

STEEL #3.5 WATER COOLED CABINET

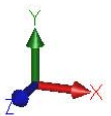

FRONT

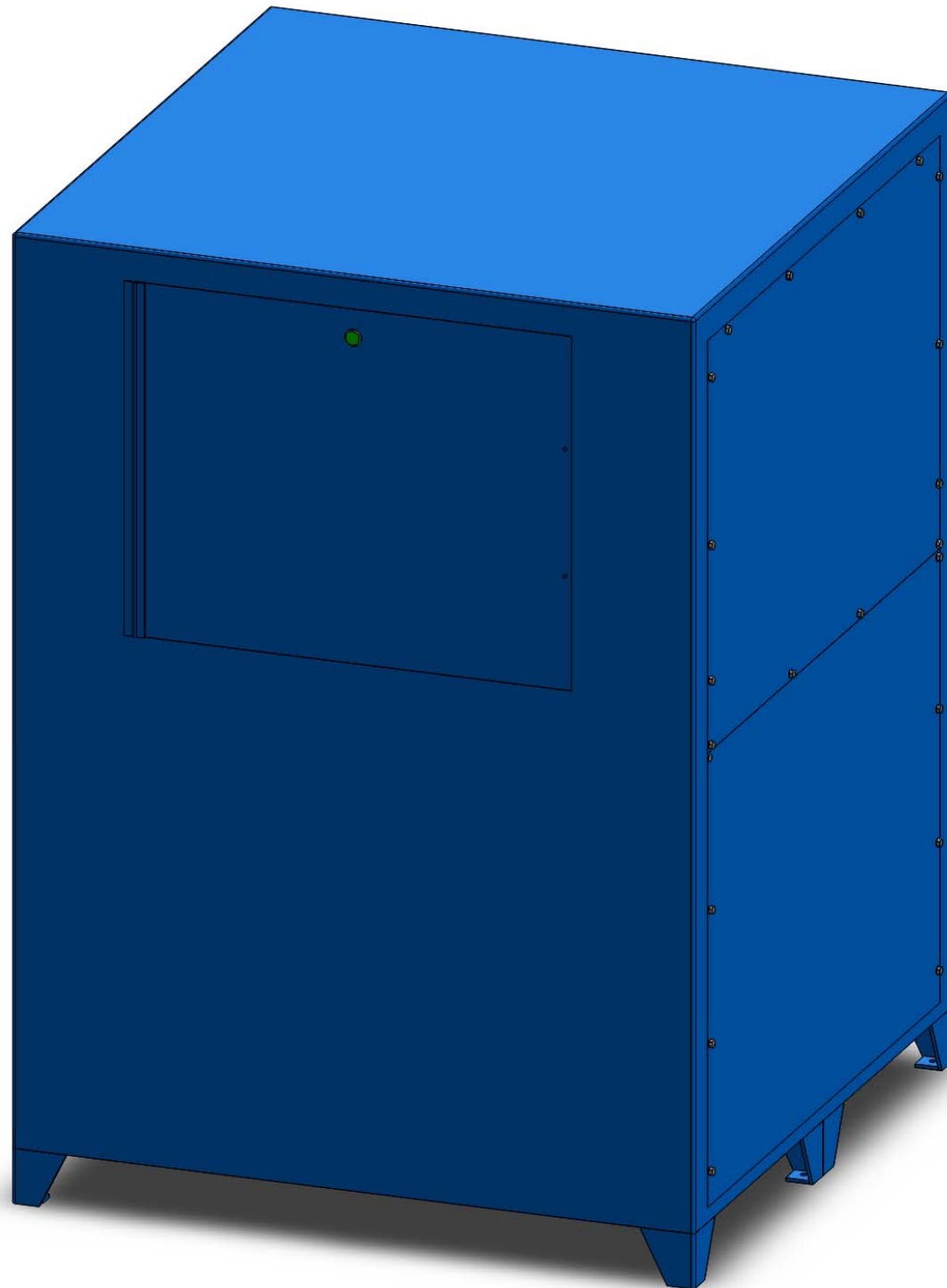
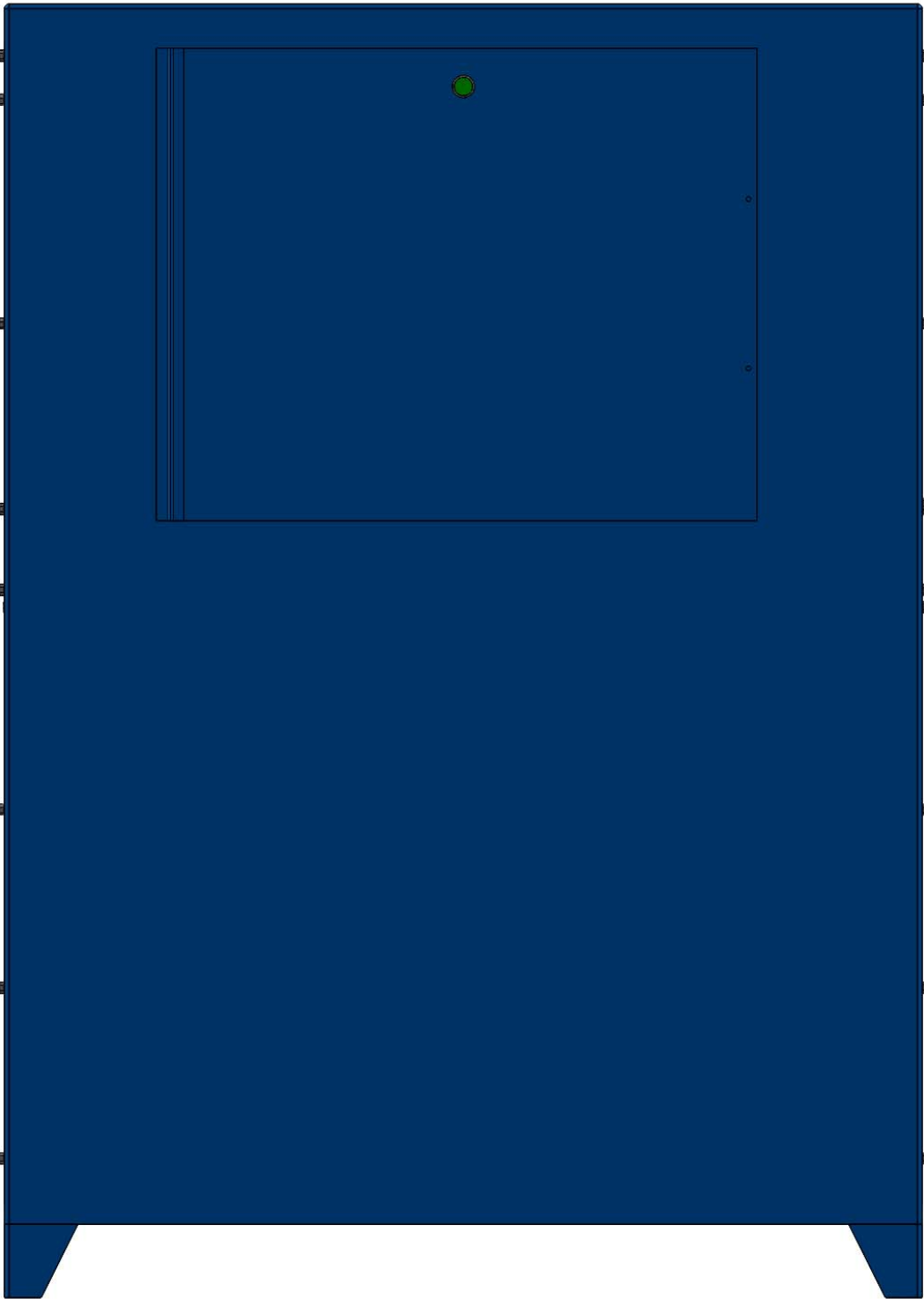

RIGHT

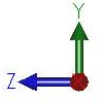
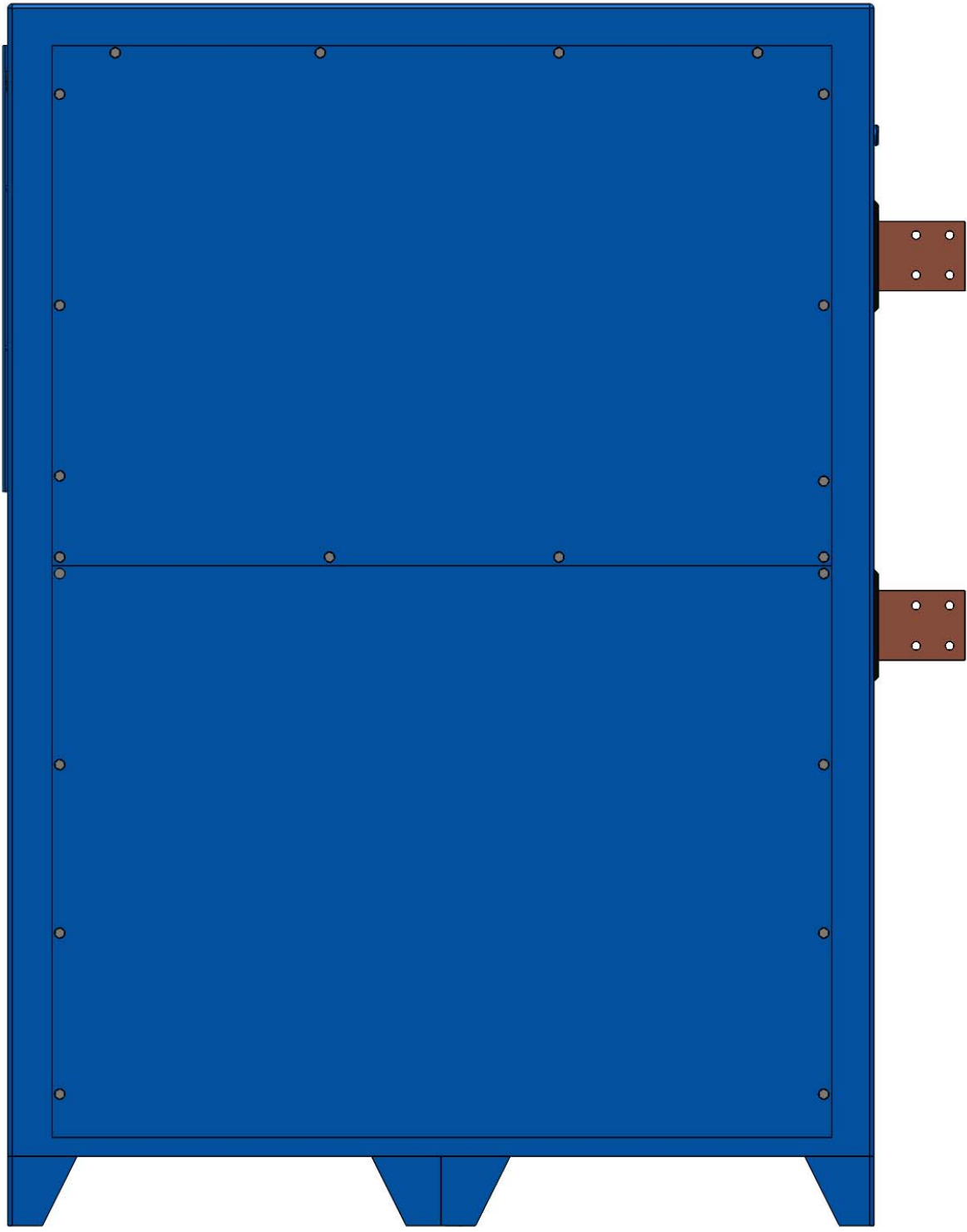

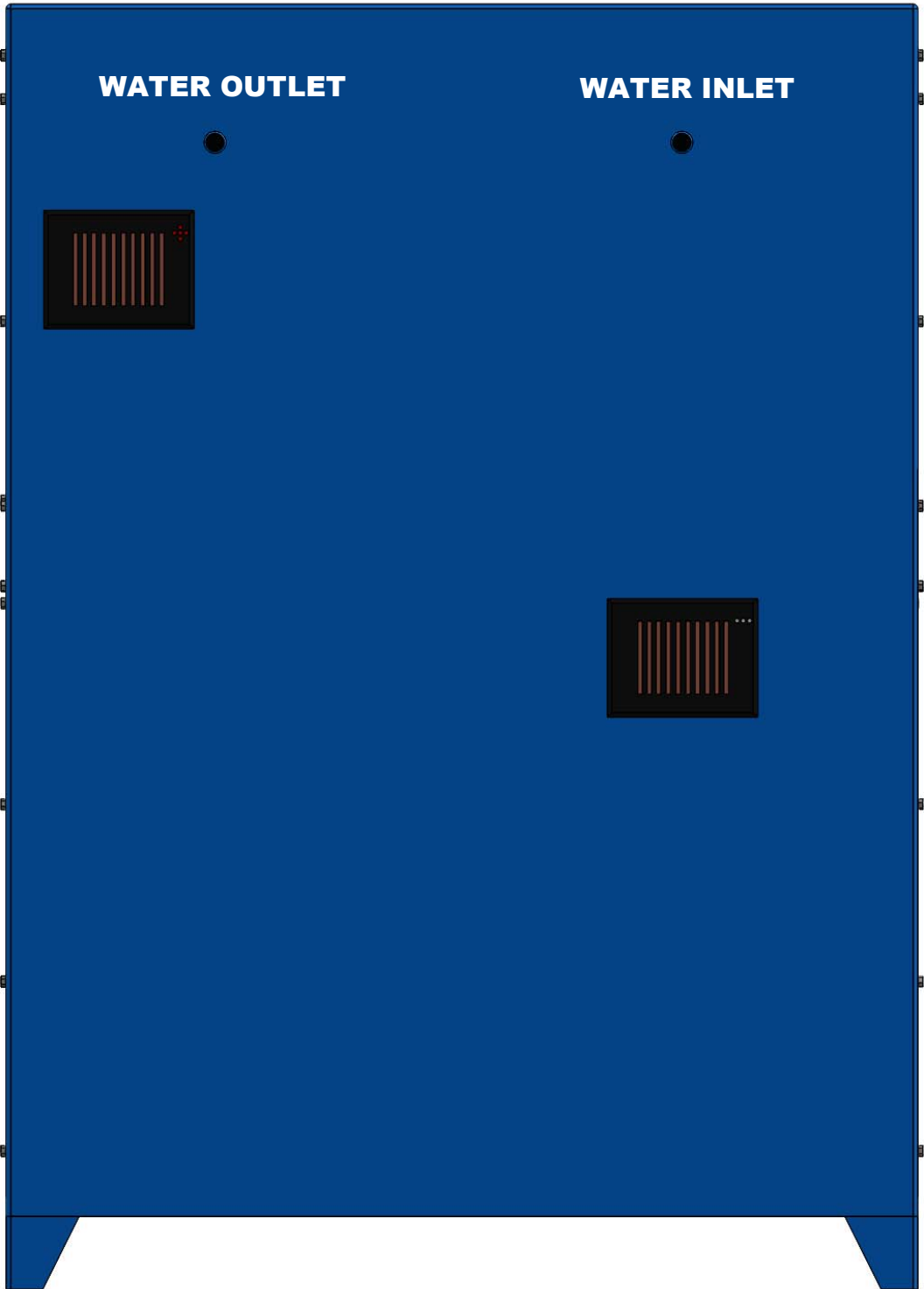

LEFT

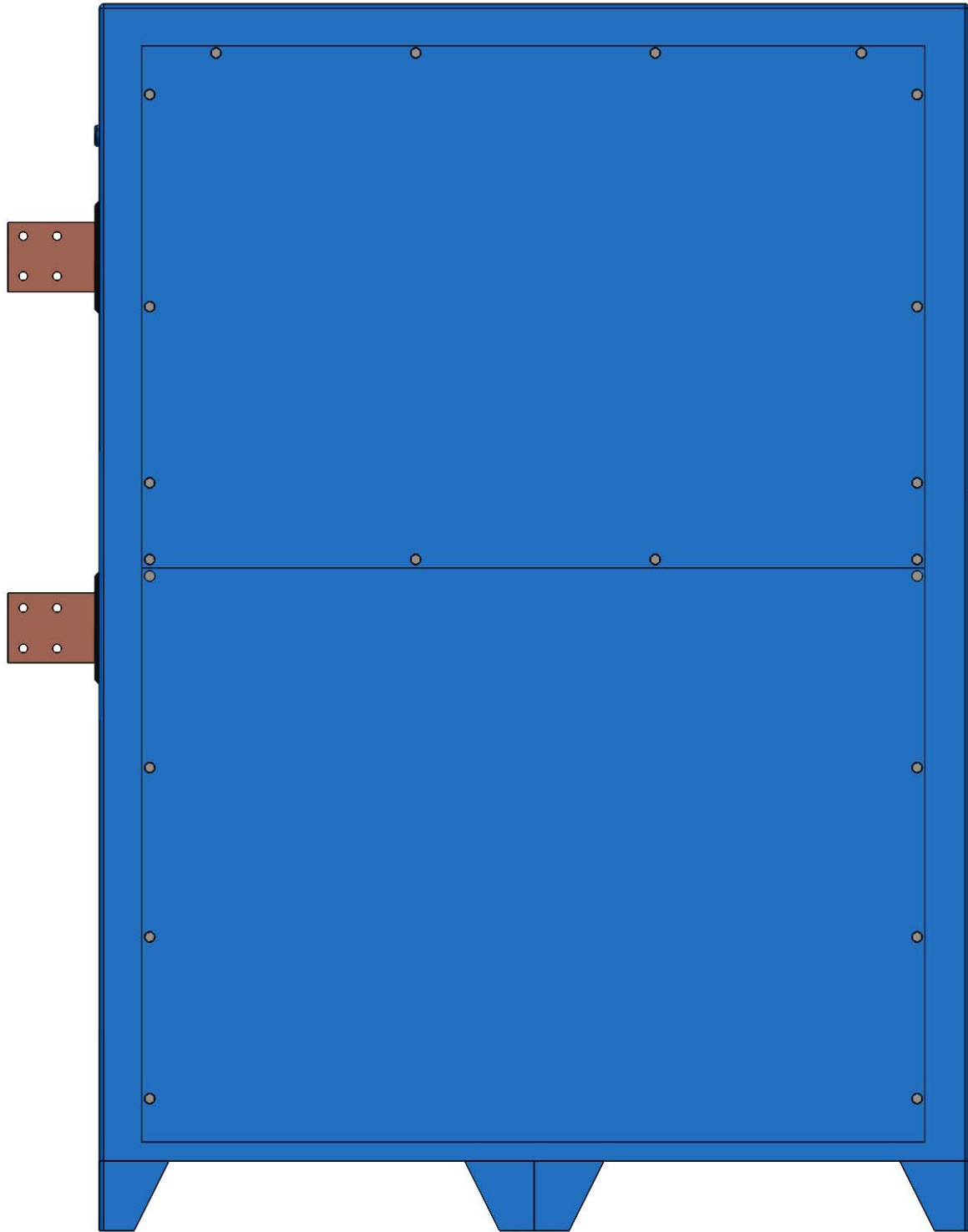

TOP

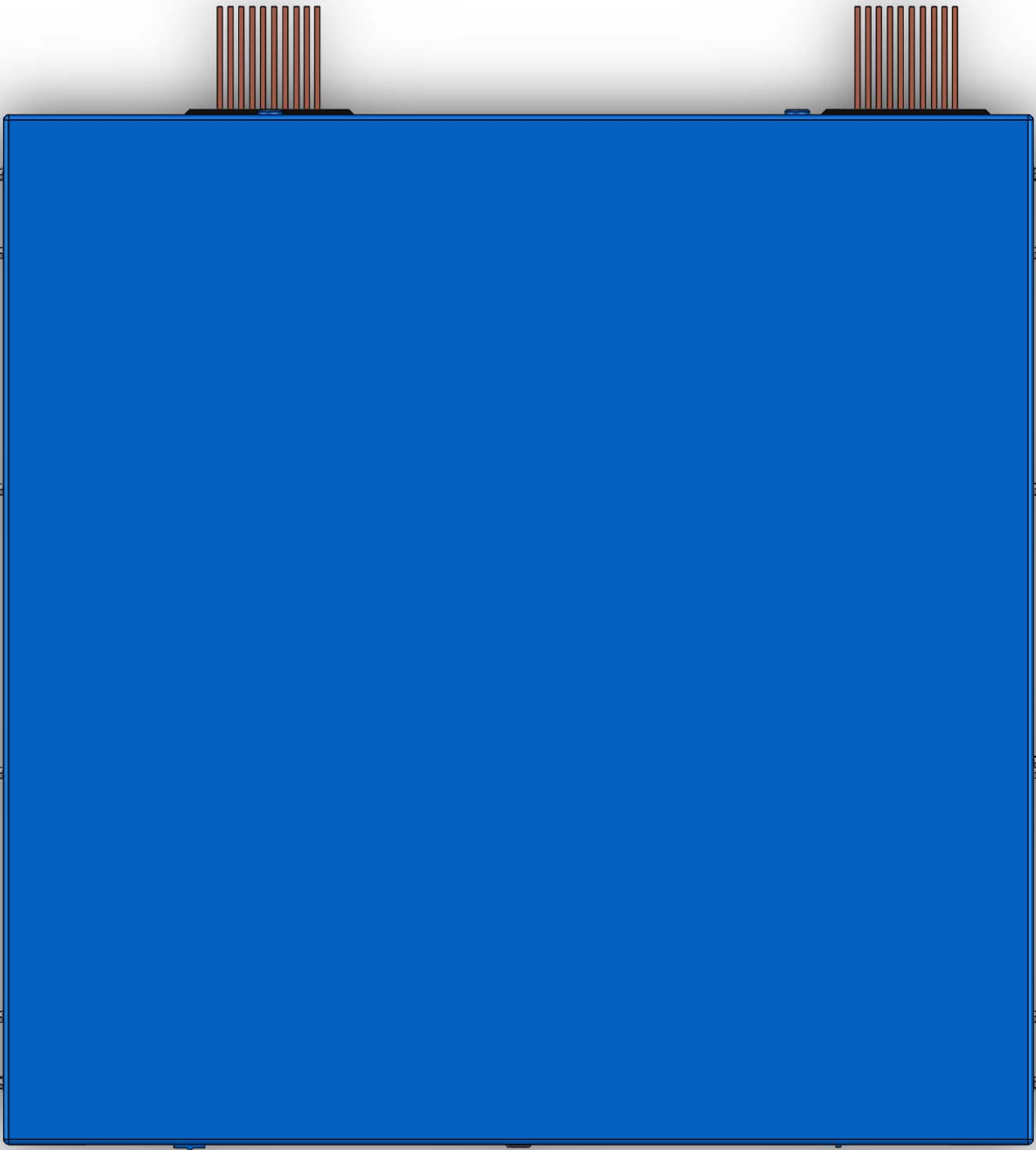

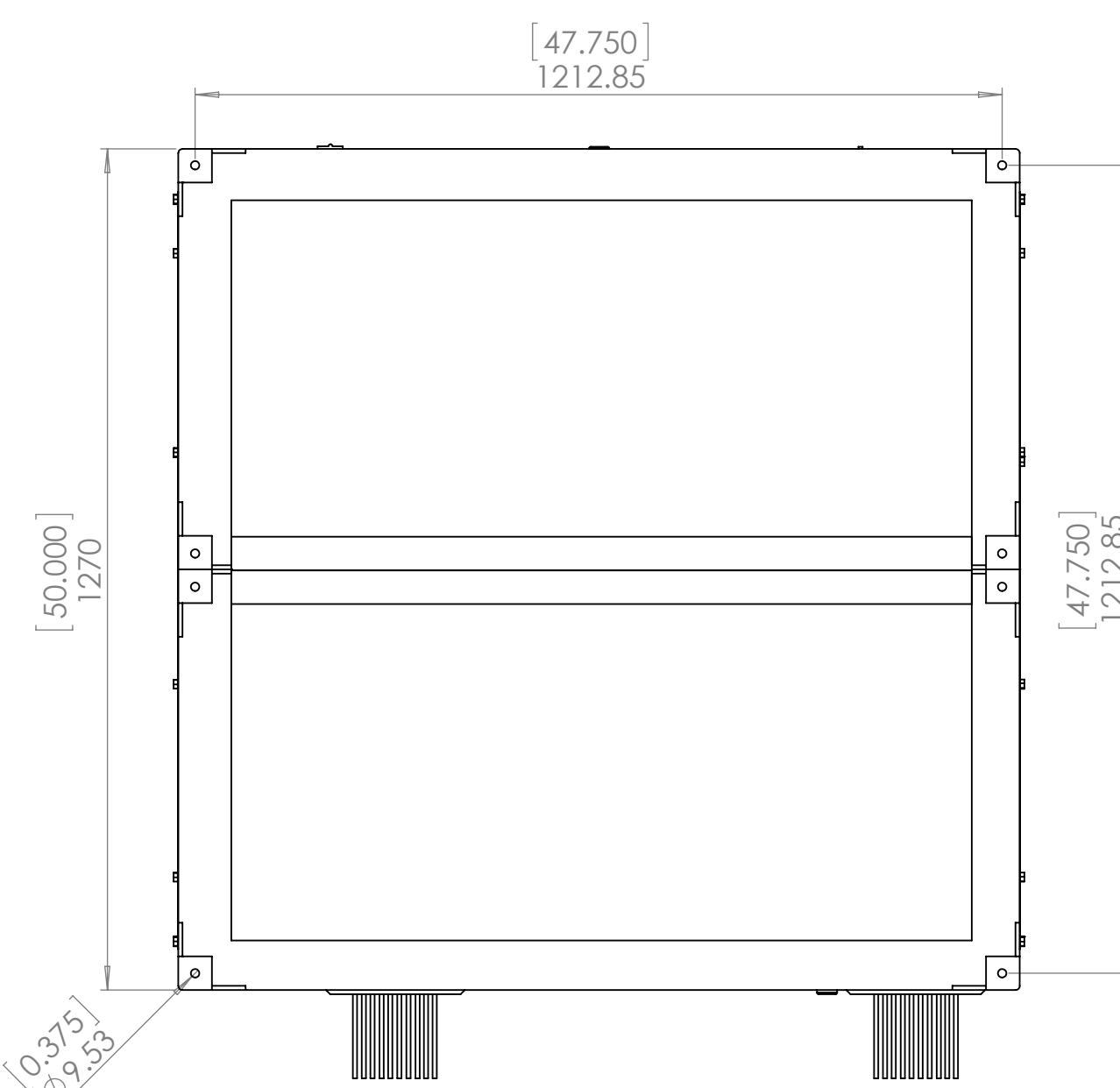
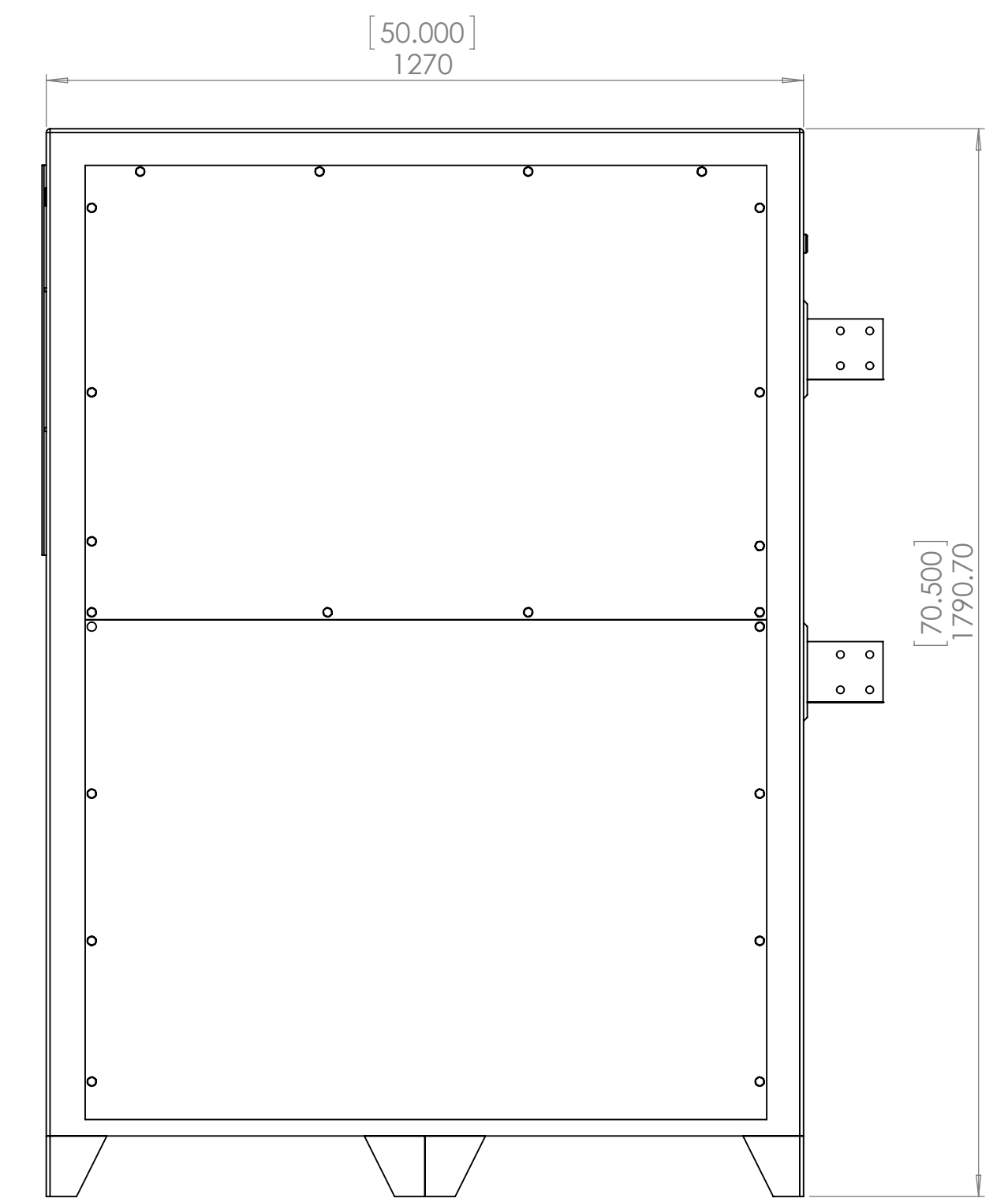
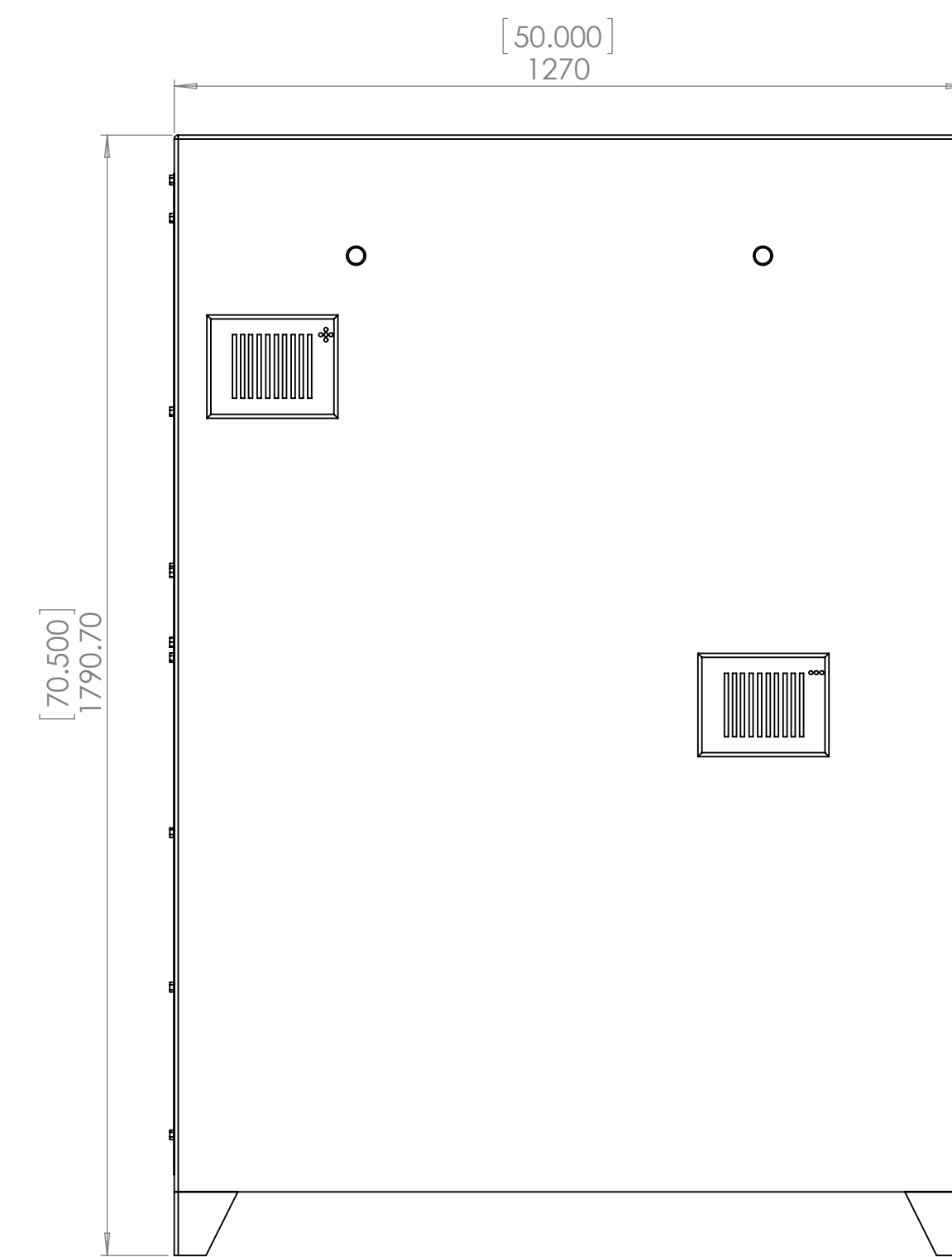
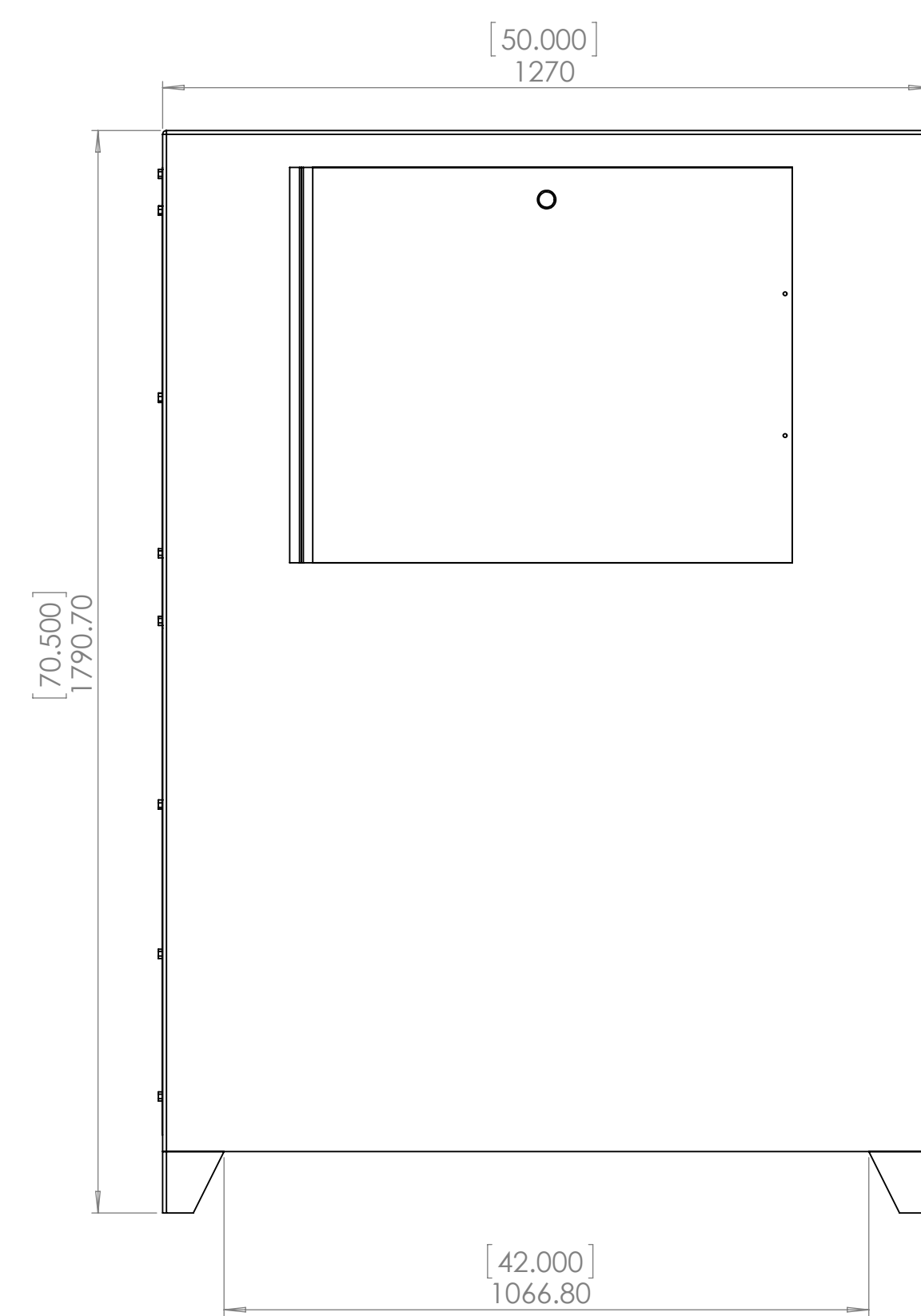
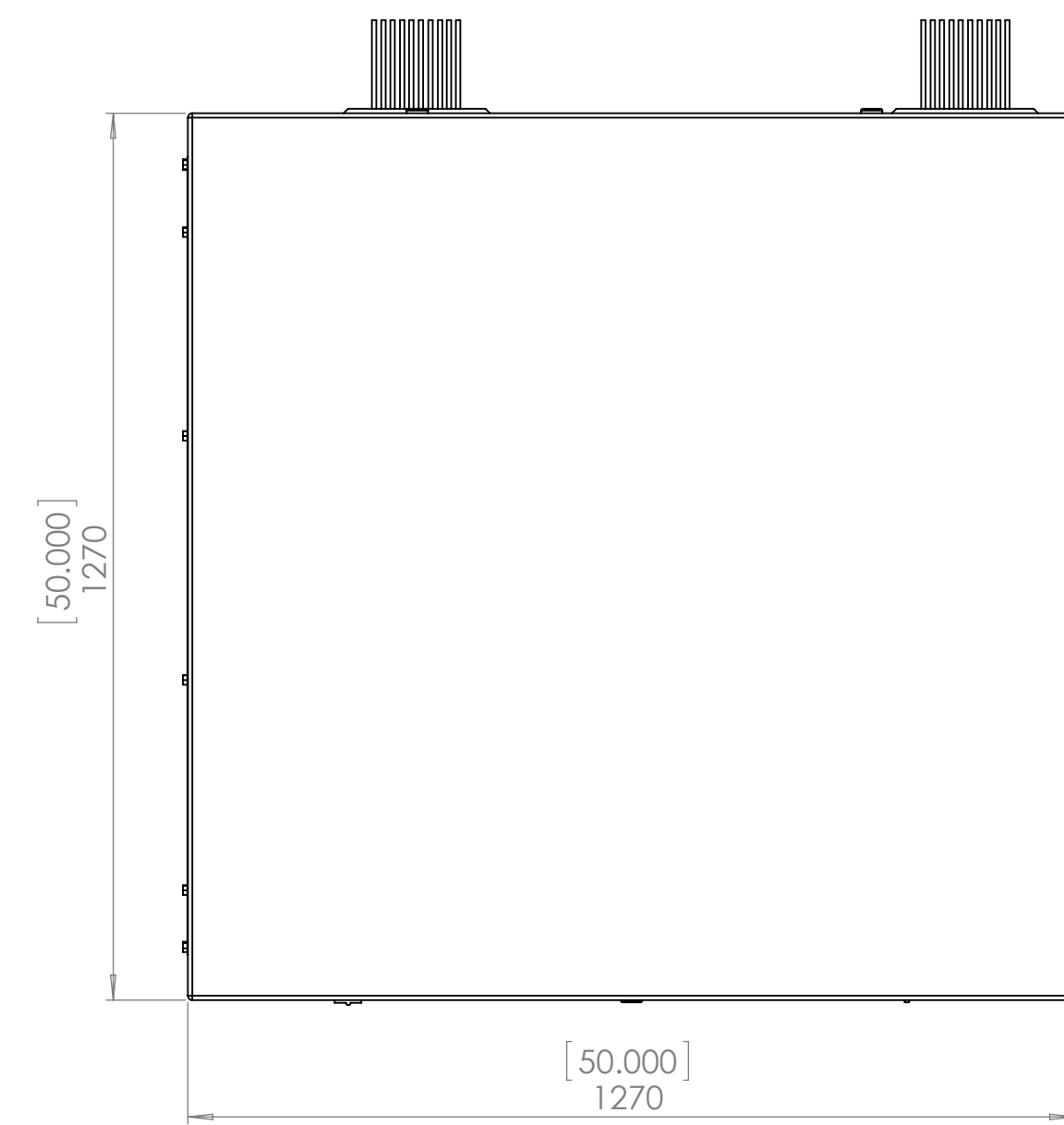
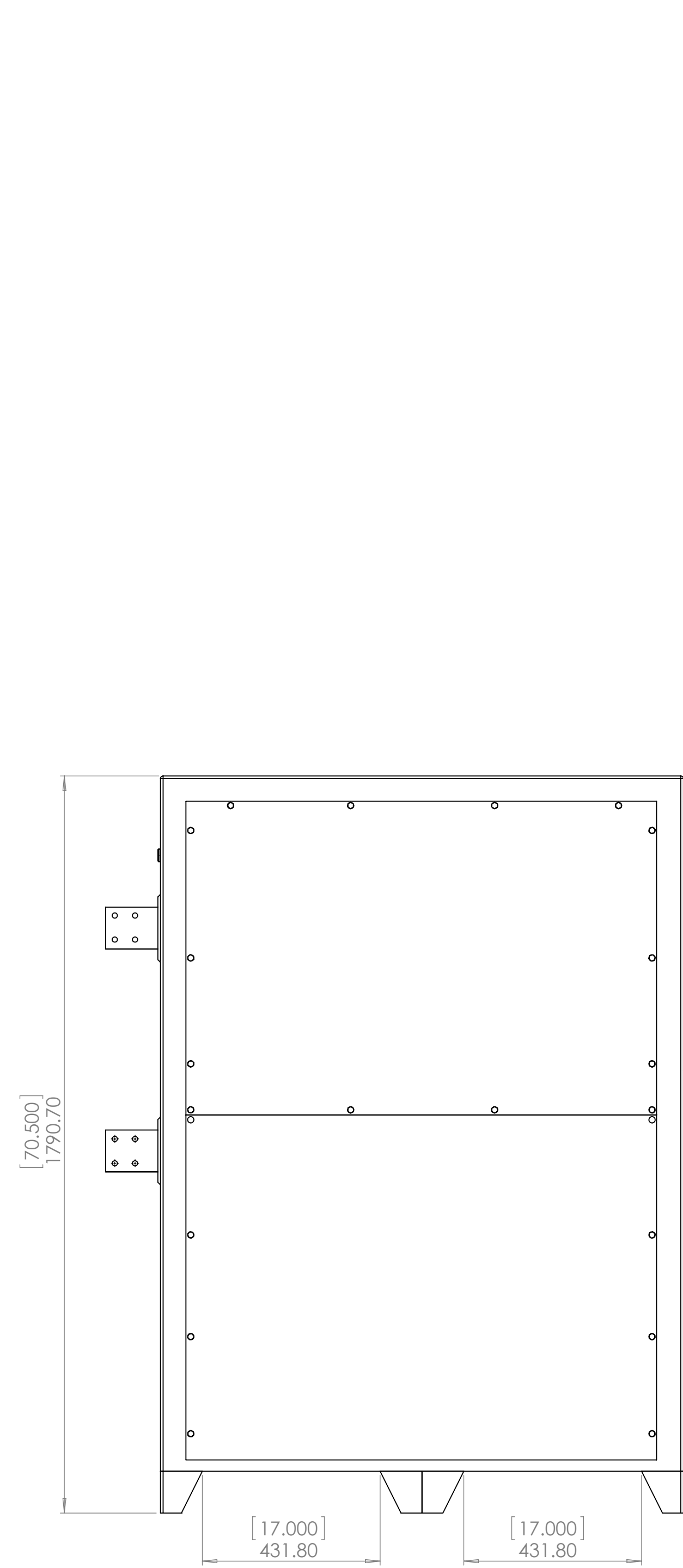

UNLESS OTHERWISE SPECIFIED: DIMENSIONS ARE IN MILLIMETERS SURFACE FINISH: TOLERANCES: LINEAR: ANGULAR:		FINISH:	DEBUR AND BREAK SHARP EDGES	DO NOT SCALE DRAWING	REVISION
DRAWN: SO			SIGNATURE:	DATE: 6-12-19	TITLE: ENCLOSURE
CHK'D: SO			SIGNATURE:	DATE: 6-12-19	
APP'VD:			SIGNATURE:	DATE:	
MFG:			SIGNATURE:	DATE:	
Q.A.:			SIGNATURE:	DATE:	
MATERIAL:					
WEIGHT:					
DWG NO: S-3.5W CABINET				A1	
SCALE: 1:10				SHEET 1 OF 1	