

CANARY  
CLOSETS & CABINETS

DOORS & MOLDING  
2017



---

697 Rahway Ave. Union NJ 07083  
Ph. 908-851-2894 F. 908-851-2895  
[www.canarycc.com](http://www.canarycc.com)

## About

Doors are constructed from exact match polyester wrapped mdf moldings and melamine center panels in Tafisa, Uniboard and American Laminates colors. In stock are 6 profiles and 43 different colors with matching accessory moldings. All corner joints are mortise and tenon joinery.

## Ordering

All orders are placed online through our ordering site: [canary.allmoxy.com](http://canary.allmoxy.com)

Doors and drawer faces are a six day lead time. Glass inserts carry a ten day lead time. In stock moldings are available for same day shipment. Rush orders are available at an additional charge.

All doors and drawer faces are custom made to your specifications, therefore are not returnable.

## Shipping

We use the most economical shipping method for your order and add actual shipping charges to your order. Doors up to 60" can be boxed as well as moldings. Oversize doors up to 96" are palletized. We use FedEx ground for boxed shipments And chose the best carrier for pallet orders.

## Warranty

Doors and moldings are warranted against manufacturing defects and delaminating for five years from delivery. Doors Over 50" are not covered by any warping warranty. The warranty is limited to door or molding replacement only, therefore Shipping, installation and related expenses are not covered.

## Hinging

Hinge drilling is available in the Blum / Salice pattern. The Hinge cup diameter is 35mm with a tab distance of 5mm. (note: If you are using face frame hinges, please let us know as the tab distance is 3mm ! )

Standard drilling is as follows:

| Door height               | hole locations           |
|---------------------------|--------------------------|
| 2 holes: 0" to 35.7"      | 79mm from top and bottom |
| 3 holes: 35.75" to 50.15" | 79mm / center / 79mm     |
| 4 holes: 50.19" to 70.75" | 79mm / 463mm             |
| 5 holes: over 70.86"      | 79mm / 463mm / center    |

## Glass inserts

Factory installed glass inserts are available in three options:

*Clear tempered*

*Frosted tempered*

*Mirror with safety backing*

All inserts are 1/4" and are adhered in the frames in Place of the 1/4" panel, fully captive in the frame.



# DOOR & DRAWER FACE STYLES

4741 Transitional

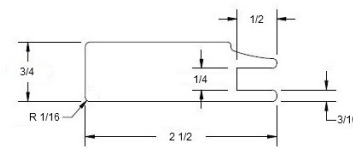

Min. size door = 6" X 6"

4459 Small Shaker

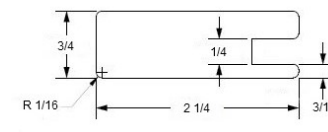

Min. size door = 6" X 6"

4546 Large Shaker \*

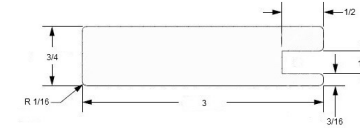

Min. size door = 7" X 7"

4753 Classic

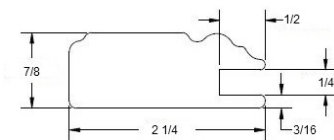

Traditional



4307 Drawer face

Min. size = 5" X 5"

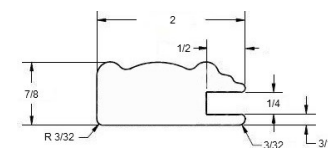

4300 Door

Min. size = 7" X 7"

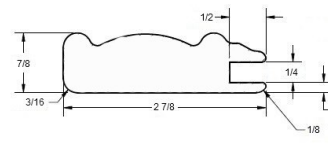

all doors, maximum size = 36" x 92"

\* shown with small shaker drawer face

# AVAILABLE COLORS



## SOLID COLORS



WHITE L-080



WHITE SMOOTHWOOD L-080



WHITE URBANIA L-080



IVORY L-204

## WOODGRAINS



SUMMER FLAME L-420



CANDLE LIGHT L-421



CHOCOLATE PEAR L-444

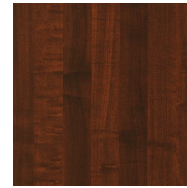

RUBY PLANK MAPLE L-478



RUSTIC CHERRY L-521

## URBANIA COLORS

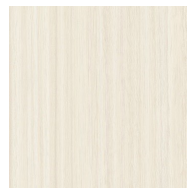

WHITE CHOCOLATE L-492



MILK CHOCOLATE L-493



DARK CHOCOLATE L-494

## ALTO COLORS

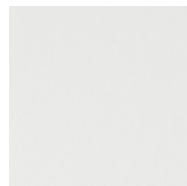

LATITUDE NORTH L-530

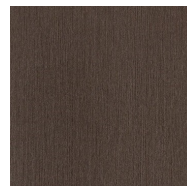

LATITUDE SOUTH L-531

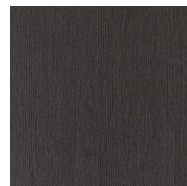

LATITUDE WEST L-532



LATITUDE EAST L-533



NORTHWESTER L-534



SOUTHWESTER L-535



BREAKWATER L-537



RIVER ROCK L-538



SUMMER BREEZE L-540

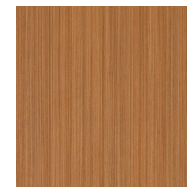

WINTER CHERRY L-541

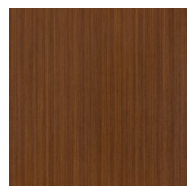

AUTUMN LEAVES L-542

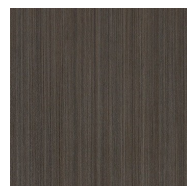

SPRING BLOSSOM L-543

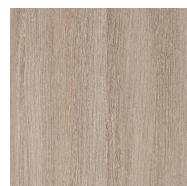

BEACHWOOD L-550

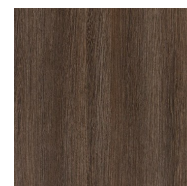

BOARDWALK L-551



# AVAILABLE COLORS



## SOLID COLORS



WHITE



WHITE SMOOTHWOOD



WHITE WOODPRINT



ANTIQUE WHITE

## RIO COLORS



FRESCO R-60



CARNAVAL R-61



SAMBA R-63

## WOODPRINT COLORS

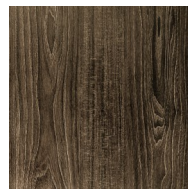

SILVA H-50

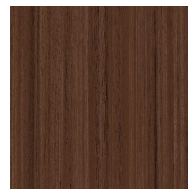

ZAHARA H-51



RIVA H-52

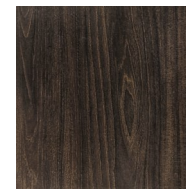

EMBER H-53



SKYE H-54



MYSTIC-H55

## AURA COLORS



CHILL H-56



STRATA H-64



CANYON H-65



VINTAGE H-66

# AVAILABLE COLORS

## SOLID COLORS



AMLAM WHITE



ANTIQUE WHITE

## WOODGRAINS



SUMMER FLAME

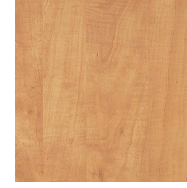

CANDLE LIGHT



CHOCOLATE PEAR

## REAL WOOD TEXTURE SOLID COLORS



WHITE RW TEXTURE



ANTIQUE WHITE RW TEXTURE



PUMICE RW TEXTURE



FOLKSTONE RW TEXTURE

## REAL WOOD TEXTURE (ALTO)

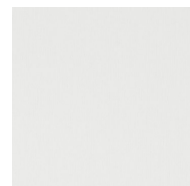

LATITUDE NORTH



LATITUDE SOUTH

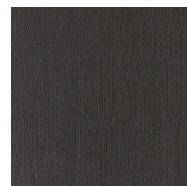

LATITUDE WEST



LATITUDE EAST



NORTHWESTER



SOUTHWESTER



BREAKWATER



RIVER ROCK



SUMMER BREEZE



WINTER CHERRY

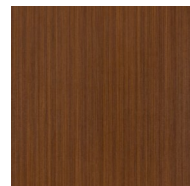

AUTUMN LEAVES

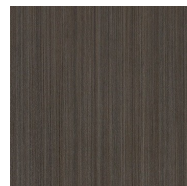

SPRING BLOSSOM



BEACHWOOD

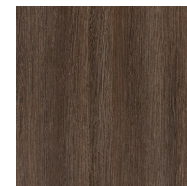

BOARDWALK

# ACCESSORY MOLDINGS

## STOCK MOLDINGS

All 8' lengths, see availability chart as all profiles are stocked in all colors. Any color and profile can be special ordered, minimums apply.

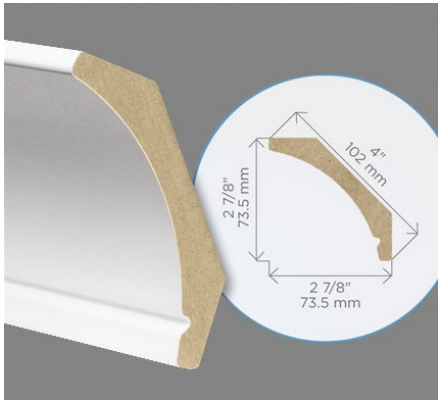

4766 Contemporary Cornice

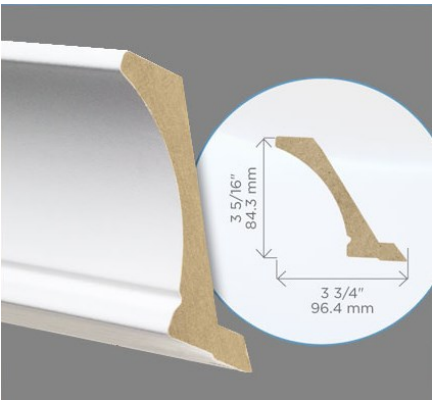

WP-22 Contemporary Crown

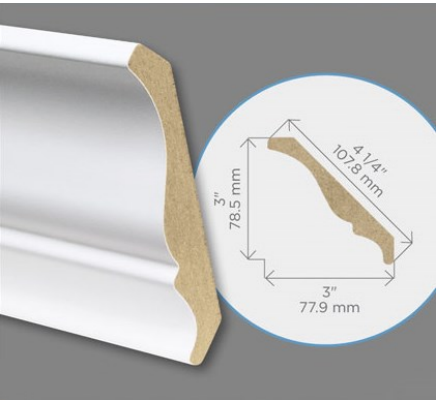

4634 Large Cornice

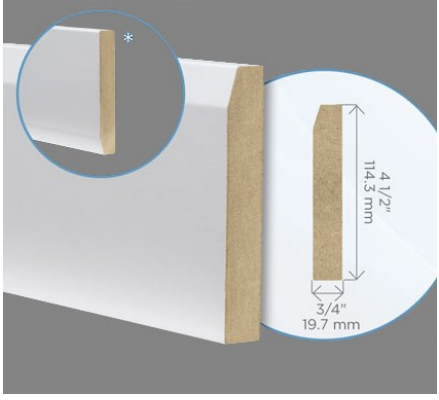

4794 Baseboard

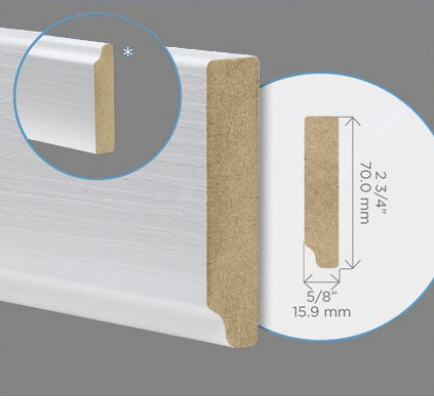

4022 Light Shield

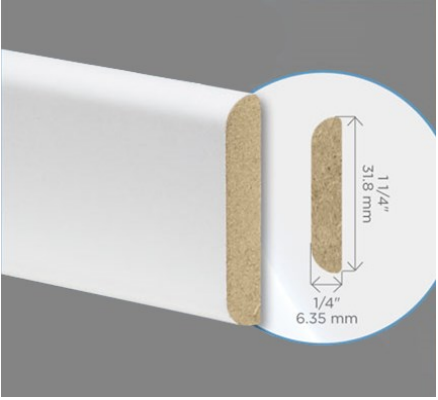

4632 Batten

## SPECIAL ORDER MOLDINGS

Available in any color, minimums apply

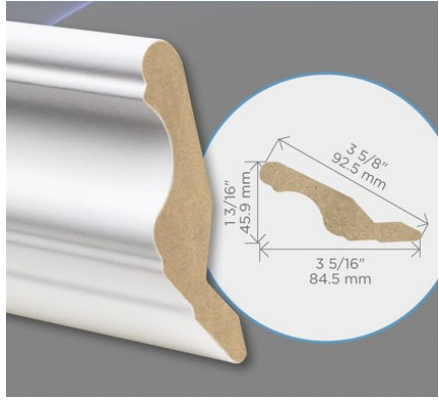

4021 Colonial Crown

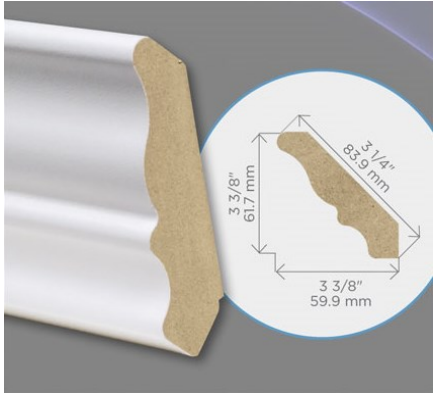

5027 Medium Cornice

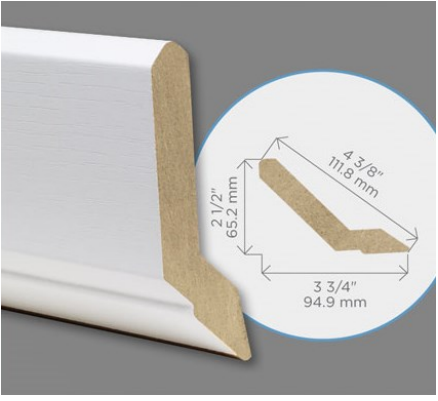

4716 Shaker Crown

# AVAILABILITY CHART

|                     | TAFISA | UNIBOARD | AME LAMINATES | 4307<br>TRADITIONAL DRAWER | 4300<br>TRADITIONAL DOOR | 4459<br>SMALL SHAKER | 4546<br>LARGE SHAKER | 4741<br>TRANSITIONAL | 4753<br>CLASSIC | WP22<br>CONTEMPORARY CROWN | 4794<br>BASEBOARD | 4766<br>CONTEMPORARY CORNICE | 4634<br>LARGE CORNICE | 4632<br>BATTEN | 4022<br>LIGHT LARGE SHIELD |   |
|---------------------|--------|----------|---------------|----------------------------|--------------------------|----------------------|----------------------|----------------------|-----------------|----------------------------|-------------------|------------------------------|-----------------------|----------------|----------------------------|---|
| <b>SOLID COLORS</b> |        |          |               |                            |                          |                      |                      |                      |                 |                            |                   |                              |                       |                |                            |   |
| White TX            | ●      | ●        | ●             | ●                          | ●                        | ●                    | ●                    | ●                    |                 | ●                          | ●                 | ●                            | ●                     | ●              |                            |   |
| White woodprint     |        | ●        |               |                            |                          | ●                    |                      | ●                    |                 |                            | ●                 | ●                            | ●                     | ●              |                            |   |
| White urbania       | ●      |          |               |                            |                          | ●                    |                      | ●                    |                 |                            | ●                 | ●                            | ●                     | ●              |                            |   |
| White smooth        | ●      | ●        |               |                            |                          | ●                    |                      | ●                    | ●               |                            | ●                 | ●                            |                       | ●              | ●                          |   |
| Antique white       | ●      | ●        | ●             | ●                          | ●                        | ●                    | ●                    | ●                    |                 | ●                          | ●                 |                              | ●                     | ●              |                            |   |
| White RW            | ●      |          | ●             |                            |                          |                      |                      | ●                    |                 |                            | ●                 | ●                            |                       | ●              |                            |   |
| Antique White RW    |        |          | ●             |                            |                          |                      |                      | ●                    |                 |                            | ●                 | ●                            |                       | ●              |                            |   |
| Pumice RW           |        |          | ●             |                            |                          |                      |                      | ●                    |                 |                            | ●                 | ●                            |                       | ●              |                            |   |
| Folkstone RW        |        |          | ●             |                            |                          |                      |                      | ●                    |                 |                            | ●                 | ●                            |                       | ●              |                            |   |
| <b>WOODGRAINS</b>   |        |          |               |                            |                          |                      |                      |                      |                 |                            |                   |                              |                       |                |                            |   |
| Candlelight         | ●      | ●        | ●             | ●                          | ●                        | ●                    | ●                    | ●                    |                 | ●                          | ●                 |                              | ●                     | ●              |                            |   |
| Rustic cherry       | ●      |          | ●             | ●                          | ●                        | ●                    | ●                    | ●                    |                 | ●                          | ●                 |                              | ●                     | ●              |                            |   |
| Summer flame        | ●      | ●        | ●             | ●                          | ●                        | ●                    | ●                    | ●                    |                 | ●                          | ●                 |                              | ●                     | ●              |                            |   |
| Ruby plank maple    | ●      |          | ●             | ●                          | ●                        | ●                    | ●                    | ●                    |                 | ●                          | ●                 |                              | ●                     | ●              |                            |   |
| Chocolate pear      | ●      | ●        | ●             | ●                          | ●                        | ●                    | ●                    | ●                    |                 | ●                          | ●                 |                              | ●                     | ●              |                            |   |
| <b>URBANIA</b>      |        |          |               |                            |                          |                      |                      |                      |                 |                            |                   |                              |                       |                |                            |   |
| White chocolate     | ●      |          |               |                            |                          | ●                    | ●                    | ●                    |                 | ●                          | ●                 | ●                            |                       | ●              |                            |   |
| Milk chocolate      | ●      |          |               |                            |                          | ●                    | ●                    | ●                    |                 | ●                          | ●                 | ●                            |                       | ●              |                            |   |
| Dark chocolate      | ●      |          |               |                            |                          | ●                    | ●                    | ●                    |                 | ●                          | ●                 | ●                            |                       | ●              |                            |   |
| <b>WOODPRINT</b>    |        |          |               |                            |                          |                      |                      |                      |                 |                            |                   |                              |                       |                |                            |   |
| Silva               |        | ●        |               | ●                          | ●                        | ●                    | ●                    | ●                    |                 | ●                          |                   | ●                            |                       | ●              | ●                          | ● |
| Zahara              |        | ●        |               | ●                          | ●                        | ●                    | ●                    | ●                    |                 | ●                          |                   | ●                            |                       | ●              | ●                          | ● |
| Riva                |        | ●        |               | ●                          | ●                        | ●                    | ●                    | ●                    |                 | ●                          |                   | ●                            |                       | ●              | ●                          | ● |
| Ember               |        | ●        |               | ●                          | ●                        | ●                    | ●                    | ●                    |                 | ●                          |                   | ●                            |                       | ●              | ●                          | ● |
| Skye                |        | ●        |               | ●                          | ●                        | ●                    | ●                    | ●                    |                 | ●                          |                   | ●                            |                       | ●              | ●                          | ● |
| Mystic              |        | ●        |               | ●                          | ●                        | ●                    | ●                    | ●                    |                 | ●                          |                   | ●                            |                       | ●              | ●                          | ● |



# AVAILABILITY CHART

|  | TAFISA | UNIBOARD | AME. LAMINATES | 4307<br>TRADITIONAL<br>DRAWER | 4300<br>TRADITIONAL<br>DOOR | 4459<br>SMALL SHAKER | 4546<br>LARGE SHAKER | 4741<br>TRANSITIONAL | 4753<br>CLASSIC | WP22<br>CONTEMPORARY<br>CROWN | 4794<br>BASEBOARD | 4766<br>CONTEMPORARY<br>CORNICÉ | 4634<br>LARGE<br>CORNICÉ | 4632<br>BATTEN | 4022<br>LIGHT<br>LARGE<br>SHIELD |
|--|--------|----------|----------------|-------------------------------|-----------------------------|----------------------|----------------------|----------------------|-----------------|-------------------------------|-------------------|---------------------------------|--------------------------|----------------|----------------------------------|
|--|--------|----------|----------------|-------------------------------|-----------------------------|----------------------|----------------------|----------------------|-----------------|-------------------------------|-------------------|---------------------------------|--------------------------|----------------|----------------------------------|

## ALTO

|                |   |   |  |  |   |   |   |   |  |   |   |   |  |  |   |
|----------------|---|---|--|--|---|---|---|---|--|---|---|---|--|--|---|
| Latitude north | ● | ● |  |  |   | ● |   | ● |  |   | ● | ● |  |  | ● |
| Latitude south | ● | ● |  |  |   |   |   | ● |  |   | ● | ● |  |  | ● |
| Latitude west  | ● | ● |  |  |   |   |   | ● |  |   | ● | ● |  |  | ● |
| Latitude east  | ● | ● |  |  |   |   |   | ● |  |   | ● | ● |  |  | ● |
| Northwester    | ● | ● |  |  |   |   |   | ● |  |   | ● | ● |  |  | ● |
| Southwester    | ● | ● |  |  |   |   |   | ● |  |   | ● | ● |  |  | ● |
| Breakwater     | ● | ● |  |  |   |   |   | ● |  |   | ● | ● |  |  | ● |
| River rock     | ● | ● |  |  |   |   |   | ● |  |   | ● | ● |  |  | ● |
| Summer breeze  | ● | ● |  |  | ● |   | ● | ● |  | ● | ● | ● |  |  | ● |
| Winter cherry  | ● | ● |  |  |   |   |   | ● |  |   | ● | ● |  |  | ● |
| Autumn leaves  | ● | ● |  |  | ● |   | ● | ● |  | ● | ● | ● |  |  | ● |
| Beachwood      | ● | ● |  |  |   |   |   | ● |  |   | ● | ● |  |  | ● |
| Boardwalk      | ● | ● |  |  |   |   |   | ● |  |   | ● | ● |  |  | ● |
| Spring blossom | ● | ● |  |  | ● |   | ● | ● |  | ● | ● | ● |  |  | ● |

## RIO

|          |  |   |  |  |  |  |  |  |   |   |  |   |  |  |   |   |
|----------|--|---|--|--|--|--|--|--|---|---|--|---|--|--|---|---|
| Fresco   |  | ● |  |  |  |  |  |  | ● | ● |  | ● |  |  | ● | ● |
| Carnaval |  | ● |  |  |  |  |  |  | ● | ● |  | ● |  |  | ● | ● |
| Samba    |  | ● |  |  |  |  |  |  | ● | ● |  | ● |  |  | ● | ● |

## AURA

|         |  |   |  |  |   |  |  |   |  |  |  |   |  |  |  |  |
|---------|--|---|--|--|---|--|--|---|--|--|--|---|--|--|--|--|
| Chill   |  | ● |  |  | ● |  |  | ● |  |  |  | ● |  |  |  |  |
| Strata  |  | ● |  |  | ● |  |  | ● |  |  |  | ● |  |  |  |  |
| Canyon  |  | ● |  |  | ● |  |  | ● |  |  |  | ● |  |  |  |  |
| Vintage |  | ● |  |  | ● |  |  | ● |  |  |  | ● |  |  |  |  |

**CANARY**  
CLOSETS & CABINETS

697 Rahway Ave. Union NJ 07083  
Ph. 908-851-2894 F. 908-851-2895  
[www.canarycc.com](http://www.canarycc.com)