

APPAREL

NEW

A1850

AVAILABLE IN CUSTOM
A700 SERIES

PRO HOCKEY HOODIE
 · POLYFLEECE - 100% POLYESTER
 · HOCKEY SKATE LACE
 · YOUTH SIZES - LACE TACKED DOWN

ADULT	XS	S	M	L	XL	2XL	3XL
YOUTH	S	M	L	XL			

202
DETROIT RED304
CHICAGO RED305
CHICAGO WHITE308
MONTREAL RED369
EDMONTON ORANGE376
DALLAS KELLY402
TORONTO 3RD ROYAL498
BOSTON BLACK524
PHILADELPHIA ORANGE563
MINNESOTA DARK GREEN566
NEW JERSEY RED595
WINNIPEG NAVY614
CHICAGO BLACK722
VANCOUVER ROYAL812
NYR ROYAL816
PITTSBURGH BLACK820
EDMONTON ROYAL828
PITTSBURGH SKY941
LOS ANGELES BLACK

NEW

A1845

AVAILABLE IN CUSTOM
A600 SERIES

HOCKEY STRIPE HOODIE

- POLYFLEECE - 100% POLYESTER
- RIB KNIT CUFFS AND WAIST
- FRONT POUCH POCKET
- HOCKEY SKATE LACE
- YOUTH SIZES - LACE TACKED DOWN

ADULT	XS	S	M	L	XL	2XL	3XL
YOUTH	S	M	L	XL			



206
ROYAL/WHITE



208
RED/WHITE



216
NAVY/WHITE



221
BLACK/WHITE



304
CHICAGO RED



305
CHICAGO WHITE



308
MONTREAL RED



330
PHILADELPHIA ORANGE



376
DALLAS KELLY



498
BOSTON BLACK



563
MINNESOTA DARK GREEN



595
WINNIPEG NAVY



614
CHICAGO BLACK



812
NYR ROYAL



820
EDMONTON ROYAL



828
PITTSBURGH SKY



941
LOS ANGELES BLACK



NEW

A1840

AVAILABLE IN CUSTOM
A400 SERIES

TWO COLOUR HOODIE

- POLYFLEECE - 100% POLYESTER
- RIB KNIT CUFFS AND WAIST
- FRONT POUCH POCKET
- YOUTH SIZES - NO DRAWSTRING

ADULT	XS	S	M	L	XL	2XL
						3XL
YOUTH	S	M	L	XL		



925
HEATHER GREY/HEATHER CHARCOAL



930
HEATHER CHARCOAL/BLACK



931
HEATHER CHARCOAL/NAVY



932
HEATHER CHARCOAL/ROYAL



933
HEATHER CHARCOAL/RED



934
HEATHER CHARCOAL/DARK GREEN

NEW

A1834

AVAILABLE IN CUSTOM
A500 SERIES

HOCKEY LACE HOODIE

- POLYFLEECE - 100% POLYESTER
- RIB KNIT CUFFS AND WAIST
- FRONT POUCH POCKET
- HOCKEY SKATE LACE
- YOUTH SIZES - LACE TACKED DOWN

ADULT	XS	S	M	L	XL	2XL
						3XL
YOUTH	S	M	L	XL		



000
WHITE



001
BLACK



002
ROYAL



004
NAVY



005
RED



020
HEATHER GREY



021
HEATHER CHARCOAL

NEW

A1835

AVAILABLE IN CUSTOM
A400 SERIES

CLASSIC ONE COLOUR HOODIE

- POLYFLEECE - 100% POLYESTER
- RIB KNIT CUFFS AND WAIST
- FRONT POUCH POCKET
- YOUTH SIZES - NO DRAWSTRING

MENS	XS	S	M	L	XL	2XL
						3XL
LADIES	XS	S	M	L	XL	2XL
YOUTH		S	M	L	XL	



000
WHITE



001
BLACK



002
ROYAL



004
NAVY



005
RED



006
GOLD



007
KELLY



009
MAROON



010
PURPLE



014
PINK



018
SKY



029
DARK GREEN



064
ORANGE



020
HEATHER GREY



021
HEATHER CHARCOAL

NEW

A1815



AVAILABLE IN CUSTOM
A300 SERIES

· ACTIFLEX - 100% POLYESTER - MOISTURE WICKING

ADULT	XS	S	M	L	XL	2XL
						3XL

YOUTH	S	M	L	XL	
-------	---	---	---	----	--



NEW

A1820



AVAILABLE IN CUSTOM
A300 SERIES

· ACTIFLEX - 100% POLYESTER - MOISTURE WICKING

ADULT	XS	S	M	L	XL	2XL
						3XL

YOUTH	S	M	L	XL	
-------	---	---	---	----	--



NEW

A1825



AVAILABLE IN CUSTOM
A300 SERIES

· ACTIFLEX - 100% POLYESTER - MOISTURE WICKING

ADULT	XS	S	M	L	XL	2XL
						3XL
YOUTH		S	M	L	XL	



NEW

A1827



AVAILABLE IN CUSTOM
A300 SERIES

· ACTIFLEX - 100% POLYESTER - MOISTURE WICKING

ADULT	XS	S	M	L	XL	2XL
						3XL
YOUTH		S	M	L	XL	



NEW

A1810



AVAILABLE IN CUSTOM
A200 SERIES

CLASSIC ONE COLOUR POLO

· ACTIFLEX - 100% POLYESTER - MOISTURE WICKING

MENS	XS	S	M	L	XL	2XL
						3XL
LADIES	XS	S	M	L	XL	2XL
YOUTH		S	M	L	XL	



NEW

A1800



AVAILABLE IN CUSTOM
A100 SERIES

CLASSIC ONE COLOUR T-SHIRT

· ACTIFLEX - 100% POLYESTER - MOISTURE WICKING

MENS	XS	S	M	L	XL	2XL
						3XL
LADIES	XS	S	M	L	XL	2XL
YOUTH		S	M	L	XL	



A1375



AVAILABLE IN CUSTOM A100 SERIES

• DRYFLEX - 100% POLYESTER - MOISTURE WICKING
• PRODUCT CONFORMS TO BASEBALL SIZING

MENS	S	M	L	XL	2XL	3XL
LADIES	XS	S	M	L	XL	2XL
YOUTH	S	M	L	XL		



NEW

A1846



AVAILABLE IN CUSTOM A100 SERIES

3/4 SLEEVE BASEBALL TEE

• ACTIFLEX - 100% POLYESTER - MOISTURE WICKING

ADULT	XS	S	M	L	XL	2XL	3XL
YOUTH	S	M	L	XL			



AS1700

- DRYFLEX - 100% POLYESTER - MOISTURE WICKING
- ELASTIC WAIST WITH DRAWSTRING
- SIDE POCKETS
- 9" INSEAM - MENS
- 5" INSEAM - LADIES
- 7" INSEAM - YOUTH

MENS	S	M	L	XL	2XL
LADIES	XS	S	M	L	XL
YOUTH	S	M	L	XL	



AVAILABLE IN CUSTOM AS100 SERIES **POCKETS ADDITIONAL**

AS1300

- DRYFLEX - 100% POLYESTER - MOISTURE WICKING
- ELASTIC WAIST WITH DRAWSTRING
- 9" INSEAM - MENS
- 5" INSEAM - LADIES
- 7" INSEAM - YOUTH

MENS	S	M	L	XL	2XL
LADIES	XS	S	M	L	XL
YOUTH	S	M	L	XL	



AVAILABLE IN CUSTOM AS100 SERIES

NEW

A1830

HOCKEY TOQUE

- 100% ACRYLIC

ADULT	ONE SIZE FITS ALL
YOUTH	ONE SIZE FITS ALL



AVAILABLE IN CUSTOM AT200 SERIES

CUSTOM SUBLIMATION APPAREL PATTERNS

ZAL1000 SERIES

SWEATSHIRT

• SELF FABRIC CREW NECK

ZAL1210

ZAL1211



• HEMMED SLEEVES & WAIST



• RIB KNIT CUFFS & WAIST

SIZES

ADULT: XS - 2XL
+ OVERSIZE

YOUTH: S - XL

LADIES: XS - 2XL
+ OVERSIZE

OPTION AVAILABLE

ZAL2010P

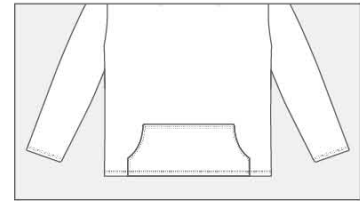

FRONT POCKET
FOR OPTIONAL POCKET ADD "P" TO END OF PATTERN CODE

ZAL2000 SERIES

HOODIE

• HOOD WITH DRAWSTRING (NO DRAWSTRING ON YOUTH SIZES)

ZAL2010P*

ZAL2011



• HEMMED SLEEVES & WAIST
* SHOWN WITH OPTIONAL FRONT POCKET



• RIB KNIT CUFFS & WAIST

SIZES

ADULT: XS - 2XL
+ OVERSIZE

YOUTH: S - XL

LADIES: XS - 2XL
+ OVERSIZE

1/4 ZIP SWEATSHIRT

• SELF FABRIC COLLAR

• 1/4 ZIPPER

ZAL2610

ZAL2611



• HEMMED SLEEVES & WAIST



• RIB KNIT CUFFS & WAIST

ZAL3000 SERIES

LACE NECK HOODIE

• LACE NECK HOOD WITH UNDERLAY (YOUTH LACE TACKED DOWN)

ZAL3310

ZAL3311



• HEMMED SLEEVES & WAIST

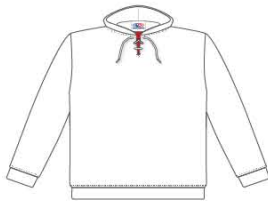

• RIB KNIT CUFFS & WAIST

SIZES

ADULT: XS - 2XL
+ OVERSIZE

YOUTH: S - XL

LADIES: XS - 2XL
+ OVERSIZE

FULL ZIP HOODIE

• HOOD WITH DRAWSTRING (NO DRAWSTRING ON YOUTH SIZES)

• FULL ZIPPER

ZAL3710

ZAL3711P*



• HEMMED SLEEVES & WAIST

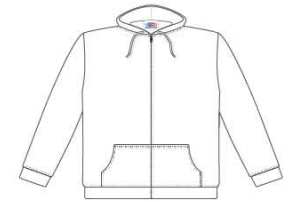

• RIB KNIT CUFFS & WAIST
* SHOWN WITH OPTIONAL FRONT POCKETS

ZAP9000 SERIES

SWEATPANTS

• ELASTIC WAISTBAND WITH DRAWSTRING

ZAP9100

ZAP9100P

ZAP9200

ZAP9200P

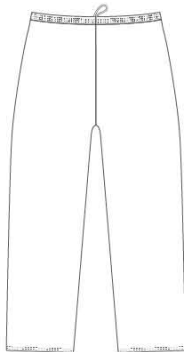

• HEMMED BOTTOMS



• HEMMED BOTTOMS
• SIDE POCKETS

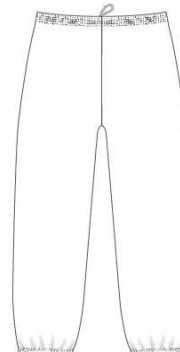

• ELASTIC BOTTOMS

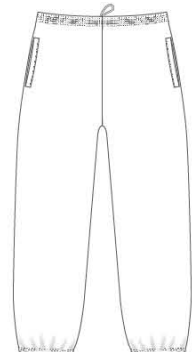

• ELASTIC BOTTOMS
• SIDE POCKETS

SIZES

ADULT: XS - 2XL
+ OVERSIZE

YOUTH: S - XL

LADIES: XS - 2XL
+ OVERSIZE



CUSTOM SUBLIMATION APPAREL PATTERNS

ZAL2000 SERIES

FULL ZIP SWEATSHIRT

- SELF FABRIC COLLAR
- FULL ZIPPER

ZAL2710



• HEMMED SLEEVES & WAIST

ZAL2711



• RIB KNIT CUFFS & WAIST

SIZES

ADULT: XS - 2XL
+ OVERSIZE

YOUTH: S - XL

LADIES: XS - 2XL
+ OVERSIZE

OPTION AVAILABLE

ZAL4711Z



POCKET ZIPPERS
FOR OPTIONAL POCKET ZIPPERS
ADD "Z" TO END OF PATTERN CODE
***ONLY AVAILABLE ON ZAL4000 SERIES PRODUCTS**

ZAL4000 SERIES

1/4 ZIP SWEATSHIRT

- SELF FABRIC COLLAR
- SIDE INSERTS
- FRONT POCKETS
- 1/4 ZIPPER

ZAL4610



• HEMMED SLEEVES & WAIST

ZAL4611



• RIB KNIT CUFFS & WAIST

SIZES

ADULT: XS - 2XL
+ OVERSIZE

YOUTH: S - XL

LADIES: XS - 2XL
+ OVERSIZE

FULL ZIP SWEATSHIRT

- SELF FABRIC COLLAR
- SIDE INSERTS
- FRONT POCKETS
- FULL ZIPPER

ZAL4710



• HEMMED SLEEVES & WAIST

ZAL4711



• RIB KNIT CUFFS & WAIST

CUSTOM SUBLIMATION APPAREL ACCESSORIES

SUBLIMATED TOQUE

- DOUBLE LAYER

ZAA101



SIZES

- ADULT
- YOUTH

SUBLIMATED SCARF

- DOUBLE LAYER

ZAA102

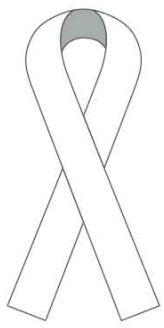

DIMENSIONS
70"L x 7"W

SUBLIMATED BANNER

DIMENSIONS

ZAA318
18"H x 12"W

ZAA324
24"H x 18"W

ZAA336
36"H x 24"W



SUBLIMATED PENNANT

DIMENSIONS

ZAA409
9"H x 24"W

ZAA412
12"H x 30"W

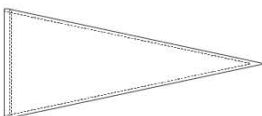

SUBLIMATED GARMENT BAG

ZAA501

- CARRY LOOP
- FULL FRONT ZIPPER

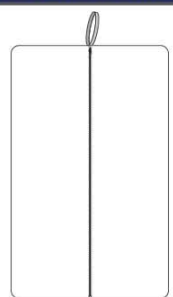

DIMENSIONS
38"H x 24"W

CUSTOM SUBLIMATION APPAREL PATTERNS

ZA10 SERIES

STANDARD FEATURES

- SELF FABRIC V-NECK
- HEMMED SLEEVES

SIZES

- ADULT: XS - 2XL + OVERSIZE
- YOUTH: S - XL
- LADIES: XS - 2XL + OVERSIZE



ZAL10 SERIES



NECK STYLES



V-NECK

ZA10 SERIES
• SHORT SLEEVES

ZAL10 SERIES
• LONG SLEEVES



CREW NECK

ZA20 SERIES
• SHORT SLEEVES

ZAL20 SERIES
• LONG SLEEVES

ZA40 SERIES

STANDARD FEATURES

- SELF FABRIC 3 BUTTON POLO
- HEMMED SLEEVES

SIZES

- ADULT: XS - 2XL + OVERSIZE
- YOUTH: S - XL
- LADIES: XS - 2XL + OVERSIZE



ZAL40 SERIES



NECK STYLES



3 BUTTON POLO

ZA40 SERIES
• SHORT SLEEVES

ZAL40 SERIES
• LONG SLEEVES



1/4 ZIPPER POLO

ZA50 SERIES
• SHORT SLEEVES

ZAL50 SERIES
• LONG SLEEVES

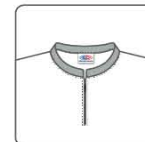

1/4 ZIPPER MANDARIN COLLAR

ZA60 SERIES
• SHORT SLEEVES

ZAL60 SERIES
• LONG SLEEVES

ZAC20 SERIES COMPRESSION FIT

STANDARD FEATURES

- SELF FABRIC CREW NECK
- HEMMED SLEEVES

SIZES

- ADULT: XS - 2XL + OVERSIZE
- YOUTH: S - XL



ZALC20 SERIES COMPRESSION FIT



ZAS90 SERIES

STANDARD FEATURES

- ELASTIC WAISTBAND WITH DRAWSTRING
- 9" INSEAM ADULT
- 7" INSEAM YOUTH
- 5" INSEAM LADIES

OPTIONS AVAILABLE

SIZES

- SIDE POCKETS (ZAS91P)
- ADULT: XS - 2XL + OVERSIZE
- YOUTH: S - XL
- LADIES: XS - 2XL + OVERSIZE



PATTERN CODE BREAKDOWN



- **ZA11** - SUBLIMATION
- **ZA11** - SPORT
- **ZA11** - NECK
- **ZA11** - SLEEVE STYLE

SUBLIMATED APPAREL SERIES



DESIGN A1801
ZAL2011P
DESIGN COLOURS 1 2 3



DESIGN A1802
ZAL3310P
DESIGN COLOURS 1 2 3



DESIGN A1803
ZAL2010P
DESIGN COLOURS 1 2 3 4



DESIGN A1804
ZAL2010P
DESIGN COLOURS 1 2 3 4



DESIGN A1805
ZAL3310P
DESIGN COLOURS 1 2 3



DESIGN A1806
ZAL2010P
DESIGN COLOURS 1 2 3



DESIGN A1807
ZAL3310P
DESIGN COLOURS 1 2 3



DESIGN A1808
ZAL3310P
DESIGN COLOURS 1 2 3



DESIGN A1809
ZAL2010P
DESIGN COLOURS 1 2 3



DESIGN A1810
ZAL2010P
DESIGN COLOURS 1 2 3



DESIGN A1811
ZAL2010P
DESIGN COLOURS 1 2 3 4



DESIGN A1812
ZAL2010P
DESIGN COLOURS 1 2 3



DESIGN A1813
ZAL2010P
DESIGN COLOURS 1 2 3



DESIGN A1814
ZAL2010P
DESIGN COLOURS 1 2 3



DESIGN A1815
ZAL3310P
DESIGN COLOURS 1 2 3



DESIGN A1816
ZAL3310P
DESIGN COLOURS 1 2 3



DESIGN A1817
ZAL3310P
DESIGN COLOURS 1 2 3



DESIGN A1818
ZAL2010P
DESIGN COLOURS 1 2 3 4

SUBLIMATED APPAREL SERIES



DESIGN A1819
ZAL3310P
DESIGN COLOURS 1 2 3 4



DESIGN A1820
ZAL2010
DESIGN COLOURS 1 2 3 4



DESIGN A1821
ZAL2010P
DESIGN COLOURS 1 2 3



DESIGN A1822
ZAL2010P
DESIGN COLOURS 1 2 3



DESIGN A1823
ZAL3310P
DESIGN COLOURS 1 2 3



DESIGN A1824
ZAL3310P
DESIGN COLOURS 1 2 3



DESIGN A1825
ZAL2010P
DESIGN COLOURS 1 2 3



DESIGN A1826
ZAL3310
DESIGN COLOURS 1 2 3



DESIGN A1827
ZAL2010P
DESIGN COLOURS 1 2 3



DESIGN A1828
ZAL2010P
DESIGN COLOURS 1 2 3 4 5



DESIGN A1829
ZAL3711P
DESIGN COLOURS 1 2



DESIGN A1830
ZAL2011P
DESIGN COLOURS 1 2 3 4



DESIGN A1831
ZAL2010P
DESIGN COLOURS 1 2



DESIGN A1832
ZAL2010P
DESIGN COLOURS 1 2 3



DESIGN A1833
ZAL2010P
DESIGN COLOURS 1 2 3 4 5



DESIGN A1834
ZAL3710P
DESIGN COLOURS 1 2 3



DESIGN A1835
ZAL2010P
DESIGN COLOURS 1 2



DESIGN A1836
ZAL2010P
DESIGN COLOURS 1 2

SUBLIMATED APPAREL SERIES



DESIGN A1837
ZAL2010P
DESIGN COLOURS 1 2 3



DESIGN A1838
ZAL2011P
DESIGN COLOURS 1 2



DESIGN A1839
ZAL2010P
DESIGN COLOURS 1 2 3 4



DESIGN A1840
ZAL2010P
DESIGN COLOURS 1 2 3



DESIGN A1841
ZAL3710
DESIGN COLOURS 1 2 3 4



DESIGN A1842
ZAL2010P
DESIGN COLOURS 1 2 3



DESIGN A1843
ZAL2010P
DESIGN COLOURS 1 2



DESIGN A1844
ZAL3710
DESIGN COLOURS 1 2 3 4



DESIGN A1845
ZAL2010
DESIGN COLOURS 1 2 3



DESIGN A1846

ZAL2011P

DESIGN COLOURS 1 2 3 4 5



DESIGN A1847

ZAL3710

DESIGN COLOURS 1 2



DESIGN A1848

ZAL2010P

DESIGN COLOURS 1 2 3 4



DESIGN A1849

ZAL3711P

DESIGN COLOURS 1 2



DESIGN A1850

ZAL2010P

DESIGN COLOURS 1 2 3



DESIGN A1851

ZAL2710

DESIGN COLOURS 1 2 3



DESIGN A1852

ZAL2710

DESIGN COLOURS 1



DESIGN A1853

ZAL2610

DESIGN COLOURS 1 2 3 4



DESIGN A1854

ZAL2611

DESIGN COLOURS 1 2



SUBLIMATED APPAREL SERIES



DESIGN A1855
ZAL2610
DESIGN COLOURS 1 2 3



DESIGN A1856
ZAL2610
DESIGN COLOURS 1 2 3



DESIGN A1857
ZAL4710
DESIGN COLOURS 1 2



DESIGN A1858
ZAL4710
DESIGN COLOURS 1 2 3



DESIGN A1859
ZAL4710
DESIGN COLOURS 1 2 3



DESIGN A1860
ZAL2610
DESIGN COLOURS 1 2 3 4 5



DESIGN A1861
ZAL2610
DESIGN COLOURS 1 2 3



DESIGN A1862
ZAL2610
DESIGN COLOURS 1 2



DESIGN A1863
ZAL2610
DESIGN COLOURS 1 2



DESIGN A1864
ZAL2610

DESIGN COLOURS 1 2 3

DESIGN AP1864
ZAP9100P

DESIGN COLOURS 1 2 3



DESIGN A1865
ZAL2010P

DESIGN COLOURS 1 2 3 4

DESIGN AP1865
ZAP9100P

DESIGN COLOURS 1 2 3 4



DESIGN A1866
ZAL2010P

DESIGN COLOURS 1 2 3 4

DESIGN AP1866
ZAP9100P

DESIGN COLOURS 1 2 3 4 5



DESIGN A1867
ZAL2010P

DESIGN COLOURS 1 2

DESIGN AP1867
ZAP9200P

DESIGN COLOURS 1 2



DESIGN A1868
ZAL2010P

DESIGN COLOURS 1 2 3 4 5

DESIGN AP1868
ZAP9100P

DESIGN COLOURS 1 2 3 4 5



DESIGN A1869
ZAL3710P

DESIGN COLOURS 1 2 3 4

DESIGN AP1869
ZAP9100

DESIGN COLOURS 1 2 3

SUBLIMATED APPAREL SERIES



DESIGN A1870

ZA22

DESIGN COLOURS 1 2 3 4

DESIGN AS1870

ZAS91P

DESIGN COLOURS 1 2 3 4



DESIGN A1871

ZA22

DESIGN COLOURS 1 2 3

DESIGN AS1871

ZAS91

DESIGN COLOURS 1 2 3



DESIGN A1872

ZA22

DESIGN COLOURS 1 2 3

DESIGN AS1872

ZAS91P

DESIGN COLOURS 1 2 3



DESIGN A1873

ZA11

DESIGN COLOURS 1 2 3

DESIGN AS1873

ZAS91

DESIGN COLOURS 1 2 3



DESIGN A1874

ZA12

DESIGN COLOURS 1 2 3

DESIGN AS1874

ZAS91

DESIGN COLOURS 1 2 3



DESIGN A1875

ZA22

DESIGN COLOURS 1 2 3

DESIGN AS1875

ZAS91

DESIGN COLOURS 1 2 3



DESIGN A1876

ZA12

DESIGN COLOURS 1 2 3

DESIGN AS1876

ZAS91

DESIGN COLOURS 1 2 3



DESIGN A1877

ZA12

DESIGN COLOURS 1 2 3

DESIGN AS1877

ZAS91

DESIGN COLOURS 1 2 3



DESIGN A1878

ZA22

DESIGN COLOURS 1 2 3

DESIGN AS1878

ZAS91

DESIGN COLOURS 1 2 3



DESIGN A1879

ZAL21

DESIGN COLOURS 1 2 3

DESIGN AS1879

ZAS91P

DESIGN COLOURS 1 2 3



DESIGN A1880

ZAL11

DESIGN COLOURS 1 2 3 4

DESIGN AS1880

ZAS91

DESIGN COLOURS 1 2 3 4



DESIGN A1881

ZAL21

DESIGN COLOURS 1 2 3

DESIGN AS1881

ZAS91P

DESIGN COLOURS 1 2 3



DESIGN A1882

ZAL21

DESIGN COLOURS 1 2 3

DESIGN AS1882

ZAS91P

DESIGN COLOURS 1 2 3



DESIGN A1883

ZAL11

DESIGN COLOURS 1 2 3

DESIGN AS1883

ZAS91P

DESIGN COLOURS 1 2 3



DESIGN A1884

ZAL11

DESIGN COLOURS 1 2 3 4

DESIGN AS1884

ZAS91

DESIGN COLOURS 1 2 3



DESIGN A1885

ZAL21

DESIGN COLOURS 1 2 3

DESIGN AS1885

ZAS91P

DESIGN COLOURS 1 2 3



DESIGN A1886

ZAL51

DESIGN COLOURS 1 2 3 4

DESIGN AS1886

ZAS91P

DESIGN COLOURS 1 2 3



DESIGN A1887

ZAL61

DESIGN COLOURS 1 2 3 4

DESIGN AS1887

ZAS91P

DESIGN COLOURS 1 2 3 4

SUBLIMATED APPAREL SERIES



DESIGN A1888
ZA52
 DESIGN COLOURS 1 2 3 4



DESIGN A1889
ZA51
 DESIGN COLOURS 1 2 3



DESIGN A1890
ZA51
 DESIGN COLOURS 1 2 3 4



DESIGN A1891
ZA51
 DESIGN COLOURS 1 2 3 4



DESIGN A1892
ZA51
 DESIGN COLOURS 1 2 3



DESIGN A1893
ZA42
 DESIGN COLOURS 1 2 3



DESIGN A1894
ZA42
 DESIGN COLOURS 1 2 3 4



DESIGN A1895
ZA51
 DESIGN COLOURS 1 2 3



DESIGN A1896
ZA41
 DESIGN COLOURS 1 2 3



DESIGN A1897
ZA51
DESIGN COLOURS 1 2 3



DESIGN A1898
ZA51
DESIGN COLOURS 1 2 3 4



DESIGN A1899
ZA41
DESIGN COLOURS 1 2 3



DESIGN A1900
ZA42
DESIGN COLOURS 1 2 3 4



DESIGN A1901
ZA51
DESIGN COLOURS 1 2 3 4



DESIGN A1902
ZA52
DESIGN COLOURS 1 2 3



DESIGN A1903
ZA42
DESIGN COLOURS 1 2 3



DESIGN A1904
ZA51
DESIGN COLOURS 1 2 3



DESIGN A1905
ZA42
DESIGN COLOURS 1 2 3

SUBLIMATED TOQUES



SUBLIMATED SCARVES

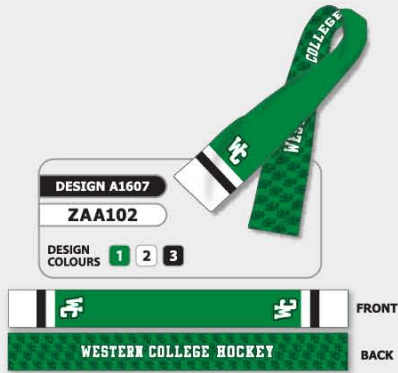

SUBLIMATED GARMENT BAGS



SUBLIMATED BANNERS



DESIGN A1601

ZAA336

DESIGN COLOURS 1 2 3

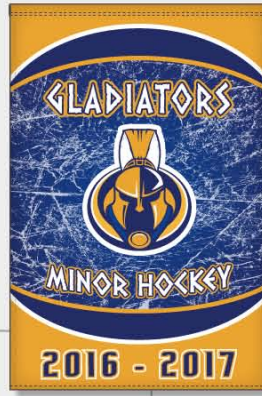

DESIGN A1602

ZAA336

DESIGN COLOURS 1 2 3 4



DESIGN A1603

ZAA336

DESIGN COLOURS 1 2 3 4 5

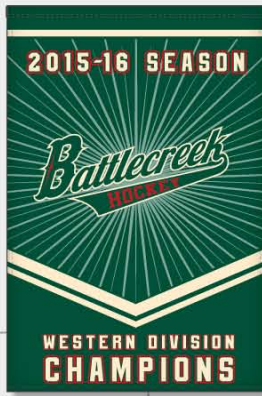

DESIGN A1604

ZAA336

DESIGN COLOURS 1 2

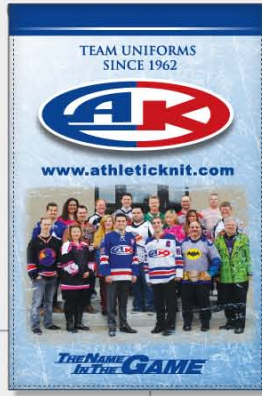

DESIGN A1605

ZAA336

DESIGN COLOURS 1 2 3

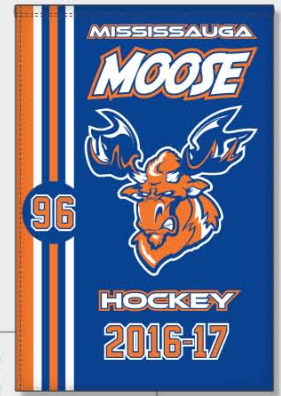

DESIGN A1606

ZAA336

DESIGN COLOURS 1 2 3



DESIGN A1607

ZAA336

DESIGN COLOURS 1 2 3

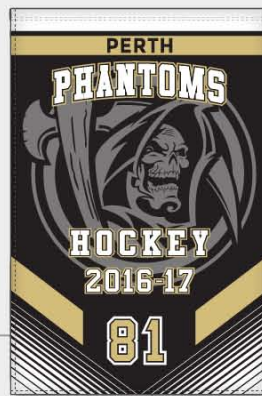

DESIGN A1608

ZAA336

DESIGN COLOURS 1 2 3



DESIGN A1609

ZAA336

DESIGN COLOURS 1 2 3 4 5 6

SUBLIMATED PENNANTS



DESIGN A1601
ZAA412
DESIGN COLOURS 1 2 3



DESIGN A1602
ZAA412
DESIGN COLOURS 1 2 3 4



DESIGN A1603
ZAA412
DESIGN COLOURS 1 2 3 4 5



DESIGN A1604
ZAA412
DESIGN COLOURS 1 2 3



DESIGN A1605
ZAA412
DESIGN COLOURS 1 2 3



DESIGN A1606
ZAA412
DESIGN COLOURS 1 2 3



DESIGN A1607
ZAA412
DESIGN COLOURS 1 2 3



DESIGN A1608
ZAA412
DESIGN COLOURS 1 2 3



DESIGN A1609
ZAA412
DESIGN COLOURS 1 2 3 4 5



DESIGN A1610
ZAA412
DESIGN COLOURS 1 2 3 4



DESIGN A1611
ZAA412
DESIGN COLOURS 1 2 3



DESIGN A1612
ZAA412
DESIGN COLOURS 1 2 3

SCREEN PRINTING - STOCK FONTS

STOCK NUMBER FONTS:

SCREEN BLOCK

1 2 3 4 5 6 7 8 9 0

CFL

1 2 3 4 5 6 7 8 9 0

SHADOW

1 2 3 4 5 6 7 8 9 0

3", 4", 6", 8", 10", 12"

1 2

1 COLOUR 2 COLOUR

3", 4", 6", 8", 10", 12"

3 4 5

1 COLOUR CFL NUMBERS 2 COLOUR CFL NUMBERS 1 COLOUR SHADOW NUMBERS

STOCK NAME FONT:

PLAIN BLOCK STENCIL

A B C D E F G H I J K L M
N O P Q R S T U V W X Y Z

TACKLE TWILL - STOCK FONTS

STOCK NUMBER FONT:

TWILL BLOCK

1 2 3 4 5 6 7 8 9 0

STOCK NAME FONT:

TWILL BLOCK

A B C D E F G H I J K L M
N O P Q R S T U V W X Y Z

3", 4", 6", 8", 10", 12"

1 2

1 COLOUR 2 COLOUR

4", 10", 12"

3

3 COLOUR

SUBLIMATION - STOCK FONTS

STOCK NUMBER FONT:

SUB BLOCK

1 2 3 4 5 6 7 8 9 0

STOCK NAME FONT:

SUB BLOCK

A B C D E F G H I J K L M
N O P Q R S T U V W X Y Z

3", 4", 6", 8", 10", 12"

1 2 3

1 COLOUR 2 COLOUR 3 COLOUR

FOR OUR FULL COLLECTION OF AVAILABLE NUMBER AND LETTER FONTS, VISIT

WWW.ATHLETICKNIT.COM

PLEASE NOTE: NOT ALL FONTS ARE AVAILABLE IN ALL APPLICATIONS.
CONTACT CUSTOMER SERVICE FOR DETAILS.



APPAREL

SWEATSHIRTS & HOODIES

SIZING - CHEST	XS	S	M	L	XL	2XL	3XL	4XL	5XL
ADULT/MENS	38"- 40"	41"- 43"	44"- 46"	47"- 49"	50"- 52"	54"- 56"	58"- 60"	62"- 64"	66"- 68"
LADIES	37"- 39"	39"- 41"	41"- 43"	43"- 45"	46"- 48"	49"- 51"	52"- 54"	55"- 57"	58"- 60"
YOUTH		32"- 34"	34"- 36"	36"- 38"	38"- 40"				

- NO DRAWSTRING ON YOUTH SIZE HOODIES

SWEATPANTS

SIZING - WAIST	XS	S	M	L	XL	2XL	3XL	4XL	5XL
ADULT/MENS	27"- 29"	30"- 32"	33"- 35"	36"- 38"	39"- 41"	43"- 45"	47"- 49"	51"- 53"	55"- 57"
LADIES	24"- 26"	26"- 28"	28"- 30"	30"- 32"	33"- 35"	36"- 38"	39"- 41"	42"- 44"	45"- 47"
YOUTH		21"- 23"	23"- 25"	25"- 27"	27"- 29"				

POLOS & T-SHIRTS & 3/4 RAGLAN

SIZING - CHEST	XS	S	M	L	XL	2XL	3XL	4XL	5XL
ADULT/MENS	36"- 38"	39"- 41"	42"- 44"	45"- 47"	48"- 50"	52"- 54"	56"- 58"	60"- 62"	64"- 66"
LADIES	35"- 37"	37"- 39"	39"- 41"	41"- 43"	44"- 46"	47"- 49"	50"- 52"	53"- 55"	56"- 58"
YOUTH		30"- 32"	32"- 34"	34"- 36"	36"- 38"				

COMPRESSION FIT SHIRTS

SIZING - CHEST	XS	S	M	L	XL	2XL	3XL	4XL	5XL
ADULT/MENS		32"- 34"	36"- 38"	40"- 42"	44"- 46"	48"- 50"	52"- 54"	56"- 58"	60"- 62"
LADIES	31"- 33"	33"- 35"	35"- 37"	37"- 39"	40"- 42"	43"- 45"	46"- 48"	49"- 51"	52"- 54"
YOUTH		23"- 25"	25"- 27"	27"- 29"	29"- 31"				

SHORTS

SIZING - WAIST	XS	S	M	L	XL	2XL	3XL	4XL	5XL
MENS		28"- 30"	32"- 34"	36"- 38"	40"- 42"	44"- 46"	48"- 50"	52"- 54"	56"- 58"
LADIES	24"- 26"	26"- 28"	28"- 30"	30"- 32"	33"- 35"	36"- 38"	39"- 41"	42"- 44"	45"- 47"
YOUTH		21"- 23"	23"- 25"	25"- 27"	27"- 29"				

BASEBALL

T-SHIRTS

SIZING - CHEST	XS	S	M	L	XL	2XL	3XL	4XL	5XL
MENS		37"- 39"	41"- 43"	45"- 47"	49"- 51"	53"- 55"	57"- 59"	61"- 63"	65"- 67"
LADIES	35"- 37"	37"- 39"	39"- 41"	41"- 43"	45"- 47"	49"- 51"	53"- 55"	57"- 59"	61"- 63"
YOUTH		30"- 32"	32"- 34"	34"- 36"	36"- 38"				



ULTIMATE TEAM PROGRAM

SAM-AK-1

PRO SERIES HOCKEY JERSEY - HOME

- H550B - NYR813B IN-STOCK HOCKEY JERSEY
- AK-KNIT - 100% POLYESTER
- TWILL LETTERING FRONT LOGO
- TWILL SHOULDER PATCHES
- TACKLE TWILL BACK AND SLEEVE NUMBERS
- TACKLE TWILL NAMEBAR

ADULT **XL**



SAM-AK-2

PRO SERIES HOCKEY JERSEY - AWAY

- H550B - NYR812B IN-STOCK HOCKEY JERSEY
- AK-KNIT - 100% POLYESTER
- SUBLIMATED TWILL PATCH FRONT LOGO
- TWILL SHOULDER PATCHES
- SUBLIMATED TWILL BACK NUMBERS
- SUBLIMATED TWILL NAMEBAR

ADULT **L**



SAM-AK-3

KNITTED HOCKEY SOCKS

- H637 - 313 IN-STOCK KNITTED HOCKEY SOCKS
- 60% POLYESTER/40% COTTON

ADULT **L**

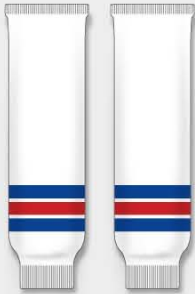

SAM-AK-4

HOCKEY PANT SHELL

- H901 - RED (005) IN-STOCK HOCKEY PANT SHELL
- DURASHELL - 100% POLYESTER

ADULT **L**



SAM-AK-5

CUT & SEW HOCKEY SOCKS

- H2100 - 812 IN-STOCK PRO CUT AND SEW HOCKEY SOCKS
- AK-KNIT - 100% POLYESTER
- DRYFLEX - 100% POLYESTER
- MOISTURE WICKING STRETCH THIGH

ADULT **L**



SAM-AK-6

PRO HOCKEY HOODIE SWEATSHIRT

- A1850 - 812 IN-STOCK LACE NECK PRO HOCKEY HOODIE
- SCREEN PRINTED FRONT LOGO
- POLYFLEECE - 100% POLYESTER

ADULT **XL**



SAM-AK-7

HOCKEY TOQUE

- A1830 - 812 IN-STOCK KNITTED HOCKEY TOQUE
- EMBROIDERED FRONT LOGO
- 100% ACRYLIC

SIZE **ADULT**



SAM-AK-8

2 COLOUR HOODIE SWEATSHIRT

- A1840 - 932 IN-STOCK HOODIE WITH DRAWSTRING
- SCREEN PRINTED FRONT LOGO
- FRONT POCKET
- POLYFLEECE - 100% POLYESTER

ADULT **L**



SAM-AK-9

CLASSIC ONE COLOUR T-SHIRT

- A1800 - 020 IN-STOCK CLASSIC ONE COLOUR T-SHIRT
- HEAT TRANSFER FRONT LOGO
- ACTIFLEX - 100% POLYESTER MOISTURE WICKING

ADULT **M**



SAM-AK-10

TRAINING SHORTS

- A1300 - 002 IN-STOCK SHORTS
- 9" INSEAM
- SCREEN PRINTED LOGO
- DRYFLEX - 100% POLYESTER MOISTURE WICKING

ADULT **L**



SAM-AK-11

3/4 SLEEVE BASEBALL TEE

- A1846 - 922 IN-STOCK 3/4 SLEEVE BASEBALL TEE
- SCREEN PRINTED FRONT LOGO
- ACTIFLEX - 100% POLYESTER MOISTURE WICKING

ADULT **L**



SAM-AK-12

TWO COLOUR POLO SHIRT

- A1820 - 208 IN-STOCK POLO
- EMBROIDERED FRONT LOGO
- ACTIFLEX - 100% POLYESTER MOISTURE WICKING

ADULT **M**



SAM-AK-13

CLASSIC ONE COLOUR POLO

- A1810 - 002 IN-STOCK CLASSIC ONE COLOUR POLO
- HEAT TRANSFER FRONT LOGO
- ACTIFLEX - 100% POLYESTER MOISTURE WICKING

ADULT **L**



SAM-AK-14

PENNANT - SMALL

- ZAA409 SUBLIMATED PENNANT
 - DURASHELL - 100% POLYESTER
- SIZE **9"H x 24"W**



SAM-AK-15

BANNER - SMALL

- ZAA318 SUBLIMATED BANNER
 - DURASHELL - 100% POLYESTER
- SIZE **18"H x 12"W**



SAM-AK-16

GARMENT BAG

- ZAA501 SUBLIMATED GARMENT BAG
 - CARRY LOOP & FULL FRONT ZIPPER
 - DURASHELL - 100% POLYESTER
- SIZE **38"H x 24"W**



FRONT

BACK



APPAREL

*THE NAME
IN THE **GAME***



www.athleticknit.com

athletic Knit
2 Scarlett Road
Toronto, Ontario
Canada, M6N 4J6



Tel: 416.766.6151
Toll Free: 1.888.818.5648
Fax: 416.766.7381
Toll Free: 1.800.354.9051

Proudly supporting our authorized dealers since 1962

A-18