

CONECTORES PARA MADERA

TIMBER CONNECTORS

Los conectores de madera pueden ser instalados con las siguientes fijaciones: Clavos, tornillos o pernos.

Material: Acero

Recubrimiento: Zincado

Reacción al fuego: Euroclass 1

Can be installed with the following fasteners; nail, screws and bolts

Material: Steel

Corrosion protector: Zinc plated

Reaction to fire: Euroclass 1

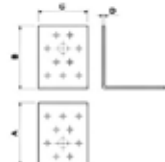
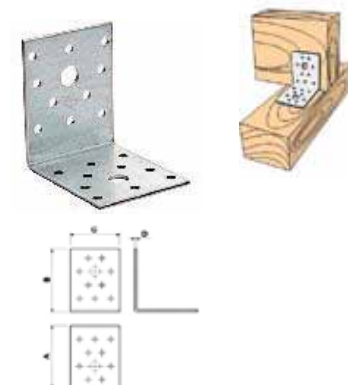
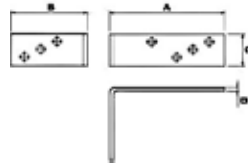
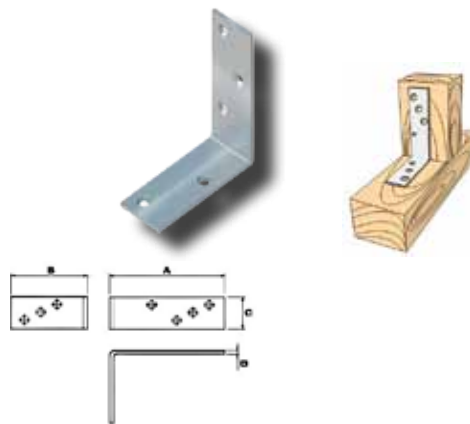
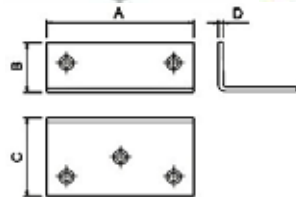
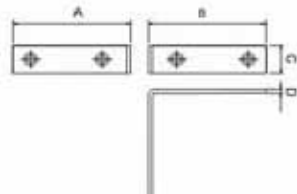
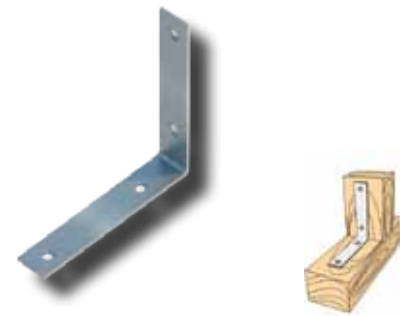

Soporte de ángulo estrecho

Código Item	Medida Size				Unds. Cartón Qty. Carton.
	Ax	Bx	Cx	D	
SAE01	25x	25x	15x	2,0	200
SAE02	30x	30x	15x	2,0	200
SAE03	40x	40x	15x	2,0	100
SAE04	50x	50x	15x	2,0	100
SAE05	60x	60x	15x	2,0	100
SAE06	75x	75x	15x	2,0	100
SAE07	90x	90x	20x	2,0	100
SAE08	100x	100x	20x	2,0	100
SAE09	100x	100x	20x	4,0	50
SAE10	120x	120x	20x	2,0	50
SAE11	125x	125x	20x	5,0	50
SAE12	150x	150x	25x	2,0	50

Soporte de ángulo ancho.

Código Item	Medida Size				Unds. Cartón Qty. Carton.
	Ax	Bx	Cx	D	
SAE13	30x	30x	30x	2	100
SAE14	40x	40x	40x	2	100
SAE15	60x	60x	60x	2	50
SAE16	75x	40x	25x	2	50

Soporte de ángulo de viga.

Código Item	Medida Size				Unds. Cartón Qty. Carton.
	Ax	Bx	Cx	D	
SAE17	100x	75x	30x	2,5	50
SAE18	100x	50x	50x	4	40
SAE19	120x	80x	35x	4	20
SAE20	180x	120x	40x	5	25

Placa de conexión en ángulo.

Código Item	Medida Size				Unds. Cartón Qty. Carton.
	Ax	Bx	Cx	D	
SAE21	50x	50x	35x	2,5	50
SAE22	70x	70x	55x	2,5	50
SAE23	90x	90x	65x	2,5	50
SAE24	105x	105x	90x	2,5	50
SAE25	150x	150x	35x	2,5	50

GARANTÍA FESIT



Indicado para:
Recommend:

Madera
Wood



Soporte de ángulo reforzado

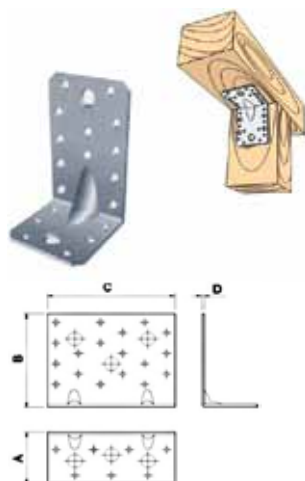

Código Item	Medida Size Ax Bx Cx D (mm)	Unds. Cartón Qty. Carton.
SAE26	70x 70x 55x 2,5	50
SAE27	90x 50x 55x 2,5	50
SAE28	90x 90x 65x 2,5	50
SAE29	105x 105x 90x 2,5	50
SAE30	90x 60x 60x 2,5	50
SAE31	90x 50x 48x 2,5	50
SAE32	90x 50x 76x 2,5	50
SAE33	90x 50x 116x 2,5	50
SAE34	65x 65x 90x 2,5	50

Soporte de ángulo reforzado

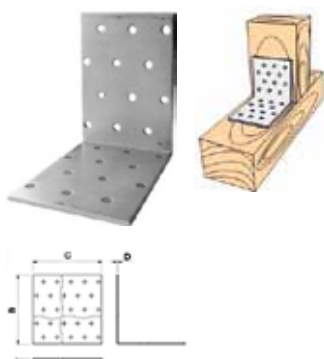

Código Item	Medida Size Ax Bx Cx D (mm)	Unds. Cartón Qty. Carton.
SAE35	40x 40x 20x 2	100
SAE36	40x 40x 40x 2	50
SAE37	40x 40x 60x 2	50
SAE38	40x 40x 100x 2	50
SAE39	40x 40x 200x 2	50
SAE40	50x 50x 40x 2	50
SAE41	60x 60x 40x 2	50
SAE42	60x 60x 60x 2	50
SAE43	60x 60x 80x 2	50
SAE44	60x 60x 100x 2	50
SAE45	80x 80x 40x 2	50
SAE46	80x 80x 60x 2	50
SAE47	100x 100x 60x 2	40
SAE48	100x 100x 80x 2	40
SAE49	100x 100x 100x 2	40
SAE50	160x 160x 60x 2	40
SAE51	160x 160x 80x 2	40

Tirante de anclaje.

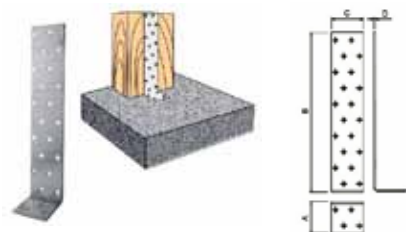

Código Item	Medida Size Ax Bx Cx D (mm)	Unds. Cartón Qty. Carton.
SAE52	40x 200x 40x 2	100
SAE53	40x 300x 40x 2	50
SAE54	40x 400x 40x 2	50
SAE55	95x 95x 40x 2	50
SAE56	120x 95x 40x 2	50

CONECTORES PARA MADERA

TIMBER CONNECTORS

Los conectores de madera pueden ser instalados con las siguientes fijaciones: Clavos, tornillos o pernos.

Material: Acero

Recubrimiento: Zincado

Reacción al fuego: Euroclass 1

Can be installed with the following fasteners; nail, screws and bolts

Material: Steel

Corrosion protector: Zinc plated

Reaction to fire: Euroclass 1

GARANTÍA FESIT



Indicado para:
Recommend:

Madera
Wood



CONECTORES PARA MADERA

TIMBER CONNECTORS

Los conectores de madera pueden ser instalados con las siguientes fijaciones: Clavos, tornillos o pernos.

Material: Acero

Recubrimiento: Zincado

Reacción al fuego: Euroclass 1

Can be installed with the following fasteners: nail, screws and bolts

Material: Steel

Corrosion protector: Zinc plated

Reaction to fire: Euroclass 1

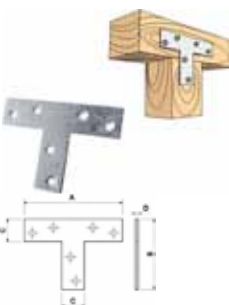
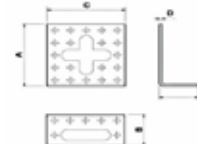
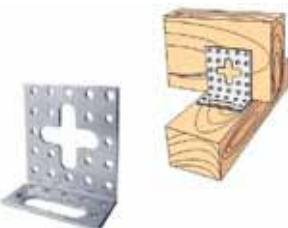
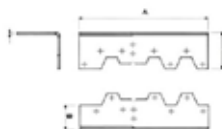
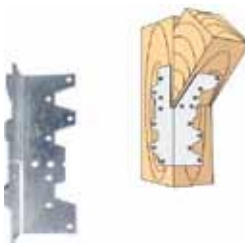
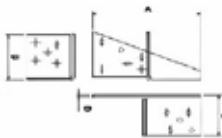
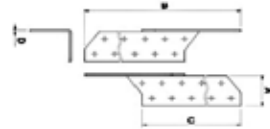
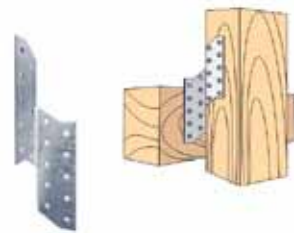

Conector de travesaño.

Código Item	Medida Size			Unds. Cartón Qty. Carton.
	Ax	Bx	Cx D (mm)	
SAE57	40x	170x	100x 2,0	25
SAE58	40x	170x	100x 2,0	25
SAE59	40x	210x	140x 2,0	25
SAE60	40x	210x	140x 2,0	25
SAE61	40x	250x	180x 2,0	25

Conector universal.

Código Item	Medida Size			Unds. Cartón Qty. Carton.
	Ax	Bx	Cx D (mm)	
SAE62	100x	50x	40x 2,5	20
SAE63	100x	50x	40x 2,5	20

Anclaje de encuadre con pestaña flexible.

Código Item	Medida Size			Unds. Cartón Qty. Carton.
	Ax	Bx	Cx D (mm)	
SAE64	120x	40x	40x 2,0	50

Anclaje de encuadre ajustable.

Código Item	Medida Size			Unds. Cartón Qty. Carton.
	Ax	Bx	Cx D (mm)	
SAE64	60x	30x	60x 2,0	50
SAE65	60x	40x	60x 2,5	50
SAE66	80x	65x	20x 4,0	50

Soporte T.

Código Item	Medida Size			Unds. Cartón Qty. Carton.
	Ax	Bx	D (mm)	
SAE67	70x	50x	16x 2,0	50

GARANTÍA FESIT



Madera Wood

Placa de clavado

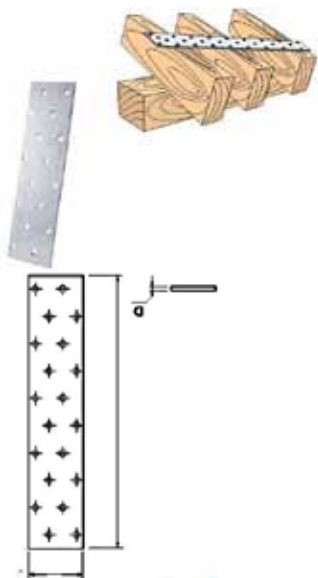

Código Item	Medida Size Ax Bx D (mm)	Uds. Cartón Qty. Carton.
SAE68	40x 80x 2,0	50
SAE69	40x 100x 2,0	50
SAE70	40x 120x 2,0	50
SAE71	40x 160x 2,0	50
SAE72	50x 180x 2,0	50
SAE73	50x 200x 2,0	50
SAE74	50x 240x 2,0	50
SAE75	60x 140x 2,0	50
SAE76	60x 160x 2,0	50
SAE77	60x 180x 2,0	50
SAE78	60x 200x 2,0	50
SAE79	60x 220x 2,0	50
SAE80	60x 240x 2,0	50
SAE81	80x 100x 2,0	50
SAE82	80x 140x 2,0	50
SAE83	80x 180x 2,0	50
SAE84	80x 200x 2,0	50
SAE85	80x 220x 2,0	50
SAE86	80x 240x 2,0	50
SAE87	80x 300x 2,0	50
SAE88	100x 200x 2,0	25
SAE89	100x 220x 2,0	25
SAE90	100x 240x 2,0	25
SAE91	100x 260x 2,0	25
SAE92	100x 300x 2,0	25
SAE93	120x 240x 2,0	20
SAE94	120x 300x 2,0	20
SAE95	140x 400x 2,0	20
SAE96	200x 200x 2,0	20
SAE97	300x 400x 2,0	20

Correa de fijación.

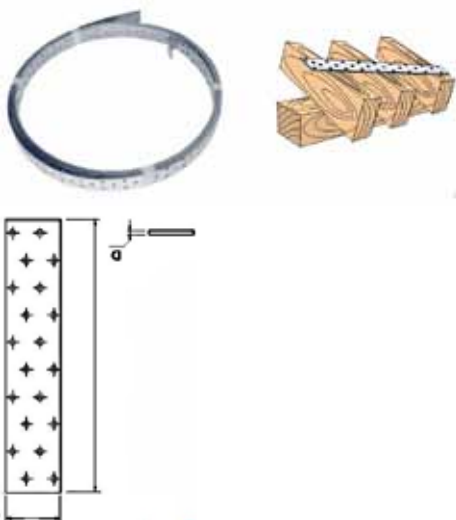

Código Item	Medida Size Ax Bx D (mm)	Uds. Cartón Qty. Carton.
SAF50	1.000x 40x 2,0	25
SAF51	1.000x 60x 2,0	25
SAF52	1.000x 80x 2,0	25

CONECTORES PARA MADERA

TIMBER CONNECTORS

Los conectores de madera pueden ser instalados con las siguientes fijaciones: Clavos, tornillos o pernos.

Material: Acero

Recubrimiento: Zincado

Reacción al fuego: Euroclass 1

Can be installed with the following fasteners; nail, screws and bolts

Material: Steel

Corrosion protector: Zinc plated

Reaction to fire: Euroclass 1

GARANTÍA FESIT



Madera Wood



Conectores para madera



Timber connectors



Conectores madera



Conessioni per legno



Connecteurs pour le bois



Conectori lemn-

CONECTORES PARA MADERA

TIMBER CONNECTORS

Los conectores de madera pueden ser instalados con las siguientes fijaciones: Clavos, tornillos o pernos.

Material: Acero

Recubrimiento: Zincado

Reacción al fuego: Euroclass 1

Can be installed with the following fasteners; nail, screws and bolts

Material: Steel

Corrosion protector: Zinc plated

Reaction to fire: Euroclass 1

Placa de anclaje.

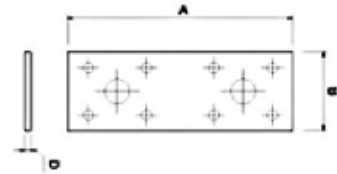
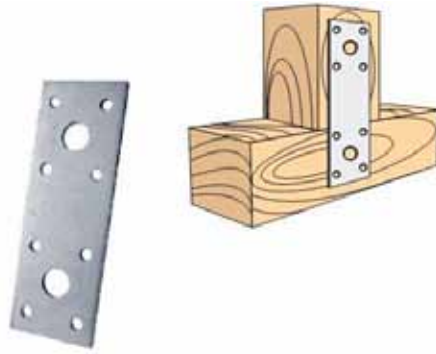

Código Item

Medida Size
Ax Bx D
(mm)Unds. Cartón
Qty. Carton.

SAF53	100x 35x 2,5	50
SAF54	140x 55x 2,5	50
SAF55	180x 40x 2,5	50
SAF56	180x 65x 2,5	50
SAF57	210x 90x 2,5	50

Placa de anclaje de alta resistencia.

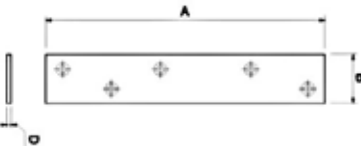
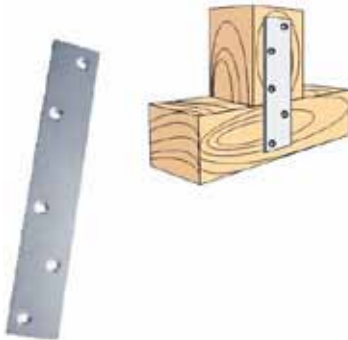

Código Item

Medida Size
Ax Bx D
(mm)Unds. Cartón
Qty. Carton.

SAF58	170x 30x 2,5	50
SAF59	195x 35x 4,0	50

Soporte interior de viga.

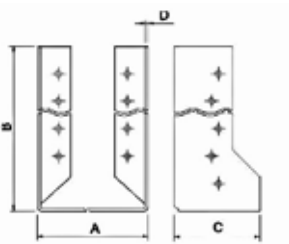
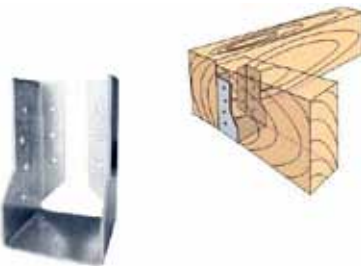

Código Item

Medida Size
Ax Bx Cx D
(mm)Unds. Cartón
Qty. Carton.

SAF60	60x 100x 60x 2,0	20
SAF61	80x 120x 60x 2,0	20
SAF62	100x 140x 60x 2,0	20
SAF63	120x 140x 60x 2,0	20
SAF64	140x 180x 60x 2,0	20

GARANTÍA FESIT



Madera
Wood

Soporte de viga.

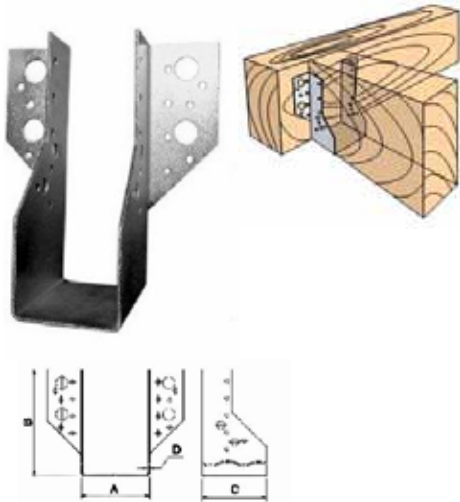

Código Item	Medida Size Ax BxCx D (mm)	Unds. Cartón Qty. Carton.
SAF65	25x 100x 75x 2,0	20
SAF66	38x 130x 75x 2,0	20
SAF67	41x 100x 75x 2,0	20
SAF68	41x 135x 75x 2,0	20
SAF69	41x 169x 75x 2,0	20
SAF70	46x 100x 75x 2,0	20
SAF71	46x 167x 75x 2,0	20
SAF72	47x 100x 75x 2,0	20
SAF73	47x 135x 75x 2,0	20
SAF74	50x 125x 75x 2,0	20
SAF75	50x 145x 75x 2,0	20
SAF76	60x 100x 80x 2,0	20
SAF77	60x 130x 75x 2,0	20
SAF78	60x 150x 75x 2,0	20
SAF79	64x 150x 75x 2,0	20
SAF80	64x 158x 75x 2,0	20
SAF81	70x 155x 75x 2,0	20
SAF82	41x 125x 75x 2,0	20
SAF83	75x 152x 75x 2,0	20
SAF84	76x 210x 75x 2,0	20
SAF85	80x 120x 80x 2,0	20
SAF86	86x 146x 75x 2,0	20
SAF87	90x 145x 75x 2,0	20
SAF88	100x 140x 80x 2,0	20
SAF89	120x 160x 80x 2,0	20
SAF90	140x 180x 80x 2,0	20

Soporte angular inclinado.

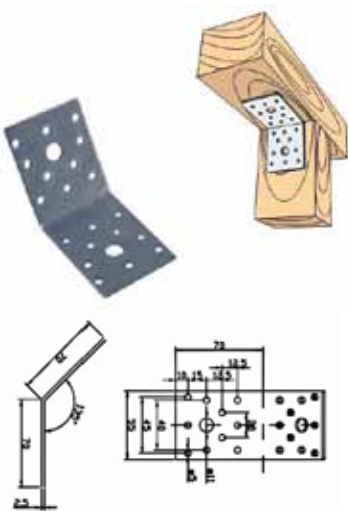

Código Item	Medida Size Ax BxCx D (mm)	Unds. Cartón Qty. Carton.
SAF91	50x 50x 35x 2,5	100
SAF92	70x 70x 55x 2,5	50
SAF93	90x 90x 65x 2,5	50
SAF94	105x 105x 90x 2,5	25

CONECTORES PARA MADERA

TIMBER CONNECTORS

Los conectores de madera pueden ser instalados con las siguientes fijaciones: Clavos, tornillos o pernos.

Material: Acero

Recubrimiento: Zincado

Reacción al fuego: Euroclass 1

Can be installed with the following fasteners; nail, screws and bolts

Material: Steel

Corrosion protector: Zinc plated

Reaction to fire: Euroclass 1

GARANTÍA FESIT



Madera Wood

CONECTORES PARA MADERA

TIMBER CONNECTORS

Los conectores de madera pueden ser instalados con las siguientes fijaciones: Clavos, tornillos o pernos.

Material: Acero

Recubrimiento: Zincado

Reacción al fuego: Euroclass 1

Can be installed with the following fasteners; nail, screws and bolts

Material: Steel

Corrosion protector: Zinc plated

Reaction to fire: Euroclass 1

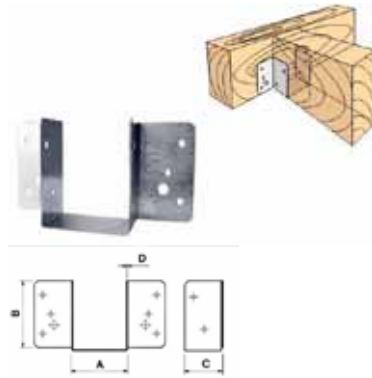

Soporte tipo C

Código Item	Medida Size Ax BxCx D (mm)	Unds. Cartón Qty. Carton.
SAG10	50x 60x 35x 1,0	25
SAG11	38x 70x 35x 1,0	25
SAG12	32x 70x 35x 1,0	25
SAG13	25x 75x 35x 1,0	25

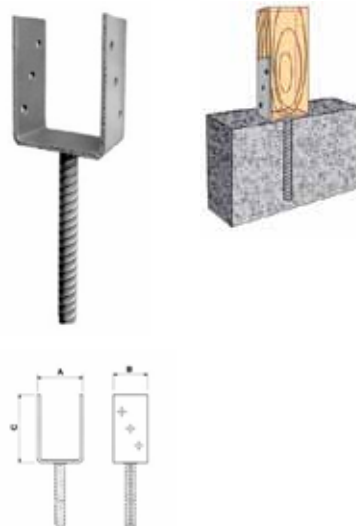

Soporte de cemento.

Código Item	Medida Size Ax BxCx D (mm)	Unds. Cartón Qty. Carton.
SAG14	70x 60x 125x 5,0	10
SAG15	80x 60x 125x 5,0	10
SAG16	90x 60x 125x 5,0	10
SAG17	100x 60x 125x 5,0	10
SAG18	150x 60x 125x 5,0	10
SAG19	84x 90x 135x 1,0	10

GARANTÍA FESIT



Madera
Wood

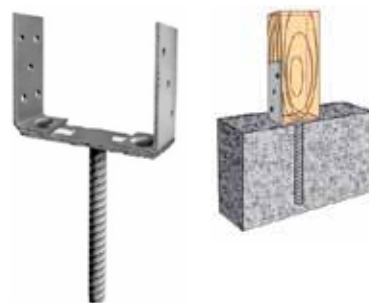

Soporte de cemento regulable.

Código Item	Medida Size Ax BxCx D (mm)	Unds. Cartón Qty. Carton.
SAG20	80-170x 60x 90x 5,0	10

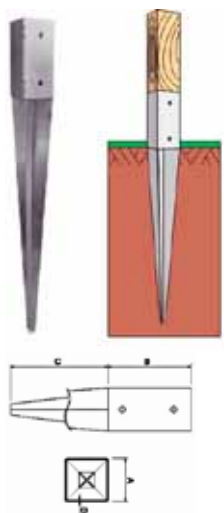

Anclaje de poste.

Código Item	Medida Size Ax BxCx D (mm)	Unds. Cartón Qty. Carton.
SAG21	71x 145x 600x 2,0	1
SAG22	91x 145x 600x 2,0	1



CONECTORES PARA MADERA

TIMBER CONNECTORS

Los conectores de madera pueden ser instalados con las siguientes fijaciones: Clavos, tornillos o pernos.

Material: Acero

Recubrimiento: Zincado

Reacción al fuego: Euroclass 1

Can be installed with the following fasteners; nail, screws and bolts

Material: Steel

Corrosion protector: Zinc plated

Reaction to fire: Euroclass 1

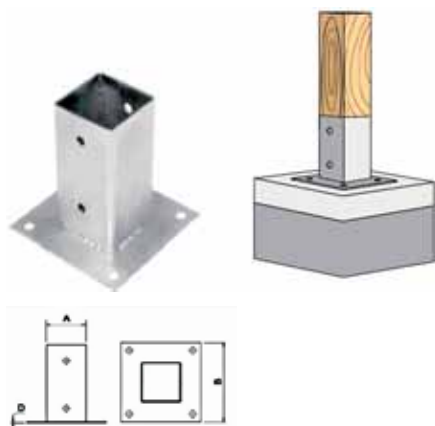

Base de poste.

Código Item	Medida Size Ax BxCx D (mm)	Unds. Cartón Qty. Carton.
SAG21	71x 145x 150x 2,0	1
SAG22	91x 145x 175x 2,0	1



Escuadra clip.

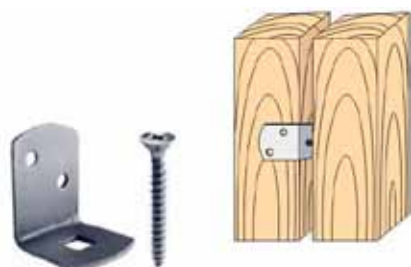

Código Item	Medida Size Ax BxCx D (mm)	Unds. Cartón Qty. Carton.
SAG21	31x 30x 27x 2,0	50



GARANTÍA FESIT



Madera Wood