

| PARTS LIST | | | | | |
|------------|-----|-----------------|--|------------------------|-------------|
| ITEM | QTY | PART NUMBER | DESCRIPTION | MANUFACTURER | AMAZON ASIN |
| 1 | 1 | BB10012 | 100 Ah 12 Volt Deep Cycle Battery | Battle Born Batteries | B06XX197GJ |
| 2 | 1 | EJ-3520-BBX | Electric Jack w/ Footplate 25-1/8" Lift - 3.5K | etrailer.com | N/A |
| 3 | 2 | 5025 | ATO/ATC Fuse Block 6-Circ w/Cover & Neg | Blue Sea Systems | B000THQ0CQ |
| 4 | 1 | 5032 | ATO/ATC Fuse Block 12-Circ Split, Cover, Neg | Blue Sea Systems | B00WM2MWQ4 |
| 5 | 1 | MKA / SHUNT-100 | 100 Amp, 100 mv Current Shunt | Deltec / AZ Wind & Sun | N/A |
| 6 | 1 | 2300 | Blue Sea Systems BusBar 10 Gang w/ Cover | Blue Sea Systems | B0091VHLW4 |
| 7 | A/R | 104043 | 18 Gauge AWG 4 Conductor Speaker Wire/Cable | Mono Price | B003KPYRJM |
| 8 | 1 | 387874 | Switch Assembly (Battery ON/OFF Switch) | Lippert | B077SS3BWC |
| 9 | 1 | 01-00055-000 | Battery Disconnect Relay | Intellitec | B072N8NYN2 |
| 10 | 2 | SPR-E-Flex-100 | 100 Watt Solar Panel | SunPower | N/A |
| 11 | 1 | 701 | Battery Switch, Surface Mount | BEP / Maringo | B005DUUL9W |
| 12 | 1 | 1011 | 12V Socket | Blue Sea Systems | B001U4ZZPK |
| 13 | 1 | PD9130LV | Power Converter - Lithium, 12 Volts, 30 Amps | Progressive Dynamics | N/A |
| 14 | 1 | ZS-30A | 5-Stage PWM Charge Controller (Lithium) | Zamp | N/A |
| 15 | 1 | TM2030A | Trimetric Battery Monitor | Bogart / AZ Wind & Sun | N/A |
| 16 | 1 | GP-SW150-12 | 150-Watt Pure Sine Wave Inverter | Go Power | B00153EYX0 |
| 17 | 1 | 4353 | Below Deck Panel, On/Off, 12V, Dual USB | Blue Sea Systems | B01AYOSD50 |
| 18 | 1 | RH2B-UTDC12V | Relay Top Mount DPDT 10A 12VDC | Idec | B005T5I9C2 |
| 19 | 1 | HW30C | 30 Amp Hardwired RV EMS | Progressive Industries | B002UC6RSA |
| 20 | 11 | 5240 | ATC 7.5 Amp Fuse (BRN) | Blue Sea Systems | B00GZOWWVU |
| 20 | 4 | 5243 | ATC 20 Amp Fuse (YEL) | Blue Sea Systems | B00GZOX0HU |
| 20 | 2 | 5245 | ATC 30 Amp Fuse (GRN) | Blue Sea Systems | B00GZOX0HK |
| 20 | 1 | 5246 | ATC 40 Amp Fuse (ORG) | Blue Sea Systems | B0000T05VM |
| 21 | 1 | B07BN1ZV12 | 12V 48 LED LIGHT BAR (QTY 4) | AMPPPER | B07BN1ZV12 |
| 22 | 1 | 00-07500K | DELUXE REMOTE CONTROL RV VENT FAN, SMOKE | MAXXFAN | B003YJDW6 |

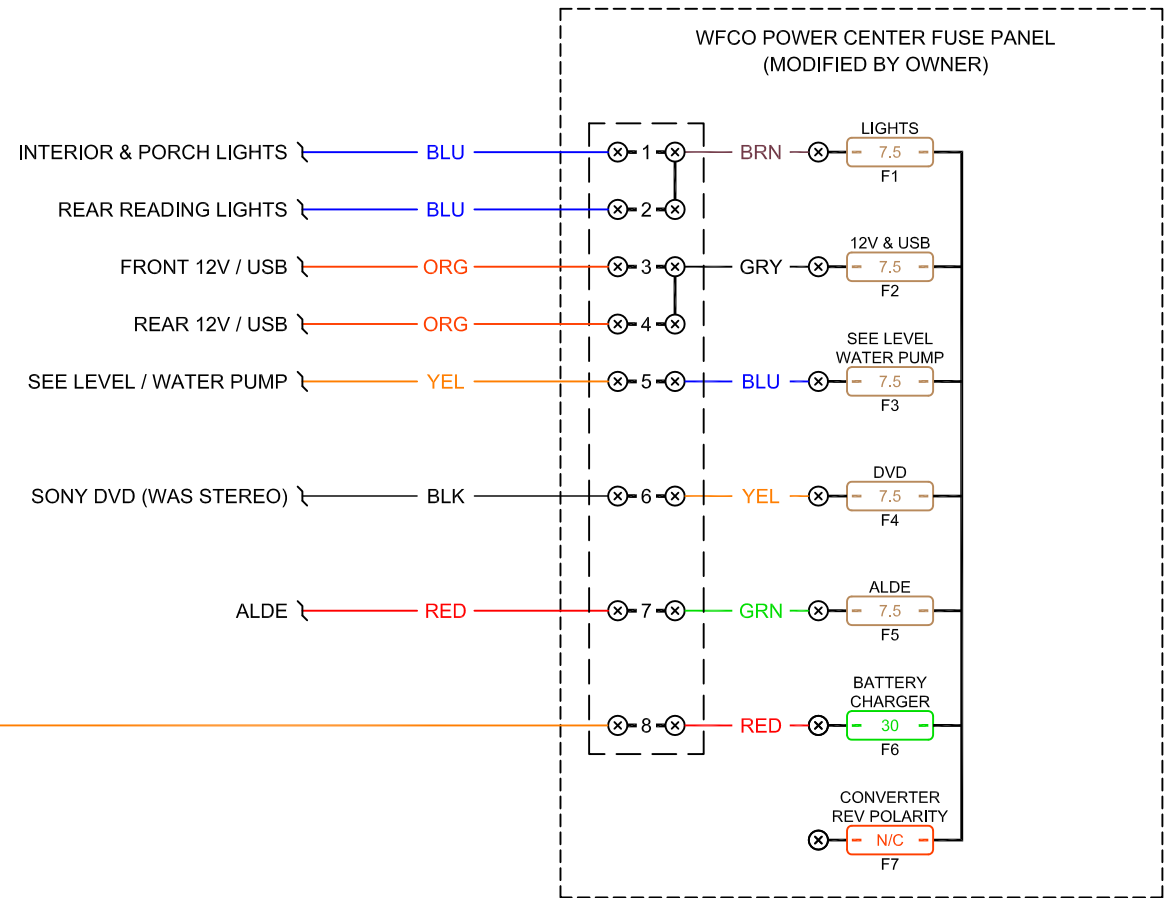

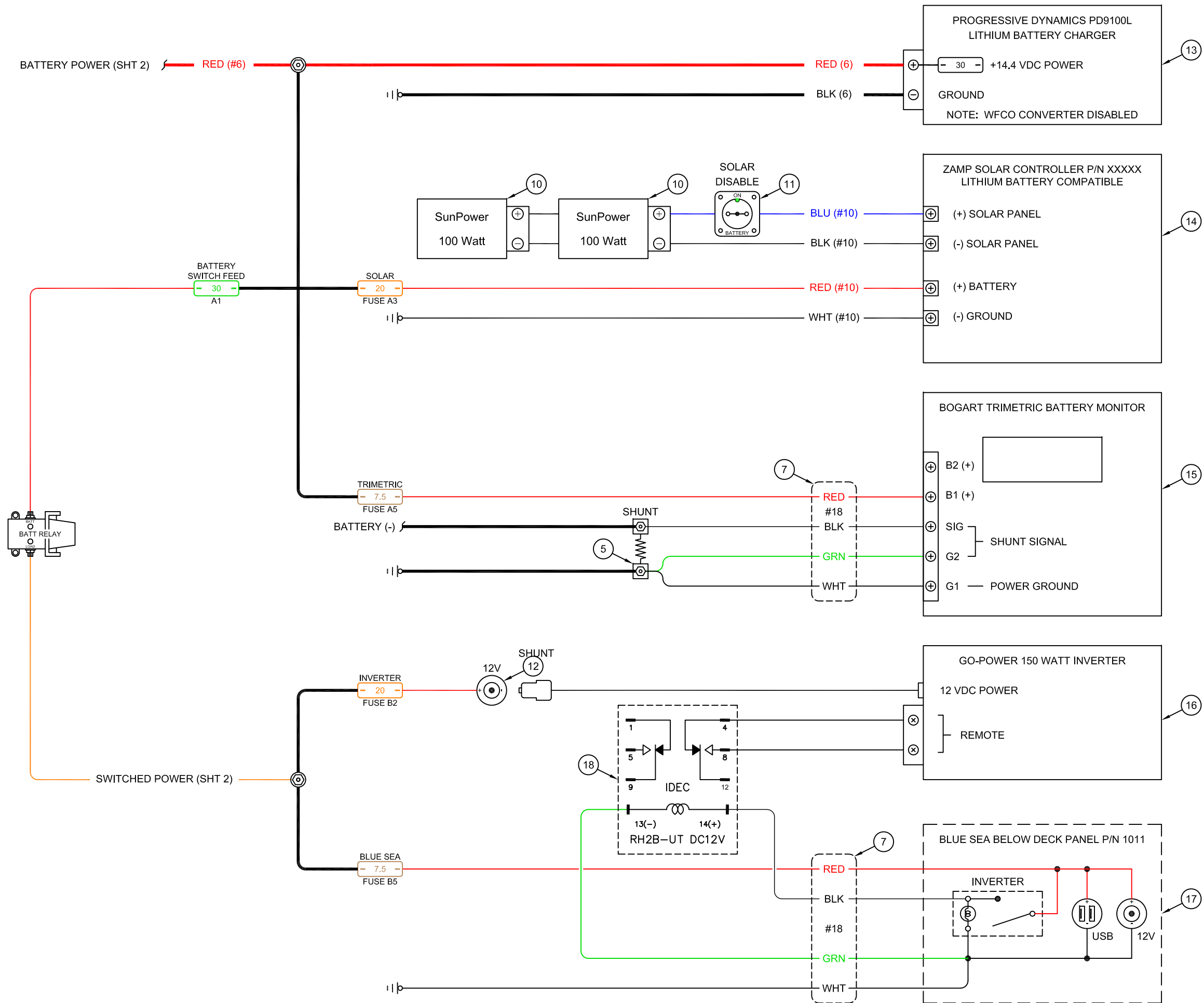

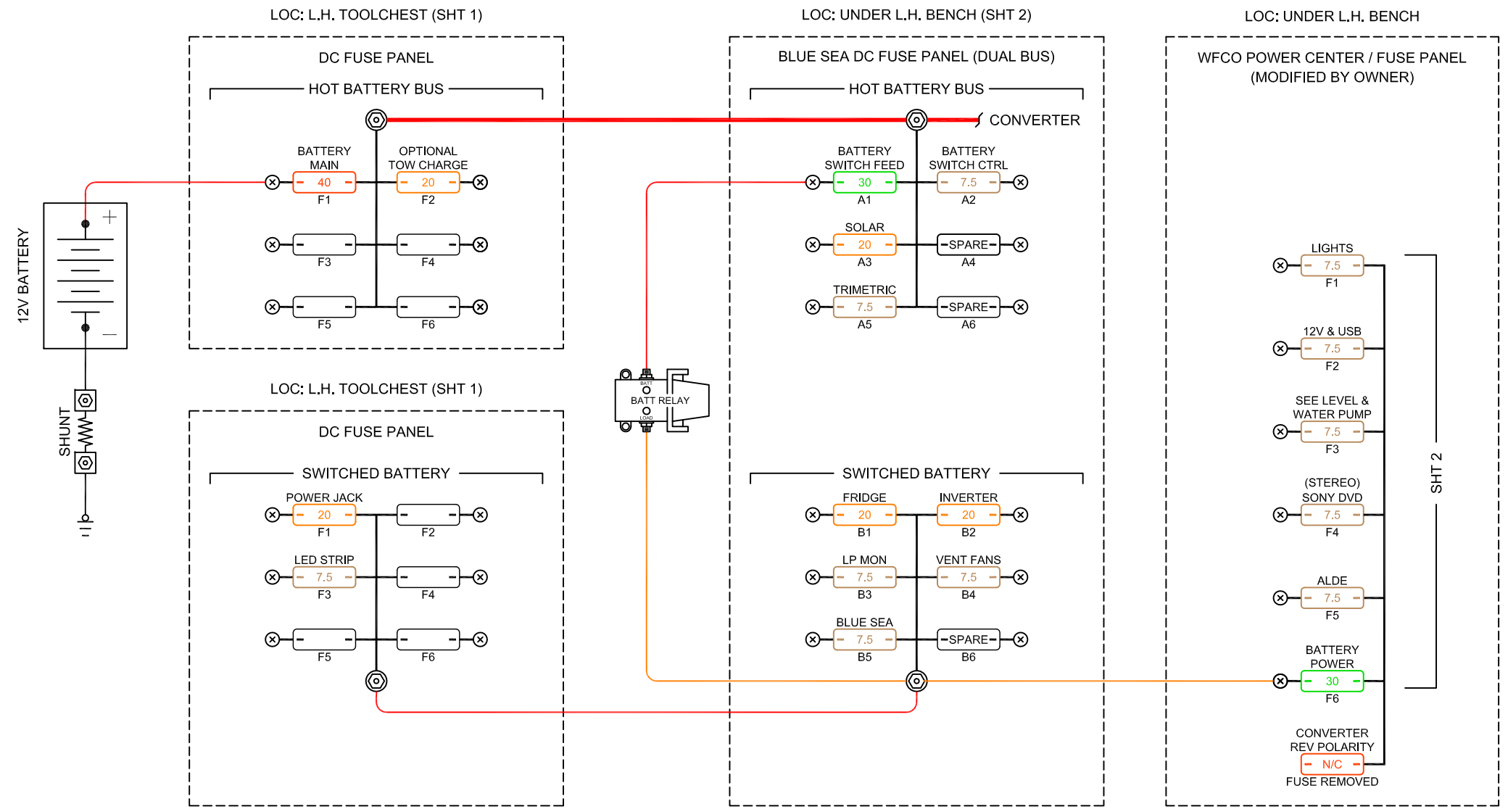

MALE NEMA L5-30P
MATING SIDE
TRAILER POWER CONNECTOR

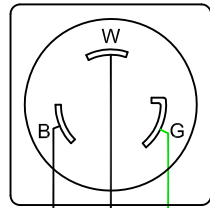

GRN #10
WHT #10
BLK #10

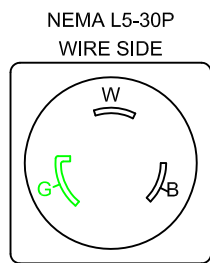

PEDESTAL CONNECTION

NEMA TT-30R
MATING SIDE

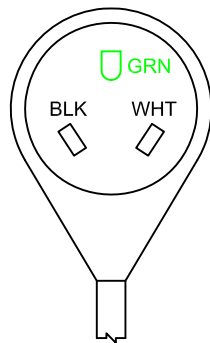

NEMA TT-30P
MATING SIDE

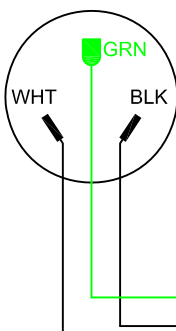

POWER CORD

NEMA L5-30R
MATING SIDE

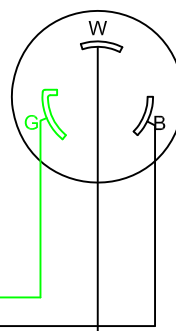

NEMA TT-30R
(WIRE SIDE)

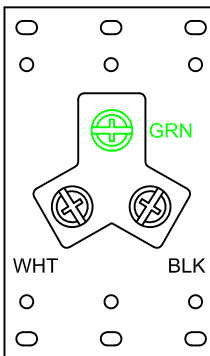

NEMA TT-30P
WIRE SIDE

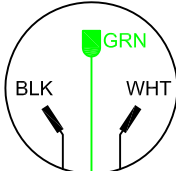

NEMA L5-30R
WIRE SIDE

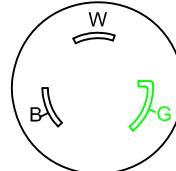

LOC: ABOVE TV

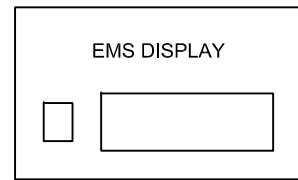

19

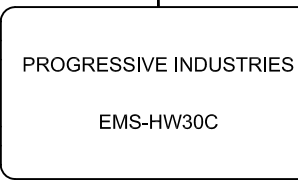

LOC: NEXT TO ALDE

19

LOC: LOWER L.H. BENCH

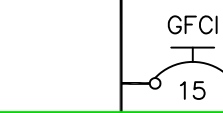
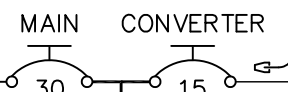

ALDE



A/C



REFRIG

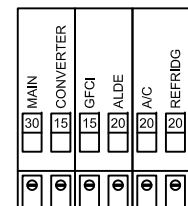

WFCO LOAD CENTER - 120 VAC CIRCUIT

THESE ITEMS ADDED BY MODIFICATION

CONV RECEPT (ADDED)

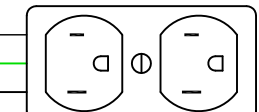

LOC: UNDER L.H. BENCH

LOC: UNDER L.H. BENCH

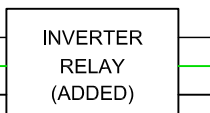

17

GFCI RECEPT

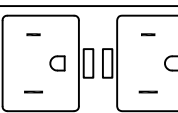

LOC: LOWER L.H. BENCH

LOC: UNDER L.H. BENCH

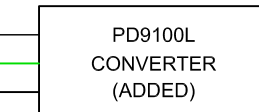

12

LOC: UNDER L.H. BENCH



16

TV EQUIP RECEPT (ADDED)

LOC: UNDER L.H. BENCH

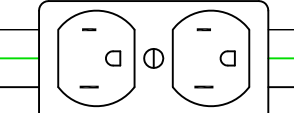

OUTDOOR RECEPT

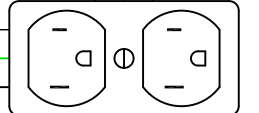
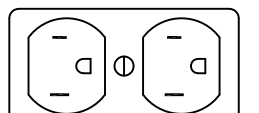

AFT BED RECEPT

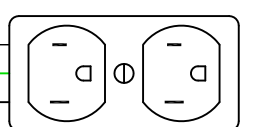

GALLEY RECEPT