

 ***SMI*** *Distributing Inc.*

---

---

**AUTOMOTIVE EXHAUST PRODUCTS**

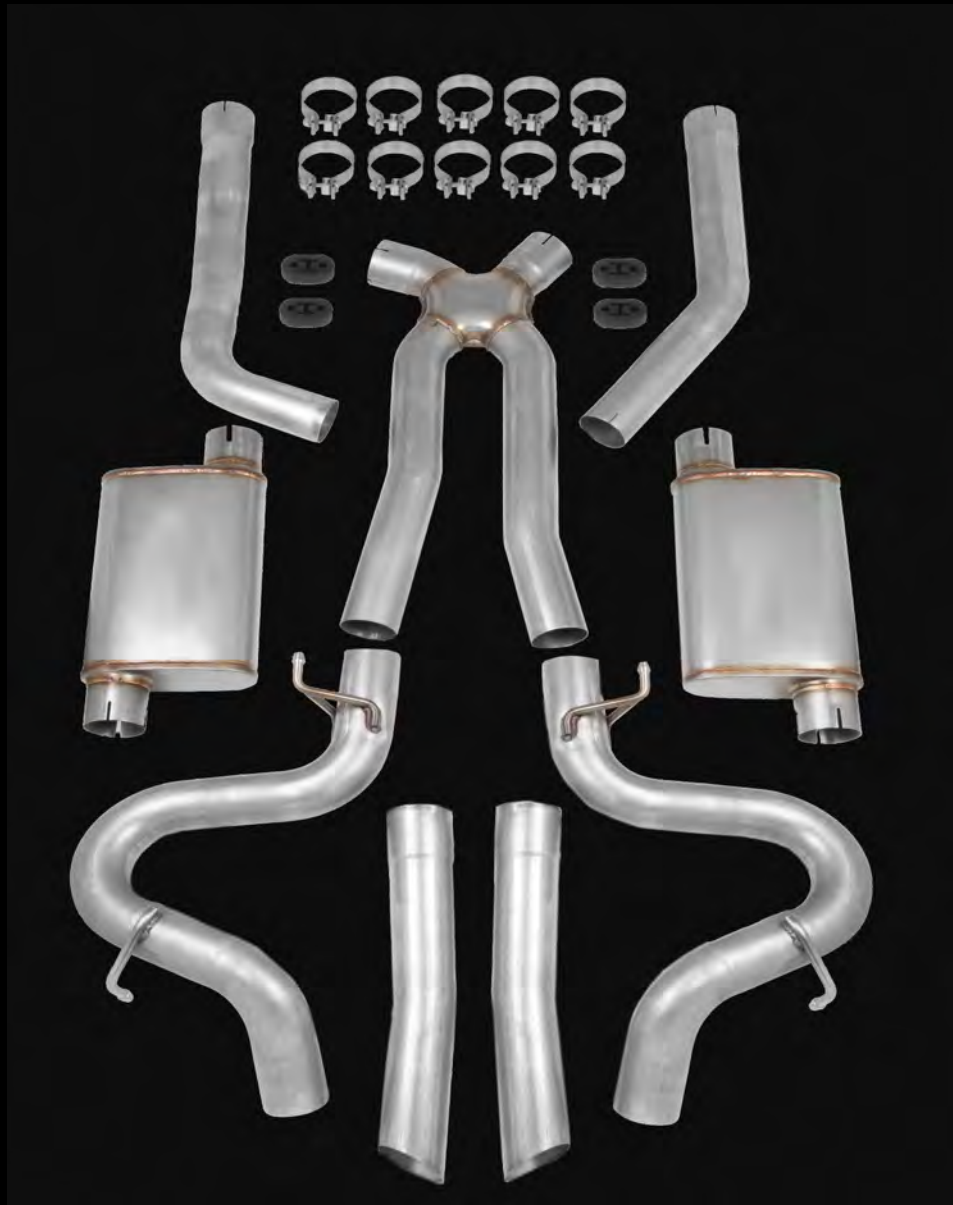

**WWW.SMIEXHAUST.COM**

### Exhaust Flange (2 Hole (Standard))

FL1502	1.50"
FL2002	2"
FL2252	2¼"
FL2502	2½"
FL3002	3"



### Exhaust Gasket (2 Hole (Universal))

G1342U	1¾"
G2002U	2"
G2252U	2¼"
G2502U	2½"

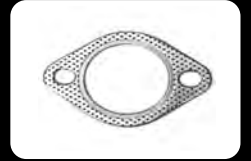

### Exhaust Flange (2 Hole (Universal))

FL134U	1¾"
FL2002U	2"
FL2252U	2¼"
FL2502U	2½"



### Exhaust Gasket (2 Hole (Standard))

G2002	2"
G2252	2¼"
G2502	2½"
G3002	3"



### Exhaust Flange (3 Holes)

FL2003	2"
FL2253	2¼"
FL2503	2½"
FL3003	3"
FL 3503	3.5"



### Exhaust Gasket (3 Hole)

G2003	2"
G2253	2¼"
G2503	2½"
G3003	3"
G3503	3½"



### Exhaust Flange ( 4 Holes)

FL 2254	2.25"
FL 4004	4"

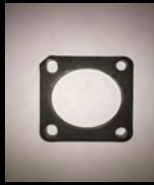

### Exhaust Gasket (Donut)

G 017	2"
G 070	2¼"
G 057	2½"



### FLANGE TOYOTA COROLLA & HONDA

SF 162	TOYOTA COROLLA, HONDA 2 HOLE, 2"
--------	--



### GASKET HONDA ELEMENT

G 469	HONDA ELEMENT
-------	---------------



### FLANGE GM

SF 012	GM 3 HOLE, 2"
--------	------------------



### GASKET TOYOTA COROLLA

G 973	TOYOTA COROLLA
-------	----------------



### GASKET GM

G 236
-------



### J-Hook

DTJ-001 5/16" J-HOOK  
 DTJ-002 3/8" J-HOOK  
 DTJ-004 3/8" ARROW HOOK



### Rubber Hanger (VOLVO)

FEH124 (O Ring) Exhaust Insulator (VOLVO)



### J Hook with Rubber

HD-002 (Swivel Hanger)



### Rubber Hanger (BMW)

FEH336 Exhaust Insulator BMW



### J HOOK MOUNTING BLOCK

HD-003 3/8"



### (BMW)

FEH337 Description Exhaust Insulator (BMW)



### MOTOR HOME

TPH 020L-50



### Rubber Hanger

8161 Exhaust Insulator (GM)



### Rubber Hanger

NIC21160 4 Hole  
(Rubber Hanger)



### MITSUBISHI

FEH 908 Exhaust Insulator (MITSUBISHI)



### L-Bracket

2HL200 2"  
 2HL550HD 5.50"  
 2HL750HD 7-1/2"  
 NHL900HD 9"



### Rubber Hanger

FEH1187 Exhaust Insulator (One Hole Larger) TOYOTA



### Straight Strap

2HS300 3"  
 2HS450 4-1/2"  
 2HS575 5-3/4"  
 2HS700 7"  
 2HS900 9"



### HONDA & ACURA

FEH560 Fits Acura & Honda



### AUDI & VW

FEH568 (O Ring) Exhaust Insulator



### O RING

FEH554 (O Ring) Exhaust Insulator



### (TOYOTA)

FEH867 Exhaust Insulator (Same Size Holes)



### Rubber Hanger

FEH556 Audi, Mercedes, VW



# HARDWARE

## Bolts

BOLT 1	5/16" X 1.25"
BOLT 2	5/16" X 1.50"
BOLT 3	3/8" X 1.25"
BOLT 4	3/8" X 1.50"
BOLT 5	3/8" X 2"
BOLT 6	3/8" X 2.50"
BOLT 7	3/8" X 3"
BOLT 8	7/16" X 1.50"
BOLT 9	7/16" X 2"



## Nuts Standard Flare

NUT 1	5/16"	STANDARD NUT
NUT 2	5/16"	FLARE NUT
NUT 3	3/8"	STANDARD NUT
NUT 4	3/8"	FLARE NUT
NUT 5	7-16"	STANDARD NUT



## Washers

WASHER 1	5/16" X 1.25"	FENDER WASHER
WASHER 2	5/16"	SPLIT LOCK
WASHER 3	5/16" X 1"	FLAT WASHERS
WASHER 4	3/8" X 1.25"	FENDER WASHERS
WASHER 5	3/8"	SPLIT LOCK
WASHER 6	3/8" X 1"	FLAT WASHERS
WASHER 7	7/16"	SPLIT LOCK



## Manifold Studs



H-197	8mm x 1.25p x 43 mm	(VW)
H-210	10mm x 1.25p x 43 mm	(TOY)
H-212	10mm x 1.50p x 43 mm	(NISS)
H-561	3/8" X 2.5"	COARSE
H-562	3/8" X 3.5"	COARSE
H-564	7/16" X 2.50"	COARSE

## Metric Nuts

H 207	8 MM	8 X 1.25
H 208	10 MM	10 X 1.50
H 209	10 MM	10 X 1.25



## Sensor Nuts

OX-002	O2 SENSOR NUT
OX-003	O2 SENSOR SPACER
5140-3X	45 DEGREE O2 SENSOR NUT
80062	O2 SENSOR PLUG
5140-5	TOYOTA O2 SENSOR FLANGE



## U-Bolt Exhaust Clamp

SMICL112	1.50"
SMICL134	1.75"
SMICL200	2"
SMICL214	2.25"
SMICL212	2.50"
SMICL300	3"
SMICL350	3.50"
SMICL400	4"
SMICL500	5"



## V Band Clamp

VFQ-212	2.50"
VFQ-300	3"



## Rubber Grommet

BR015	Female
BR016	Male
GR121	(Hi-Temp with washer)



## Flexible-Joint

SJ134	1.75"
SJ200	2"
SJ225	2.25"
SJ250	2.50"
SJ300	3"



## DIRECT FLEX PIPE

GM 5	1996-1997
	CHEVY S-10 2.2L
	GMC S-15 SONOMA 2.2L
	ISUZU HOMBRE 2.2 L



## DIRECT FLEX PIPE

GM 11

02-08	CHEVY COBALT DOHC VIN F 2.2L
05-08	CHEVY COBALT DOHC VIN B 2.4L
06-08	CHEVY HHR DOHC 2.2L, 2.4L
06-08	PONTIAC G5 DOHC 2.2L
07-08	PONTIAC G5 DOHC 2.4L



## GLASS PACK

A3012B	3"	1.75"	12"
A3014B	3"	1.75"	14"
A3016B	3"	1.75"	16"
A3018B	3"	1.75"	18"
A3022B	3"	1.75"	22"
A3509B	3.5"	2"	9"
A3512B	3.5"	2"	12"
A3514B	3.5"	2"	14"
A3516B	3.5"	2"	16"
A3518B	3.5"	2"	18"
A3520B	3.5"	2"	20"
A3522B	3.5"	2"	22"
A3524B	3.5"	2"	24"
A3526B	3.5"	2"	26"
A3530B	3.5"	2"	30"
A3536B	3.5"	2"	36"
A3540B	3.5"	2"	40"
A3509B-225	3.5"	2.25"	9"
A3512B-225	3.5"	2.25"	12"
A3515B-225	3.5"	2.25"	15"
A3518B-225	3.5"	2.25"	18"
A3522B-225	3.5"	2.25"	22"
A3524B-225	3.5"	2.25"	24"
A4512B	4"	2.50"	12"
A4515B	4"	2.50"	15"
A4518B	4"	2.50"	18"
A4520B	4"	2.50"	20"
A4522B	4"	2.50"	22"
A4524B	4"	2.50"	24"
A4526B	4"	2.50"	26"
A4530B	4"	2.50"	30"
A4312B	4"	3"	12"
A4315B	4"	3"	15"
A4318B	4"	3"	18"
A4322B	4"	3"	22"
A4326B	4"	3"	26"
A4330B	4"	3"	30"



## DIRECT FLEX PIPE

DS 1

95-00	DODGE STRATUS 2.0L, 2.4L, 2.5L
98-00	PLYMOUTH BREEZE 2.0L
97-00	PLYMOUTH NEON 2.0L
95-00	CHRYSLER SEBRING 2.4L, 2.5L
96-97	CHRYSLER CIRRUS 2.4L
95-98	CHRYSLER CIRRUS LT 2.5L
01-07	PT CRUISER TURBO 2.4L



## FLEX PIPES

	<u>Diameter</u>	<u>Length</u>
DTF 1704B	1.75"	4"
DTF 1706B	1.75"	6"
DTF 1708B	1.75"	8"
DTF 1710B	1.75"	10"
DTF 2004	2"	4"
DTF 2006	2"	6"
DTF 2008	2"	8"
DTF 2010	2"	10"
DTF 2404B	2.25"	4"
DTF 2406B	2.25"	6"
DTF 2408B	2.25"	8"
DTF 2410B	2.25"	10"
DTF2504B	2.5"	4"
DTF2506B	2.5"	6"
DTF2508B	2.5"	8"
DTF2510B	2.5"	10"
DTF 3004	3"	4"
DTF 3006	3"	6"
DTF 3008	3"	8"
DTF 3010	3"	10"
DTF 3508	3.5"	8"
DTF 4008B	4"	8"



# TAILPIPES

## EXHAUST PIPE (FRONT)

93993 (2 BOLT)

CHEVY S10	96-97	2.2L
GMC SONOMA		2.2L
ISUZU HOMBRE		2.2L



## Truck Universal Tailpipes

### DESCRIPTION

X6302	Driver Side with 45 degree exit
X6301	Passenger Side with 45 degree exit
X6008	Driver Side with 90 degree exit
X6007	Passenger Side with 90 degree exit
54150	4" Passenger Side Tailpipe
55555	3.5" 05-07 Ford F-250 WALKER



## EXHAUST PIPE (FRONT)

93994 (3 BOLT)

CHEVY S10	98-03	2.2L
GMC SONOMA	98-03	2.2L
ISUZU HOMBRE	98-00	2.2L



## FORD MUSTANG

84-04

125637 DRIVER SIDE 2.25"

125636 PASSENGER 2.25"

87-93 (MANDREL BEND)

X5002 DRIVER SIDE 2.50"

X5003 PASSENGER 2.50"



64756 DRIVER SIDE

64755 PASSENGER

FORD CROWN VICTORIA 92-97

V8-4.6L

LINCOLN TOWN CAR 91-97

V8-4.6L

LINCOLN TOWN CAR 90

V8-5.0L

MERCURY GRAND MARQUIS 92-97

V8-4.6L



64703 DRIVER SIDE

64702 PASSENGER

FORD CROWN VICTORIA LTD 89

V8-5.0L, 5.8L

LINCOLN TOWN CAR 88-89

V8-5.0L

MERCURY GRAND MARQUIS 89

V8-5.0L, 5.8L

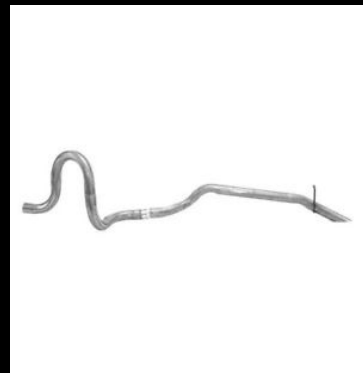

## EXHAUST PIPE (FRONT)

X6500 MANDREL BEND

CHEVY CAMARO 83-92



# ALUMINIZED TUBING

T112	1.5"
T134	1.75"
T200	2"
T225	2.25"
T250	2.5"
T300	3"
T350	3.5"
T400	4"
T500	5"
T600	6"



## 13 GAUGE

49069	2" X 10'
49068	2.25" X 10'
49067	2.50" X 10'
49065	3.00" X 10'
300A1013	3.00" X 10'

## METAL ROD

### Ø

R516	5/16" X 10'
R38	3/8" X 10'
R12	1/2" X 10'



## X Pipes

AX2020	2"
AX 2424	2.25"
AX 2525	2.50"
AX 3030	3"
SX 2424	2.25" (STAINLESS)
SX 2525	2.50" (STAINLESS)
SX 3030	3" (STAINLESS)



## Y Pipes

	<u>Inlet</u>	<u>Outlet</u>
AY 2020	2"	2"
AY 2424	2.25"	2.25"
AY 2525	2.50"	2.50"
AY 3030	3"	3"
AY 2524	2.5"	2.25"
AY 3024	3"	2.25"
AY3025	3"	2.50"



# Chrome Tips

## Angle Cut Tips

	<u>Inlet</u>	<u>Outlet</u>	<u>Length</u>
AC31212	2.25"	3.50"	12"
AC31212-3	3"	3.50"	12"
AC31216	2.25"	3.50"	16"
AC31218	2.25"	3.50"	18"
AC31222	2.25"	3.50"	22"
AC412	2.25"	4"	12"
AC418	2.25"	4"	18"
AC418-3	3"	4"	12"



## Pencil Tips

	<u>DIAMETER</u>	<u>LENGTH</u>
PT112	1.50"	9"
PT134	1.75"	9"
PT200	2"	9"
PT214	2.25"	9"
PT212	2.50"	9"
IR-3512-3	3.50"	9"
PT112-14	1.50"	14"
PT134-14	1.75"	14"
PT200-14	2"	14"
PT225-14	2.25"	14"
PT250-14	2.50"	14"



## Angel Cut Tips

	<u>Diameter</u>	<u>Length</u>
AC 112	1.50"	9"
AC 134	1.75"	9"
AC 200	2.00"	9"
AC 214	2.25"	9"
AC 212	2.50"	9"
AC 300	3"	9"



## Turn Down Tips

	<u>Diameter</u>	<u>Length</u>
TD 134	1.75"	8"
TD 200	2.00"	8"
TD 214	2.25"	8"
TD212	2.50"	8"



## Rolled in Tips

	<u>Inlet</u>	<u>Outlet</u>	<u>Length</u>
AC 31212	2.25"	3.5"	12"
AC 31212-3	3"	3.5"	12"
AC 31216	2.25"	3.5"	16"
AC 31218	2.25"	3.5"	18"
AC 31222	2.25"	3.5"	22"
AC 412	2.25"	4"	12"
AC 418	2.25"	4"	18"



# Aluminized Elbows & U-Bends

## 45 Degrees

UB15045AL	1.50"
UB17545AL	1.75"
UB20045AL	2.00"
UB22545AL	2.25"
UB25045AL	2.50"
UB30045AL	3.00"



## 90 Degrees

UB15090AL	1.50"
UB17590AL	1.75"
UB20090AL	2.00"
UB22590AL	2.25"
UB25090AL	2.50"
UB30090AL	3.00"



## 180 degree Aluminized U Bends

UB 150AL	1.50"
UB 175AL	1.75"
UB 200AL	2.00"
UB 225AL	2.25"
UB 250AL	2.50"
UB 300AL	3.00"



## H.D. ELBOW

10632      30 DEGREES  
4" ID-4"OD



## ADAPTERS/REDUCERS

9722	4"-3"
9332	4"-3.5"
8965	5"-4"



## RIDGID TUBING CUTTER

32940

1" - 3 1/8"



## TUBE CUTTER REPLACEMENT WHEELS

33175

FOR RIDGID  
TUBE CUTTER



## Muffler Stand

JMS 1







**HydraBOND Mig/Mag Welding Wire**

	<u>Size</u>	<u>Weight</u>
11-023	0.023"	(11 Lbs)
11-030	0.030"	(11 Lbs)
11-035	0.035"	(11 Lbs)
30-030	0.030"	(30 Lbs)
30-035	0.035"	(30 Lbs)



**TWECO/LINCOLN**

HB 6511 MIG GUN 130A

HB 6511F MIG GUN 130A, FLEXIBLE

**TWECO/LINCOLN GUN WITH MILLER FITTING**

HB6514 MIG GUN, 15 FEET

**Welding Helmet**

**AUTOMATICALLY DARKENS**

**HB 2019**



**MISGLOVE**

H.WEIGHT 8oz.  
Brown Jersey  
Gloves, Knit Wrist,  
(12-Pairs)



300A

HYDRABOND EARTH  
CLAMP



**Chop Saw Discs**

12346



**TWECO/LINCOLN**

Contact Tip      Gas Diffuser      Nozzle

11-23		
11-30	35-50 TIP HOLDER	21-50
11-35		

BHG 52 TIP HOLDER

14-23	<u>NOZZLE INSULATOR</u> BHG32
14-30	
14-35	

NOZZLE  
BHG22-50

**MILLER**

**Contact Tip**

BHG087299	11-023
BHG000067	11-030
BHG000068	11-035



**Small Miller**

TIP ADAPTOR  
BHG169728

NOZZLE  
BHG169715

**Larger Miller**

TIP ADAPTOR  
BHG169729  
NOZZLE  
BHG169725  
(LARGER)

TIP ADAPTOR  
BHG169728  
NOZZLE  
BHG169724  
(SMALLER)



**Welding Rod**

<u>Parts #</u>	<u>Size</u>	<u>Weight</u>
WASRG60	1/8" x 36"	Sold by 10 pound bundles

**Gator Sawzall Blades**

12022	6"
12023	8"
12025	6" HeavyDuty
12027	8" HeavyDuty



**Muffler Cement**

T27      16oz



# ECONOMY MUFFLERS

## 6" ROUND / REDONDO

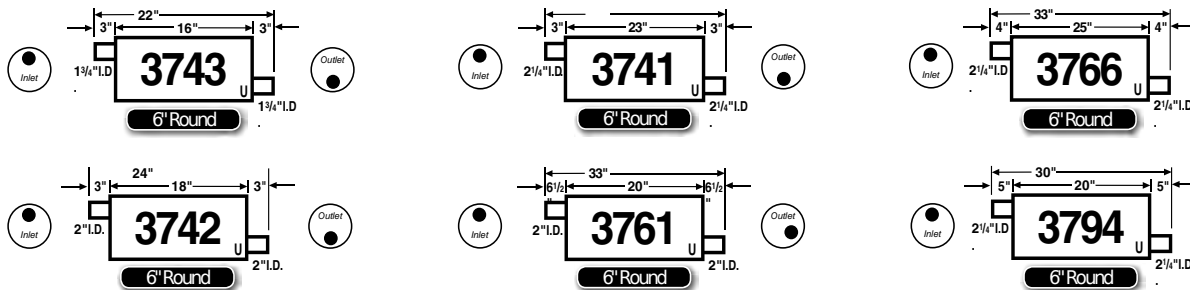

## 3 1/4" X 7 3/4" OVAL / OVALADO



**ENFORCER**

## 4 1/4" X 8 3/4" OVAL / OVALADO

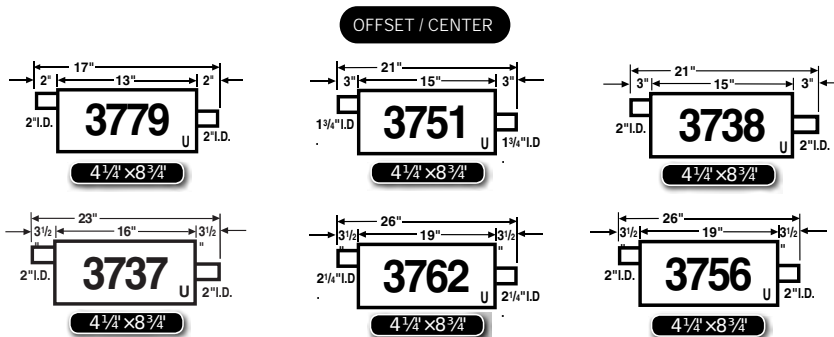

OFFSET / OFFSET

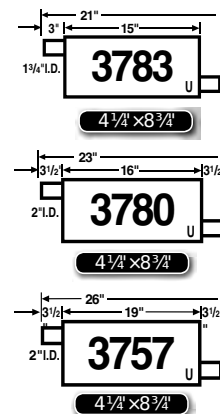

## 4 1/16" X 10 1/2" OVAL / OVALADO

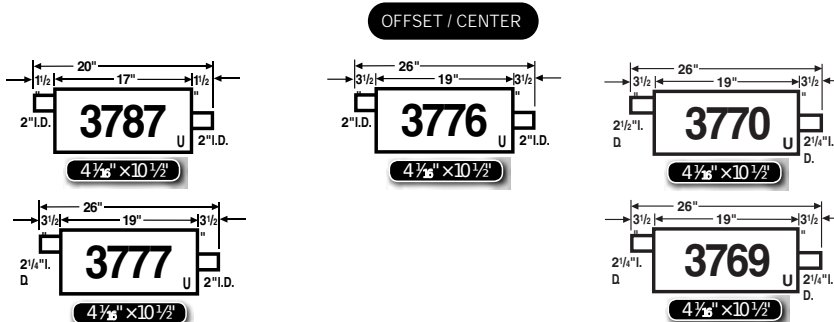

OFFSET / OFFSET

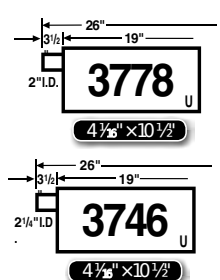

# MMSL<sup>®</sup> MUFFLER

## 4" ROUND / REDONDO

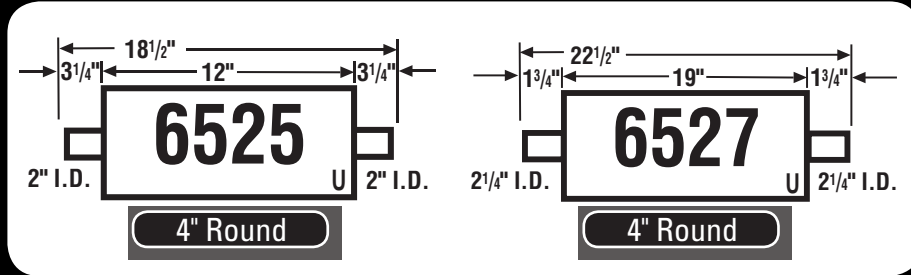

## 5" ROUND / REDONDO

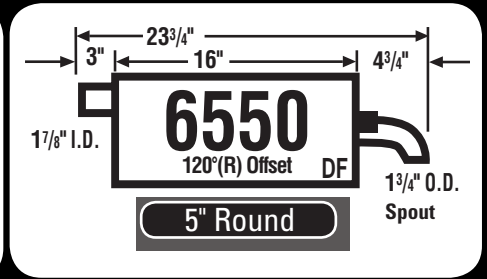

## 7" ROUND / REDONDO

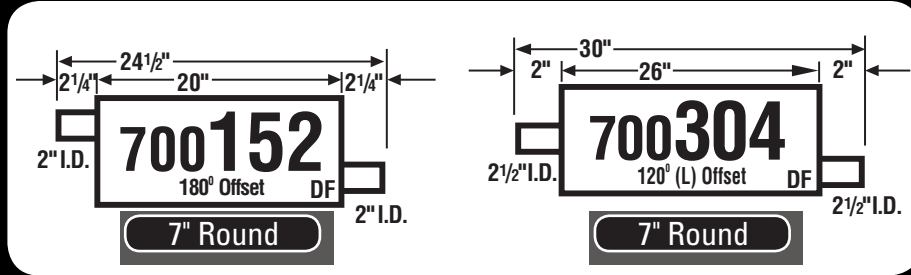

## 3 1/4" x 7 3/4" OVAL

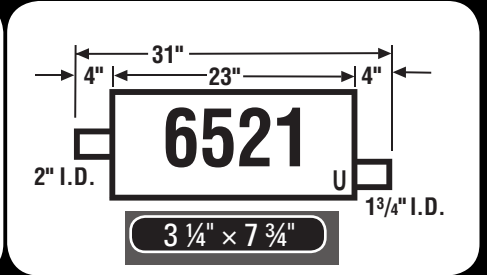

## 4 1/4" x 8" OVAL / OVALADO

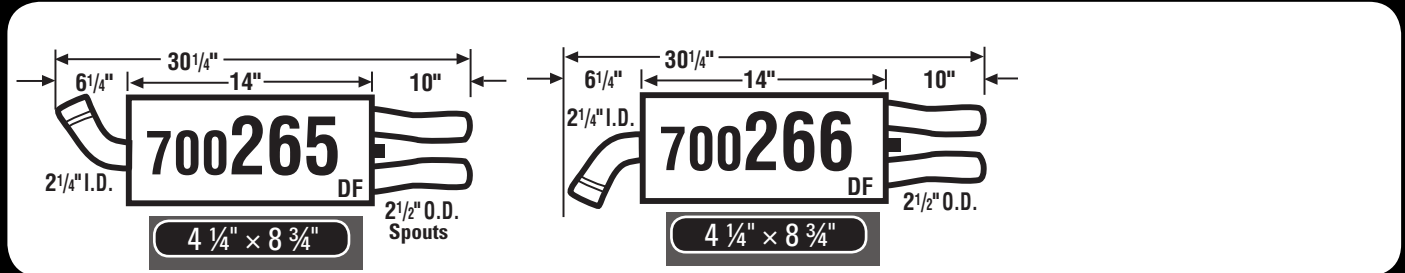

## 4 1/16" x 10 1/2" OVAL / OVALADO

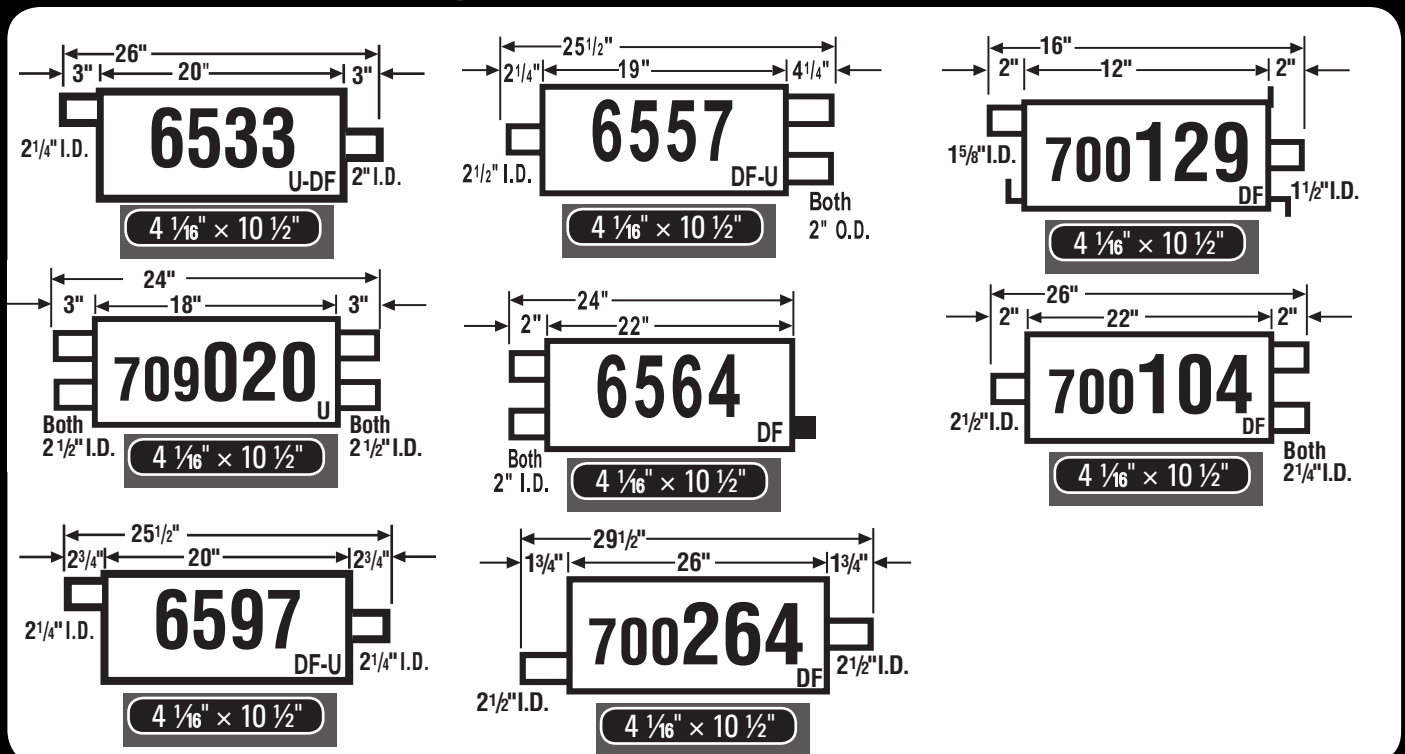

# MSL<sup>®</sup> MUFFLER

4 1/4" x 11" OVAL

5 1/2" x 11" OVAL / OVALADO

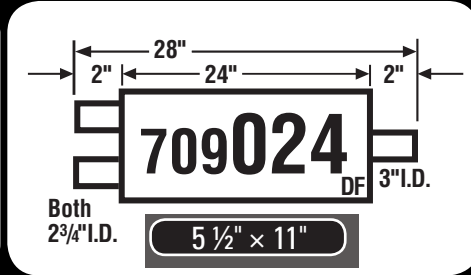
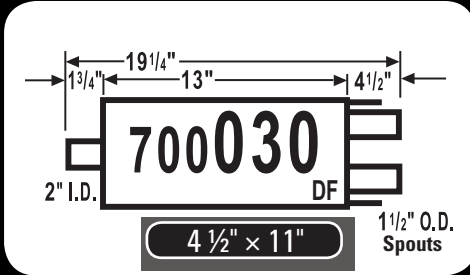

7" x 9" OVAL / OVALADO

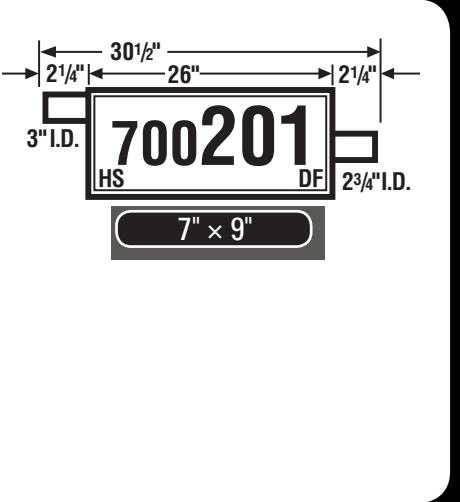
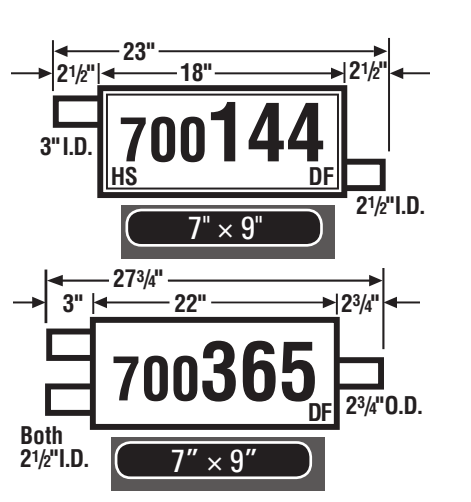
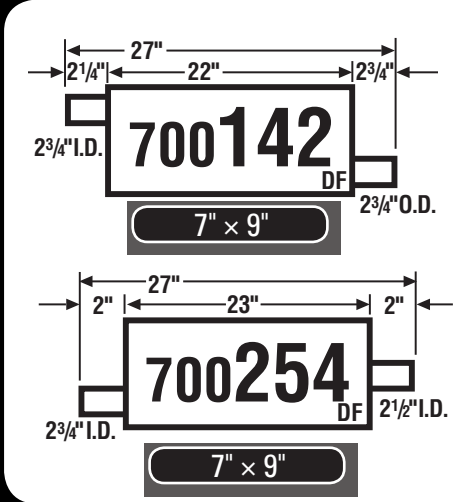

# BIG MAX<sup>®</sup> TURBO MUFFLER

4 1/4" x 8 3/4" OVAL / OVALADO

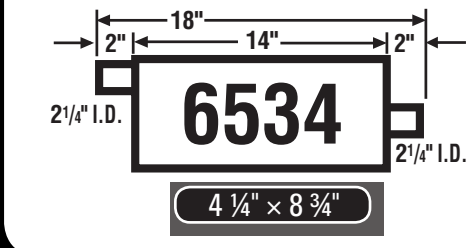
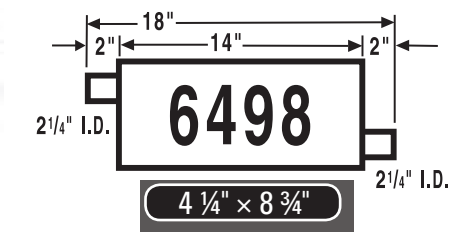
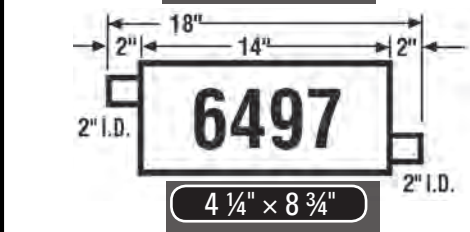
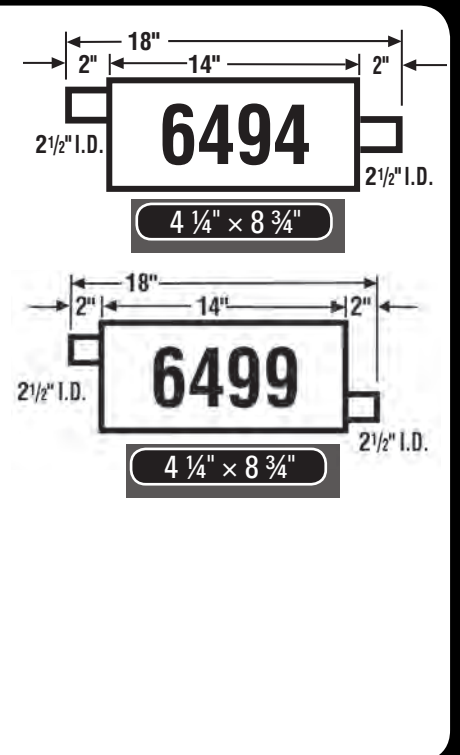
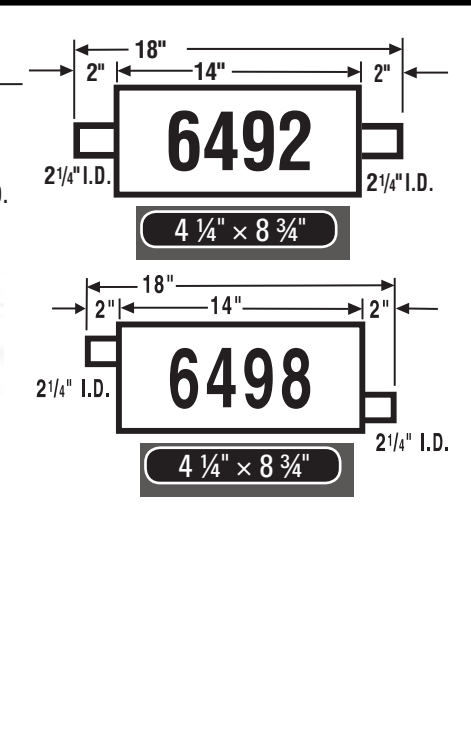
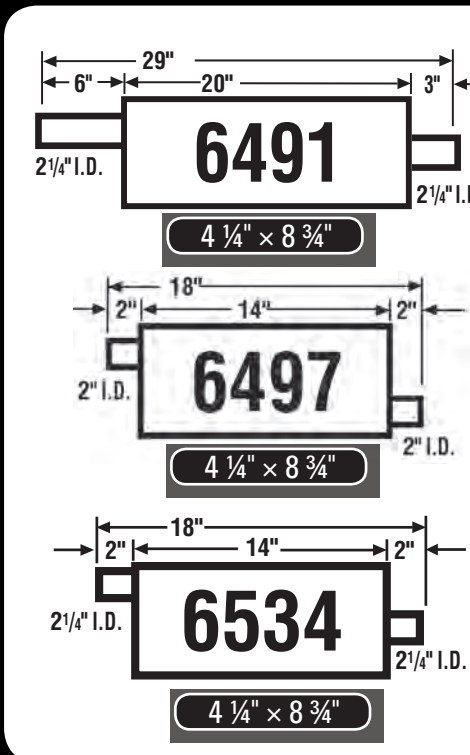

# HEAVY DUTY TRUCK MUFFLERS

UNIVERSAL ALL WELDED ALUMINIZED HEAVY DUTY TRUCK MUFFLERS

100% Aluminized  
All Welded Construction  
Light Truck & Medium Duty  
Truck Applications

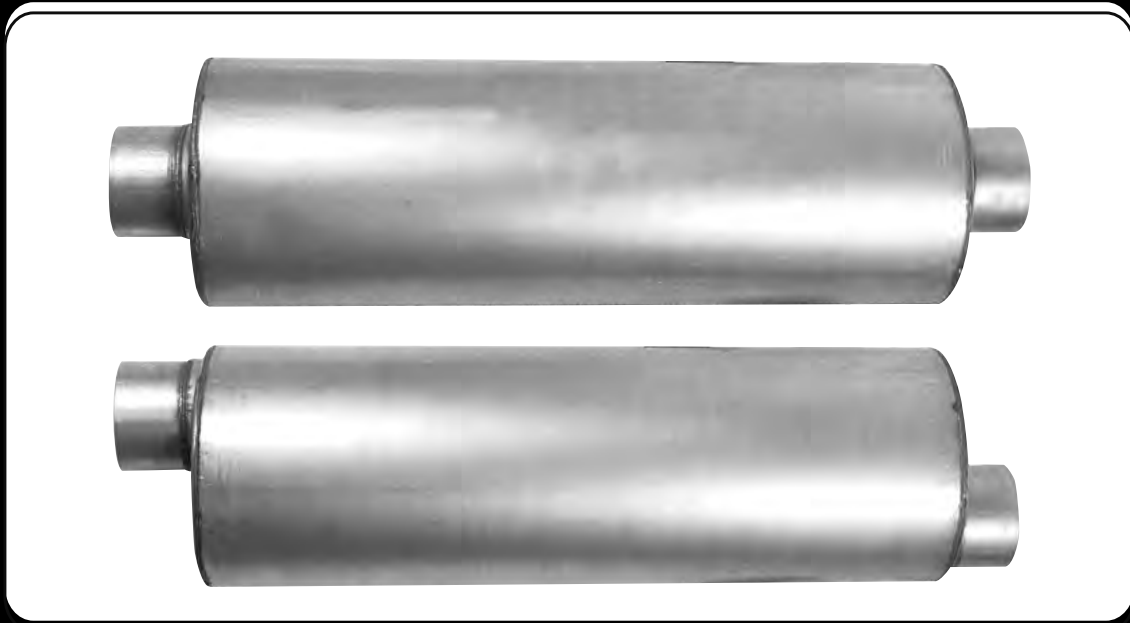

Part Number	Diameter	Body Length	Overall length	Inlet/Outlet	Neck Diameter
4268	7" Round	26"	32"	Center/Center	2 1/2"
4269	7" Round	26"	32"	Center/Center	3"
4270	7" Round	26"	32"	Center/Center	3 1/2"
4271	7" Round	26"	32"	Center/Center	2 1/4"
4272	7" Round	26"	32"	Offset/Offset	2 1/2"
4273	7" Round	26"	32"	Offset/Offset	3"
4274	7" Round	26"	32"	Offset/Offset	3 1/2"
SD726-4B	7" Round	26.5"	33"	Offset/Offset	2 1/2"
SD726-6B	7" Round	26.5"	33"	Offset/Offset	3"
SD726-8D	7" Round	26.5"	33"	Offset/Offset	4"
SD830-6B	8" Round	30"	36"	Offset/Offset	3"
SD8308D	8" Round	30"	36"	Center/Center	4"
*SD726-64P*	7" Round	26.5"	33"	*Offset/Dual*	3" INLET 2 1/2" Dual

Outlet

# SPECIALTY MUFFLERS

## PERFORMANCE MUFFLER



**X503**

**Muffler - Universal Medium  
Duty**

CHEVROLET-C3500, SILVERADO 1500 HD,  
SILVERADO 2500 HD, SILVERADO 3500  
(06-01); GMC-C3500, SIERRA 1500 HD,  
SIERRA 2500 HD, SIERRA 3500 (06-01)



**X504**

**Muffler - Universal Medium  
Duty**

CHEVROLET-C3500, SILVERADO 1500  
HD, SILVERADO 2500 HD, SILVERADO  
3500 (06-01); GMC-C3500, SIERRA 1500  
HD, SIERRA 2500 HD, SIERRA 3500  
(06-02)



**APE2560P**

**1 7/8 D/D 6.5" x 23"  
ROUND  
MERCEDES**



**APE2561P**

**MUFFLER DUAL/DUAL  
OVAL**

# OUTLAW

## RACE MUFFLER



IN / OUT	CASE DIAMETER	CASE LENGTH	PART#
3.50"/3.50"	5.00"	9.00"	13509135



**14020100 DIESEL**  
**Description**  
**Pro Series Muffler**  
**ID/OD: 4.00 / 4.00**  
**BODY LENGTH: 20"**  
**HEIGHT: 9"**  
**WIDTH: 9"**

IN / OUT	CASE DIAMETER	CASE LENGTH	PART#
3.00"	4.00"	11.00"	15430
3.00"	4.00"	7.00"	15430S

409S STAINLESS MODELS			
IN / OUT	CASE DIAMETER	CASE LENGTH	PART#
2.50"	4.50"	11.00"	815425
2.50"	4.50"	7.00"	815425S

# SUPER 10

DELTA FLOW®

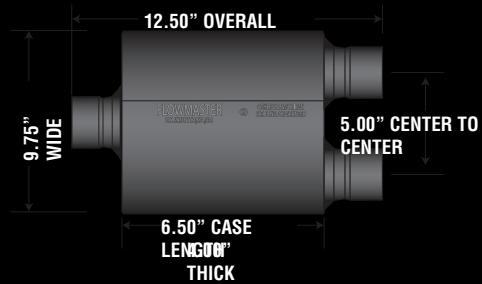

IN / OUT	C / C	O / O	C / D
2.25"	---	--	---
2.50"	842515	842518	---
3.00"	843015	--	--
IN / OUT	C / C	O / O	C / D
2.50" / 2.25"	---	---	8425152
3.00" / 2.50"	---	---	8430152

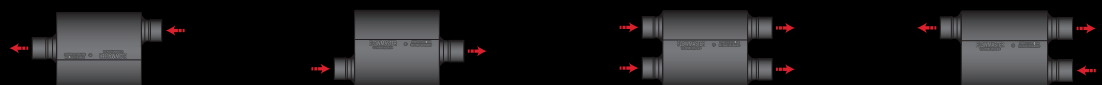

IN / OUT	C / O	O / C	D / D	S / D
2.50"	842512	842516	8425154	8425810
3.00"	--	843016	---	--

# 40 SERIES

## ORIGINAL

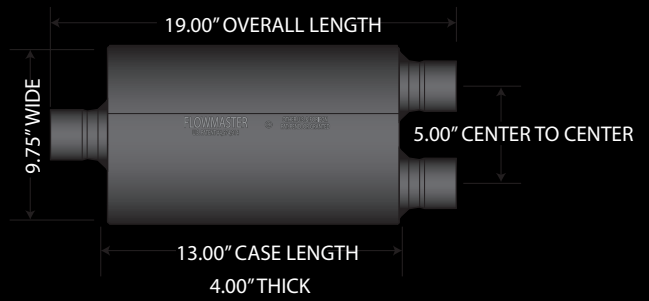

IN / OUT	C / C	O / C	C / O	O / O	O / O SAME SIDE
2.25"	--	42441	42442	42443	--
2.50"	--	42541	42542	42543	--
3.00"	---	43041	--	43043	---
409S STAINLESS STEEL MODELS					
2.25"	---	8042441	--	8042443	--
2.50"	--	8042541	--	8042543	--
3.00"	---	8043041	---	8043043	---

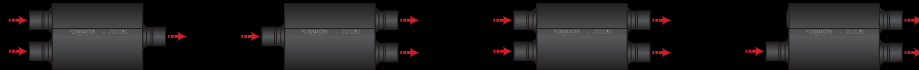

IN / OUT	D / C	C / D	D / D	O / D
2.50" / 2.50"	--	---	425404	--
3.00" / 2.50"	---	430402	--	--
409S STAINLESS STEEL MODELS				
3.00" / 2.50"	---	80430402	--	--

# 40 SERIES

## DELTA FLOW<sup>®</sup>

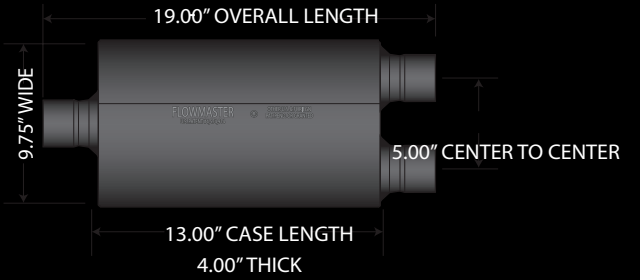

IN / OUT	C / C	O / C	C / O	O / O	O / O SAME SIDE
2.00"	942040	942041	942042	942043	--
2.25"	942440	942441	942442	942443	942444
2.50"	942540	942541	942542	942543	942544
3.00"	943040	943041	943042	943043	--
409S STAINLESS STEEL MODELS					
2.50"	--	842541	--	842543	--
3.00"	--	843041	--	---	---



IN / OUT	D / C	C / D	D / D	O / D
2.25"/2.25"	----	9424422	---	----
2.50"/2.25"	---	9425422	---	9425432
2.50"/2.50"	---	9425400	---	---
3.00"/2.25"	---	9430422	---	----
3.00"/2.25"	----	9430402	----	9430412
409S STAINLESS STEEL MODELS				
3.00"/2.25"	---	---	---	----
3.00"/2.25"	---	8430402	---	----



# 50 SERIES

TM

BIG BLOCK

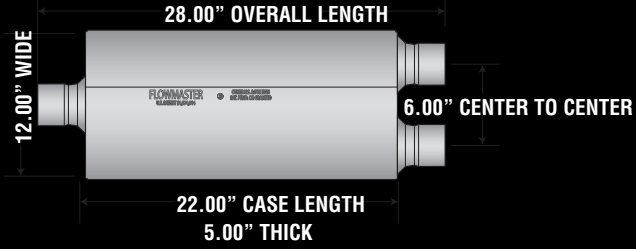

IN / OUT	C / C	O / C	C / O	O / O	O / O SAME SIDE
3.50"	--	---	---	53553	---
IN / OUT	D / O	C / D	D / D	O / D	
2.75" / 2.50"	--	---	527504	--	
3.00" / 2.50"	---	---	530504	---	
3.00" / 3.50"	530513*	--	---	----	

# SUPER 44

DELTA FLOW

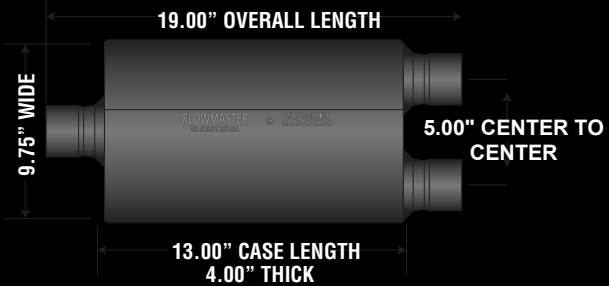

IN / OUT	C / C	O / C	C / O	O / O	O / O SAME SIDE
2.25"	942445	942446	942447	942448	942449
2.50"	942545	942546	942547	942548	942549
3.00"	943045	943046	943047	943048	943049
409S STAINLESS STEEL MODELS					
2.25"	---	842446	---	842448	--
2.50"	---	842546	842547	842548	842549
3.00"	---	843046	---	843048	---

IN / OUT	D / C	C / D	D / D	O / D	T / C
2.25" / 2.25"	--	9424472	---	---	----
2.50" / 2.25"	--	9425452	---	---	----
2.50" / 2.50"	--	9425472	---	---	---
3.00" / 2.25"	---	9430472	---	---	---
3.00" / 2.50"	--	9430452	--	9430462	---
409S STAINLESS STEEL MODELS					
2.50" / 3.00"	8425453	---	---	---	---
3.00" / 2.50"	--	8430452	---	---	---
2.50" / 2.50"	--	----	8425454	---	8425461



## 3.5"x7" OVAL BODY MUFFLERS

11" OFFSET/OFFSET

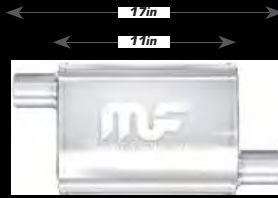

IN/OUT	STAINLESS
2"/2.25"	11132

14" SINGLE/DUAL

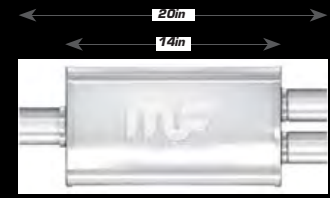

IN/OUT	STAINLESS
2.25"/2" Dual	11148

## 4"x9" OVAL BODY MUFFLERS

11" CENTER/OFFSET



IN/OUT	STAINLESS
2.25"	11365
2.5"	11366

18" CENTER/OFFSET

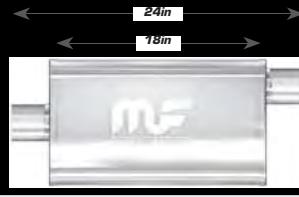

IN/OUT	STAINLESS
2.25"	11255
2.5"	11256
3"	11259

14" CENTER/OFFSET

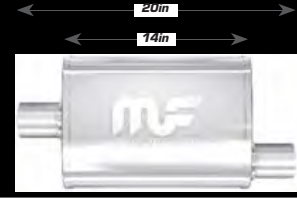

IN/OUT	STAINLESS
2"	11224
2.25"	11225
2.5"	11226
3"	11229

14" OFFSET/OFFSET

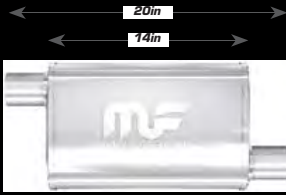

IN/OUT	STAINLESS
2"	11234
2.25"	11235
2.5"	11236

14" CENTER/CENTER



IN/OUT	STAINLESS
2"	11214
2.25"	11215
2.5"	11216
3"	11219

14" DUAL/DUAL

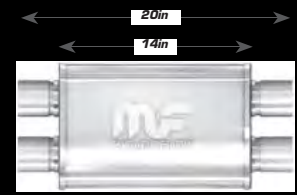

IN/OUT	STAINLESS
2.25"	11385*
2.5"	11386*

\*Tru-X Perforated Core

## 5"x8" OVAL BODY MUFFLERS

14" SINGLE/DUAL



IN/OUT	STAINLESS
2.25"/2" Dual	12148
2.25"/2.25" Dual	12138
2.5"/2.5" Dual	12158
3"/2.5" Dual	12198

14" CENTER/OFFSET



IN/OUT	STAINLESS
2.25"	12225
2.5"	12226
3"	12229

## 5"x11" OVAL BODY MUFFLERS

22" SINGLE/DUAL



IN/OUT	STAINLESS
3"/2.5" Dual	12588
3"/3" Dual	12590

22" DUAL/DUAL



IN/OUT	STAINLESS
2.5"	12568*
3"/2.5"	12569*

22" CENTER/OFFSET



IN/OUT	STAINLESS
3"	12589

## 4" ROUND BODY MUFFLERS

14" CENTER/CENTER



IN/OUT	CORE	STAINLESS
2"	2.5"	10414
2.25"	2.5"	10415
2.5"	2.5"	10416

18" CENTER/CENTER



IN/OUT	STAINLESS
2.25"	10425
2.5"	10426

22" CENTER/CENTER

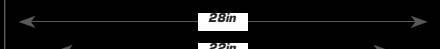

IN/OUT	STAINLESS
2.25"	10435
2.5"	10436

## 4" ROUND BODY RACE MUFFLERS

4" CENTER/ CENTER



IN/OUT	LENGTH	OVERALL	POLISH-SS
2.5"	6"	12"	14156



## CRATE MUFFLERS



PART #	Motor Application(s)	Sound Level	Inlet/Outlet	Configuration		Case Size	Overall Length
			INSIDE DIAMETER	INLET	OUTLET	(L x W x H)	
400823	CrateMuffler® STOCK SBC 283/ 327/ 350	ATAK®	2.5"	Offset	Offset	14" X 4.35" X 9.0"	19"
400829	CrateMuffler® Stock SBF 289/ 302/ 351 FE Big Block	ATAK®	2.5"	Offset	Offset	14" X 4.35" X 9.0"	19"
400943	CrateMuffler® Big Block Mopar 383/ 413/ 426/ 440	ATAK®	2.5"	Offset	Offset	14" X 4.35" X 9.0"	19"
400825	CrateMuffler® STOCK SBC 283/ 327/ 350	S-Type	2.5"	Offset	Center	14" X 4.35" X 9.0"	19"
400844	CrateMuffler® SBC High Output 350/ 383	ATAK®	3"	Offset	Center	14" X 4.35" X 9.0"	19"
400852	CrateMuffler® BBC 396/402/427	ATAK®	2.5"	Offset	Center	14" X 4.35" X 9.0"	19"
400941	CrateMuffler® Big Block Mopar - 383/ 413/ 440	ATAK®	2.5"	Offset	Center	14" X 4.35" X 9.0"	19"
400945	CrateMuffler® LS3	ATAK®	2.5"	Offset	Center	14" X 4.35" X 9"	19"



## PRO XS MUFFLER



Part#	Product Type	Inlet/Outlet	Shape	Tubing Size	Case Size	Overall Length
		Configuration				
40344	Muffler	Center/Offset	Oval	2"	14" x 4" x 9.5"	19"
40357	Muffler	Center/Offset	Oval	2.25"	14" x 4" x 9.5"	19"
40358	Muffler	Center/Offset	Oval	2.5"	14" x 4" x 9.5"	19"
40359	Muffler	Center/Offset	Oval	3"	14" x 4" x 9.5"	19"
400481	Muffler	Center/Offset	Oval	2.5"	14" x 4.25" x 7.88"	19"
40664	Muffler	Center/Offset	Oval	2.25"	19" x 4" x 9.5"	24"
40665	Muffler	Center/Offset	Oval	2.5"	19" x 4" x 9.5"	24"
40842S	Muffler	Center/Center	Round	2.5"	10" x 5" diameter round	15"
40941	Muffler	Center/Center	Oval	2.5"	12" x 4.5" x 7.88"	17"
40943	Muffler	Center/Center	Oval	3"	12" x 4.5 x 7.88"	17"
40347	Muffler	Center/Center	Oval	2"	14" x 4" x 9.5"	19"
40363	Muffler	Center/Center	Oval	2.25"	14" x 4" x 9.5"	19"
40364	Muffler	Center/Center	Oval	2.5"	14" x 4" x 9.5"	19"
40085	Muffler	Center/Center	Round	3"	15" x 5"	20"
40352	Muffler	Offset/Offset	Oval	2.5"	14" x 4" x 9.5"	19"
40348	Muffler	Center/Dual	Oval	2.5" Inlet/ Dual 2.5" Outlet	19" x 4" x 9.5"	24"
40349	Muffler	Center/Dual	Oval	3" Inlet/ Dual 2.5" Outlet	19" x 4" x 9.5"	24"
40670	Muffler	Center/Dual	Oval	3" Inlet/ Dual 2.25" Outlet	19" x 4" x 9.5"	24"
400286	Muffler	Dual/Dual	Oval	2.5"	19" x 4" x 9.5"	24"
400286	Muffler	Dual/Dual	Oval	2.5"	19" x 4" x 9.5"	24"



ULTRAFLO		
17217	OFFSET/CENTER	2.25"
17226	OFFSET/OFFSET	2.25"
17230	CENTER/CENTER	2.50"
ULTRA TURBO		
17674	CENTER/OFFSET	3"
	SINGLE IN/DUAL OUT	
SUPER TURBO		
17730	OFFSET/CENTER	2"
17731	OFFSET/CENTER	2.25"
17733	OFFSET/CENTER	2.50"
17744	OFFSET/CENTER	3"
17769	OFFSET/CENTER	3"
17747	CENTER/OFFSET	2.25"
17748	CENTER/OFFSET	2.50"
17749	OFFSET/OFFSET	2.50"
17732	OFFSET/OFFSET	2.25"
17734	OFFSET/OFFSET	2.50"
17741	OFFSET/OFFSET	2.25 "

### RACE SERIES BULLET



	ID/OD	TOTAL LENGTH
24250	2.50"	9"
24215	2.50"	16.5"
24222	3"	16.5"
24219	3"	23.25"

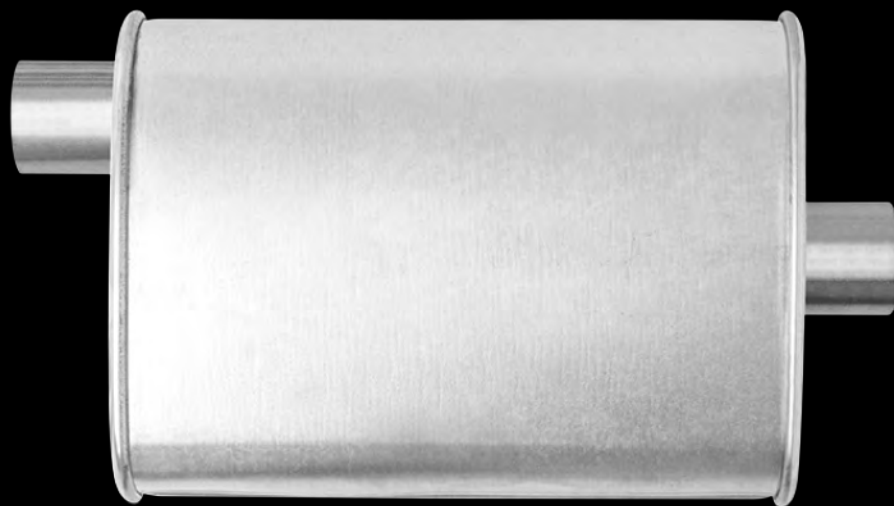

### TURBO MUFFLERS

	CONFIGURATION	OVERALL	BODY LENGTH	WIDTH	INLET/OUTLET
17704	OFFSET/CENTER	18.5"	14"	7.75"	2"
17711	OFFSET/CENTER	18.5"	14"	9.75"	2"
17713	OFFSET/CENTER	18.5"	14"	9.75"	2.25"
17717	OFFSET/CENTER	25"	20"	9.75"	2.25"
17712	OFFSET/OFFSET	18.5"	14"	9.75"	2"
17714	OFFSET/OFFSET	18.5"	14"	9.75"	2.25"



	OVERALL LENGTH	BODY LENGTH	WIDTH	INLET/OUTLET
24210	17"	12"	3"	1.75"
24201	25"	20"	3.5"	2.25"



## JONES FLOW PACK, TURBO & TURBINE MUFFLERS

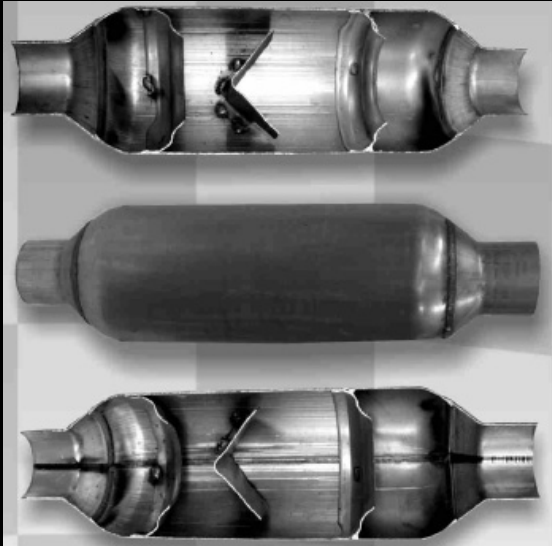

	INLET/OUTLET	OVERALL LENGTH
JFP225	2.25"	19.5"
JFP250	2.50"	19.5"
JFP300	3"	19.5"

## JONES FLOW PACK, TURBINE AND TURBO MUFFLERS, JONES RESONATORS



	INLET/OUTLET	BODY	OVERALL LENGTH
JR24	2.25"	10"	14"
JR24	2.50"	10"	14"
JR30	3" , 6" ROUND	10	14"



# KO MUFFLERS

## 40 SERIES



PART #	DESCRIPTION	DIMENSIONS	EQUIVALENT TO PART #
KO42441	O/C 2.25"	5x10x21	42441
KO42541	O/C 2.50"	5x10x21	42541
KO43041	O/C 3"	5x10x21	43041
KO42443	O/O 2.25"	5x10x21	42443
KO42543	O/O 2.50"	5x10x21	42543
KO43043	O/O 3"	5x10x21	43043
KO430402	C/DUAL 3"/2.50"	5x10x21	430402

## 10 SERIES



PART #	DESCRIPTION	DIMENSIONS	EQUIVALENT TO PART #
KO425410	C/C 2.50"	4.50x10x20.5	842515
KO43010	C/C 3"	4.50x10x20.5	843015
KO42513	O/O 2.50"	4.50x10x20.5	842518
KO425102	C/DUAL 2.50"/2.25"	4.50x10x20.5	8425152
KO430102	C/DUAL 3"/2.50"	4.50x10x20.5	8430152

WE NOW ARE DISTRIBUTORS OF HEDMAN HEDDERS  
AND K&N.

CALL FOR PRICING, AVAILABILITY ON ANY PRODUCT  
FROM THEIR CATALOG.



## RESONATORS



	LENGTH	OVERALL LENGTH	I.D./O.D.	BODY WIDTH/HEIGHT
RSN-243519	15"	19"	2.25"/2.25"	3.5"
RSN-254009	8.50"	11.5"	2.50"/2.50"	4"
RSN-254016	12"	16"	2.50"/2.50"	4"
RSN-254019	15"	19"	2.50"/2.50"	4"
RSN-304009	8.50"	11.50"	3"/3"	4"
RSN-304016	12"	16"	3"/3"	4"
RSN-304019	15"	19"	3"/3"	4"

# FLOWSOUND PERFORMANCE MUFFLERS

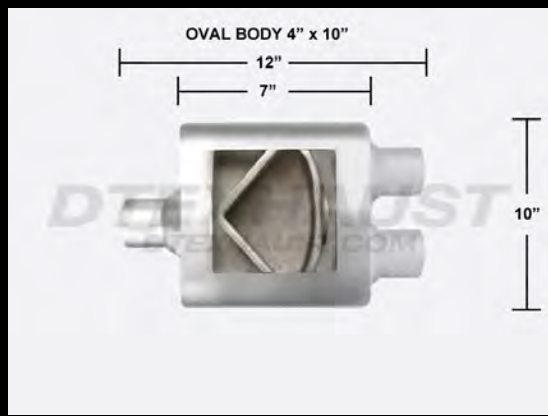
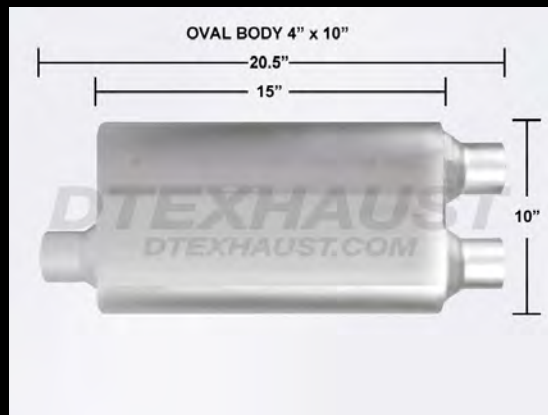

Part #	ID	OD	Configuration	Body Height	Body Width	Body Length	Total Length
72426	2.25"	2.25"	Center / Center	4.00"	10.00"	7.00"	12.00"
72526	2.50"	2.50"	Center / Center	4.00"	10.00"	7.00"	12.00"
73026	3.00"	3.00"	Center / Center	4.00"	10.00"	7.00"	12.00"
73526	3.50"	3.50"	Center / Center	4.00"	10.00"	7.00"	12.00"
72441	2.25"	2.25"	Offset / Center	4.00"	10.00"	7.00"	12.00"
72541	2.50"	2.50"	Offset / Center	4.00"	10.00"	7.00"	12.00"
73041	3.00"	3.00"	Offset / Center	4.00"	10.00"	7.00"	12.00"
73541	3.50"	3.50"	Offset / Center	4.00"	10.00"	7.00"	12.00"
72443	2.25"	2.25"	Offset / Offset	4.00"	10.00"	7.00"	12.00"
72543	2.50"	2.50"	Offset / Offset	4.00"	10.00"	7.00"	12.00"
73043	3.00"	3.00"	Offset / Offset	4.00"	10.00"	7.00"	12.00"
7C24D24	2.25"	2.25"	Center / Dual	4.00"	10.00"	7.00"	12.00"
725422	2.50"	2.25"	Center / Dual	4.00"	10.00"	7.00"	12.00"
725400	2.50"	2.50"	Center / Dual	4.00"	10.00"	7.00"	12.00"
730402	3.00"	2.50"	Center / Dual	4.00"	10.00"	7.00"	12.00"
730422	3.00"	2.25"	Center / Dual	4.00"	10.00"	7.00"	12.00"
72481	2.25"	2.25"	Dual / Dual	4.00"	10.00"	7.00"	12.00"
72581	2.50"	2.50"	Dual / Dual	4.00"	10.00"	7.00"	12.00"
82426	2.25"	2.25"	Center / Center	4.00"	10.00"	13.00"	19.00"
82526	2.50"	2.50"	Center / Center	4.00"	10.00"	13.00"	19.00"
83026	3.00"	3.00"	Center / Center	4.00"	10.00"	13.00"	19.00"
82041	2.00"	2.00"	Offset / Center	4.00"	10.00"	13.00"	19.00"
82441	2.25"	2.25"	Offset / Center	4.00"	10.00"	13.00"	19.00"
82541	2.50"	2.50"	Offset / Center	4.00"	10.00"	13.00"	19.00"
83041	3.00"	3.00"	Offset / Center	4.00"	10.00"	13.00"	19.00"
82042	2.00"	2.00"	Center / Offset	4.00"	10.00"	13.00"	19.00"
82542	2.50"	2.50"	Center / Offset	4.00"	10.00"	13.00"	19.00"
83042	3.00"	3.00"	Center / Offset	4.00"	10.00"	13.00"	19.00"
82043	2.00"	2.00"	Offset / Offset	4.00"	10.00"	13.00"	19.00"
82443	2.25"	2.25"	Offset / Offset	4.00"	10.00"	13.00"	19.00"
82543	2.50"	2.50"	Offset / Offset	4.00"	10.00"	13.00"	19.00"
83043	3.00"	3.00"	Offset / Offset	4.00"	10.00"	13.00"	19.00"
8C24D24	2.25"	2.25"	Center / Dual	4.00"	10.00"	13.00"	19.00"
825422	2.50"	2.25"	Center / Dual	4.00"	10.00"	13.00"	19.00"
830402	3.00"	2.50"	Center / Dual	4.00"	10.00"	13.00"	19.00"
830422	3.00"	2.25"	Center / Dual	4.00"	10.00"	13.00"	19.00"
830412	3.00"	2.50"	Offset / Dual	4.00"	10.00"	13.00"	19.00"
825CMRC	2.50"	2.50"	CAMARO	4.00"	10.00"	15.00"	20.50"
8D24D24	2.25"	2.25"	Dual / Dual	4.00"	10.00"	17.00"	23.00"
8D25D25	2.50"	2.50"	Dual / Dual	4.00"	10.00"	17.00"	23.00"
842453	2.25"	2.25"	Offset / Offset	4.00"	10.00"	17.00"	23.00"
842451	2.25"	2.25"	Offset / Center	4.00"	10.00"	17.00"	23.00"
842551	2.50"	2.50"	Offset / Center	4.00"	10.00"	17.00"	23.00"
843051	3.00"	3.00"	Offset / Center	4.00"	10.00"	17.00"	23.00"
843052	3.00"	3.00"	Center / Offset	4.00"	10.00"	17.00"	23.00"
8430522	3.00"	2.25"	Center / Dual	4.00"	10.00"	17.00"	23.00"
8430502	3.00"	2.50"	Center / Dual	4.00"	10.00"	17.00"	23.00"
8424553	2.25"	3.00"	Dual / Center	4.00"	10.00"	17.00"	23.00"

# BLUE FLAME EXHAUST TIPS



**DT-24017BF**  
3.5" DOUBLE WALL ANGLE W/ BLUE FLAME

**INLET DIAMETER:** 2.25"  
**OUTLET DIAMETER:** 3.50"  
**OVERALL LENGTH:** 7.00"  
**UNITS PER BOX:** 10



**DT-244017BF, DT-254017BF**  
4" DOUBLE WALL ANGLE W/ BLUE FLAME

**INLET DIAMETER:** 2.25" / 2.50"  
**OUTLET DIAMETER:** 4.00"  
**OVERALL LENGTH:** 7.00"  
**UNITS PER BOX:** 10



**DT-24156BF**  
DUAL 3.5" DOUBLE WALL ROLLED SLANT W/ BLUE FLAME

**INLET DIAMETER:** 2.25"  
**OUTLET DIAMETER:** 3.50" **BODY WIDTH:** 7.25"  
**OVERALL LENGTH:** 9.50"  
**UNITS PER BOX:** 5



**DT-24156LBF, DT-24156RBF DUAL**  
3.5" DOUBLE WALL STAGGERED ROLLED SLANT W/ BLUE FLAME

**INLET DIAMETER:** 2.25"  
**OUTLET DIAMETER:** 3.50" **BODY WIDTH:** 7.25"  
**OVERALL LENGTH:** 9.50"  
**UNITS PER BOX:** 5

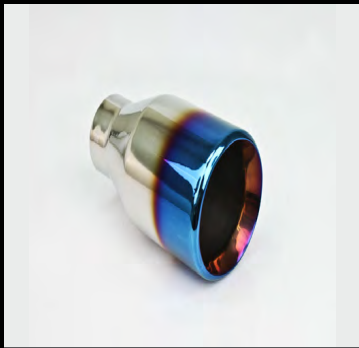

**DT-24158BF**  
4" DOUBLE WALL STRAIGHT W/ BLUE FLAME

**INLET DIAMETER:** 2.25"  
**OUTLET DIAMETER:** 4.00"  
**OVERALL LENGTH:** 7.00"  
**UNITS PER BOX:** 10



**DT-24159BF**  
3.5" DOUBLE WALL STRAIGHT W/ BLUE FLAME

**INLET DIAMETER:** 2.25"  
**OUTLET DIAMETER:** 3.50"  
**OVERALL LENGTH:** 7.25"  
**UNITS PER BOX:** 10



**DT-24160BF**  
REVERSIBLE 3" DUAL ROUND ROLLED EDGE W/ BLUE FLAME

**INLET DIAMETER:** 2.25"  
**OUTLET DIAMETER:** 3.00" **BODY WIDTH:** 6.25"  
**OVERALL LENGTH:** 9.00"  
**UNITS PER BOX:** 5



**DT-24161BF**  
DUAL 3.5" DOUBLE WALL ROLLED SLANT W/ BLUE FLAME

**INLET DIAMETER:** 2.25"  
**OUTLET DIAMETER:** 3.50" **BODY WIDTH:** 7.25"  
**OVERALL LENGTH:** 9.75"  
**UNITS PER BOX:** 5



**DT-24161LBF, DT-24161RBF DUAL**  
3.5" DOUBLE WALL STAGGERED ROLLED SLANT W/ BLUE FLAME

**INLET DIAMETER:** 2.25"  
**OUTLET DIAMETER:** 3.50" **BODY WIDTH:** 7.25"  
**OVERALL LENGTH:** 9.75"  
**UNITS PER BOX:** 5



**DT-24162LBF, DT-24162RBF DUAL**  
3" DOUBLE WALL STAGGERED ANGLE W/ BLUE FLAME

**INLET DIAMETER:** 2.25"  
**OUTLET DIAMETER:** 3.00" **BODY WIDTH:** 6.25"  
**OVERALL LENGTH:** 9.25"  
**UNITS PER BOX:** 5



**DT-24163LBF, DT-24163RBF DUAL**  
3" SINGLE WALL STAGGERED ANGLE W/ BLUE FLAME

**INLET DIAMETER:** 2.25"  
**OUTLET DIAMETER:** 3.00" **BODY WIDTH:** 6.25"  
**OVERALL LENGTH:** 9.25"  
**UNITS PER BOX:** 5



**DT-24164BF**  
3.5" DOUBLE WALL STRAIGHT W/ BLUE FLAME

**INLET DIAMETER:** 2.25"  
**OUTLET DIAMETER:** 3.50"  
**OVERALL LENGTH:** 7.75"  
**UNITS PER BOX:** 10

# BLACK POWDER COATED



**Q9-254090RBK**  
 BLACK POWDER COATED  
 4" ROLLED SLANT

**INLET DIAMETER:** 2.50"  
**OUTLET DIAMETER:** 4.00"  
**OVERALL LENGTH:** 9.00"  
**UNITS PER BOX:** 10



**DT-24013BDLBK, DT-25013BDLBK**  
 BLACK POWDER COATED  
 DUAL 3.5" DOUBLE WALL ANGLE

**INLET DIAMETER:** 2.25" / 2.50"  
**OUTLET DIAMETER:** 3.50" **BODY WIDTH:** 7.75"  
**OVERALL LENGTH:** 9.50"  
**UNITS PER BOX:** 10



**DT-24017ACBK** BLACK  
 POWDER COATED 3.5"  
 DOUBLE WALL ANGLE

**INLET DIAMETER:** 2.25"  
**OUTLET DIAMETER:** 3.50"  
**OVERALL LENGTH:** 7.00"  
**UNITS PER BOX:** 10



**DT-027CBK**  
 BLACK POWDER COATED  
 SQUARE CAMARO TIP

**INLET DIAMETER:** 2.25"  
**OUTLET DIAMETER:** 6.00" x 2.00"  
**OVERALL LENGTH:** 10.00"  
**UNITS PER BOX:** 10



**DT-027SBK**  
 BLACK POWDER COATED  
 SQUARE CAMARO TIP

**INLET DIAMETER:** 2.25"  
**OUTLET DIAMETER:** 8.00" x 2.25"  
**OVERALL LENGTH:** 10.00"  
**UNITS PER BOX:** 10



**DT-30028DSBK**  
 BLACK POWDER COATED  
 3.5" DUAL DOUBLE WALL SIDWAYS TIP

**INLET DIAMETER:** 3.00"  
**OUTLET DIAMETER:** 3.50" **BODY WIDTH:** 7.25"  
**OVERALL LENGTH:** 13.50"  
**UNITS PER BOX:** 10



**DT-25038DWBK, DT-30038DWBK**  
 BLACK POWDER COATED  
 4" DOUBLE WALL ANGLE

**INLET DIAMETER:** 2.50" / 3.00"  
**OUTLET DIAMETER:** 4.00"  
**OVERALL LENGTH:** 12.00"  
**UNITS PER BOX:** 10



**DT-043SBK**  
 BLACK POWDER COATED  
 6" ROLLED ANGLE

**INLET DIAMETER:** 2.25"  
**OUTLET DIAMETER:** 6.00" x 3.25"  
**OVERALL LENGTH:** 9.00"  
**UNITS PER BOX:** 10



**DT-305052-12BK**  
 BLACK POWDER COATED  
 5" DOUBLE LAYER SLANTED ROLLED

**INLET DIAMETER:** 3.00"  
**OUTLET DIAMETER:** 5.00"  
**OVERALL LENGTH:** 12.00"  
**UNITS PER BOX:** 10



**DT-25083LBK, DT-25083RBK** BLACK  
 POWDER COATED  
 3" DUAL DOUBLE WALL STAGGERED ANGLE

**INLET DIAMETER:** 2.50"  
**OUTLET DIAMETER:** 3.00" **BODY WIDTH:** 6.25"  
**OVERALL LENGTH:** 9.50"  
**UNITS PER BOX:** 10



**DT-24113ABK**  
 BLACK POWDER COATED  
 3" DOUBLE WALL ANGLE

**INLET DIAMETER:** 2.25"  
**OUTLET DIAMETER:** 3.00"  
**OVERALL LENGTH:** 8.00"  
**UNITS PER BOX:** 10



**DT-24113BBK**  
 BLACK POWDER COATED  
 3.5" DOUBLE WALL ANGLE

**INLET DIAMETER:** 2.25"  
**OUTLET DIAMETER:** 3.50"  
**OVERALL LENGTH:** 8.00"  
**UNITS PER BOX:** 10



**DT-24113CBK**  
 BLACK POWDER COATED  
 4" DOUBLE WALL ANGLE

**INLET DIAMETER:** 2.25"  
**OUTLET DIAMETER:** 4.00"  
**OVERALL LENGTH:** 8.00"  
**UNITS PER BOX:** 10



**DT-30124BK**  
 BLACK POWDER COATED  
 4" DUAL DOUBLE WALL SIDWAYS TIP

**INLET DIAMETER:** 3.00"  
**OUTLET DIAMETER:** 4.00" **BODY WIDTH:** 9.00"  
**OVERALL LENGTH:** 16.00"  
**UNITS PER BOX:** 10



**DT-24147BK**  
 BLACK POWDER COATED  
 4" RESONATED ROLLED SLANT

**INLET DIAMETER:** 2.25"  
**OUTLET DIAMETER:** 4.00"  
**OVERALL LENGTH:** 9.00"  
**UNITS PER BOX:** 10



**DT-25152BK**  
 BLACK POWDER COATED  
 DUAL SINGLE WALL SQUARE

**INLET DIAMETER:** 2.50"  
**OUTLET DIAMETER:** 8.25" x 2.25"  
**OVERALL LENGTH:** 8.25"  
**UNITS PER BOX:** 5



**DT-24156LBK, DT-24156RBK**  
**DT-25156LBK, DT-25156RBK**  
 BLACK POWDER COATED DUAL 3.5"  
 DOUBLE WALL STAGGERED ROLLED SLANT

**INLET DIAMETER:** 2.25" / 2.50"  
**OUTLET DIAMETER:** 3.50" **BODY WIDTH:** 7.25"  
**OVERALL LENGTH:** 9.50"  
**UNITS PER BOX:** 5



**DT-24161LBK, DT-24161RBK**  
**DT-25161LBK, DT-25161RBK**  
 BLACK POWDER COATED DUAL 3.5"  
 DOUBLE WALL STAGGERED ROLLED SLANT

**INLET DIAMETER:** 2.25" / 2.50"  
**OUTLET DIAMETER:** 3.50" **BODY WIDTH:** 7.25"  
**OVERALL LENGTH:** 9.75"  
**UNITS PER BOX:** 5



**DT-24162LBK, DT-24162RBK**  
**DT-25162LBK, DT-25162RBK**  
 BLACK POWDER COATED DUAL 3"  
 DOUBLE WALL STAGGERED ANGLE

**INLET DIAMETER:** 2.25" / 2.50"  
**OUTLET DIAMETER:** 3.00" **BODY WIDTH:** 6.25"  
**OVERALL LENGTH:** 9.25"  
**UNITS PER BOX:** 5



**DT-243512DSBK, DT-253512DSBK**  
 BLACK POWDER COATED  
 3.5" DUAL SINGLE WALL SIDWAYS TIP

**INLET DIAMETER:** 2.25" / 2.50"  
**OUTLET DIAMETER:** 3.50" **BODY WIDTH:** 7.50"  
**OVERALL LENGTH:** 18.00"  
**UNITS PER BOX:** 5

# BLACK POWDER COATED



DT-243512ABK, DT-243518ABK  
BLACK POWDER COATED 3.5" ANGLE

**INLET DIAMETER:** 2.25"  
**OUTLET DIAMETER:** 3.50"  
**OVERALL LENGTH:** 12" / 18"  
**UNITS PER BOX:** 10



DT-244012ABK, DT-244018ABK  
BLACK POWDER COATED 4" ANGLE

**INLET DIAMETER:** 2.25"  
**OUTLET DIAMETER:** 4.00"  
**OVERALL LENGTH:** 12" / 18"  
**UNITS PER BOX:** 10



DT-243512RBK, DT-243518RBK  
BLACK POWDER COATED 3.5" ROLLED SLANT

**INLET DIAMETER:** 2.25"  
**OUTLET DIAMETER:** 3.50"  
**OVERALL LENGTH:** 12" / 18"  
**UNITS PER BOX:** 10



DT-244012RBK, DT-244018RBK  
BLACK POWDER COATED 4" ROLLED SLANT

**INLET DIAMETER:** 2.25"  
**OUTLET DIAMETER:** 4.00"  
**OVERALL LENGTH:** 12" / 18"  
**UNITS PER BOX:** 10



BQ9-404018TD  
BLACK POWDER COATED  
4" BOLT-ON TURNDOWN TIP

**INLET DIAMETER:** 4.00"  
**OUTLET DIAMETER:** 4.00"  
**OVERALL LENGTH:** 18.00"  
**UNITS PER BOX:** 10



BQ9-405016TD, BQ9-505016TD  
BLACK POWDER COATED  
5" BOLT-ON TURNDOWN TIP

**INLET DIAMETER:** 4.00" / 5.00"  
**OUTLET DIAMETER:** 4.00"  
**OVERALL LENGTH:** 16.00"  
**UNITS PER BOX:** 10



BQ9-405012RBG, Q9-405012RBG  
GLOSSY BLACK POWDER COATED  
5" BOLT-ON OR WELD ON ROLLED SLANT

**INLET DIAMETER:** 4.00"  
**OUTLET DIAMETER:** 5.00"  
**OVERALL LENGTH:** 12.00"  
**UNITS PER BOX:** 10



BQ9-405015RBG, BQ9-405018RBG  
GLOSSY BLACK POWDER COATED  
5" BOLT-ON ROLLED SLANT

**INLET DIAMETER:** 4.00"  
**OUTLET DIAMETER:** 5.00"  
**OVERALL LENGTH:** 15" / 18"  
**UNITS PER BOX:** 10



BQ9-406015RBG, BQ9-406018RBG  
GLOSSY BLACK POWDER COATED  
6" BOLT-ON ROLLED SLANT

**INLET DIAMETER:** 4.00"  
**OUTLET DIAMETER:** 6.00"  
**OVERALL LENGTH:** 15" / 18"  
**UNITS PER BOX:** 10



BQ9-506015RBG, BQ9-506018RBG  
GLOSSY BLACK POWDER COATED  
6" BOLT-ON ROLLED SLANT

**INLET DIAMETER:** 5.00"  
**OUTLET DIAMETER:** 6.00"  
**OVERALL LENGTH:** 15" / 18"  
**UNITS PER BOX:** 10



BQ9-354512RBK  
BLACK POWDER COATED  
BOLT-ON 4.5" ROLLED SLANT

**INLET DIAMETER:** 3.50"  
**OUTLET DIAMETER:** 4.50"  
**OVERALL LENGTH:** 12.00"  
**UNITS PER BOX:** 10



BQ9-405012RBK, BQ9-405015RBK,  
BQ9-405018RBK  
BLACK POWDER COATED 5" BOLT-ON ROLLED SLANT

**INLET DIAMETER:** 4.00"  
**OUTLET DIAMETER:** 5.00"  
**OVERALL LENGTH:** 12"/15"/18"  
**UNITS PER BOX:** 10



BQ9-406015RBK, BQ9-406018RBK  
BLACK POWDER COATED  
6" BOLT-ON ROLLED SLANT

**INLET DIAMETER:** 4.00"  
**OUTLET DIAMETER:** 6.00"  
**OVERALL LENGTH:** 15" / 18"  
**UNITS PER BOX:** 10



BQ9-506012RBK, BQ9-506015RBK,  
BQ9-506018RBK  
BLACK POWDER COATED 6" BOLT-ON ROLLED SLANT

**INLET DIAMETER:** 5.00"  
**OUTLET DIAMETER:** 6.00"  
**OVERALL LENGTH:** 12"/15"/18"  
**UNITS PER BOX:** 10



BQ9-407015RBK, BQ9-407018RBK  
BLACK POWDER COATED  
7" BOLT-ON ROLLED SLANT

**INLET DIAMETER:** 4.00"  
**OUTLET DIAMETER:** 7.00"  
**OVERALL LENGTH:** 15" / 18"  
**UNITS PER BOX:** 10



BQ9-507015RBK, BQ9-507018RBK  
BLACK POWDER COATED  
7" BOLT-ON ROLLED SLANT

**INLET DIAMETER:** 5.00"  
**OUTLET DIAMETER:** 7.00"  
**OVERALL LENGTH:** 15" / 18"  
**UNITS PER BOX:** 10



BQ9-408015RBK, BQ9-408018RBK  
BLACK POWDER COATED  
8" BOLT-ON ROLLED SLANT

**INLET DIAMETER:** 4.00"  
**OUTLET DIAMETER:** 8.00"  
**OVERALL LENGTH:** 15" / 18"  
**UNITS PER BOX:** 10



BQ9-508015RBK, BQ9-508018RBK  
BLACK POWDER COATED  
8" BOLT-ON ROLLED SLANT

**INLET DIAMETER:** 5.00"  
**OUTLET DIAMETER:** 8.00"  
**OVERALL LENGTH:** 15" / 18"  
**UNITS PER BOX:** 10



Q9-405012RBK, Q9-405015RBK  
BLACK POWDER COATED  
5" ROLLED SLANT

**INLET DIAMETER:** 4.00"  
**OUTLET DIAMETER:** 5.00"  
**OVERALL LENGTH:** 12" / 15"  
**UNITS PER BOX:** 10



Q9-406015RBK, Q9-406018RBK  
BLACK POWDER COATED  
6" ROLLED SLANT

**INLET DIAMETER:** 4.00"  
**OUTLET DIAMETER:** 6.00"  
**OVERALL LENGTH:** 15" / 18"  
**UNITS PER BOX:** 10

# SUPPLIERS



WELDING SUPPLIES

WAREHOUSE INDUSTRIAL



## SUN VALLEY

8077 SAN FERNANDO RD.  
SUN VALLEY, CA 91352

Phone: (818) 683-1777

Fax: (818) 683-1778

### Operating Hours:

Mon.-Fri. 8:00am - 5:00 pm

Sat 8:00am - 12:00 pm

Sun Closed

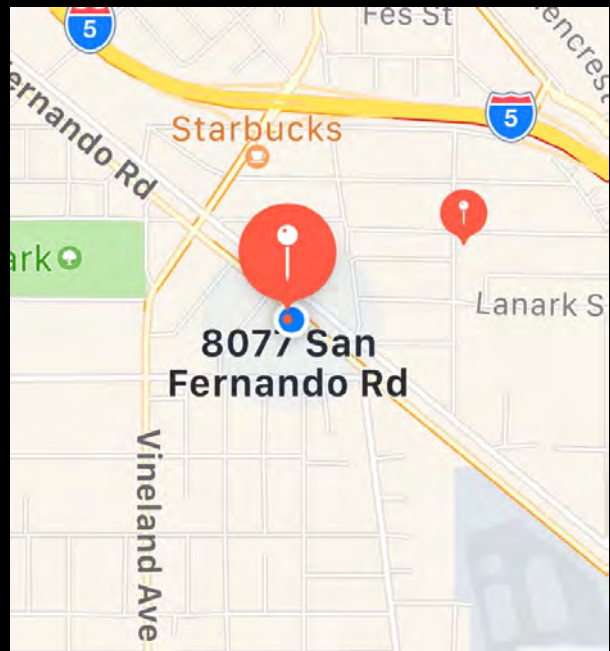

## UPLAND

1700 W. FOOTHILL BLVD  
UPLAND, CA 91786

Phone: (909) 981-5555

Fax: (909) 981-4196

### Operating Hours:

Mon.-Fri. 8:00am - 5:00 pm

Sat 8:00am - 12:00 pm

Sun Closed

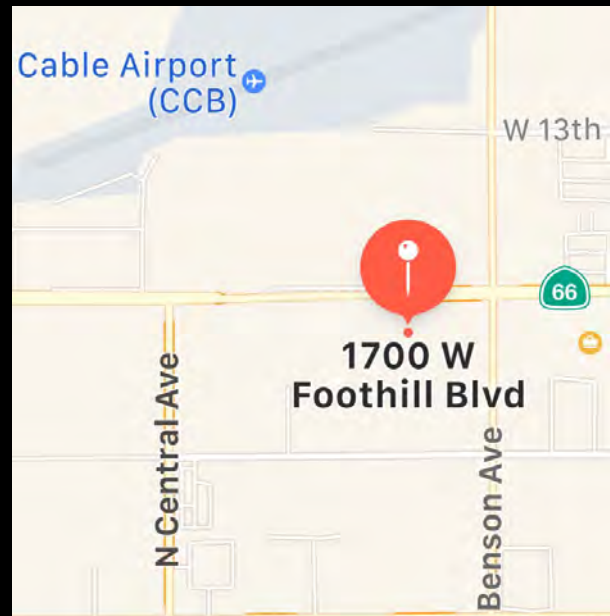

## SANTA ANA

1008 EAST  
CHESTNUT SANTA  
ANA, CA 92701

Phone: (949) 284-8383

Fax: (949) 284-8384

### Operating Hours:

Mon.-Fri. 8:00am - 5:00 pm

Sat 9:00am - 1:00 pm

Sun Closed

