

Ezekiel 4. The master key to unlock the Bible's chronology

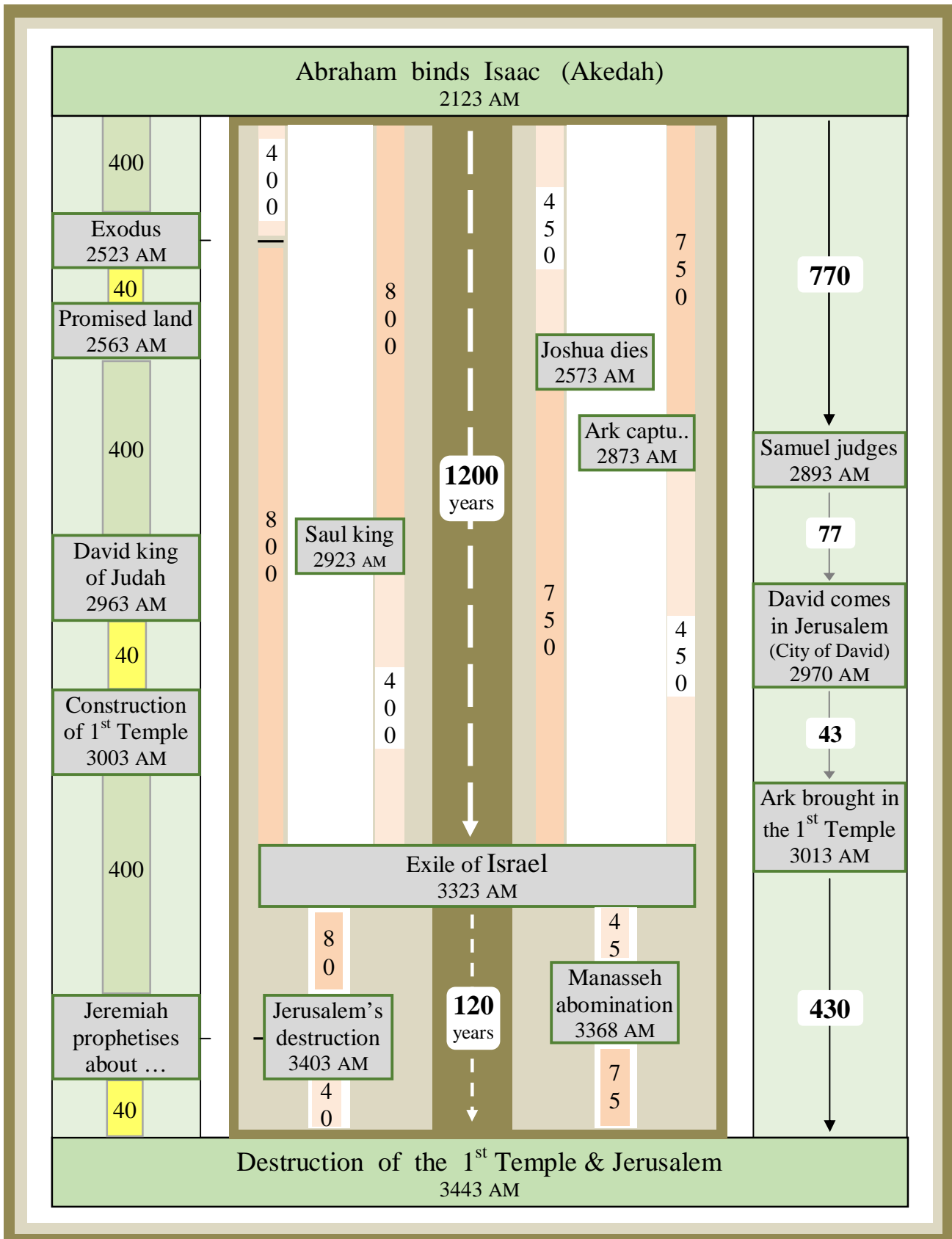

If the only achievement of this book was the discovery of these patterns, I would be satisfied. But there is so much more..

Yves Peloquin



"Make the mind of this people dull, and stop their ears, and shut their eyes, so that they may not look with their eyes, and listen with their ears, and comprehend with their minds, and turn and be healed."

Isaiah 6:10

It is the glory of God to conceal a matter; to search out a matter is the glory of kings.

Prov 25:2 NIV

Dédié à Marie-Paule mon épouse, sans qui je n'aurais jamais pu m'investir avec autant d'énergie dans cette recherche, et à mes trois enfants :

Jeanne, Émile, Évelyne
qui ont si souvent été privés de ma présence.

Also dedicated to my father Léo (1921-1994 AD) from whom I learned the names of Jacob's children. I believe he was one of the great...great grandsons of Leah, first wife of the patriarch Jacob.

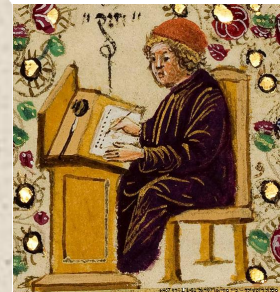

In today's world where well-educated men and women put their faith in unbelieving scholars, the miracles of the Bible are view as tales for children. But what if the timelines of these so called tales would show truly miraculous properties?

"For as the heavens are higher than the earth, So are My ways higher than your ways, And My thoughts than your thoughts.
Isa 55:9 NKJV



The First Part

The house of Judah sin that lasted 40 days (years)	page 13
The house of Israel sin that lasted 390 days (years)	page 17
A siege that last 430 days (390 days + 40 days)	page 27
Why an iron wall	page 35
Left side/Right side	page 39
The feeding of Ezekiel during his siege	page 44
The need to have Ezekiel tied up	page 45
Prophesying against the siege of Jerusalem	page 50
Ezekiel's bare arm	page 58
Ezekiel eating defiled food	page 67
The 430 years and 400 years to Exodus	page 78
Ezekiel shaves his hair	page 89
Ezekiel is weighing and dividing the hair	page 97
Ezekiel's hair started growing again	page 104
Daniel 70-week & post exile chronology	page 112
Ezekiel's fasting	page 133
Ezekiel's famine of words	page 135

Second Part

Setting a true chronology of the Bible	page 141
The timeline of Joseph	page 142
Sabbath and Jubilee	page 146
Yeshua's ministry	page 149
The 2 nd Temple became redundant	page 156
The time of Joshua	page 157
Oppressions and Judges	page 159
Pilgrimage of fathers and sons	page 171
When did Abraham marry	page 173
Did the Israelites wait 19 y. in Kadesh Barnea?	page 169
Understanding Judah & Israel EXILE	page 174
A fitting timeline for Samson	page 187
Was Solomon 17 years old when he became king?	page 188
Unseal chronological patterns in 28 charts	page 189
Conclusion of second part	page 218
Appendix A From Adam to Abraham's family tree	page 220
Appendix B Counting with New moons and Days	page 226
Appendix C Timing of Levi, Kohath, Amram and Moses	page 252
Appendix D Synchronizing the calendar	page 253
Appendix E The Bible's timeline	page 254
Appendix F Daniel 8:14 '2300 evenings & mornings' ..	page 263
Appendix G Daniel 12:11-12 1,290 days & 1,335 days	page 265
Appendix H Daniel 70 th week	page 268
Appendix I King of Israel	page 274
Appendix J The flood's chronology	page 275
Appendix K 666 as a magic square	page 277
Appendix L 77 People of authority (11 + 22 + 44)	page 280
Appendix M The 12 symbolic acts of Ezekiel 4-5	page 281

Ezekiel 4. The master key to unlock the Bible's chronology

Yves Peloquin
Montréal, Canada

Email:
Yves.Peloquin@bell.net

<http://www.EzekielMasterKey.com>

Created Dec 2004
(Year 5966 AM)

Last update Oct 11, 2021
(Year 5983 AM)

Several solutions have been proposed to explain the 390 and the 40 years symbolized by Ezekiel's 390 and 40 days. None has been very convincing so far.

The following observation is therefore indisputable: in spite of the fact that Ezekiel spent a very long period (430 days) on his sides to perform a sign to the house of Israel, no one has ever come up with any hidden interpretation that could match (and justify) the prophet's amazing task? This book shall propose a fresh new way to understand Ezekiel 4.

The Siege of Jerusalem prophesied

Ezek 4:1-13 4:1 "Now, son of man, take a clay tablet, put it in front of you and draw the city of Jerusalem on it. 2 **Then lay siege to it:** Erect siege works against it, build a ramp up to it, set up camps against it and put battering rams around it. 3 Then take an iron pan, **place it as an iron wall between you and the city** and turn your face toward it. **It will be under siege, and you shall besiege it.** This will be a sign to the house of Israel. 4 "Then lie on your left side and put the sin of the house of Israel upon yourself. You are to bear their sin for the number of days you lie on your side. 5 I have assigned you the same number of days as the years of their sin. So for 390 days you will bear the sin of the house of Israel. 6 "After you have finished this, lie down again, this time on your right side, and bear the sin of the house of Judah. I have assigned you 40 days, a day for each year. 7 Turn your face toward the siege of Jerusalem and with bare arm prophesy against her. 8 I will tie you up with ropes so that you cannot turn from one side to the other until you have finished the days of your siege. 9 "Take wheat and barley, beans and lentils, millet and spelt; put them in a storage jar and use them to make bread for yourself. You are to eat it during the 390 days you lie on your side. 10 **Weigh** out twenty shekels of food to eat each day and eat it **at set times**. 11 Also measure out a sixth of a hin of water and **drink it at set times**. 12 Eat the food as you would a barley cake; bake it in the sight of the people, using human excrement for fuel." 13 The LORD said, "In this way the people of Israel will **eat defiled food among the nations** where I will drive them."

It is certain that some important chronological information can be obtained by correctly interpreting the sign performed by Ezekiel. After all, we already know that when he was lying for 390 and 40 days, he was then symbolically portraying a mysterious period of sin that lasted 390 years and another one that lasted 40 years. No doubts that these two values will lead us to the discovery of some solid markers in the Bible chronology once we have them correctly understood.

But there is more information to be obtained from Ezek 4-5 than what has been suggested until now. We will see in the following pages that while he was lying on his sides Ezekiel was performing more than a dozen different symbolic acts each one portraying an independent set of events that had or would take place over distinct periods of either 390, 40, or 430 years.

From a few basic sequences of events whose timeline are well known, we are going to, while identifying each Ezekiel 4-5 symbolic act, find out the timing of **every meaningful biblical event**. Figuratively speaking, this book has been designed like a ladder. Where each rung allow a workman to go higher and higher, here most chapters will introduce a new Ezekiel 4-5 symbolical act and consolidate the chronological information validated in the previous chapters. As we move on, several paths of reliable events will keep expanding until it becomes possible to merge them into a tightly interconnected network.

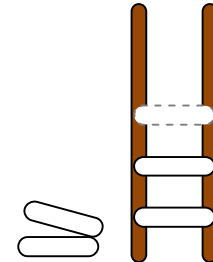

A unique feature pertaining to the development of this research will be obvious in **the first part** of the book. I decided that no biblical event would be associated to a specific date. Indeed, each event will be featured in its relationship with other. Thus similar to what is done in the Bible's narration, the emphasis will be exclusively over the length of time (# of years) separating the events between themselves (i.e. **relative dating**). This 'destabilizing' approach is necessary to establish a fundamental timeline that owes nothing to any material found outside the Bible (historic records, archeological deductions, scholar hypothesis, ect).

Like some of you may already know, once the chronology of the patriarchs has been figured out it is impossible to move on in a straight manner to reach the time of Moses, Aaron, Joshua, Caleb and others. This is why I believe the bible chronology should be handled like a jigsaw puzzle where the best strategy is not to progress from a single location but instead work with several parts according their color or patterns and then linking these areas together. We will see how it can be done.

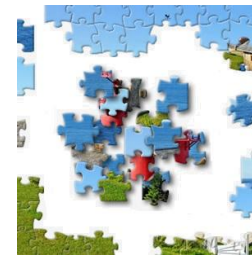

In the second part of the book, dates will be anchored to each biblical event (i.e. **absolute dating**). This is a prerequisite to adequately discuss about the occurrence of the sabbatical years, highlight the use of palindromic dates (Ex. Destruction of the first Temple in [3443 AM](#)), to project the likely timing of the future re-emergence of the Lost-Tribes of Israel, and of course to produce the detailed biblical timeline expected in this kind of work.

By the end of the book more than 180 biblical events will have been firmly dated and presented in spectacular patterns. Truly, never before was a biblical chronology elaborated around so many markers and with such an abundance of **self-validating mechanisms**.

I just mentioned that this chronology will display some spectacular patterns. In fact patterns are a major outcome of this chronology. They come in so many forms and they involve so many events that one could ask ourselves: Why were all those events inscribed in such a vast network of patterns? The likely answer is that the patterns, by their sole presence, are a proof of the accuracy of the dates leading to them. Given that a random set of dates would rarely lead to a sophisticate and spectacular pattern, finding a large number of them, interacting between each other, compels us to accept the involvement of a Master Designer.

Let's start with **five examples of spectacular patterns** to show evidence of design.
(note: this book is not about 'gematria' i.e counting the value of letters,

First example: The age of the last four patriarchs

Abraham	175	Gen 25:7
Isaac	180	Gen 35:28
Jacob	147	Gen 47:28
Joseph	110	Gen 50:26

Part of the following was observed by Stanley Gevirtz in an article called 'The Life Spans of Joseph and Enoch and the Parallellism'

Here the age of these four closely related and most central patriarchs of the Bible are used to produce the following mathematical relationship.

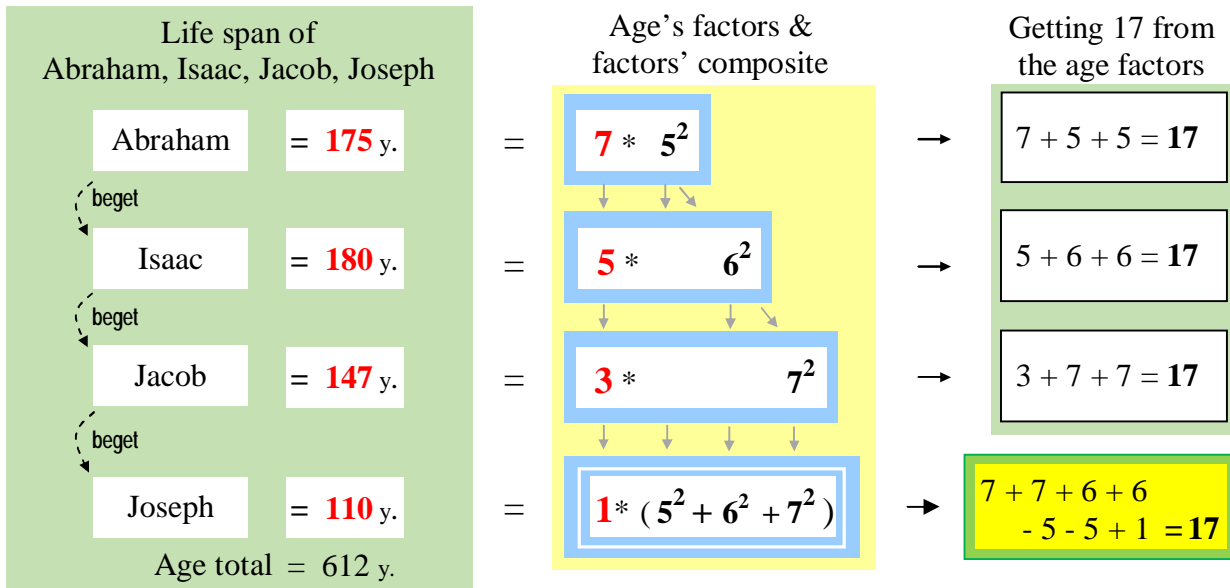

$612 = 4 * 153$ or
 $4 * (1+2+3+ .. +17)$

One can say that the mean value for these four individuals' age is 153 or $\sum_{i=1}^{17} i$ years

17 is the highest integer in the 'Summation' representing the average age (153 years) of the 4 patriarchs.

Second example: in this book

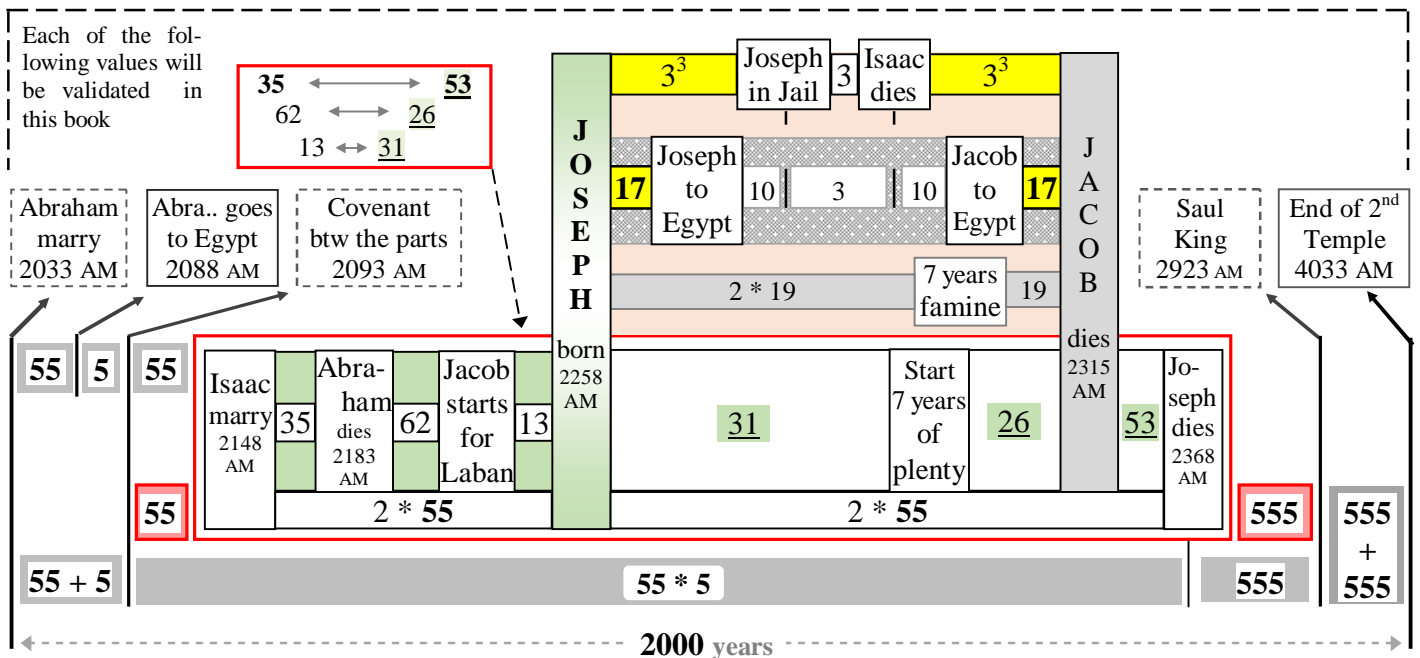

Third example : Genesis 1:1

The very first verse of the Bible tells us that God created the universe

Gen 1:1 In the beginning God created the heavens and the earth.

↓ ↓ ↓ ↓
 TIME ENERGY SPACE MATTER

Below, the Hebrew text of Gen 1:1 with the Gematria¹ value of each letter of the 7 words.

GENESIS 1:1						
7	6	5	4	3	2	1
90 200 1 5	400 1 6	40 40 10 40 300 5	400 1 4	40 10 5 30 1	1 200 2	400 10 300 1 200 2
הָאָרֶץ	וָאֵת	הַשָּׁמַיִם	אֵת	אֱלֹהִים	בָּרָא	בְּרֵאשִׁית
earth the	and	heaven the		God	created	beginning the In
296	407	395	401	86	203	913
← 7 letters →		← 7 letters →		← 14 letters →		← 14 letters →
← The 7 words use 28 letters (i.e. 1+2+3+4+5+6+7 letters) →						

The forth word 'אֵת' (i.e. **central word**) is untranslatable. Its two letters (Aleph א and Tav ת) are the very first and the very last letter of the Hebrew alphabet.

There are **22** letters in the Hebrew alphabet and the sum of the gematria values of the first letter of each words of Gen 1:1 is (2+2+1+1+5+6+5) = **22**

The gematria value of the 7 Hebrew words of Gen 1:1 leads to some fascinating information².

Let's add the 7 gematria values = 913 + 203 + 86 + 401 + 395 + 407 + 296 = **2701**

Multiply the 7 values → 913 * 203 * 86 * 401 * 395 * 407 * 296 = 304,153,525,784,175,760. 37*73

Add the digits of each number. ↓ ↓ ↓ ↓ ↓ ↓ ↓ 4 + 5 + 5 + 5 + 8 + 2 + 8 ─────────── 37	304 + 153 + 525 + 784 + 175 + 760 = 2701 ↓ ↓ ↓ ↓ ↓ ↓ ↓ 7 + 9 + 12 + 19 + 13 + 13 = 73 ↓ ↓ ↓ ↓ ↓ ↓ ↓ 7 + 9 + 3 + 10 + 4 + 4 = 37
--	--

2701 = 37 * 73 (37 & 73 are Reflective Numbers)
3773 = 2701 + 1072 (Note: 3773 = 7 * 7 * 77)

Note: In this book we will see that numbers **37** and **73** are hidden all over the timeline of the Bible.

There are 3*7*73 verses in Genesis (i.e. 1533)

In Gen 1:1 the gematria of	1st word + 3rd word	= 913 + 86	= 999
	2nd word + 4th word + 5th word	= 203 + 401 + 395	= 999
	6th word + twice the 7th word	= 407 + 296 + 296	= 999

¹ In the Hebrew alphabet each character has a value. A gematria of a word is the sum of these characters values.
² This information should be credited to Vernon Jenkins (<http://www.whatabeginning.com/>) and John Ellias (see <https://www.37x73.com/>)

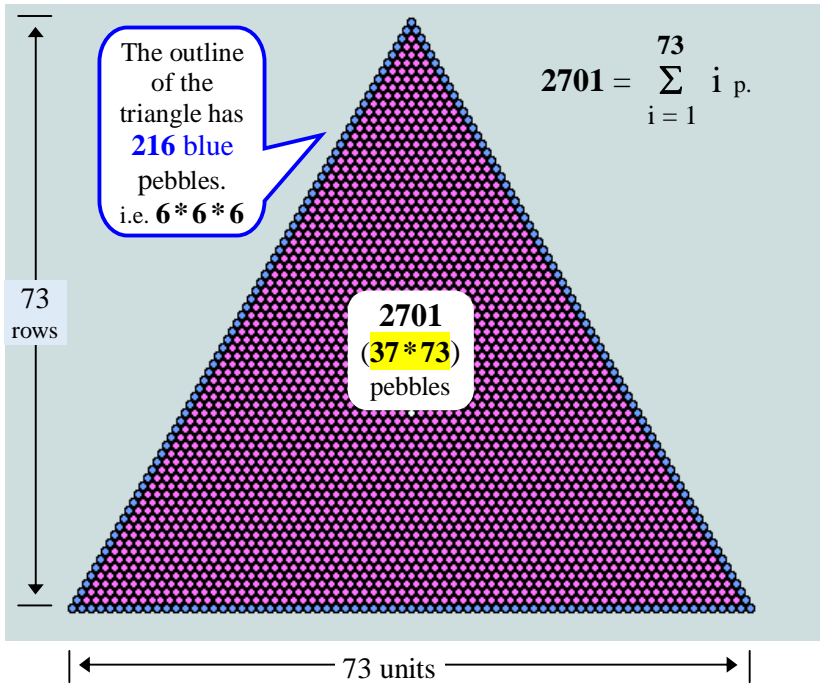

2701 is a triangular number and can be expressed like this:
 $1+2+3+\dots+71+72+73$

To visualize the value **2701**, we will build a triangle by aligning small pebbles (p) the following way:

there will be
 1 pebble on the first row,
 2 on the second,
 3 on the third
 ...
 73 pebbles on the 73th

There are 2701 pebbles in all.

Without adding or losing any pebble, we can transform the previous geometric structure in four perfectly fitting new ones.

Notice
 The gematria value of Gen 1:1 first 5 words
 'In the beginning God created the heavens'
 i.e. (913, 203, 86, 401, 395)

add up to **3 * 666**
 and the last two words
 'and the earth'
 i.e. (407 and 296)
 add up to **703**

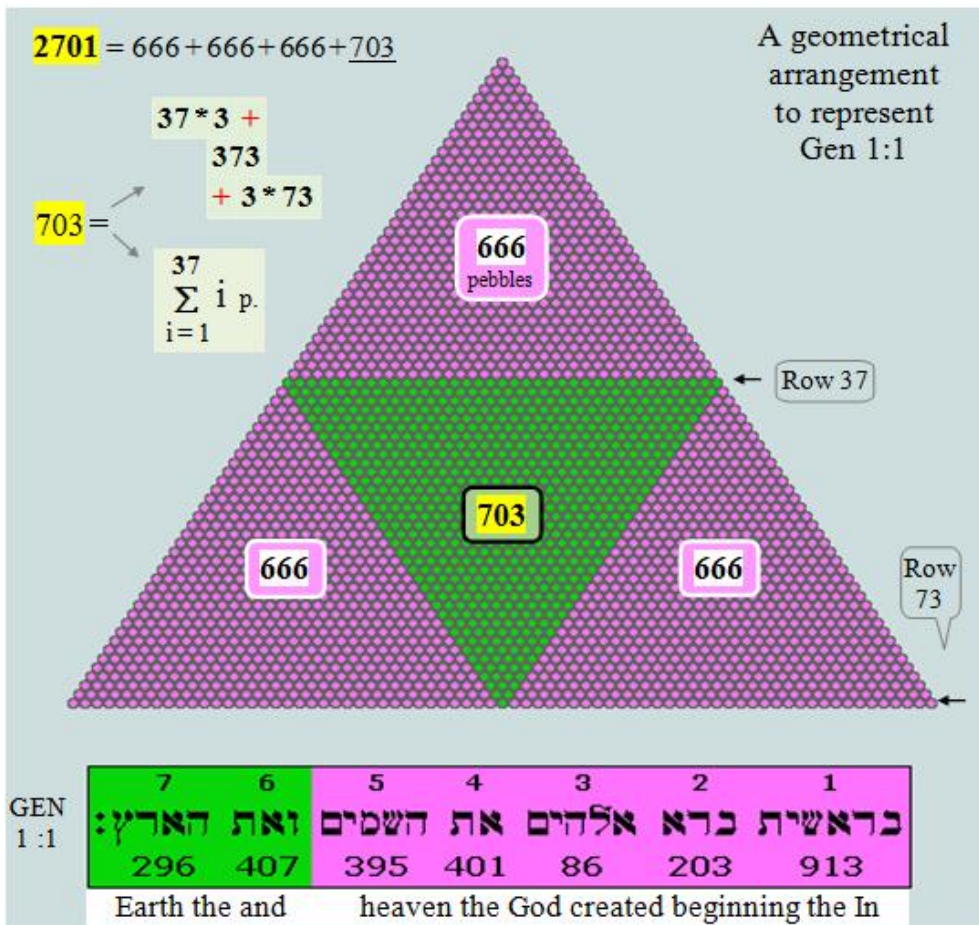

Interesting:
 $666 = (6+6+6) * 37$
 $666 = 1^6 - 2^6 + 3^6$
 $666 = 2^2 + 3^2 + 5^2 + 7^2 + 11^2 + 13^2 + 17^2$
 $666 = 1^3 + 2^3 + 3^3 + 4^3 + 5^3 + 6^3 + 5^3 + 4^3 + 3^3 + 2^3 + 1^3$
 $666 = 1+2+3+4+567+89$
 $= 123 + 456 + 78 + 9$
 $= 9+87+6+543+21$
 See Appendix K on page 279

Fourth example : The High Priest's Breastplate³

In Exodus 28 we are told that the High Priest was going to wear a piece of garment called the Breastplate. Over this garment was disposed, on 4 rows, 12 precious stones on which were engraved the **names of each tribe of Israel**, one name on each stone. Independantly of its power, the breastplate was hiding a numeric structure showing the absolute cleverness of God.



To demonstrate this we need to see the breastplate as a mathematical matrix in which the name of each tribe of Israel is replaced by its gematria value⁴. The following table gives us the gematria's values corresponding to each tribe's name. (The tribe's order can be found in Gen 29:32-Gen 20:20, Gen 41:51-52)

#	Tribe	Hebrew	gematria
1	Reuben	רֵאוּבֵן	259
2	Simeon	שִׁמְעוֹן	466
3	Judah	יְהוּדָה	30
4	Dan	דָּן	54
5	Naphtali	נַפְתָּלִי	570
6	Gad	גָּד	7

7	Asher	אֲשֵׁר	501
8	Issachar	יִשָּׁשכָר	830
9	Zebulun	זְבֻלֻן	95
10	Benjamin	בְּנִימִין	162
11	Manasseh	מְנַשֶּׁה	395
12	Ephraim	אֶפְרַיִם	331

3	2	1
30 Judah	466 Simeon	259 Reuben
6	5	4
7 Gad	570 Naphtali	54 Dan
9	8	7
95 Zebulun	830 Issachar	501 Asher
12	11	10
331 Ephraim	395 Manasseh	162 Benjamin

Here we have each matrix's row filled from right to left with the name of each tribe according the order of their birth.

Notice two important rules:

The name of '**LEVI**' is not used in the matrix. The **Breastplate** was worn by a Levite therefore there was no need to represent that tribe with a stone.

The name of **Joseph** is not used either. Instead we replace it with the names of his two sons (**Manasseh & Ephraim**) who were adopted by Jacob.

Gen 48:5 "Now then, your two sons born to you in Egypt before I came to you here will be reckoned as mine;

The first interesting fact in this matrix is that the sum of all the gematria value = **3700**.

$$3700 = 10 * 10 * 37$$

$$= 259 + 466 + 30 + 54 + 570 + 7 + 501 + 830 + 95 + 162 + 395 + 331$$

³ The following description should be entirely credited to two individuals, one is called Ian Mallett and the other is Vernon Jenkins whose work can be seen at <http://www.whatabeginning.com/> under 'AN ORACLE RESTORED'

⁴ In the Hebrew alphabet each character has a value and the gematria of a word is the sum of these values.

3 30 Judah ----- 7 Gad	2 466 Simeon ----- 570 Naphtali	1 259 Reuben
5 95 Zebulun	830 Issachar	4 54 Dan ----- 501 Asher
6 331 Ephraim	395 Manasseh	162 Benjamin

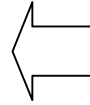

Lets divide the matrix in 6 perfectly fitting and harmonious parts.

To each area we associate the combined gematria values of each name found in it.

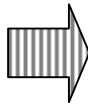

And here is an incredible discovery brought to light Vernon Jenkins: the number **37** is the main factor in each of the 6 parts of the new arrangement.

3 37	2 1036 (37 *28)	1 259 (37 *7)
5 925 (37 *25)	4 555 (37 *15)	
6 888 (37 *24)		

But it doesn't stop here, next page will show more stunning properties of Jacob's sons matrix.

3 30 Judah	2 466 Simeon	1 259 Reuben
6 7 Gad	5 570 Naphtali	4 54 Dan
9 95 Zebulun	8 830 Issachar	7 501 Asher
12 331 Ephraim	11 395 Manasseh	10 162 Benjamin

3 30 Judah	2 466 Simeon	1 259 Reuben
6 7 Gad	5 570 Naphtali	4 54 Dan
9 95 Zebulun	8 830 Issachar	7 501 Asher
12 331 Ephraim	11 395 Manasseh	10 162 Benjamin

The combined value of the greens areas
 $(259+30+570+501+95+395)$
 = 1850
 or
 $50 * 37$

The combined value of the oranges areas
 $(466+54+7+830+162+331)$
 = 1850
 or
 $50 * 37$

The combined value of the oranges areas
 $(30+7+830+95+162+395+331)$
 = 1850
 or
 $50 * 37$

The combined value of the greens areas
 $(259+466+54+570+501)$
 = 1850
 or
 $50 * 37$

Interesting:
 The gematria of Gen 1:1 (i.e. 2701) is found in the Breastplate's matrix

30 Judah	466 Simeon	259 Reuben
7 Gad	570 Naphtali	54 Dan
95 Zebulun	830 Issachar	501 Asher
331 Ephraim	395 Manasseh	162 Benjamin

$30 + 466 + 259 + 570 + 54 + 95 + 501 + 331 + 395 = 2701 = 37 * 73$

$7 + 830 + 162 = 999$

Now lets take the Gen 1:1 gematria values and add each number's digits the way it is done here
 $296=2+9+6=17$ then $17=1+7=8$

We do the same with the gematria values of the breastplate names.

The Gen 1:1 numbers
 (296 407 395 401 86 203 913)
 Adding the digit of each number
 $8 \rightarrow 2 \rightarrow 8 \rightarrow 5 \rightarrow 5 \rightarrow 5 \rightarrow 4$
 = 37

The Breastplate numbers
 (259 466 30 54 570 7 501 830 95 162 395 331)
 Adding the digit of each number
 $7 \rightarrow 7 \rightarrow 3 \rightarrow 9 \rightarrow 3 \rightarrow 7 \rightarrow 6 \rightarrow 2 \rightarrow 5 \rightarrow 9 \rightarrow 8 \rightarrow 7$
 = 73

Isn't it remarkable that the final values obtained by summing these numbers are **37** and **73** ?
 (Ref Matrix of the Breastplate by Leo Tavares)

Fifth example: The seven resurrections.

There are plenty of example showing that the number ‘7’ has a special meaning in the Bible

At the creation of the world, the **seventh day** was set apart from the previous six days. This is the only day which does not mention any new creative elements. Day 7 is also the only day that does not have the repeated formula, “And there was evening and there was morning. It is obvious that the seventh day is special.

Special too was the **7th patriarch** ‘Enoch’ (Adam, Seth, Enosh, Kenan, Mahalalel, Jared, Enoch). Gen 5:24 Enoch walked with God; then he was no more, because God took him away.

Joshua and Israel marched around Jericho **seven** times while **seven** priests blew **seven** trumpets before the walls came crashing down (Joshua 6:3-4).

On a recommendation of the prophet Elisha, Naaman, commander of the army of the king of Aram, was cure of leprosy by going to wash himself **7 times** in the Jordan (ref 2 King 5:1-14)

God instituted **7 feast days**. There are 4 in the spring : Passover, Unleavened bread, First fruits, Feast of Weeks. And there are 3 in the fall: Trumpets (Rosh Hashanah), Atonement (Yom Kippur), Tabernacles (Sukkot).

Yeshua was the **7th individual** brought back to life in the Bible. His resurrection is especially special giving that the 6 previous one are part of an unexpected pattern⁵ organized around the post mortem stage of those who died.

A double sequence of three post-mortem stages

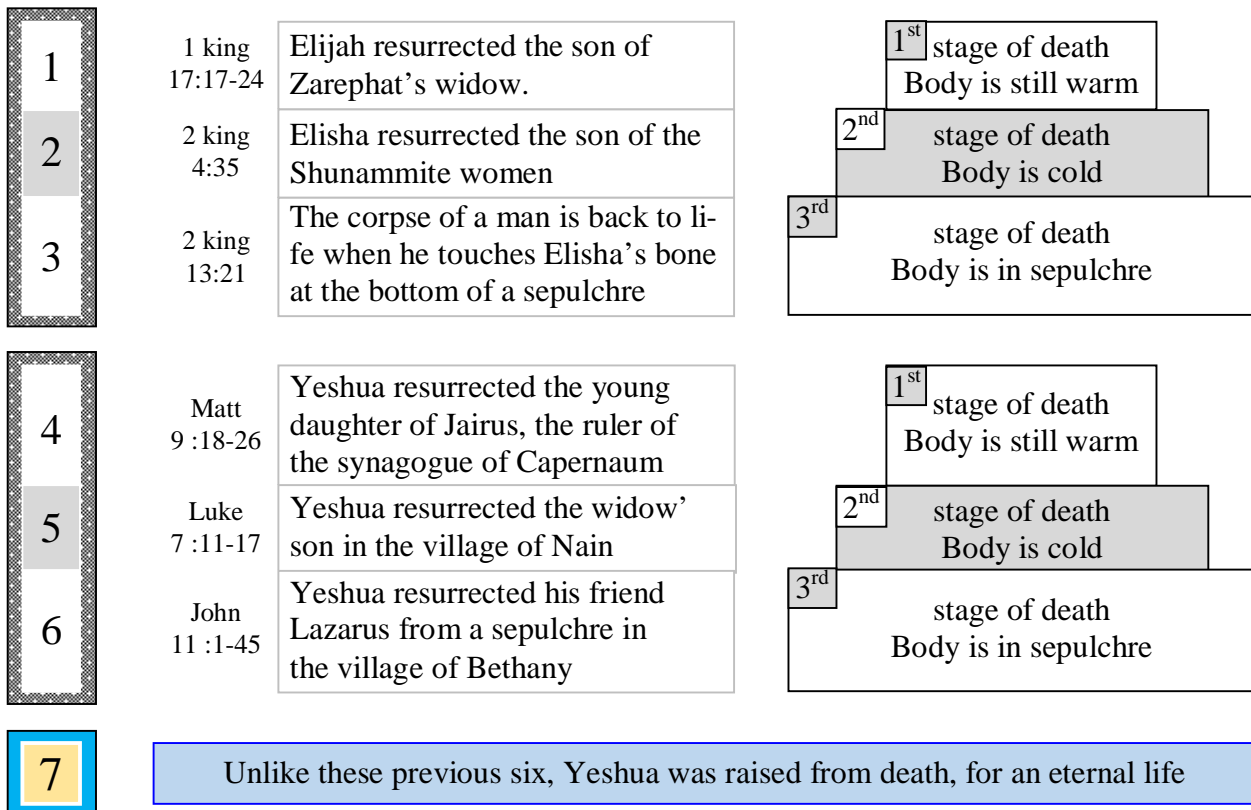

⁵ I learned about this pattern in ‘The Resurrection Pattern’ by Darek Barefoot

A premise } Given that the 40-year of sin (alluded by the 40 days of Ezek 4:6) represents a fixed period, we can deduce that it was preceded and followed by a period without sin. If this were not the case it wouldn't be possible to mark the beginning and the end of that 40 years.

Here is a new way to look at it:

When Ezekiel was told to bear the sin of the house of Judah, he was not told to bear all the sins of Judah; the request was much more specific than that. **He was going to bear ONLY one sin, a single sin that lasted 40 years.** All other sins committed by Judah could have lasted hundreds of years, or they could have been preceded and followed by years without sin; in the end these other sins were irrelevant to Ezekiel's 40 years of Sin.

HOUSE OF JUDAH HISTORY

Solomon dies	X years	40 years	Y years	Jerusalem's destruction
Kingdom splits (Ref 1 King 12:16)	Absence of the special sin	Special Sin	Absence of the special sin	

What was Judah's special Sin?

Ezek 5:11-12 Therefore as surely as I live, declares the Sovereign LORD, **because you have defiled my sanctuary** with all your vile images and detestable practices, I myself will withdraw my favor; I will not look on you with pity or spare you. A third of your people will die of the plague or perish by famine inside you; a third will fall by the sword outside your walls; and a third I will scatter to the winds and pursue with drawn sword. See also 2 Kings 21:7, Jer 7:30, 2 Chron 33:4-6, 2 Chron 33:7

➔ ➔ ➔ **Defilement of God's Temple** ← ← ←

Defiling the Temple (His dwelling place) was certainly an abomination in the eyes of God, something worse than anything else the people could have done.

We have now to answer three questions:

1. Who did it?
2. How and when was it stopped?
3. When did it start?

Who did it?

- 2 Kings 21:7-9 He took the carved Asherah pole he had made and put it in the temple **Manasseh** led them astray, so that they did more evil than the nations the LORD had destroyed before the Israelites.

See also Jer 15:3-4, 2 Kings 23:26-27, 2 Kings 24:2-4

So who did it? ➔ King Manasseh defiled the Temple.

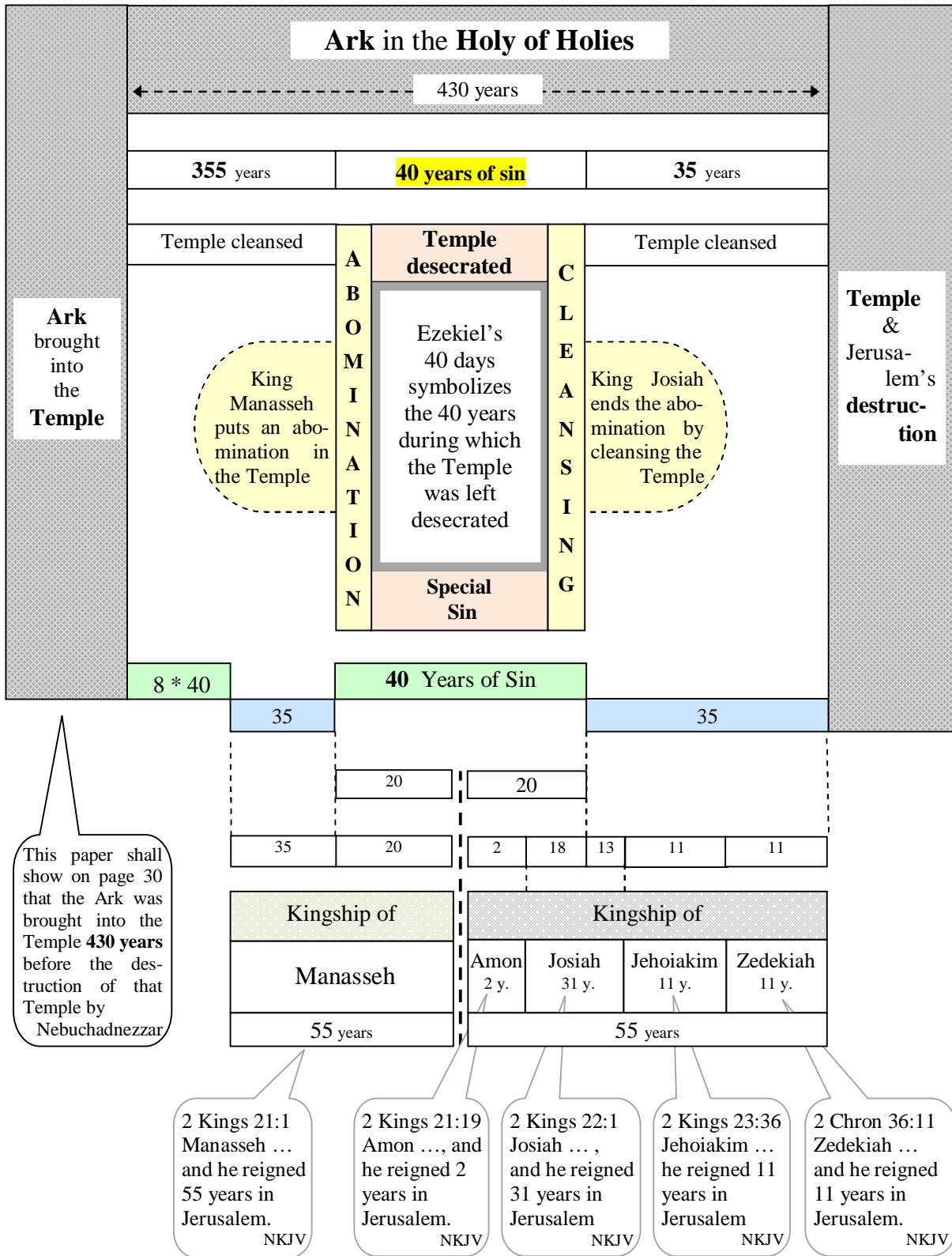

Figure 1. Judah's 40 years of Sin

The 390 years imputed to the house of Israel

The house of Israel's sin that we are looking for needs to satisfy the following 5 requirements:

- #1. Unique and never done before
- #2. Started at a specific time
- #3. Ended at a specific time
- #4. Lasted 390 years (and involve the same people from the start to the end)
- #5. Inflamed God

Here, contrary to the house of Judah's very unique sin that we have identified earlier, no such sin can be found in relation to the house of Israel. We have to consider the only other alternative: **the '390 years of sin' refers to a time in which numerous sins were committed.** Given that it is very unlikely that all those sins started on the same day, the beginning that we are looking for must be linked to an event involving the 12 tribes and must have been so disgraceful to God that it became the start of the 390 years of sin. Unsurprisingly, there is such an event.

- Hos 9:9 They have sunk deep into corruption, as **in the days of Gibeah**. God will remember their wickedness and punish them for their sins.
- Hos 10:9 "**Since the days of Gibeah**, you have sinned, O Israel, and there you have remained.

Judges 19 describes what happened in Gibeah. It can be summarized the following way:

A Levite and his concubine found shelter for the night in an old man's house in Gibeah in Benjamin. During the night the concubine was abused by some of the wicked men [Benjamites] of the city while this Levite showed no concern for her. The woman was found lying on the threshold of the house in the morning. Later, the Levite dismembered his concubine (while she might have been still alive) and sent one part to every tribe of Israel:

- Judg 19:29 When he reached home, he took a knife and cut up his concubine, limb by limb, into twelve parts and sent them into all the areas of Israel.

The disastrous outcome of this event was that the 12 tribes were involved in a fratricidal war for the first time. (11 tribes fought against the tribe of Benjamin who didn't want to release the guilty)

- Among the 11 tribes who fought against Benjamin there was more than 40,000 victims.
- Benjamin's tribe was nearly exterminated⁷. Among all the men, woman and children of that tribe only 600 soldiers survived by hiding for 4 months⁸.

⁷ Judg 20:48 The men of Israel went back to Benjamin and put all the towns to the sword, including the animals and everything else they found. All the towns they came across they set on fire.

⁸ Judg 20:46-47 On that day twenty-five thousand Benjamite swordsmen fell, all of them valiant fighters. But six hundred men turned and fled into the desert to the rock of Rimmon, where they stayed four months. NIV

The incident at Gibeah is the perfect candidate for the start⁹ of the 390-year period.

- ❖ Hosea (10:9) called the days of Gibeah the start of a period of sin (**Since the days of Gibeah**, you have sinned, O Israel). This is exactly what we are looking for.
- ❖ What happened was unique.¹⁰

Notice that the original intent of the men of Gibeah (Benjamites) was to commit **an abomination** prescribed by the law of God. Compare¹¹ Judge 19:22 and Lev 18:22. Therefore, both periods of sin (390 years and 40 years¹²) are associated with abominations.

When did the Gibeah incident happen?

Phinehas, the grandson of Aaron, was officiating when it happened. It situates the incident in the period following the arrival in the Promised Land:

- Judg 20:27-28 And the Israelites inquired of the LORD. (In those days the ark of the covenant of God was there, with Phinehas son of Eleazar, the son of Aaron, ministering before it.)

Israel served the Lord until all the elders who had witnessed the Exodus died. That makes it unlikely that the Gibeah incident happened before the death of Joshua:

- Josh 24:31 Israel served the LORD throughout the lifetime of Joshua and of the elders who outlived him and who had experienced everything the LORD had done for Israel.

If we speculate that the elders who outlived Joshua were at least 15 years old at the time of the Exodus (old enough to have understood what was going on) but younger than 20 years old (otherwise they would have died before reaching the promised land, a direct outcome of the spies' event as stipulated in Num 14:29) we have a group of people aged at least 60 years old at the division of the land. All those elders could have died during the next 30 years after the division of the land.

Note that Josh. 24:31 implies that Israel stopped serving the Lord not long after the death of all those witnesses.

⁹ There is no doubt that Israel was already sinning long before the event of Gibeah but the ABOMINATION that was committed at that time was worse than everything else.

¹⁰ Judg. 19:30 Everyone who saw it said, "Such a thing has never been seen or done, not since the day the Israelites came up out of Egypt

¹¹ Judg 19:22 "Bring out the man who came to your house so we can have sex with him."
Lev 18:22 Thou shalt not lie with mankind, as with womankind: it is abomination.

¹² 2 Kings 21:11 "Because Manasseh king of Judah has done these abominations (he has acted more wickedly than all the Amorites who were before him, and has also made Judah sin with his idols),

- Ruth 4:11 The LORD make the woman that is come into thine house like Rachel and like Leah, which two did build the house of Israel: NKJV

After the Gibeah incident the Israelites kept sinning for several hundred years and during that time:

- They were often oppressed in response to their worshipping of others gods.
- The Ark was captured.
- They rejected God their true King and asked for Saul.
- God rejected Saul their first king.

It would have been an amazing change if the people had suddenly succeeded in reforming themselves after all these years, yet, according to Ezekiel 4. the period of sin lasted no more than 390 years. A very important event must have happened to justify that the count of years of sin came to a stop after these 390 years?

This event seems to be directly related to God's dwelling place:

- Deut 12:4-5 You must not worship the LORD your God in their way. **But you are to seek the place the LORD your God will choose from among all your tribes to put his Name there for his dwelling.**

At the time of the Gibeah incident God's "**permanent**" dwelling place was at Shiloh (**under the jurisdiction of Ephraim**¹⁵), however He abandoned it and chose Zion instead.

- Ps 78:59 he rejected Israel completely.
- Ps 78:68 but he chose the tribe of Judah, Mount Zion, which he loved.

If it can be shown that God's dwelling place was moved to Zion exactly 390 years after the Gibeah incident, we would have a very strong argument to explain why Israel's years of Sin did not go over the 390's mark; the logic would be that by moving to a new dwelling place, God was heralding an important change: Offering a new beginning (see p. 24) to the people by bringing to an end the counting of the years of their sins would be in harmony with the notion of an important change.

Paying attention to the location of the Ark of covenant

God rejected the House of Israel (He left Shiloh)

- 1 Sam 4:22 The glory has departed from Israel, for the ark of God has been captured."

We have something truly unique here: as a sign that He had rejected the House of Israel and His dwelling place in Shiloh, God sent the Ark into captivity:

- 1 Sam 3:11 And the LORD said to Samuel: "See, I am about to do something in Israel that will make the ears of everyone who hears of it tingle.

God chose the House of Judah (He came to Zion)

Years later the Ark would again be used, but this time to show that God was coming to His new dwelling place in Zion.

¹⁵ Jer 31:9 because I am Israel's father, and Ephraim is my firstborn son. NIV

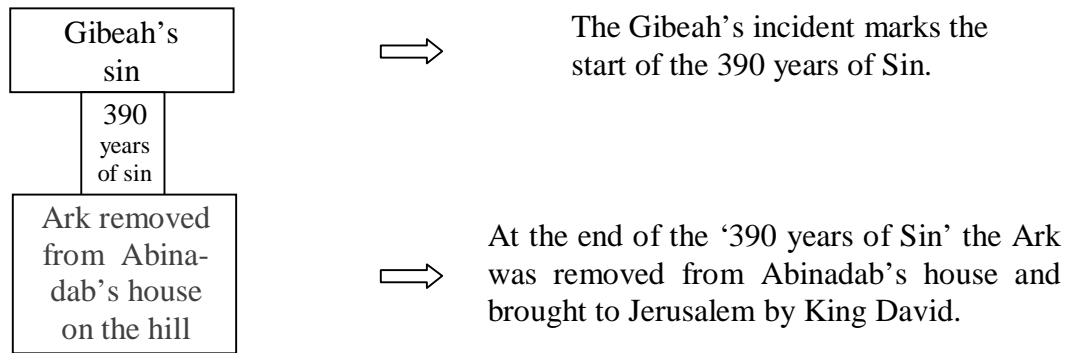

When the time came to bring the Ark into Jerusalem David had to fetch it from the house of Abinadab. In 2 Sam 6:3 we are told that Abinadab's house was on a **hill**. Why are we told this seemingly useless detail? It doesn't appear to bring anything to the story and from the reader's perspective that 'hill' could have been any hill.

The Hebrew word translated as '**hill**' in 2 Sam 6:3 is the very same word used in Judges 19 to designate the Benjamite town of '**Gibeah**'. Interesting, isn't it? The implication here is that we were not merely informed that the house of Abinadab was on an 'unknown' hill, impossible to identify, but we were rather told that this house was at Gibeah, the same 'Gibeah' that was involved with the start of the 390 years of Sin. Notice that while most English translations of the Bible have the house of Abinadab on a hill, the KJV has located it at 'Gibeah':

- 2 Sam 6:3 And they set the ark of God upon a new cart, and brought it out of the house of Abinadab that was in Gibeah: KJV

Obviously 'Gibeah' and 'hill' are from the same Hebrew word. Which one the author of 2 Sam 6:3 had in mind when he wrote the verse is hard to determine but we can speculate in favor of 'Gibeah'.

The town of Gibeah was where King Saul (the first king of Israel) lived during his whole kingship. Therefore, it would be reasonable to think that Saul, at one time during his kingship, had the Ark brought to Gibeah so that it could be close to him. Was not David going to do exactly the same when he moved to Jerusalem?

- 2 Sam 6:12 O David went down and brought up the ark of God from the house of Obed-Edom to the City of David with rejoicing. NIV

As we can see, the start and the end of the 390 years of sin are both related to Gibeah somehow.

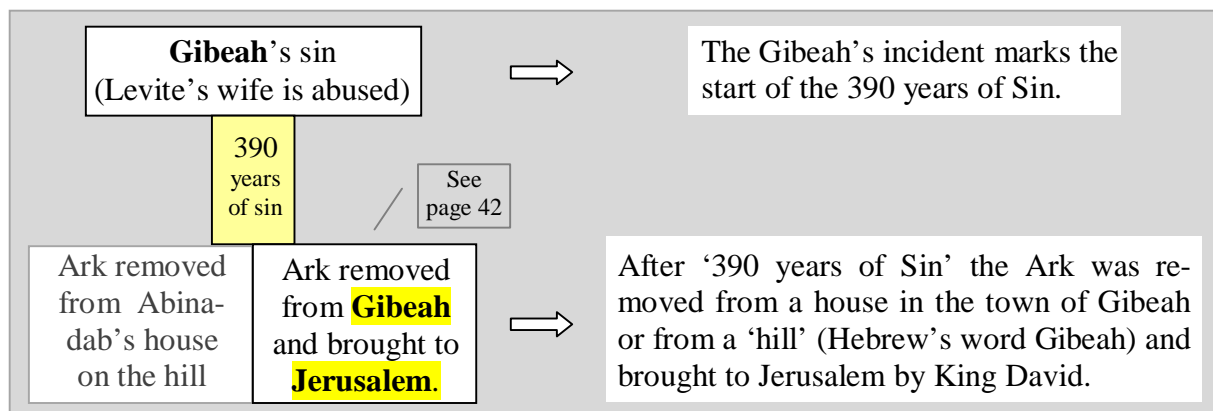

The following 7 points will highlight some interesting parallels between the Start (S1-S7) and the End (E1-E7) of that 390-year period. They confirm that the two events are related somehow.

S1	<p>There was no King in Israel at that time: Judg 19:1 In those days Israel had no king.</p>	
	<p>David was the first king to reign over all Israel.</p>	E1

S2	<p>The Levite wouldn't go to Jerusalem for sanctuary: Judg 19:12 No We won't go into an alien city, whose people are not Israelites.</p>	
	<p>The Ark could not be brought to its new sanctuary without the participation of the Levites: 1 Chron 15:12-13 "You are the heads of the Levitical families; you and your fellow Levites are to consecrate yourselves and bring up the ark of the LORD, the God of Israel, to the place I have prepared for it. It was because you, the Levites, did not bring it up the first time that the LORD our God broke out in anger against us.</p>	E2

S3	<p>The Levite wouldn't go to Jerusalem because it was occupied by the Jebusites: Judg 19:11-12 "Come, let's stop at this city of the Jebusites and spend the night." His master replied, "No.</p>	
	<p>When David came to Jerusalem, a few years before he brought the Ark, the first thing he and his army did was to remove the Jebusites from the city: 2 Sam 5:6 The king and his men marched to Jerusalem to attack the Jebusites, who lived there.</p>	E3

S4	<p>The Levite dismembered his concubine in 12 parts: Judg 19:29 When he reached home, he took a knife and cut up his concubine, limb by limb, into twelve parts and sent them into all the areas of Israel.</p>	
	<p>The last Benjamite king over Israel was Ish-Bosheth and he was killed by two of his own compatriots. The surprising thing about this is that all three Benjamites men were dismembered and the total number of their limbs was also 12.</p> <ul style="list-style-type: none"> Ish-Boseth's head was cut off: = 2 parts. • 2 Sam 4:7 After they stabbed and killed him, they cut off his head. Recab and Baanah, Ish-Boseth's murderer: 5 parts each = 10 parts • 2 Sam 4:12 They cut off their hands and feet and hung the bodies by the pool in Hebron. 	E4

S5 The people of Israel who came to fight at Gibeah didn't want to go to war against the whole tribe of Benjamin. They sent men among the Benjamites to negotiate the surrender of the wicked men of Gibeah who had abused the Levite concubine:
Judg 20:13 Now surrender those wicked men of Gibeah so that we may put them to death and purge the evil from Israel."
Unexpectedly the **Benjamites refused to listen to their brother** and chose to protect those who were guilty.
All the Benjamite woman and children were killed during the following war. (Jud 20:48)

Of all the people gathered in Jerusalem for the bringing in of the Ark, the only one (we are told) who didn't show a joyful heart during the event was Michal, the King's wife. She despised David because he was dancing before the Ark:
2 Sam 6:16 As the ark of the LORD was entering the City of David, Michal daughter of Saul watched from a window. And when she saw King David leaping and dancing before the LORD, she despised him in her heart.
Unexpectedly Michal, a **Benjamite** (daughter of Saul) **refused to humble herself**.
This Benjamite woman didn't have any children until the day of her death. (2 Sam 6:23)

E5

S6 After having fought and won against the Benjamites, the people of Israel went to Bethel ('**house of God**') to repent of the gravity of their action.
→ The people fasted:
Judg 21:2 The people went to Bethel, where they sat before God until evening, raising their voices and weeping bitterly.
→ Presented burnt offerings and fellowship offerings:
Judg 21:4 and presented burnt offerings and fellowship offerings.

After the Ark was brought to Zion (its new **dwelling place**)
→ David presented burnt offerings and fellowship offering:
1 Chron 16:2 After David had finished sacrificing the burnt offerings and fellowship offerings
→ And the people were fed:
1 Chron 16:3 Then he gave a loaf of bread, a cake of dates and a cake of raisins to each Israelite man and woman.

E6

S7 One outcome of the Gibeah incident was the near extinction of the Benjamites. Of the 600 men who survived 200 needed to find a wife among the other tribes. It was agreed that they could pick one from **among the girls that were dancing at Shiloh**. (see Jud 21:20-22)

When the Ark came to Zion **David was seen leaping and dancing** before the Lord:
2 Sam 6:16 and when she saw King David leaping and dancing before the LORD

E7

NOTE: In each case the dancing was very special and the person doing it would never have to do it again.
-- The girls of Shiloh were dancing to find a husband (otherwise the author of Jud 21:22 would have used a much stronger word than 'complaint' to describe the people's protestation. Notice also that only the girls' fathers and brothers were involved, if the matter had been dramatic the whole town would have joined in.).
-- The King was dancing in the street (a very unusual sight) because the Ark was coming to Zion. He would never have to do it again.

It was previously said (on page 20) that the count of years was stopped in the 390th year because that year (when the Ark was brought to Jerusalem) the Israelites were offered a new beginning. Were they really offered a new beginning?

Consider this: Bringing the Ark to Jerusalem was a major event in the history of the 12 tribes and it was done with the approbation of God and every leader of Israel¹⁶.



When the right time came, everybody¹⁷ in Israel was mobilized to bring the Ark and each one had the proper attitude for transforming that day into a grand celebration.

Holiness

- 1 Chron 15:12-13 "You are the heads of the fathers' houses of the Levites; sanctify yourselves, you and your brethren, that you may bring up the ark of the LORD God of Israel to the place I have prepared for it.

Respect

- 2 Sam 6:13 And so it was, when those bearing the ark of the LORD had gone six paces, that he sacrificed oxen and fatted sheep.

Humility

- 2 Sam 6:14 Then David danced before the LORD with all his might; and David was wearing a linen ephod.

Joy

- 2 Sam 6:15 So David and all the house of Israel brought up the ark of the LORD with shouting and with the sound of the trumpet.

When the Ark reached its new Tabernacle in Zion (the tent used at the previous location was not brought with the Ark) David offered a peace offering¹⁸ to God in the name of all the people¹⁹.

And then David blessed²⁰ all the people **in the name of God.**

¹⁶ 1 Chron 13:1-3 Then David consulted with the captains of thousands and hundreds, and with every leader. And David said to all the assembly of Israel, "If it seems good to you, and if it is of the LORD our God, let us send out to our brethren everywhere who are left in all the land of Israel, and with them to the priests and Levites who are in their cities and their common-lands, that they may gather together to us; and let us bring the ark of our God back to us NKJV

¹⁷ 1 Chron 15:3 David assembled all Israel in Jerusalem to bring up the ark of the LORD to the place he had prepared for it.

¹⁸ Peace Offering. This sacrifice celebrated covering of sin, forgiveness by God, and the restoration of a right and meaningful relationship with God and with life itself. (from Nelson's Illustrated Bible Dictionary, Copyright (c)1986, Thomas Nelson Publishers)

¹⁹ 2 Sam 5:1-2 All the tribes of Israel came to David at Hebron and said, "We are your own flesh and blood. ... And the LORD said to you, 'You will shepherd my people Israel, and you will become their ruler.'"

²⁰ 2 Sam 6:18 he blessed the people in the name of the LORD Almighty. NIV

David's blessing is the key element in my belief that the count of 'year of sin' was then stopped. In those days the people were not collectively blessed on a regular basis and the last time they had been was on Mount Gerizim (Josh 8:33-34) when Joshua did it (400 years earlier). Therefore, David's blessing was so exceptional that its implication cannot be neglected.

There would have been no point in God allowing David to pass special favours to the 12 tribes if at the same time He intended to keep cumulating the years of their sin.

When was the Ark brought to Jerusalem?

David first 7 years as King were in Hebron:

- 2 Sam. 5:5 In Hebron he reigned over Judah for seven years and six months, and in Jerusalem he reigned over all Israel and Judah for thirty-three years.

So the Ark did not come to Jerusalem before David's 8th year of reign. In fact, we will see a little further in this paper (on page 65) that the Ark was probably brought to Jerusalem 3 years after David came to the city.

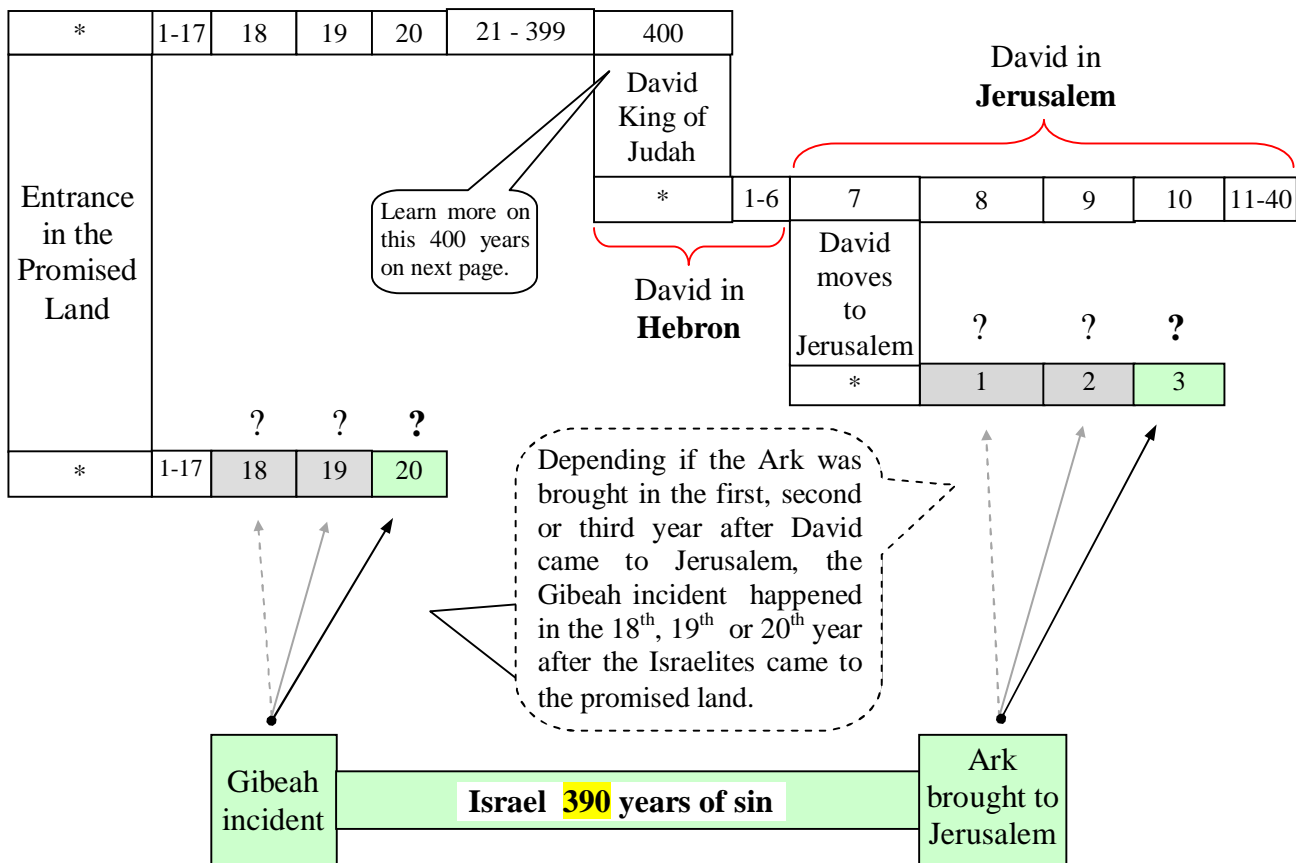

The **390** years of sin associated with the House of Israel is **the time period between the Gibeah incident and the 'arrival' of the Ark in Jerusalem.**

David's reign

The following chart shows that David began to reign 400 years after the Israelites came to the Promised Land. For more explanation, read my paper "The 44 Hebrew monarchs (A Chronology of two kingdoms)"

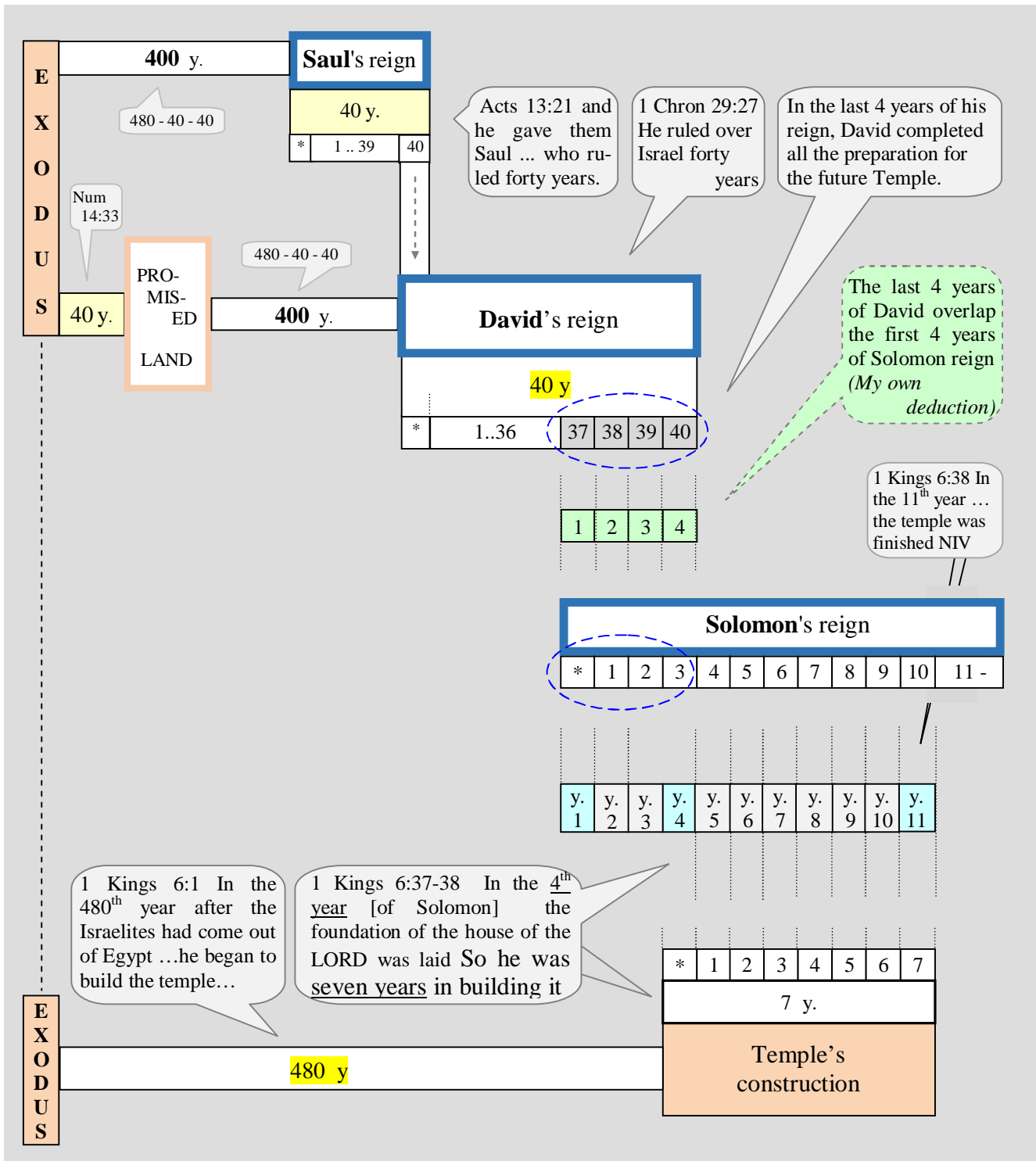

Ezekiel's 430-year SIEGE of Jerusalem

Ezekiel was asked to symbolize a siege that would end with the destruction of Jerusalem.

- Ezek 4:1-3 ... and portray on it a city, Jerusalem. **Lay siege against it**, **build a siege wall** against it, and heap up a mound against it; set camps against it also, and place battering rams against it all around. Moreover take for yourself an iron plate, and set it as an iron wall between you and the city. Set your face against it, and it shall be besieged, and you shall lay siege against it. NKJV
- Ezek 5:14 Moreover **I will make you a waste** and a reproach among the nations that are all around you, in the sight of all who pass by. NKJV

To do it, he had to lie on his side in front of an image of the city for 430 days, a number obtained by combining the 390 days he spent lying for the House of Israel with the 40 days he spent lying for the House of Judah:

- Ezek 4:5-7 ... So for 390 days you will bear the sin of the house of Israel. "After you have finished this, I have assigned you 40 days, a day for each year.

A major point has to be understood about the duration of Ezekiel's siege. No matter that the 430 days are a composite of the 390 days and 40 days, it would be erroneous to deduce that Ezekiel performed two different sieges (one 390-day siege associated with Israel and one 40-day siege associated with Judah.). Ezekiel's siege had nothing to do with the side on which he was lying on. During the **whole 430 days** of the act, Ezekiel had been continually facing the image of Jerusalem; therefore he was portraying a single and uninterrupted siege.

Using the rule that a day stands for a year²¹ **Ezekiel portrayed a siege that lasted 430 years**. As we know, it was Nebuchadnezzar, King of Babylon, who achieved the destruction of Jerusalem. He came to Jerusalem in the 9th year of the reign of Zedekiah (King of Judah), he laid a siege in front of the city and, in the 11th year of the reign of the King of Judah, succeeded in piercing the wall. Jerusalem was then burned down and the Temple destroyed. **Nebuchadnezzar's siege lasted less than 2 years:**

- 2 Kings 25:1-4 So in the ninth year of Zedekiah's reign, on the tenth day of the tenth month, Nebuchadnezzar king of Babylon marched against Jerusalem with his whole army. He encamped outside the city and built siege works all around it. The city was kept under siege until the eleventh year of King Zedekiah.Then the city wall was broken through

Why did the symbolic siege that Ezekiel was portraying had a duration of 430 years (day = year) when it is so obvious that Nebuchadnezzar's siege only lasted 2 years? There could be only one possible explanation. Even though those two sieges ended with the destruction of Jerusalem,

Ezekiel's siege was not depicting Nebuchadnezzar's siege at all.

Was Jerusalem under siege for 430 years? Yes it was.

²¹ As explained in Ezek. 4:5 I have assigned the same number of days as the years of their sin.

- 1 Sam 4:6-7 when they learned that the ark of the LORD had come into the camp, the Philistines were afraid.
- 1 Sam 5:3 When the people of Ashdod rose early the next day, there was Dagon, fallen on his face on the ground before the ark of the LORD!
- 1 Sam 5:10 the people of Ekron cried out, "They have brought the ark of the god of Israel around to us to kill us and our people."
- 1 Sam 6:19 But God struck down some of the men of Beth Shemesh, putting seventy of them to death because they had looked into the ark of the LORD

Did the ark come to a new location? **It was brought to the Temple:**

- 1 Kings 8:3-4 When all the elders of Israel had arrived, the priests took up the ark, and they brought up the ark [*in the temple*]

Do we have a fortified camp? Yes, the **Holy of Holies inside the Temple:**

- Ezek 24:21 I am about to desecrate my sanctuary-**the stronghold** in which you take pride,
- 1 Kings 6:19-20 He prepared the inner sanctuary within the temple to set the ark of the covenant of the LORD there.
- 2 Sam 6:2-3 the ark of God, which is called by the Name, the name of the LORD Almighty, who is enthroned between the cherubim that are on the ark.
- Ezek 43:6-7 I heard someone speaking to me from inside the temple. He said: "Son of man, this is the place of my throne and the place for the soles of my feet.
- Ezek 9:3 Now the glory of the God of Israel went up from above the cherubim, where it had been, and moved to the threshold of the temple.
- 1 Kings 8:11 for the glory of the LORD filled his temple.
- 1 Kings 8:12-13 "The LORD has said that he would dwell in a dark cloud; I have indeed built a magnificent temple for you, a place for you to dwell forever."

The ark of the covenant, sitting in the inner sanctuary of the Temple was, for the people of Jerusalem, a constant reminder (430 years) of the alliance they had agreed with God.

- Ex 34:10 Then the LORD said: "I am making a covenant with you.

- Jer 25:6 Do not follow other gods to serve and worship them; do not provoke me to anger with what your hands have made
- Jer 44:4-6 Again and again I sent my servants the prophets, who said, 'Do not do this detestable thing that I hate!' But they did not listen or pay attention; they did not turn from their wickedness or stop burning incense to other gods. Therefore, my fierce anger was poured out; it raged against the towns of Judah and the streets of Jerusalem and made them the desolate ruins they are today.
- Jer 44:10 To this day they have not humbled themselves or shown reverence, nor have they followed my law and the decrees I set before you and your fathers.

The whole Temple was filled with the power of God:

- 1 Kings 8:10-11 When the priests withdrew from the Holy Place, the cloud filled the temple of the LORD. And the priests could not perform their service because of the cloud, for the glory of the LORD filled his temple.
- Ezek 24:21 I am about to desecrate my sanctuary-**the stronghold** in which you take pride,

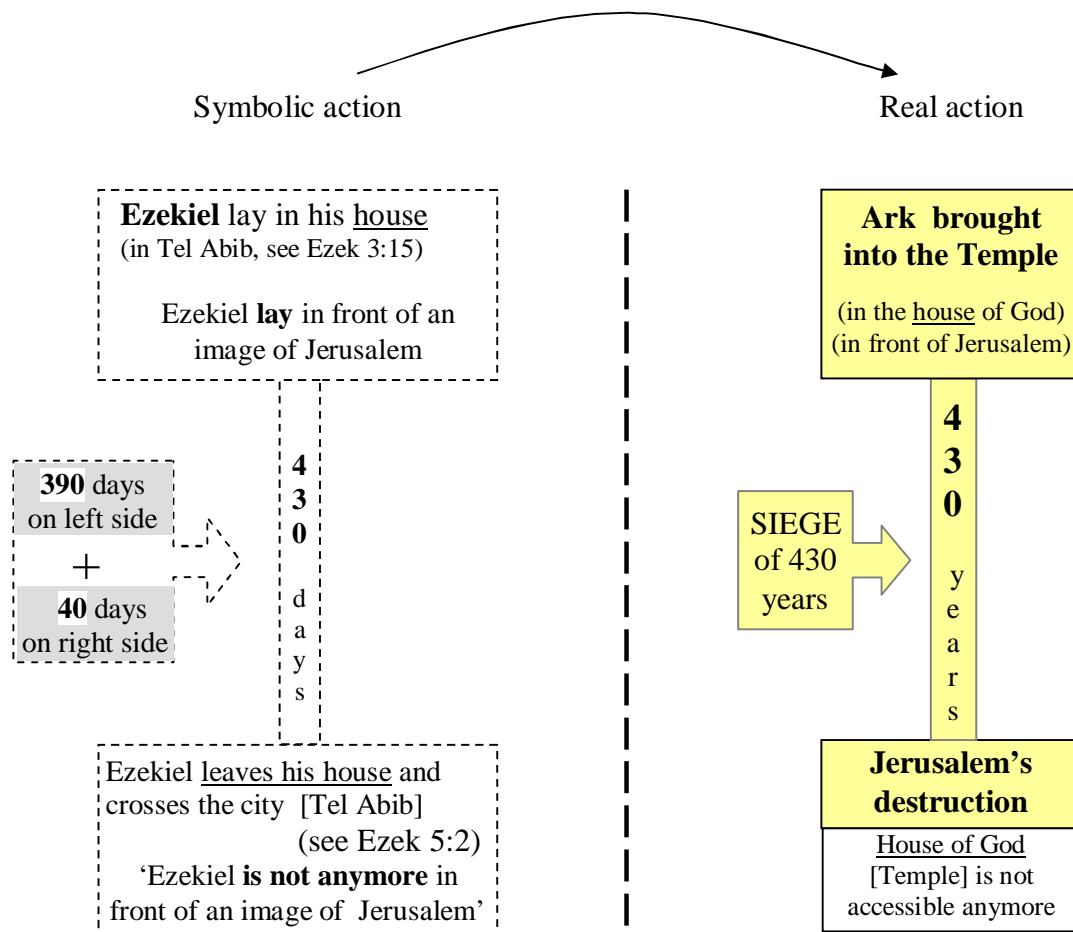

Figure 3. God's 430 years SIEGE

The Temple

The Temple built by Solomon was the third stage of a design conceived by God. Five of those stages are known, the first one was used in the book of Genesis and the last one belongs in the book of Revelation.

- | | | |
|---|--|---|
| #1. The Garden of Eden's layout (Genesis) | | It is outside the scope of this paper to discuss how each structure mirrors a unique pattern but under a different form. Suffice it to say that from the first structure to the last, elements had been evolving from their physical representation toward a spiritual counterpart in heaven. |
| #2. The Tabernacle of Moses (Exodus) | | |
| #3. Solomon's Temple (King) | | |
| #4. Ezekiel's Temple (Ezekiel) | | |
| #5. The heavenly Throne of God (Revelation) | | |

It is important for the comprehension of 'Ezekiel 4-5' to realize that because each structure shares the same design, we can borrow information supplied in one stage and apply it to the next stage (and vice versa).

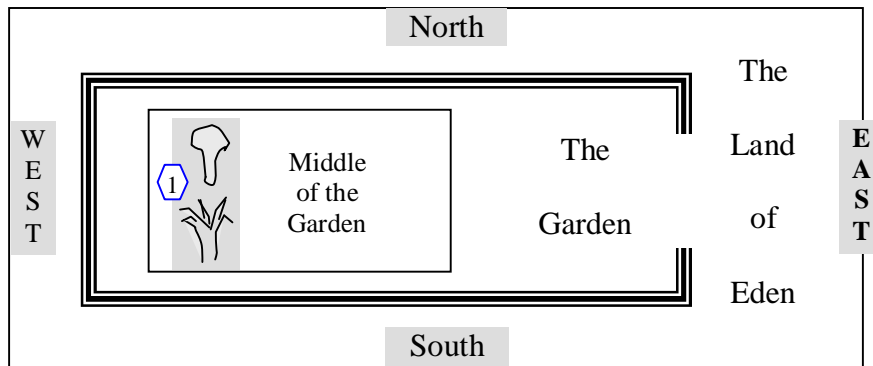

Same layout

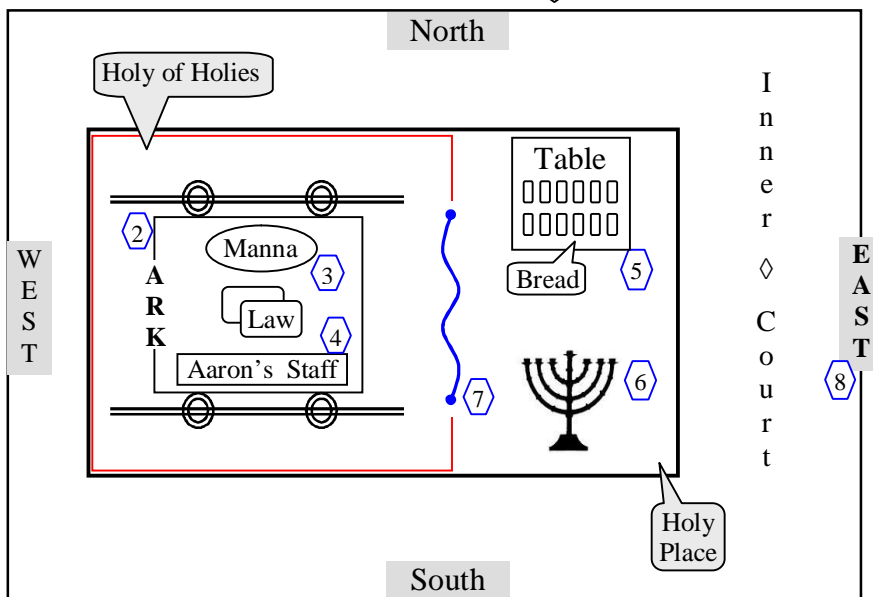

The Garden of Eden was in the Land of Eden. In the middle of the garden was a very special place where two unique trees were found. One was called the Tree of Life and the other the Tree of Good and Evil

In the tabernacle of Moses, in the inner room called the Holy of Holies, was the Ark, that contained the Pot of Manna and Aaron's staff.

In the 2nd structure the pot of manna and Aaron's staff typify the tree of life and the tree of good and evil of the first structure. We know that Aaron's staff is related to almonds (Num 17:8-9) so it is probably the case for one of the two trees found in the middle of the garden.

1 Gen. 2:9 In the middle of the garden were the tree of life and the tree of the knowledge of good and evil.

2 In the Temple the Ark contained only the Law:

1 Kings 8:9 9 There was nothing in the ark except the two stone tablets that Moses had placed in it at Horeb, where the LORD made a covenant with the Israelites after they came out of Egypt.

But at Sinai there was also some manna and Aaron's staff:

Heb. 9:4 This ark contained the gold jar of manna, Aaron's staff that had budded, and the stone tablets of the covenant.

A representation of the manna and Aaron's staff will be kept in the following schemas for their symbolic value.

3 Ex 16:34 Aaron put the manna in front of the Testimony,

Ex 16:33 So Moses said to Aaron, "Take a jar and put an omer of manna in it. Then place it before the LORD to be kept for the generations to come."

NOTE 1 : That was in Moses' Tabernacle

NOTE 2 : The Manna is situated on the north side since this is the side where the bread will be. See item 4.

4 Num. 17:8 Aaron's staff, which represented the house of Levi, had not only sprouted but had budded, blossomed and produced almonds.

NOTE 1 : That was in Moses' Tabernacle.

NOTE 2 : Aaron's staff is situated on the south side since this is the side where the lamp will be. See item 5.

5 Ex. 26:35 Place the table outside the curtain on the north side

Ex. 40:23 and set out the bread on it before the LORD

Lev. 24:6 Set them in two rows, six in each row,

6 Ex. 26:35 put the lampstand opposite it on the south side.

Ex. 25:32-33 Six branches are to extend from the sides of the lampstand-
-three on one side and three on the other. Three cups shaped like almond flowers with buds and blossoms are to be on one branch, three on the next branch, and the same for all six branches extending from the lampstand.

7 2 Chron. 3:14 He made the curtain of blue, purple and crimson yarn and fine linen, with cherubim worked into it.

8 Two of the structures were facing 'EAST' and it must be the case for the others.

Garden of Eden: Gen. 2:8 Now the LORD God had planted a garden in the east, in Eden;

Ezekiel Temple : Ezek. 8:16 With their backs toward the temple of the LORD and their faces toward the east, they were bowing down to the sun in the east

Now, instead of visualizing Ezekiel in his home, we will depict him in the Temple²³ of Solomon..

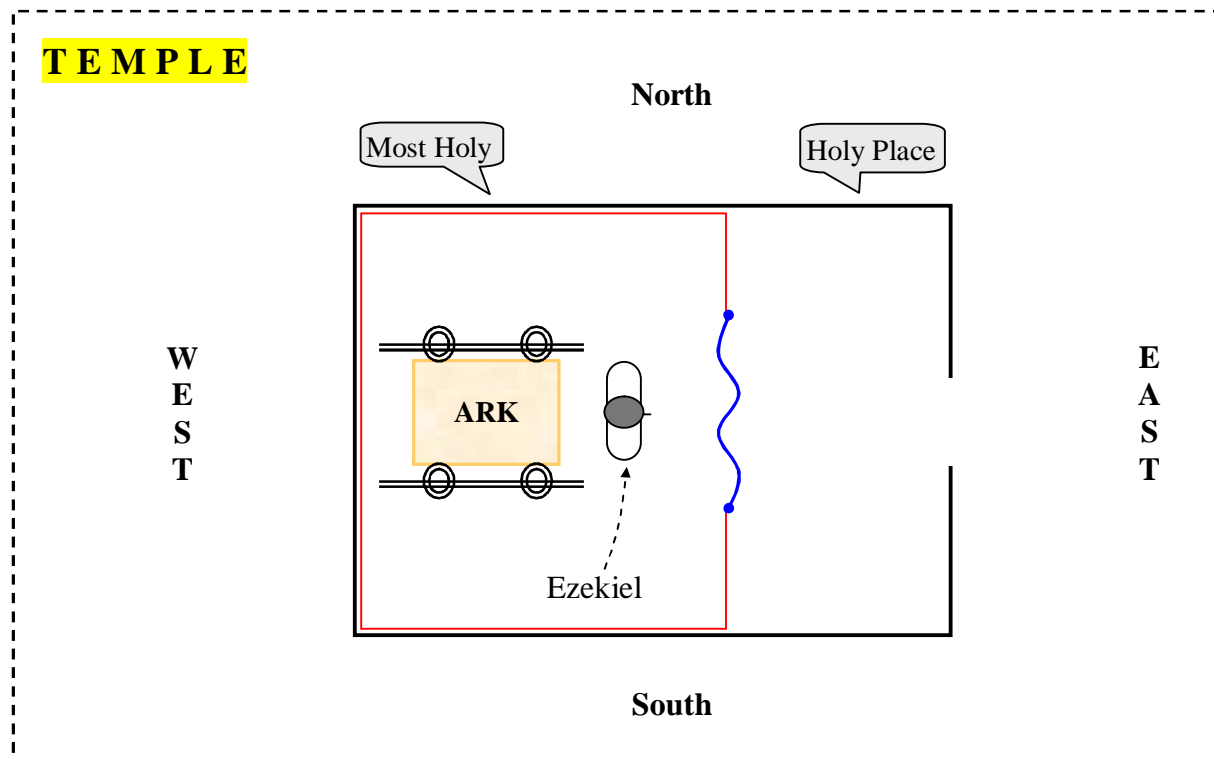

Figure 4. Temple of Solomon²⁴

It is indisputable that Ezekiel was physically in his home when he lay on his side for 430 days, but he then was portraying the siege that was going on in the Temple of Solomon. With that in mind it is natural to symbolically represent Ezekiel in the Temple²⁵, the intended location of his action.

To help us analyze this siege we need a small artifice. We are going to borrow some of the features of Moses' Tabernacle and transpose them into Solomon's Temple; they will occupy the same position. Can we do that? Yes. Remember that Ezekiel's action is highly symbolic; it is a sign²⁶. Surely we are allowed some digression as long as it helps us understand the message we are being told.

N.B. The Tabernacle of Moses and the Temple of Solomon are two different structures sharing an identical design conceived by God.²⁷ Every piece of furniture found in them have a counterpart in the Heavenly Throne of God and occupy a very specific location in the design. To transpose them from one structure to the other²⁸ is not going to alter their symbolic value.

²³ Ezekiel was a priest. Ezek. 1:3 the word of the LORD came to Ezekiel the priest

²⁴ Of all the furniture found in Solomon's Temple only the Ark is shown here.

²⁵ Some years later Ezekiel was shown the future Temple. Ref : Ezek. 43:5 Then the Spirit lifted me up and brought me into the inner court, and the glory of the LORD filled the temple.

²⁶ Ezek. 4:3 This will be a sign to the house of Israel.

²⁷ Ezek. 43:11 make known to them the design of the temple-its arrangement, its exits and entrances-its whole design and all its regulations ... so that they may be faithful to its design

Before we continue with Ezekiel we need to alter our representation of the Temple of Solomon a little more and get closer to what it really looked like. The following representation is the subject of an entire paper, 'Secrets of the Holy Ark' by Tony Badillo²⁹.

According to Mr Badillo the plan of the whole floor of the Temple depicted a human body whose face was located in the Holy of Holies.

From Tony Badillo's paper we learn that:

- The two cherubims standing behind the Ark, represented the eyes of the face
- The Ark with its poles on each side was the nose and its two nostrils
- There were two protuberances³⁰ indented in the veil by the two poles
- There was a stair separating the Holy of Holies from the Holy Place (*This stair portrays the mouth of the Temple face YP*)
- The Golden Altar was at the bottom of the stair

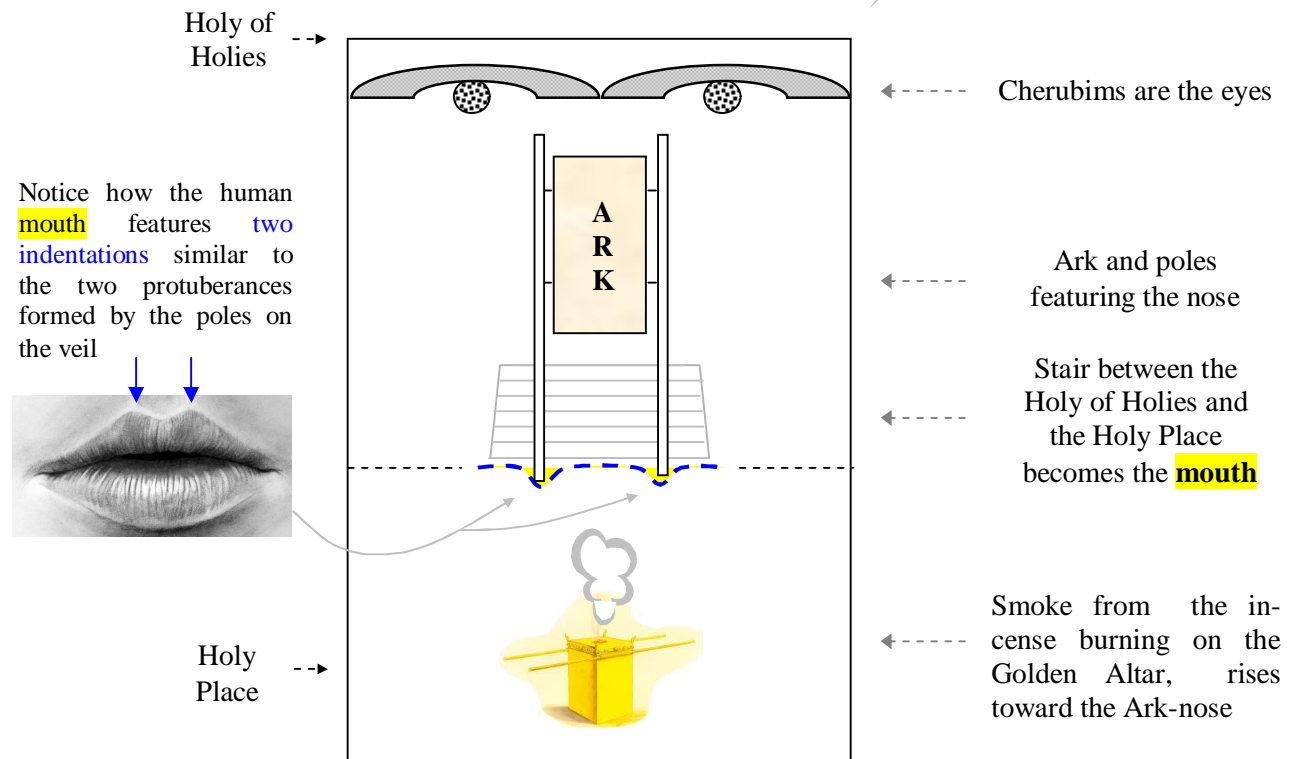
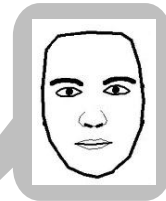

Figure 5 Temple Face

²⁸ The two structures are also directly linked to the 12 tribes of Israel. The Tabernacle of Moses was created at the start of the Exodus; it was eventually replaced by Solomon's Temple which lasted until all the 12 tribes had finally been sent into captivity.

²⁹ Use a search engine like Google.com to do a search with the following keywords:

Ark of the Covenant Secrets badillo

³⁰ 1 Kings 8:8 These poles were so long that their ends could be seen from the Holy Place in front of the inner sanctuary, but not from outside the Holy Place;

WALL OF IRON

There is an aspect of Ezekiel's re-enactment (Ezek. 4) that has been quite puzzling and came as a complete surprise when I finally understood it. We first read that Ezekiel was told to draw 'carve' on a clay tile the city of Jerusalem (and its wall) and have all the military equipment needed for a siege leaned up against it:

- Ezek 4:1-2 You also, son of man, take a clay tablet and lay it before you, and portray on it a city, Jerusalem. Lay siege against it, **build a siege wall against it**, and heap up a mound against it; set camps against it also, and place battering rams against it all around. NKJV

And then we read this very unexpected statement:

- Ezek 4:3 Then **take an iron pan**, place it as an iron wall between you and the city and turn your face toward it.

If the tile with the carving of Jerusalem, the **city's wall** and the military apparatus, form a whole,

why was there a need to further add a **second wall** (the iron pan) between Ezekiel and that 'model siege' on the tile?

Ezekiel

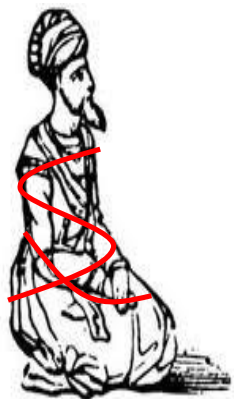

Iron pan



Tile



Ezekiel sketched the city of Jerusalem on a fresh newly made clay brick then he casted the material needed for a siege around it.

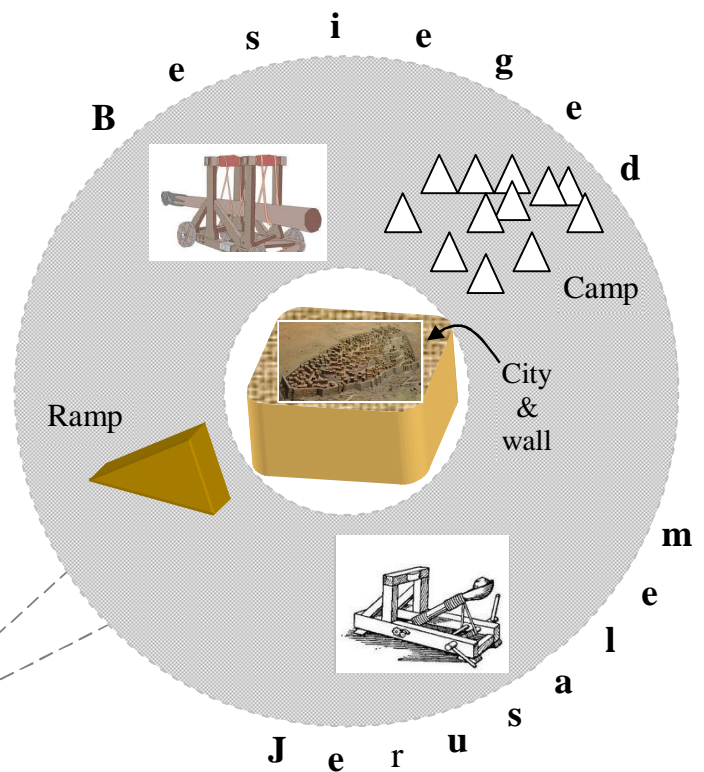

No matter how you look at it, **if** the iron wall (iron pan) was meant to be part of the military siege, it is wrongly located. But suppose the real purpose of the iron wall ('qiy'r') was to bring to mind a separation between two rooms (the Hebrew word 'qiy'r' refers to the internal or external wall of a house and has nothing to do with the wall of a city (chowmat))

Let's remember that although Ezekiel was physically lying in his home it was meant to represent him symbolically **lying in the Jerusalem Temple**. Doesn't this fact directly point to the real purpose of the 'iron pan'?

It is not an overstatement to say that the Temple's Holy of Holies was the most inaccessible location of Israel. The high priest was the only one to enter it and for a single day each year. However, the only thing that separated the most holy from the holy room was a **veil**. *Parochet*

- Ex 26:33 Hang the curtain from the clasps and place the ark of the Testimony behind the curtain. **The curtain will separate the Holy Place from the Most Holy Place**
- 2 Chron 3:14 He made the curtain of blue, purple and crimson yarn and fine linen, with cherubim worked into it.

That veil was as efficient as an IRON WALL.

Isn't it ironic that Ezekiel was told to use an 'IRON PAN' to represent the Temple's veil? Iron was among the hardest material to be found at the time of Ezekiel while the curtain offered hardly any resistance.

And there is more. Notice that Ezekiel was asked to turn³¹ his **face toward the iron pan** in front of him. By doing this he was portraying the **Temple's face**, in front of the **veil**, as depicted³² by the furniture in the Holy of Holies.

Notice also that during his siege Ezekiel was **tied up** in front of the **iron pan** (representing the veil). Isn't it quite appropriate that the **veil** separating the Holy of Holies from the Holy Place was crisscrossed with **gold chains**?

- 1 Kings 6:21 Solomon covered the inside of the temple with pure gold, and he extended gold chains across the front of the inner sanctuary, which was overlaid with gold.

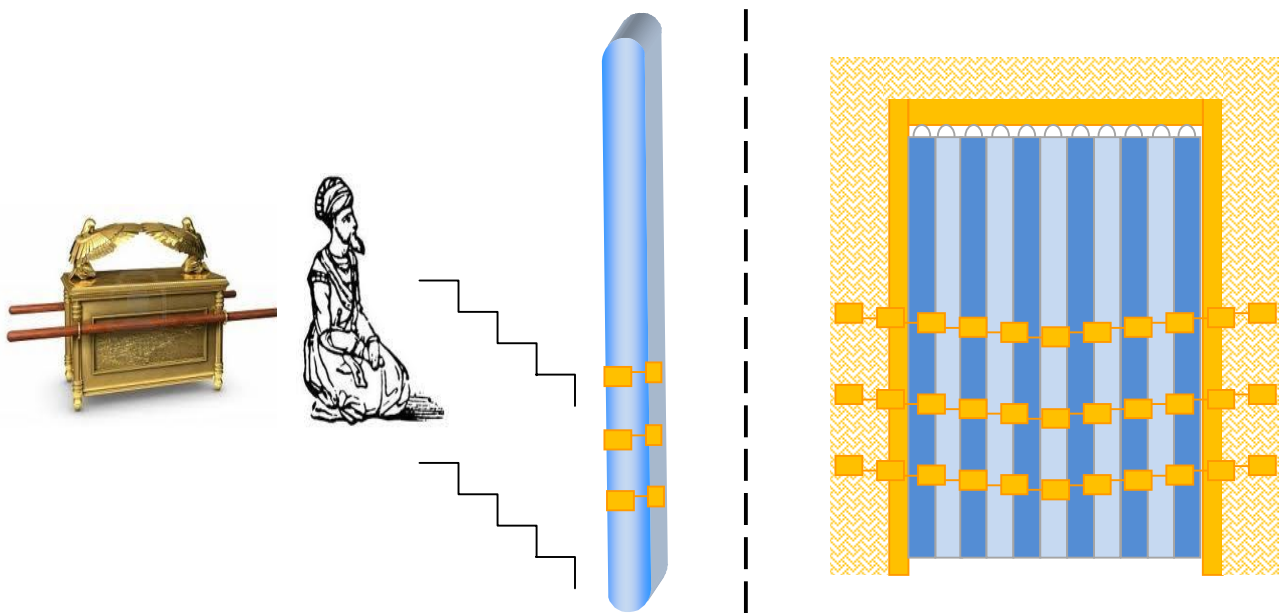

³¹ Ezek 4:3 Then take an iron pan, place it as an iron wall between you and the city and turn your face toward it.

³² See page 34 about the Temple's floor plan and Tony Badillo.

Ezekiel went through a cleansing ritual

Even though there is no direct reference to support it, we do have here a strong indication that Ezekiel's action **was really intended to show what was going on in the Temple.**

No commentator seems to have noticed it but Ezekiel, just before lying on his side for 430 days, went through the cleansing ritual that he described in Ezek. 44:26-27. This ritual was prescribed to the priests **before they entered the Temple.**

Ezek. 44:26-27 After he is cleansed, ¹
they shall count seven days ²
for him. And on the day that he goes to the sanctuary ³
to minister in the sanctuary,
he must offer his sin offering ⁴
in the inner court," says the Lord GOD ⁵

God's house

Now see how Ezekiel fulfilled each point:

1 Ezek. 2:1-3 Then **the Spirit entered me** when He spoke to me, and set me on my feet; and I heard Him who spoke to me. And He said to me: "Son of man, I am sending you to the children of Israel,

Ezek. 3:3 "Son of man, eat this scroll I am giving you and fill your stomach with it." So I ate it, and **it tasted as sweet as honey** in my mouth.

2 Ezek. 3:15 Then I came to the captives at Tel Abib, who dwelt by the River Chebar; and I sat where they sat, and remained there **astonished among them seven days.**

Ezek. 3:24 Then the Spirit came into me and raised me to my feet. He spoke to me and said: "**Go, shut yourself inside your house.**

3 Note: Just before that, Ezekiel had been in the presence of the Glory
Ezek 3:23 And the glory of the LORD was standing there... and **I fell face down**

4 Ezek. 4:10 Weigh out twenty shekels of food to eat each day and eat it at set times.

Ezek. 4:3 Then take an iron pan, place it as an iron wall between you and the city.

5 *The iron pan represents the veil and given that the pan was between Ezekiel and the city, Ezekiel's action put him symbolically in the Holy of Hollies.*

We have here Ezekiel in his symbolic location with all the Temple's features in place

TEMPLE

composite

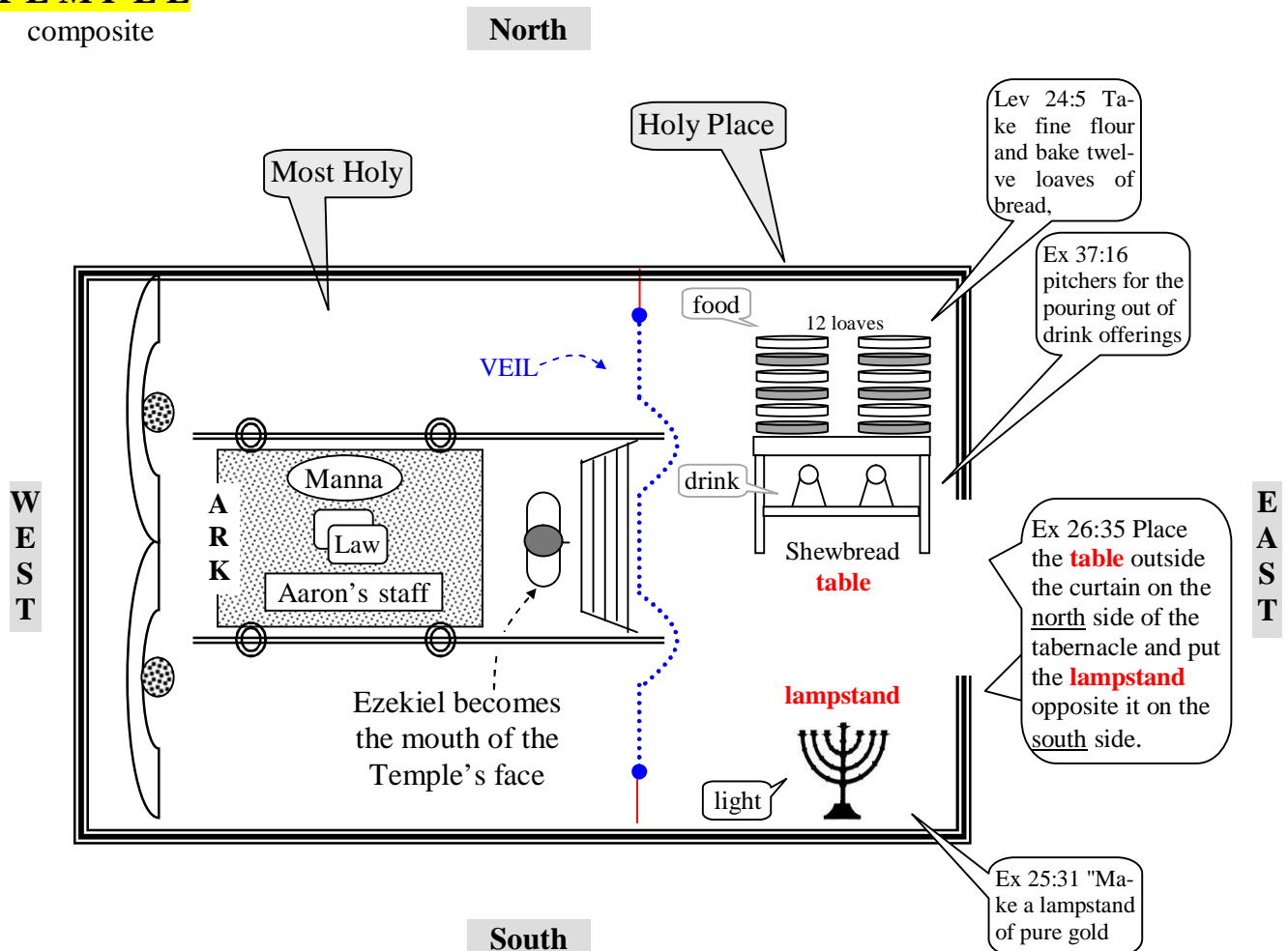

Notice that Ezekiel stands in front of the curtain, at the top of the stair, exactly where the ‘**Temple’s mouth**’ (see Temple Face on page 34) happens to be. This detail is of some importance given the number of times Ezekiel had previously been warned about speaking when it would be time:

Ezek 2:4 I am sending you to them, and you shall say to them ... NKJV

Ezek 2:7 You shall speak My words to them, NKJV

Ezek 3:1 "Son of man, eat what you find; eat this scroll, and go, speak to the house of Israel."

Ezek 3:4 "Son of man, go to the house of Israel and speak with My words to them.

Ezek 3:11 and speak to them and tell them, 'Thus says the Lord GOD,'

Ezek 3:26 I will make your tongue cling to the roof of your mouth ...

It is very meaningful to have Ezekiel (the “**Prophet**” of YHWH) the future Watchman of Israel (Ezek 33:7) becoming the **mouth** of the Temple’s face.

LEFT SIDE / RIGHT SIDE

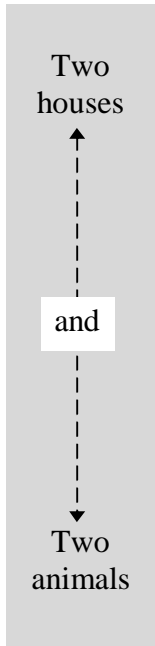

The house of Israel represented the 12 tribes and, since the 390 years of sin is attributed to the house of Israel (not the kingdom of Israel), the 390 years of sin involved the 12 tribes. The house of Israel was somewhat under the leadership of Joseph's son Ephraim, who was blessed profusely by Jacob:

Jer 31:9 For I am a Father to Israel, And Ephraim is my firstborn. NKJV

Ephraim is associated with a calf (a bull, an ox):

Jer 31:18 "I have surely heard Ephraim's moaning:
'You disciplined me like an unruly calf,

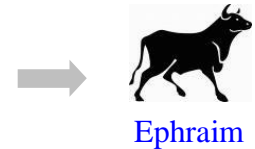

The house of Judah represented the tribes of Benjamin and Judah, since the 40 years of sin is attributed to the house of Judah, the 40 years of sin involve only those two tribes. The tribe of Judah assumed leadership of the house.

Judah is associated with a lion:

Gen 49:9 You are a lion's cub, O Judah;

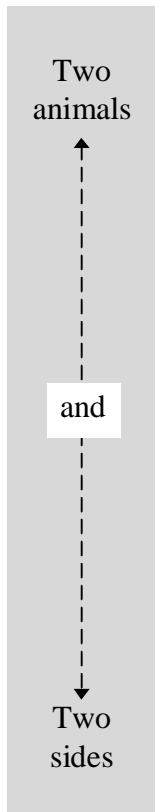
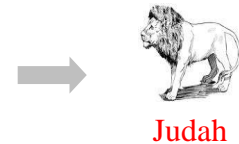

At the beginning of Ezekiel a creature with four faces was seen. This creature gives us the key to understand why the left side was attributed to the house of Israel and the right side to the house of Judah:

- Ezek 1:10 Their faces looked like this: ... and on the **right** side each had **the face of a lion**, and on the **left** the face of an ox;

Notice that the left side is associated with a grazing animal (bull, cow, calf) whose distinctive feature is the activity of its **mouth**. However, for obvious reasons, the distinctive feature of the lion, associated with the right side, is its **head** (crowned with a mane, a symbol of majesty).

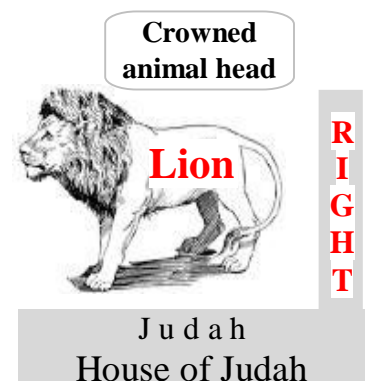
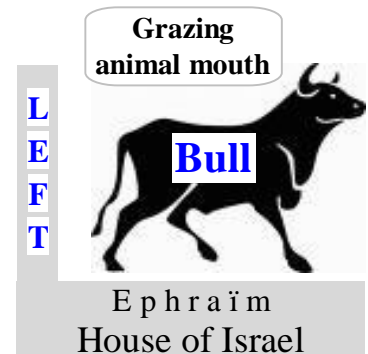

Note: The ancient usage of such terminology was based upon the proposition that one faced the East (the rising sun); and thus the left stood for the North, the right stood for the South; and the East was always considered "the front." Since Northern Israel (Samaria) lay north of Jerusalem, the "right" and "left" designation applied to the Ten Northern tribes and to Judah, respectively. See Coffman's Commentaries on the Bible

Ezekiel is lying on his left side for 390 days

For the first 390 days of his siege's re-enactment Ezekiel was lying on his left side:

- Ezek 4:5 For I have laid on you the years of their iniquity, according to the number of the days, three hundred and ninety days; so you shall bear the iniquity of the house of Israel. NKJV

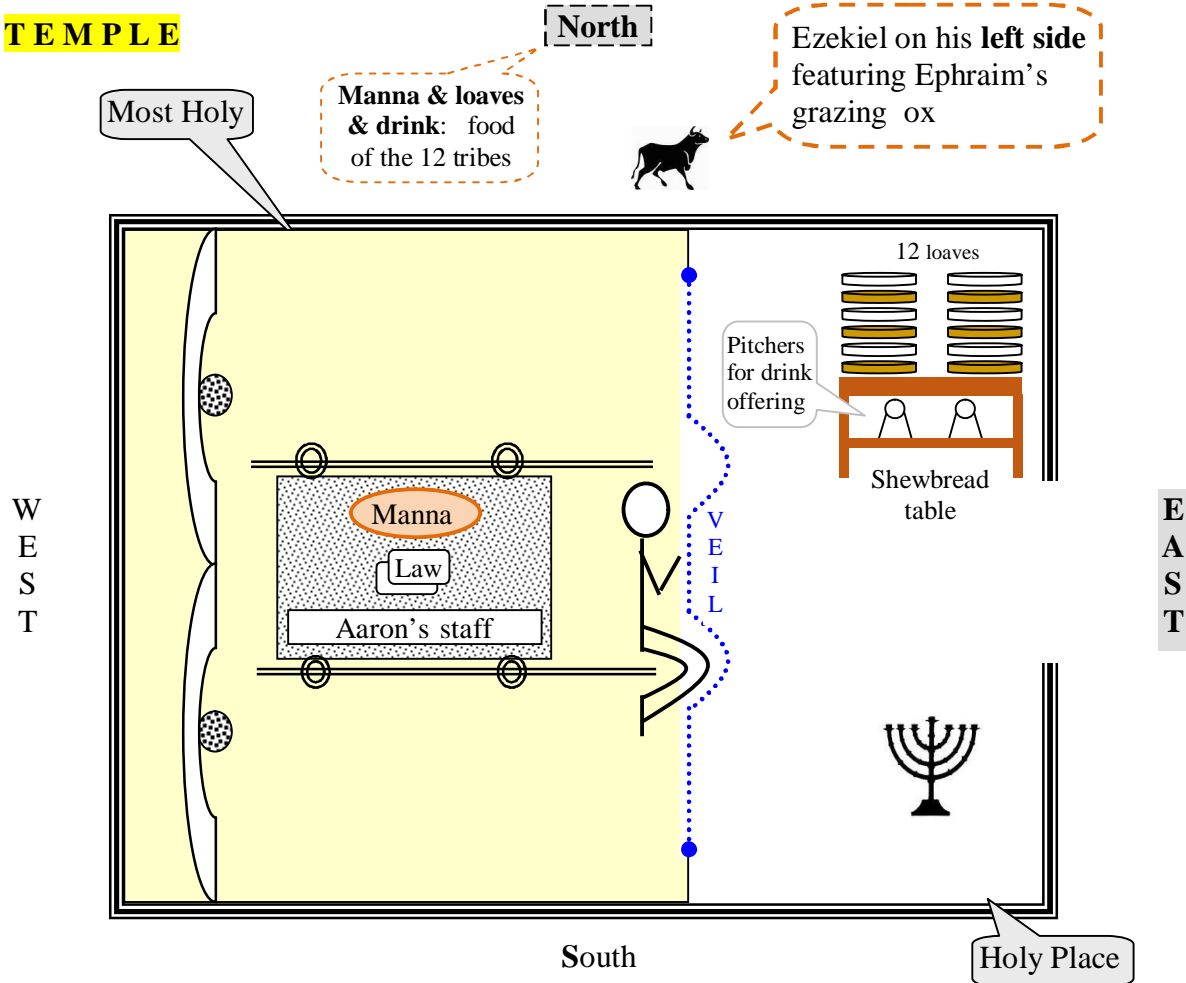

Figure 6. Ezekiel on his left side for 390 days (mouth toward north)

Notice: Ezekiel's **mouth**³³ on the north side with 'the food' of the temple

The first 390 days of Ezekiel's siege are characterized by his access to food³⁴ & water.

- Ezek 4:9-10 Take wheat and barley, beans and lentils, millet and spelt; put them in a storage jar and use them to make bread for yourself. You are to eat it during the 390 days you lie on your side.
- Ezek 4:11 1 Also measure out a sixth of a hin of water and drink it at set times. NIV

The two items³⁵ on the north side (borrowed from the Tabernacle) are related to **food** and characterize the **12 tribes** as abundantly blessed by God..

³³ The 'mouth' is the distinctive feature of the grazing ox representing Ephraim.

³⁴ There is no mention of food in the second part of Ezekiel's siege (40 days). This will be discussed later.

³⁵ Manna food of the 12 tribes at Exodus. And the 12 loaves representing the 12 tribes.

Ezekiel is lying on his right side for 40 days

For the second part of his siege, the last 40 days, Ezekiel was lying on his right side:

- Ezek 4:6 "After you have finished this, lie down again, this time on your right side, and bear the sin of the house of Judah.

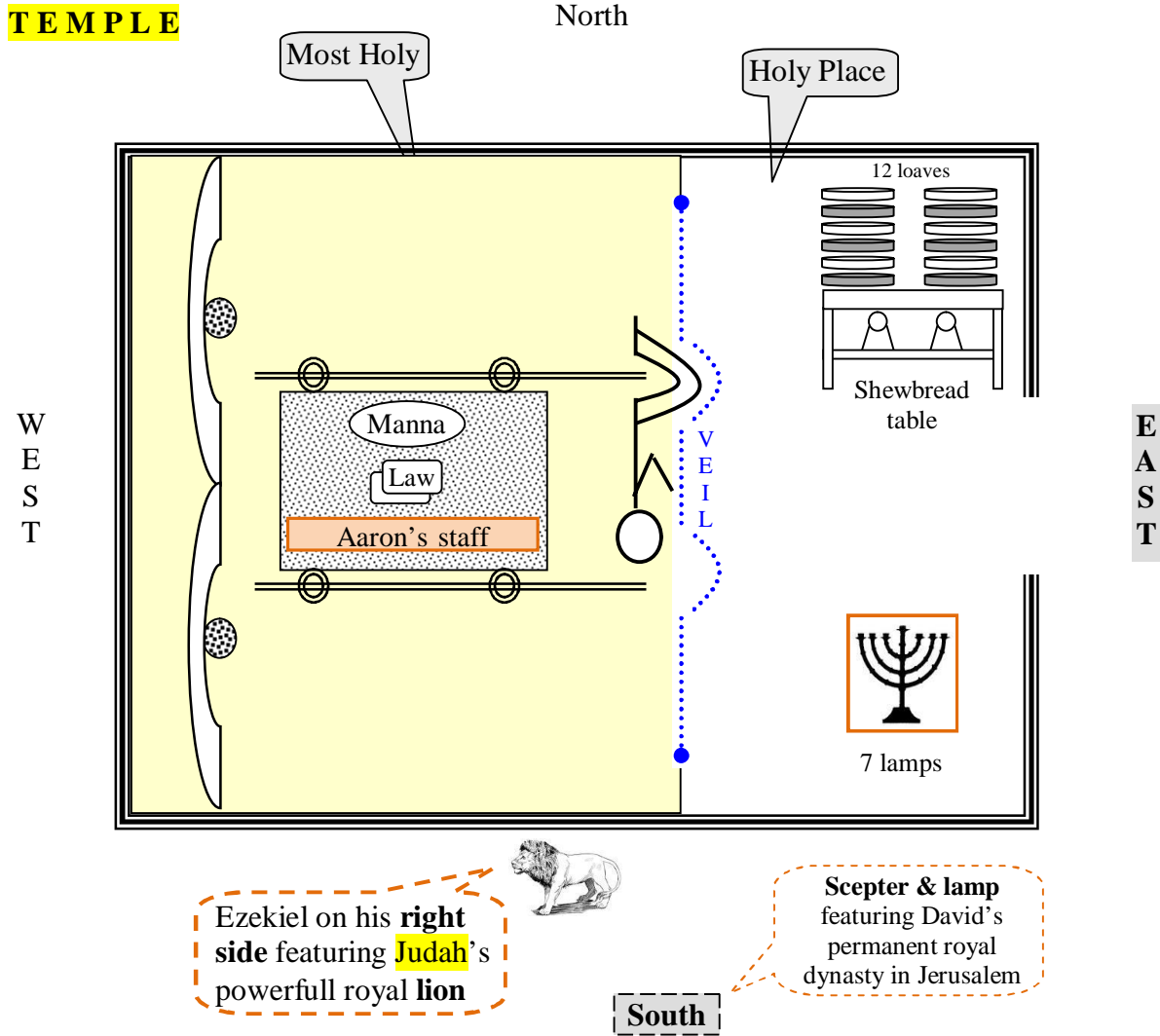

Figure 7. Ezekiel on his right side for 40 days (head toward south)

Ezekiel's head³⁶ on the south side with the Temple's objects symbolizing 'authority'.

Notice: Ezekiel was not fed during the 40 days and as we should expect there is no trace of food on the south side.

³⁶ The 'head', is the distinctive feature of the crowned lion representing Judah.

The two items on the south side (borrowed from the Tabernacle) characterize Judah³⁷ as a guide.

The STAFF

Stands for the rule of law (scepter) and can be associated with governmental and legal power.

- Gen 49:10 The scepter will not depart from Judah

Sceptre emblem and sign of power

Lamp = Monarch
2 Sam 1:17



The LAMP

- 1 Kings 11:36-37 I will give one tribe to his son so that David my servant may always have a lamp before me in Jerusalem, the city where I chose to put my Name.
- 2 Kings 8:19 Nevertheless, for the sake of his servant David, the LORD was not willing to destroy Judah. He had promised to maintain a lamp for David and his descendants forever.

Judah had to keep the scepter and by association, the law.

The start of the 40 years of sin is directly connected with the abandoning of the law:

- 2 Kings 21:8-9 if only they will be careful to do everything I commanded them and will keep the whole Law that my servant Moses gave them." But the people did not listen. Manasseh led them astray,

The end of the 40 years of sin came with the rediscovery of the book of the law:

- 2 Kings 22:3,11 In the eighteenth year of his reign, King Josiah ... When the king heard the words of the Book of the Law, he tore his robes.

During the 390-year period of sin the Ark was under the care of the 12 tribes whose leadership was assumed (symbolically) by Ephraim. The **symbol of Ephraim is an ox**.

At the end of the 390 years of sin the Ark was removed from the house of Abinadab³⁸ and David attempted to bring it to Jerusalem by putting it on a cart that was drawn by **oxen**. It was a failure and the Ark was left at the house of Obed-Edom.

Three months later the Ark was successfully brought to Zion. This time the Ark was carried on the Levites' shoulders while they were following King David, a man crowned like a **lion**³⁹ (**Judah's symbol**).

The Ark coming to Jerusalem marks the end of Israel 390-year of sin

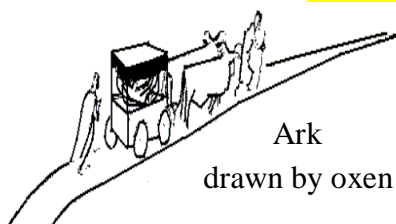

Ark drawn by oxen

3 months later



Ark on Levites shoulders following David, the Lion-king of Judah

³⁷ According to Jacob's blessings (Gen 49:10) Judah is forever a ruler.

³⁸ See 2 Sam 6:3

³⁹ The Ark went from the Ox to the Lion, another way to show that it was leaving Ephraim to come to dwell in Judah.

We have already seen many small details to back up our deduction that Ezekiel's performance was meant to be set in the Temple (although it was physically held in his home). Here is a final piece of evidence to strengthen this conclusion.

Prior to going to his house for 430 days, Ezekiel was engulfed in a celestial vision of the Lord's throne (or celestial Temple). At one point in this vision, while he was (A) in the Lord's dwelling place, Ezekiel heard from (B) behind him the noise of flapping (D) wings belonging to (C) four living creatures:

- Ezek 1:5 Also from within it came the likeness of **four** living creatures. NKJV
- Ezek 3:12-13 Then the Spirit lifted me up, and I heard **behind** me a great thunderous voice: "Blessed is the glory of the LORD from **His place!**" **I also heard the noise of the wings** of the **living creatures** that **touched one another**, NKJV

Now, with the description of Ezekiel's vision in mind, let's see how each element of that vision can also be found in the Temple's composite that became Ezekiel's symbolic surroundings while he was lying in his own house.

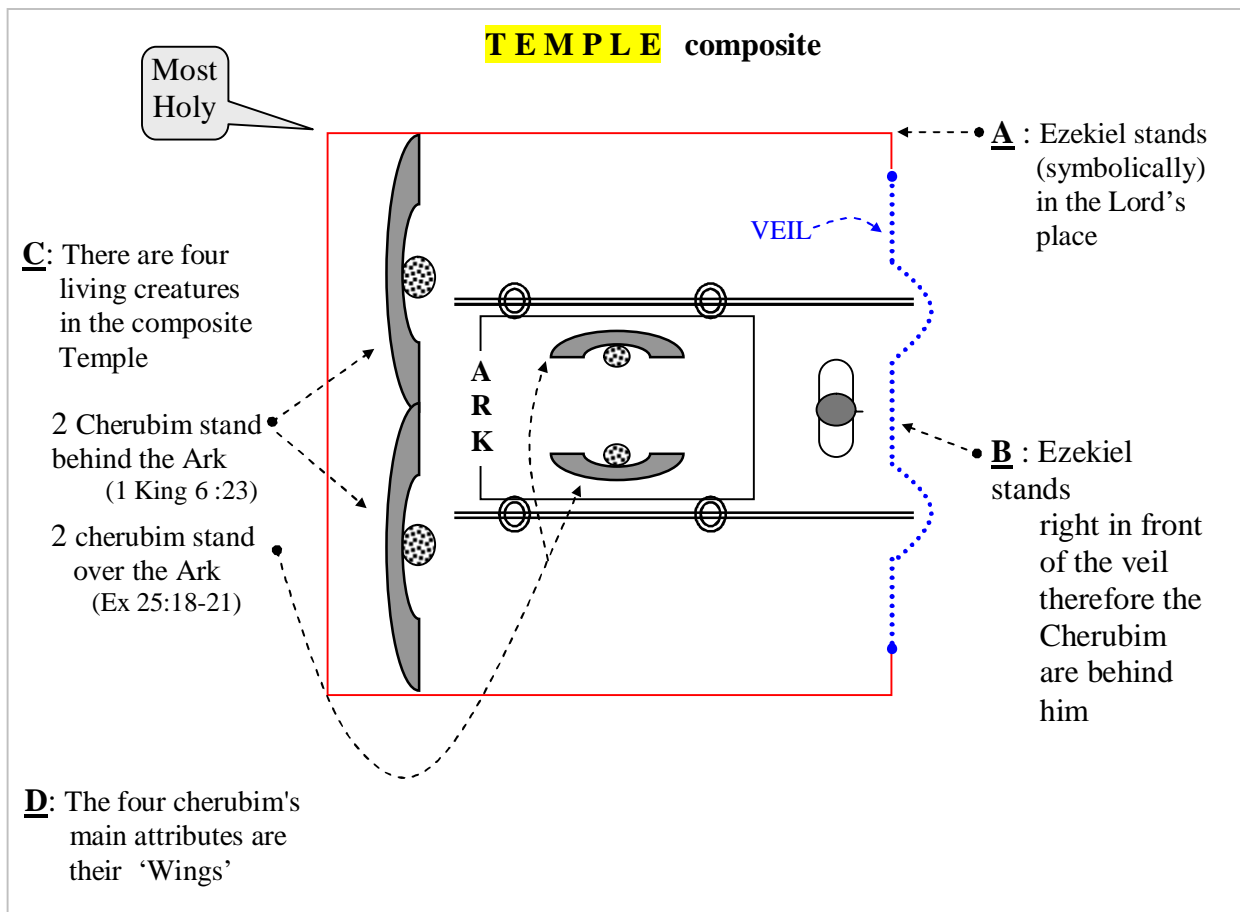

Can there be any doubts left when so many pieces point in the same direction?

A period of feeding and a period of no feeding

A major difference between the two periods enacted by Ezekiel, while laying on his sides, has to do with food. For the first 390 days he was told to eat some food, which was not the case for the following 40 days⁴⁰. It is strange, isn't it? Why was Ezekiel not offered any food during the 40 days he was lying on his right side? No doubt Ezekiel had had access to an adequate supply of food; he had filled the jar himself at the beginning of the first period:

- Ezek. 4:9 "Take wheat and barley, beans and lentils, millet and spelt; put them in a storage jar and use them to make bread for yourself.

His access to all the water he wanted is even more obvious. Ezekiel was asked to measure it just before he drank it, but nowhere was he told that he had to stock it:

- Ezek 4:11 Also measure out a sixth of a hin of water and drink it at set times.

It is clear that God instructed Ezekiel to eat in the 390 days⁴¹ of the first period and not in the following 40 days⁴², even though, as I believe, there was food and water available. There is only one word that can give light to the whole situation: FASTING.

40 days of fasting for the sin of Judah

This is a very interesting thought and it becomes quite convincing when we realize that the food on the first 390 days had a **dual purpose**. It was used to feed Ezekiel - he wouldn't have survived without food - but its main purpose was to be used as a SIN OFFERING.

A sin offering offered 390 times for the sin of Israel

According to Lev 5:11-13 a sin offering couldn't have any oil and it was given to a priest. Ezekiel, a priest, didn't put any oil in his food. Notice also that Ezekiel had to eat at 'set time', as if he was following a ritual.

- Ezek 4:9 "Take wheat and barley, beans and lentils, millet and spelt; put them in a storage jar and **use them to make bread** for yourself.
- Ezek 4:10-11 And your food which you eat shall be by weight, twenty shekels a day; **from time to time** you shall eat it.

Ezekiel's food (sin offering) was corrupted when it was cooked over dung (Ezek 4:12-13). Unsurprisingly the 390 years period associated with it was also characterized by corruption:

- Hos 9:9 They have sunk deep into corruption, as in the days of Gibeah.

There is much more to say about the 390 days of food and the 40 days without any. We will see later how Ezekiel's food become some major symbolic acts.

Ref: Ezekiel ate defiled food for 390 days: Page 67 & Ezekiel fasts during 40 days: page 134

⁴⁰ In order for Ezek 4:17 to say that the people would be going to lack bread and water, Ezekiel had to portray a period while having for himself 'bread & water' and another period during which he himself lacked 'food & water'.

⁴¹ Have you noticed that while on his left side, the side associated with the grazing animal, Ezekiel cooked his food (Eze 4:15) over a fire fueled with cow manure?

⁴² Another interesting fact: the left side is associated with grazing animals who feed and drink most of the time. Ezekiel on his left side had access to food and water every day. It was not the case when he turned on his right side and had to fast for 40 days. And what was the animal associated with the right side? A lion, a hunting animal that could go days without food and water.

What was the motive to bind Ezekiel for 430 days?

- Ezek 4:8 I will tie you up with ropes so that you cannot turn from one side to the other until you have finished the days of your siege.

It is obvious in Eze 4:8 that Ezekiel was physically tied⁴³ for the whole 430 days (390 + 40) of his siege. But to be tied for 430 days is an awfully long time and we should seek an hidden meaning behind this very harsh treatment. Why did it have to be done that way? Was God afraid that Ezekiel wouldn't hold his position on each side and therefore needed to be tied? Absolutely not, Ezekiel was a priest whose entire life had been devoted to God.

- Ezek 4:14 Then I said, "Not so, Sovereign LORD! I have never defiled myself. From my youth until now I have never eaten anything found dead or torn by wild animals. No unclean meat has ever entered my mouth."

He didn't weep or lament when he lost his wife because he was told not to do so:

- Ezek 24:18 So I spoke to the people in the morning, and in the evening my wife died. The next morning I did as I had been commanded.

If the ropes were not used to force Ezekiel to obey then we have to conclude that they were used for a symbolic purpose. It is said in Ezek 4:8 that the prophet could not turn on the other side before the right time. Thus Ezekiel was first portraying somebody tied for 390 days and then someone tied for 40 days. A two parts symbolic act that brought freedom at the end. Without surprise the Bible has nothing to say about anybody that could have been tied for 430 years (390 + 40). But then, did we correctly understand what was meant by the rope symbol?

What if the ropes that were put on Ezekiel were not meant to symbolize somebody tied? What if those ropes were no more than an artifact used to symbolize somebody held prisoner? Wasn't the binding of Ezekiel the proper way to symbolically represent somebody confined in a specific location? (Keep in mind that Ezekiel was confined in his house for the whole duration of this ordeal)

- Ezek 3:25 And you, son of man, they will tie with ropes; you will be bound so that you cannot go out among the people.

If we are right about this we should be able to find an important individual who had been in prison for 430 days⁴⁴ and did recover his freedom at the end of a siege. Don't we have the perfect candidate in the person of Jeremiah the prophet?

- Jer 38:6 So they took Jeremiah and put him into the cistern NIV
- Jer 38:28 Now Jeremiah remained in the court of the prison until the day that Jerusalem was taken.

⁴³ The reader is already aware that Ezekiel was **tied** in front of an iron wall which symbolised the veil of the Holy of Holies. That veil was also criss-crossed by **chains**. See discussion on Iron Wall on page 36.

⁴⁴ in this context we discard a 430-year period as it wouldn't make any sense

Ezekiel lying on his left and right sides while being tied up	
430 days	
390 days	40 days
food	no food

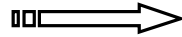

Jeremiah's imprisonment	
430 days ?	
390 days ?	40 days ?
Feed with bread	No food / not feed

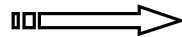

In a cistern
Jer 38:6

In the prison's yard
Jer 38:13,28

Ezek 4:8 I will tie you up with ropes so that you cannot turn from one side to the other until you have finished the days of your siege. NIV

Jer 38:6 They lowered Jeremiah by **ropes** into the cistern

Jer 38:13 So they drew up Jeremiah with cords, and took him up out of the dungeon: and Jeremiah remained in the court of the prison. KJV
Jer 38:28 So Jeremiah abode in the court of the prison until the day that Jerusalem was taken: and he was there when Jerusalem was taken. KJV

Jeremiah's story doesn't specify that he was held prisoner exactly 430 days but a careful reading of the book of Jeremiah and an understanding of the sequence of events surrounding Nebuchadnezzar's siege against Jerusalem, do strengthen this belief. **Furthermore** Jeremiah was held captive in **two different locations**. First in a **cistern** in which he was **feed** (Jer 37:21) every day, then in the **court of the prison** at a time where there was **no more food** in the city (Jer 38:9)

The timeline of Jeremiah's actions

- #1. Nebuchadnezzar attacked Jerusalem in Zedekiah's 9th year, 10th month, 10th day. (This is **about 560 days** before Jerusalem was captured in the 11th year, 4th month, 9th day of Zedekiah): See Jer 52:4 and 2 Kings 25:1
- #2. While Jerusalem and a few other cities were still resisting, Jeremiah told King Zedekiah that he and the city would be captured but the King would die peacefully: (Jer 34:2-7). Zedekiah made a covenant to free all the slaves (Jer 34:8-9). Then **Nebuchadnezzar ended the siege of Jerusalem** (Jer 37:5). The King didn't maintain the covenant and everybody took back their slaves: (Jer 34:11, Jer 34:16). Jeremiah announced that Nebuchadnezzar would be back (Jer 34:21-22, 37:7-8)

IN PRISON -----

- #3. Jeremiah wanted to leave Jerusalem but was arrested and accused of trying to join the then leaving Babylonian army (Jer 37:4, 37:11-12, 37:15-16).
- #4. As prophesied earlier (see #2) the Babylonian army came back.
- #5. King Zedekiah who was worried about what was going to happen to him, had Jeremiah brought to the palace for questioning: See Jer 37:17. Jeremiah was fearing for his life in the dungeon (Jer 37:20-21). While a prisoner Jeremiah bought a field (Jer 32:1-3, 32:6-7)

#6. Turning point No more bread -----

Zedekiah inquires from Jeremiah (Jer 21:1-2) and was told about the imminent destruction of Jerusalem (Jer 21:7, 38:2). Pashur and his men had previously lowered Jeremiah in a dungeon (cistern) to kill him (Jer 38:6). The Cushite Ebed-Melech rescued Jeremiah after telling the King that Jeremiah would die if he was kept in the dungeon since **there was no more bread in the city:**

- Jer 38:9 ... For there is no more bread in the city." NKJV

#7. With the bread gone, the famine started.

- Ezek 4:16-17 Son of man, surely I will cut off the supply of bread in Jerusalem; they shall eat bread by weight and with anxiety, and shall drink water by measure and with dread, that they may lack bread and water, and be dismayed with one another,
- Lam 4:9 Those killed by the sword are better off than those who die of famine; racked with hunger, they waste away for lack of food from the field.
- Lam 2:20 Should women eat their offspring, the children they have cared for?

#8. People dying everywhere. The food was completely gone, the wall was broken and the city was captured:

- Jer 52:6 By the **ninth day of the fourth month** the famine in the city had become so severe that there was no food for the people to eat
- Jer 38:28 Now Jeremiah remained in the court of the prison until the day that Jerusalem was taken. And he was there when Jerusalem was taken.
- Jer 39:2 In the eleventh year of Zedekiah, in the fourth month, on the ninth day of the month, the city was penetrated.

Given that the length of Ezekiel's siege is divided into two periods of time (390 and 40 days), we can speculate that Jeremiah's stay in prison was also divided in a similar way.

E Z E K I E L	3 9 0 days	<p>During the first 390 days Ezekiel had access to food</p> <ul style="list-style-type: none"> Ezek 4:9 "Take wheat and barley, beans and lentils, millet and spelt; put them in a storage jar and use them to make bread for yourself. You are to eat it during the 390 days you lie on your side 	o n h i s s i d e s
	Turning point (Ezekiel starts fasting)		
	4 0 days	<p>During the following 40 days Ezekiel was fasting (already discussed in this work)</p>	

In each case the turning point is related to **food**.

J E R E M I A H	3 9 0 days ??	<p>In the first part (points #3, #4, #5 of the previous chronology of Jeremiah) there was food in Jerusalem and we are told that Jeremiah received his daily bread:</p> <ul style="list-style-type: none"> Jer 37:21 King Zedekiah then gave orders for Jeremiah to be placed in the courtyard of the guard and given bread from the street of the bakers each day until all the bread in the city was gone. 	In the C I T Y R E N then in the Y A R d
	Turning point (No more bread)		
	4 0 days ??	<p>In the second part (points #6, #7, #8) the famine progressed in the city.</p> <p>This period started when Jeremiah was put in a dungeon and the King was told that there was no more bread in the city:</p> <ul style="list-style-type: none"> Jer 38:9 and he is likely to die from hunger in the place where he is. For there is no more bread in the city." NKJV <p>At the end of the period (which corresponds to the end of Jeremiah's imprisonment) there is no more food in the city:</p> <ul style="list-style-type: none"> Jer 52:6 By the ninth day of the fourth month the famine in the city had become so severe that there was no food for the people to eat. <p>We know that this period had to be short (40 days?); point #7 describes the terrible conditions that prevailed in the city once the food started to become scarce.</p>	

As mentioned a few pages back we won't find in Jeremiah's writing any confirmation that his imprisonment lasted exactly 430 days and it was divided into an initial period of 390 days followed by a period of 40 days. **We got those numbers by recognizing in Ezekiel's binding a symbolic reference to Jeremiah's imprisonment.** Nevertheless, not having a direct statement from Jeremiah about those numbers doesn't mean he left us clueless.

We are told that Jeremiah was arrested during the period of Nebuchadnezzar's interrupted siege (see #3 earlier). We are also told that the people abandoned the covenant they had made when they realized that Nebuchadnezzar was not threatening them anymore. This betrayal of the covenant led to the return of Nebuchadnezzar, which in turn led King Zedekiah, in the 10th year of his kingship, to consult Jeremiah.

All those events happened in a short time and given that we are told that King Zedekiah met Jeremiah sometime in the 10th year of his Kingship⁴⁵, we know they all happened between the 480th and the 98th day before the capture of Jerusalem⁴⁶.

Fixing Jeremiah's whole imprisonment to 430 days
is in agreement with 'between 480 and 98 days'.

The famine that prevailed toward the end of Nebuchadnezzar's siege started when the bread became unavailable and ended when the food was gone completely. This progression couldn't have evolved in just a few days; it had to last several weeks. Indeed, Ezekiel implied that the famine would be progressive:

- Ezek 5:16 I will bring more and more famine upon you and cut off your supply of food.

Another important fact about this famine is that one third of the population died from starvation and sickness:

- Ezek 5:12 A third of your people will die of the plague or perish by famine inside you

Before they started dying from starvation the people had been desperately eating any possible scrap of food they found. In the end they even ate their own flesh (see #7). We shouldn't doubt that it must have taken weeks of privation and starvation before they persuaded themselves to do such a terrible thing:

- Ezek 4:17 They will be **appalled at the sight of each other** and will waste away because of their sin.
- Lam 4:9 Those killed by the sword are better off than those who die of famine; racked with hunger, **they waste away for lack of food** from the field.

Fixing Jeremiah's second part of imprisonment to 40 days
is in agreement with the progression of the famine just described.

⁴⁵ Jer 32:1 This is the word that came to Jeremiah from the LORD in the tenth year of Zedekiah king of Judah, which was the eighteenth year of Nebuchadnezzar.

⁴⁶ Not knowing in what part of the 10th year of Zedekiah those events took place we use the earliest (First day of the 10th year) and the latest (last day of the 10th year). Zedekiah was captured in the fourth month of his 11th year.

Prophecy against the siege of Jerusalem

- Ezek 4:7 Therefore thou shalt set thy face toward the siege of Jerusalem, and thine arm shall be uncovered, and thou shalt prophesy against it. KJV

By using the words ‘**against it**’ the translators of Ezek 4:7 may have misled us into believing that Ezekiel was going to prophesy about (against) Nebuchadnezzar’s future siege of Jerusalem. This is doubtful that it was the purpose. What would he have accomplished by prophesying for 430 days about the coming destruction of Jerusalem? Who would have benefited from it? Ezekiel was confined in the privacy of his home where he might have been, as far as we know, alone most of the time.

Ezekiel was mute and he could not have prophesied with his words as he lay on his sides and looked at the sketch (a representation of Jerusalem under siege) he had drawn on a tile.

Therefore ‘his’ prophetising has to be attributed to his whole posture and to the time he spent on each of his side.

If the people who saw Ezekiel at that time perceived that he was prophetising, they didn’t know what it was about and it didn’t matter given that it was not done to inform them.

What nobody understood until now is the fact that Ezekiel’s prophesying was done as **an independent symbolic act**. In this particular case it was the act of ‘prophesying’ in itself that was used to reveal something hidden rather than the information that could have been heard by the people around.

T H E P R O P H E T

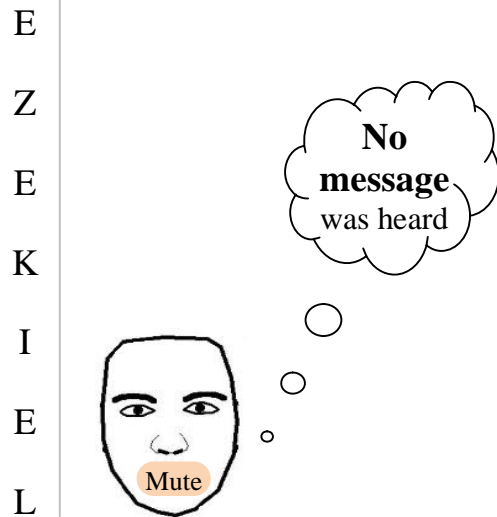

Similar to the other symbolic acts⁴⁷ that Ezekiel had performed during the period of 430 days, this new one was also done according to familiar pattern: during the first 390 days the prophet prophesied while lying on his left side (House of Israel), and during the following 40 days he prophesied while lying on his right side (House of Judah).

As we will see in the following pages, we can point to two different periods (**390 years and 40 years**) of Israel’s history during which prophetic communication was a major characteristic.

⁴⁷ Like lying on his sides, eating food, being tied.

390 years of prophecy for the House of Israel (North side)

In all likelihood the first period portrayed by “Ezekiel’s prophesying” starts with “Moses’ escapes from Egypt” and ends with the ‘capture of the Ark’.

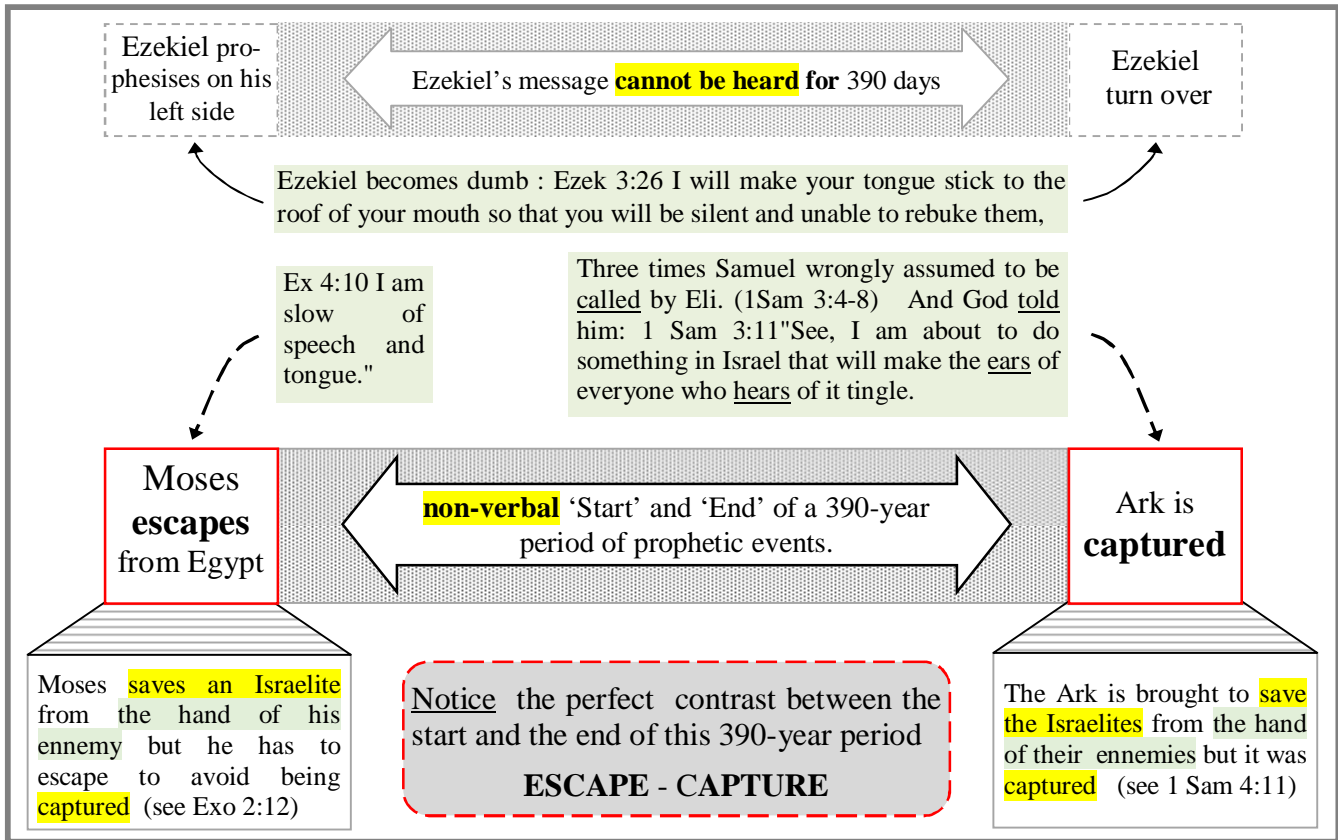

Escape from Egypt : Was Moses’ escape a prophetic event and does it qualify for the start of any period? The answer to both questions is yes. In fact, we will see that “Moses’ escape from Egypt” not only started ‘390 years of prophetic events’ it also marks the beginning of a series of events that went on for 40 years and whose echo can be heard during the next 40 years of Exodus. An appropriate way to view these first 40 years of what I call the ‘390 years of prophetic events’ would be to see them as the 40 years of **Moses’ phantom Exodus**.

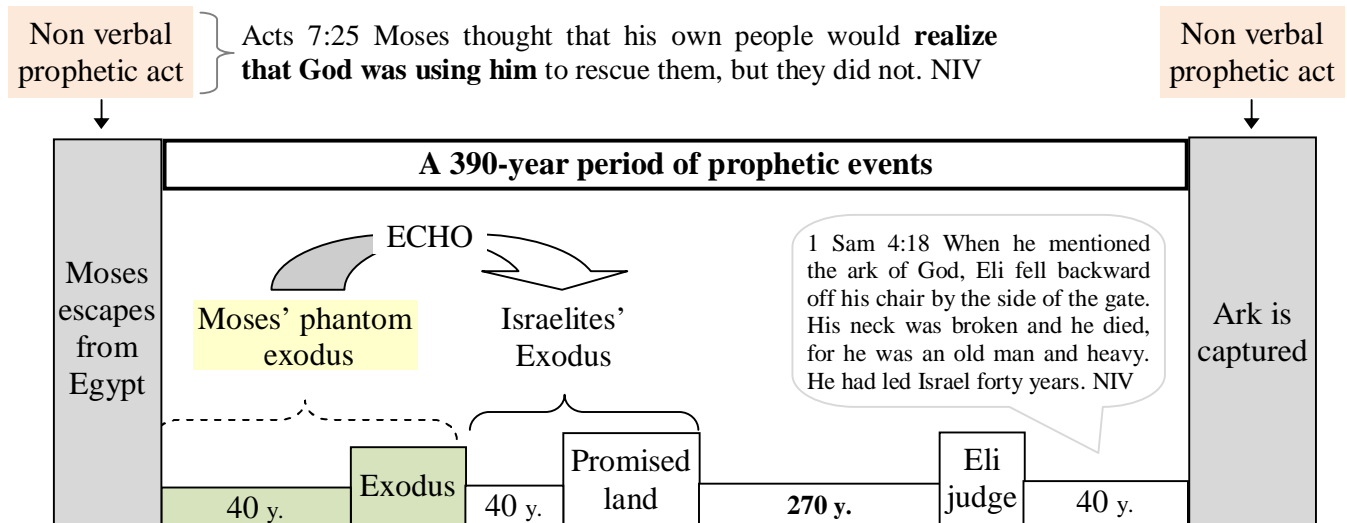

Here we have 10 events that took place during Moses' phantom exodus and are echoed during the Israelites' Exodus.

1 Moses sees his people's hardship:
Ex 2:11 and it came to pass in those days, when Moses was grown, that he went out unto his brethren, and looked on their burdens KJV

God see his people's hardship:
Ex 3:7 And the LORD said, I have surely seen the affliction of my people which are in Egypt, and have heard their cry by reason of their taskmasters; for I know their sorrows; KJV.

2 Moses rescues one Israelite:
Ex 2:11 and he spied an Egyptian smiting an Hebrew, one of his brethren. KJV

Moses rescues every Israelite:
Ex 3:10 and I will send thee unto Pharaoh, that thou mayest bring forth my people the children of Israel out of Egypt. KJV

3 Moses kills an Egyptian soldier and **'buries' him in the sand:**
Ex 2:12 he slew the Egyptian, and hid him in the sand. KJV

Moses would **'drown'** the whole Egyptian army **in the water:**
Ex 14:28 And the waters returned, and covered the chariots, and the horsemen, and all the host of Pharaoh that came into the sea after them; there remained not so much as one of them. KJV

4 Moses is told by an Israelite that he isn't his Judge:
Ex 2:14 Who made thee a prince and a judge over us? KJV

Moses becomes ruler and Judge over every Israelite:
Ex 18:13 And it came to pass on the morrow, that Moses sat to judge the people: and the people stood by Moses from the morning unto the evening. KJV

Pharaoh plans to kill Moses but he will never see him again:

5

Ex 2:15 Now when Pharaoh heard this thing, he sought to slay Moses.

Pharaoh [a different one] threatens Moses that he will kill him next time he sees him but they will never meet again:

Ex 10:28 And Pharaoh said unto him, Get thee from me, take heed to thyself, see my face no more; for in that day thou seest my face thou shalt die. KJV

Moses flees from Egypt to avoid being captured:

6

Ex 2:15 Now when Pharaoh heard this thing, he sought to slay Moses. But Moses fled from the face of Pharaoh, and dwelt in the land of Midian KJV

Moses helps all of Israel to flee from Egypt and regain their freedom:

Ex 12:31-33 ... Rise up, and get you forth from among my people, both ye and the children of Israel; and go, serve the LORD, as ye have said. .. And the Egyptians were urgent upon the people, that they might send them out of the land in haste; KJV

Note: Pharaoh authorized Israelites to take a three-day journey to worship their God. Pharaoh never authorized them to leave permanently. We can therefore say that Moses and all the Israelites escaped from Egypt.

Moses leaves Egypt and crosses a desert.

7

(It is here assumed that the Midianites' land borders a desert.)

The Israelites leave Egypt and cross the sea:

Ex 14:22 And the children of Israel went into the midst of the sea upon the dry ground: and the waters were a wall unto them on their right hand, and on their left. KJV

Moses goes to the Sinai and talks to God:

8

Ex 3:4 God called unto him out of the midst of the bush, and said, Moses, Moses. And he said, Here am I. KJV

The Israelites go to the Sinai and hear God talking to Moses:

Ex 19:9 And the LORD said unto Moses, Lo, I come unto thee in a thick cloud, that the people may hear when I speak with thee, and believe thee for ever. KJV

Ex 19:18-19 and the whole mount quaked greatly. And when the voice of the trumpet sounded long, and waxed louder and louder, Moses spake, and God answered him by a voice. KJV

9

At the end of ‘Moses’ phantom exodus’ one of his sons (it could be both), born in the wilderness, is circumcised:

Ex 4:25 Then Zipporah took a sharp stone, and cut off the foreskin of her son, KJV

At the end of the Israelites’ Exodus, all those born in the wilderness are circumcised:

Josh 5:3 And Joshua made him sharp knives, and circumcised the children of Israel at the hill of the foreskins. KJV

Josh 5:5 but all the people that were born in the wilderness by the way as they came forth out of Egypt, them they had not circumcised. KJV

10

Moses’ phantom Exodus could have lasted 40 years:

Acts 7:23 And when he was full forty years old, it came into his heart to visit his brethren the children of Israel. KJV

Ex 7:7 And Moses was [80] years old, and Aaron [83] years old, when they spake unto Pharaoh. KJV

NOTE: To those who might be reticent to accept any reference from the book of Act, I suggest that they **postulate** from here on that Moses was 40 years old when he fled from Egypt and that the Exodus occurred 40 years later. At the end of this ‘paper’ they will be in a much better position to evaluate the soundness of this postulate.

Israel’s Exodus lasted 40 years:

Num 14:33 And your children shall wander in the wilderness forty years, KJV

Ark captured (End of the 390 years)

We have seen that the start of the 390 (prophetic) years was initiated by the ‘escape of Moses from Egypt’, an event symbolizing the exodus that was about to occur for the twelve tribes.

At the opposite end of the period, 390 years later, a calamity that must have been felt by every member of the twelve tribes took place. At the time, some of the tribes were engaged in a battle against their oppressors, the Philistines. Expecting that it would bring them some divine help, the Israelites brought the Ark of the Covenant onto the battlefield. They were defeated and the Philistines took the Ark with them.

Before saying more about the ‘capture of the Ark’, here is a cursory layout that shows how these 390 years (of prophecy) relate to others events.

This chart is the **chronological embryo** from which the whole Bible Timeline will grow. (it is self-validating when following the sequence A,B,C...J,K,L)

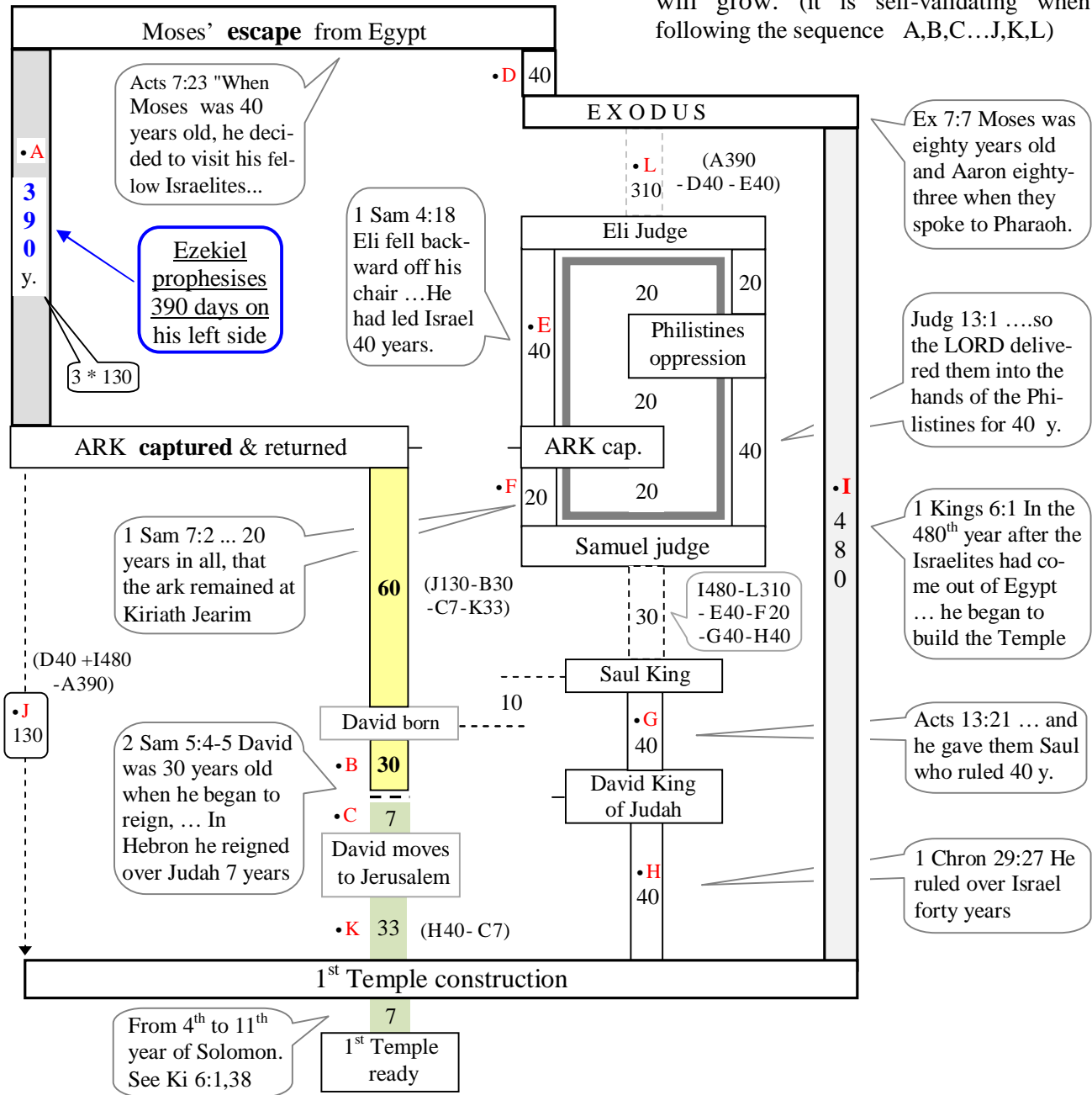

Besides having conveniently happened 390 years⁴⁸ after "Moses' escape from Egypt", did the 'capture of the Ark' mark the end of this ongoing 'prophetic' period? We need to keep in mind that there was a break after Ezekiel's first 390 days of prophesying. When he turned over, his action was fully accomplished in regard to the House of Israel. The finality expressed in Ezekiel's action (turning over) had to be found also at the end of the 390 year period that we are looking at.

But to our question we can answer a strong 'yes'. The Capture of the Ark was nothing less than God's proclamation that He was leaving his dwelling place in Shiloh:

- 1 Sam 4:22 She said, "The glory has departed from Israel, for the ark of God has been captured."

⁴⁸ This is part of the hidden information found in Ezekiel 4.

The departure of the Ark was permanent it never came back to Shiloh after the capture. In fact it was the accomplishment of a prophetic event hinted by Samuel some time earlier:

- 1 Sam 3:11 And the LORD said to Samuel: "See, I am about to do something in Israel that will make the ears of everyone who hears of it tingle.

Samuel was informed of the future capture of the Ark while lying in the Temple. We can hardly fail to see the connection with Ezekiel 'symbolically' lying in the Temple while indirectly portraying Samuel in the same situation:

- 1 Sam 3:9,15 So Eli told Samuel, "Go and lie down, and if he calls you, say, 'Speak, LORD, for your servant is listening.'" So Samuel went and lay down in his place... Samuel lay down until morning and then opened the doors of the house of the LORD.
- Ezek 4:4 "Then lie on your left side and put the sin of the house of Israel upon yourself.

Moses at the start and Samuel at the end of the 390 year period.

The start of the 390 years began with a prophetic sign performed by Moses (his **escape from** Egypt) and ended with a prophetic sign revealed to Samuel some time before it occurred (Ark's **capture**).

Both prophets (Moses and Samuel) were highly regarded in the eyes of God:

Jer 15:1 Then the LORD said to me, "Even if Moses and Samuel stood before Me, My mind would not be favorable toward this people.

Moses was the first judge of Israel. (He is the one who anointed the first High Priest [Aaron].)

Samuel was the last Judge. (He is the one who anointed the first king [Saul].)

Both of them owe their life to the unusually strong will of their mother (not their father):

Ex 2:3 Then she placed the child [**Moses**] in it and put it among the reeds along the bank of the Nile.

1 Sam 1:11 "O LORD Almighty, if you will only look upon your servant's misery and remember me, and not forget your servant but give her a son[**Samuel**],

Surprisingly neither of them was raised by his strong mother.

Moses was raised by Pharaoh's daughter while being weaned by his mother.

Samuel was raised by Eli in the Temple at Shiloh after having been weaned by his mother.

Each one stood on Holy ground.

Moses went up the Sinai and Samuel used to lie down in the Temple.

40 years of prophecy for the House of Judah (South side)

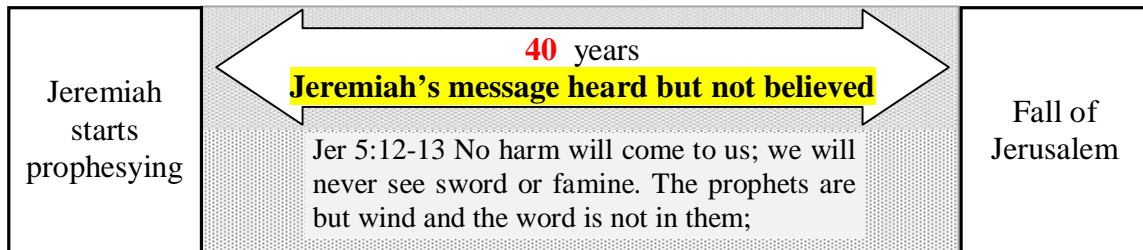
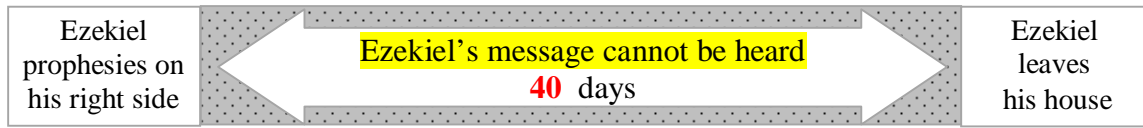

Exactly 40 years before the destruction of Jerusalem, the prophet Jeremiah was mandated to prophesy against Jerusalem:

*	1-4	5	6-17	18	19-21	22	23-28	29	30	31-39	40
Jeremiah starts prophesying	When Ezekiel prophesied (in silence) for 40 days (facing south) he was then portraying Jeremiah prophesying 40 years to people not listening.										Fall of Jerusalem

Jer 25:1-3 The word that came to **Jeremiah** concerning all the people of Judah, in the **4th** year of Jehoiakim ... "From the **13th** year of Josiah the son of Amon, king of Judah, even to this day, these **23 years** the word of the LORD has come to me, and **I have spoken to you again and again, but you have not listened.** NASU

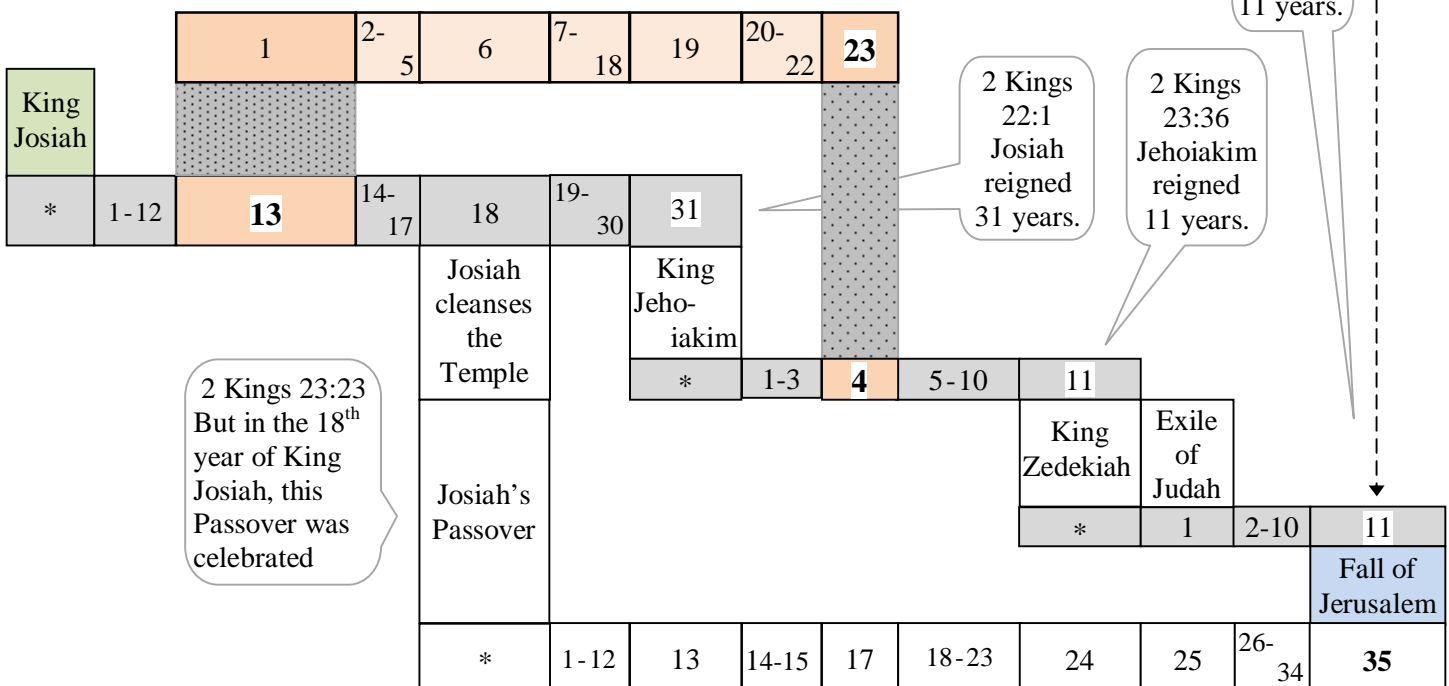

With bare arm . . . (390 + 40 days)

Besides prophesying while lying on his side Ezekiel was instructed to do it **with his arm uncovered**:

- Ezek 4:7 Turn your face toward the siege of Jerusalem and with bare arm prophesy against her.

The request seems so inconsequential that the casual reader doesn't give it a second thought and if he does he probably fails to understand the purpose of it.

Some commentators rightly associated 'the bare arm' of Ezekiel as a sign of power or fighting. In biblical times, it was customary for a soldier about to engage in a fight to uncover his right arm. This was done to prevent his garment being in the way while manipulating the sword. Aware of this information, we should refrain from assuming that Ezekiel's bare arm was a sign of the imminent siege⁴⁹ coming against Jerusalem. If it had been intended that way, it would have been lessened by Ezekiel's appearance, as he was lying and tied during the whole time. And besides that, the siege had already been portrayed on a tile; there was no need to call our attention to it again.



The only other reference where the two words, 'Chaasap' and 'et- z^arowa' (translated 'bare' and 'arm') appear together is in Isa 52:10:

- Isa 52:10 The LORD hath made bare his holy arm in the eyes of all the nations; and all the ends of the earth shall see the salvation of our God.

It is obvious here that the subject of Isa 52:10 is God's powerful accomplishment for his people.

Now, since Ezekiel was specifically chosen by God to act in the present performance and since he was doing it in his capacity of a prophet, we may conclude that Ezekiel's 'bare arm' was a substitute for God's 'bare arm'. Ezekiel, by having his arm bare, was performing yet another symbolic act, which was also dependent on the time that he lay on his sides. However, in the present case there is no need to differentiate between what was going on during the first 390 days and what was going on during the last 40 days. In the end Ezekiel had been laying bare arm for **430 days**, even⁵⁰ if he had to turn over at one time.

Ezekiel's portraying of God's powerful arm for 430 days was intended to remind us of the 430-year period that started at the Exodus.

⁴⁹ Nebuchadnezzar' siege

⁵⁰ When Ezekiel turned to the other side at the end of the first 390 days, it did create a break for many symbolic acts that were currently going on but it was not the case with the 'bare arm' one. Laying South-north facing East rather than laying North-south facing East had no impact on Ezekiel's bare arm. The symbolic act kept going on until the 430th day.

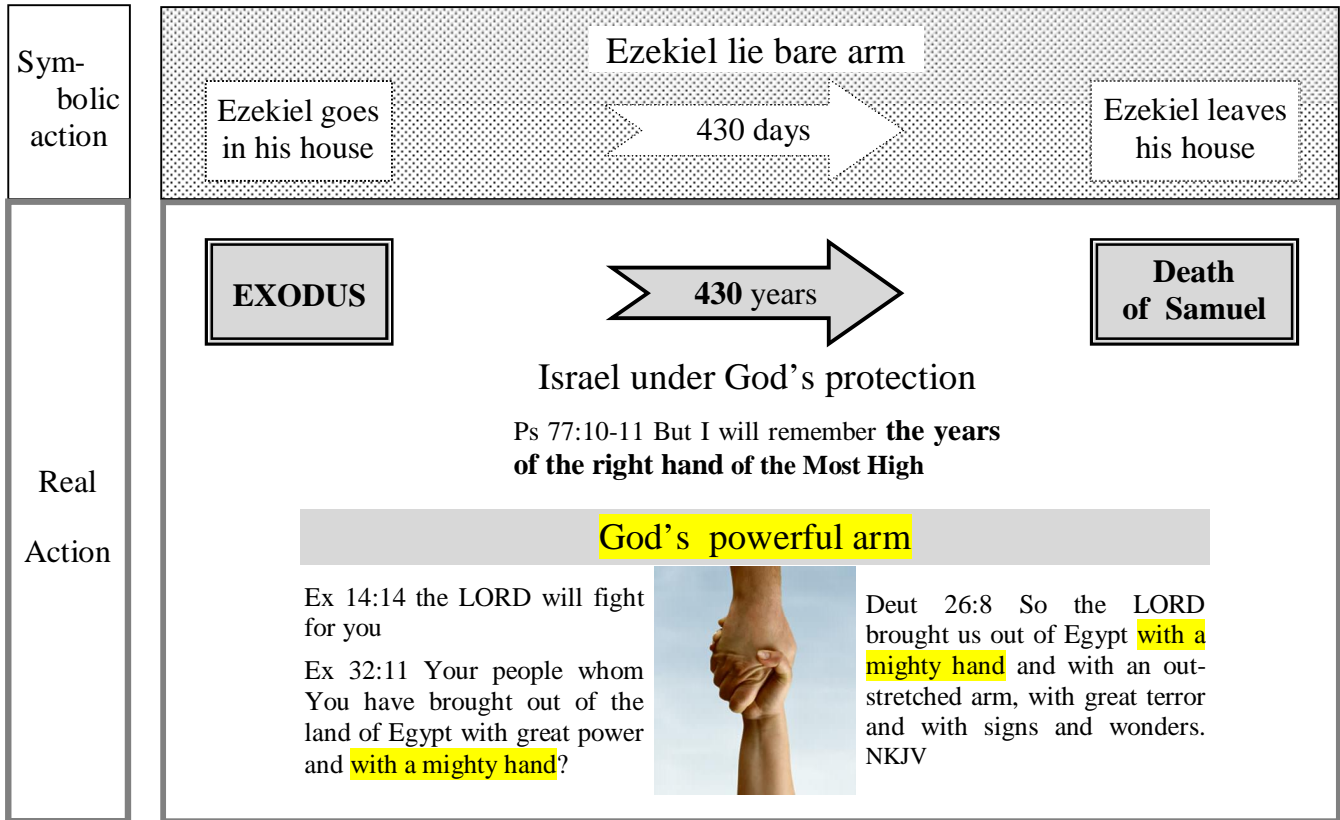

Before the Exodus, God's manifestations of power had been extremely rare and were never witnessed by more than a few individuals if at all. At the Exodus, God's mighty power was manifested in such a spectacular way that nobody could have pretended not to have heard about it. In the space of a single day every family⁵¹ in Egypt lost a son, a father or a brother while tens of thousands⁵² Israelites, untouched by the tragedy, left the country:

- Ex 12:12 "On that same night I will pass through Egypt **and strike down** every firstborn
- Ex 13:3 "Commemorate this day, the day you came out of Egypt, out of the land of slavery, because the LORD brought you out of it **with a mighty hand**
- Ex 7:4 Then **I will lay my hand on Egypt** and with mighty acts of judgment I will bring out my divisions, my people the Israelites.

By his mighty power God opened the sea and allowed the 12 tribes to cross it on dry land:

- Ex 14:13-14 Moses answered the people, "Do not be afraid. Stand firm and you will see the deliverance the LORD will bring you today. The Egyptians you see today you will never see again. **The LORD will fight for you**; you need only to be still."
- Isa 43:16-17 he who made a way through the sea, a path through the mighty waters, who drew out the chariots and horses, the army and reinforcements together,

In the 40 years following the Exodus the 12 tribes witnessed almost every day the manifestation⁵³ of God's power:

- Ex 13:22 He took not away the pillar of the cloud by day, nor the pillar of fire by night, from before the people.

⁵¹ There was a dead in every house (Ex 12:30). The first born of all the livestock was put to death. (Ex 12:29)

⁵² See "The Good Torah Sense of the Alpha-Eleph: How the Torah Counts the Tribes and Why" by Rabbi Michael S. Bar-Ron

⁵³ See also Deut 2:7, Num 11:31, Num 9:15-16

- Deut 8:16 He gave you manna to eat in the desert, something your fathers had never known,
- Ex 17:6 Strike the rock, and water will come out of it for the people to drink."
- Deut 8:4 Your clothes did not wear out and your feet did not swell during these forty years.

After the Israelites had entered the Promised Land their prosperous and also their adverse fortunes in that land were all miraculous.

- Josh 23:10 One of you routs a thousand, because the LORD your God fights for you, just as he promised.
- Judg 2:14-15 In his anger against Israel the LORD handed them over to raiders who plundered them. He sold them to their enemies all around, whom they were no longer able to resist. Whenever Israel went out to fight, **the hand of the LORD was against them** to defeat them,
- Judg 2:18 Whenever the LORD raised up a judge for them, he was with the judge and **saved them out of the hands of their enemies** as long as the judge lived;

The 430 years under God's special protection ended at Samuel's death, the last and one of the greatest of the judges. During Samuel's lifetime the Ark was captured⁵⁴, the Philistines were permanently subdued⁵⁵, and two kings were anointed⁵⁶.

The people rejected God. There was a good reason to end the 430 years of God's protection (mighty arm) at the time of Samuel's death. The Israelites in their blindness, voluntarily rejected that special protection by asking for a king:

- 1 Sam 8:6 But when they said, "Give us a king to lead us," this displeased Samuel;
- 1 Sam 8:7 And the LORD told him: "Listen to all that the people are saying to you; it is not you they have rejected, **but they have rejected me as their king.**

There was no equivocation, they thought they didn't need God's arm to fight for them anymore, their new king would protect them:

- 1 Sam 8:19-20 But the people refused to listen to Samuel. "No!" they said. "**We want a king over us.** Then we will be like all the other nations, **with a king to lead us and to go out before us and fight our battles.**"

At the end of Samuel's life (the last Judge of Israel), all ties with the past were done away with and God's manifestation of power became extremely rare.

⁵⁴ 1 Sam 3:11 And the LORD said to Samuel: "See, I am about to do something in Israel that will make the ears of everyone who hears of it tingle.

⁵⁵ 1 Sam 7:12-13 "Thus far has the LORD helped us." So the Philistines were subdued and did not invade Israelite territory again.

⁵⁶ Saul (see 1 Sam 15:17) & David (see 1 Sam 16:13)

The 3 blocks view

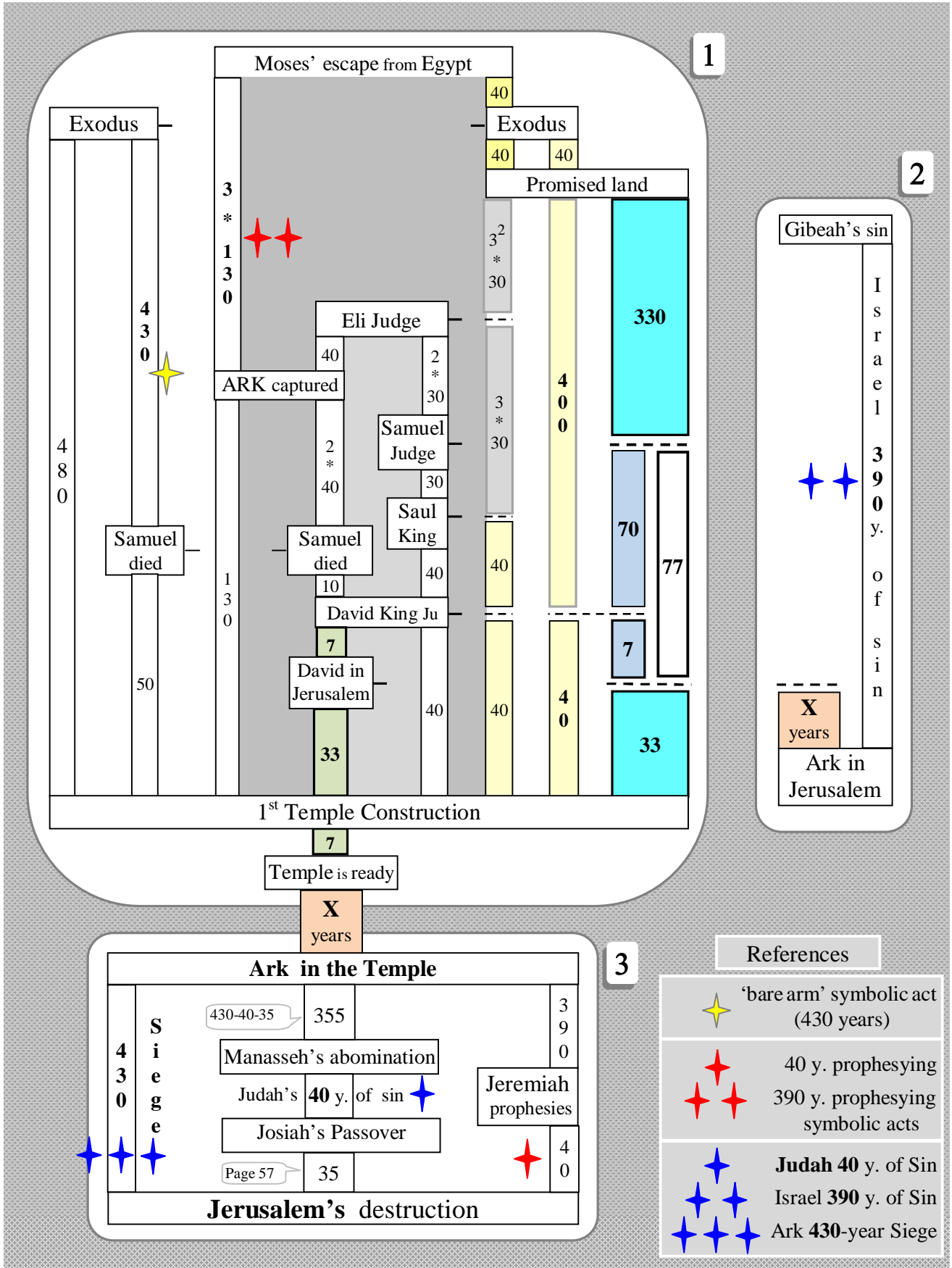

The previous figure combines all the information obtained from Ezekiel 4. so far. As we can see, the chronology of the period from “Moses’ escape” to “Jerusalem’s destruction” can be divided into three blocks of information. Now, we will try to link those three blocks together.

Between block 1 and block 3

By postulating that the Ark was brought into the Temple three years after the end of its construction, one observes (see Figure 8. Blocks 1 and 3 reunited on page 63’) that many events can now be linked together by either meaningful values or by original patterns.

Most of us took for granted that the Ark was brought into the Temple right at the end of the 7 years of its construction, which cannot be the case.

According 1 King 6:38 the Temple was ready in the **month of Bull** (the 8th month), 7 years after the start of its construction:

1 Kings 6:38 In the eleventh year in the month of Bul, the eighth month, the temple was finished in all its details according to its specifications. He had spent seven years building it.

But the Ark was brought in the **month of Ethanim** (the 7th month):

1 Kings 8:2-4 All the men of Israel came together to King Solomon at the time of the festival in the month of Ethanim, the seventh month. When all the elders of Israel had arrived, the priests took up the ark, 4 and they brought up the ark of the LORD

The Ark could not have been brought to the Temple one month before this one was ready. Therefore the only way to reconcile the information we are given is to recognize that the Ark was brought the following year at the earliest. In fact, the following figure shows that a delay of three years generates a vast collection of patterns and represent the best possible solution.

A three-year wait is quite acceptable given that the Temple, once its structure was completed (after 7 years), needed to be properly dressed before becoming operational. Thousands of people had worked on the structure, but only a few and exceptionally skilled workers were involved with the temple furnishing:

- 1 Kings 7:13-14 King Solomon sent to Tyre and brought Hiram ... Hiram was highly skilled and experienced in all kinds of bronze work. He came to King Solomon and did all the work assigned to him.
- 1 Kings 7:48-50 Solomon also made all the furnishings that were in the Lord’s temple: the golden altar; the golden table on which was the bread of the Presence; the lampstands of pure gold (five on the right and five on the left, in front of the inner sanctuary); the gold floral work and lamps and tongs; the pure gold basins, wick trimmers, sprinkling bowls, dishes and censers; and the gold sockets for the doors of the innermost room, the Most Holy Place, and also for the doors of the main hall of the temple.

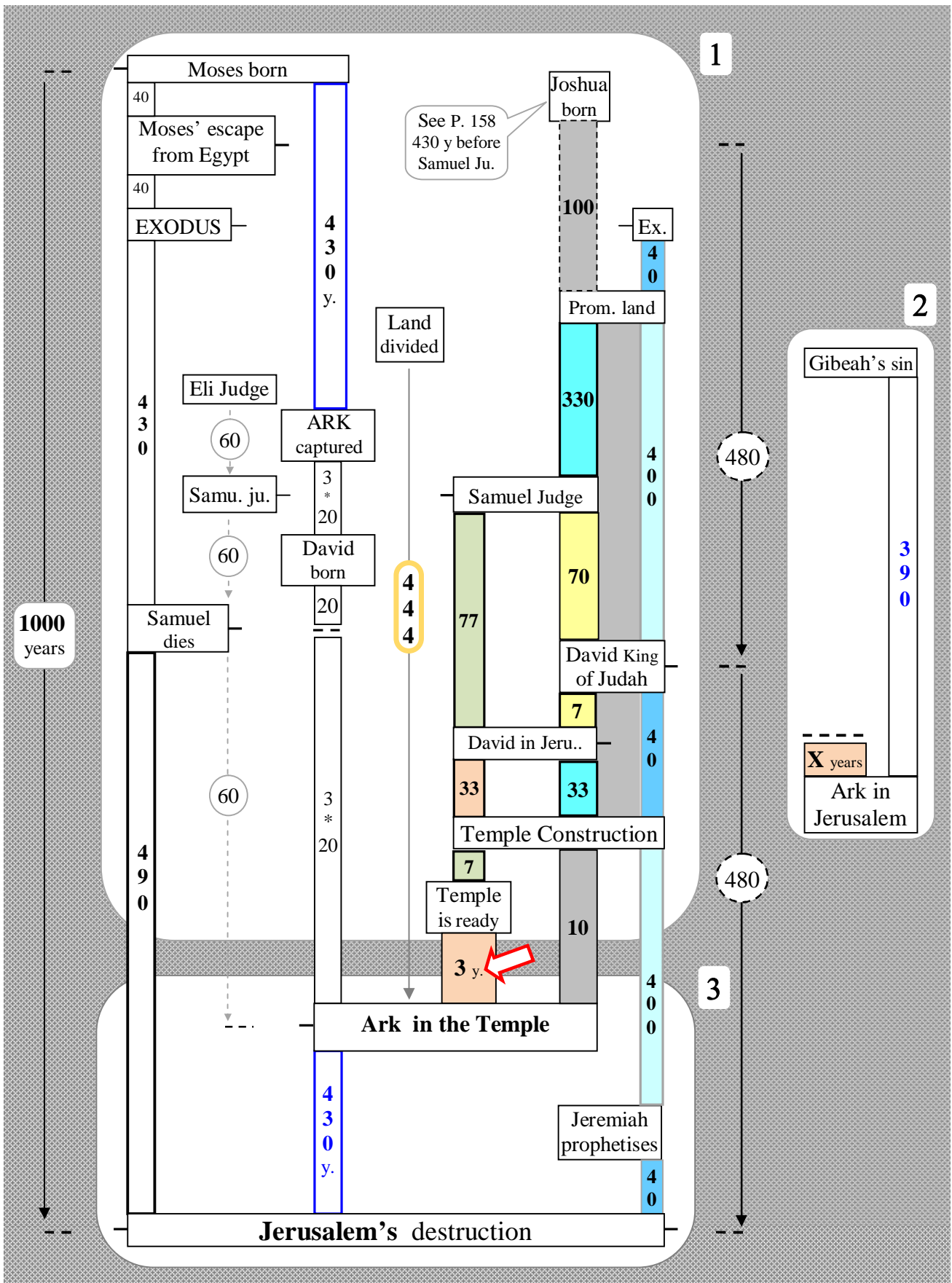

Figure 8. Blocks 1 and 3 reunited

On a chronological point of view, an extremely important piece of information is obtained from the previous figure. There were 490 years between Samuel's death and Jerusalem's end.

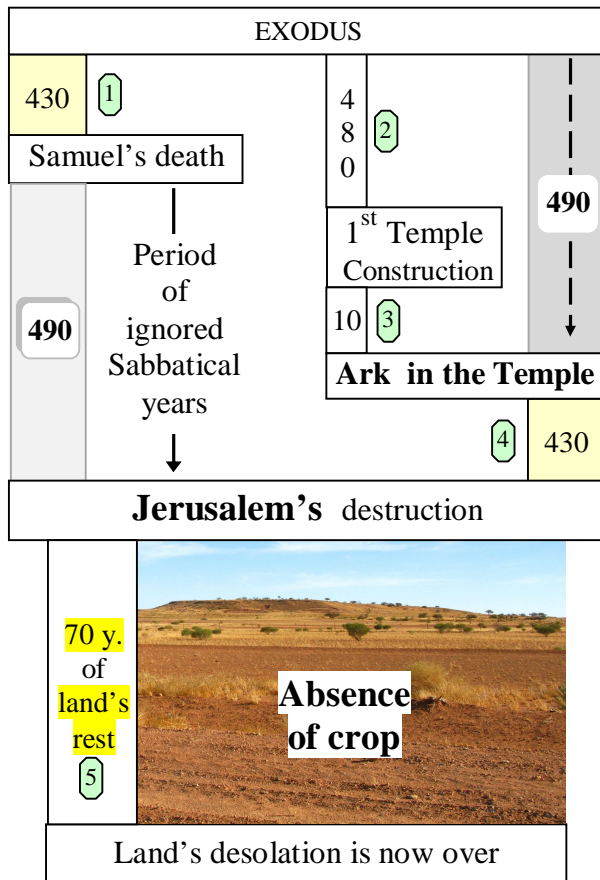

Figure 9. Samuel's death

The number of sabbatical years that have been ignored was 70. At a rate of one sabbatical year, every 7 years, the people had been disobeying the sabbatical law for 490 years. With the help of the previous figure, it is easy to see that going back 490 years from the 'Destruction of Jerusalem' we reach the time of Samuel's death. Should we be surprised? The people stopped observing the sabbatical year as soon as Samuel, their last judge, died.

Going back to the earlier discussion of Ezekiel's 'bare arm' on page 59, we concluded that it portrayed the mighty hand of God that operated from 'EXODUS' to 'Samuel's death', a period of 430 years. We can now also say that the mighty hand of God operated from 'Exodus' to the time the Israelites started ignoring the sabbatical years.

By choosing to ignore⁵⁷ God's important warning the Israelites brought to an end the unmatched superiority they had over other people around:

- Deut 5:15 Remember that you were slaves in Egypt and that the LORD your God brought you out of there with a mighty hand and an outstretched arm. **Therefore the LORD your God has commanded you to observe the Sabbath day.**

⁵⁷ The sabbatical law didn't limit itself to the weekly cycle; there was also a counterpart that has to do with the 7 years cycle.

- 1 The 430 years obtained from the 430 days of Ezekiel's bare arm.
- 2 1 Kings 6:1 In the 480th year after the Israelites had come out of Egypt, ... he began to build the temple of the LORD
- 3 This is deduced by earlier speculation when it was shown that the Ark was brought into the Temple 3 years after the 7 years it took to built it.
- 4 The 430 years portrayed by the total 430 days (i.e. 390 + 40) that Ezekiel had been lying on his sides. (Siege of the Ark)
- 5 Following the destruction of Jerusalem (and the Temple) we are told that the land was going to enjoy all the sabbatical rest it hadn't received in the past.
2 Chron 36:21 The land enjoyed its Sabbath rests; all the time of its desolation it rested, until the **seventy years** were completed in fulfillment of the word of the LORD

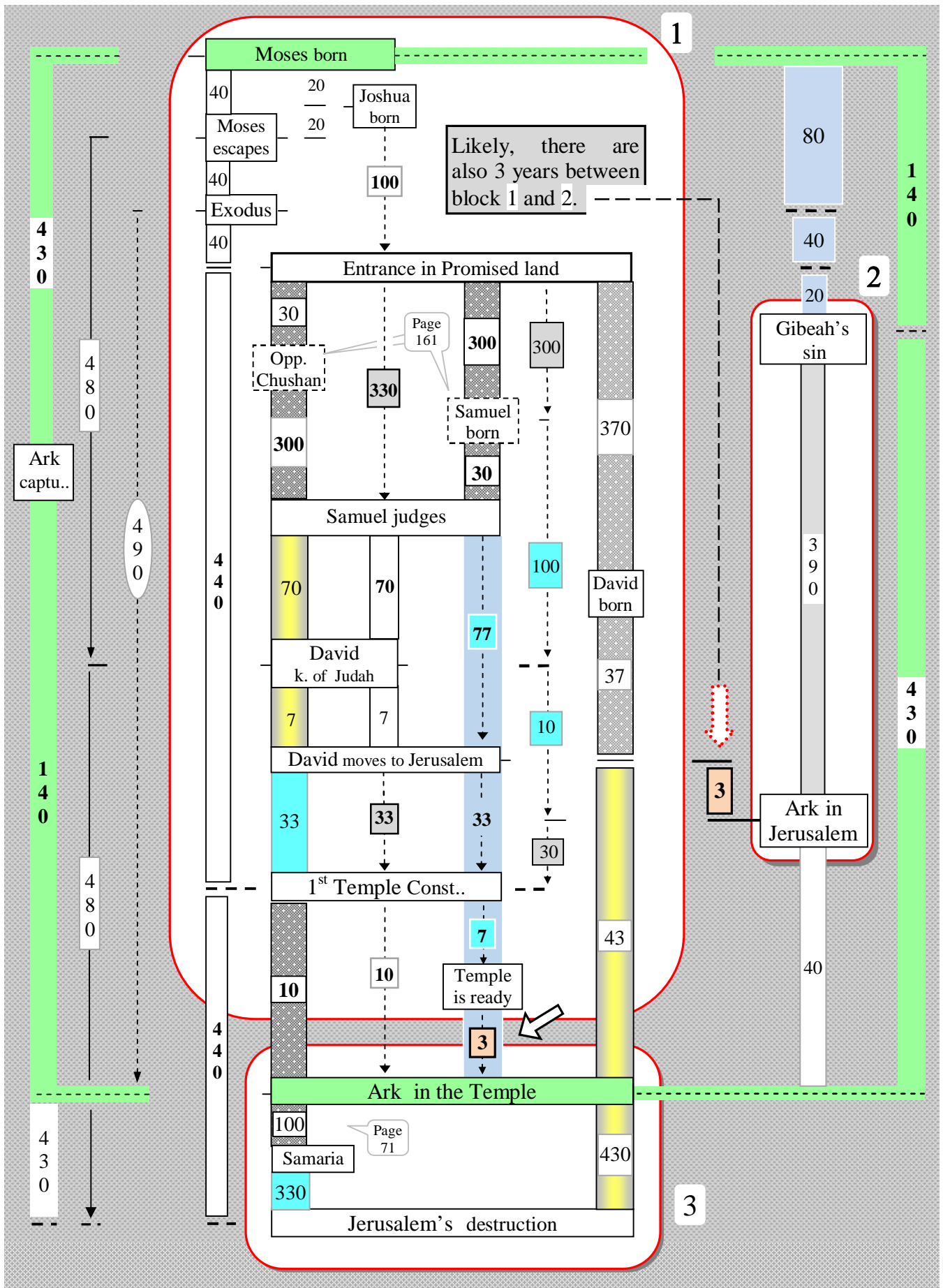

The ark was brought in Jerusalem 3 years after David settled down in that city

Did David wait three years to bring the Ark in Jerusalem? It is quite conceivable if he was planning to bring it into the new palace that he was building during that time.

1 Chron 15:1 David built houses for himself in the City of David; and he prepared a place for the ark of God, and pitched a tent for it.

1 Chron 15:3 David assembled all Israel in Jerusalem to bring up the ark of the LORD to the place he had prepared for it.

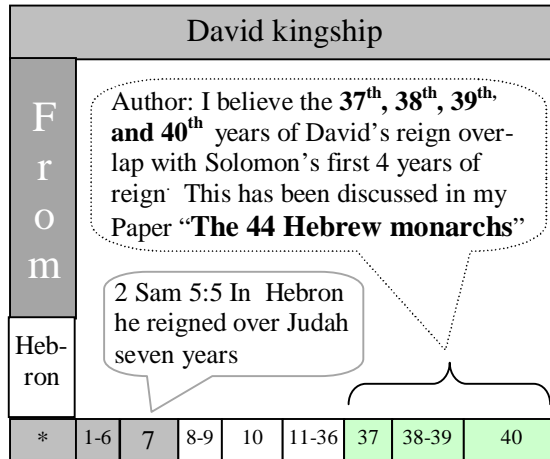

1 Kings 6:37 The foundation of the temple of the LORD was laid in the 4th year,

1 Kings 6:38 In the 11th year in the month of Bul,

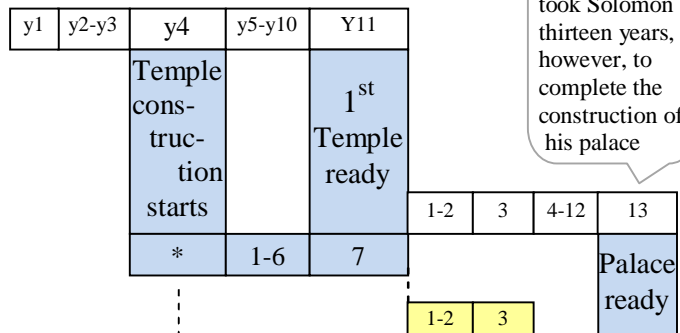
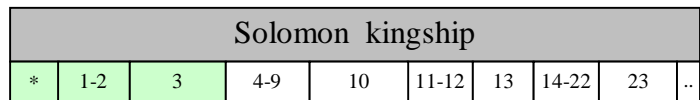

1 Kings 7:1 It took Solomon thirteen years, however, to complete the construction of his palace

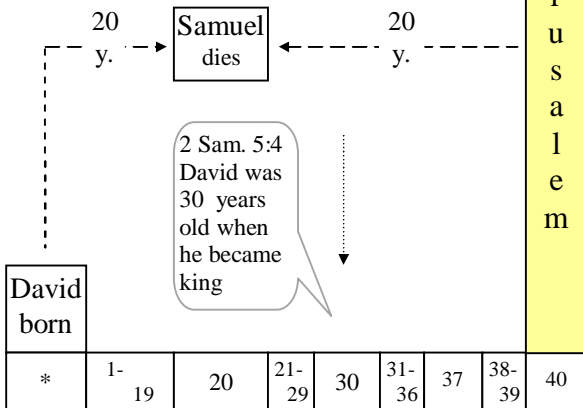

Many patterns substantiate it, the Ark was put in the Temple 40 years after it was brought in Jerusalem.

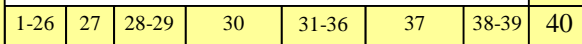

Ezekiel ate defiled food for 390 days

Among the numerous symbolic acts described in Ezekiel 4, there is the profanation of his food:

Ezek 4:12-15 ... and bake it using fuel of human waste in their sight." Then the LORD said, "So shall the children of Israel eat their defiled bread among the Gentiles, where I will drive them." Then he said unto me, Lo, I have given thee cow's dung for man's dung,

Notice the correlation between the 'Bull' (north side's animal) associated with the House of Israel's 390 days, and the "cow's dung" used by Ezekiel.



Ezekiel used cow's dung as fuel

Ezekiel was told to eat a special food for 390 days (Ezek 4:9). He was also told to cook this special food in a way that would defile it. Obviously we have here another symbolic act that was meant to portray a specific 390 years period.

Human dung VS cow dung

God first asked Ezekiel to cook his food using human dung but consecutive to Ezekiel's objection that he had never defiled himself in the past, God proposed an abatement: Ezekiel was going to use cow dung to fuel the cooking fire.

Keeping in mind that Ezekiel had to eat defiled food in order to portray the Israelites eating defiled food, • Ezek 4:13 The LORD said, "In this way the people of Israel will eat defiled food among the nations where I will drive them." NIV

the following point can therefore be deduced: It didn't matter which of the 'human dung' or 'cow dung' was to be used. In the end Ezekiel food **had to** be defiled to properly create the symbolic act.

But because Ezekiel vehemently protested that he had never been defiled in the past.

- Ezek 4:14 Then said I, Ah Lord GOD! behold, my soul hath not been polluted: for from my youth up even till now have I not eaten of that which dieth of itself, or... KJV

we can also deduce **the following point:** Using cow dung didn't defile Ezekiel, if it had, it would have defeat the purpose of the abatement.

The cow dung used as fuel defiled the food but not Ezekiel

	Using human waste as fuel	Using cow dung as fuel
Effect on Food	Defiled	Defiled
Effect on Ezekiel	Defiled	Not defiled

But what is it with human waste that would have defiled Ezekiel? Could it be that human waste, contrary to cow dung, which can be found over the ground, had to be dug out from the ground? It seems that Ezekiel understood that if he had to dig out the human excrement he would have defiled himself and it was intolerable.

The abatement protected Ezekiel from being defiled even though he was still eating defiled food.

How to interpret this symbolic act?

We have to keep in mind three important elements when analyzing it:

1. It lasted 390 years: Ezekiel was allowed to feed himself only during the first 390 days of his siege. Therefore, according to the rule that ‘a day equals a year⁵⁸’, whatever was portrayed by the defiled food had to last **exactly 390 years**.
2. It applied to the 12 tribes: Any symbolic act associated with the first 390 days that Ezekiel lay on his side involve the 12 tribes and ‘indirectly’ connects to the north side of the Temple. This point has already been shown twice in this paper.
3. It was going to involve other nations:
 - o Ezek 4:13 "In this way the people of Israel will eat defiled food among the nations where I will drive them." NIV

In short, we are looking for a period of 390 years during which the people of Israel (12 tribes) supposedly ate defiled food among other nations. If we look at this possible interpretation, we find only three possible ‘starts’ for the period. (None will be retained.)

First Exile ? When Jacob brought his whole family in Egypt. The sojourn lasted exactly 225 years. (See page 173). This period is way to short to be the right one.

Second Exile ? When the 10 northern tribes were deported to Assyria at the end of King Hoshea’s reign. Unfortunately they never came back to the land and are still in exile to this day. (*there will be much more to say about that exile later in this book, ref p.176*). This period cannot be used either.

Third Exile ? When Judah went into Exile in Babylon. This exile lasted only 70 years and is therefore too short to be the period we are looking for.

The 390-year period could not have started with any of the previous three exiles, on the other hand Ezek 4:13 does say that the Israelites shall eat their defiled food among the nations. It can hardly be more unambiguous: the Israelites had to be in exile to fulfill this description.

Now wouldn’t it bring a whole new perspective to our interpretation if, instead of assuming that our ‘period of defiled food’ was initiated by the beginning of an EXILE we would postulate that it was rather concluded by the ‘**return from an exile**’? A quick review shows that the return from the **first** or **second** exile cannot be good candidates. Going backward 390 years from the coming out of Egypt (end of first exile) would bring us to a time when the 12 patriarchs were not even born. Neither can we use the end of the second exile given that this exile is not over yet (*author absolute belief*).

That leaves us with the possibility that the 390 years period ended at the time the exiles of Judah came back from Babylon (*the third exile in the previous list*).

Event X	Israelites ate defiled food for 390 years		Judah returns from Babylonian Exile
	First 320 years	Judah 70 years of Exile	

We will see why this is the correct understanding.

⁵⁸ Ezek 4:5 For I have laid on you the years of their iniquity, according to the number of the days NKJV
 Note: People have been ill-advised to replace ‘days’ by ‘years’ every time they found it convenient in their research on chronology but to do it with Ezekiel 4 is quite appropriate.

Defiled food = False word

The Israelites were told that along with their bread they also needed to feed themselves with the ‘word of God’:

- Deut 8:3 He humbled you, causing you to hunger and then feeding you with manna, which neither you nor your fathers had known, to teach you that man does not live on bread alone but **on every word that comes from the mouth of the LORD.** NIV

Jeremiah and Ezekiel were fed by the words of God before being sent to the people:

- Jer 15:16 When your words came, I ate them; they were my joy and my heart's delight, NIV
- Ezek 3:3 Then he said to me, "Son of man, eat this scroll I am giving you and fill your stomach with it." So I ate it, and it tasted as sweet as honey in my mouth. NIV

The role of the prophets was to feed the people with food for the mind⁵⁹. Therefore, by analogy, when the prophets were lying and gave words that did not come from God, **they were feeding the people with defiled food.**

So, my theory is this: **Ezekiel's unclean food** symbolized the **false words given to the people by most of the prophets**; it all started at the **time of the foundation of Samaria.**

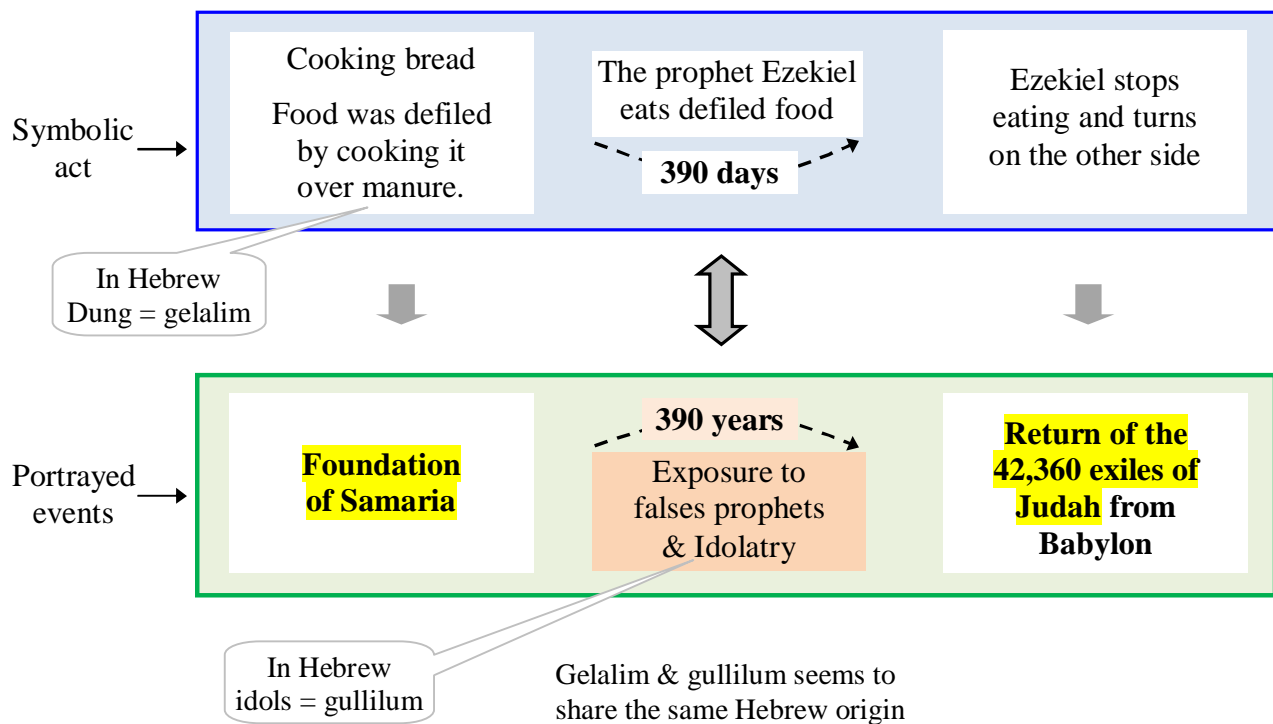

We will see later that the Foundation of Samaria coincide with the start of the most corrupted (defiled) period of Israel's history, a period also characterized by the introduction of the worship of Baal (a foreign nation's deity) by the Israelites.

⁵⁹ Notice in the following verse from Amos that the ‘absence of word’ (from God) can be equated to a famine. [Amos 8:11 "Behold, the days are coming," says the Lord GOD, "That I will send a famine on the land, Not a famine of bread, Nor a thirst for water, But of hearing the words of the LORD. NKJV]

Was Samaria founded 390 years before the return of the 42,360 exiles from Babylon? Yes, and to justify this affirmation, I will show that King Omri, the one who founded Samaria, was the one reigning 390 years before the return of the exiles of Judah from Babylon.

✓ The return from the Babylonian exile happened **60 years** after the temple destruction:

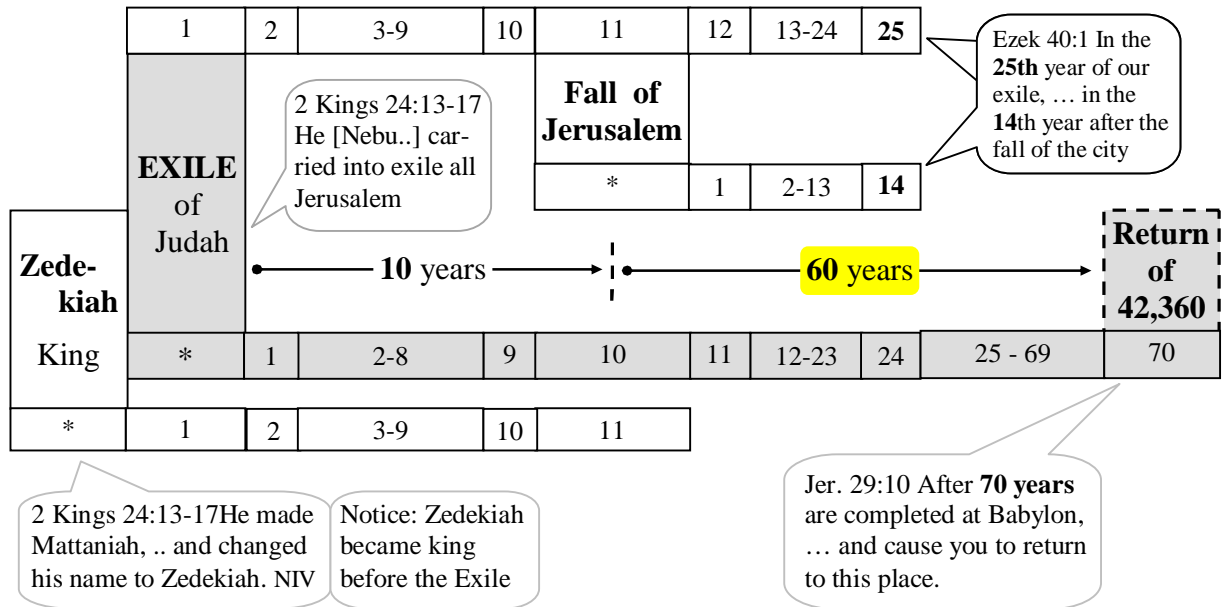

✓ Omri became king of Israel (and built Samaria) **100 years** after the Ark was brought in the Temple.

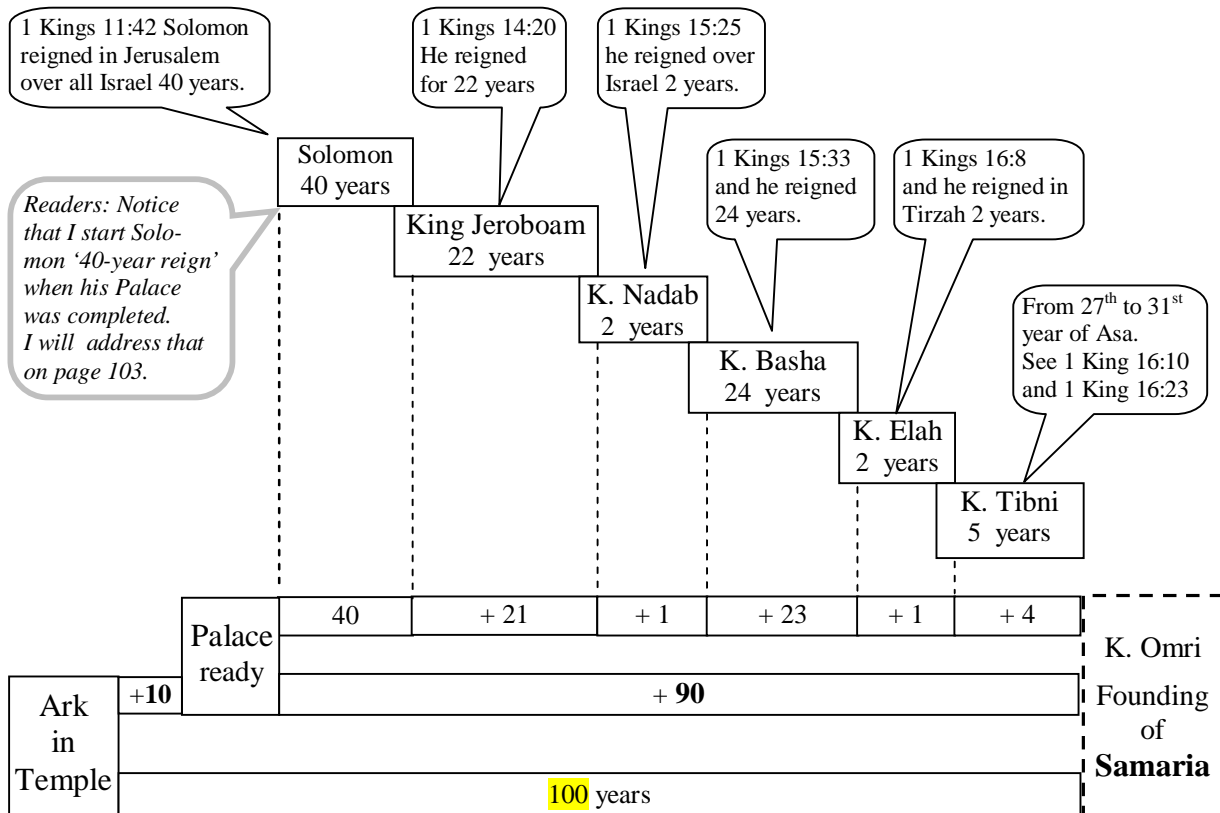

Using the information found up to now, we can deduce that there are **390** years between 'the founding of Samaria' and 'the return of the exiles'. i.e. (A430 + B60) – C100.

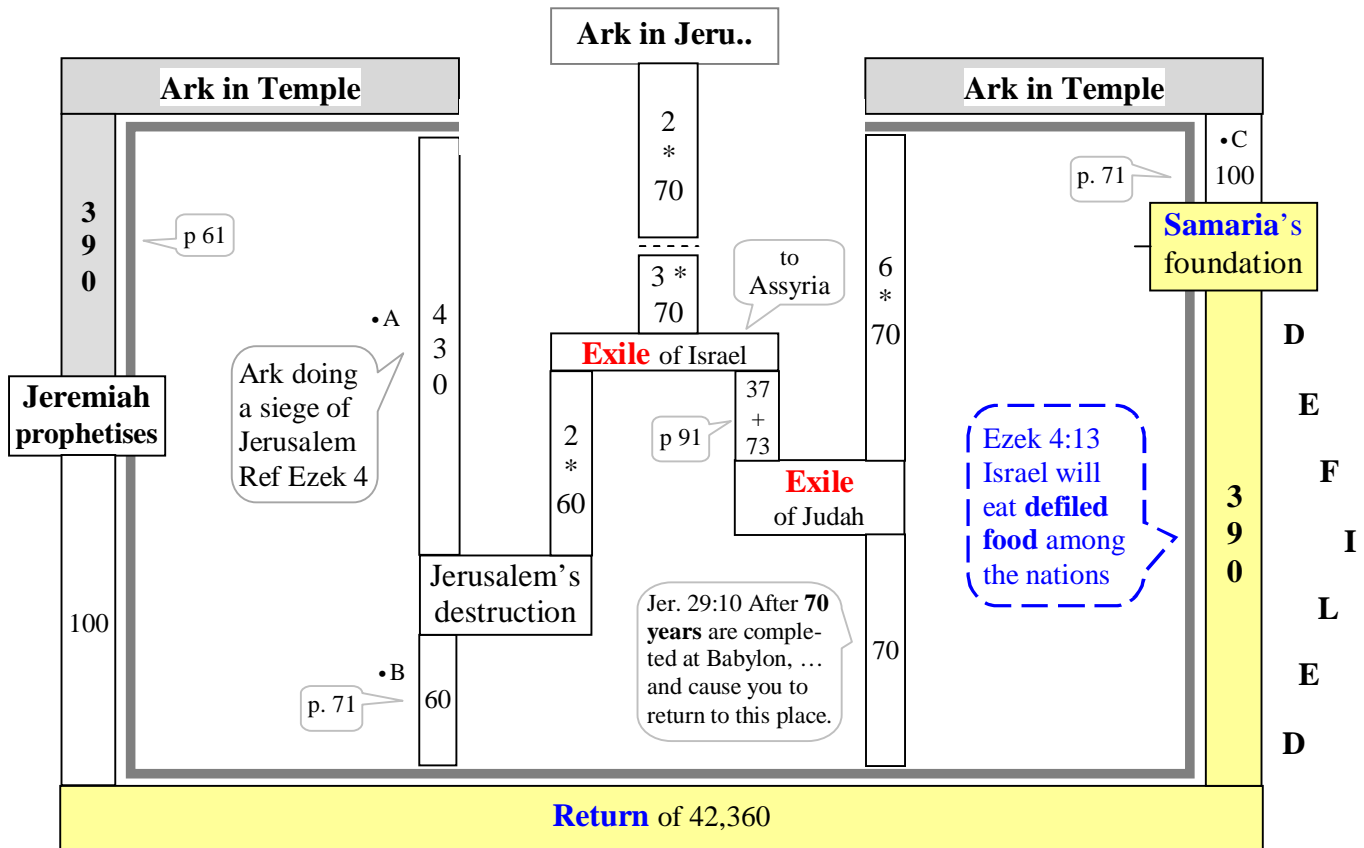

Figure 11. Defiled food

Initiating the period of 390 years with the foundation of Samaria is quite judicious. Samaria hadn't only become the capital⁶⁰ of the northern kingdom it also became the seat of all the corruption that prevailed in Israel:

- Jer 23:13 "Among the prophets of Samaria I saw this repulsive thing: They prophesied by Baal and led my people Israel astray.

With the start of Samaria a new dynasty of kings (Omri, Ahab, Ahaziah, Jehoram [Joram] began to reign over the people. They introduced changes that would have a profound effect on the people:

1 Kings 16:25 But Omri did evil in the eyes of the LORD and sinned more than all those before him.

1 Kings 16:30-32 Ahab son of Omri did more evil in the eyes of the LORD than any of those before him. He not only considered it trivial to commit the sins of Jeroboam son of Nebat, but he also married Jezebel daughter of Ethbaal king of the Sidonians, and began to serve Baal and worship him.

1 Kings 22:53 He [Ahaziah] served and worshiped Baal and provoked the LORD, the God of Israel, to anger, just as his father had done.

2 Kings 3:2 He [Joram son of Ahab] did evil in the eyes of the LORD,

⁶⁰ from then on Samaria would be the residence of all the kings of the northern kingdom until the Exile

Legacy of Omri's dynasty

New deity, New prophets, Corrupted shrines, A Temple of Baal in Samaria:

- 1 Kings 18:18 "I have not made trouble for Israel," Elijah replied. "But you [Ahab] and your father's family [Omri] have. You have abandoned the LORD's commands and have followed the Baals.

The corruption in Israel became so critical that it was almost impossible to hear the words of God anywhere in the whole territory. There came a time when there was only one prophet of God left:

- 1 Kings 18:22 Then Elijah said to the people, "I alone am left a prophet of the LORD; but Baal's prophets are four hundred and fifty men. NKJV
- 1 Kings 22:22-23 The LORD said to him, 'In what way?' So he said, 'I will go out and be a lying spirit in the mouth of all his prophets.' And the LORD said, 'You shall persuade him, and also prevail. Go out and do so.' 23 "Therefore look! The LORD has put a lying spirit in the mouth of all these prophets of yours, and the LORD has declared disaster against you." NKJV
- Hos 4:7 "The more they increased, The more they sinned against Me; NKJV
- Hos 5:3 For now, O Ephraim, you commit harlotry; Israel is defiled. NKJV

Meanwhile Judah didn't do any better. Its land was also filled with corruption:

- Jer 23:16 Thus says the LORD of hosts: "Do not listen to the words of the prophets who prophesy to you. They make you worthless; They speak a vision of their own heart, Not from the mouth of the LORD. NKJV
- Jer 23:26 "How long will this be in the heart of the prophets who prophesy lies? Indeed they are prophets of the deceit of their own heart, NKJV
- Jer 27:9-10 Therefore do not listen to your prophets, your diviners, your dreamers, your soothsayers, or your sorcerers, who speak to you, saying, "You shall not serve the king of Babylon." 'For they prophesy a lie to you, to remove you far from your land; and I will drive you out, and you will perish. NKJV
- Ezek 22:26 Her priests have violated My law and profaned My holy things; they have not distinguished between the holy and unholy, nor have they made known the difference between the unclean and the clean; and they have hidden their eyes from My Sabbaths, so that I am profaned among them. NKJV
- Zeph 1:4 "I will stretch out My hand against Judah, And against all the inhabitants of Jerusalem. I will cut off every trace of Baal from this place, The names of the idolatrous priests with the pagan priests-- NKJV
- Zeph 3:1,4 Woe to her who is rebellious and polluted, To the oppressing city! 4 Her prophets are insolent, treacherous people; Her priests have polluted the sanctuary, They have done violence to the law. NKJV

The people of every tribes were fed with lies

After the foundation of Samaria, the idolatry, the deception, the violation of God's law spread like a disease across Israel. For hundreds of years, people of every tribe, showing an obvious lack of judgment, had been listening and believing false teaching, thus succeeding in alienating from their one true God. Each Kingdom (North, South) was independently sent in exile and the land was emptied of any descendant of Jacob.

The 390 years period ended when the first Israelites came back to the land (it happens to be those from Judah). These had been exiled in Babylon for 70 years. The people were then offered a new start, their sins were forgiven and they received a new spirit:

Jer 29:13-14 You will seek me and find me **when you seek me with all your heart**. I will be found by you," ... , "and will bring you back from captivity. NIV

Ps 85:1-2 Lord, You have been favorable to Your land; You have brought back the captivity of Jacob. **You have forgiven the iniquity of Your people**; You have covered all their sin. NKJV

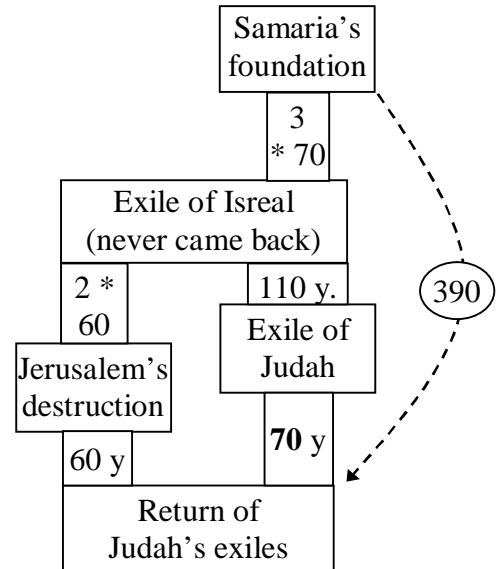

The Israelites didn't need to go among other nations for the whole 390 years.

Some readers will also argue that Ezekiel 4:13 imply that the Israelites would have to eat their food (hearing lies) among **other nations** for **the whole 390-year period** and not for a mere 70-year during which the Southern Kingdom was in exile.

Ezek 4:13 The LORD said, "In this way the people of Israel will eat defiled food among the nations where I will drive them." NIV

Although the objection is legitimate it cannot be retained for the following reason. When told about the way he should cook his food, Ezekiel protested vehemently and as a result, received 'partial' abatement for his assignment

Ezek 4:15 "Very well," he said, "I will let you bake your bread over cow manure instead of human excrement." NIV

It is only logical that the events portrayed by this symbolical act should also reflect a convincing form of abatement. Thus, as we will see, the Israelites didn't immediately go abroad to eat the defiled food from other nations. In the 210 years before Israel's exile (Northern kingdom), and the 320 years before Judah's exile (Southern kingdom), it was the people of other nations who came to Israel and changed (corrupted) their traditions.

After the foundation of Samaria the Israelites were inclined to mix with other nations:

- 1 Kings 20:34 "I will return the cities my father took from your father," Ben-Hadad offered. "You may set up your own market areas in Damascus, as my father did in Samaria." NIV
- Hos 7:8-9 "Ephraim has mixed himself among the peoples; Ephraim is a cake unturned. Aliens have devoured his strength, But he does not know it; NKJV

King Ahab's wife Jezebel, who was not an Israelite, brought with her the deity of her own nation and introduced the worship of Baal on a large scale in the northern kingdom. (It is quite conceivable that she brought also her own prophets with her when she came to Samaria.)

- 1 Kings 16:31 but he also married Jezebel daughter of Ethbaal king of the Sidonians, and began to serve Baal and worship him. NIV
- 1 Kings 18:19 And bring the four hundred and fifty prophets of Baal and the four hundred prophets of Asherah, who eat at Jezebel's table."
- 2 Kings 15:29 In the time of Pekah king of Israel, Tiglath-Pileser king of Assyria came and ... NIV

Foreign armies invaded Judah's territory and the people were subdued by others nations for years before being sent into captivity, thus sharing the same fate as their brothers from the northern kingdom.

- 2 Kings 16:7 Ahaz sent messengers to say to Tiglath-Pileser king of Assyria, "I am your servant and vassal.
- 2 Kings 24:1 During Jehoiakim's reign, Nebuchadnezzar king of Babylon invaded the land, and Jehoiakim became his vassal for three years. NIV

Coking every day while tied up would have been impossible

Did Ezekiel really cook his food every day over the 390 day period?

Most commentators don't hesitate to answer 'yes' to this question and then argue that the daily cooking (gathering dung, starting the fire, food preparation) is a confirmation that Ezekiel wasn't required to be on his side 24 hours a day.

The only problem is that the Bible's text is **unambiguous, Ezekiel was going to be tied until the end of his siege and there is no mention of any relaxing.**

- Ezek 3:24 Go, **shut yourself inside your house**. NIV
- Ezek 3:25 And you, son of man, they will tie with ropes; you will be bound so that you cannot go out among the people. NIV
- Ezek 4:8 I will tie you up with ropes so that you cannot turn from one side to the other **until** you have finished the days of your siege. NIV

The full textual meaning of this is that Ezekiel was tied up and had to lie on his side **without interruption** for 430 days (390 + 40).

What about the daily cooking then? Well, there couldn't have been any daily cooking.

Notice that Ezekiel was told to cook his food **in the sight of the people?**



but he was also order **to go in his house** for the duration of the whole period (textually implied)

Ezek 4:12 bake it in the sight of the people NIV



Ezek 3:24 Go, **shut** yourself inside your house.

Isolation

The only way to reconcile this apparent contradiction **is to have the 'whole' cooking done in front of the people before Ezekiel went inside the house and lied on his sides** for 430 days.

Ezekiel couldn't have cook more than one bread

Given that Ezekiel didn't cook any food while he was lying down, does it mean that he cooked a stack of 390 bread the very first day and ate one of them every day? I don't think so. I believe Ezekiel cooked only a single bread right in front of the people at the very beginning of his ordeal and ate a piece from it, at set time, every day during the following 390 days. Obviously this thinking forces us to conclude that God miraculously preserved Ezekiel's bread and made it possible for the prophet to eat a weight of 20 shekels part of it every day.

The widow at Zarephath received an **inexhaustible supply of oil from God**

1 Kings 17:11-14 As she was going to get it, he called, "And bring me, please, a piece of bread." "As surely as the LORD your God lives," she replied, "I don't have any bread-only a handful of flour in a jar and a little oil in a jug. I am gathering a few sticks to take home and make a meal for myself and my son, that we may eat it-and die." Elijah said to her, "Don't be afraid. Go home and do as you have said. But first make a small cake of bread for me from what you have and bring it to me, and then make something for yourself and your son. For this is what the LORD, the God of Israel, says: 'The jar of flour will not be used up and the jug of oil will not run dry until the day the LORD gives rain on the land.'" NIV

Ezekiel as mentioned before, was portraying actions from the Temple's perspective.

Isn't it interesting that the food he ate for 390 days was associated with Israel north side of the Temple. And what was the food on the northern side of the 'real' Temple? Wasn't it 12 loaves of bread placed on the 'shewbread table' by the High Priest?

According the Jewish sages the Temple's 12 loaves of bread were miraculously preserved. They say that when they were replaced during each Sabbath, although 7 days had passed since they were brought in, the loaves were 'still hot as if freshly baked' (BT Menachot 29:A) Besides, these 12 loaves, once removed from the table, were given in very small bite portion to each Levites priest to be eaten (the bread was not stale). Each one hunger was fully satisfied.

So, because of the correlation between Ezekiel's food and the food on the North side of the Temple we have a strong indication that Ezekiel food didn't become stale in spite of the long period it was kept. And because an '**inexhaustible supply of material**' is not something unheard of, it is quite possible that Ezekiel's bread was constantly and miraculously renewed during the 390 days of his enactment.

But there is still an ultimate proof that Ezekiel cooked only a single bread and only at the very beginning of his ordeal. Each Ezekiel' symbolic act portrayed a period of time and the pair of events that bookended that period of time. If you accept that the real events portrayed by the symbolic acts performed by Ezekiel can supply back some details about the symbolic

acts themselves, you will have to agree with me on the following point: The foundation of Samaria was a single event that had to be matched by an unique event no matter that it was a symbolic one. Therefore there couldn't have been more than one single bread cooked by Ezekiel.

Foundation of Samaria ----->|

A unique occurrence that had to be portrayed by a 'single' event

Cooking of one bread <-----|

Foundation of Samaria & baking of a bread were acts of creation. Something that didn't exist was made.

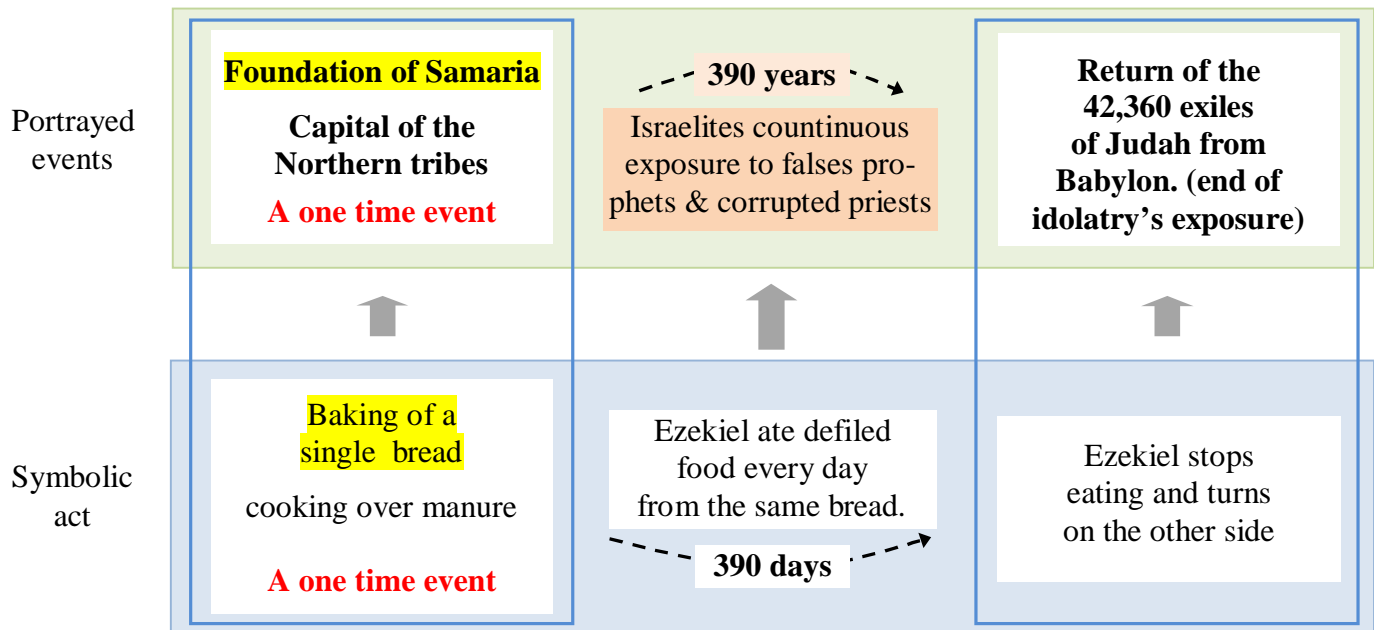

If Ezekiel had cooked a different bread each day for more than a year then the foundation of Samaria would have had to be repeated 390 times, which it didn't. Also, as Samaria's foundation occurred only once, to portray it by baking (i.e. creating) 390 breads in a single day would have greatly weakened and ruined the value of the symbolic act.

We are now left with the following questions:

- Did Ezekiel spend 430 days without relieving himself?
- Was his food protected from spoiling during the 390 days he was allowed to eat?
- Could Ezekiel have survived the following 40 days period without eating?
- Was Ezekiel's body protected from bed sores while laying down for so long?

I say 'YES' to all these questions. Ezekiel had been given a mandate from God. Anything outside the symbolical realm of that mandate should be view as irrelevant (which would explain why these miracles are not even mentioned in the text).

Is it rational to faithfully accept the miracles described in Deu 8:4

Deut 8:4 Your garments did not wear out on you, nor did your foot swell these forty years. NKJV

while being sceptical of the way a major prophet like Ezekiel fulfilled God's instructions?

Ezek 4:8 And surely I will restrain you so that you cannot turn from one side to another till you have ended the days of your siege.

Hardcore sceptics would like to convince us that the 10 plagues of Egypt were a chaining of natural phenomena and their consequences. As if a natural phenomena could selectively target every first born of a population? What would have been the point to tell Ezekiel what to do if he had had no means to do it? Lets not forget that prior to its calling **Ezekiel had been strengthen** in a way impossible to evaluate for us. Ezek 3:24 **Then the Spirit entered me** and set me on my feet NKJV

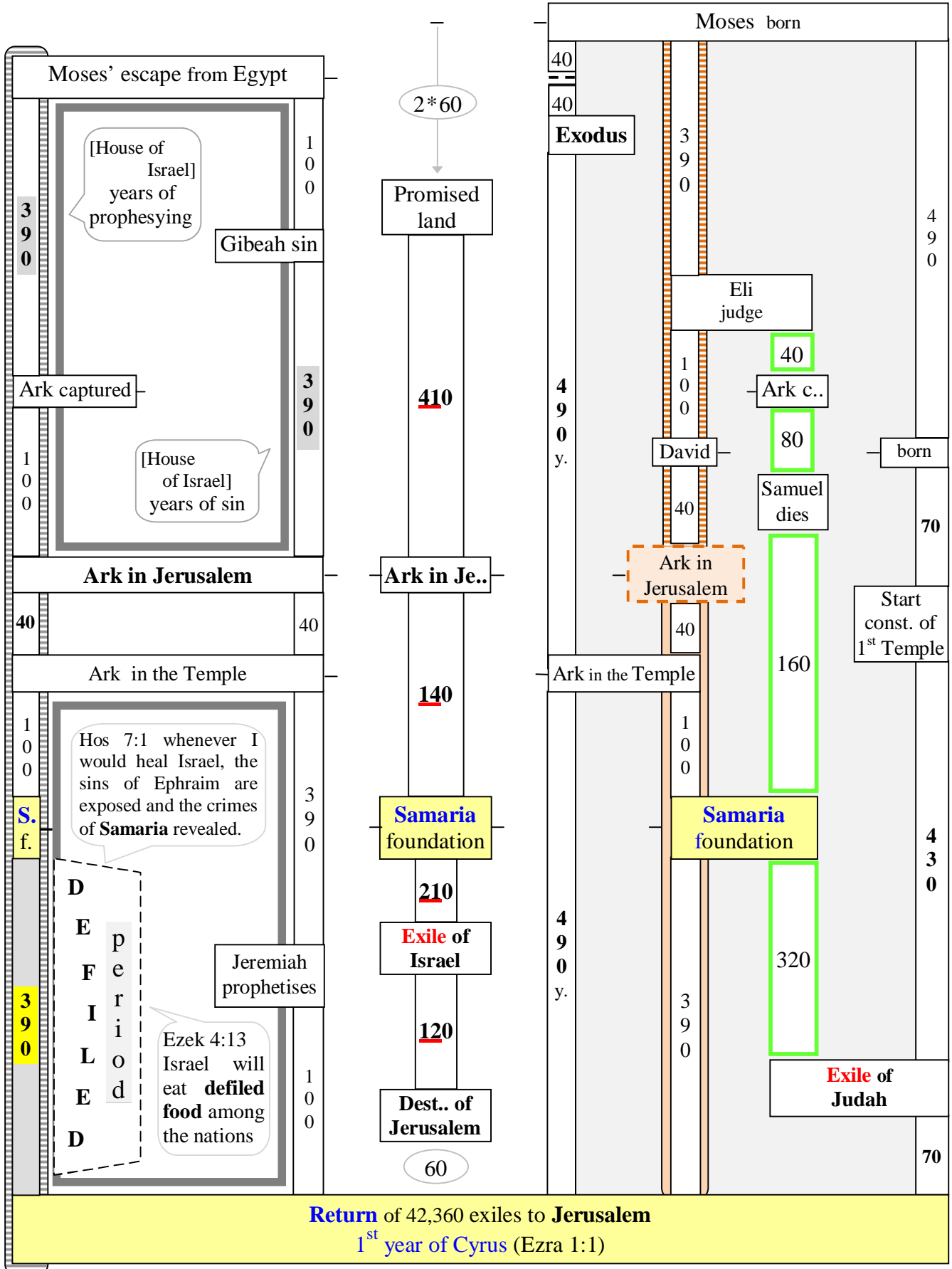

Figure 12. Ezekiel defiled food

The 430 years and 400 years countdown to Exodus

Anybody who has studied the Bible's chronology for some time will agree. There is only one way to obtain the date of the Exodus and it is by properly identifying the origin of the 430 years mentioned in Exodus 12:40 and in Galatians 3:17. These two verses are fundamental to the building of an elaborate and consistent chronology of the Bible.

Ex 12:40-41 Now the sojourn of the children of Israel who lived in Egypt was four hundred and thirty years. ... all the armies of the LORD went out from the land of Egypt. NKJV

Gal 3:17 What I mean is this: The law, introduced 430 years later, does not set aside the covenant previously established by God and thus do away with the promise NIV

In the following pages we will

identify the covenant alluded to in

Galatians 3:17. **EVENT X**

It happened 430 years before Exodus.

determine the right date for the Exodus,

and finally find out what happened 400 years before the Exodus. **EVENT Y**

- Gen 15:13 and they will be enslaved and mistreated four hundred years. NIV

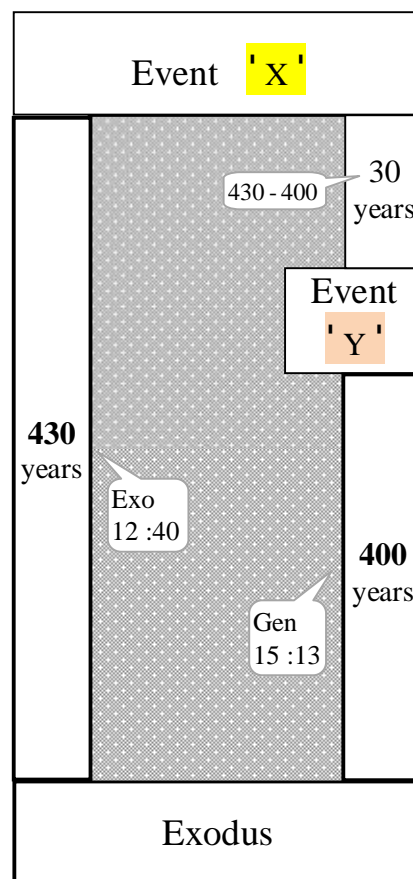

According to Exo 12:40 the Israelites left Egypt (Exodus) at the end of a period of 430 years⁶¹. The verse doesn't say anything about the beginning of the period. Fortunately, we are not left without a clue as Galatians 3:17 supplies us with an important clarification: the 430-year period originated at the time of a covenant. In Galatians 3:16, the previous verse, we learn that the covenant was known to Abraham, the first patriarch of Israel.

- Gal 3:16 Now to Abraham and his Seed were the promises made. NKJV

Our initial approach will be to build a timeline of the important events in Abraham's life. One of those events is more likely to have triggered the 430-year countdown to the Exodus. We have to keep in mind that we don't know yet if we are looking for a covenant that was enunciated, confirmed or activated.

⁶¹ Here many people have been lured into thinking that the Israelites spent the whole 430 years in Egypt. Even though the verse seems to say so it wasn't the case and we will see later that there is an alternate way to understand Ex 12:40.

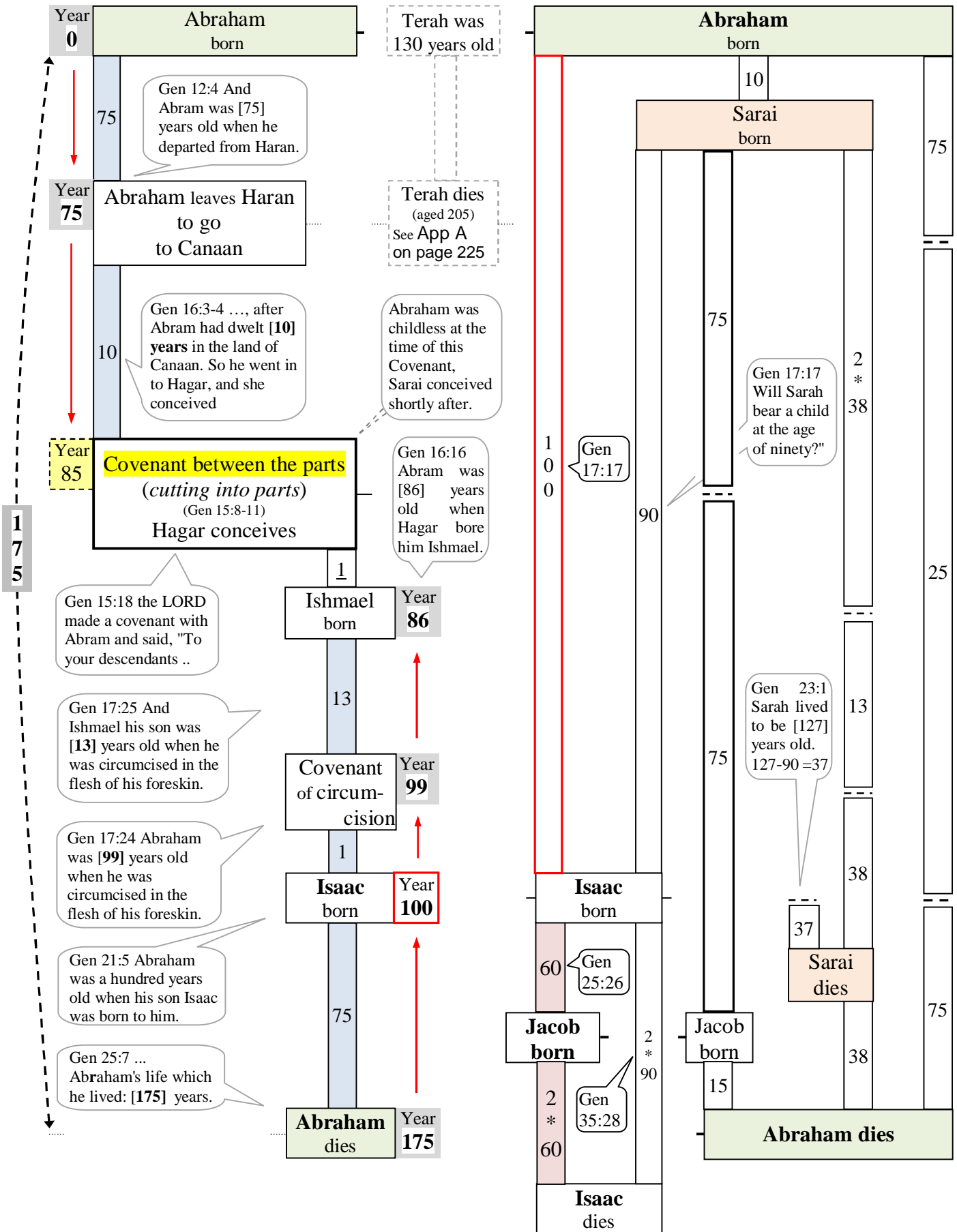
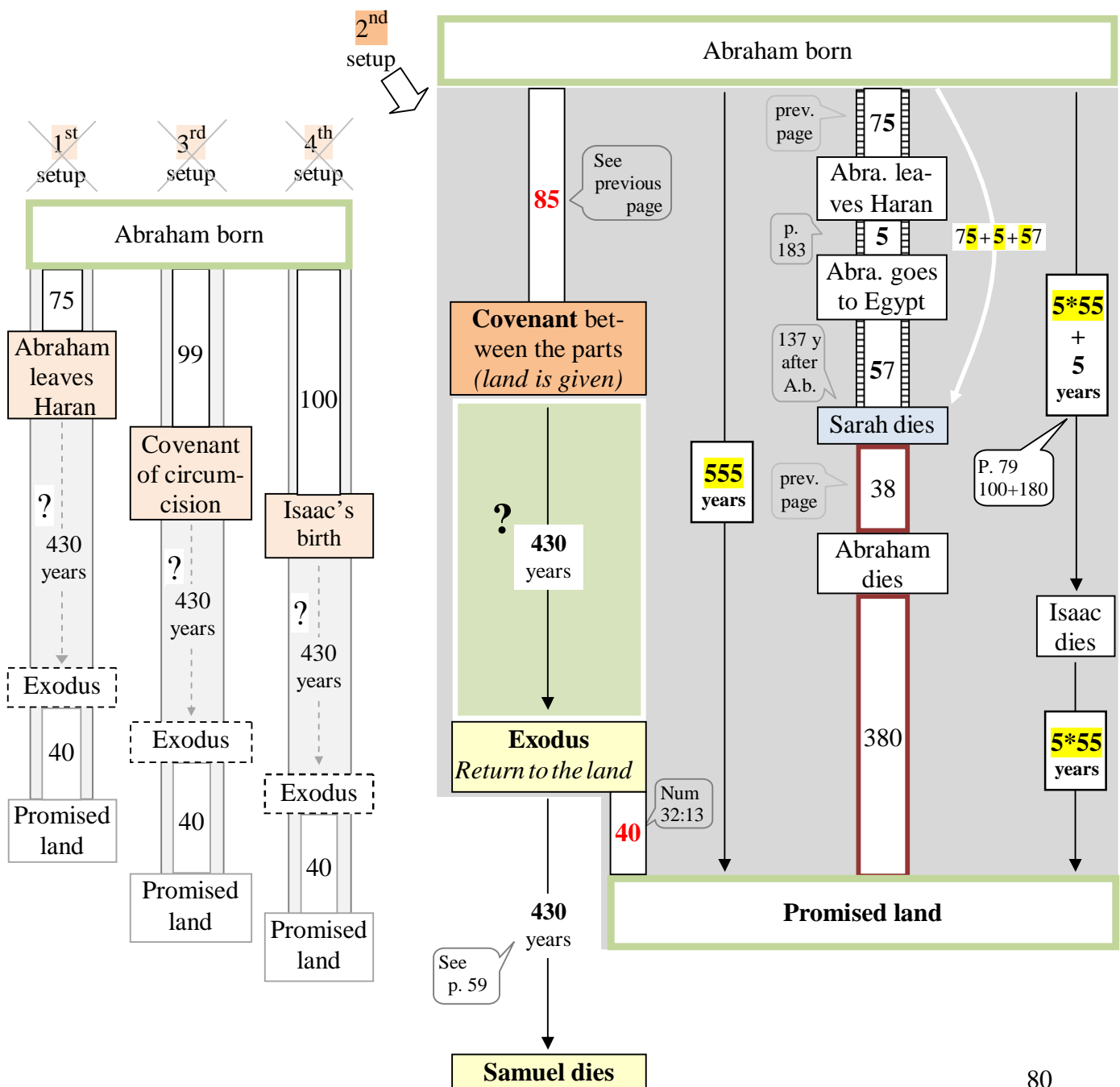

Figure 13 Abraham timeline

The timing of the Exodus (and the coming to the Promised Land) is a tributary to the origin of the 430-year period mentioned in Exo 12:40. There is only 4 events in Abraham's life that could have trigger the 430 years count. We will see that among the next four setups only the second one reveals some surprising connections.

- ⇒ **First** When Abraham left Haran at age 75? He was certainly obeying God in doing that.
- ⇒ **Scd** When Abraham received the covenant between the parts (Land being given) at age 85? This is the first time a sign is introduced to confirm that the land will be given (the cutting into part, Gen 15:8-11).
- ⇒ **Third** When Abraham was circumcised at age 99? By marking his own flesh and the flesh of his people Abraham was ratifying a very special agreement with God.
- ⇒ **Fourth** When 100-year-old Abraham became the father of Isaac? This was the fulfillment of a promise received the previous year and the beginning of an important dynasty.



Intuitively, it seems right to start the 430 years leading to the Exodus at the ‘Covenant between the parts’ when the land was given. One could say that the period started with God’s promise to give the land (and the covenant that goes with it), and ends 430 years later when the return (from Egypt) of all the people to that land was initiated.

--- Unfortunately, that argument wouldn’t be strong enough to convince everyone that those events are absolutely complementary. But there is more...

Have you noticed that the strange ritual performed by Abraham during the covenant between the parts (cutting into parts), was echoed in several points at Exodus? Look at the following two events and compares **A & A’ B & B’ C & C’ D & D’**

Covenant between the parts	Gen 15:10-11 Then he brought all these to Him and cut them in two (A) , down the middle, and placed each piece opposite the other (B) ; but he did not cut the birds in two. And when the vultures came down on the carcasses, Abram drove them away(C) .
	Gen 15:17 And it came to pass, when the sun went down and it was dark, that behold, there appeared a smoking oven and a burning torch that passed between those pieces (D) .
430 years later	
Exodus	Ex 14:16 But lift up your rod, and stretch out your hand over the sea and divide it (A’) .
	Ex 14:19-20 ... and the pillar of cloud ... So it came between the camp (B’) of the Egyptians and the camp of Israel. Thus it was a cloud and darkness to the one, and it gave light [like a burning torch] by night to the other ...
	Ex 14:22 and the Israelites went through the sea on dry ground, with a wall of water on their right and on their left (D’) . NIV
	Ex 14:24 the LORD looked down from the pillar of fire and cloud at the Egyptian army and threw it into confusion (C’) . NIV

Covenant between the parts	⇌ ⇐	Exodus
Abraham cut the animals in two	A – A’	Moses splits the sea in two
Abraham placed the pieces opposite to each other	B – B’	the camp of Israel faced the camp of the Egyptians
Abraham drove away the vultures	C – C’	God threw the Egyptian army in confusion.
A burning torch passed between the pieces	D – D’	pillar of fire following the Israelite while they crossed the split sea.

A journey that lasted 430 years (in 6 steps)
(Covenant between the parts to Exodus)

(1) For the first time Abraham received a covenant

- Gen 15:18 On the same day the LORD made a covenant with Abram, saying: "To your descendants I have given this land, from the river of Egypt to the great river

(2) that was accompanied by a **sign**

- Gen 15:9-10 So He said to him, "Bring Me a three-year-old heifer, a three-year-old female goat, a three-year-old ram, a turtledove, and a young pigeon." Then he brought all these to Him and cut them in two, down the middle, and placed each piece opposite the other; but he did not cut the birds in two. NKJV

(3) And in order to inaugurate (and seal) this covenant, **God blazing torch went through the animal parts.**

(4) **And 430 years went by**

Ex 12:40-41 Now the sojourn of the children of Israel who lived in Egypt was four hundred and thirty years. ... all the armies of the LORD went out from the land of Egypt.

NOTE: Ex 12:40 seems to say that the children of Israel lived in Egypt for 430 years but with the proper punctuation the expression 'who lived in Egypt' become a distinctive mark that should be associated with the 'children of Israel' rather than the 'sojourn'.

→ Now the sojourn of the children of Israel, who lived in Egypt, was 430 years...

Here the word used by the translators to describe what the children of Israel were doing for 430 years is 'sojourn' (or 'dwelling'). Wouldn't the text be better served with a word like 'journey'?

→ Now the 'journey' of the children of Israel, who lived in Egypt, was 430 years...

(5) God remembered the covenant and was ready to give the Israelites their land:

- Ex 6:4-5 I have also established My covenant with them, to give them the land of Canaan, the land of their pilgrimage, in which they were strangers. And I have also heard the groaning of the children of Israel whom the Egyptians keep in bondage, and I have remembered My covenant. NKJV
- Ex 6:8 and I will give it to you as a heritage NKJV

(6) Prior receiving the object of the covenant⁶² that was sealed when God went through the parts, the Israelites **went through the sea, which had been physically split.** (We have here a clear reminder of the true origin of this covenant.)

- Ex 14:16 But lift up your rod, and stretch out your hand over the sea and divide it. And the children of Israel shall go on dry ground through the midst of the sea. NKJV

⁶² that is : the land

The dismissal of Hagar (the Egyptian's slave)

The Exodus also echoed another event that occurred during the very same year that the covenant between the parts was performed. This event is related to Hagar, the Egyptian slave.

D I S M I S S A R L	<p>An (A) <u>Egyptian slave</u> was (B) <u>mistreated</u> by her (C) <u>Hebrew mistress</u>. She (D) <u>fled</u> into the (E) <u>desert</u> where she was met by an (F) <u>angel</u> while she rested near a (G) <u>spring</u> on the road to (H) <u>Shur</u>.</p> <p>Gen 16:6-7 " Then Sarai mistreated Hagar; so she fled from her. The angel of the LORD found Hagar near a spring in the desert; it was the spring that is beside the road to Shur NIV</p>
--	--

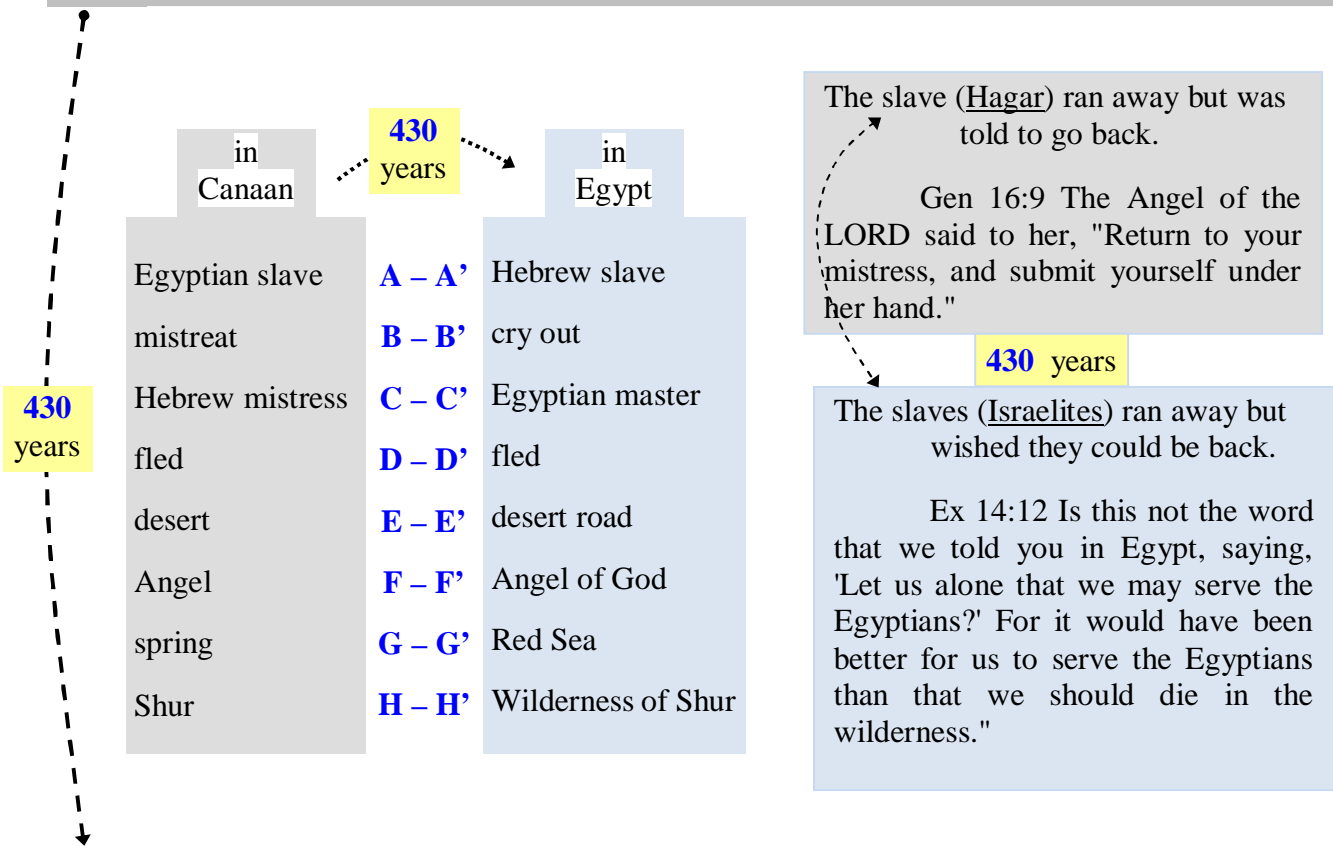

E X O D U S	<p>Ex 3:7 "I have indeed seen the misery of my people [A' <u>Hebrew slave</u>] in Egypt. I have heard them B' <u>crying out</u> because of their slave drivers [C' <u>Egyptian master</u>], and I am concerned about their suffering.</p> <p>Ex 13:18 So God led the people around by the E' <u>desert</u> road toward the <u>Red Sea</u>.</p> <p>Ex 14:5 When the king of Egypt was told that the people D' <u>had fled</u>,</p> <p>Ex 14:19 Then the F' <u>angel of God</u>, who had been traveling in front of Israel's army, withdrew and went behind them.</p> <p>Ex 15:22 So Moses brought Israel from the G' <u>Red Sea</u>; then they went out into the H' <u>Wilderness of Shur</u>.</p>
----------------------------	---

A subordinate journey that lasted 400 years

(From Akedah to Exodus)

With the link between ‘Covenant between the parts’ and ‘Exodus’ established we are now well positioned to determine with absolute certainty the origin of the 400 years of Gen 15:13.

- Gen 15:13 Then He said to Abram: "Know certainly that your descendants will be strangers in a land that is not theirs, and will serve them, and they will afflict them **four hundred years**. NKJV

Going backward 400 years from Exodus brings us to a point in time that is 30 years after the Covenant between the parts. From the chart lay out on page 79 we can deduce that **Isaac was then 15 years old**, a non event that wouldn't qualify as a meaningful start for the 400 years. But suppose Isaac was 15 years old when he was sacrificed by Abraham! (The Jews refer to this event as ‘the binding of Isaac’ and call it by the Hebrew word ‘**AKEDAH**’)

The Bible doesn't give any direct chronological link to Isaac's binding. Isn't it surprising when we think about it? Isn't it quite inconceivable that the biggest act of obedience and faith ever described in the Bible, the most important symbolic act, an act that would be mirrored at Yeshua's death, wouldn't be accurately dated when more than 300 chronological references are available to chart all kinds of other events? Could the true origin of the 400-year period coincide with the time of the binding of Isaac? Is there any other event that could be more meaningful to mark the beginning of this important period?

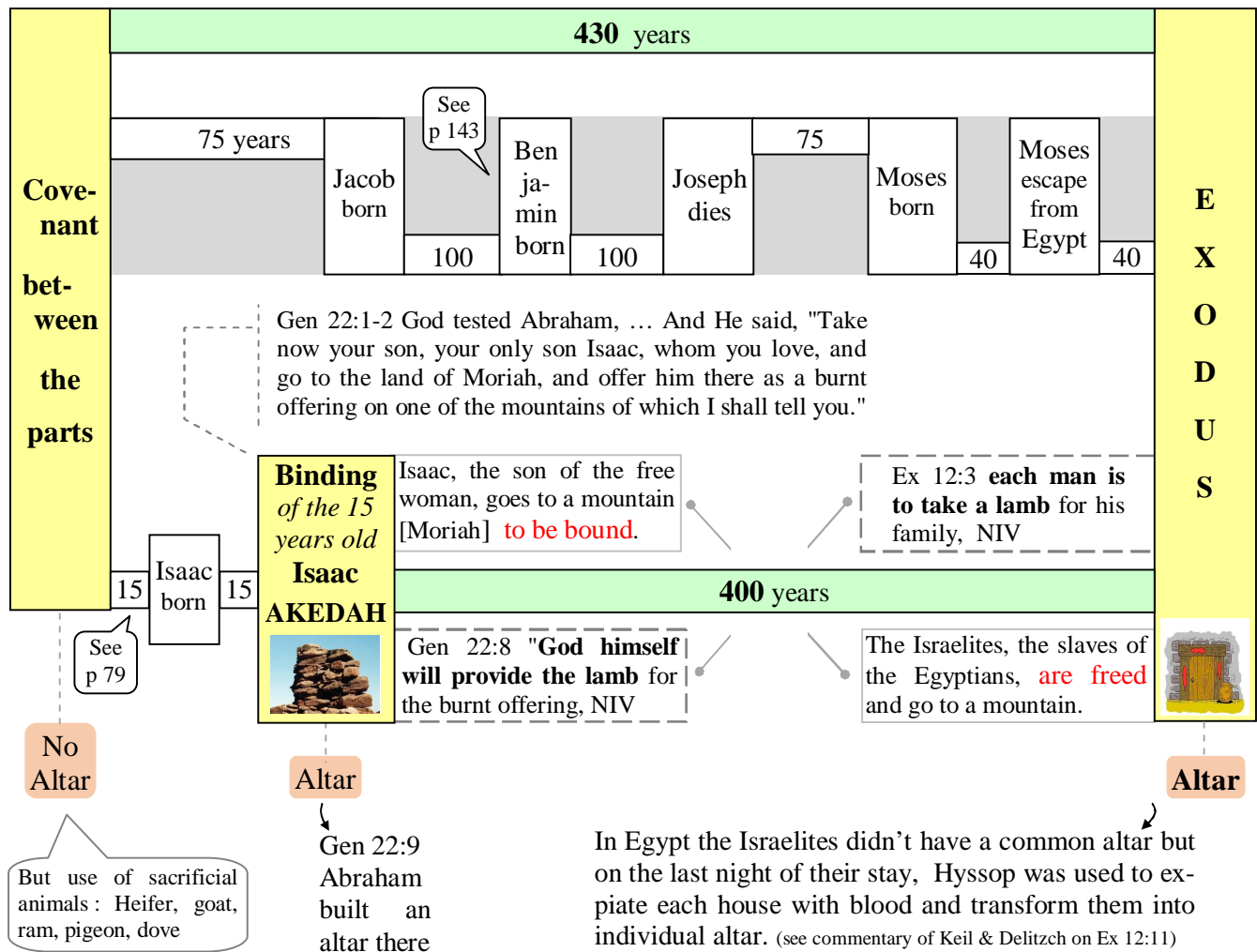

In Gen 15:13 we are told that the 400-year period has to do with the whereabouts of Abraham's **descendant**. At first glance an event like the birth of Isaac, the first Abraham legitimate son, would be the perfect candidate to initiate this 400-year period. Unfortunately the preceding chart shows that it was not the case given that Isaac was already 15 years old when the 400-year period started. But we will see that the sacrifice of Isaac, if it happened when this one was 15 years old, is a much better choice to initiate the period.

First a few facts to show that Isaac was neither an infant nor an adult at the time of the binding. One can say that at 15 years old, he was in the right age range.

Old enough to worship

- Gen 22:5 We will worship and then we will come back to you." NIV

Strong enough to hold all the wood

- Gen 22:6 Abraham took the wood for the burnt offering and placed it on his son Isaac, NIV

Still young enough to be called "boy"

- Gen 22:5 He said to his servants, "Stay here with the donkey while I and the boy go over there. NIV

NOTE: w^ahana`ar the Hebrew word translated here as "the boy" could describe Isaac any period from the age of infancy to adolescence.

We are told that God would establish a covenant with Isaac.

- Gen 17:19 I will establish My covenant with him [Isaac] for an everlasting covenant, and with his descendants after him. NKJV
- Gen 17:21 1 But My covenant I will establish with Isaac, NKJV

We are also told that Abraham and Isaac would be involved (together?) in a covenant and a promise.

- 1 Chron 16:16 The covenant which He made with Abraham, And His oath to Isaac, NKJV
- Ps 105:9 the covenant he made with Abraham, the oath he swore to Isaac. NIV

We know that a covenant was confirmed to Abraham at Akedah.

- Gen 22:15-17 The angel of the LORD called to Abraham from heaven a second time and said, "I swear by myself, declares the LORD, that because you have done this and have not withheld your son, your only son, I will surely bless you.. NIV

Could it be that Isaac was also chosen during Akedah?

Isaac's relationship with his father Abraham culminated at Akedah. The only bonding activity between them, that was ever documented in the Bible, was their three days' journey to Mt. Moriah. During this trip Abraham's sadness must have been almost unbearable. How could it have been different? He had just been asked to do the most difficult thing ever: to show his

unfaltering obedience to God by voluntarily killing the unexpected son of his old age, the only son he shared with Saraï, a son that he loved⁶³ very much. At age 15, Isaac was old enough to understand what was going on and if he had ever witnessed his father making a sacrifice to God in the past, he must have sensed that this time something was quite different.

- Gen 22:7 "The fire and wood are here," Isaac said, "but where is the lamb for the burnt offering?"

Whether he had known for some time or had only learned at the last minute that he would be the Sacrificial lamb, it didn't make any difference. Isaac never offered any resistance and he followed his father, unrestrained, to the top of the mountain where an altar would be built.

- Gen 22:5 Stay here with the donkey while I and the boy go over there.

Thirty years after the Covenant 'between the parts' Abraham was 115 years old (see Figure 13 Abraham timeline on page 79) and he would never have been able to bind his 15 year old son if this one had refused to cooperate. Isaac could have found many opportunities to run away but he was a consenting victim and he walked the last stretch to the altar by himself.

- Gen 22:9 He bound his son Isaac and laid him on the altar, on top of the wood.

The sacrifice of Isaac was a request so well chosen that it allowed both, Abraham and Isaac, to independently prove to God their worthiness during the same event.

- ❖ Abraham demonstrated his total submission by offering his son in sacrifice.
- ❖ Isaac demonstrated his total submission by accepting to be the sacrifice.

At Akedah Isaac didn't object to his father's plan and he fully accepted that he was going to die. In fact, he came so close to death that one can say that symbolically **he did die that day**. But then, **if there was a symbolic death, there was also a symbolic resurrection**, a new beginning. Indeed, Isaac inherited his father's covenant that very same day.

- Gen 15:13 Then He said to Abram: "Know certainly that your **descendants** will be **strangers** in a land that is not theirs, and will serve them, and they will afflict them **four hundred years**. NKJV

The only remaining question before one can fully accept that Akedah is at the origin of the 400-year period is the following. Did Isaac, the new born descendant, begin this new journey by being a **stranger** in a land that was not his? The answer is: Absolutely! Have you noticed that Isaac never returned home with his father?

- Gen 22:19 Then Abraham returned to his servants, and they set off together for Beersheba. And Abraham stayed in Beersheba. NIV

In fact 25 years⁶⁴ will pass before we hear (Gen 24:62) that Isaac had been living in the Negev and is about to meet his future wife. It seems that, after Akedah, Isaac's whole life was spent in the wilderness.

⁶³ Gen 22:2 "Take your son, your only son, Isaac, whom you love

⁶⁴ we just saw that Isaac was 15 at Akedah and according Gen 25:20 he was 40 years old when he married Rebekah.

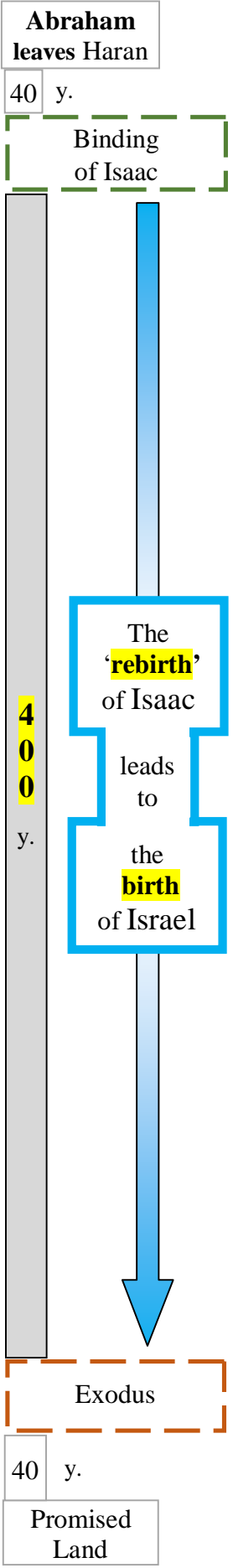

Instead of dying during the sacrifice, Isaac was saved at the last second. This symbolic **rebirth** is the most appropriate start for the **400 years** found in:

Gen 15:13 "Know certainly that your **descendants** will be strangers in a land that is not theirs, and will serve them, and they will afflict them **400 years**."

Heb 11:19 Abraham reasoned that God could raise the dead, and figuratively speaking, he did receive Isaac **back from death**.

Gen 28 :3 May God Almighty bless you and make you fruitful and increase your numbers **until** you **become** a community of **peoples**

To God, the **whole community of Israel** is viewed as a **firstborn son**:

Ex 4:22-23 Israel is my firstborn son, and I told you, "Let my son go"

The 'Childbirth Metaphor'

On the night before they left Egypt, the Israelite's houses became like the womb of pregnant women ready to give birth after 40 weeks. (40 w. VS 400 y.)

1. Pharaoh had increased the people's **labor**. Ex 5:9 | Beginning of birth pains for a woman
2. In the 1st **plague** all the **water** of Egypt were changed to blood, freedom was at the 10th. Ex 7:20 | When her **water breaks**, a woman knows that the child delivery process has just started.
3. Men waited with the loins girded (**legs free**) Ex 12:11
4. Eating in **haste** Ex 12:11, (**impending event**). Unleavened bread picturing the urgency of the situation and the lack of time for the leavening process.
5. Through Egypt **'wailing'** was heard Ex 11:6 | Period of active labor for a woman
6. Early in the morning, people went out through a **bloody entrance**. Ex 12:7 | Birth of the child
7. That day God **delivered** the nation Ex 14:13 | The midwife helps to deliver the baby during the birth.
8. Any meat **left over** had to be completely burned before the morning (Ex 12:10) . | Women's afterbirth need to be disposed of (buried or burned).
9. In the morning, the Egyptians **gave the Israelites women pieces of clothing** for their children. Ex 3:22
10. The Day of Exodus, similar to a **child birthday**, is an event that is regularly **commemorated**. Ex 13:3
11. In Ex 12:34 the people wrapped their 'unleaven' dough in cloaks and carried it on their shoulders. | A mother would carry her 'sinless' newborn, wrapped in cloths, over her shoulder.
12. On the 8th day (?) Moses divided the sea by stretching his hand and the people walked through it. | A Jewish baby is circumcised on the 8th day and is 'traditionally' named on that day.
13. God took care of his first born (Israel) and He **fed him** in the desert Ex 16:8.
14. And "As a man **disciplines** his son, so the LORD your God disciplines you. Deut 4:36 "

While the first born of the Egyptian were dying, those of the **Israelites** were miraculously protected. Figuratively speaking, similar to Isaac, the Israelites were received **back from the dead**.

Metaphor
of a child delivery

1	Labor increase
2	Water breaks
3	clear legs
4	Impending event
5	Wailing
6	Bloody exit
7	Delivery
8	Afterbirth
9	Gift received
10	Day to remember
11	Carry the baby
12	Circumcision
13	Nursing
14	Discipline

The 430 years and 400 years countdown from Exodus

on P. 173

Covenant between the parts
Gen 15:18 To your descendants I give this land

(Cutting Into 2- parts Gen 15:10)

A covenant involves 2 parties	God binding part of the covenant	A covenant involves pouring blood
	Abraham binding part of the cov..	

Blazing torch Gen 15:17



Gen 22:10

Fire on the altar Gen 22:9

Binding of Isaac 'Akedah'

430

Ex 12:40 Now the sojourn of the children of Israel who lived in Egypt was **430** years.

Gen 15:13 and they will be enslaved and **mistreated 400** years.

Isn't Isaac's **binding** the most obvious way to start this 400 years of 'mistreatment'?

Exo.14:16

Pillar of fire Exo 14:24

EXODUS
(Cutting the sea in 2 parts)

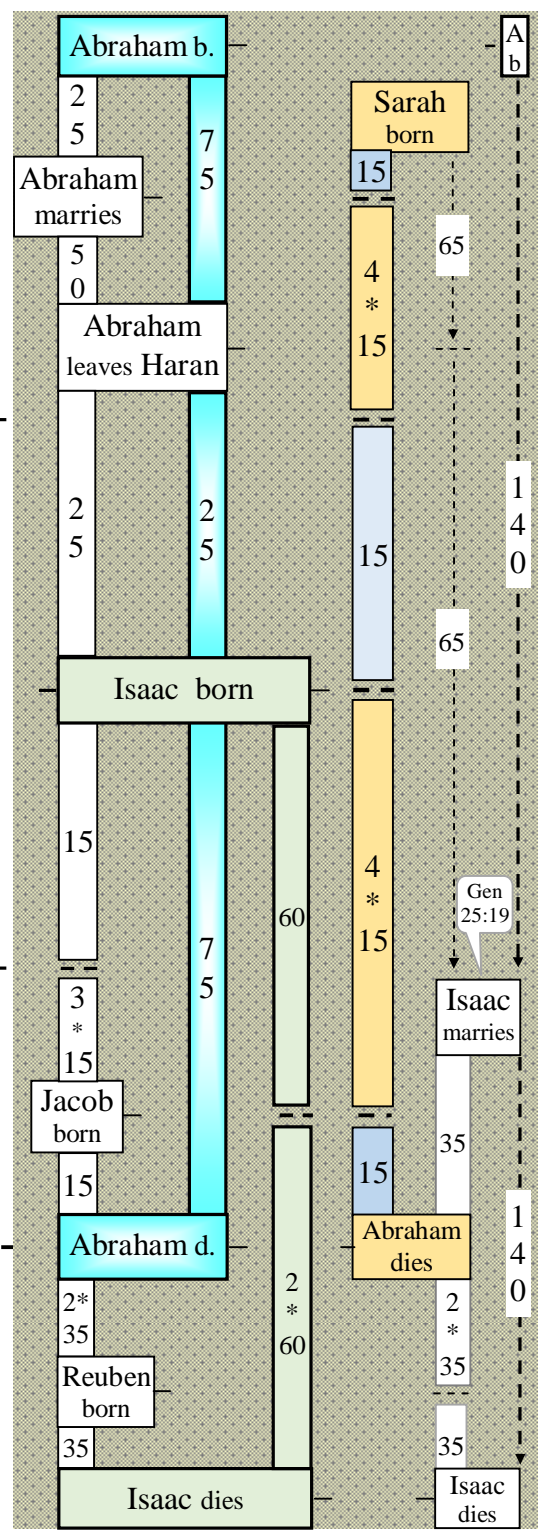

Rebirth of Isaac
Israel becomes God **firstborn**

Ezekiel shaves his hair

Ezek 5:1-3 "And you, son of man, take a sharp sword, take it as a barber's razor, and pass it over your head and your beard; then take balances to weigh and divide the hair. You shall burn with fire one-third in the midst of the city, when the days of the siege are finished; then you shall take one-third and strike around it with the sword, and one-third you shall scatter in the wind: I will draw out a sword after them. NKJV



We learn in Ezekiel 5:12 that everything that was done with the hair (i.e. Burn, Strike, Scatter) would also be done to the population of Jerusalem:

- Ezek 5:12 One-third of you shall die of the pestilence, and be consumed with famine in your midst; and one-third shall fall by the sword all around you; and I will scatter another third to all the winds, and I will draw out a sword after them. NKJV

The purpose of having Ezekiel shave his hair was to use the hair to show how the people of Jerusalem would be punished. The whole action could have been done without interruption right after Ezekiel's 430-day siege.

Unexpectedly it was done differently

Ezekiel was told to shave all his hair and (see Ezek 5:2) **wait until the end of his siege** before using the hair to portray future events. How do we know that he was told that **before** his siege? If the siege had already been mimicked, there wouldn't have been any point in telling him to wait **until** the end of his siege to dispose the hair

Ezek 5:2 You shall burn with fire one third in the midst of the city, **when the days of the siege are finished**; NKJV

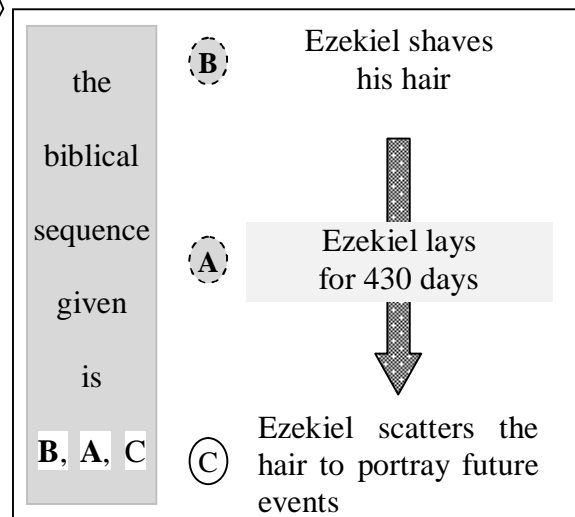
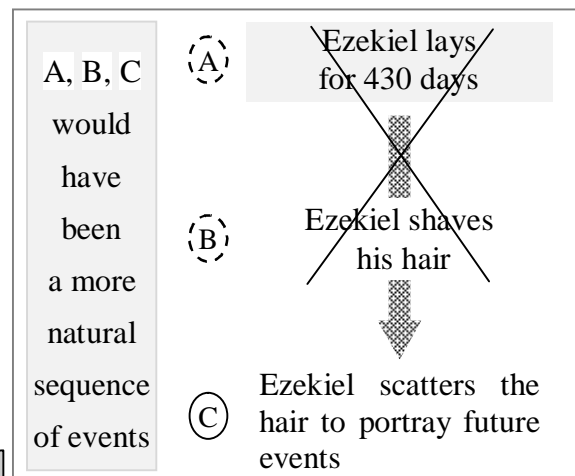

Why was a ‘delay of 430 days’ introduced between the shaving and the scattering of the hair? What could possibly justify that the shaving was done so early and the ‘disposing’ so much later? In this paper, we have previously seen that many symbolic acts took place at the beginning of Ezekiel’s siege. Was there also a symbolic act associated with the ‘shaving’ itself? Yes.

In order to find out where the ‘shaving action’ is meant to lead us, we first need to understand how deeply humiliating the shaving of his head and beard must have been felt by Ezekiel:

- Lev 21:5-6 They shall not make any bald place on their heads, nor shall they shave the edges of their beards nor make any cuttings in their flesh. They shall be holy to their God NKJV
- 2 Sam 10:4-5 Therefore Hanun took David's servants, shaved off half of their beards, cut off their garments in the middle, at their buttocks, and sent them away. When they told David, he sent to meet them, because the men were greatly **ashamed**. And the king said, "Wait at Jericho until your beards have grown, and then return." NKJV

To have his beard and hair shaved was a **humiliating** experience for a priest and even though he was only performing a symbolic act there is no reason to believe that Ezekiel would have felt differently at the start of his 430-day siege. The keyword to understand this new symbolic act is ‘humiliation’. We have to find a period of 430 years, initiated by an event that turned out to be greatly humiliating for the whole House of Israel. This event can be found without too much difficulty for it had a tremendous effect on the Israelites:

It is the **capture of the Ark** by the Philistine (1 Sam 4:10-11):

- 1 Sam 4:13 And when the man came into the city and told it, all the city cried out.

What should have been a day of victory for the people of Israel turned out to be a day of great stupefaction, confusion and humiliation. This was prophesied earlier by Samuel:

- 1 Sam 3:11 Then the LORD said to Samuel: "Behold, I will do something in Israel at which both ears of everyone who hears it will tingle⁶⁵. NKJV



The daughter of Eli, who gave birth that day, named her child in relation to this event:

- 1 Sam 4:21 Then she named the child Ichabod, saying, "The glory has departed from Israel!" because the ark of God had been captured

Notice here the perfect relationship between

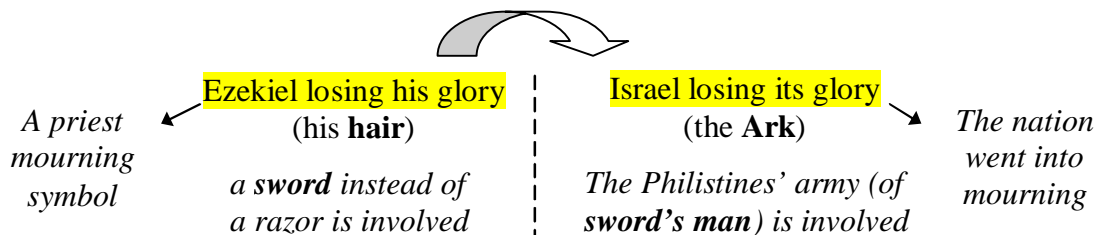

⁶⁵ According to Strong’s definition (6750) tingle carries the idea of ‘vibration’ of the ears in reddening with shame.

Searching for the end of the 430 years 'shaving act'

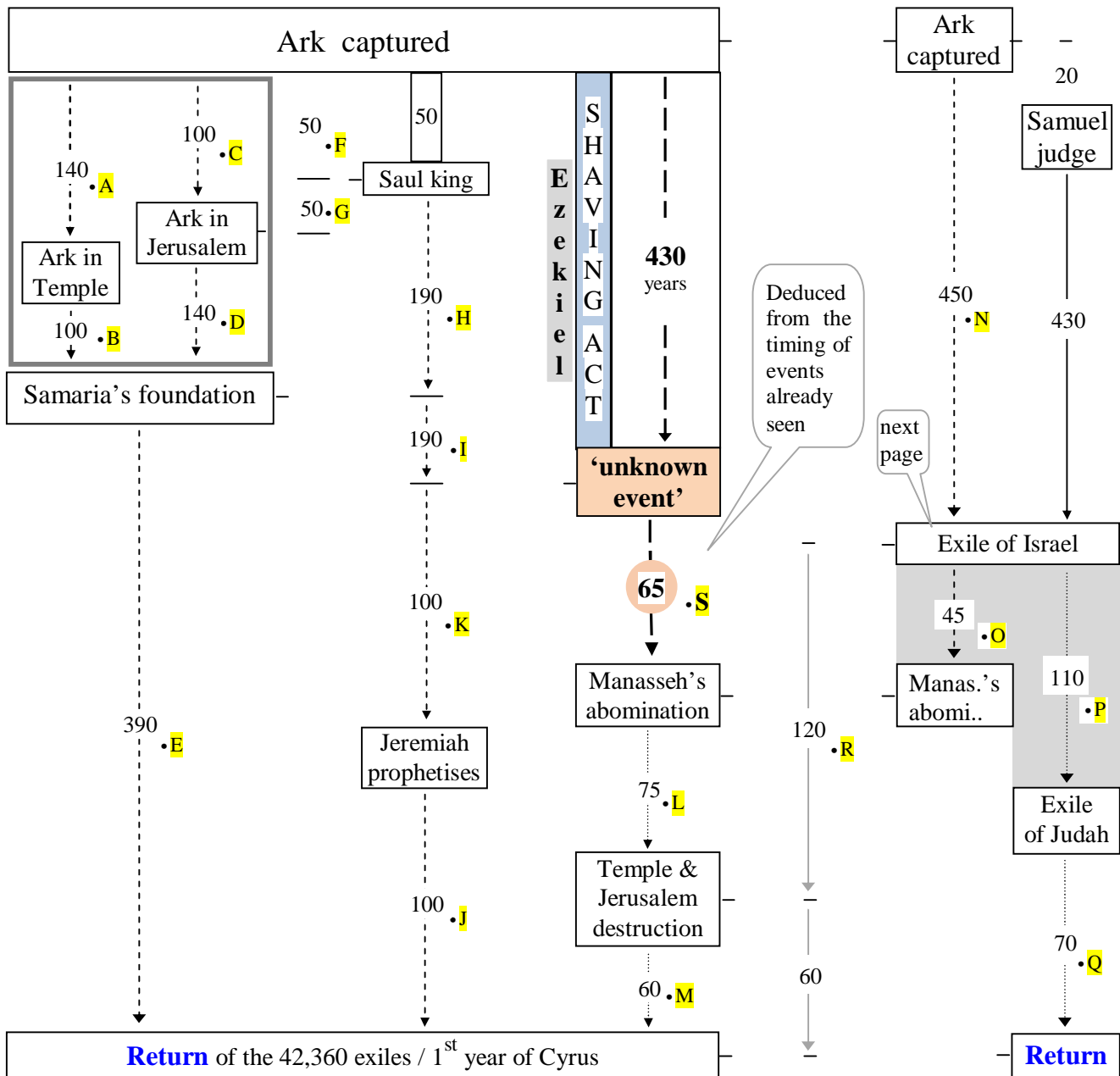

Figure 14. Shaving act

References:

- a See on page 63
- b See on page 70
- c See on page 77
- d See on page 77
- e See on page 77
- f See on page 55
- g C100 – f50
- h c 100 + d 140 – f 50

- i 430 – f50 – h 190
 - j see page 71
 - k e 390 – i 190 – j 100
 - L see page 61 (40 + 35)
 - m see page 70
 - n see page 77
- (100+140+210)

- o see page 92
- p see page 92
- q see page 71
- r o45 + L75
- S a 140 + b 100 + e 390
- 430 – L 75 – m 60

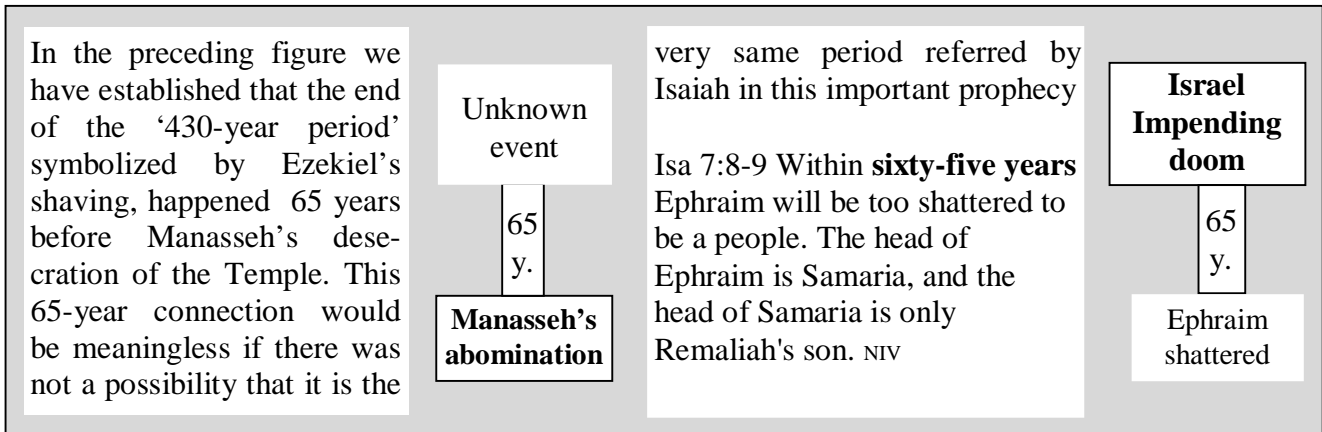

The following figure shows that Isaiah's prophecy (referred by me as Israel impending doom) was told, very likely, 65 years before the Temple's desecration by Manasseh. The prophecy was told at the beginning of king Ahaz's kingship in answer to the threat represented by king Pekah.

Isa 7:3-4 Then the LORD said to Isaiah, "Go out, you and your son Shear-Jashub, to meet Ahaz at the end of the aqueduct of the Upper Pool, on the road to the Washerman's Field. 4 Say to him, 'Be careful, keep calm and don't be afraid. NIV

And it could not have been told after the 20th year of Pekah given that this king reigned only 20 years.

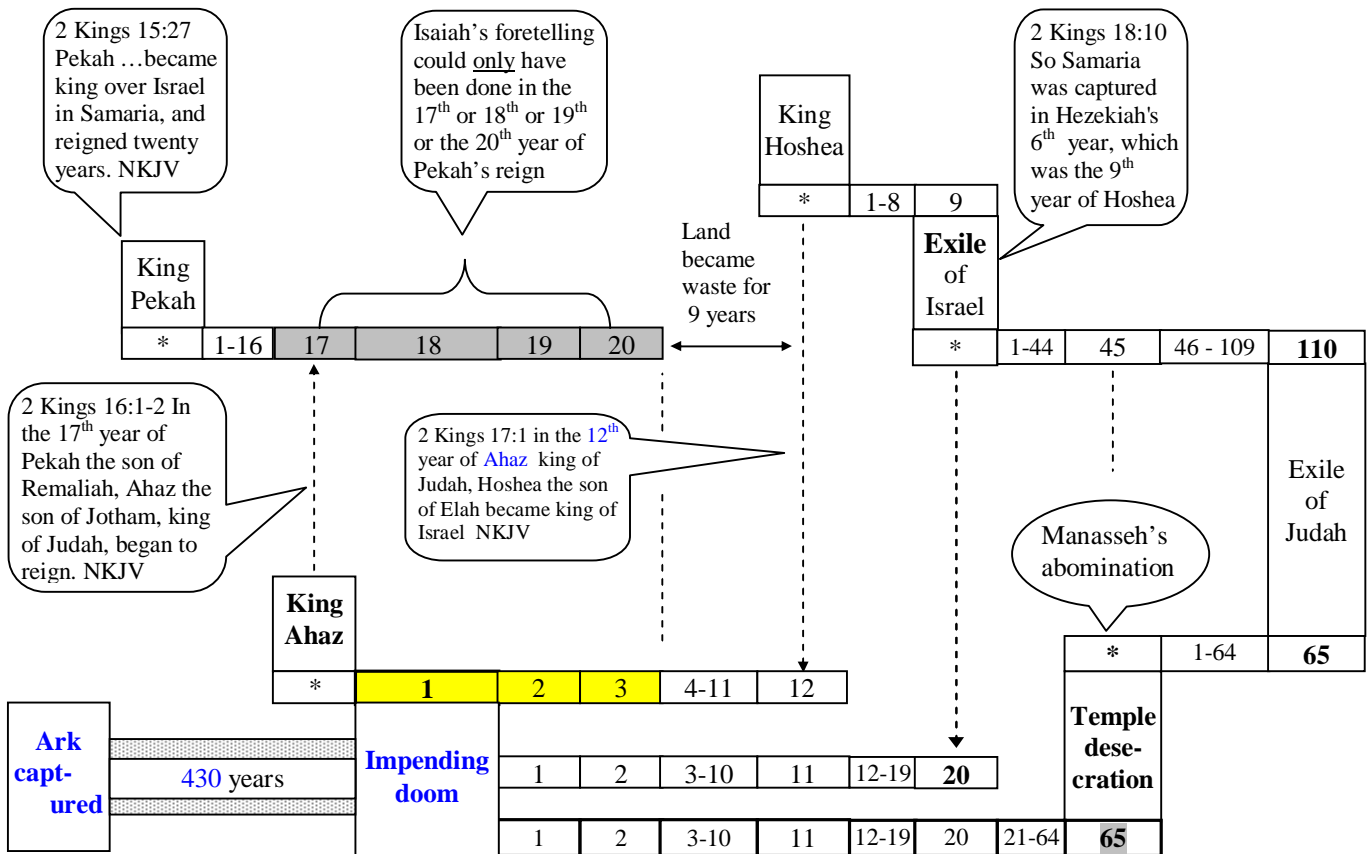

In the preceding figure, in spite of the fact that it could also have been told in the second or third year of Ahaz, it is 'postulated' that Isaiah's prophecy was delivered in the **first** year of King Ahaz. Note that Isa 7:16 implies that between the time the prophecy was delivered and the end of King Pekah's kingship, a boy would have matured enough to know right and wrong.

If the 'capture of the Ark' is an event that could match the humiliation suffered by Ezekiel when he had to shave, we haven't yet justified that the announce of 'Israel impending doom' is the appropriate event to close the 430-year period. This will be addressed shortly.

When Isaiah told King Ahaz that within 65 years Israel (i.e. Kingdom of Israel) wouldn't be a 'people' anymore, he was certainly not referring to the time Israel would go in exile. If the reader looks at the preceding figure he will notice that Israel went into exile only 20 years after the announcement of the impending doom. The question that should be asked is: Why then did Isaiah allude to a time that was 45 years (65 – 20) after the Exile of Israel? The answer is that even though Israel was sent into Exile 20 years later (in the 9th year of Hosea) it is assumed that many people (from the northern tribes) had been left in the land and it would take another 45 years to remove their identity.

In 2 Chron 30:5-6 King Hezekiah of Judah, in preparation for a very special Passover (5 years after Israel went in captivity) is sending couriers all over Israel's territories to invite people to the feast in Jerusalem:

- 2 Chron 30:5-6 They decided to send a proclamation throughout Israel, from Beersheba to Dan, calling the people to come to Jerusalem and celebrate the Passover to the LORD, the God of Israel. It had not been celebrated in large numbers according to what was written. At the king's command, couriers went throughout Israel and Judah NIV

Two important facts have to be kept in mind:

1. Hezekiah wouldn't have dared to send couriers into the northern territories if King Hoshea had still been ruling over the land. Therefore, we can only conclude (without the need of any timeline) that the Exile had already taken place.
2. Hezekiah wouldn't have sent couriers if nobody had been living in these territories at that time. Thus we can deduce that not all the northern Israelites were gone already.

The Exile of Israel (northern ten tribes) that took place in the 9th year of Hoshea was not enough to completely eradicate the name of Ephraim's kingdom; many people (Israelites) were still living in the territory after that Exile. Isaiah was in fact predicting that it would take another 45 years after the Exile to fully erase the Northern Kingdom's identity once and for all. How did it happen? It is believed that at the time of Manasseh's temporary captivity

- 2 Chron 33:10-11 The LORD spoke to Manasseh and his people, but they paid no attention. So the LORD brought against them the army commanders of the king of Assyria, who took Manasseh prisoner, put a hook in his nose, bound him with bronze shackles and took him to Babylon. NIV

the King of Assyria took that opportunity to resettle (exchange) people all over the territory:

- Ezra 4:2-3 they came [people living in the land at that time] to Zerubbabel ...and said, "Let us help you build because, like you, we seek your God and have been sacrificing to him **since the time of Esarhaddon king of Assyria, who brought us here.**" But Zerubbabel, Jeshua and the rest of the heads of the families of Israel answered, "**You have no part with us** in building a temple to our God. NIV

Now that the connection between 'Israel impending doom', the desecration of the Temple and Manasseh's captivity is better understood, we can investigate why this 'foretelling' is the appropriate event to close the 430-year period initiated with the capture of the Ark.

The scattering of Ezekiel's hairs is matched by Isaiah's foretelling

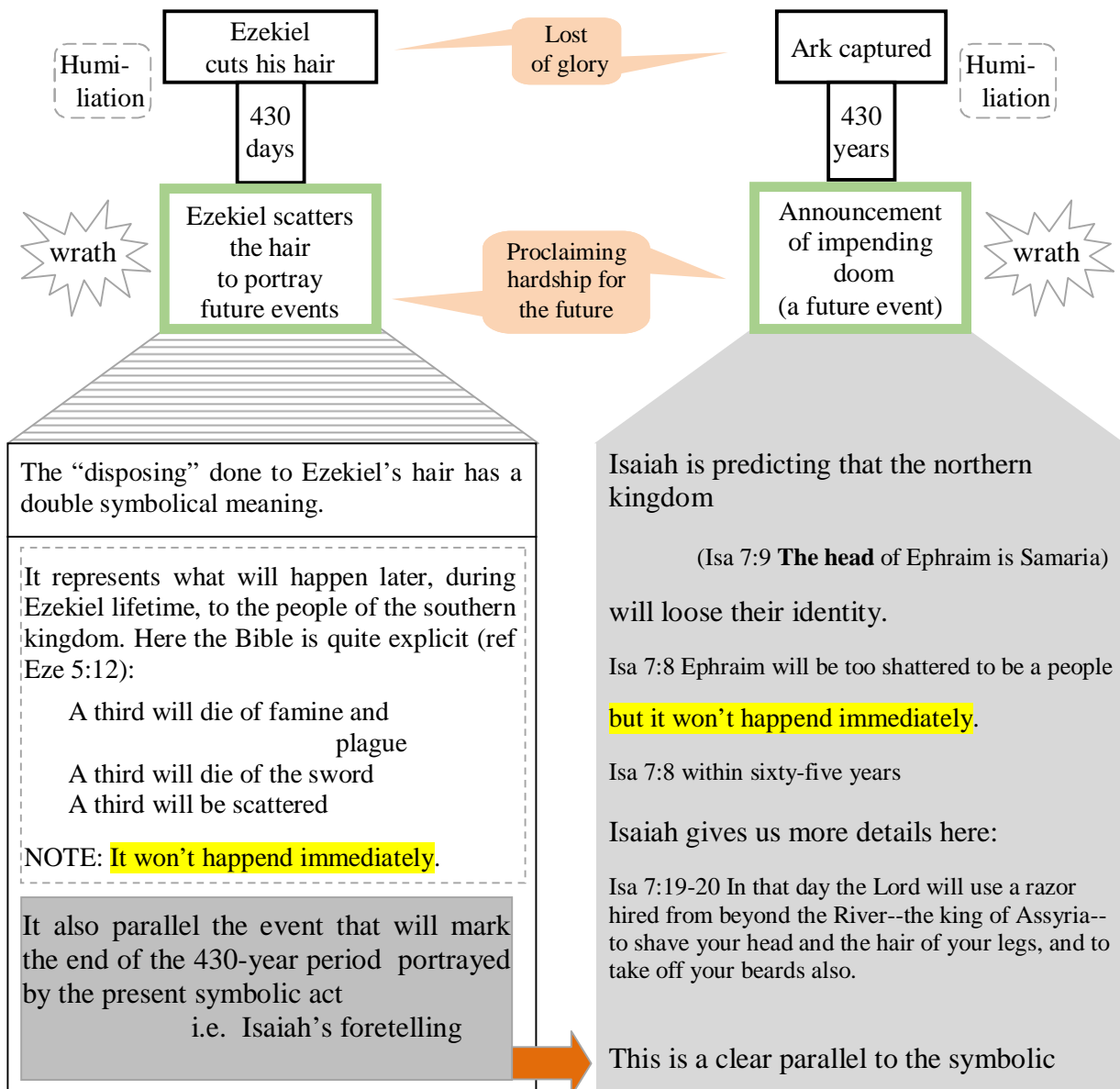

language used in Ezekiel. (Shave, razor, hair, beard).

If Jeremiah can equate ‘**scattering**’ (casting the hair) with ‘**rejecting Judah**’

Jer 7:29 Cut off your hair and **throw it away** ... for the LORD **has rejected** and abandoned this generation.

then, when Isaiah tell us that God will **reject Israel**

Israel won't be a people
The King of Assyria will be a razor

we can picture him (Isaiah) **scattering** some hair too.

Contrary to the other symbolic acts of Ezekiel that we have seen in this paper, the **shaving** act (i.e. cutting & disposing of) was not continuously carried on over the whole period of time that Ezekiel lay on his side. Even though it is true that the two actions (cutting & disposing of) were separated by the 430 days of his siege⁶⁶, each action was fully completed on the day it was initiated. For instance, once he had cut off his hair (first part of the shaving act) it started growing again.

This is an important point to keep in mind while we are looking at the 430-year period following the capture of the Ark. The humiliation of Ezekiel (losing his hair) was never intended to become a permanent attribute⁶⁷ of the period he lay on his side. Therefore, there is no need to look for traces of ‘humiliation’ during the whole 430-year period that followed the capture of the Ark.

The second part of the shaving act (i.e. disposing of the hair to portray future events) and its counterpart, ‘Israel impending doom’, mirror each other adequately. When God asked Ezekiel to dispose of his hair He was sealing the fate of the people of Judah (southern kingdom). When Isaiah said that Israel would lose its identity within the next 65 years, God was also sealing the fate of the northern 10 tribes (Ephraim). Notice that in both cases there would be many years before the things announced came to pass.

Shaving act

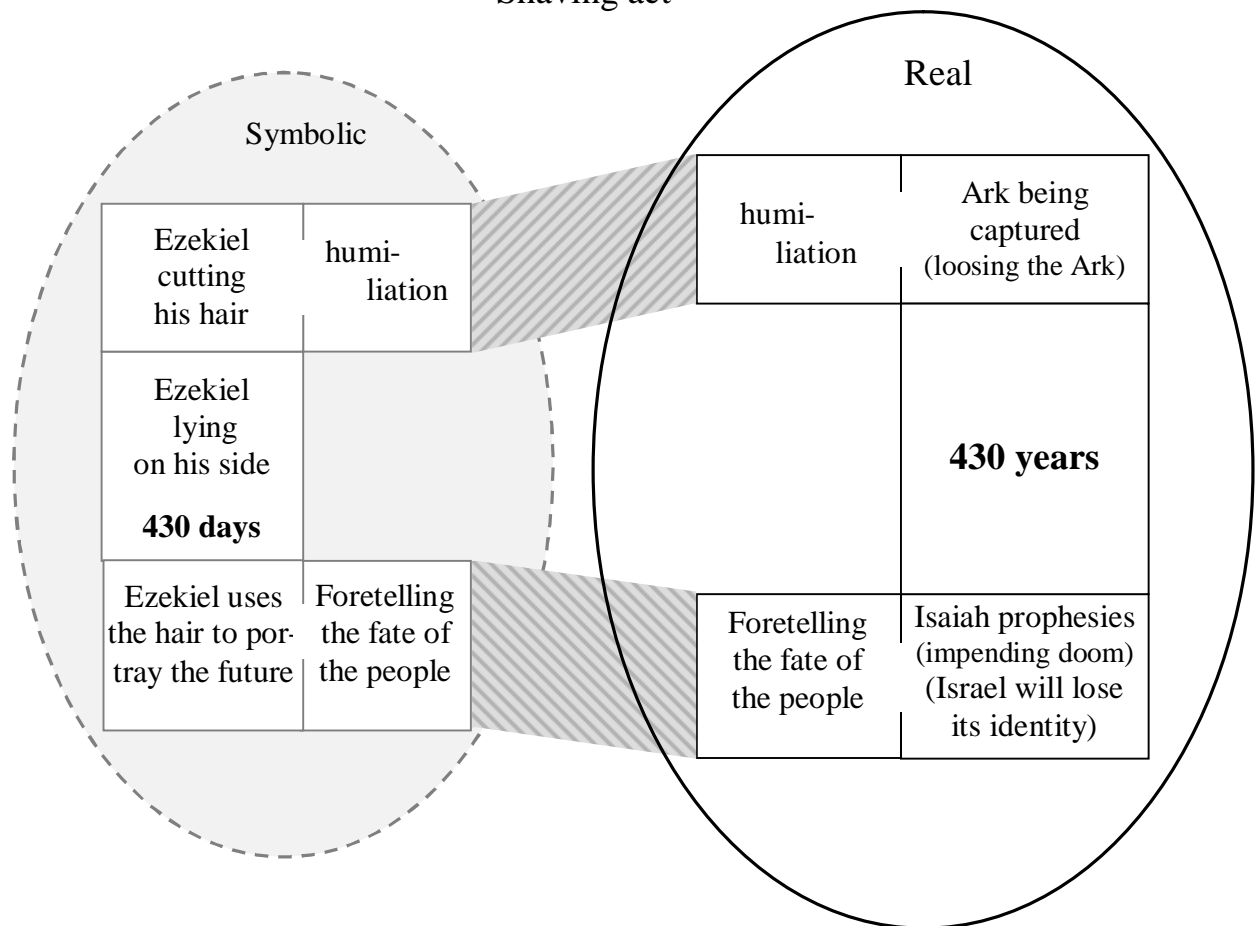

⁶⁶ Thus establishing the duration of this [‘430 days of shaving’] symbolic act.

⁶⁷ If it had been meant that way Ezekiel would have had to shave every few days during the next 430 days.

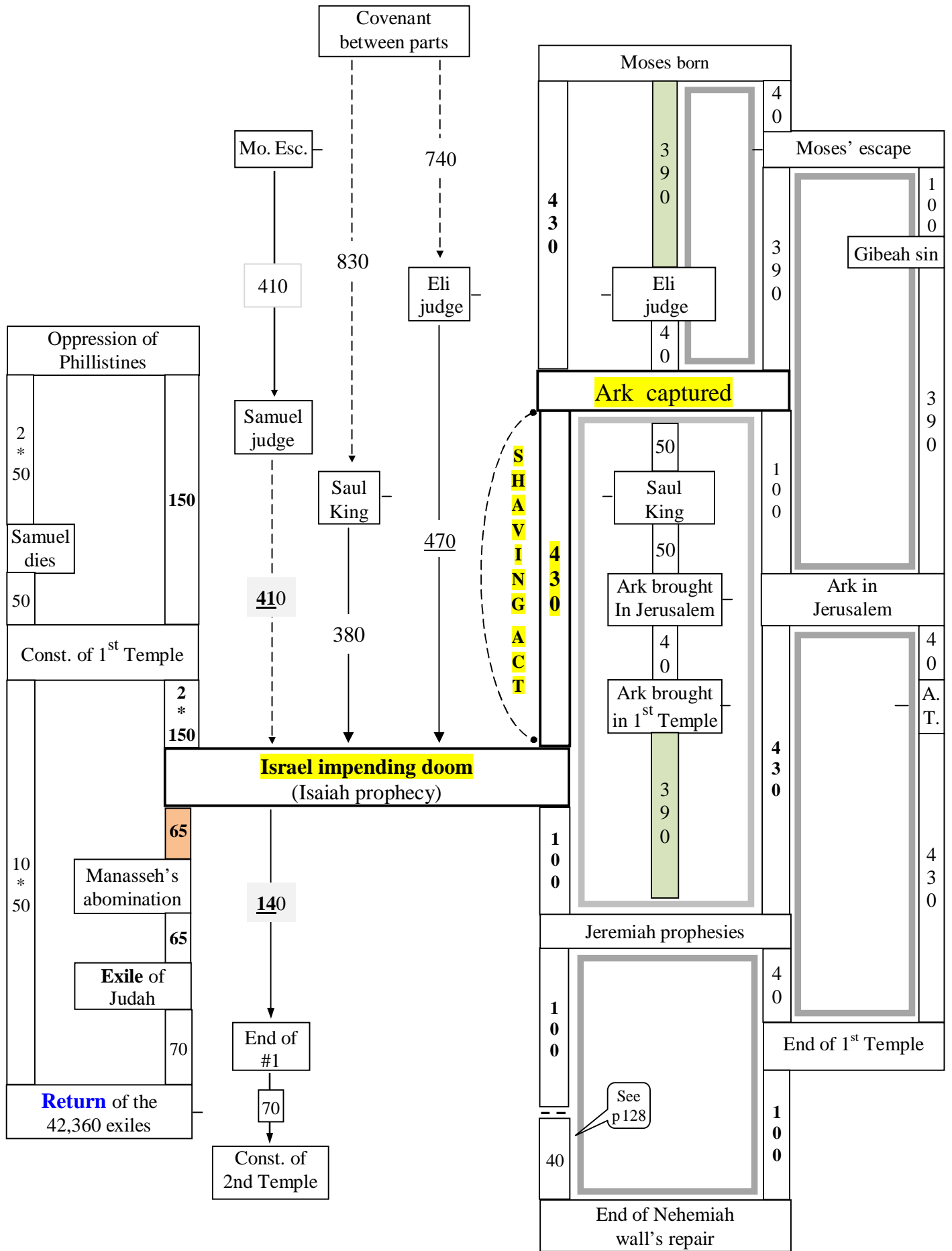

Ezekiel weighs and divides the hair

It is only when the shaving of his hair is understood as a symbolic act that we can grasp why Ezekiel had to do the ‘cutting of his hair’ at the beginning of the 430-day siege but wait until the end of that siege to use the hair to portray future events.



Ezek 5:1 "And you, son of man, take a sharp sword, take it as a barber's razor, and pass it over your head and your beard; **then take balances to weigh and divide the hair.** NKJV

Ezek 5:2 You shall **burn with fire one-third** in the midst of the city, **when the days of the siege are finished**; then you **shall take one-third** and strike around it with the sword, and **one-third you shall scatter in the wind**: I will draw out a sword after them.

Unfortunately, this knowledge doesn't explain why Ezekiel had to ‘weigh and divide’ the hair immediately after the ‘cutting’ when it would have been much more practical to perform these two actions just before the ‘dismissal’ of that hair at the end of his siege.

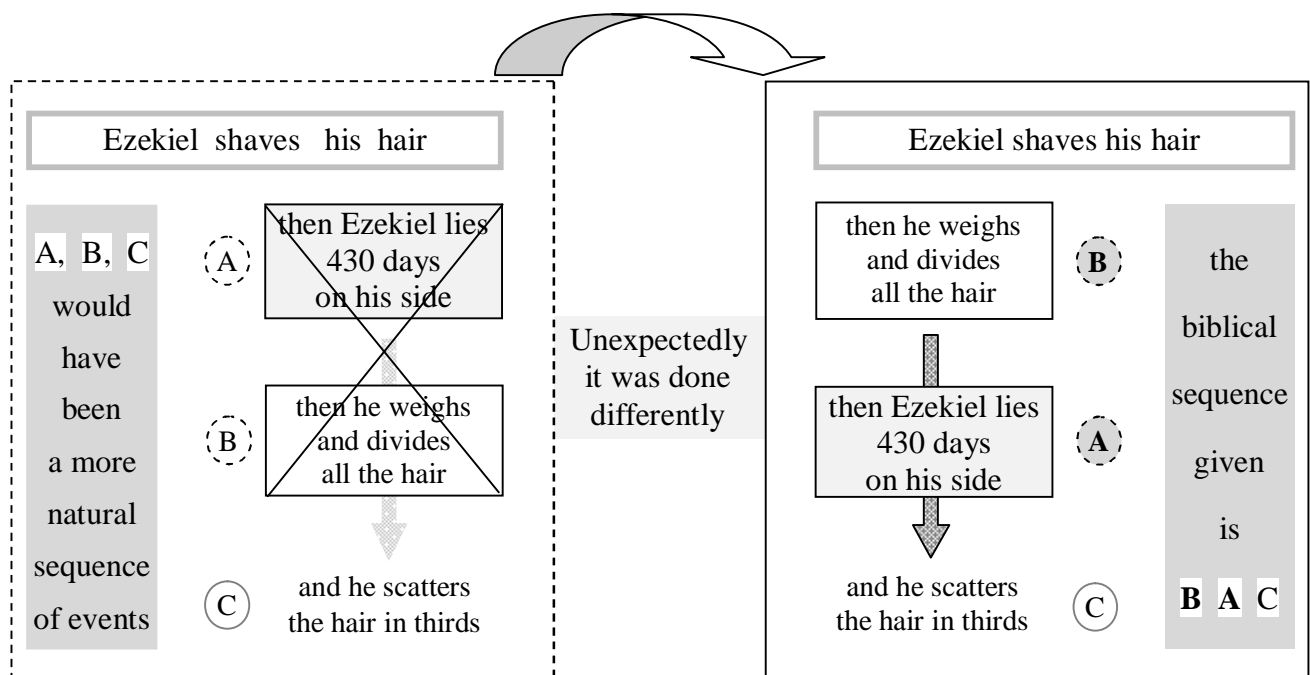

Other questions should also be asked. For instance did God ask Ezekiel to make **three bundles** of hair of the same weigh with a scale?

IMPORTANT: At the time of Ezekiel ‘scales’ were not very sophisticated. An object could be weighted against a reference mass placed on the other side of the scale.

One could also establish that an object was lighter or heavier than another by placing each one on a different pan of the scale..



It is very unlikely not to say impossible that Ezekiel could have created **three** bundles of hair of identical weight with the type of scale available at that time. It should be obvious that the ‘scale’ in Ezek 5:1 was needed for a different purpose. NOTE: Ezek 5:2 introduces the three bundles of hair only after mentioning the 430-day siege, therefore it is speculative to say that they (the three bundles) were weighted and created on the scale before that siege begun.

Another thing that seems questionable is the shaving of the beard. What did it brought that wasn’t already portrayed by Ezekiel’s humiliation when he shaved his head? More hair for the scale? I doubt there was such a need. While ‘hair’ from the head are physiologically the same as ‘hair’ from the beard both are from opposite (upper vs lower) but adjacent areas of the head. Isn’t it interesting that many symbolic acts described in this book are related to either the **Northern** Kingdom or the **Southern** Kingdom of Israel, two opposite but adjacent territories?

I suggest that the scale was meant to accentuate the separation between Ezekiel’s hair from his beard and the hair from his head. The weighting was symbolic and any quantitative value obtained was irrelevant.



But how do we reconcile the fact that, according Ezek 5:2, the hair was separated in thirds? By simply recognizing that after his 430-day siege, Ezekiel, without the scale, must have separated the hair a second time. This scenario is quite interesting as it introduces a new symbolic act ‘Weigh & Divide’ subtly imbedded in the ‘Shaving’ symbolic act seen on p. 95.

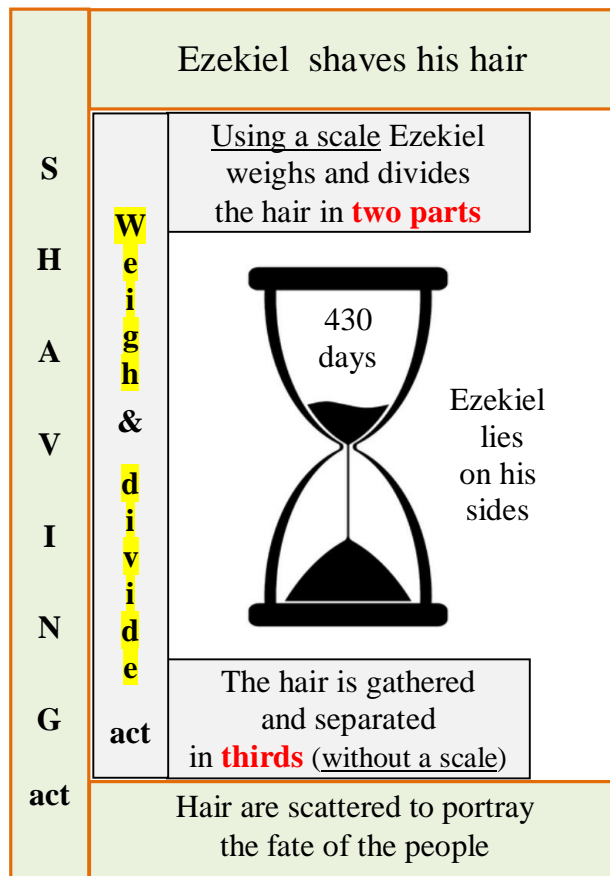

In the symbolism used by Ezekiel, ‘hair’ represents ‘people’:

Ezek 5:12 One-third of you shall ... ; and one-third shall ... ; and I will scatter another third NKJV

And ‘weighing’ could stand for ‘evaluating’:

Prov 16:2 All the ways of a man are pure in his own eyes, But the LORD **weighs** the spirits. NKJV

We have enough here to discern the two events that perfectly match the start and the end of the new ‘Weigh & Divide’ symbolical act.

START	The division of Solomon’s kingdom (in two parts)	
W e i g h t & D i v i d e 4 3 0 y.	<p>Solomon had been judged (evaluated, weighed) and found guilty; he was then told that his kingdom wouldn’t survive him:</p> <p>1 Kings 11:10-11 Therefore the LORD said to Solomon, "Because you have done this, and have not kept My covenant and My statutes, which I have commanded you, I will surely tear the kingdom away from you and give it to your servant. NKJV</p> <p>1 Kings 11:13 However I will not tear away the whole kingdom; I will give one tribe to your son for the sake of my servant David, NKJV</p> <p>1 Kings 11:30-31 Then Ahijah took hold of the new garment that was on him, and tore it into twelve pieces. And he said to Jeroboam, "Take for yourself ten pieces, for thus says the LORD, the God of Israel: 'Behold, I will tear the kingdom out of the hand of Solomon and will give ten tribes to you NKJV</p>	
	<p>Start of Babylon imperialism</p>	
	<p>time allowed for the domination by Babylon over the surrounding nations:</p> <p>Jer. 25:9-11 I will summon all the peoples of the north and my servant Nebuchadnezzar king of Babylon," declares the LORD, "and I will bring them against this land and its inhabitants and against all the surrounding nations. and these nations will serve the king of Babylon <u>70 years</u></p>	<p>70 years</p>
<p>End of Babylonian kingdom after 70-year Darius (the Mede) took over the Babylonian kingdom .</p> <p>Dan 5:30-6:3 That very night Belshazzar, king of the Chaldeans, was slain. And Darius the Mede received the kingdom, being about sixty-two years old. It pleased Darius to set over the kingdom one hundred and twenty satraps, to be over the whole kingdom; and over these, three governors, of whom Daniel was one, that the satraps might give account to them, so that the king would suffer no loss. NKJV</p>		
END	Darius divides his kingdom in three	

‘Weigh & divide’ Symbolic act

Symbolic action

Real action

Ezek 5:1-2
 "And you, son of man, take a sharp sword, take it as a barber's razor, and pass it over your head and your beard; then take **balances** to **weigh** and **divide** the hair. NKJV

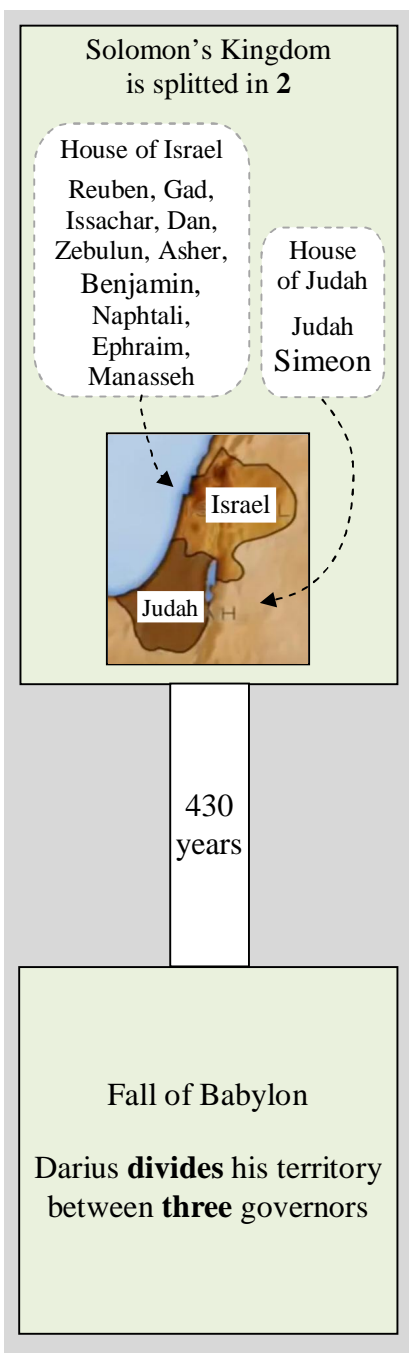
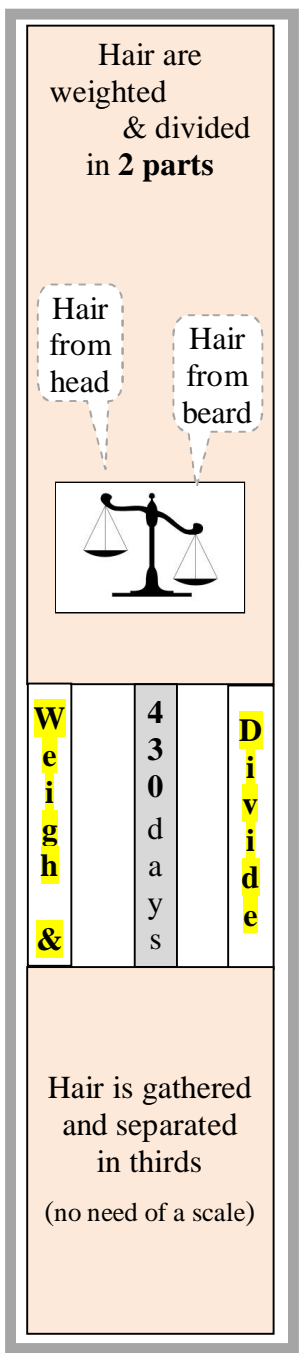

1 Kings 11:31
 'See, I am going to tear the kingdom out of Solomon's hand and give you ten tribes. NIV

Ezek 5:2 When the days of your siege come to an end, **burn a third** of the hair with fire inside the city. **Take a third and strike it** with the sword all around the city. And **scatter a third** to the wind.

Dan 5:26-28
MENE: God has numbered your kingdom, And finished it; **TEKEL**: You have been **weighed** in the **balances**, and found wanting; **PERES**: Your kingdom has been **divided**,

Solomon lost the whole kingdom because of his idolatry

1 Kings 11:4-6 As Solomon grew old, his wives turned his heart after other gods, and his heart was not fully devoted to the LORD his God, as the heart of David his father had been. He followed Ashtoreth the goddess of the Sidonians, and Molech the detestable god of the Ammonites. So Solomon did evil in the eyes of the LORD; he did not follow the LORD completely, as David his father had done. NIV

Belshazzar lost the 'Babylonian' kingdom because of his idolatry

Dan 5:23 You praised the gods of silver and gold, of bronze, iron, wood and stone, which cannot see or hear or understand. But you did not honor the God who holds in his hand your life NIV

From the timing of Nebuchadnezzar we can anchor the period of Babylonian imperialism to the destruction of Jerusalem.

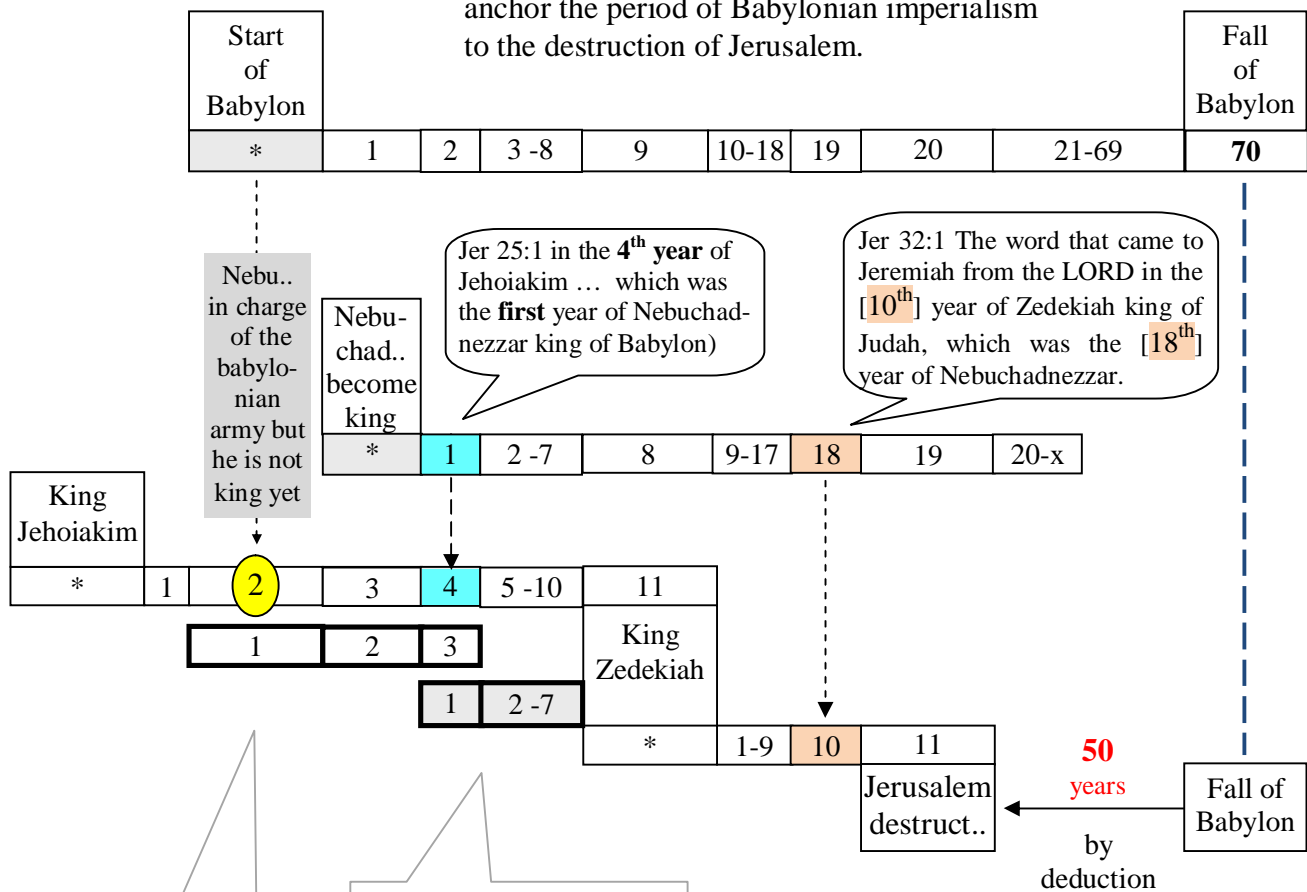

2 Kings 24:1 Nebuchadnezzar king of Babylon invaded the land, and Jehoiakim became his vassal for **three years**. But then he changed his mind and rebelled against Nebuchadnezzar. NIV

Dan 4:31-32 The words were still on his lips when a voice came from heaven, "This is what is decreed for you, King Nebuchadnezzar: Your royal authority has been taken from you. ... **Seven times** will pass by for you until .. NIV

Why did Jehoiakim rebel after 3 years? Could it be because Nebuchadnezzar became incapacitate (for 7 years) by God? If it is the case then, going backward, we can deduce that Nebuchadnezzar made a vassal of Jehoiakim one year before he became himself king. So let's start the Kingdom of Babylon at that time (i.e. Jehoiakim 2nd year)

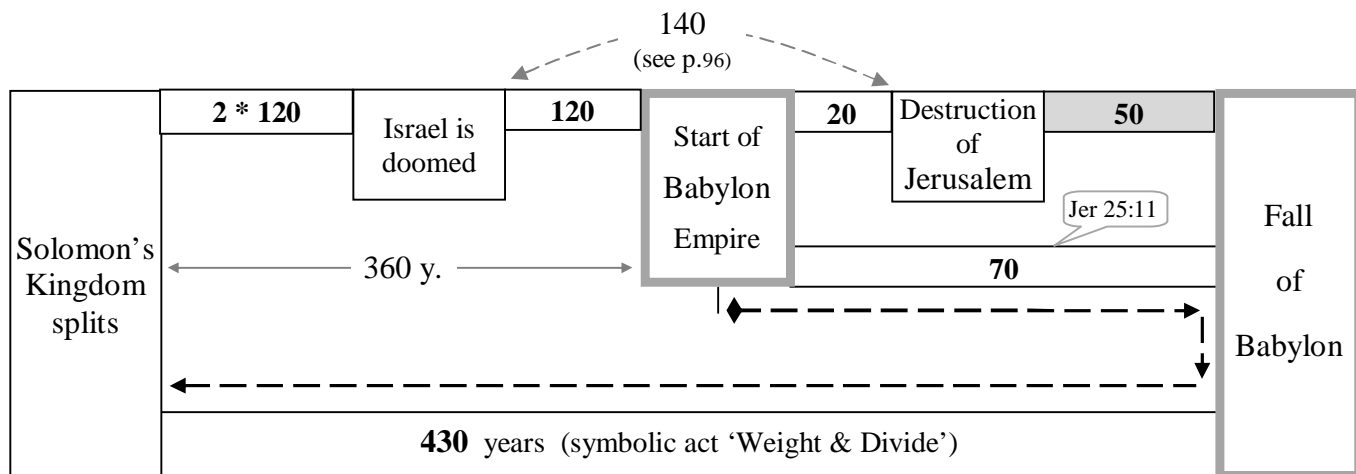

We know now that the ‘end of the 70-year Babylonian imperialism’ happened **50** years after the ‘destruction of Jerusalem’ (by Nebuchadnezzar’s army), and we know that Solomon’s kingdom split happened 430 years before the Fall of Babylon, we have enough to show that Solomon spent as much as **40** years in his new Palace.

From ‘Ark in Temple’ to

① Jerusalem’s destruction
= 430 years (see page 30)

From ‘Jerusalem’s destruction’

② to ‘Fall of Babylon’
= 50 years (see previous page)

From ‘Ark in Temple’ to

③ ‘Solomon’s palace ready’
= 10 years (see page 66)

From ‘kingdom’s split’ to

④ ‘Fall of Babylon’ = 430 years
(hair divided symbolic act)

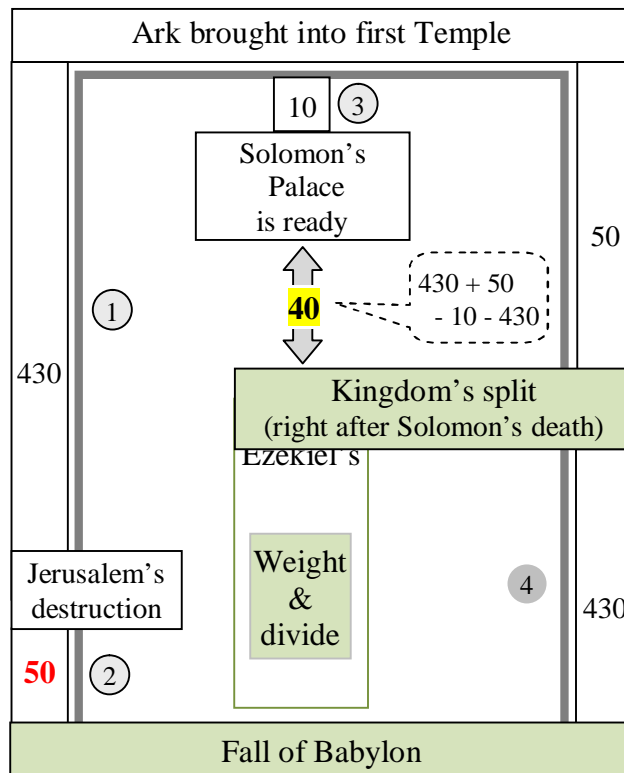

How long did Solomon reign?

Now that the ‘kingdom’s split’ has been accurately fixed we have enough to invalidate the widespread belief that Solomon’s kingship lasted only 40 years. We will see that in fact **“Solomon had been king for 63 years”**.

Solomon’s death occurred shortly before the ‘kingdom’s split’ and we have just learned in the previous figure that this ‘split’ occurred 40 years after Solomon’s palace became available. It follows therefore that Solomon’s reign had been longer than 40 years. Many readers would find it outrageous if they were asked to question the authenticity⁶⁸ of 1 Kings 11:42 where it is mentioned that Solomon reigned over Israel for a total of 40 years. Fortunately, they won’t be told to do such a thing. According to the previous figure, from the completion of his palace to his death (shortly before the kingdom’s split) there is a period of 40 years. This **has to be** the same ‘40 years’ as the one mentioned in 1 Ki 11:42. But before accepting this convenient interpretation, one point needs to be clarified. Why would 1 Ki 11:42 emphasize only the last 40 years of Solomon’s reign and choose to ignore the first 23 years during which Solomon built the Temple and his Palace?

The answer is 1 Kings 3:14 So **if you walk** in My ways, to keep My statutes and My commandments, as your father David walked, **then** I will lengthen your days.

Among all the things God told Solomon He would give him, there is only one that came with a condition attached. Solomon would first have to walk in God’s way before he received a long life. In other words, there would be a period of evaluation **before** the promise would be delivered. This explains why God appeared to Solomon a second time 23 years after the beginning of his reign, right after the completion of his palace (see on page 66 or below).

⁶⁸ 1 Kings 11:42 And the period that Solomon reigned in Jerusalem over all Israel was forty years. NKJV

- 2 Chron 7:11-12 ... and Solomon successfully accomplished all that came into his heart to make in the house of the LORD and in his own house. **Then the LORD appeared to Solomon by night,** NKJV

The Theophany of 2 Chron 7:12 is a proof that Solomon's reign had reached a **turning point**. Up to that time Solomon had been on '**probation**' as he needed to demonstrate that he was a worthy king. By appearing a second time God acknowledged that the king had done well and he would be allowed a long life. Isn't it quite revealing that all this happened at the very time the new Palace became available? As if, symbolically, Solomon's reign was given an official start at the very time he was going to occupy his newly built palace.

Solomon's kingship lasted 63 years

(His reign was divided in two parts : 23 & 40 years)

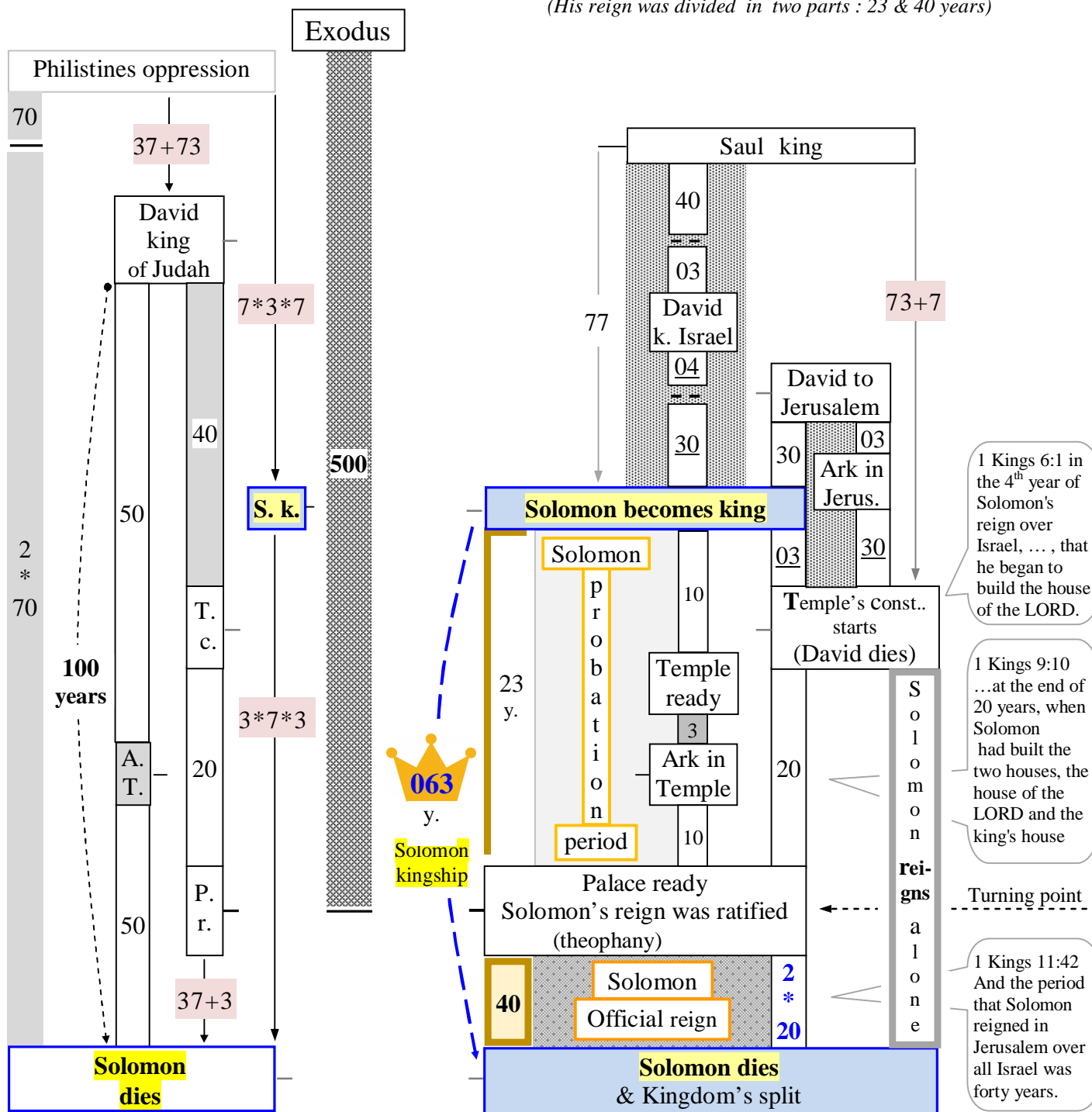

Ezekiel's hair started growing again

Before directly addressing this new topic we first need to identify what happened at the end of Jerusalem's 70 years of desolation.

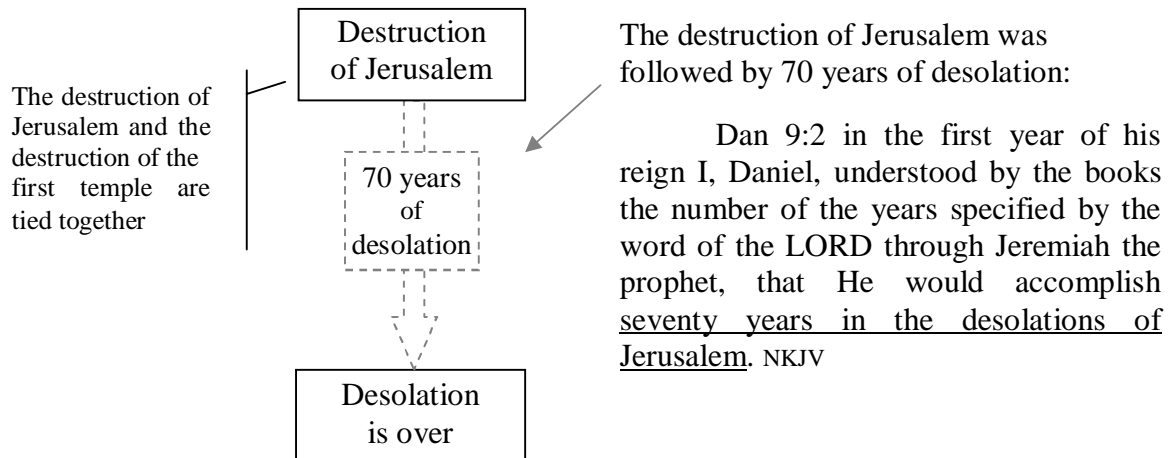

We learn from Chronicles that during the 70-year desolation, the land enjoyed its Sabbaths:

- 2 Chron 36:21 to fulfill the word of the LORD by the mouth of Jeremiah, until the land had enjoyed her Sabbaths. As long as she lay desolate she kept Sabbath, to fulfill seventy years. NKJV

And we also learn that the 70-year desolation was to compensate the 70 sabbatical years that had not been previously observed:

- Lev 26:35 As long as it lies desolate it shall rest--**for the time it did not rest on your Sabbaths when you dwelt in it.** NKJV

When the Israelites came into the Promised Land God instructed them to allow the land to rest for a full year every 7 years. That rule was known as the Sabbath law and it was observed by the people until the death of Samuel (see on page 64). After Samuel's death, during the next 490 years, the Israelites never let the land rest and by the time Jerusalem was destroyed a total of 70 years (one year for every 7 years) had been disregarded. The Israelites had deliberately chosen to ignore the divine law, unfortunately for them God did not forget it.

There is an important point to understand here. The 70 years of desolation that came after the destruction of Jerusalem were not years of 'punishment'⁶⁹ against the Israelites, but rather years of 'restitution' to a land that had been denied its Sabbatical rest during 490 years.

UNDERSTAND: The 70 years of desolation of the land were 70 years of rest for that land.

⁶⁹ In fact the punishment had been handled 10 years before when the Israelites (tribe of Judah) were sent into Exile.

The **70** years
DESOLATION
of the land

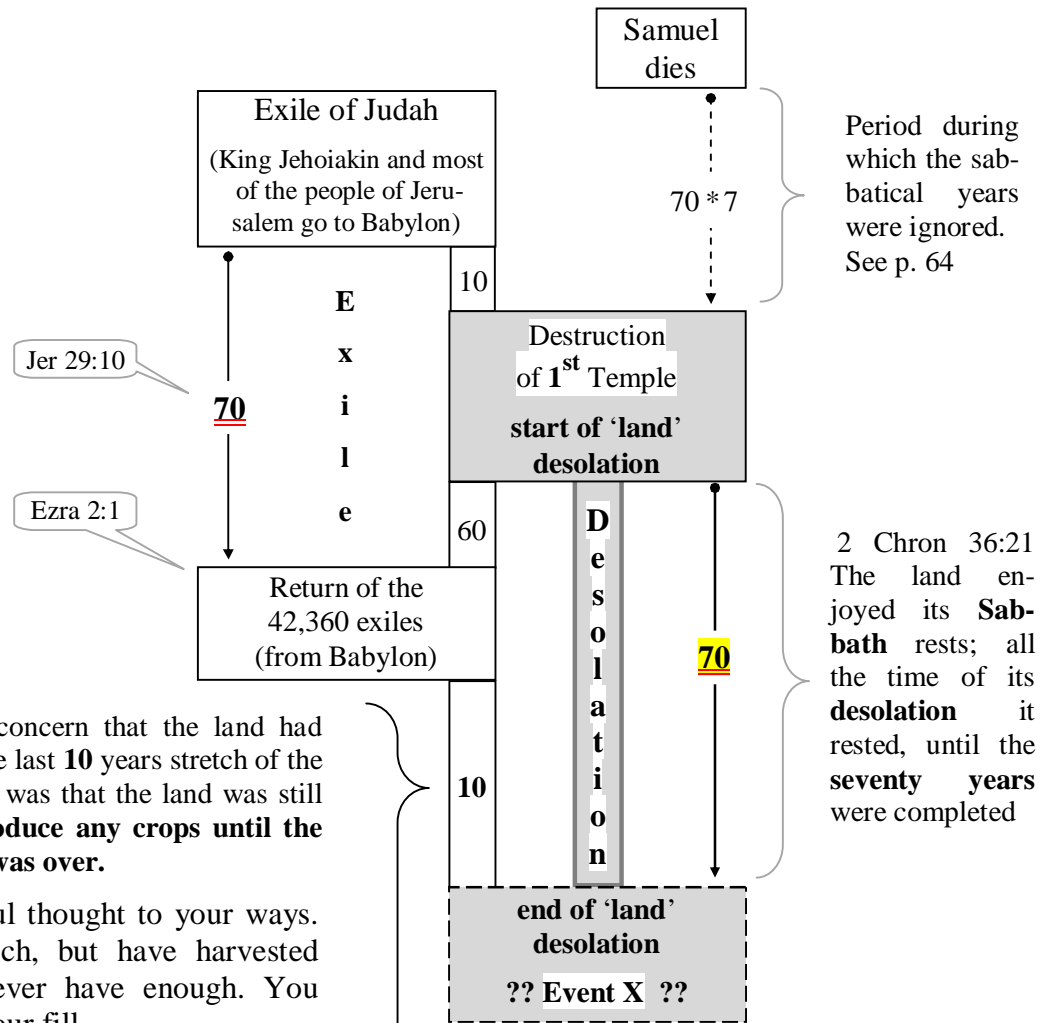

There shouldn't be any concern that the land had been inhabited during the last **10** years stretch of the desolation; what mattered was that the land was still resting **and wouldn't produce any crops until the whole 70-year Sabbath was over.**

Hag 1:5-6 "Give careful thought to your ways. You have planted much, but have harvested little. You eat, but never have enough. You drink, but never have your fill.

Hag 1:10 Therefore, because of you the heavens have withheld their dew and the earth its crops.

IMPORTANT: The 70 years of exile & the 70 years of desolation are two different periods

We have two important clues to identify the event 'X' that marked the end of Jerusalem's desolation.

- #1. The return of the exiles⁷⁰ (42,360) is not linked to the end of desolation.
- #2. Once the 70 years of rest were completed the land would give useful crop yields for the people again.

The timing of the event 'X' that we are looking for was clearly invoked by Haggai:

The land was going to produce again:

- Hag 2:18-19 Give careful thought: Is there yet any seed left in the barn? Until now, the vine and the fig tree, the pomegranate and the olive tree have not borne fruit. **"From this day on I will bless you."**

⁷⁰ Ezra 2:1 Now these are the people of the province who came back from the captivity, of those who had been carried away, whom Nebuchadnezzar the king of Babylon had carried away to Babylon, and who returned to Jerusalem and Judah, everyone to his own city. NKJV

The event that would mark the end of the desolation of the land was the resuming of the construction of the second Temple:

- Hag 1:9-11 "Because of **my house, which remains a ruin**, while each of you is busy with his own house. Therefore, because of you **the heavens have withheld their dew and the earth its crops**. I called for a drought on the fields and the mountains, on the grain, the new wine, the oil and whatever the ground produces, on men and cattle, and on the labor of your hands."

Three important things to note from Hagai 1:9-11:

- #1. Haggai clearly identified a time when the Israelites were building their house⁷¹ while the Temple lay in ruins.
- #2. The land was not producing any useful crops. (In fact the land had until then been enjoying its 70 sabbatical years of rest.)
- #3. Obtaining any crops of the land was directly related to the construction of the second Temple.

For Haggai to suggest the third point could only mean that the 70 years of desolation had just been reached. There was nothing preventing⁷² the construction of the second Temple anymore.

- Hag 1:7-8 Go up into the mountains and bring down timber **and build the house**, so that I may take pleasure in it and be honored

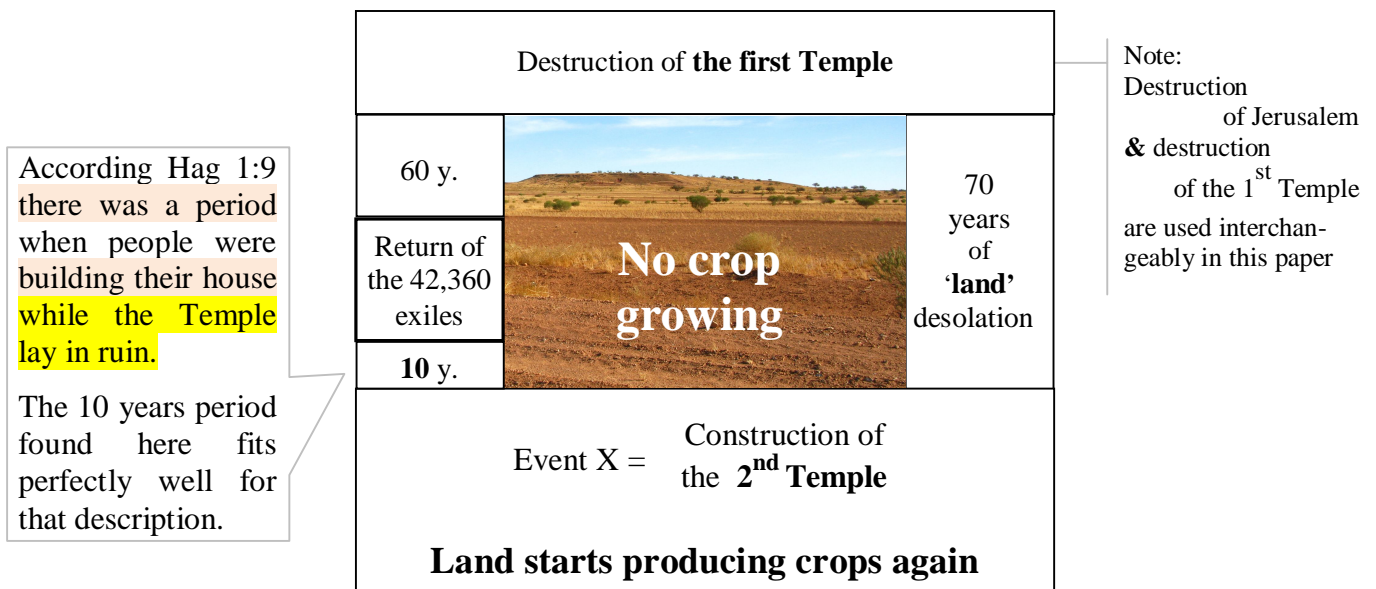

⁷¹ This is not surprising given that according to our hypothesis the Israelites came back to the land 10 years before.

⁷² A few years back the people (from the 42,360 who came back with Zerubbabel) had laid the foundation of the new Temple but they were not allowed to start any construction at that time.

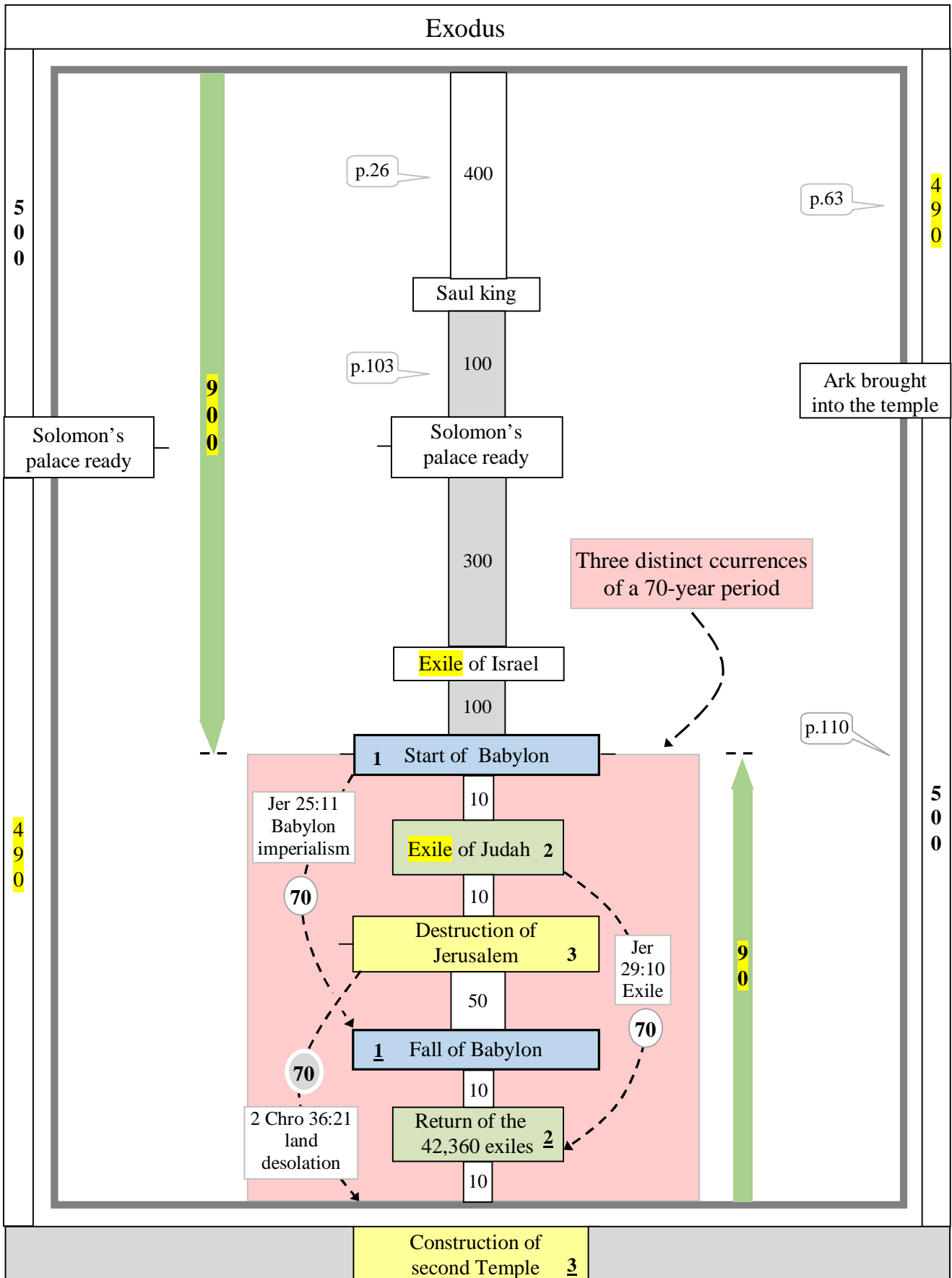
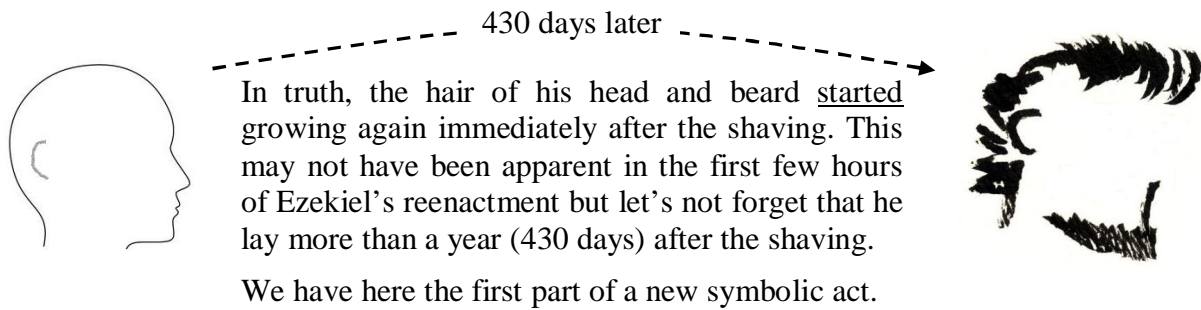

Figure 15. Construction of the second Temple

As mentioned earlier, Ezekiel had to shave his head and beard at the beginning of his siege. What has not been emphasized however, is the fact that his new baldness didn't last long.



In truth, the hair of his head and beard started growing again immediately after the shaving. This may not have been apparent in the first few hours of Ezekiel's reenactment but let's not forget that he lay more than a year (430 days) after the shaving.

We have here the first part of a new symbolic act.

This act is associated with no specific house⁷³ and it lasted the whole 430 days of Ezekiel's siege. Surprisingly the act was not concluded by Ezekiel shaving his head again⁷⁴. However, it is more than likely that the prophet rushed to make some proper hairdressing as soon as the siege reenactment was over and he was set free⁷⁵:

- Ezek 44:20 They [priest] shall neither shave their heads **nor let their hair grow long**; but **they shall keep their hair well trimmed**. NKJV

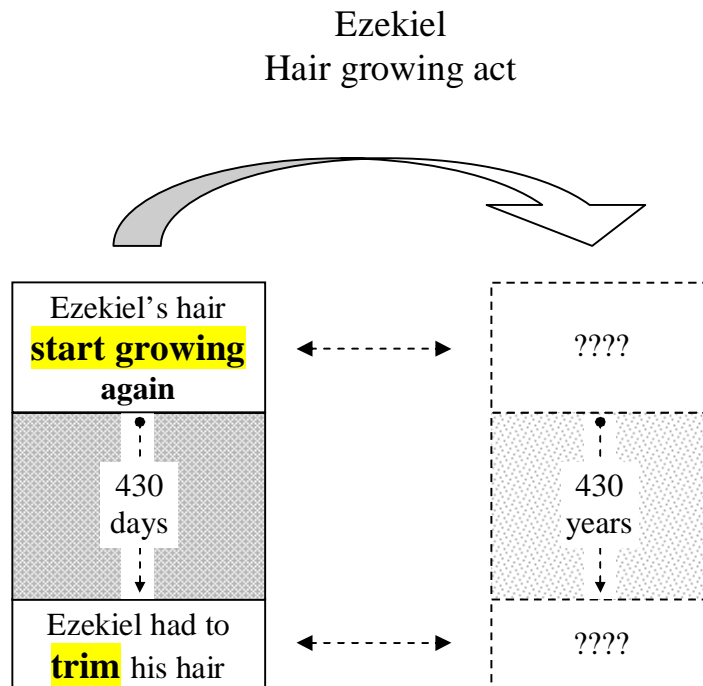

⁷³ The side on which Ezekiel was lying didn't alter the meaning of the act. Whatever side Ezekiel was lying on, his hair was growing independently of it.

⁷⁴ There is absolutely no indication that he would have done it any time during the siege. And it is quite unlikely that he would have gone through the humiliation (shaving his head) a second time after the siege.

⁷⁵ Ezekiel was tied during 430 days.

What might be portrayed by Ezekiel's **start** of 'growing hair'? There is one event that qualifies more adequately than any other: it is the **'construction of the second Temple'**. Notice that in each case ("hair starts growing" and "construction of the second Temple") a slow process is initiated and will eventually bring back something that had been 'dramatically' removed⁷⁶.

The construction of the second Temple took place at the end of a 70-year period during which the land was left completely desolated. We have already (on page 106) seen that 'the day' the Israelites returned to the construction of the (second) Temple the land started producing food again:

- Hag 1:7-8 Thus says the LORD of hosts: "Consider your ways! Go up to the mountains and bring wood **and build the temple, that I may take pleasure in it** and be glorified," says the LORD. NKJV
- Hag 2:19 Is the seed still in the barn? As yet the vine, the fig tree, the pomegranate, and the olive tree have not yielded fruit. **But from this day forward I will bless you.'**

Could it be more plain than that? The land started **growing food** the same day the construction⁷⁷ of the second temple began. We have here a direct connection with Ezekiel's **'growing hair'**.

It was inferred earlier that after his siege was over, Ezekiel needed to trim his hair. Wouldn't it be also expected, that after 430 years, the second Temple was in dire need of some major repairs? John 2:20 confirms that some major repairs were done to the 2nd Temple⁷⁸

Ezekiel **'hair growing'** symbolic act

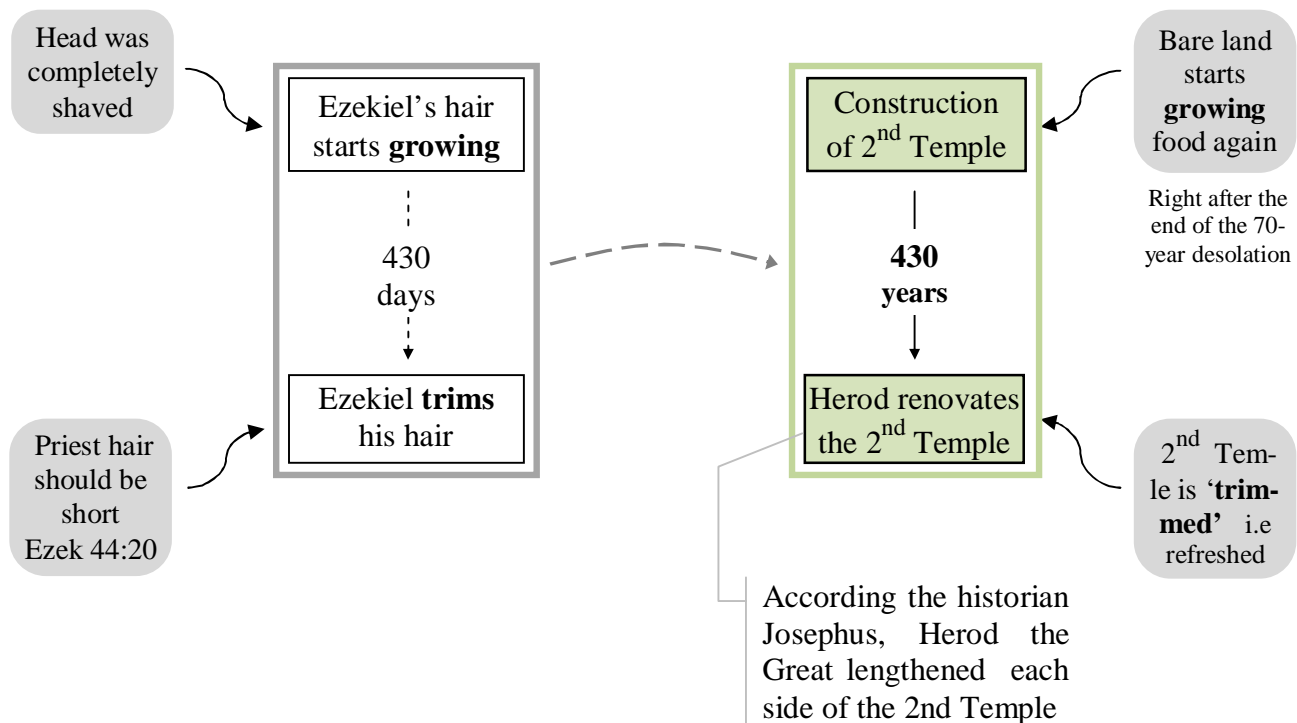

⁷⁶ Ezekiel felt humiliation at losing his hair; the Israelites felt despair at seeing their Temple destroyed.

⁷⁷ We will see in the coming pages of this book that the construction of the 2nd Temple happened 3 years after its foundation was laid out. It is important to keep in mind that these two events are not the same.

⁷⁸ John 2:20 The Jews replied, "It has taken **forty-six** years to build this temple, NIV

Here are the 3 symbolic acts associated with Ezekiel's hair (ref p 89, 97, 108)

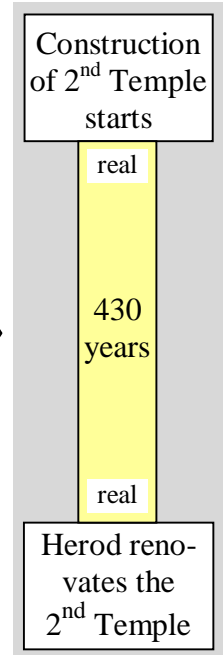
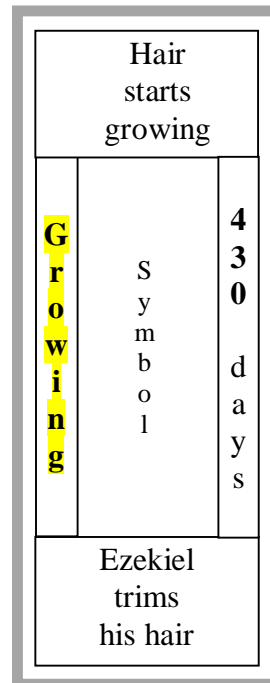
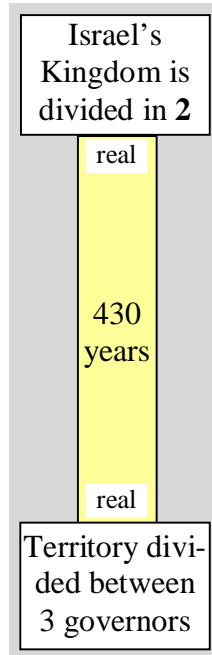
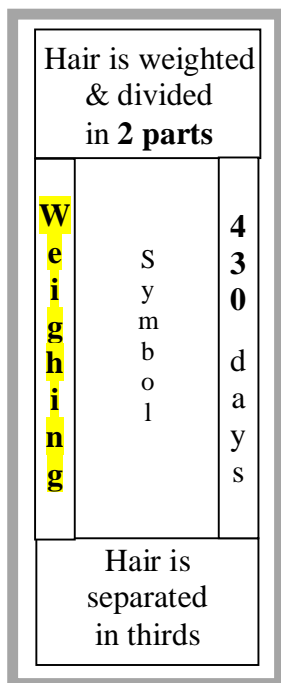
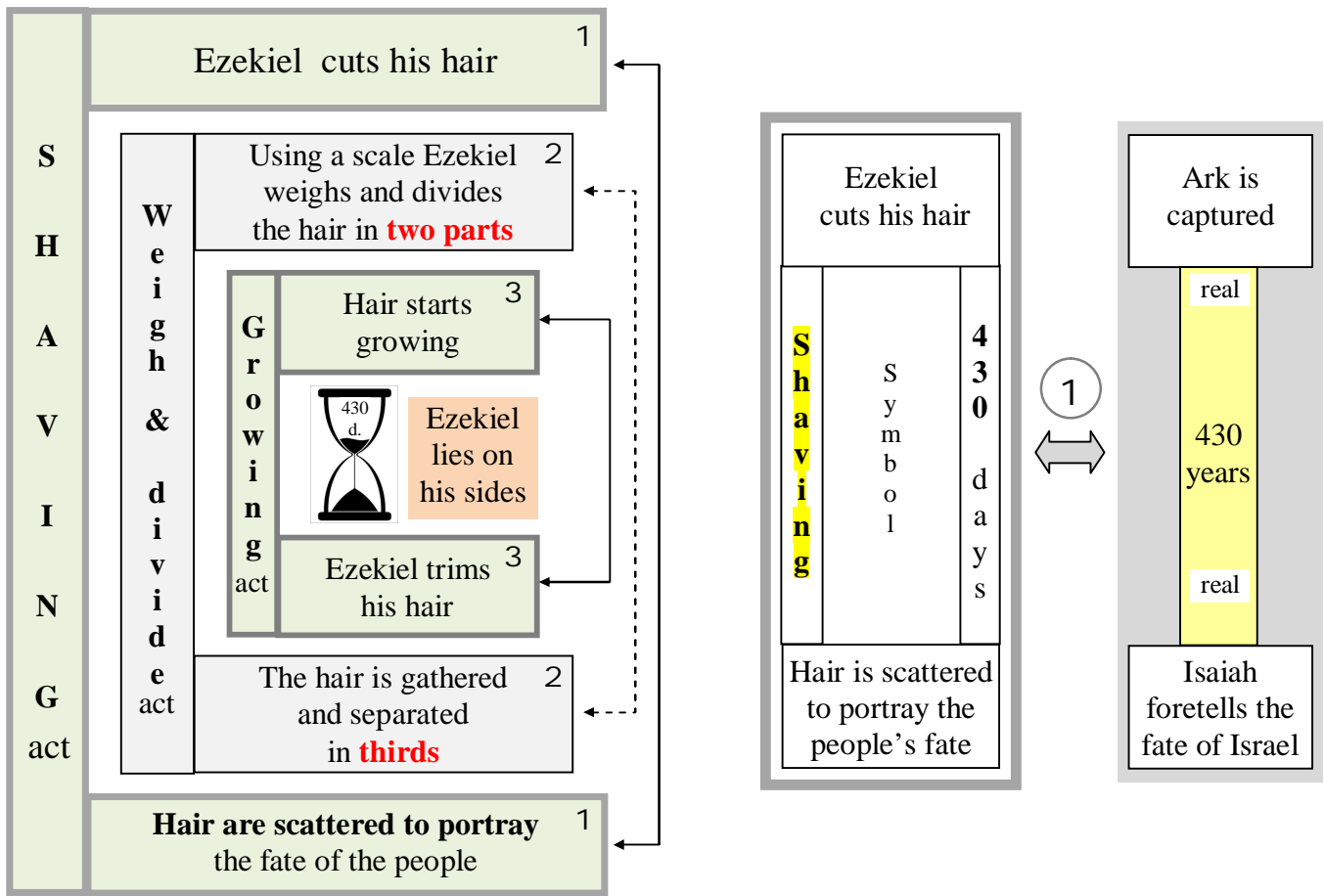

Daniel 70-week & post exile chronology

Daniel 70-week prophecy (Dan 9:25-27) covers a period of 490 years (i.e 70 weeks of 7 years each). The text of Daniel can be divided in the following way (my understanding).

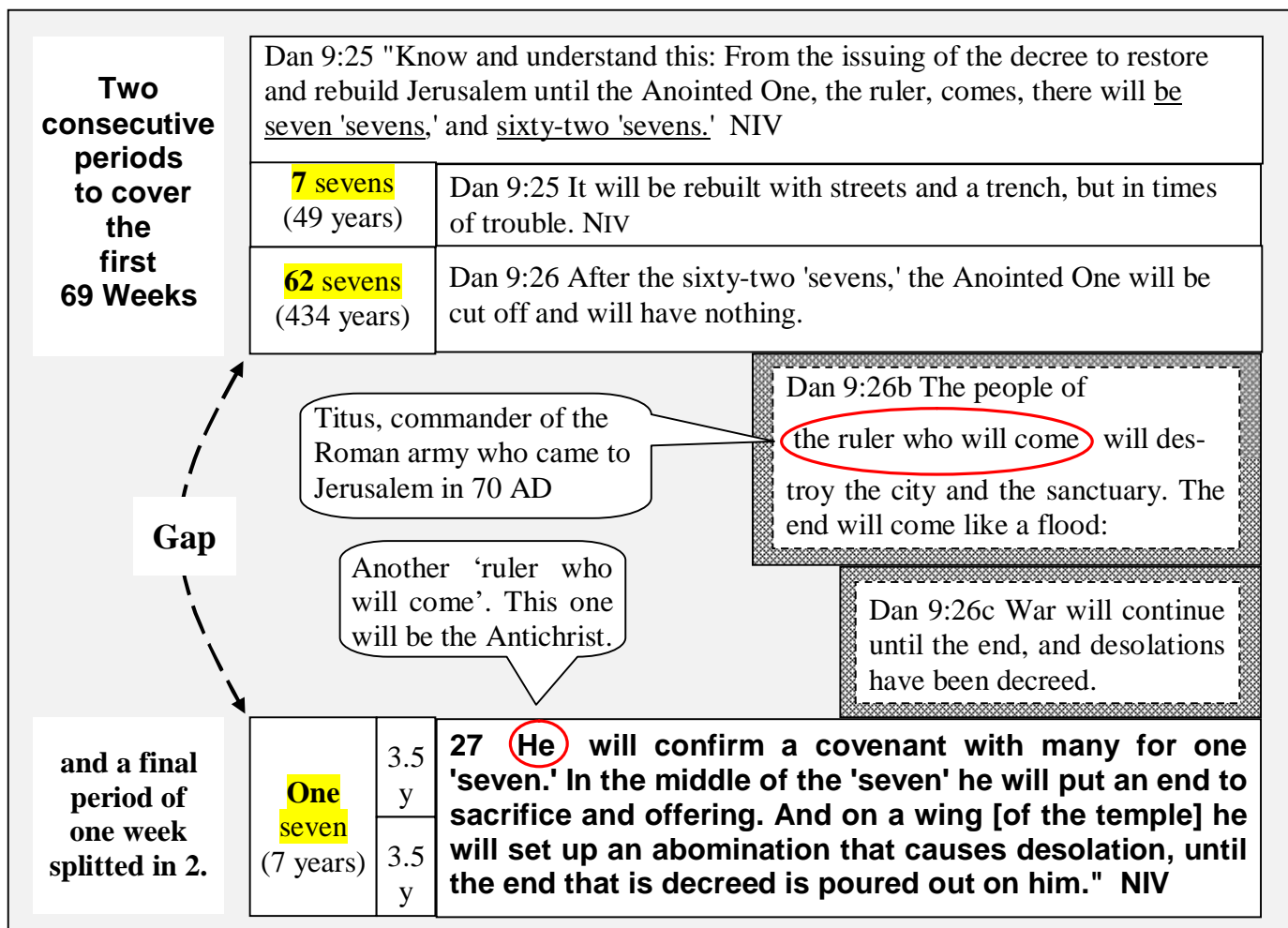

How does the 70-week start?

Daniel's '70-week' start is connected to the going forth of a word:

Dan 9:25 Know therefore and understand that from the going forth of the word to restore and build Jerusalem RSV

Isa 44:28 ... he [Cyrus] will say of Jerusalem, "Let it be rebuilt," and of the temple, "Let its foundations be laid." '

While most chronologers take the position that the 70-week period started at the alleged time (extra biblical sources can be wrong) of a (highly speculative) imperial decree from either Cyrus or Artaxerxes, I have a very different approach.

Daniel tells us that the 'Seventy 'sevens' are decreed for **his people** and '**Jerusalem**' (see Dan 9:24). Why should the clock start with any so called edict pronounced a thousand kilometers away by non-Jewish people in a foreign city that has nothing to do with the vision? A more sensible approach in my opinion would be to associate the 'start of the 70-week with the very first '**concrete action**' to restore Jerusalem after the Exile.

It is obvious to me that the ‘going forth of the word’ (Dan 9:25) doesn’t point to the ‘promulgation of a commandment but rather to its **EXECUTION** i.e. to the very first action that was laid down on the ground to restore Jerusalem.

Ezra 3:10-11 **When the builders laid the foundation of the temple** of the LORD, the priests in their vestments and with trumpets, and the Levites (the sons of Asaph) with cymbals, took their places to praise the LORD, as prescribed by David king of Israel. With praise and thanksgiving they sang to the LORD:

"He is good; his love to Israel endures forever."

And all the people gave a great shout of praise to the LORD NIV

In this paper there is no doubt that

laying the Foundation⁷⁹ of the 2nd Temple

was the first **“concrete”** step to rebuild Jerusalem and therefore it coincided with the

start of Daniel’s 70 weeks.

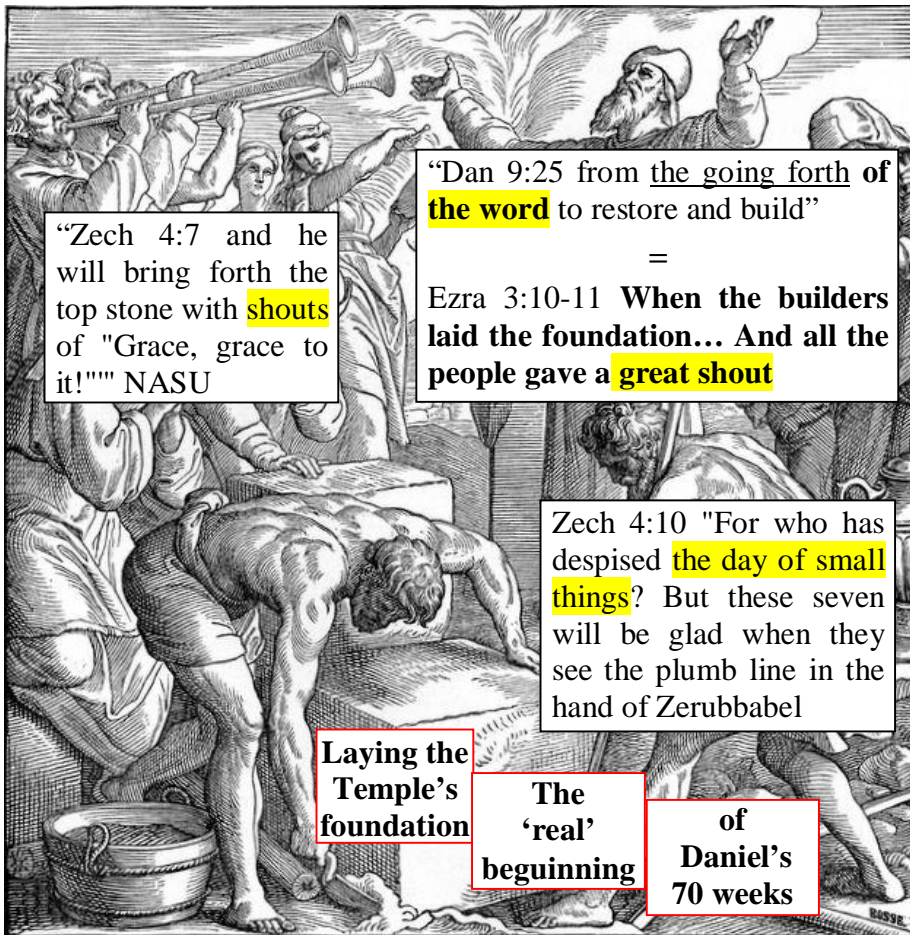

“Zech 4:7 and he will bring forth the top stone with **shouts** of "Grace, grace to it!"” NASU

“Dan 9:25 from the going forth of the word to restore and build”

=
Ezra 3:10-11 **When the builders laid the foundation... And all the people gave a **great shout****

Zech 4:10 "For who has despised **the day of small things**? But these seven will be glad when they see the plumb line in the hand of Zerubbabel

Laying the Temple’s foundation

The ‘real’ beginning

of Daniel’s 70 weeks

Isa 44:28 he will say of Jerusalem, "Let it be rebuilt," and of the temple, "Let its foundations be laid." ' NIV

rebuilding Jerusalem = laying the 2nd Temple’s foundation

The combine first two divisions (7 + 62 weeks) ends with the death of an anointed one (i.e. Yeshua’s death). Note I will discuss the first 7 weeks later.

The third division (i.e. the last 7 years of Daniel 490 years) covers the time of the antichrist (that period is usually called ‘End time period’).

“he will set up an abomination [in the Temple??] that causes desolation” Dan 9:27

⁷⁹ This is the very first step toward the Temple’s construction and thereby the first step to restoring and rebuilding Jerusalem. It doesn’t matter that the Israelites had erected an altar in Jerusalem in the 7th month 2 years before given that it was made with earth or by piling a few stones one over the others. (see Ezra 3:1)

The following verses also point to the 'end time period'.

Matt 24:15 "So when you see standing in the holy place 'the abomination that causes desolation,' spoken of through the prophet Daniel-let the reader understand- NIV

2 Thess 2:3-4 Don't let anyone deceive you in any way, for that day will not come until the rebellion occurs and the man of lawlessness is revealed, the man doomed to destruction. 4 He will oppose and will exalt himself over everything that is called God or is worshiped, so that he sets himself up in God's temple, proclaiming himself to be God. NIV

On page 112, I bookended the part of the second half of Daniel 9:26 that says:

The people of the ruler who will come will destroy the city and the sanctuary.
The end will come like a flood:

between the **second** and **third** division of Daniel 70 weeks.

One has to understand that the 'destruction of Jerusalem and the sanctuary' happened after the end of the first 69 weeks period but before the 70th week.

Here we have three clues to argue that this destruction of Jerusalem and the Temple refer to the events of 70 AD (thus after the end of the 62-week but before the start of the 70th week).

First: The people of the prince

We all know that Jerusalem and the Temple were destroyed in 70 AD by the three legions of the army of Titus. Interestingly Titus had given orders to his soldiers to preserve the Temple. But the soldiers in their fury disobeyed and set fire to the Temple. (As mention by Daniel 9:26 it is **the people of** the ruler 'not the ruler' himself who were responsible for the destruction of the 2nd Temple.

Second. The end of it shall be with a flood

Recent estimates of the population of Jerusalem in 70 AD suggest something in the neighborhood of a hundred thousand" yet Josephus claims that 1.1 million people were killed during the siege. (Event thought Josephus could be wrong in his estimation and only half of a million of people were killed it won't matter) Josephus attributes to the celebration of Passover, which he uses as rationale, for the vast number of people present among the death toll. The point here is that several hundred thousands of people came to Jerusalem for the Passover without any fears that they could not return home after the celebration. They were completely taken by surprise when Titus army suddenly encircled the city and trapped them. Isn't that a true representation of an end that shall come like a flood?

Third

It cannot be associated with the last week of Daniel (70th) because nowhere it is said that the Antichrist will destroy the 'third' Temple.

(On the contrary, the Antichrist will occupy the Temple in the middle of Daniel 70th week)

- Dan 11:31-32 "His armed forces will rise up to desecrate the temple fortress and will abolish the daily sacrifice. Then they will set up the abomination that causes desolation. NIV
- **Matt 24:15 So when you see standing in the holy place 'the abomination that causes desolation,' NIV**

The people of the **ruler** who will come will destroy the city and the sanctuary... The end will come like a flood.

These parts happened in

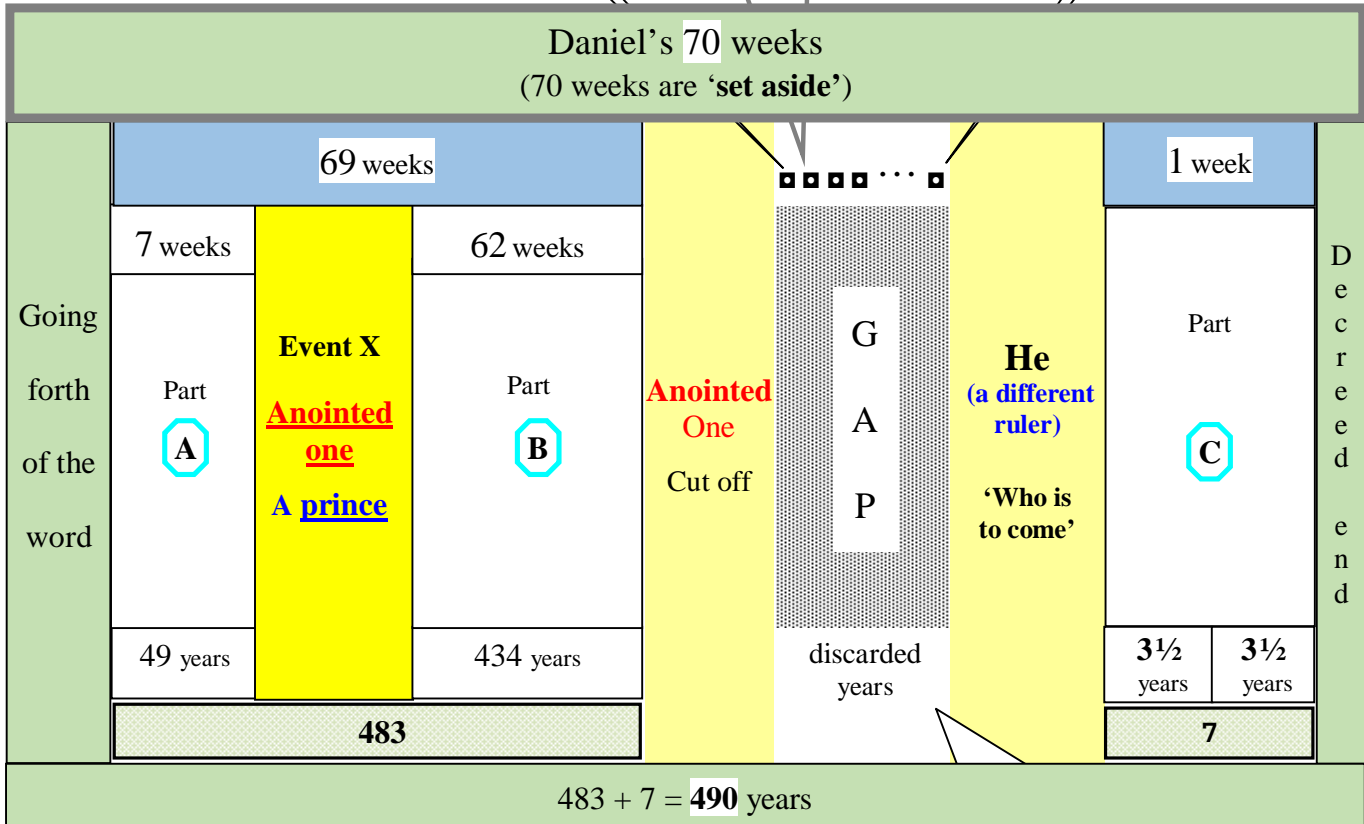
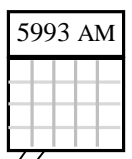
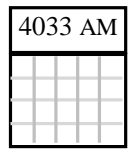
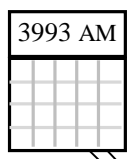

The prophecy is solely concerned by the years of the three specific periods (49 y, 434 y, and 7 years) as they are the one that will contribute an active role to bring an end to the transgression in the holy city of Jerusalem. (More on page 129)

Many people reject the possibility of a gap here because, it would, **without explanation and justification**, temporarily suspends the fulfillment of the 490 years prophecy. I fully agree that interrupting a so called God's clock would weaken the notion of chronological sequence.

But these people misunderstand the relation between 'time' and 'each part' of the this specific prophecy. The '490 years' is not meant to be a chronological sequence, **it is a time allotment**.

We will see in **p. 131** that even though parts **A** & **B** are continuous and part **C** stands apart, these two periods share an **identical and fondamental purpose**.

The gap is legitimated because it covers a period of time that has nothing to do with any of the **active** parts of this prophecy.

The prophecy is solely concerned by the years of these three specific periods (49 y, 434 y, and 7 years) as they are the one that will contribute an active role to bring an end to the transgression in the holy city of Jerusalem. The 3 divisions form a 'time allotment' of 490 years and therefore it doesn't matter if the third division (the last 7 years) is separated from the first two (49 and 434 years) (*More on page 129*)

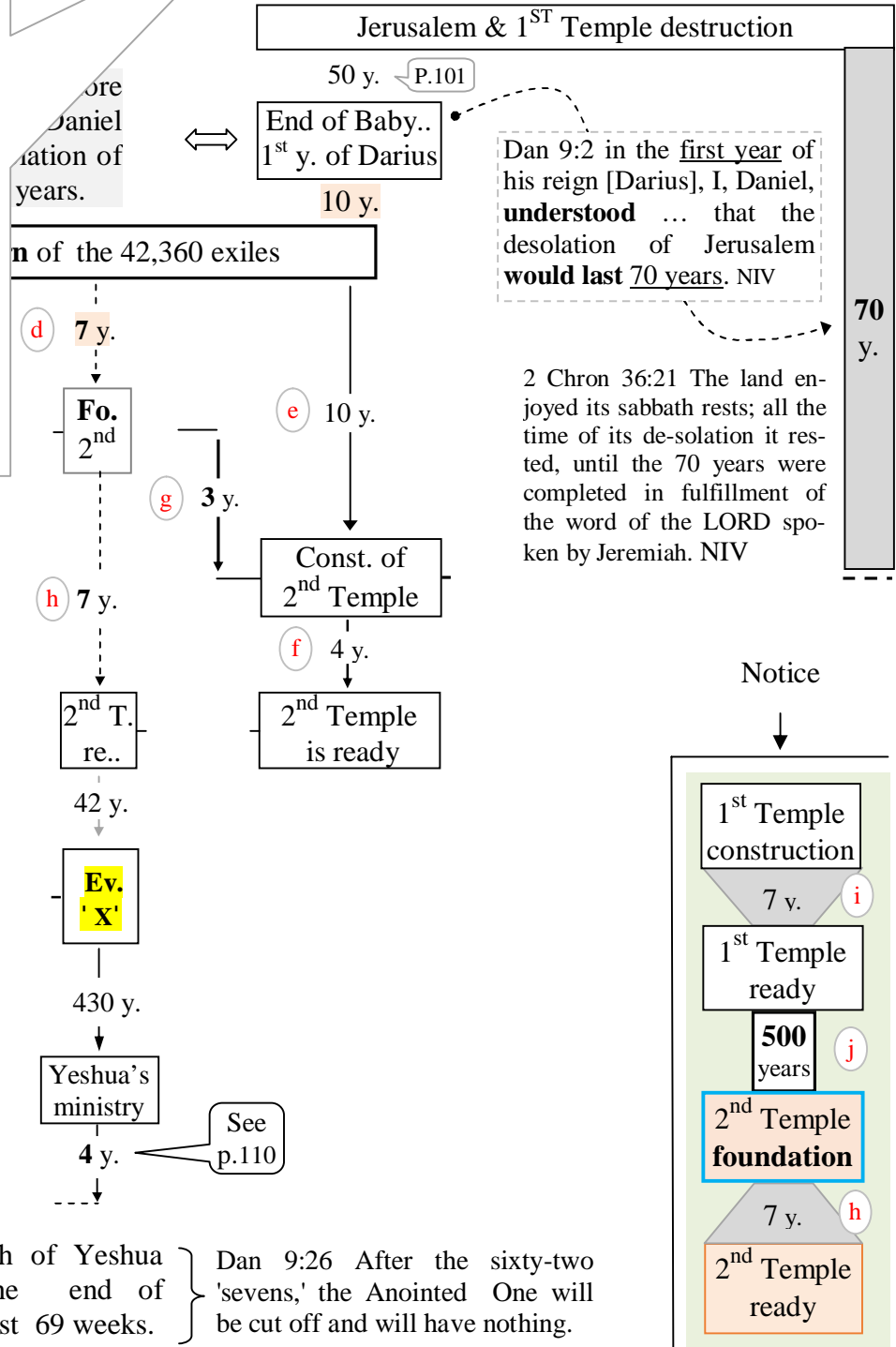
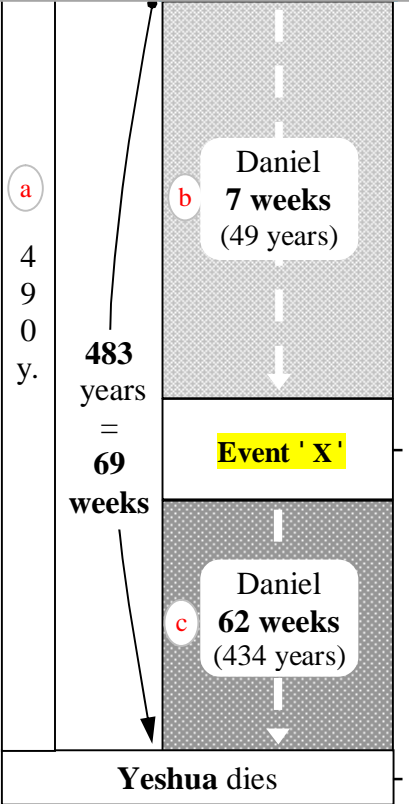

The death of Yeshua marks the end of Daniel first 69 weeks. } Dan 9:26 After the sixty-two 'sevens,' the Anointed One will be cut off and will have nothing.

Figure 17. Second Temple period

- A: p 107 & 110 (10 + 430 + 46 + 4)
- B: 7-week = 49 years
- C: 62-week = 434 years
- D: A490 - C434 - B49 = 7
- E: See Figure 15. On page 107
- F: See Ezra 6:15
- G: E10 - D7 = 3
- H: G3 + E4 = 7
- I: See page 55

- J: From Figure 8 on page 63
- 'Temple ready' to 'Temple's dest..' = 433
- From Figure 11 on page 71
- 'Temple's destruction .' to 'Return' = 60
- 'Return' to 'Foundation' = D = 7
- 500 y.
- 116

Here are two sequences of events related to the 2nd Temple construction

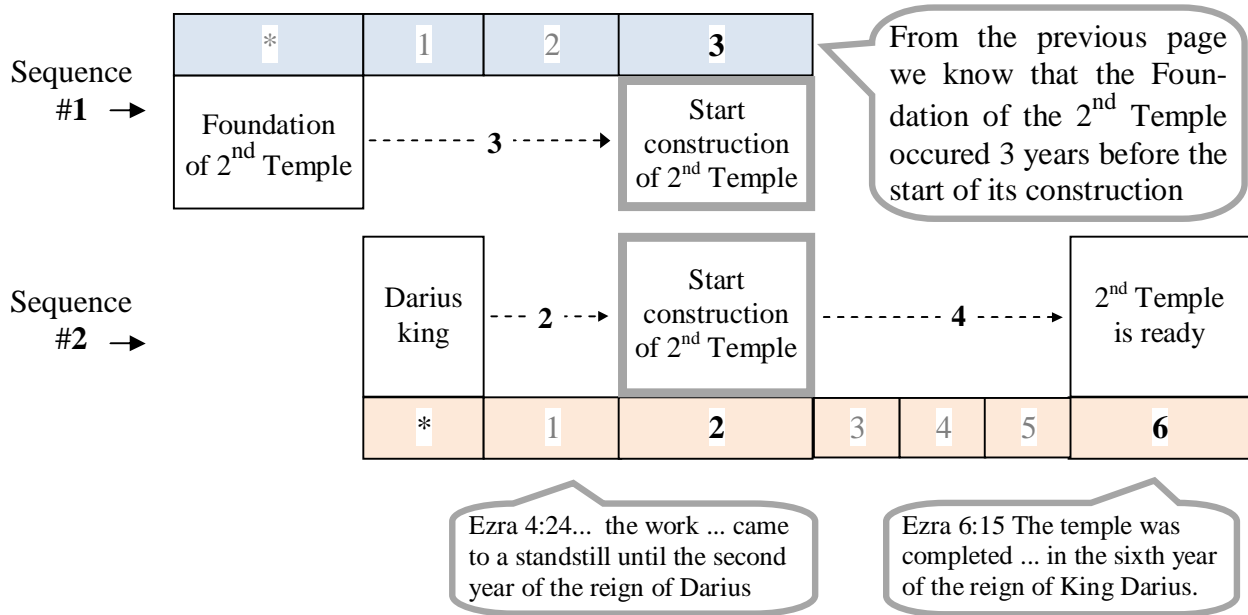

Darius sequence : Obtained by merging the previous two sequences (i.e. #1, #2)

	*	1	2	3	4	5	6
Foundation of 2 nd Temple	Darius king		Start construction of 2 nd Temple				2 nd Temple is ready
*	1	2	3	4	5	6	7

Now we will take a closer look at the Nehemiah's period:

Nehemiah Seq. #1		Connecting from an unknown event Y		Neh 1:1-2 The words of Nehemiah the son of Hachaliah. It came to pass in the <u>month of Chislev, in 20th year</u> , as I was in Shushan the citadel, that Hanani one of my brethren came with men from Judah; NKJV	
Event 'Y'	*	1-19	20 th	Note: This happened in the month of Chislev and it was in the 20th year of an event 'Y' that <u>is not mentioned by name</u> .	
			Nehemiah receives some news from Jerusalem	Note: The unknown event (Y) referred to by Nehemiah must have had great importance given that Nehemiah is still remembering it 20 years later.	

Nehemiah Seq. #2

Connecting from king Artaxerxes

King Artaxerxes		Neh. meets K. Ar..			
*	1-19	20 th	21-31	32 th	
Nehemiah asks the King to be sent to Jerusalem		Wall started	← 12 years to repair? →	Wall ended	

The wall was large (people walk on it), long (many huge gates), very high (to offer full protection). It had been unattended for almost 90 years beside being partly damaged or destroyed by Nebuchadnezzar's war (Jer 52:14).
 Neh 4:19 "The work is extensive and spread out, and we are widely separated from each other along the wall."
Should we be surprised that it took 12 years to repair? NO

Neh 2:1 And it came to pass in the month of **Nisan**, in the 20th year of King Artaxerxes, NKJV

Note: Here an event is connected with the **20th year of king Artaxerxes**, in the month of Nisan. Three months have gone since Neh 1:1 (Chislev – Tebeth – Adar – Nisan). Given that Nisan is the start of the new year (my working hypothesis in this book) we can rule out that this '20th year' of Artaxerxes (Neh 2:1) is the same '20th year' referred earlier in Neh 1:1.

Nehemiah built Jerusalem's wall from the 20th to the 32th year of Artaxerxes.
 Neh 5:14 from the time that I was appointed to be their governor in the land of Judah, from the 20th year until the 32th year of King Artaxerxes, twelve years, NKJV
 Neh 5:16 Instead, I devoted myself to the work on this wall. NIV

NOTE: Neh 6:15 seems to suggest that the work on the whole wall took only 52 days but we will see that it is not the case.

Neh 6:15 So the wall was completed on the twenty-fifth of Elul, in fifty-two days. NIV

In Neh 6:1 we are told that the wall is completed **but without the gates.**

Neh 6:1 When word came to Sanballat, Tobiah, Geshem the Arab and the rest of our enemies that I had rebuilt the wall and not a gap was left in it-**though up to that time I had not set the doors in the gates-** NIV

However, in Neh 6:3 the work is not stopped yet (in spite of having said in Neh 6:1 that the wall was already rebuilt.

Neh 6:3 "I am carrying on a great project and cannot go down. Why should the work stop while I leave it and go down to you?" NIV

Why not? Because once the wall was completed (after 12 years) the people started to work on the gates. So, when Neh 6:15 claims that the work was completed in **52 days** we need to understand that it took an additional 52 days to repair all the gates.

Merging Nehemiah's Seq. 1 & 2

	*		20 th		
Event 'Y'			Nehemiah receives news 20 years after event Y		
N E H E M I A H 's sequence	King Artaxerxes			Neh.. meets Art.. in the king's 20 th year, then goes to Jerusalem.	
	*	1-18	19	20 th	21-31
				Wall started	

3 months later



Neh 7:4 the city was large..
 It took 12 years to repair the whole wall and its towers

When Nehemiah came to Jerusalem to “repair” the wall, Jerubabel and the 42,360 exiles had already returned. We deduce this from the presence of many people (priest, nobles, officials) in the city when Nehemiah inspected the wall (three days after his own arrival):



Neh 2:12-13 I set out during the night with a few men. ... There were no mounts with me except the one I was riding on. ... By night I went out ... examining the walls of Jerusalem, which had been broken down, NIV

Neh 2:16 And the officials did not know where I had gone or what I had done; I had not yet told the Jews, the priests, the nobles, the officials, or the others who did the work. NKJV

Also, when Nehemiah came to Jerusalem **the 2nd Temple had already been rebuilt:**

- Neh 6:10 ... and he said, "Let us meet together in the house of God, within the temple, and let us close the doors of the temple, NKJV

Nehemiah couldn't have met anybody at the Temple if it hadn't been already rebuilt. Also notice⁸⁰ that the sadness expressed in Neh 2:3 occurred just before Nehemiah came to Jerusalem. He was then overwhelmed by the knowledge that the city lay in ruins and its gates had not been repaired yet. There is no mention that Nehemiah grieved for the Temple; it can only be explained by the fact that the 2nd Temple had already been reconstructed.

Now, knowing how concerned Nehemiah was when he learned, from his brother, about the awfully neglected condition⁸¹ of the city, also knowing that Nehemiah took upon himself to repair the wall around Jerusalem and, once it was done, he took some measures to repopulate the city⁸², knowing all that, wouldn't it make a lot of sense if the mysterious 'Event Y' (Neh 1:1) still remembered by Nehemiah 20 years later, happened to be the **Foundation of the 2nd Temple**?

The first 7 weeks of Daniel's 70-week prophecy are mostly concerned with the restoration of the city and we have already made the 'foundation of the Temple' the very beginning (see page 113) of those 7 weeks. Should we be surprised if Nehemiah the 'builder', who loved Jerusalem to the point of crying for it, had always **kept track of the years** since the 'foundation of the 2nd Temple' (rebirth of the city) and used them as the origin⁸³ of his personal timeline?

As we will see, this conclusion allows us to untangle the sequence of events that occurred during the first 7 weeks of Daniel's 70 weeks of prophecy.

⁸⁰ Neh 2:3 "May the king live forever! Why should my face not be sad, when the city, the place of my fathers' tombs, lies waste, and its gates are burned with fire? NKJV

⁸¹ Neh 1:2-4 and I asked them concerning the Jews who had escaped, who had survived the captivity, and concerning Jerusalem. ... The wall of Jerusalem is also broken down, and its gates are burned with fire." So it was, when I heard these words, that I sat down and wept, and mourned NKJV

⁸² Neh 11:1 ... the rest of the people cast lots to bring one out of ten to dwell in Jerusalem, the holy city, NKJV

⁸³ See Neh 1 :1-2

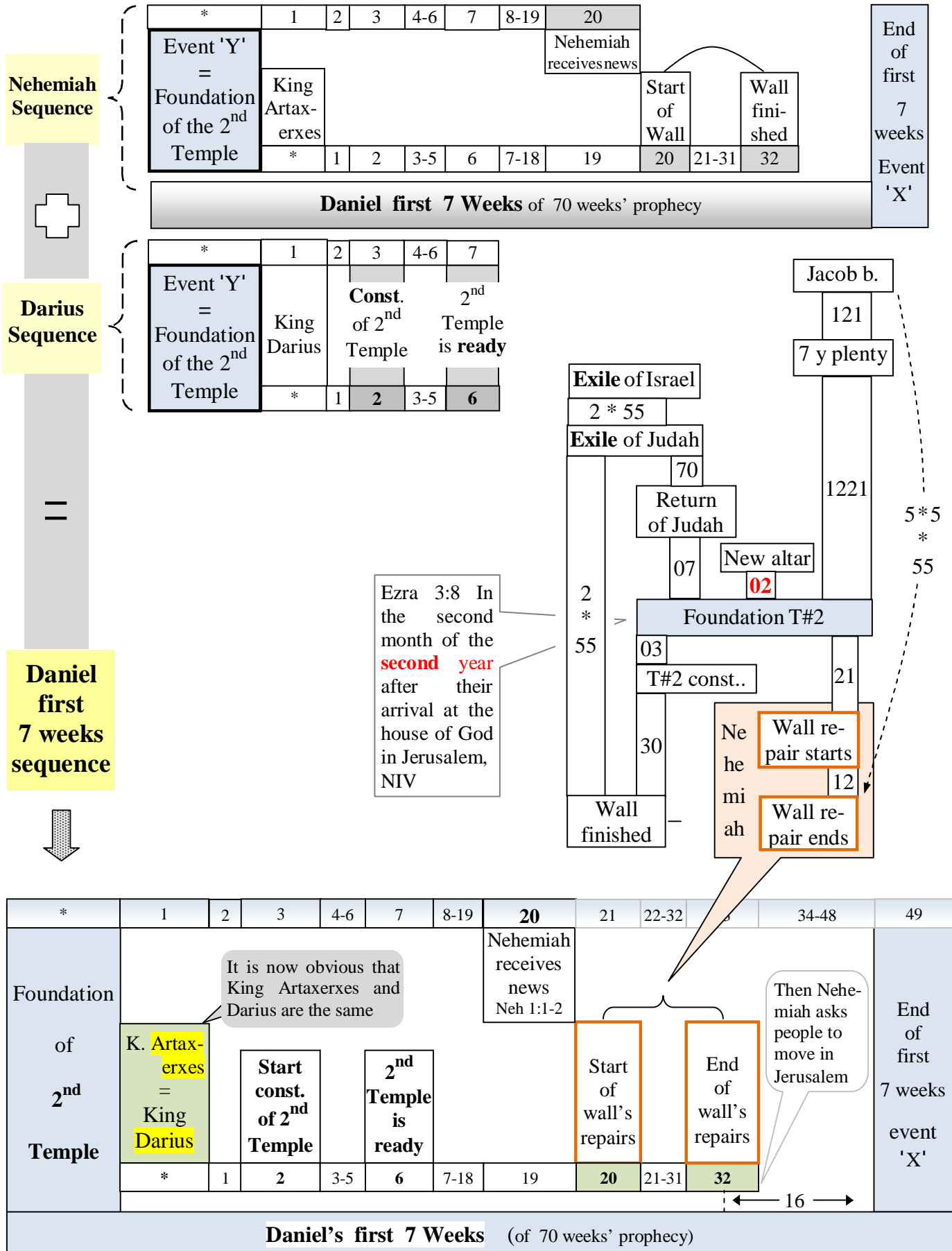
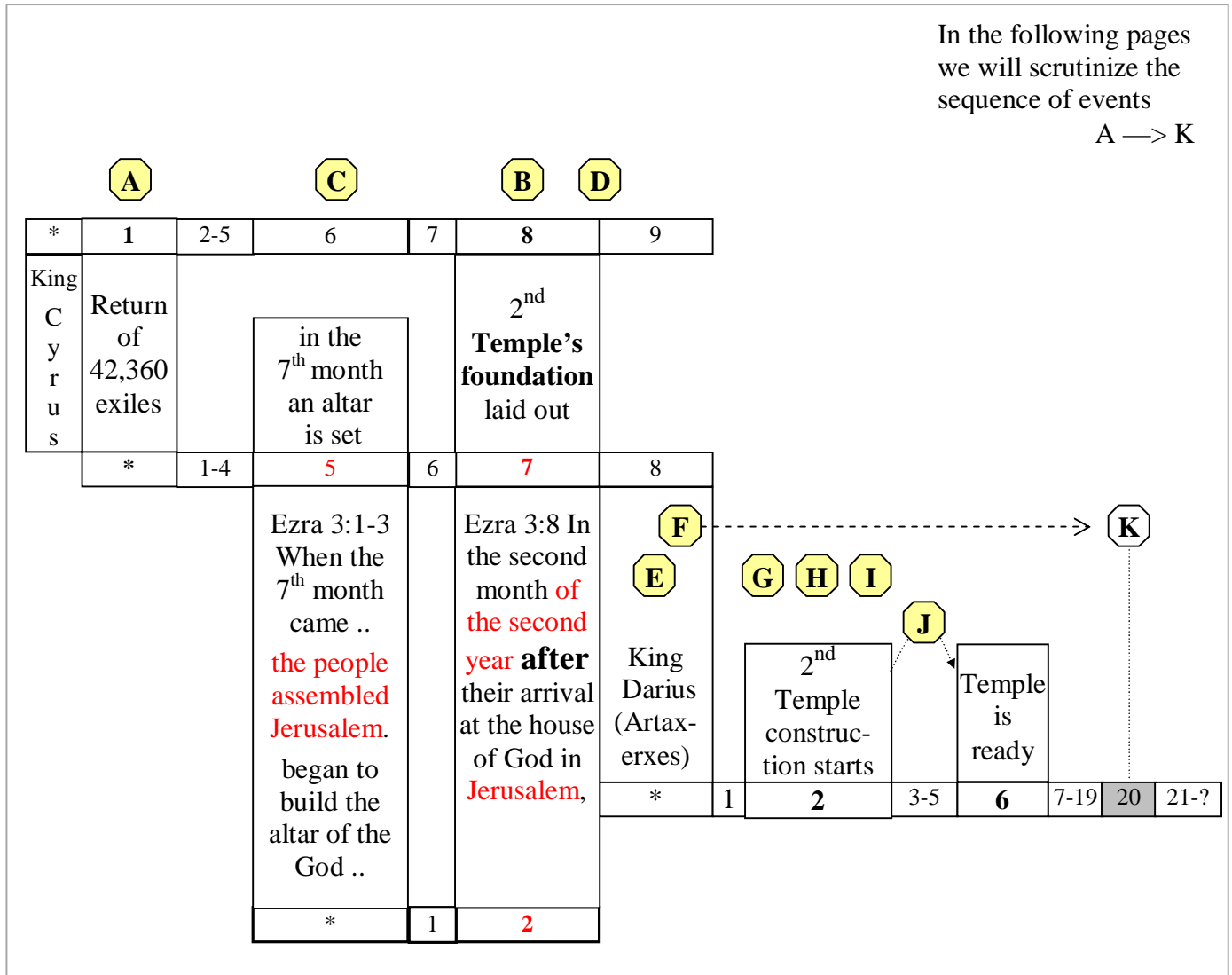

Figure 18 Post Foundation

What can we learn from the book of Ezra about the second Temple period?

Going through the book of Ezra for the first time could be a confusing experience. But, as we will see, once we have the proper sequence of events, Ezra becomes crystal clear.



A Cyrus, in the first year of his reign, allowed the exiles **to return** to Jerusalem and build their temple:

- Ezra 1:1-2 In the first year of Cyrus king of Persia, the God of heaven, has given me all the kingdoms of the earth and he has appointed me to build a temple for him at Jerusalem in Judah. NIV

B According to Figure 17 on page 116 the foundation of the second Temple was laid 7 years after the 'return of the exiles'.

C The people came to Jerusalem in the 7th month to erect an altar:

- Ezra 3:1 And when the seventh month had come, and the children of Israel were in the cities, the people gathered together as one man to Jerusalem. NKJV

We know they returned to Jerusalem before they laid the foundation of the Temple.

- Ezra 3:6 But the foundation of the temple of the LORD was not yet laid. KJV

In Ezra 3:8 says that the Israelites laid the foundation of the Temple (B) in the 2nd year of their coming to the house of God”

- Ezra 3:8 Now in the second month of the second year of their coming to the house of God at Jerusalem, NKJV

So we must conclude, because of B, that they erected an altar in the 5th years after the ‘return of the exiles’ (i.e. **two years before** the foundation of the Temple).

Note that when Ezra 3:8 alludes to ‘coming to the House of God’, we have to understand that he is talking about the devastated site where the Temple had stood before.

Could the Israelites had postponed coming to Jerusalem to erect an altar (and celebrate the Feast of Tabernacles as required) for 5 years? Yes. Have you notice that Ezra 3:1 does specify that the people came from their cities⁸⁴ implying that they had already settled down?

D Zerubbabel’s plan was to construct the 2nd Temple right after the foundation had been laid, but then the enemies⁸⁵ of Judah came and discouraged the people, a situation that started during the time of Cyrus and prevailed until Darius (King of Persia):

- Ezra 4:4-5 Then the people of the land tried to discourage the people of Judah. They troubled them in building, and hired counselors against them to frustrate their purpose all the days of Cyrus king of Persia, even until the reign of Darius king of Persia. NKJV

Important: The enemies of Judah did their obstruction (and prevented the construction of the Temple) without involving King Cyrus. They (the enemies) knew very well that Cyrus was favorable⁸⁶ to the construction of the Temple and it would have been foolish to address him with any request to prohibit any work by the Israelites. This explains why Cyrus never received any letters of complaint from the enemies of Judah.

E It is only when Artaxerxes (i.e. Darius) became king that the enemies wrote to the king. In their letter they complained to this new king that the people were rebuilding the city. (the people in question are the one who came back to Jerusalem to work on the Temple, they were then working on the houses of the city while waiting for the work at the Temple to resume⁸⁷).

- Ezra 4:6-7 At the beginning of the reign of Xerxes, they lodged an accusation against the people of Judah and Jerusalem. And in the days of Artaxerxes king of Persia, Bishlam, Mithredath, Tabeel and the rest of his associates wrote a letter to Artaxerxes.

Note: The ‘Xerxes’ of Ezra 4:6 is another name for Artaxerxes and should not be confused with the ‘Xerxes’ of the book of Esther.

⁸⁴ Given that it was 6 years after the return from exile, the people had had enough time to settle down in their ancestral cities.

⁸⁵ The enemies could be those ‘few’ who were already occupying the land when the exiles came back home.

⁸⁶ Ezra 1:2 Thus says Cyrus king of Persia: All the kingdoms of the earth the LORD God of heaven has given me. And He has commanded me to build Him a house at Jerusalem which is in Judah. NKJV

⁸⁷ Because of the bad counselors, the re-construction of the 2nd Temple was still being delayed.

So at the beginning of his reign Artaxerxes received a letter⁸⁸ informing him that the Jews were rebuilding the rebellious city of Jerusalem:

- Ezra 4:12 The king should know that the Jews who came up to us from you have gone to Jerusalem and are rebuilding that rebellious and wicked city. They are restoring the walls and repairing the foundations [of the city].

Upon receiving this letter King Artaxerxes had a search made in the royal archives and it was found that the city had indeed a long history of revolt:

- Ezra 4:19-20 and a search was made, and it was found that this city has a long history of revolt against kings and has been a place of rebellion and sedition.

F King Artaxerxes sent back a letter forbidding any rebuilding in Jerusalem (no houses, no wall):

- Ezra 4:21 Now issue an order to these men to stop work, so that this city will not be rebuilt until I so order.

Notice that Artaxerxes at this point was not aware that the previous king (Cyrus) had decreed the construction of the Temple. The only purpose for the search in the archives was to verify the allegation that the city had been rebellious in the past. Upon confirmation of it, Artaxerxes (Darius of Persia) ordered the returned exiles not to build anything in Jerusalem.

G In the second year of Darius (that is to say ‘Artaxerxes’) Haggai confronted the people of Judah and told them not to delay the construction of the Temple any more. As a result the people stopped building their houses⁸⁹, came back to the site of the Temple and at long last resume the work on the 2nd Temple. I will refer to it as the ‘Construction of the 2nd Temple’.

- Hag 1:14-15 So the LORD stirred up the spirit of Zerubbabel son of Shealtiel, governor of Judah, and the spirit of Joshua son of Jehozadak, the high priest, and the spirit of the whole remnant of the people. They came and began to work on the house of the LORD Almighty, their God, on the twenty-fourth day of the sixth month in the second year of King Darius.

⁸⁸ Ezra 4:8 Rehum the commanding officer and Shimshai the secretary wrote a letter against Jerusalem to Artaxerxes the king

⁸⁹ We have two strong indications that the people at that time were not building their houses inside the city of Jerusalem:

- 1) King Artaxerxes had forbidden any construction in the city. See **F**
- 2) More than 30 years later, after the completion of the wall we will see that there were still no houses in the city (Jerusalem) and Nehemiah had to take some measures to change this situation:
 - Neh 7:4 Now the city was large and spacious, but there were few people in it, and the houses had not yet been rebuilt.
 - Neh 11:1 Now the leaders of the people settled in Jerusalem, and the rest of the people cast lots to bring one out of every ten to live in Jerusalem, the holy city, while the remaining nine were to stay in their own towns.

H The enemies then sent a new letter to Darius (Artaxerxes) telling him the people had started the construction of their Temple:

- Ezra 5:7-8 The report they sent him read as follows: To King Darius: Cordial greetings. The king should know that we went to the district of Judah, to the temple of the great God. The people are building it

In this letter it was also mentioned that the people who were rebuilding the Temple, pretended that they had been authorized to do so by the late King Cyrus:

- Ezra 5:17 Now if it pleases the king, let a search be made in the royal archives of Babylon to see if King Cyrus did in fact issue a decree to rebuild this house of God in Jerusalem

I King Darius had a new search done in the archives, but this time it was to verify whether King Cyrus (the previous king) had ordered the construction of the Temple:

- Ezra 6:1-3 King Darius then issued an order, and they searched in the archives ...and this was written on it: In the first year of King Cyrus, the king issued a decree concerning the temple of God in Jerusalem:

Upon receiving the confirmation that Cyrus had previously authorized the work, Darius (Artaxerxes) issued a final edict that would quench all oppositions to the construction of the Temple once and for all.

- Ezra 6:7 Do not interfere with the work on this temple of God. Let the governor of the Jews and the Jewish elders rebuild this house of God on its site.

J The construction of the Temple lasted 4 years (from **the second to the 6th year** of Darius):

- Ezra 4:24 Thus the work of the house of God which is at Jerusalem ceased, and it was discontinued until the second year of the reign of Darius king of Persia. NKJV
- Ezra 6:15 Now the temple was finished on the third day of the month of Adar, which was in the sixth year of the reign of King Darius. NKJV

K Important: No matter that he allowed the Temple to be rebuilt, King Darius (aka Artaxerxes) didn't lift the interdiction (ref **F**) to construct any houses (or walls) in Jerusalem. However, in the 20th year of the king, Nehemia was granted the authorisation to repair the wall. Subsequently (see next topic) Nehemiah asked the people to come and live in Jerusalem and build houses.

- Neh 7:4 Now the city was large and spacious, but the people in it were few, and the houses were not rebuilt.

Identifying the end of the first 7 weeks of Daniel's prophecy

The first 7 weeks (=49 years) of Daniel (Figure 18 on page 120) were dedicated to the rebuilding of Jerusalem:

- Dan 9:25 It will be rebuilt with streets and a trench

Nevertheless, when Nehemiah finished the full restoration of the wall, 33 years after the beginning of Daniel first 7-week, not much had been done to reconstruct the city.

- Neh 7:4 Now the city was large and spacious, but there were few people in it, and the houses had not yet been rebuilt.

However, Nehemiah did something that would dramatically improve Jerusalem's situation by making sure that the city would become adequately populated:

- Neh 7:1 Then it was, when the wall was built and I had hung the doors,
- Neh 7:5 So my God put it into my heart to assemble the nobles, the officials and the common people for registration by families.
- Neh 11:1-2 Now the leaders of the people settled in Jerusalem, **and the rest of the people cast lots to bring one out of every ten to live in Jerusalem**, the holy city, while the remaining nine were to stay in their own towns. The people commended all the men who volunteered to live in Jerusalem.

The influx of new people, added to those no longer busy with the restoration of the wall, must have accelerate the transformation of Jerusalem during the following 16 years. There was a lot to do. The city needed to be cleaned⁹⁰, streets had to be repaired, hundreds of new houses had to be build. Interestingly, the nature of those activities make it doubtful that they had to be interrupted at the end of Daniel first 7 weeks.

How do we end the first 7 weeks?

Given that Daniel's first 69-week are separated into two periods (7 and 62 weeks) and that the second period does end with the death of the anointed one, we are justified to seek an important event that would mark the end of the first period of 7 weeks. Are we supposed to assume that sometime during the 49th year (i.e. year ending the first 7 weeks of years) Jerusalem didn't need any more new houses and therefore this important division of Daniel's prophecy was over? Of course not, who could have made this assesment any way? There must be a stronger event to justify in a more obvious way, why those first 7 weeks (of years) needed to be separated from the next 62 weeks (of years)?

- Dan 9:25 there will be **seven 'sevens,'** and sixty-two 'sevens.'

There is an important aspect of the '7 weeks' that has been neglected so far:

- Dan 9:25 It will be rebuilt with streets and a trench, **but in times of trouble.**

⁹⁰ Let's keep in mind that when Nehemiah finished the wall, Jerusalem had been almost continually deserted for 100 years.

- ❖ Nobody ever paid attention to this very important clue, Dan 9:25 plainly says that the period covering the reconstruction of Jerusalem would be a period of **fear, violence and intimidation** against the Jews.

<p>Notice what was going on during the construction of the second Temple:</p>	
<p>Ezra 4:4 Then the peoples around them set out to discourage the people of Judah and make them afraid to go on building.</p>	The builders
<p>Ezra 4:6 At the beginning of the reign of Xerxes, they lodged an accusation against the people of Judah and Jerusalem</p>	in
<p>Ezra 4:23 they went immediately to the Jews in Jerusalem and compelled them by force to stop.</p>	Jerusalem were
<p>And notice how things hadn't changed by the time they rebuilt the wall:</p>	surrounded
<p>Neh 4:1 When Sanballat heard that we were rebuilding the wall, he became angry and was greatly incensed. He ridiculed the Jews,</p>	by
<p>Neh 4:8 They all plotted together to come and fight against Jerusalem and stir up trouble against it.</p>	ennemies
<p>Neh 4:12 "Wherever you turn, they will attack us."</p>	trying
<p>Neh 4:16 From that day on, half of my men did the work, while the other half were equipped with spears, shields, bows and armor.</p>	to stop
<p>Neh 6:2 But they were scheming to harm me;</p>	the
<p>Neh 6:14 remember also the prophetess Noadiah and the rest of the prophets who have been trying to intimidate me.</p>	work

Since the whole of the first 7 weeks was going to be marked by anguish, we can deduce that something of major importance must have happened to end these 7 weeks and make the violence stop. If this had not been the case, the word **'trouble'** wouldn't have been singled out as the **major** characteristic of those first 7 weeks.

Not surprisingly there is an event that happened during the post-exile that fits like a glove. This event is described in the book of Esther.

In the 12th year of King Xerxes (King Ahasuerus) the Jews from all the provinces of the Persian Empire (that would have included Jerusalem and the region around) were going to be annihilated according a king's decree suggested by the evil Haman (see Est 4:13-14).

Est 9:24 For Haman son of Hammedatha, the Agagite, the enemy of all the Jews, had plotted against the Jews to destroy them and had cast the pur (that is, the lot) **for their ruin and destruction.** NIV

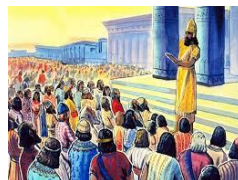

Here is Esther's interpretation of Haman's decree:

Est 7:4 For I and my people have been sold for destruction and slaughter and annihilation.

For many months after Haman's decree was issued, it had been known that **on the 13th day of the 12th month** (Jewish month known as Adar) the enemies of the Jews would be allowed to kill them in all impunity.

- Est 3:13 Dispatches were sent by couriers to all the king's provinces with the order to destroy, kill and annihilate all the Jews-young and old, women and little children-on a single day, the thirteenth day of the twelfth month, the month of Adar ...

Notice that Haman didn't contend with the immediate execution of the genocide, he rather made it known, months ahead, what was going to happen in order to better terrorize his future victims.

Est 4:3 In every province to which the edict and order of the king came, there was great mourning among the Jews, with fasting, weeping and wailing. Many lay in sackcloth and ashes. NIV

This psychological warfare fits perfectly well with the spirit of Daniel first 7-week. Fortunately, due to a miraculous reversal of the original plan, the massacre didn't happen. King Xerxes authorized all the Jews of his kingdom to get organized and to fight back against all their enemies. That day (which has been known ever since as the **Day of Purim** and has been celebrated by the Jews from all around the world), the 13th of Adar, and the next day, more than 75,000 enemies of the Jews were killed:

- Est 9:1 On the thirteenth day of the twelfth month, the month of Adar, the edict commanded by the king was to be carried out. On this day the enemies of the Jews had hoped to overpower them, but now the tables were turned and the Jews got the upper hand over those who hated them
- Est 9:16 Meanwhile, the remainder of the Jews who were in the king's provinces also assembled to protect themselves and get relief from their enemies. They killed seventy-five thousand of them but did not lay their hands on the plunder

Could there be a better 'biblical' event to mark the end of the first 7 weeks of Daniel? – seven weeks (49 years) that had been characterized by troubles (against the Jews) right from the start?

Let's see how we can integrate this new information with our timeline and learn even more.

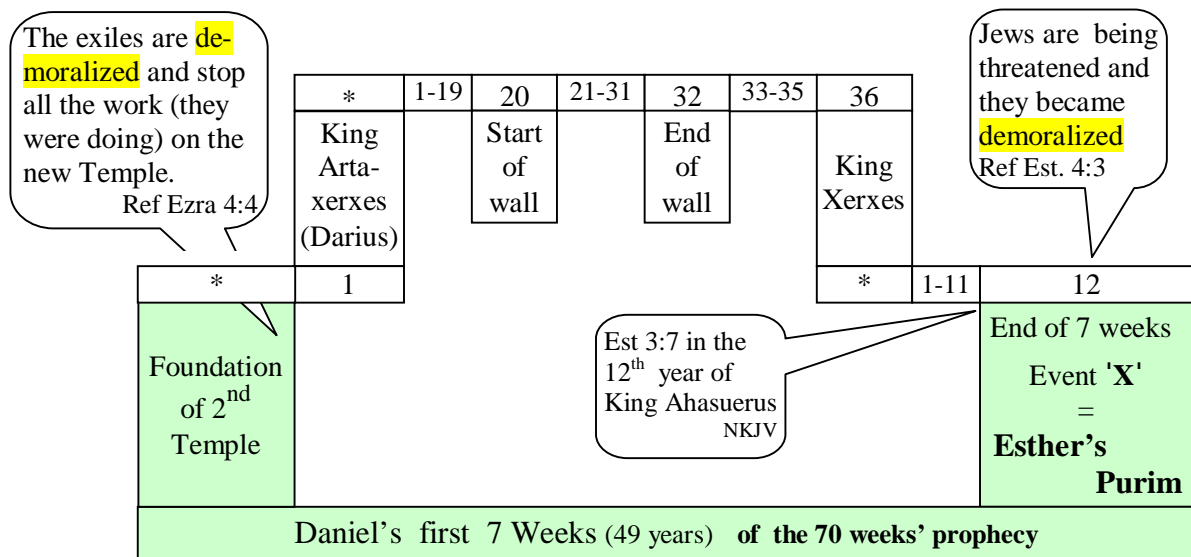

Post Exile chronology

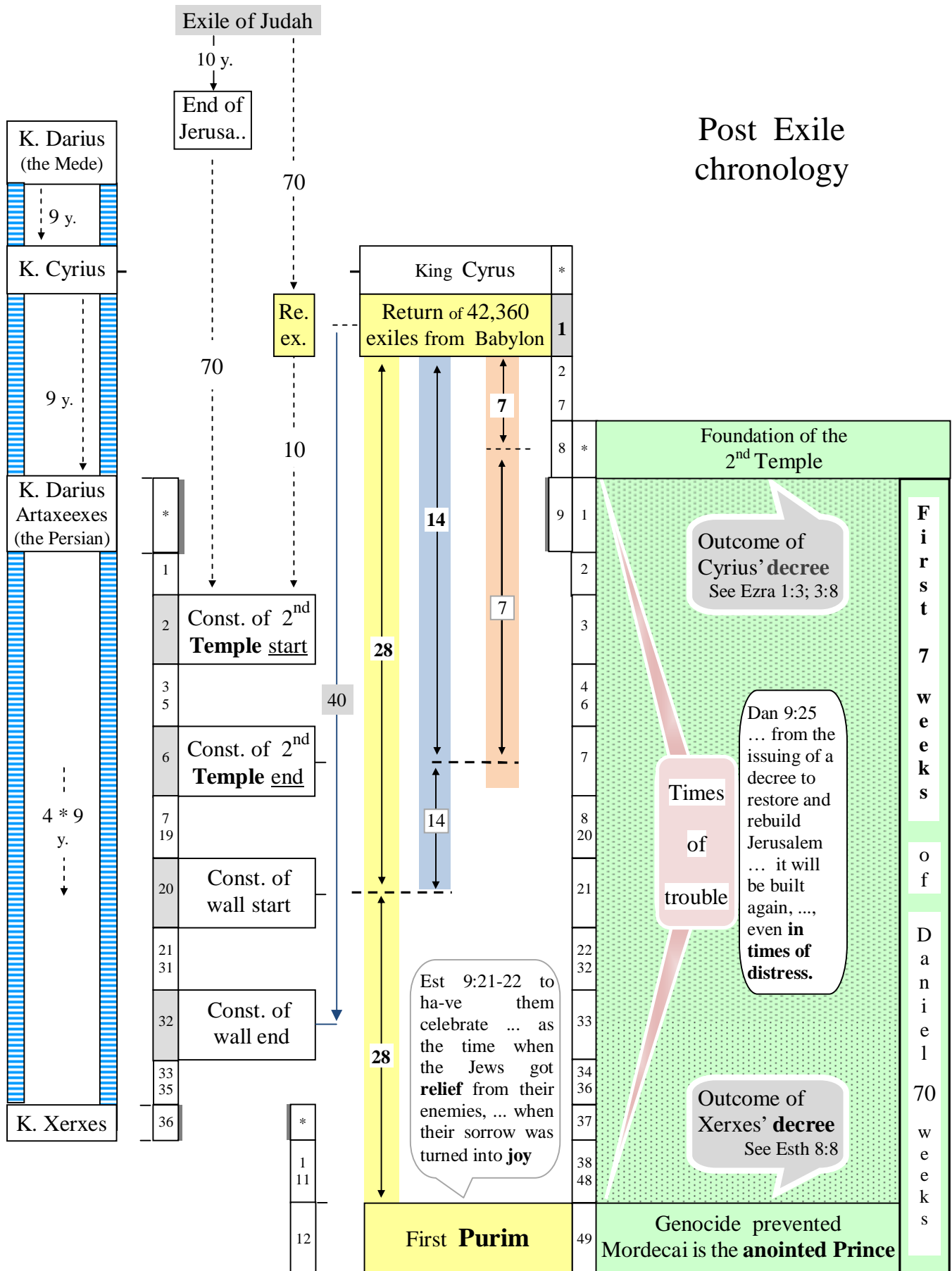

Figure 19 Post Exile chronology

Let's revisit Daniel 9:25-26.

No linguist will contest this: to really understand the structure of Daniel 9 one have to be fluent in Hebrew. Unfortunately I don't have any rudiment of this language. However I do have an invaluable tool that compensate this shortcoming: a solid post exile chronology.

A few facts to keep in mind

Dan 9:25-27 25 "Know and understand this: From the issuing of the decree to **restore and rebuild Jerusalem** until the **Anointed One**, the **ruler**, comes, there will be **seven 'sevens,'** and sixty-two 'sevens.' It will be rebuilt with streets and a trench, **but in times of trouble.** 26 After the sixty-two 'sevens,' the **Anointed One** will be cut off and will have nothing. **The people of the ruler** who will **come will destroy the city** and the sanctuary. The **end will come like a flood:** War will continue until the end, and desolations have been decreed. 27 **He** will confirm a covenant with many for one 'seven.' In the middle of the 'seven' he will put an end to sacrifice and offering. And on a wing [of the temple] he will set up an abomination that causes desolation, until the end that is decreed is poured out on him." NIV

The 7 weeks and the 62 weeks follow each other without any intervening gap.

the coming of an anointed one, a prince is associated with the end of the first 7 weeks.

'The time of trouble' fits perfectly well with the first 7 weeks.

An individual is associated with each period

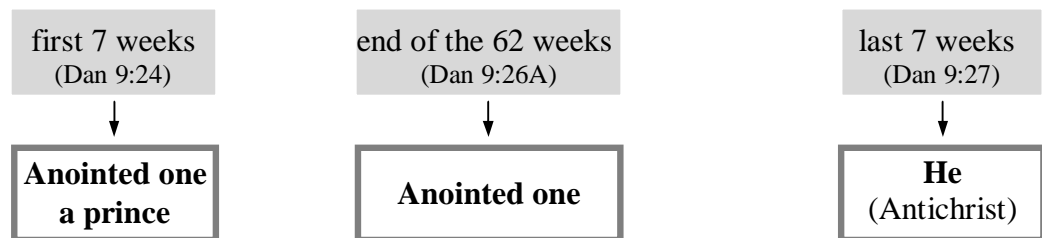

The attack against Jerusalem in 70 AD came like a flood when the Roman army suddenly encircled the city. The sanctuary was by the soldiers under their own initiative, Titus, their commander in charge, had intended to preserve it.

'Destruction of Jerusalem' and 'War will continue until the end' (dan 9:26B) are part of the period between the end of the first 69 weeks and the beginning of the 70th week.

In the previous page we have associated the end of the first 7 weeks of Daniel with the establishment of Purim. We can now point to the real identity of the 'Anointed one, the Prince' mentioned in Daniel 9:24. Without doubts it can be no one else than **Mordecai** (Queen Esther's uncle).

- Est 8:15 Mordecai left the king's presence **wearing royal garments of blue and white, a large crown of gold** and a purple robe of fine linen. NIV
- Est 9:4 Mordecai was prominent in the palace; his reputation spread throughout the provinces, and he became more and more powerful. NIV
- Est 10:3 **Mordecai the Jew was second in rank to King Xerxes**

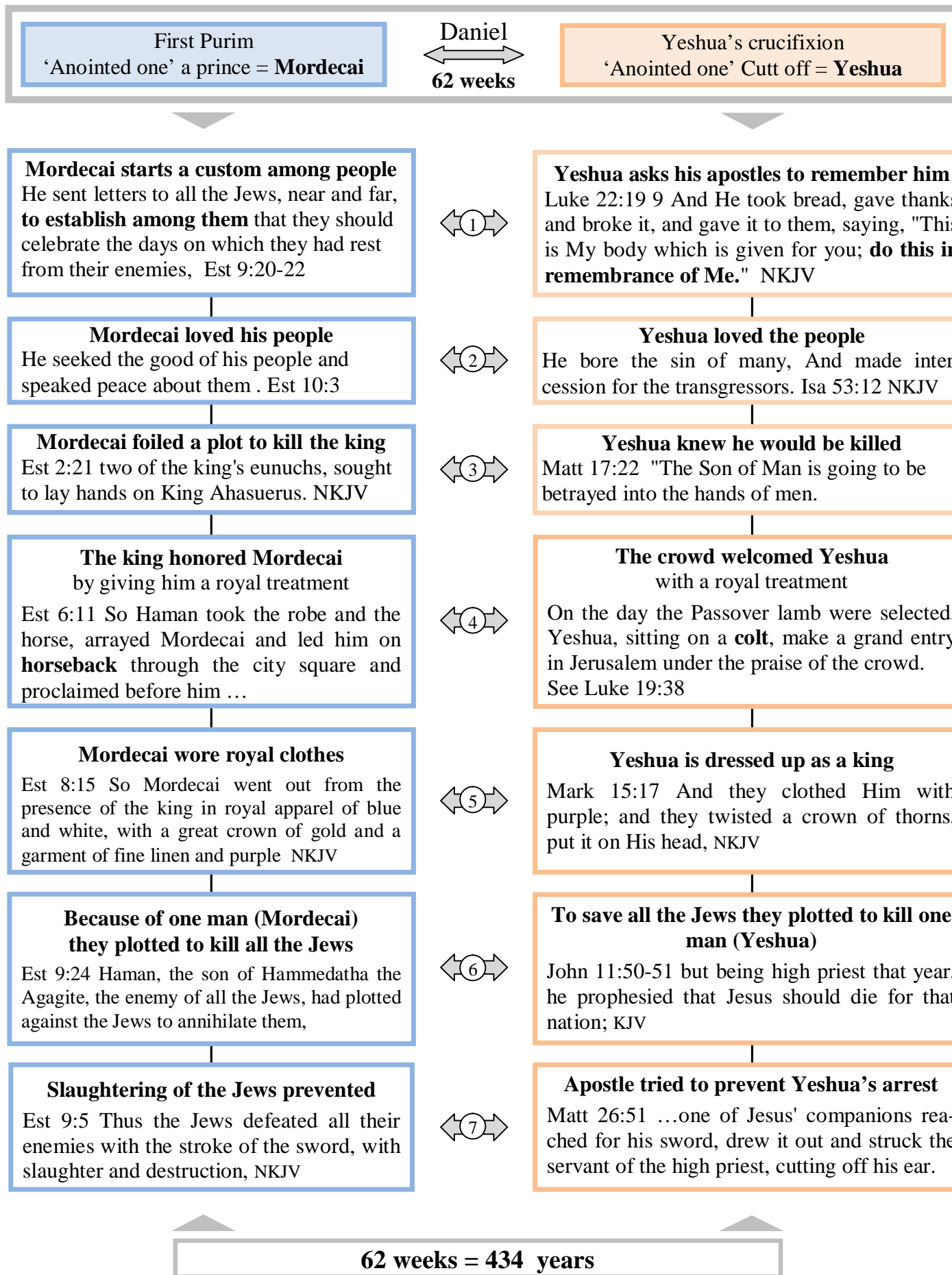

Daniel's 70 Weeks: A time allotment fully overlapping the 2nd and 3rd Temple era

In this book you have learned that the first 7-week starts with the 'Foundation' of the second Temple. We already know that the next 62 weeks ended with Yeshua's death. Less obvious is the fact that the end of those 62-week also coincides with the SYMBOLICAL end of the second Temple? Here is how:

When Yeshua died	a Temple of God was also destroyed	John 2:19 Jesus answered them, " Destroy this temple , and I will raise it again in three days." NIV
	No more separation between God and humanity	John 2:21 But the temple he had spoken of was his body. NIV Eph 2:21 In him [Yeshua] the whole building is joined together and rises to become a holy temple in the Lord
	the 2 nd Temple lost its legitimacy <i>more on p. 156</i>	<div style="border: 1px dashed black; padding: 5px;"> <p>Matt 27:51-52 At that moment the curtain of the temple was torn in two from top to bottom the curtain 'no longer functioned to keep what lay on the other side of it a secret from those outside (Leon Morris)</p> <p>Matt 23:38 Your house is left to you desolate; NKJV The need for a human high priest and a physical Temple was eliminated. Heb 9:11-12 "when Christ appeared as a high priest . . . , He entered through the greater and more perfect tabernacle ... through his own blood.</p> </div>

Note: The 70th week of Daniel will overlap a third Temple period in Jerusalem.

Dan 9:27 Then he shall confirm a covenant with many **for one week**; But in the middle of the week He shall bring an end to sacrifice and offering. NKJV

2 Thess 2:4 who opposes and exalts himself above all that is called God or that is worshiped, **so that he sits as God in the temple of God**, showing himself that he is God.

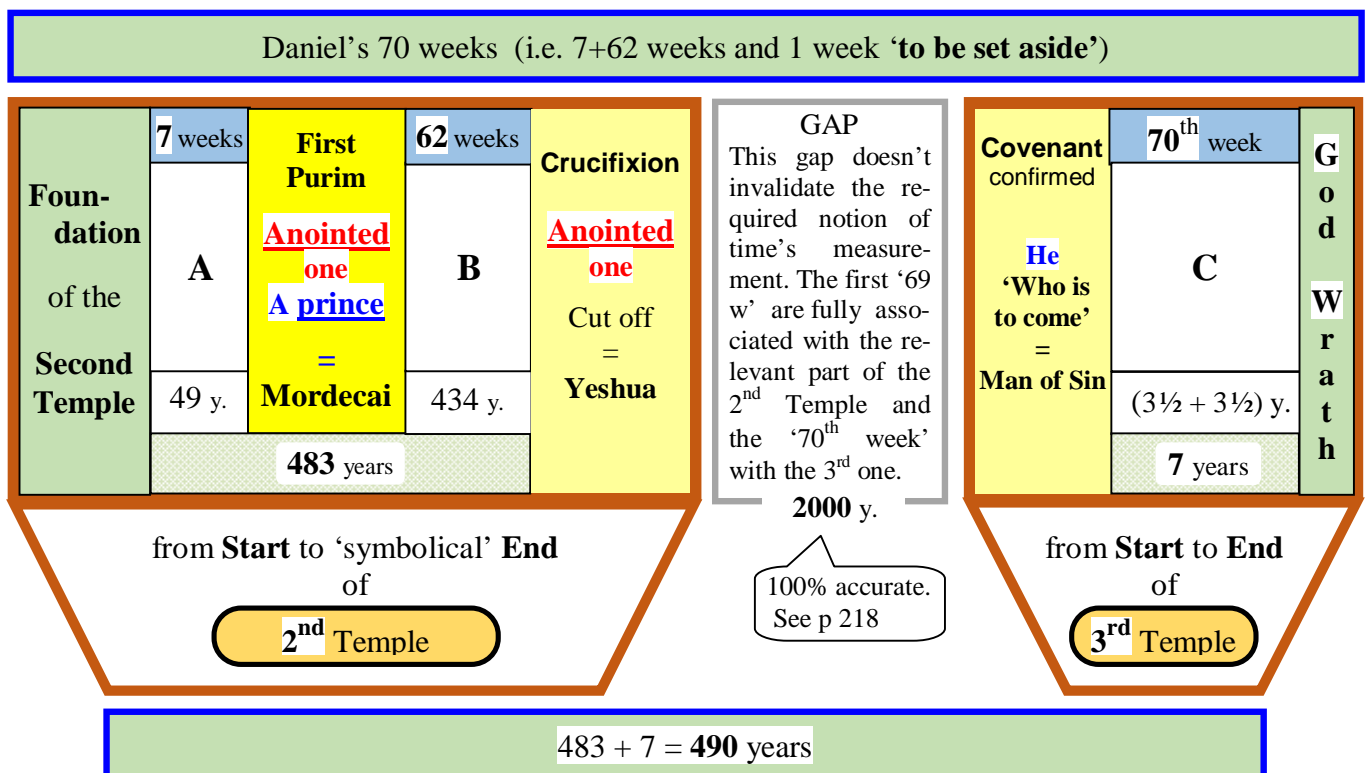

There is another good reason to insert a gap between the first 69 weeks and the 70th. We are told in Dan 9:24 that 70 week are necessary to accomplish the following 6 majors goals:

- Dan 9:24 Seventy weeks are determined upon thy people and upon thy holy city, (1) **to finish the transgression**, and (2) **to make an end of sins**, and (3) **to make reconciliation for iniquity**, and (4) **to bring in everlasting righteousness**, and (5) **to seal up the vision and prophecy**, and (6) **to anoint the most Holy**.

The first three goals were completed during Yeshua first coming (i.e. at Yeshua's death when He was cut off at the end of the first 69 weeks.)

And the last 3 goals can only be achieved with the second coming

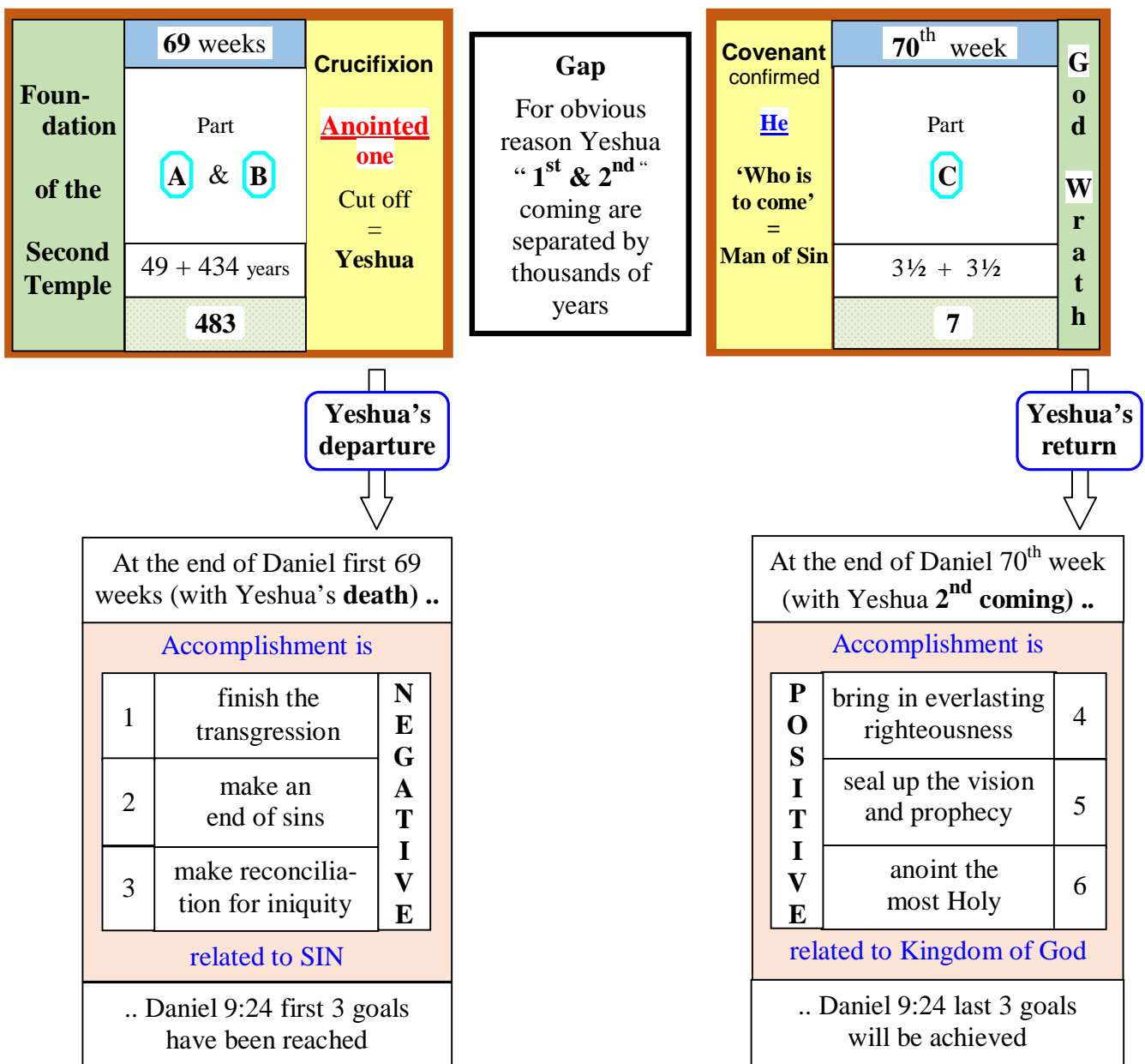

Ezekiel fasts during 40 days

(this symbolic act is the counterpart to 'Ezekiel ate defiled food for 390 days' on p. 67)

God originally intended to have Ezekiel cook his food over human excrement. However, this ordeal was lightened following Ezekiel's objection that he had never defiled himself in the past.

- Ezek 4:14 So I said, "Ah, Lord GOD! Indeed I have never defiled myself from my youth till now; I have never eaten what died of itself or was torn by beasts, nor has abominable flesh ever come into my mouth."

Ezekiel's food was cooked over cow manure, an acceptable compromise to the prophet.

- Ezek 4:15 Then He said to me, "See, I am giving you cow dung instead of human waste, and you shall prepare your bread over it."

Apparently Ezekiel's food was still symbolically defiled, no matter how it was cooked.

- Ezek 4:13 "So shall the children of Israel eat their defiled bread among the Gentiles,

So, after 390 days of eating defiled food, Ezekiel turned over and fasted⁹¹ for a period of 40 days. We saw earlier (see page 67) that the prophet eating defiled food was a symbolic act portraying a period during which Israel would only hear lies instead of the true words of God. In a way Israel was given poisonous food for the mind. What then should we think of the prophet fasting during the following 40 days? There is such a powerful contrast between Ezekiel two successive actions (eating defiled food – fasting) that we should also find a similar contrast between the two periods portrayed by them.

Symbolically, Ezekiel's 40 days fast (while lying on his right side) was like cleansing 'purging' his body. This is the characteristic that we will use to identify the intended period associated with the house of Judah. Indeed, at one point the people of Judah must have gone through a radical change that literally initiated what would become a '40 years cleansing period'. And, to mark the end of that 40 year period, we should also find the occurrence of another event that will 'metaphorically' denote how Judah's cleansing ended and how the people were reintroduced to a proper diet for the mind.

The period portrayed by the symbolic act "**Ezekiel fasts during 40 days**" will have to meet the following criteria:

- Should start with an important change: (lies and idolatry ceased)
- Create a strong contrast with the period portrayed by the 390 years of defiled food.
- Absence of any 'indoctrination' during 40 years. (portrayed by Ezekiel's fasting)
- Should end with an important change (adequate learning would be provided again, keep in mind that after his 40 days fast, Ezekiel started feeding himself again.

The '**Return of the 42,360 exiles**' points to the time when Judah (under the leadership of Zerubbabel) came back from the Babylonian captivity. This event is the perfect candidate to mark the start of the 40 years cleansing period we are looking for. Indeed, as illustrated in the next figure, the return of the exiles marked the end of a 390 year period characterized by the

⁹¹ This is implied by the absence of food during the time Ezekiel lied on his right side.

proliferation of false prophets and the spreading of idolatry. The people of Judah spent the last 70 years of this 390 year period in Babylon, an environment associated with paganism.

390 years of 'eating defiled food'									
*	1-319	320	321-329	330	331-389	390	391-429	430	
Foundation of Samaria		Exile of Judah		Destruction of Jeru..		Return of Judah		Nehemiah ends the wall's repairs	Ezra reads the law
	*	1 - 9		10		11 - 69			
Judah 70-year of exile									
	*	1 - 39		40					
40 years of cleansing « No teaching received »									

See p.128 (28+12)

When they came back from captivity, the 42,360 exiles of Judah didn't receive any teaching of the law for 40 years. They spent the time by rebuilding the cities, the houses, the Temple, and the Jerusalem's wall that Nebuchadnezzar's army had left in ruin 60 years earlier. During this 40 years they didn't have any exposure to idolatry neither to the law of God, we should view that period as **40 years of cleansing**.

A very short time after the wall was fully repaired, the law of God was read by Ezra. It was the first time in centuries that the people of Judah heard it.

Neh 7:11 After the wall had been rebuilt and I had set the doors in place NIV

Neh 7:73-8:1 When the seventh month came and the Israelites had settled in their towns, all the people assembled as one man in the square before the Water Gate. **They told Ezra the scribe to bring out the Book of the Law of Moses**, which the LORD had commanded for Israel. NIV

The reading of the law (about 6 days after Nehemiah completed the repairs on the wall) marks the end of the 40 years of cleansing that the people of Judah went through after the return from Exile. Notice how Ezekiel two consecutive symbolical acts (eating defiled food during 390 days, fasting during 40 days) portray two successive periods.

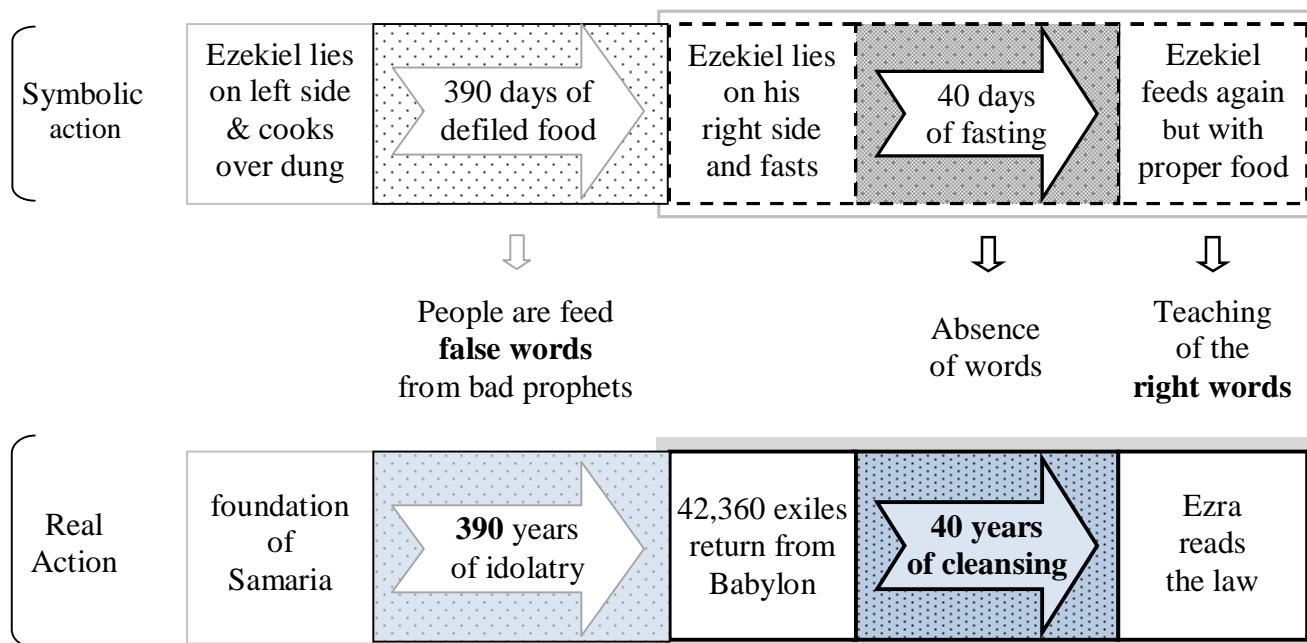

Ezekiel's famine of words

Right from the beginning of his priesthood Ezekiel was given an absolutely clear mandate. He would be sent among his brothers Israelites as a prophet and would have to tell them that their ways were doomed:

- ✓ Ezek 2:4 and you shall **say** to them, 'Thus says the Lord GOD.' NKJV
- ✓ Ezek 2:7 You shall **speak** My words to them NKJV
- ✓ Ezek 3:1 and go, **speak** to the house of Israel. NKJV
- ✓ Ezek 3:4 "Son of man, go to the house of Israel and **speak** with My words to them.
- ✓ Ezek 3:11 ... and **speak** to them and tell them, 'Thus **says** the Lord GOD NKJV
- ✓ Ezek 3:18 When I say to the wicked, 'You shall surely die,' **and you give him no warning, nor speak** to warn the wicked from his wicked way, NKJV

Ezekiel was not allowed to refuse God's call. No matter what, he would be accountable should he fail to relay the appropriate warning to the wicked:

- Ezek 3:20 because you did not give him warning, ... but his blood I will require at your hand. NKJV

As we can see from the previous references, Ezekiel was reminded again and again that he would have to talk to his people. But then, just when Ezekiel should have started to fill his assignment, **the most unexpected thing happened.** Ezekiel was asked to go and shut himself in his house for 430 days.

- Ezek 3:24 "Go, shut yourself inside your house. NIV

And the Spirit deliberately stuck Ezekiel's tongue to the roof of his mouth to incapacitate the prophet in such a way that **it became impossible for him to orally communicate with others:**

- Ezek 3:26 I will make your tongue stick to the roof of your mouth so that you will be silent and unable to rebuke them, NIV

So to stress what is now obvious: Ezekiel, the prophet, specially commissioned to talk to his brothers the Israelites, spent 430 days lying on his side, being unable to speak. During these 430 days, Ezekiel didn't receive and didn't deliver any word from God.

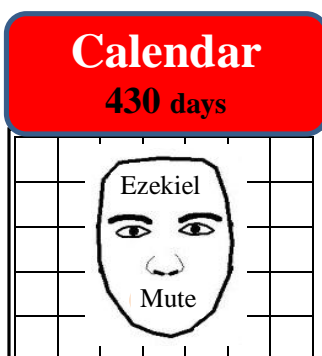

Doesn't this strange situation make a lot more sense if we recognize that Ezekiel's period of silence was yet another symbolic act? Ezekiel's 430 days of silence are screaming to draw our attention to **a famine of words** that was going to prevail for some 430 years.

“The spirit incapacitated Ezekiel to deliver the words of God. Therefore this situation directly point toward a famine of words from God himself.

Amos 8:11-12 "Behold, the days are coming," says the Lord GOD, "That I will send a famine on the land, Not a famine of bread, Nor a thirst for water, **But of hearing the words of the LORD.** They shall wander from sea to sea, And from north to east; They shall run to and fro, seeking the word of the LORD, But shall not find it. NKJV



Now, starting at the time of the ‘Covenant between the parts’ and moving forward, using some of the ‘marker event’ previously seen in this paper, can we pinpoint a 430-year period during which there was, in all likelihood, no communication from God? Yes, and it can be done without any difficulty. The following timeline shows six successive periods obtained by the use of 7 events already seen in this paper. The easiest way to isolate the period of silence we are looking for is to disqualify each period during which God maintained some form of communication with the Israelites. Inevitably⁹² only the right period will remain.

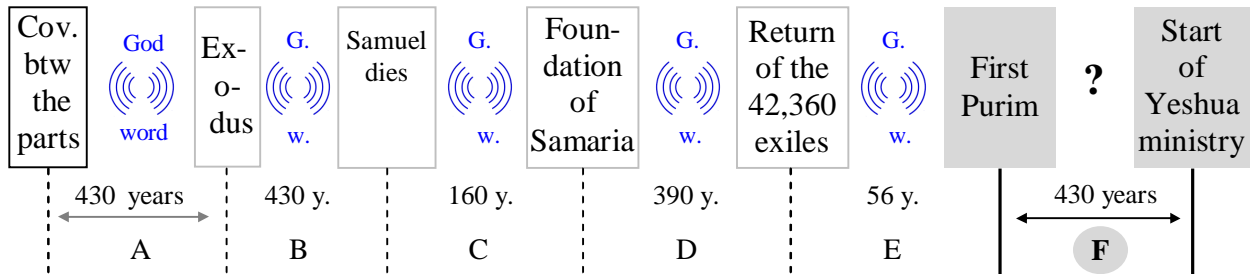

References to each period:

- A : Page 88
- B : The 3 blocks view on page 61
- C : Samuel dies to Ark in Temple (60 y.) on page 63
Ark in Temple to Samaria (100 y.) on page 71
- D : Defiled food on page 71
- E : Figure 19 Post Exile chronology on page 128
- F : Figure 17. Second Temple period on page 116

From what we know, there was some instances of communication from God or His prophets during periods (A,B,C,D,E). This leave period ‘F’ as the only period worthy of investigating. Is this period of 430 years characterized by a ‘Famine of the words’? I believe so.

The first occurrence of a Jewish Purim

We saw (p.128) that 56 years after the return of the exiles one reaches the first occurrence of the Jewish Purim. In the book of Esther⁹³ an amazing sequence of coincidences conspire to save the Jews from annihilation. It is obvious to any readers that God worked behind the scene to help the Jews right from the start. Yet, what followed is beyond comprehension.

The day after they had killed all their enemies, the Jews of the Persian Empire had an opportunity to collectively thank God and to exalt His name, but none of this happened. Instead, Esther and Mordecai, two of the four⁹⁴ characters of the story’s, institutionalised a new feast to mark the DAY of the Jewish’s salvation from Haman national holocaust. They called this new festival ‘**PURIM**’, a name that commemorates “LOT” (or cast lot) **the exact opposite of acknowledging God’s genuine involvement**. Since then, each year, the Jews across the world commemorate what happened to their ancestors by exchanging gifts between themselves and by remembering what Mordecai and Esther had done for the people (as opposed to what God had done for them).

⁹² We rule out that there was more than one ‘famine of words’ that could have lasted 430 years.

⁹³ Trivialized by everybody, there is a shocking absence in the book of Esther: **the name of God is never mentioned**. It is *the only book of the Hebrew Bible that doesn’t mention God*. According to the Jewish sages there is a play of words using the name Esther in Hebrew that could mean ‘hiding of the face’).

⁹⁴ King Xerxes, Haman the Agagite, Mordecai the Jew and his niece Esther.

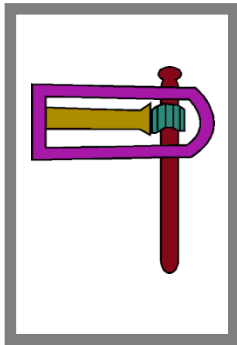

One tradition, still in force nowadays when listening to the reading of the book of Esther, is to **drown out** the name of Haman whenever it is heard with **noise and “booing”**.

Noise & Masks

Another tradition is to wear mask. In the book of Esther the story starts with the king **exposing** in every possible way the wealth of his kingdom and ordering his wife to **exhibit** in front of everybody. Later he take a new wife, Esther, who **hides** her true identity; finally it is all the Jewish people who will wish to **hide** because Haman wanted to kill all of them.

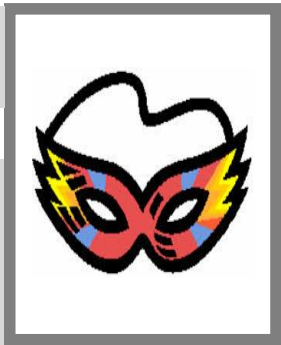

In some surprising way the author of the book of Esther highlighted a string of incredible coincidences whose outcome culminated with the unexpected salvation of the Jewish people at the exact time they were supposed to be slaughtered. Then why, in spite of God’s perceptible involvement in every circumstance or people’s action described in the story, **did the author choose to never explicitly mention His name?**

Even though the story culminates with the days of triumph it doesn’t stop at that point. The second half of Esther 9 tells us that Mordecai sent letters everywhere in the kingdom asking the Jews to commemorate the days of Purim (14th & 15th Adar) every year. Under Mordecai’s insistence this new festival, featuring a ‘**theme**’ of **concealment**, was thus initiated. **Could there have been a divine but hidden agenda put in motion at that very same time?** I say ‘yes’ to that.

Given that the absence of the name of God is a major characteristic of the book of Esther it is not unreasonable to assume that the 430 years of silence portrayed by Ezekiel had its true origin right at the time of the first day of Purim (the turning point of the Megilat Esther story).

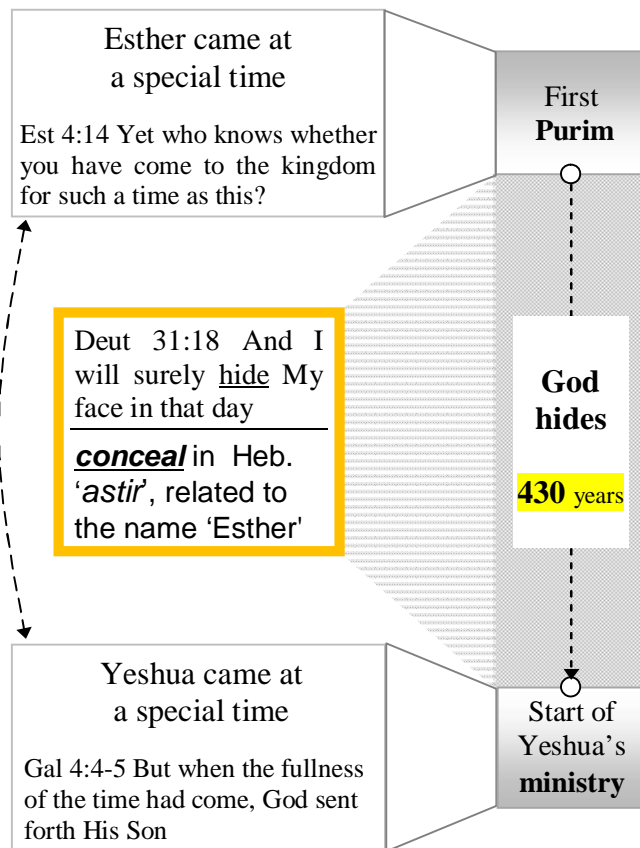

A holiday during which people **hide their face**

2 Cor 3:13-14 unlike Moses, who put a veil over his face so that the children of Israel could not look steadily at the end of what was passing away. But their minds were blinded.

Yeshua came to remove the veil
So we can now understand the **(words of the) Father**.

2 Cor 3:14 or until this day the same veil remains unlifted in the reading of the Old Testament, because the veil is taken away [*only*] in Christ.

John 14:9 Anyone who has seen me has seen the Father.

Yeshua came to reveal the father (no more hiding)

According to the Jewish belief, after the Megillat Esther there were no more prophets, no more miracles, no more communication from God. **“only silence”**

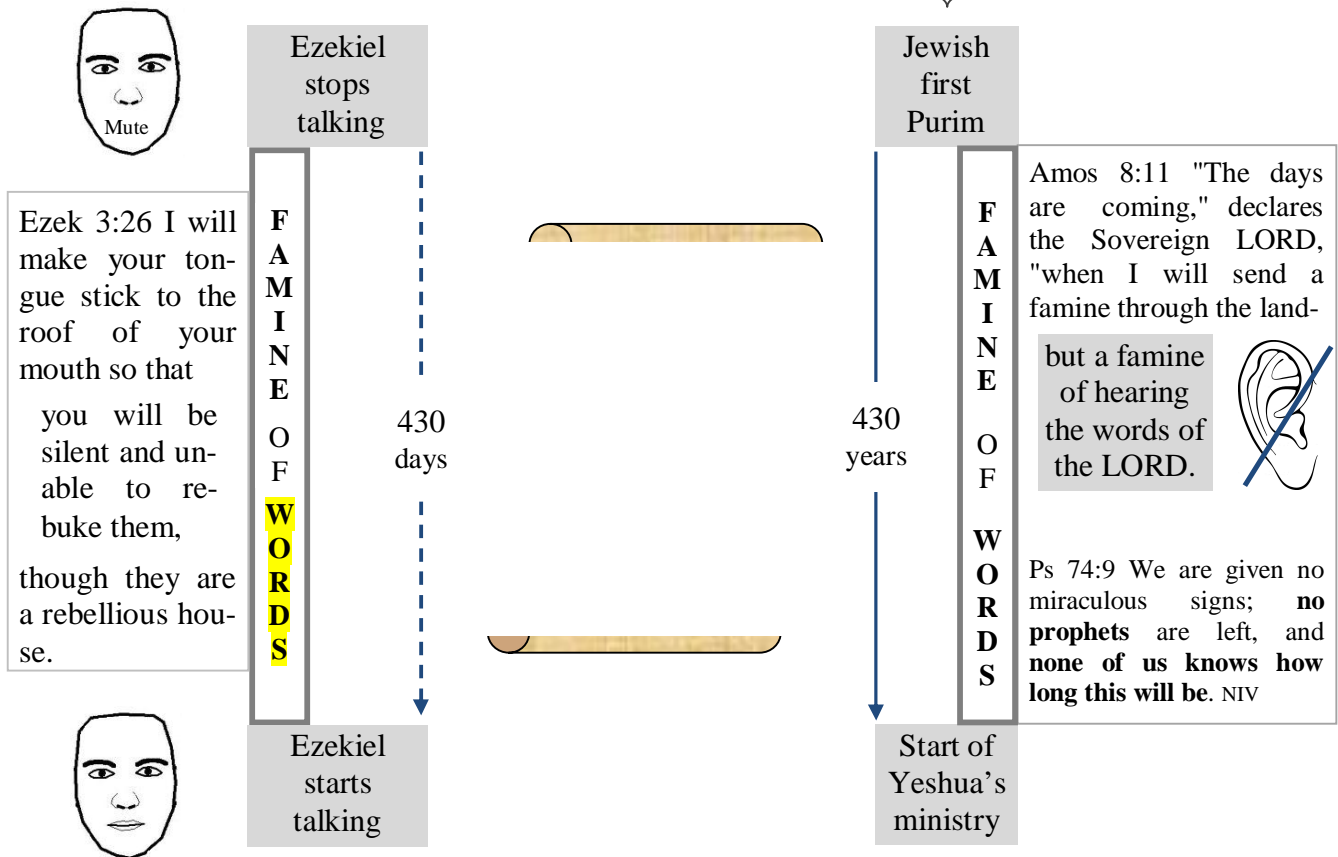

Note: Rabbi Daniel Krentzman connects **Esther** and **Yeshua** the following way:

Esther's utilization of secrecy and

Est 2:10 Esther had not revealed her people or family, for Mordecai had charged her not to reveal it. NKJV

deception in order to bring about the salvation of the Jewish people also stemmed from the quality of Mashiach ben Yosef [i.e. Yeshua] to act in secrecy

Matt 16:20 Then He [Yeshua] commanded His disciples that they should tell no one that He was Jesus the Christ.

and deceptively, in order to further the goals of Tikun Olam and the Redemption.”

Tikun Olam : the establishment of Godly qualities throughout the world

Did the start of Yeshua's ministry' brought back the prophets and some communication from God? Yes it did and here are a few references of the change that happened:

Luke 4:18,21 "The Spirit of the Lord is on me, because he has anointed me to preach good news to the poor. ---"Today this scripture is fulfilled in your **hearing.**"

Luke 3:22-23 And the Holy Spirit descended in bodily form like a dove upon Him, **and a voice came from heaven** which said, "You are My beloved Son; in You I am well pleased." Now Jesus Himself began His ministry at about thirty years of age..

Luke 4:24 Then He [Yeshua talking about himself] said, "Assuredly, I say to you, **no prophet** is accepted in his own country. NKJV

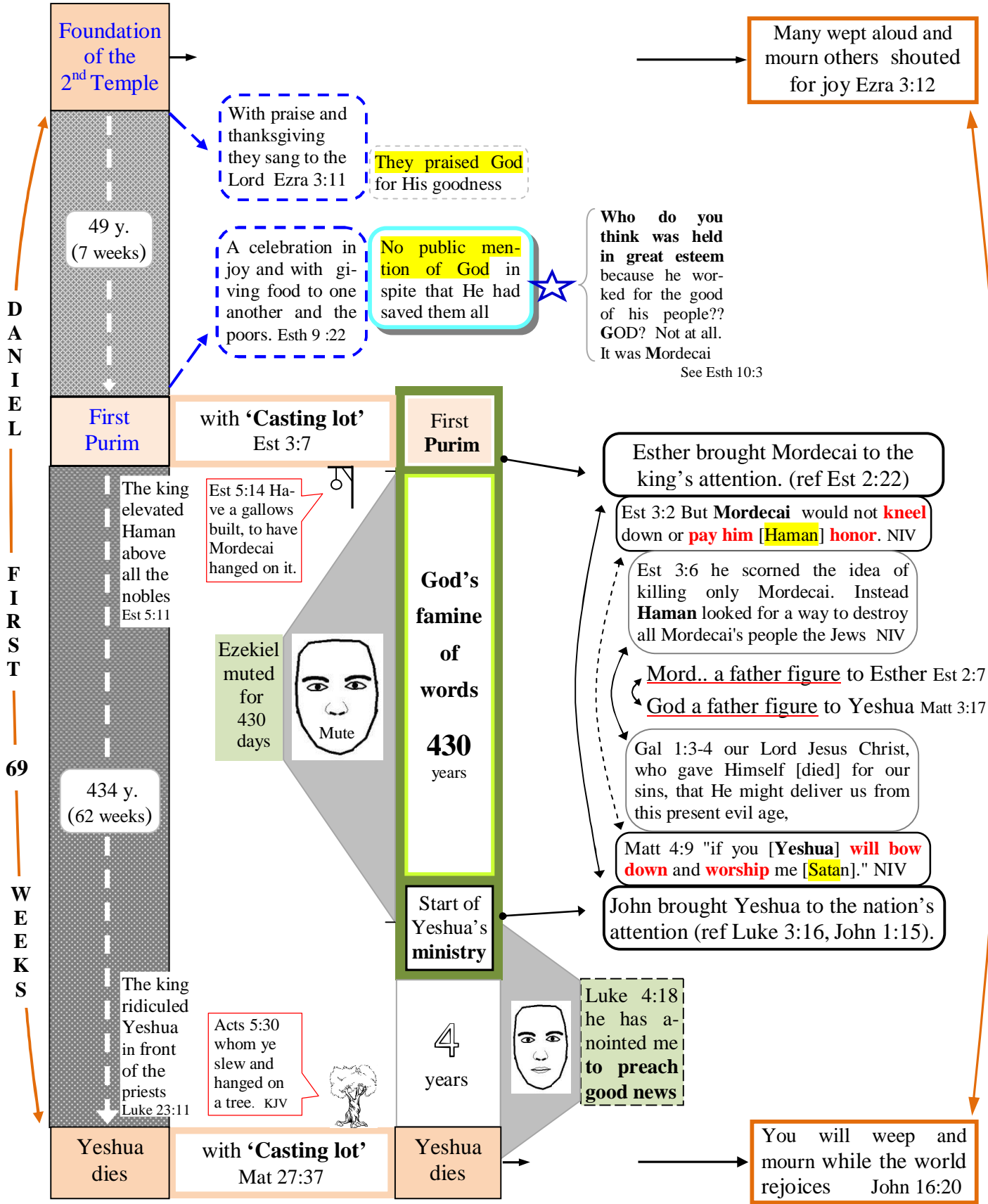

★ **Not convinced that they ignored God?** How did the Jews call the day of their deliverance? "God with us" ? "Saved by God" ? Nope. They called it Purim from the Hebrew word "PUR" meaning LOTS. Is there a concept more alien from divine providence than LOTS?

CONCLUSION (of first part)

The first part of this paper has convincingly (my wish anyway) demonstrated that Ezek 4-5 was symbolically taking place in the Temple.

Should we be surprised that the very first verse of Ezekiel (Ezek 1:1) ties in the prophet's 'personal calling' to the exact year that the 1st Temple was cleansed by King Josiah (following the 40-year desecration of King Manasseh)?

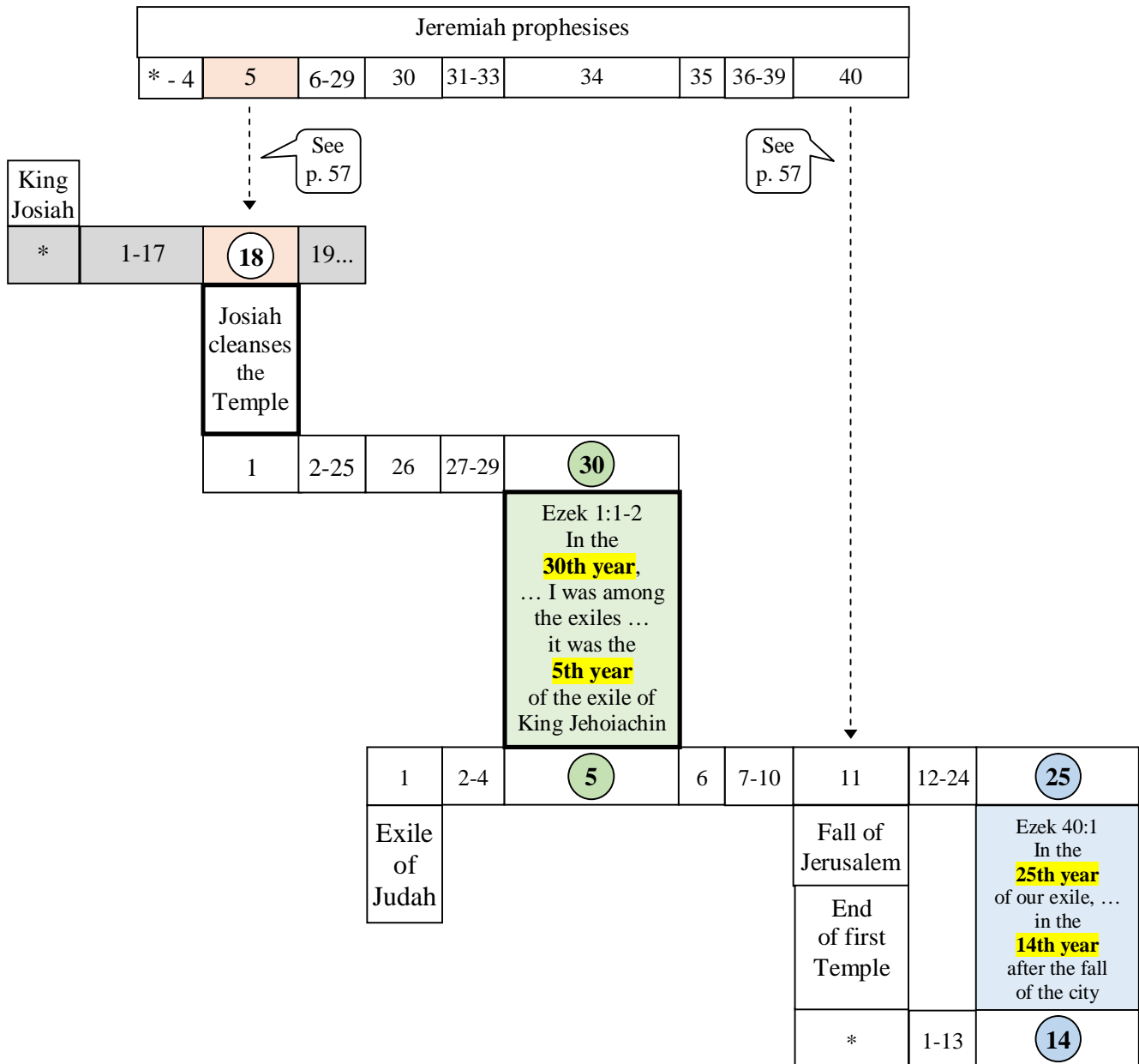

Second part

➔ Setting a true chronology of the Bible

I believe, like many other who study the Bible's chronology, that God has allowed humankind to evolve according to a 7,000-year Master Plan. In all likelihood this **Master Plan** is mirrored in the creation week. If this interpretation is right, we haven't reached year 6,000 AM yet, otherwise we would now be living during the millennial rest, which is not the case.. In the following pages I am going to associate a 'date' to each important event of the Bible, this will bring the discovery of some stunning patterns never exposed until now.

Creation week	Day 1	=	2,000 years	No Torah	Talmudic Tradition The Jews abandoned this view and failed to recognize Yeshua as the Messiah they were expecting
	Day 2	=	2,000 years	Torah	
	Day 3	=	2,000 years	Mes-sianic	
	Day 4	=	2,000 years	Millen-nial rest	
	Day 5	=	2,000 years		
	Day 6	=	2,000 years		
	Day 7	=	1,000 years		

The AM mode of dating

This chronology uses the AM mode of dating instead of our more familiar Gregorian calendar. In the **AM** system (**Anno Mundi**) year '0' coincides with the creation of the world and the new year's day occurs around the time of each new spring equinox. (See Ex 12:1-3).

Using Abraham year of birth '2008 AM' (see Appendix A on page 220) as a starting point you can figure out the date of each event displayed on the left side of the next figure. This is done by going backward or forward a specific number of years (obtained from the Bible) from a known date (2008 AM). This process consolidates a new date at each step.

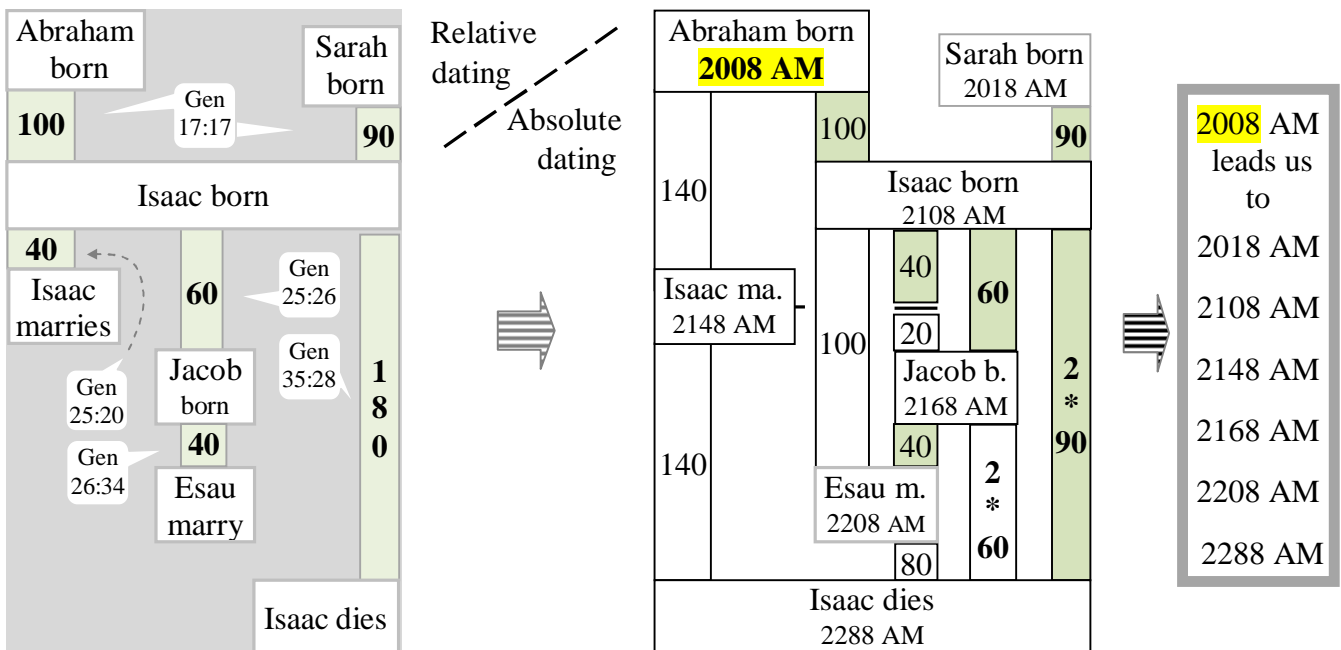

This method was used to revisit every figure previously displayed in this work. As expected, this unlocked the date of every event of the Bible. See Appendix E on page 254)

→ The timeline of Joseph

For an easier understanding follow the path in the numerical order. 1,2,3,..., 25 ★

Stepping stones path	Operation	Reference
1		Appendix A
3	2108 - 90	Gen 17:17
4	2008 + 85	See page 79
2	2008 + 100	Gen 17:17
6	2018 + 127	Gen 23:1
7	2108 + 40	Gen 25:20
8	2108 + 60	Gen 25:26
9	2008 + 175	Gen 25:7
21	2265 - 20	Gen 31:41
22	2245 + 7	Gen 29:20
23	2252 + 1	Gen 29:31-32
16	2288 - 30	Gen 41:46
19	2258 + 1	Gen 30:25
20	2259 + 6	Gen 31:41
24		Next pages
17	2258 + 17	Gen 37:2
15	2288 - 2	Gen 41:1
14	2108 + 180 2289 - 1	Gen 35:28 Gen 41:25
13	2296 - 7	Gen 41:53
12	2298 - 2	Gen 45:6
11	2168 + 130 2315 - 17	Gen 49:9 Gen 47:28
10	2168 + 147	Gen 47:28
18	2258 + 110	Gen 50:26
25	2523 + 40 – 123 From end of Exodus	Num 33:38
5	2093 + 430	Ex 12:40

Years	Event
2008 AM	Abram born
2018 AM	Sarah born
2093 AM	Covenant between the parts
2108 AM	Isaac born
2145 AM	Saraï dies
2148 AM	Isaac marries
2168 AM	Jacob/Esau born
2183 AM	Abraham dies
2245 AM	Jacob hired by Laban
2252 AM	Jacob marries
2253 AM	Reuben born
2258 AM	Joseph born
2259 AM	Jacob completes 14 years of work for Laban
2265 AM	Jacob leaves Laban
2268 AM	Benjamin born
2275 AM	Joseph in Egypt
2286 AM	Joseph helps the baker
2288 AM	Isaac dies/ Joseph meets Pharaoh
2289 AM	Start of 7 years of plenty
2296 AM	Start of 7 years of famine
2298 AM	Jacob meets Pharaoh
2315 AM	Jacob dies
2368 AM	Joseph dies
2440 AM	Aaron born
2523 AM	Exodus

There is nothing in the Bible to pinpoint the exact date of the following four events:

- Benjamin born
- Joseph sent to prison
- Manasseh birth
- Ephraim birth

Benjamin was born some years after Jacob left Laban in 2265 AM and before Joseph was sold and sent to Egypt in 2275 AM. See Gen 34-35.

In Gen 39 we learn that Joseph became the intendant of Potiphar in Egypt. No doubt it took many years before Potiphar would entrust everything he owned in the hands of Joseph. Therefore we can rightly deduce that Joseph was sent to prison (by Potiphar) at least several years after his arrival in Egypt.

From Gen 41:50 we learn that Manasseh and Ephraim were born during the 7 years of plenty.

In the following pages we will see why, in all likelihood, these 4 events can be con-nected to the following dates

Benjamin born	2268 AM
Joseph sent to prison	2285 AM
Manasseh birth	2291 AM
Ephraim birth	2295 AM

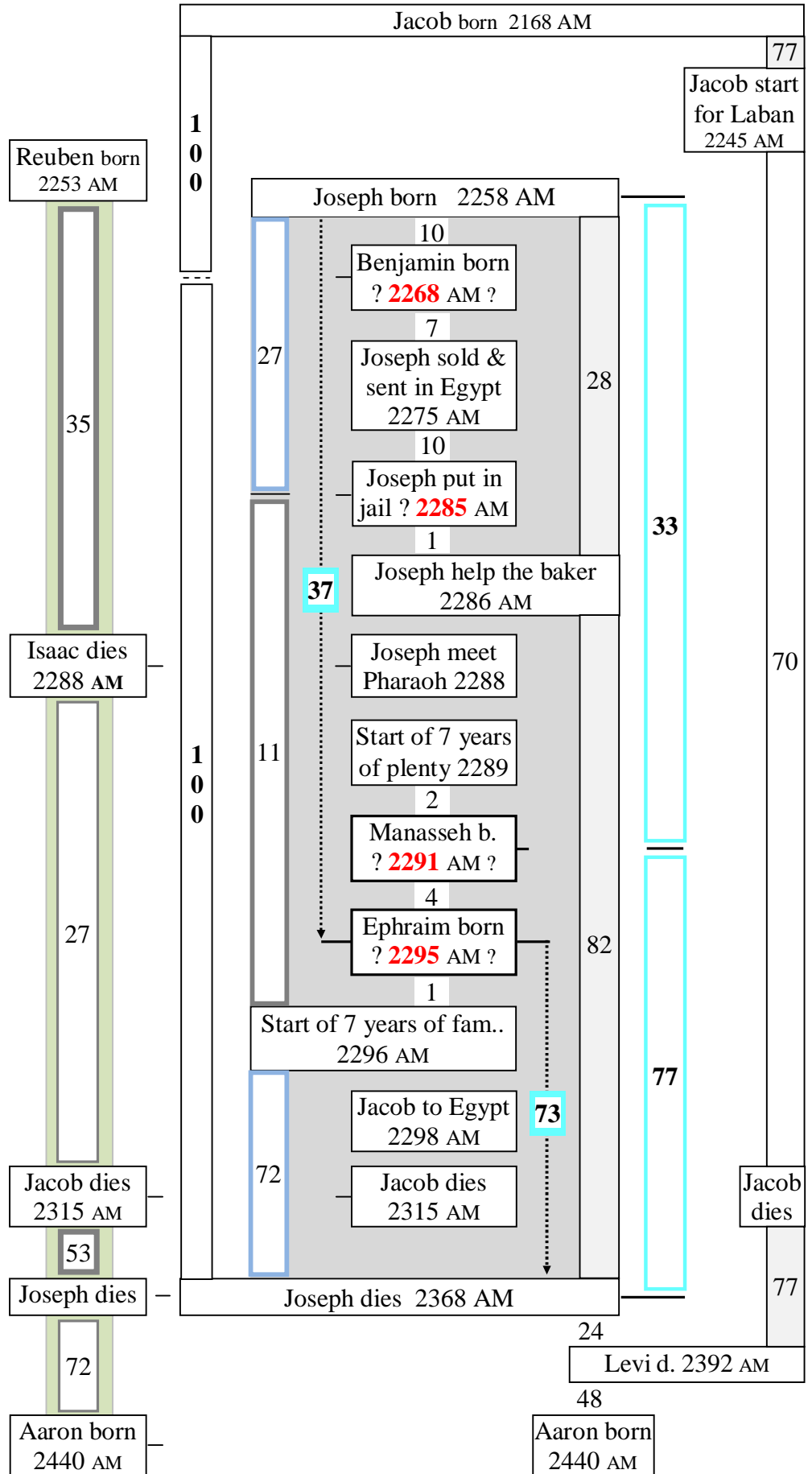

Rachel's sons

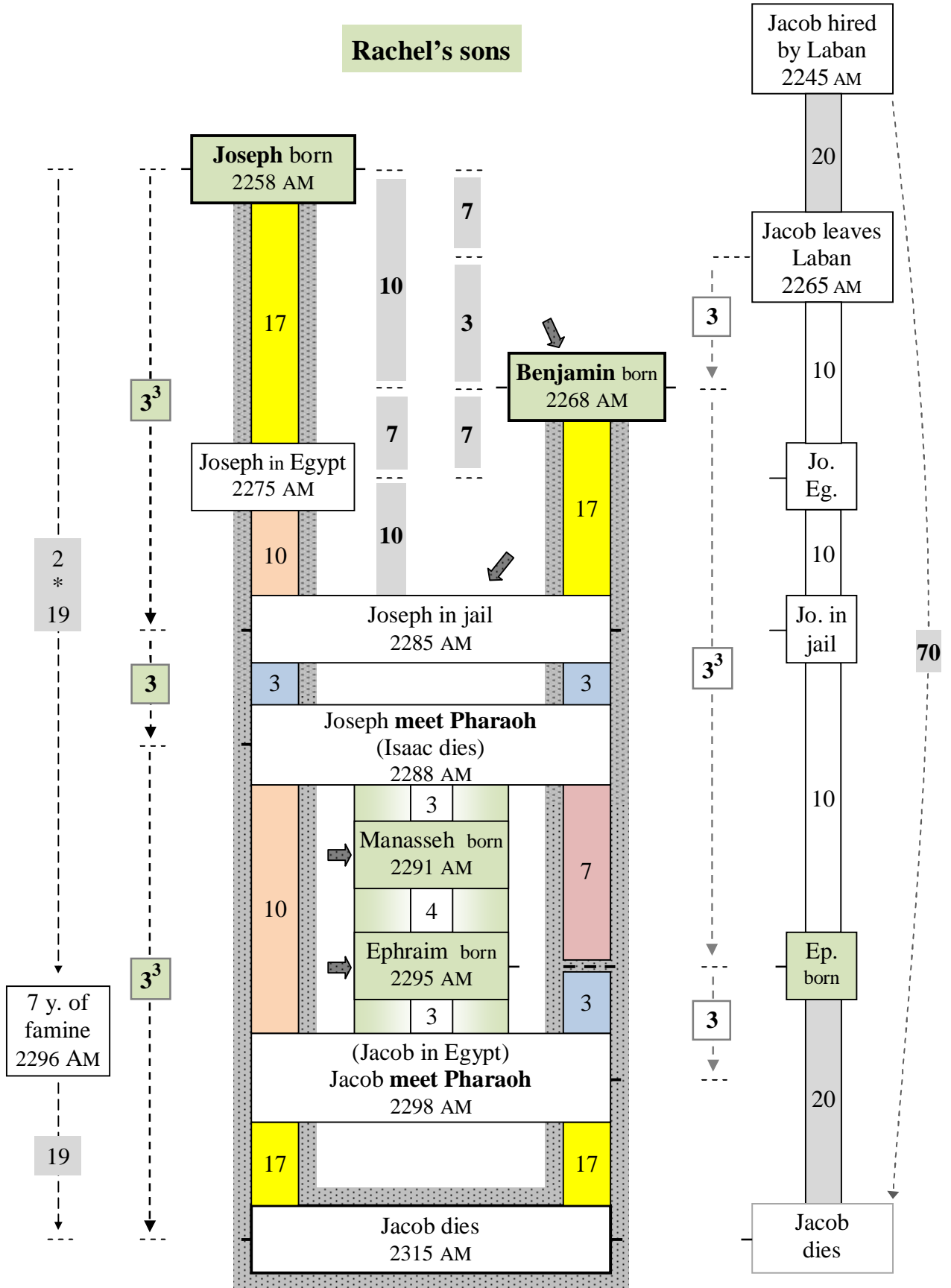

Sarai dies
2145 AM

03 A

Isaac marries 2148 AM

60 B

Esau marries
2208 AM

44 C

Jacob marries
2252 AM

06 B'

35 A

Abra..
dies 2183

62 B

Laban
hires Ja.
2245

13 C

Palindromes & Symmetry

83

Ishmael
dies
2231

27

Joseph born 2258 AM

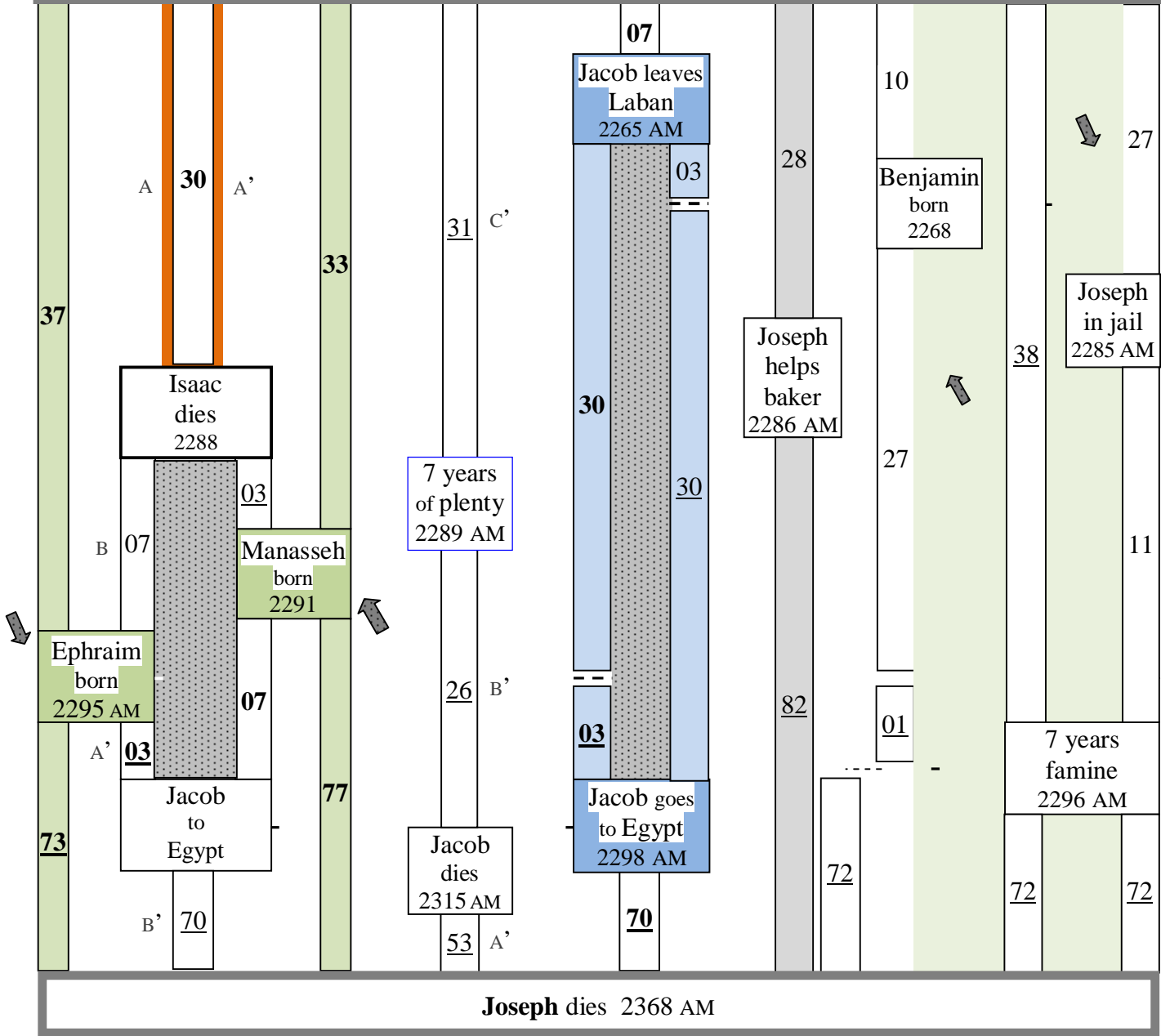

→ Was first year of Yeshua's ministry (3989 AM) a jubilee year?

To answer this question we first need to examine how the sabbatical cycle is integrated in the chronology.

After the Israelites came to the Promised Land (2563 AM) they went to war against all the kings of the land to conquer their territories. It took six years (see Land divided on page 19) before Joshua could divide the land between the tribes. This was done in year 2569 AM (2563 + 6) and in that year the Israelites started farming their new land. As we should know, the primary benefit of the sabbatical cycle⁹⁵ was to allow the land to rest for one year in every 7 years, therefore it is only logical to have the first sabbatical cycle to coincide with the time that the land was exploited for the first time (2569 AM) by the Israelites.

'Conquest of the land' under the command of Joshua						First sabbatical cycle						
						Land divided						First sabbatical year
2563 AM	25 64	25 65	25 66	25 67	25 68	2569 AM	2570 AM	2571 AM	2572 AM	2573 AM	2574 AM	2575 AM
Promised land						1 st year	2 nd	3 rd	4 th	5 th	6 th	7 th

So the first sabbatical year was 2575 AM and up to the time of Daniel's death a new one was observed every 7 years. Having God's 7,000 years Master Plan in mind, it is interesting to note that if we count the number of sabbatical cycles that was originally intended, that is to say if they hadn't been interrupted at Daniel's death in 2953 AM, we obtain a total of exactly 490 (or 7 * 70) sabbatical years before the start of the 7th millennium.

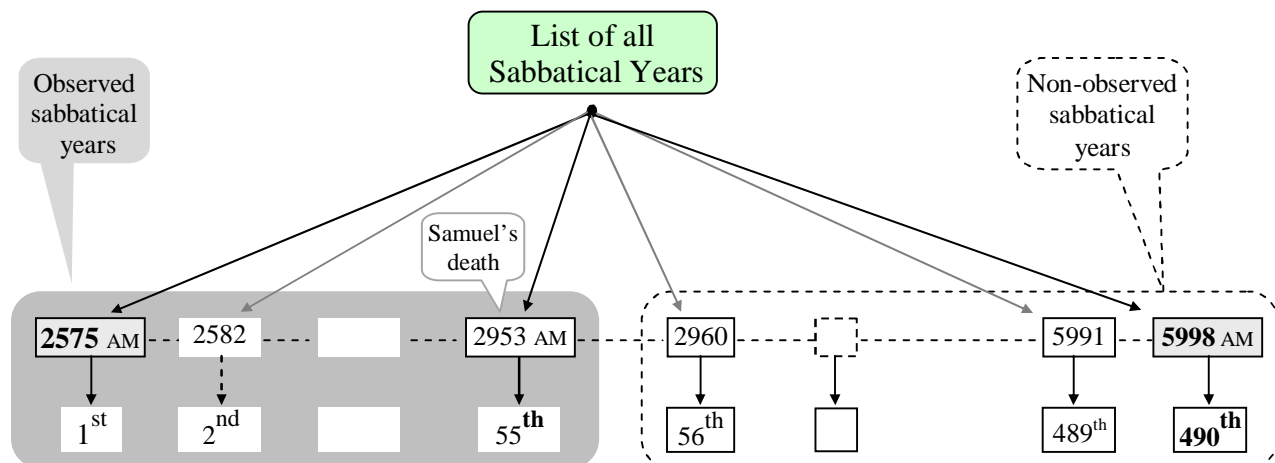

At the time they started counting for the first sabbatical cycle the Israelites also began counting for the occurrence of a jubilee year⁹⁶.

⁹⁵ Ex 23:10-11 "Six years you shall sow your land and gather in its produce, 11 but the seventh year you shall let it rest NKJV

⁹⁶ This is the most logical time to start counting the Jubilee years. Both concepts are closely related.

The JUBILEE

Lev 25:8-10 And you shall count seven Sabbaths of years for yourself, seven times seven years; and the time of the seven Sabbaths of years shall be to you forty-nine years. Then you shall cause the trumpet of the Jubilee to sound on the tenth day of the seventh month; on the Day of Atonement you shall make the trumpet to sound throughout all your land. And you shall consecrate the fiftieth year,

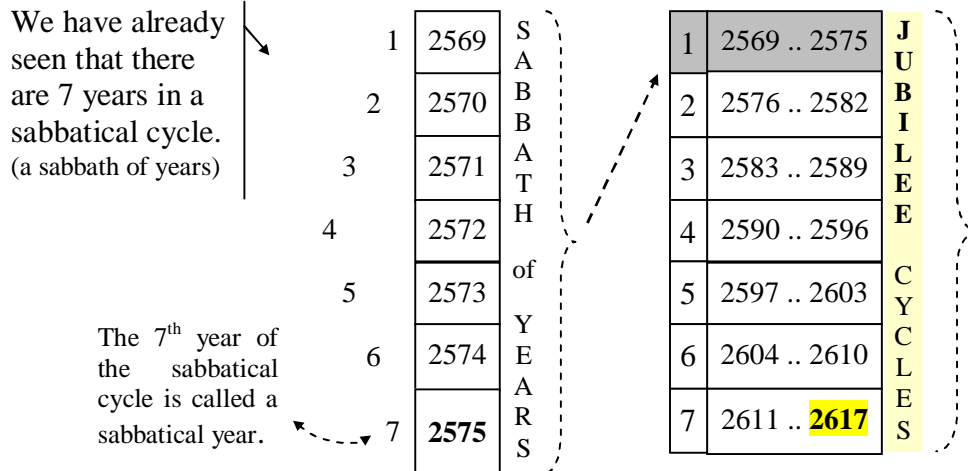

Layout of the very first jubilee cycle												
Sab. Cy.. #1	Sab. Cy.. #2		Sab. Cy.. #3		Sab. Cy.. #4		Sab. Cy.. #5		Sab. Cy.. #6		Sab. Cy.. #7	
Y1 2569 AM	Y8 2576	Y15 2583	Y22 2590	Y29 2597	Y36 2604	Y43 2611						
Y2 2570	Y9 2577	Y16 2584	Y23 2591	Y30 2598	Y37 2605	Y44 2612						
Y3 2571	Y10 2578	Y17 2585	Y24 2592	Y31 2599	Y38 2606	Y45 2613						
Y4 2572	Y11 2579	Y18 2586	Y25 2593	Y32 2600	Y39 2607	Y46 2614						
Y5 2573	Y12 2580	Y19 2587	Y26 2594	Y33 2601	Y40 2608	Y47 2615						
Y6 2574	Y13 2581	Y20 2588	Y27 2595	Y34 2602	Y41 2609	Y48 2616						
Y7 2575	Y14 2582	Y21 2589	Y28 2596	Y35 2603	Y42 2610	Y49 2617						

When do we start the Jubilee year?

On the 10th day of the 7th month of the 49th year of the Jubilee cycle (Lev 25:8-10), the jubilee year would be consecrated. It means that the Jubilee year doesn't start at the very beginning of the 49th years of the Jubilee cycle. The 'jubilee year' starts only when the 7th month of the 49th year of the jubilee cycle is reached and ended on the 7th month of the next year (which is part of the next jubilee cycle).

First Jubilee							Second Jubilee					Third Jubilee		
2569	2570	2571	-	2615	2616	2617	2618	2619	-	2665	2666	2667	2668	-
1	2	3	-	47	48	49	1	2	-	48	49	1	2	-

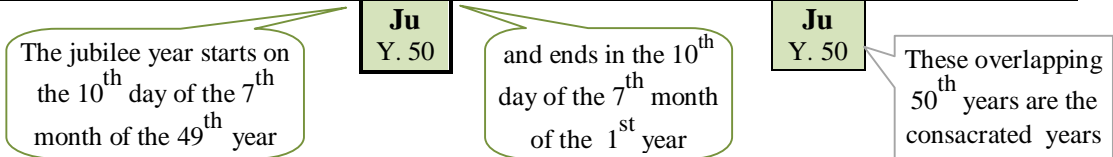

--- 69 th Ju.			70 th Jubilee					
-	5948	5949	5950	5951	-	5997	5998	5999
-	48	49	1	2	-	48	49	
			Ju Y. 50				Ju Y. 50	

7th
Millen
-nium

The Jubilee year is also known as the **YOVEL** year. The name comes from the fact that on Yom Kippur of the fiftieth year, a yovel (ram's horn) is blown throughout the land to dedica-
this new jubilee year.



List of the 70 **J**ubilee years that will occur up to the Day of the Lord

Ju 1	2617- 2618	Ju 15	3303- 3304	Ju 29	3989- 3990	Ju 43	4675- 4676	Ju 57	5361- 5362
Ju 2	2666- 2667	Ju 16	3352- 3353	Ju 30	4038- 4039	Ju 44	4724- 4725	Ju 58	5410- 5411
Ju 3	2715- 2716	Ju 17	3401- 3402	Ju 31	4087- 4088	Ju 45	4773- 4774	Ju 59	5459- 5460
Ju 4	2764- 2765	Ju 18	3450- 3451	Ju 32	4136- 4137	Ju 46	4822- 4823	Ju 60	5508- 5509
Ju 5	2813- 2814	Ju 19	3499- 3500	Ju 33	4185- 4186	Ju 47	4871- 4872	Ju 61	5557- 5558
Ju 6	2862- 2863	Ju 20	3548- 3549	Ju 34	4234- 4235	Ju 48	4920- 4921	Ju 62	5606- 5607
Ju 7	2911- 2912	Ju 21	3597- 3598	Ju 35	4283- 4284	Ju 49	4969- 4970	Ju 63	5655- 5656
Ju 8	2960- 2961	Ju 22	3646- 3647	Ju 36	4332- 4333	Ju 50	5018- 5019	Ju 64	5704- 5705
Ju 9	3009- 3010	Ju 23	3695- 3696	Ju 37	4381- 4382	Ju 51	5067- 5068	Ju 65	5753- 5754
Ju 10	3058- 3059	Ju 24	3744- 3745	Ju 38	4430- 4431	Ju 52	5116- 5117	Ju 66	5802- 5803
Ju 11	3107- 3108	Ju 25	3793- 3794	Ju 39	4479- 4480	Ju 53	5165- 5166	Ju 67	5851- 5852
Ju 12	3156- 3157	Ju 26	3842- 3843	Ju 40	4528- 4529	Ju 54	5214- 5215	Ju 68	5900- 5901
Ju 13	3205- 3206	Ju 27	3891- 3892	Ju 41	4577- 4578	Ju 55	5263- 5264	Ju 69	5949- 5950
Ju 14	3254- 3255	Ju 28	3940- 3941	Ju 42	4626- 4627	Ju 56	5312- 5313	Ju 70	5998- 5999

NOTICE: Yeshua died in 3993 AM at age 33 (born in 3960 AM), therefore he was 29 years old when he announced the 29th jubilee in the 7th month of 3989 AM. See next few pages for a convincing proof that Yeshua's ministry lasted 4 years.

→ Did Yeshua's ministry last 4 years?

In the absence of any explicit Bible's references to confirm a 4-year ministry we could try to build a limited timeline that would include each action performed by Yeshua and his apostles and see how things add up. However, it is quite possible that this information has already been supplied but in a symbolic way. Here are **7 points** directly and indirectly related to Yeshua in which the number '4' is linked to a notion of 'duration'.

1st clue 4 days in the Temple

At age 12 Yeshua spent 4 days in the Temple:

- Luke 2:44 Thinking he was in their company, they traveled on for a day.
- Luke 2:46 After three days they found him in the temple courts

The 4 days in the Temple could mirror a future 4-year ministry.

2nd clue wait four years for the fruit

- Luke 13:6-9 "A man had a fig tree, planted in his vineyard, and he went to look for fruit on it, but did not find any. So he said to the man who took care of the vineyard, **'For three years** now I've been coming to look for fruit on this fig tree and haven't found any. Cut it down! Why should it use up the soil?' "'Sir,' the man replied, 'leave it alone **for one more year**, and I'll dig around it and fertilize it. If it bears fruit next year, fine! If not, then cut it down.'"

The man who took care of the vineyard was allowed a total of 4 years. Wasn't Yeshua taking care of Israel during his ministry? Could he have been given a fourth year too?

3rd clue Passover lamb chosen 4 days before

Yeshua's crucifixion can be equated to the killing of the Passover lamb.

Yeshua was described as a lamb:

- John 1:29 The next day John saw Jesus coming toward him, and said, "Behold! The Lamb of God who takes away the sin of the world! NKJV
- Isa 53:7 He was oppressed and He was afflicted, Yet He opened not His mouth; He was led as a lamb to the slaughter, And as a sheep before its shearers is silent, So He opened not His mouth. NKJV

The Passover lamb had to be without a fault:

- Ex 12:5 Your lamb shall be without blemish NKJV

Yeshua was also without a fault:

- Luke 23:4 So Pilate said to the chief priests and the crowd, "I find no fault in this Man." NKJV

- 1 Peter 1:19 but with the precious blood of Christ, as of a lamb without blemish and without spot. NKJV
- 2 Cor 5:21 For He made Him who knew no sin to be sin for us, NKJV
- John 8:46 Which of you convicts Me of sin? And if I tell the truth, why do you not believe Me? NKJV

The Passover lamb was **chosen** 4 days before being killed:

- Ex 12:3 'On the tenth day of this month every man shall take for himself a lamb,
- Ex 12:6 Now you shall keep it until the fourteenth day of the same month. Then the whole assembly of the congregation of Israel shall kill it at twilight. NKJV

Could a four-year ministry parallel the last four days of the Passover lamb?

If Yeshua's ministry lasted four years, it would perfectly match the four days during which the blemishless lamb had been known and expressly kept to become the Passover lamb.

4th clue

Timing of the of the jubilee year

At the beginning of his ministry, Yeshua

- was baptized
- spent 40 days in the desert
- spent some time teaching in the various synagogues around.

And then Yeshua announced the jubilee:

- Luke 4:18-21 "The Spirit of the Lord is on me, because he has anointed me to preach good news to the poor. He has sent me to proclaim freedom for the prisoners and recovery of sight for the blind, to release the oppressed, to proclaim the year of the Lord's favor." Then he rolled up the scroll, gave it back to the attendant and sat down. The eyes of everyone in the synagogue were fastened on him, and he began by saying to them, "**Today** this scripture is fulfilled in your hearing."

The text that Yeshua read in the synagogue was a description of **a jubilee year** and at the end of his reading, he told everybody **that what he had just read was happening on that very day**. We even know the date of that day:

- Lev 25:9-10 Then have the trumpet sounded everywhere on the tenth day of the seventh month; on the Day of Atonement sound the trumpet throughout your land. Consecrate the fiftieth year and proclaim liberty throughout the land to all its inhabitants.

At no other time would it have been more appropriate to announce a jubilee than at the start of a ministry that would bring the same kind of relief as was expected during a jubilee year. See the following report that was transmitted to John the Baptist later on:

- Matt 11:4-6 Jesus answered and said to them, "Go and tell John the things which you hear and see: The blind see and the lame walk; the lepers are cleansed and the deaf hear; the dead are raised up and the poor have the gospel preached to them. NKJV

According to the timeline given in Appendix E on page 254, Yeshua died in 3993 AM. If the ministry lasted four years, as we are trying to demonstrate, it had to start at 3989 AM. Was 3989 AM a jubilee year? Absolutely. See list of jubilee years on page 148.

There was a jubilee year starting in the 7th month of 3989 AM.

3989 AM			3990 AM		
M1	M7D10	M12 13	M1	M7D10	M12 13
49 th year of a 49-year cycle			First year of the next 49-year cycle		
<div style="border: 1px dashed black; padding: 5px; background-color: #e0e0e0; display: inline-block;"> Jubilee year #29 It is also called the fiftieth year in Lev 25:8-10 </div>					

It is quite possible that, contrary to the popular belief, the very start of Yeshua's ministry coincides with the proclamation of the Jubilee year.

M = month
D = day

We saw earlier that a jubilee starts in the 7th month of the 7th year of the 7th sabbatical cycle and terminates in the 7th month of the first year of the next cycle. (See page 148)

5th clue Four months before the harvest

- John 4:35 Do you not say, '**Four months more and then the harvest**'? I tell you, open your eyes and look at the fields! **They are ripe for harvest.**

A careful review of John indicates that the timing of John 4:35 could be a few weeks after the first Passover of Yeshua's ministry which was held in the first month (M1) of **3990 AM**:

- John 2:13 When it was almost time for the Jewish Passover, Jesus went up to Jerusalem.

There were four Passovers (**P1, P2, P3, P4**) during Yeshua's ministry (if it lasted 4 years as assumed by the author).

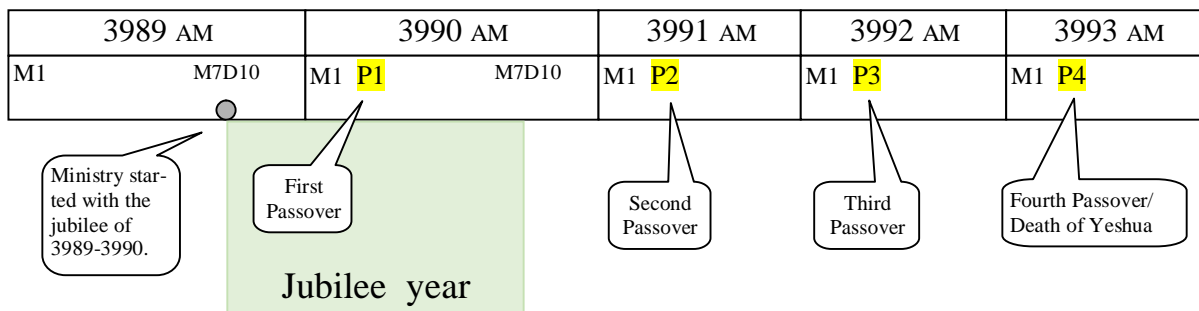

In John 4:35-38 Yeshua is telling his disciples that the fields are ready to be harvested (spring harvest) but people say “**four months more and then the harvest**”.

Why would the people wait 4 months if those fields were ready to be harvested? Why would it be a saying? Four months after the spring brings us into the fall, the fact that it was a saying could only mean that those circumstances had been encountered in the past and they would happen again in the future.

There is only one possible explanation here. At the time Yeshua was talking, during the spring of 3990 AM, there was still 4 months to wait for the end of the current jubilee year and this is why the people were not harvesting even though the crop was ready. (It would have been unlawful to do so.)

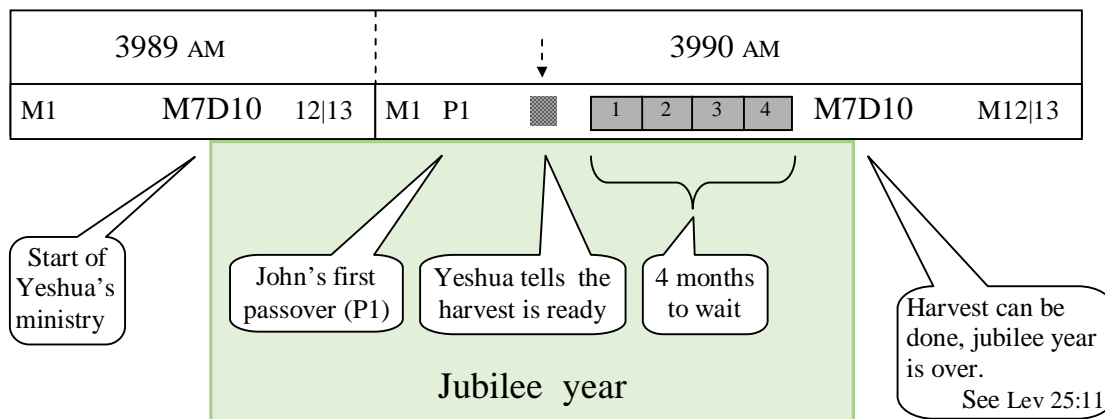

6th clue Queen Esther wait four days before going to the king uninvited

There are strong similarities between Yeshua’s ministry and what can be seen to some extent as Queen Esther’s 4-day plan.

Here I specifically point to the 4-day period during which Queen Ester held a three days’ fast with all the Jews of Susa and then presented herself, uninvited, to the King and ended-up (on the fourth day during her second banquet) pleading for her own safety. Note that by imploring the king to save the only life he cared for, the life of his queen, Esther brilliantly fought for the fate of all the Jews.

Queen Esther

4-day ministry

Est 4:16 Go, gather all the Jews who are present in Shushan, and fast for me; neither eat nor drink for **three days**, night or day.

Est 5:2 So it was, when the king saw Queen Esther standing in the court, that she found favor in his sight, and the king held out to Esther the golden scepter that was in his hand.

Est 5:8 then let the king and Haman come to the banquet which I will prepare for them, and **tomorrow** I will do as the king has said."

Est 7:2 And on the second day, at the banquet of wine, the king again said to Esther, "What is your petition, Queen Esther?"

Est 7:3 O king, and if it pleases the king, let my life be given me at my petition, and my people at my request.

The last 4 years of Absalom are a TYPE of Yeshua's ministry

In the case of Absalom the four years started when he received the authorization from his father (King David) to leave his own house in Jerusalem and circulate in the city:

- 2 Sam 14:33 Then the king summoned Absalom, and he came in and bowed down with his face to the ground before the king. And the king kissed Absalom. NIV

And it ended when Absalom tried to usurp the crown and replace his father on the throne:

- 2 Sam 15:7 At the end of four years, Absalom said to the king, NIV

Here are 7 points showing that a parallel can be established between Absalom and Yeshua.

- ▶ P1 ◀ The last 4 years in each man's life started with freedom.
Absalom: At first Absalom was confined⁹⁷ to his own house and was not allowed to see his father: See 2 Sam 14:24
Then he recovered his freedom and was allowed to see his father during the last 4 years of his life. See 2 Sam 15:7
Yeshua: At the start of his 4 year ministry Yeshua **declared a jubilee year** (freedom) : See Luke 4:16-18
- ▶ P2 ◀ Each man had an opposite way to resolve conflicts.
Absalom was seeking justice: See 2 Sam 15:4
Yeshua was promoting 'forgiveness' See Luke 6:37
- ▶ P3 ◀ The king's son and God's son were both impaled **by the spear of a soldier** while hanging **on a tree**.
Absalom was impaled (2 Sam 18:14) by Joab (a soldier 1 Chron 27:34)
Yeshua was impaled by a soldier. See John 19:34
Note: Author's belief: Yeshua was crucified on a tree.
- ▶ P4 ◀ The king's son and God's son died with a crown on the head.
Absalom See 2 Sam 18:9
Yeshua See Matt 27:29
- ▶ P5 ◀ Each man's death was followed by a loud sound.
Absalom See 2 Sam 18:16
Yeshua See Mark 15:38-39, Matt 27:51
- ▶ P6 ◀ The king's son and God's son were buried beneath a rock.
Absalom See 2 Sam 18:17
Yeshua See Matt 27:59-60
- ▶ P7 ◀ Following each death the people hurried home.
After Absalom's death See 2 Sam 18:17
After Yeshua's death See Luke 23:54,56

⁹⁷ The fact that Absalom was confined to his own house is not in doubt. It was in response to a specific order [let him return to his own house] from the king. Also notice that Absalom sent his servant twice to ask Joab to come to see him. Why didn't Absalom go to see Joab himself given that they were close neighbors:

2 Sam 14:29 And when he sent again the second time, he would not come. NKJV

2 Sam 14:30 So he said to his servants, "See, Joab's field is near mine, NKJV

And how can we explain that Absalom would have been better if he had stayed in Geshur unless he was free to move around in Geshur:

2 Sam 14:32 "Why have I come from Geshur? It would be better for me to be there still." NKJV

Can there be any doubts left?

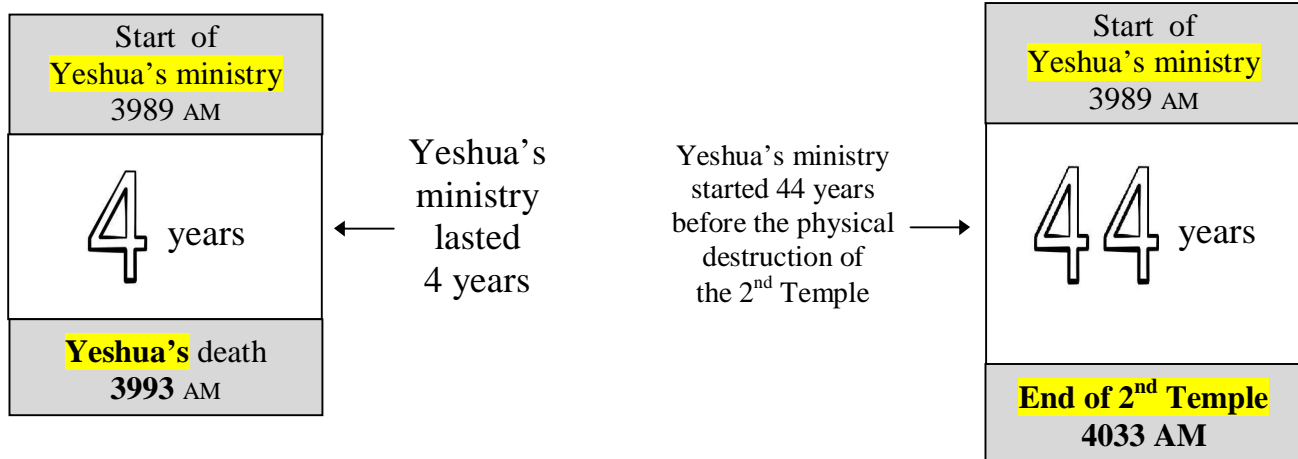

	Year	Yeshua's ministry started in the 7 th month of 3389 AM and ended in the 1 st month of 3993 AM. The ministry lasted exactly 44 months.				# of months	Total # of months
M I N I S T R Y	3989 AM	M1-	M2-	M3-	M4-	6	44 Months
		M5-	M6-	M7-Thisri	M8-Mach..		
		M9-Kislev	M10-Tevet	M11-Shevath	M12-Adar I		
		M13-Adar2					
	3990 AM	M1-Nissan	M2-Lyar	M3-Sivan	M4-Tammuz	12	
		M5-Mena	M6-Elul	M7-Thisri	M8-Mach..		
		M9-Kislev	M10-Tevet	M11-Shevath	M12-Adar I		
	3991 AM	M1-Nissan	M2-Lyar	M3-Sivan	M4-Tammuz	13	
		M5-Mena	M6-Elul	M7-Thisri	M8-Mach..		
		M9-Kislev	M10-Tevet	M11-Shevath	M12-Adar I		
		M13-Adar2					
	3992 AM	M1-Nissan	M2-Lyar	M3-Sivan	M4-Tammuz	12	
		M5-Mena	M6-Elul	M7-Thisri	M8-Mach..		
M9-Kislev		M10-Tevet	M11-Shevath	M12-Adar I			
3993 AM	M1-Nissan				1		



Ex 12:3 on the tenth day of this month each man is to take a lamb for his family

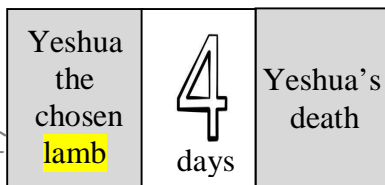

Yeshua's birth

40 God sent Jonah to Nineveh (Jo 1:2) to proclaim that the city would be overturned in **40 days**. The people repented and the city was saved. Yeshua was sent to Jerusalem to proclaim the kingdom of God, nobody repented and they killed Him. The city was destroyed **40 years** later. If only the people had remembered the message of Jonah they could have

(Neh 12:31-39) At the dedication of the wall, two choirs of people walk the top of the wall in opposite directions and meet again.

Jerusalem's wall symbolically divided in two

Neh 12:43 And on that day The **sound of rejoicing** in Jerusalem could be heard far away.

Opposition to the wall's repairs

Neh 6:9 They were all trying to frighten us, thinking, "Their hands will get too weak for the work, and it will not be completed."



Opposition to the son's work

Mark 12:10 "The stone the builders rejected has become the capstone;

Matt 27:54 When the centurion and those with him who were guarding Jesus saw the earthquake and all that had happened, **they were terrified,**

Temple's veil is divided in two

Mark 15:38 The curtain of the temple was torn in two from top to bottom.

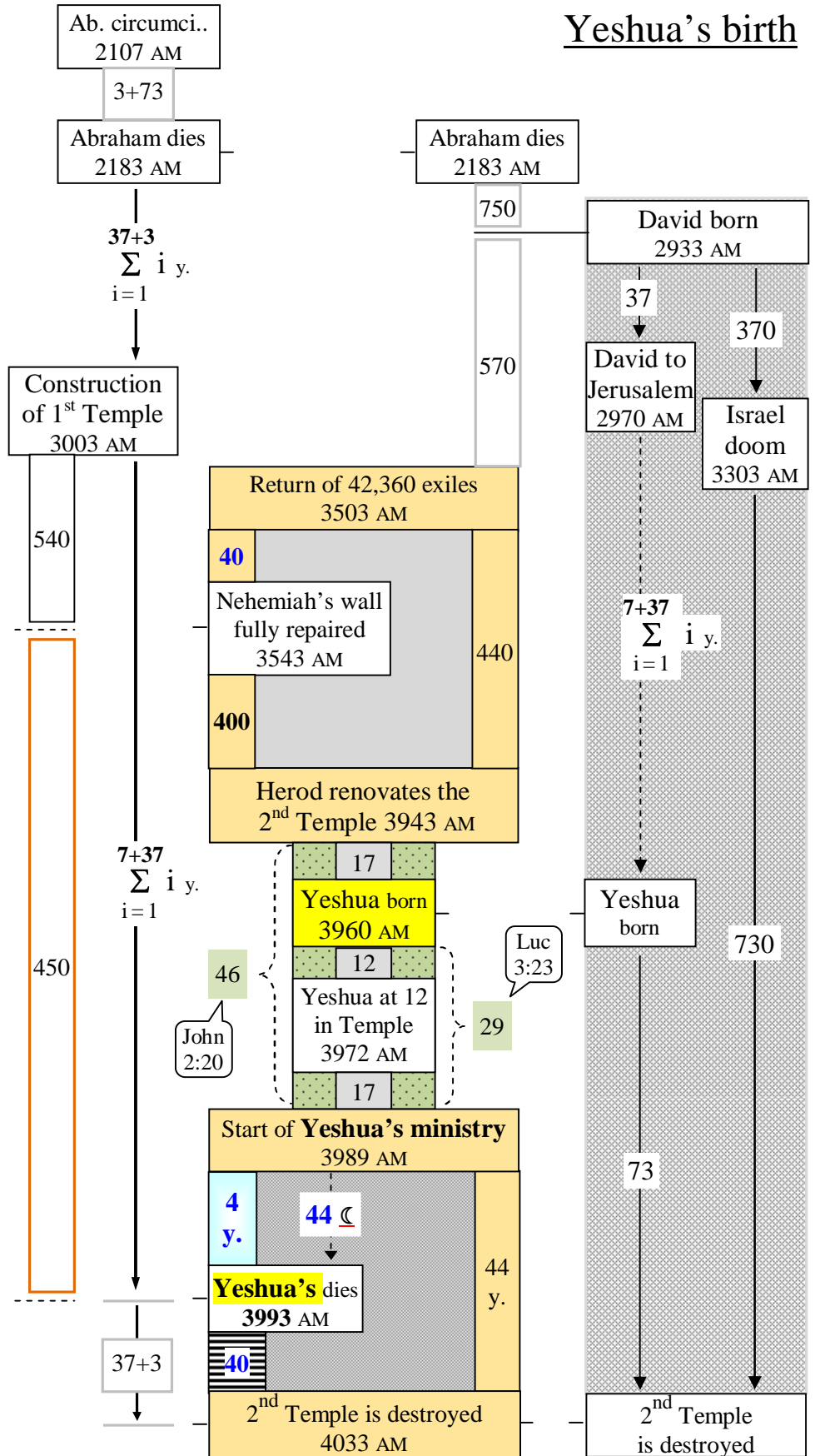

... saved Jerusalem. **Matt 12:39 "A wicked and adulterous generation asks for a miraculous sign! But none will be given it except the sign of the prophet Jonah.** Ref Jerren Lewis "Evidence, Jesus is the Messiah"

Did the second Temple lose its “raison d’être” when Yeshua died? Yes

Yeshua associated his death with the end of something.

- John 19:30 Jesus said, "It is finished." With that, he bowed his head and gave up his spirit.
- Matt 27:51 At that moment the curtain of the temple was torn in two from top to bottom. The earth shook and the rocks split.

What was finished? Right after Yeshua’s death comes the tearing of the Temple’s veil. The ‘outer’ veil marked the separation between God and humanity (only priests were allowed inside the Temple). We have here a powerful symbol informing us of a change: There would be no more need for a Temple. Worshipping would be done in spirit without any obligation to bring sacrifices at a special location.

John 4:21 Jesus declared, "Believe me, woman, a time is coming when you will worship the Father neither on this mountain nor in Jerusalem

Contrary to the popular belief, it was not the inner veil but the **outer curtain** of the Temple that was torn in two. Here is why. The soldier standing at the site of the crucifixion (Luke 23:47) witnessed the tearing. (It would have been impossible for him to see the Temple inner curtain from an outside point of view. Also, according to Josephus's work ‘The Jewish war’ the motif on the outer curtain represented a depiction of the Heaven. This last detail has a great importance when associated to the following: At his baptism (beginning of Yeshua’s ministry) the heaven was torn in two (Mark 1:10) and at his death a Temple’s curtain⁹⁸ was torn in two (Marc 15:38).

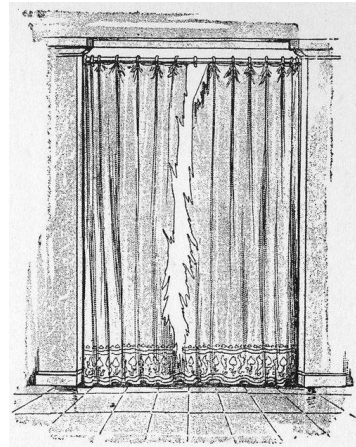

The Jewish Talmud says that 40 years before the Temple was destroyed the gates of the temple opened by themselves, until Rabbi Yohanan B. Zakkai rebuked them (i.e., the gates) saying, "Hekel, Hekel, why do you alarm us? We know that you are destined to be destroyed" (Yoma 39b).

Zech 11:1 Open your doors, O Lebanon, so that fire may devour your cedars!

This happened every day for 40 years

Josephus - Moreover, the eastern gate of the inner, [court of the temple,] which was of brass, and vastly heavy, and had been with difficulty shut by twenty men, and rested upon a basis armed with iron, and had bolts fastened very deep into the firm floor, which was there made of one entire stone, was seen to be opened of its own accord about the sixth hour of the night. (Josephus, *The Wars of the Jews*, IV: iv, 3)

Knowing that the tearing of the veil and the opening of the gates symbolize the same fact: the Temple had become **redundant**, we can conclude that the ‘**40 years**’ supplied by the Talmud represents the period between the death of Yeshua and the physical destruction of the second Temple⁹⁹.

⁹⁸ We have here a bracket around Yeshua’s ministry but it fully works only if the curtain being torn from top to bottom was the ‘outer’ one, i.e. the one picturing the Heaven. See The heavenly veil torn: Mark’s cosmic "inclusio" by David Ulansey

⁹⁹ the second Temple was burned down by the soldiers of Titus, the son of Emperor Vespasian

→ Where does Joshua fit into this chronology?

Acts 13:17-20 The God of the people of Israel **chose our fathers** he made the people prosper during their stay in Egypt, ... he overthrew seven nations in Canaan and gave their land to his people as their inheritance. All this took about 450 years. **"After** this, God gave them judges until the time of Samuel

Here we are told that there was a 450 years span (the origin has to be associated with a specific event) when God chose¹⁰⁰ our fathers (plural form). At the end of the 450 years an inheritance of land was received. Note: **the 'Judge's period came after the 450 years.**

We already know that God established a covenant (involving possession of 'land') with our "fathers" Abraham (Gen 12:2), Isaac (Gen 21:12) and Jacob (Gen 28:14). However one of them didn't have to go through a trial with God during his life. Jacob's destiny was settled even before he was born:

- Gen 25:23 ... Two peoples shall be separated from your body; One people [Jacob] shall be stronger than the other [Esau], And the older shall serve the younger." NKJV

Was there an event in the life of Abraham and Isaac during which they could have been chosen together? Yes and that event has to be **Akedah** (the sacrifice of Isaac) that took place in 2123 AM.

Abraham didn't hesitate:

Gen 22:16-18 and said, "I swear by myself, declares the LORD, that because you have done this and have not withheld your son, your only son, I will surely bless you

The full consent of Isaac was mandatory. Abraham was 115 years old and Isaac could have found an opportunity to run away but he didn't. On the contrary, he walked by himself to the altar:

Gen 22:9 He bound his son Isaac and laid him on the altar, on top of the wood.

Abraham's
willingness
to sacrifice Isaac

Most difficult
decision of
their life

Isaac's
willingness
to be sacrificed

What happened in 2573 AM that could logically mark the end of the 450 year period?

The whole Exodus period is under the leadership of two individuals, Moses at the beginning and Joshua at the end. Because Moses was not allowed to enter the Promised Land, God commissioned Joshua to replace him and lead the people in their final journey to their inheritance.

Josh 1:6-7 "Be strong and courageous, because you will lead these people to inherit the land I swore to their forefathers to give them.

After Joshua died the people went to their inheritance.

Judg 2:6 And when Joshua had dismissed the people, the children of Israel went each to his own inheritance to possess the land.

It is therefore quite reasonable to terminate the 450-year period with the **death of Joshua** (the one who brought Israel to its inheritance)

Moses

The two
leaders who
brought Israel
to their
inheritance

Joshua

¹⁰⁰ The expression 'The God of the people of Israel chose our fathers' does convey the idea that the 'choosing' was done following some actions of the 'fathers'. Also, given that Paul used this 'choosing' as the start of the 450 years we can deduce that the fathers' actions were done at the same time.

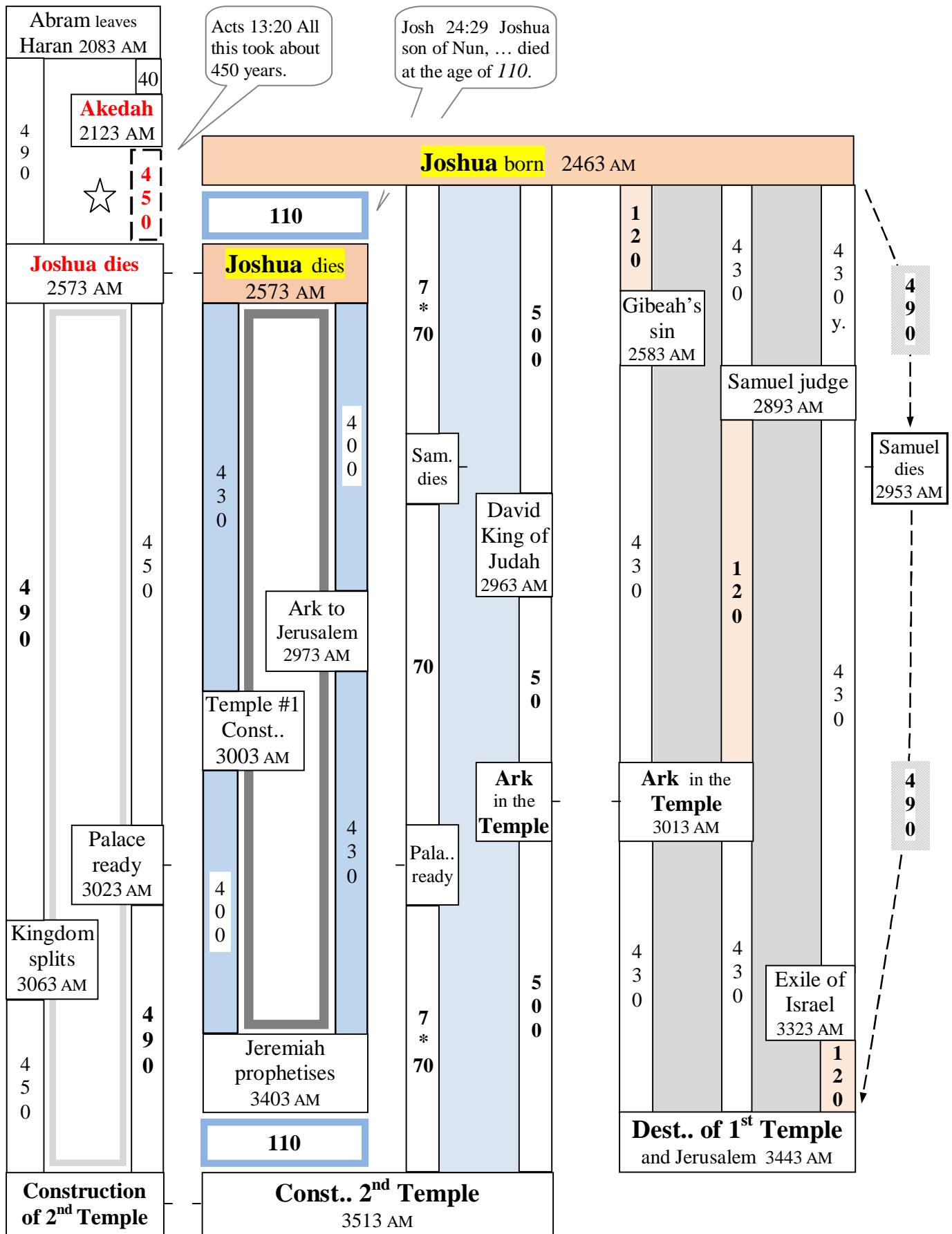

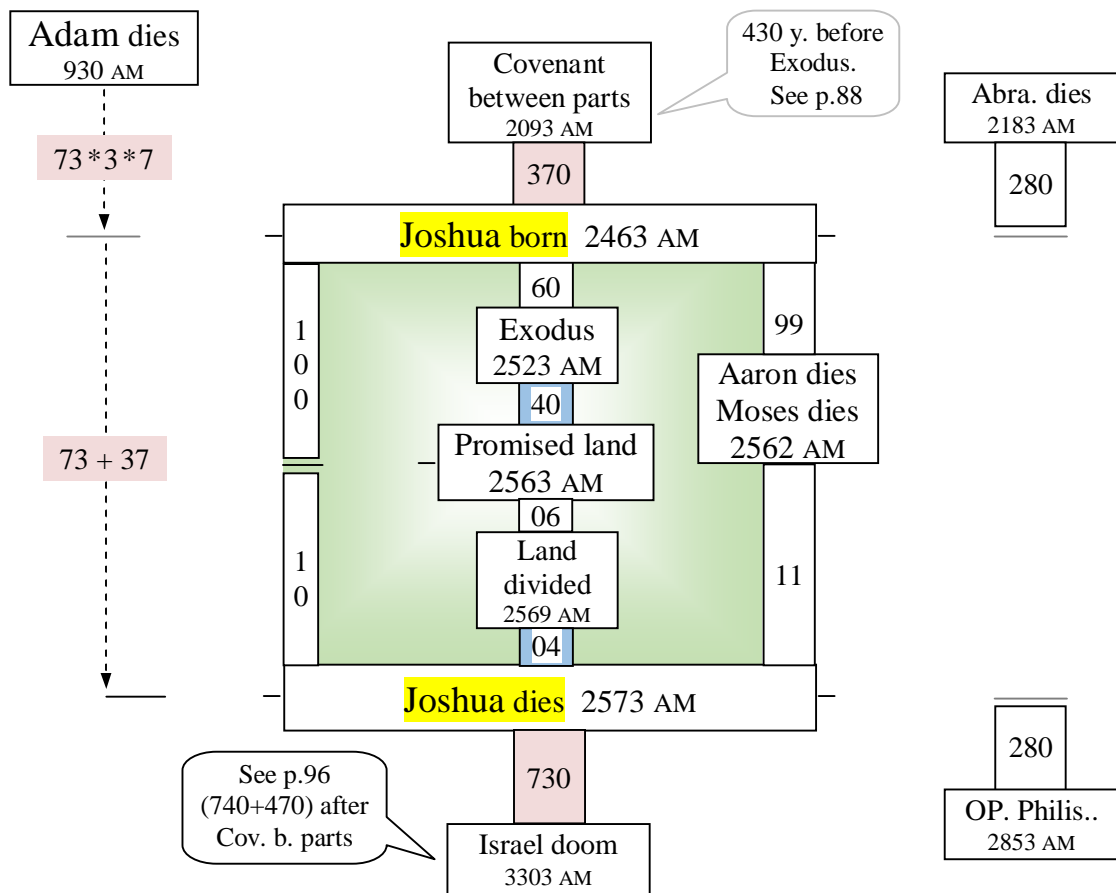

→ Chronology of 7 oppressions and 10 judges.

The first part of the ‘judges’ period’ includes all the oppressions and the judges from the Chushan oppression up to the end of the Philistine oppression (Samuel started judging right after the End of the philistines’ 40 years). This period couldn’t have started before the death of Joshua in **2573** AM or ended after the start of Samuel’s judgeship (see *). Therefore, the maximum time span available to fit in all the judges (but Samuel) and all the oppressions, is the 320 years **between 2573 and 2893** AM (see next page).

Before figuring out the chronology of this period we have to find out if the sequence of judges and oppressions could have overlapped somehow. The table on the right shows, in sequence, each judge and each oppressor with the number of years they apparently ruled. If we add all the time periods then the total obtained is **390** years.

Judge’s period (sequential layout)			
	Oppression		Judge
Judge 3:8	Opp. Chushan	8	
Judge 3:11			Ju Othniel 40
Judge 3:14	Opp. Eglon	18	
Judge 3:30			Ju Ehud 80
Judge 4:3	Opp. Jabin	20	
Judge 5:31			Ju Deborah 40
Judge 6:1	Opp. Midian	7	
Judge 8:28			Ju Gideon 40
Judge 9:22	Opp. Abimelech	3	
Judge 10:2			Ju Tola 23
Judge 10:3			Ju Jair 22
Judge 10:8	Opp. Ammon	18	
Judge 12:7			Ju Jephthah 6
Judge 12:9			Ju Ibzan 7
Judge 12:11			Ju Elon 10
Judge 12:14			Ju Abdon 8
Judge 13:1	Opp. Philistines	40	

* The judge period was before Samuel’s time Acts 13:20 "After this, God gave them judges until the time of Samuel the prophet."

This value is problematic. See next page

$$114 + 276 = \text{Total years} = 390 ?$$

The timeline of the
7 Oppressions and the 10 Judges
 cannot be obtained without some overlapping

J U D G E S	Op. Chushan	8	3 9 0 y.
	Ju. Othniel	40	
	Op. Eglon	18	
	Ju. Ehud	80	
	Op. Jabin	20	
	Ju. Deborah	40	
	Op. Midian	7	
	Ju. Gideon	40	
	Op. Abim..	3	
	Ju. Tola	23	
P E R I O D	Ju. Jair	22	
	Op. Ammon	18	
	Ju. Jephthah	6	
	Ju. Ibzan	7	
	Ju. Elon	10	
	Ju. Abdon	8	
	Op. Philistines	40	

The 390-year period needed to include the time of every judge and every oppression, as shown on the left, is far too large for the 320-year period available on the right.

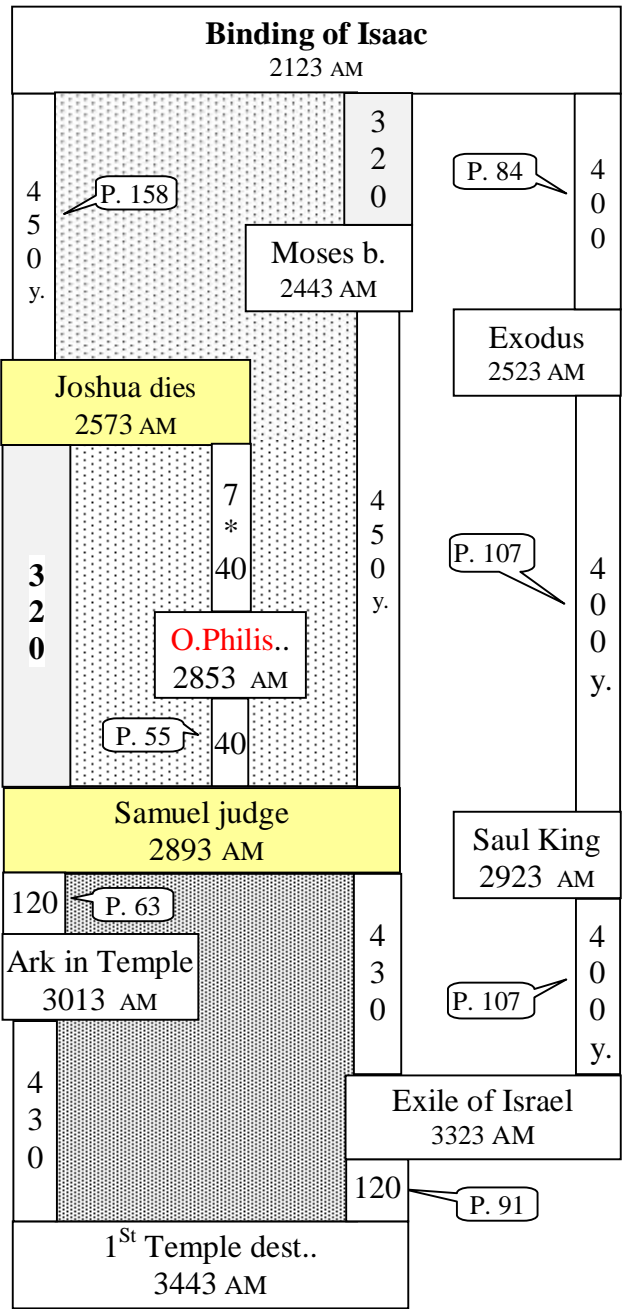

As it is clearly shown in the above figure, even if we start the oppression of Chushan the same year that Joshua died, there wouldn't be enough time to fit all the judges and all the oppressions before the start of Samuel's judgeship.

The **320** years between **Joshua's death** and the start of **Samuel's judgeship** cannot be increased. Therefore **the only way out** is to reduce the 390 year period previously obtained for the judges and oppressions. That can only be done by **overlapping** some periods or reducing the value of others. It may seem an impossible challenge given all the possibilities, but fortunately, as we will see, most of the judges and oppressions clearly didn't overlapped¹⁰¹. Our first step to resolve this difficult puzzle is to find out when the Oppression of Chushan started. The next chart gives us a very strong indication that it was in 2593 AM.

¹⁰¹ «it is decidedly contrary to the meaning of the book, to represent any two of the judges as ruling in different parts at the same time. At the commencement of each new section, it is always the nation collectively which is spoken of» Ref : John Kitto (1804-1854) *The Pictorial Bible*

Oppression of Chushan

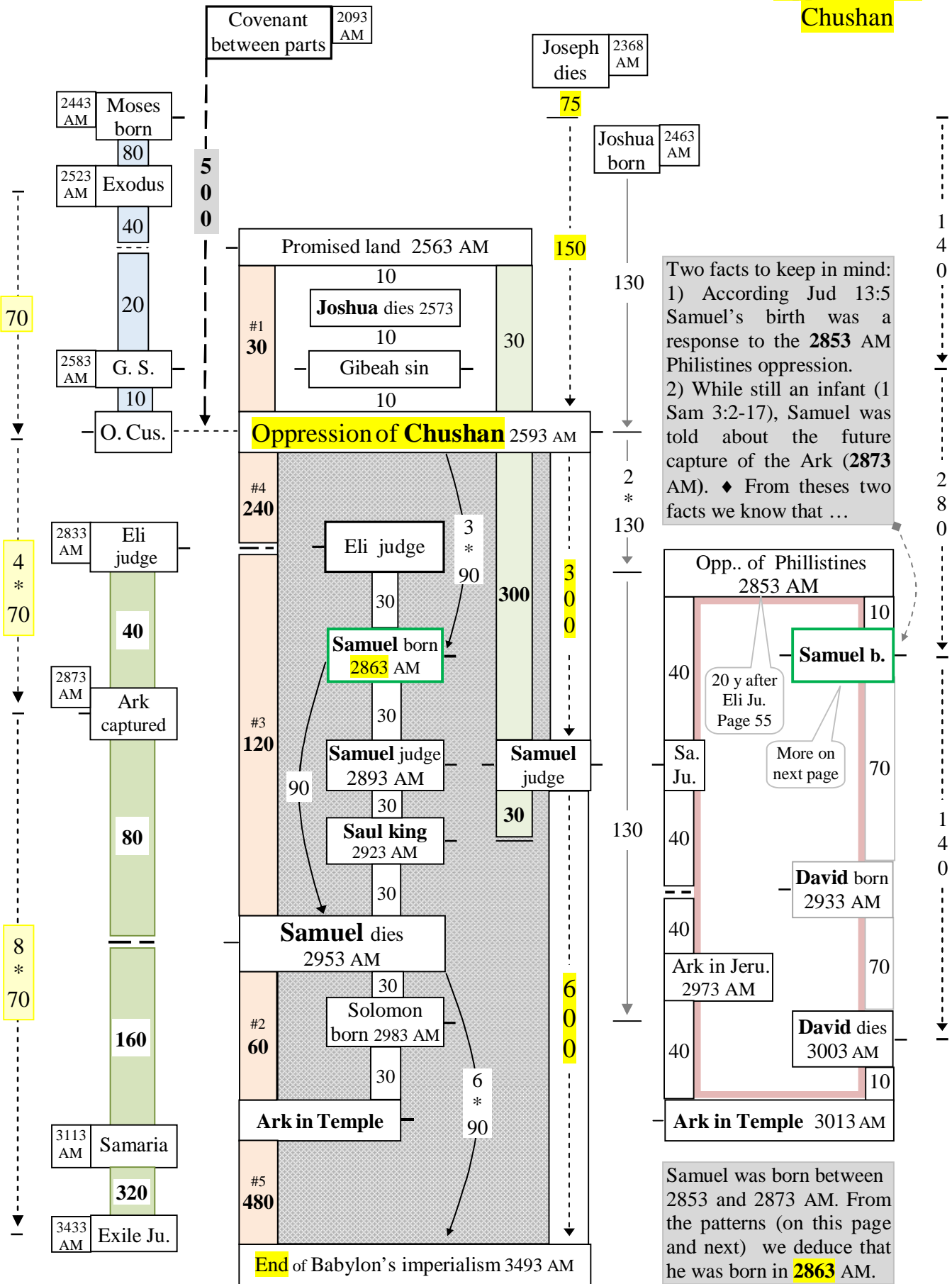

Two facts to keep in mind:
 1) According Jud 13:5 Samuel's birth was a response to the 2853 AM Philistines oppression.
 2) While still an infant (1 Sam 3:2-17), Samuel was told about the future capture of the Ark (2873 AM). ♦ From these two facts we know that ...

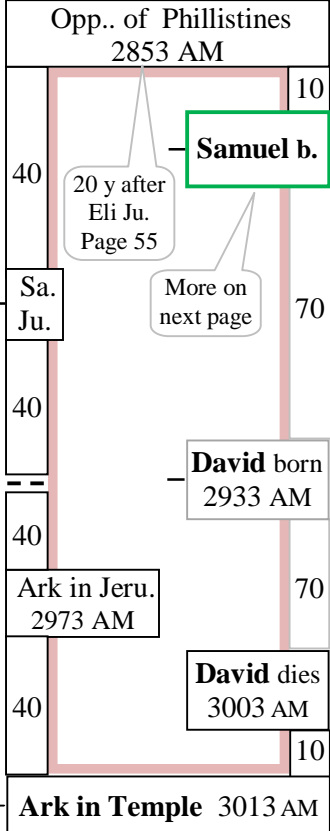

Samuel was born between 2853 and 2873 AM. From the patterns (on this page and next) we deduce that he was born in 2863 AM.

We can fix the date of Jephthah's judgeship.

After 18 years of oppression, Ammon claimed a part of Israel's territory pretending that it belonged to the Ammonites. Jephthah, a warrior, answered back that this territory had been under the control of Israel for the last 300 years:

- Judg 11:25-26 For **300 years** Israel occupied Heshbon, Aroer, the surrounding settlements and all the towns along the Arnon. Why didn't you retake them during that time?

If we can find out the origin of these 300 years we will be able to figure out the year that Jephthah became Judge.

The Bible tells us that just before the year before Moses died (i.e. 2562 AM), the territory around the Arnon was captured and given to the tribe of Reuben:

- Num 21:24 Israel, however, put him to the sword and took over his land from the Arnon to the Jabbok,
- Deut 2:36 From Aroer on the rim of the Arnon Gorge, and from the town in the gorge, even as far as Gilead, not one town was too strong for us. The LORD our God gave us all of them.
- Deut 3:16-17 But to the Reubenites and the Gadites I gave the territory extending from Gilead down to the Arnon Gorge (the middle of the gorge being the border) and out to the Jabbok River, which is the border of the Ammonites.

This territory of Reuben's is the same land that would be claimed by Ammon 300 years later, thus making Jephthah's judgeship start in 2862 AM (2562 + 300).

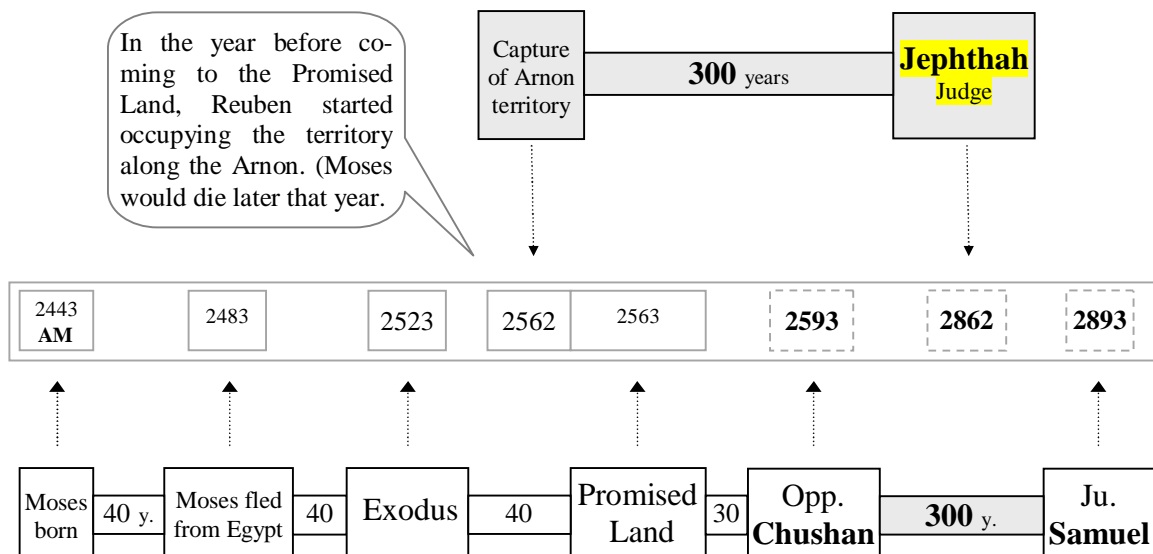

We now have three important dates to help us chart the chronology of the period of Oppressions and Judges. From those dates (2593, 2862, 2893) we are going to move forwards and backwards and lay down as many events as possible.

Judges conflicting chronology

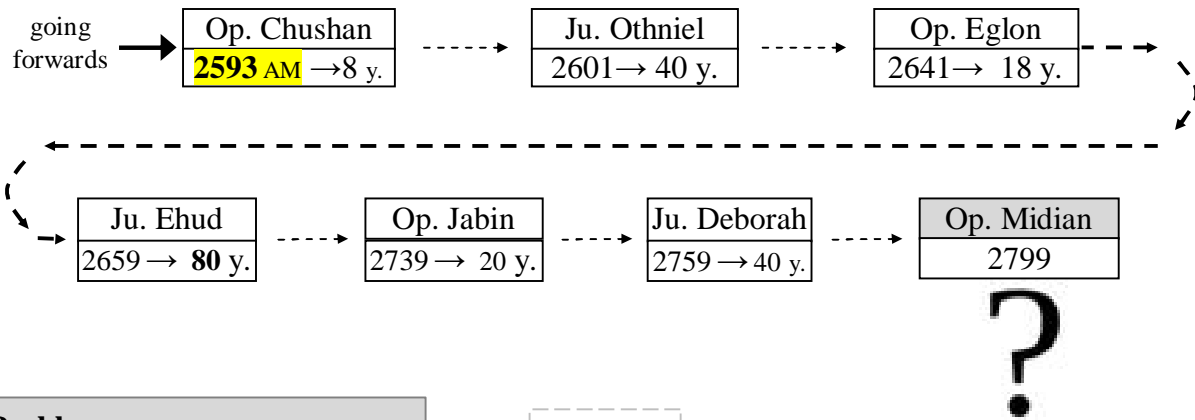

Problem
The progression of the sequence of events at the top of this page, which goes forward from the Opp of Chushan, sets the
Opp of Midian in 2799 AM



but then it creates an obvious conflict with the sequence of events found at the bottom of this page which goes backwards from Samuel and sets the
Opp of Midian in 2749 AM

?

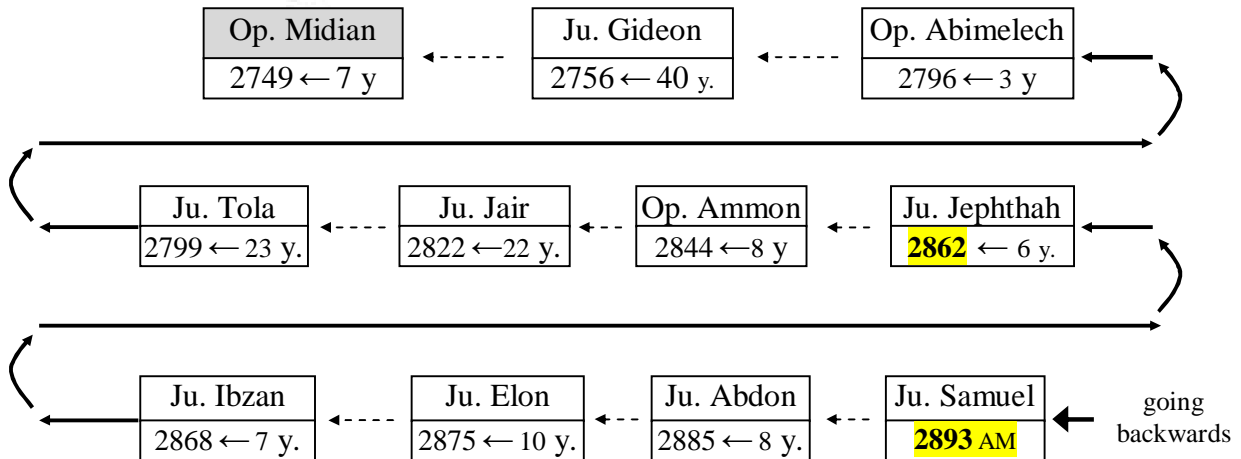

Judges' **right** chronology

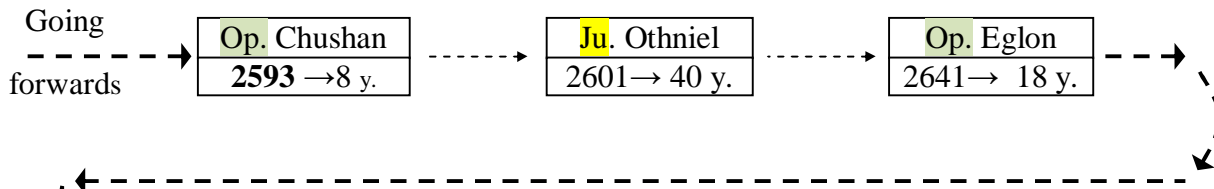

Solution : rejecting the unlikely 80 years of Ehud

The solution to harmonise the 'forwards' and the 'backwards' sequence is to recognize that the 80 years of Ehud is highly suspicious and could have been inflated as the result of a scribal error. (Notice that this number, 80, is twice 40, the highest value reached by three other Judges). The suggested solution will reduce that value from 80 to 18 and will introduce a gap of 12 years at the end of Deborah's 40-year judgeship.

It is worth noting that we could have tried to overlap the 80 years of Ehud with the judgeship of other Judges but this possibility has been rejected on the grounds that the Bible's text doesn't suggest any overlapping before the introduction of the double oppressions of Ammon and the Philistines.

- Judg 10:7 and He sold them into the hands of the Philistines and into the hands of the people of Ammon.

This solution may seem innocuous but, as you will discover in the following pages, it is going to transform the Judge's period of **inconsequential** numbers into a stunning series of patterns, imprinted by the Divine Finger.

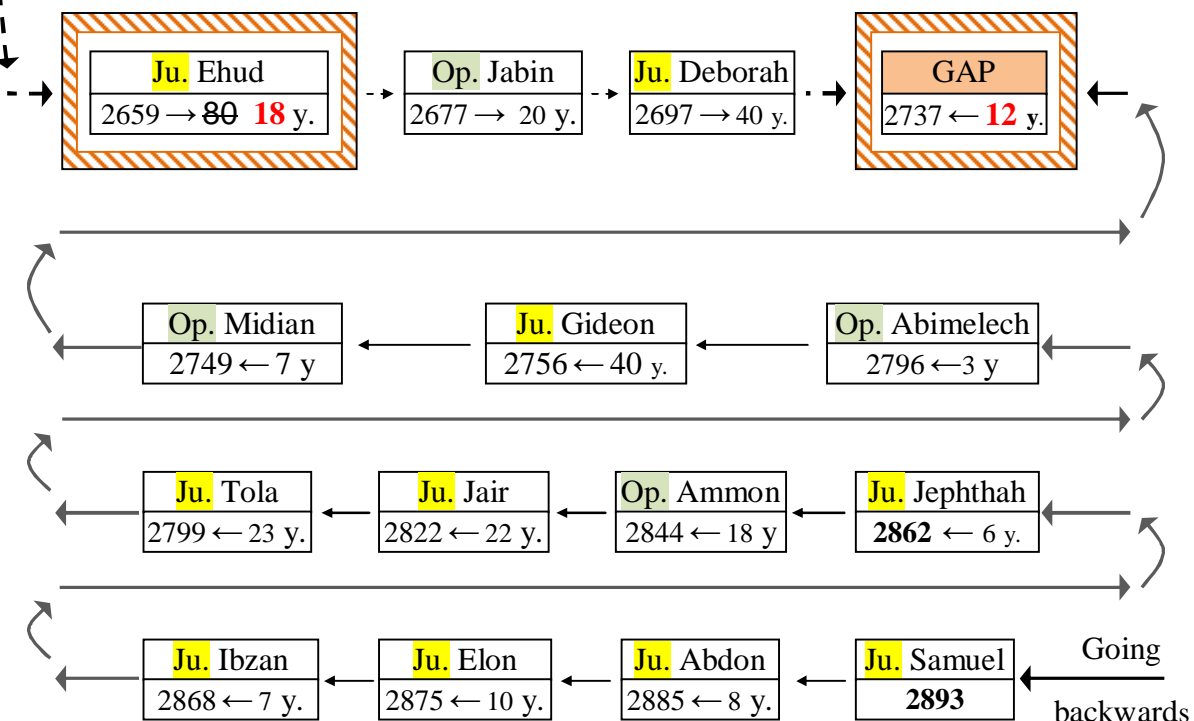

Here the Judges timeline's values are assembled in 5 groups (G1, G2, G3, G4, G5)

			G1	G2	G3	G4	G5	Total
1	Judges 3:8	8 Chushan	8					300 Years
2	Judges 3:11	40 Othniel	40					
3	Judges 3:14	18 Eglon	18					
4	Judges 3:30 ?	18 Ehud		18				
5	Judges 4:3	20 Jabin					20	
6	Judges 5:31	40 Deborah		40				
7	No ref.	12 Gap			12			
8	Judges 6:1	7 Midian			7			
9	Judges 8:28	40 Gideon			40			
10	Judges 9:22	3 Abimelech				3		
11	Judges 10:2	23 Tola				23		
12	Judges 10:3	22 Jair				22		
13	Judges 10:8	9 Ammon P1				9		
14	Judges 10:8	9 Ammon P2				9		
15	Judges 12:7	6 Jephthah					6	
16	Judges 12:9	7 Ibzan			7			
17	Judges 12:11	10 Elon					10	
18	Judges 12:14	8 Abdon		8				
			= 66	= 66	= 66	= 66	= 6*6	

Note: Most of the patterns in the last few pages couldn't have been found without reducing Ehud's 80 years to 18. I am well aware that invoking a scribal error to invalidate a value found in the biblical text is a serious matter and shouldn't be done without serious consideration. Below is a Hebrew representation of both numbers 80 and 18. Reading from right to left, we can see that the first 4 letters in each box are almost identical, however the writing of 80 involves only one word (eight in its plural form) while the writing of 18 is done with two words ('eight' in its singular form followed by ten).



The partial similarity of the two numbers doesn't prove that a scribe, a long time ago, wrongly transcribed 80 instead of 18 on his manuscript while copying Judge 3:30. It does however show that it is not absolutely unthinkable. In the light of the previous few charts and the fact that Ehud could have hardly judged for 80 years, '18' is therefore a very appealing solution.

Sequence starts with a **spying event**



Joshua send spies
2524 AM

19

Sojourn in Kadesh Barnea

Joshua born
2463 AM

120

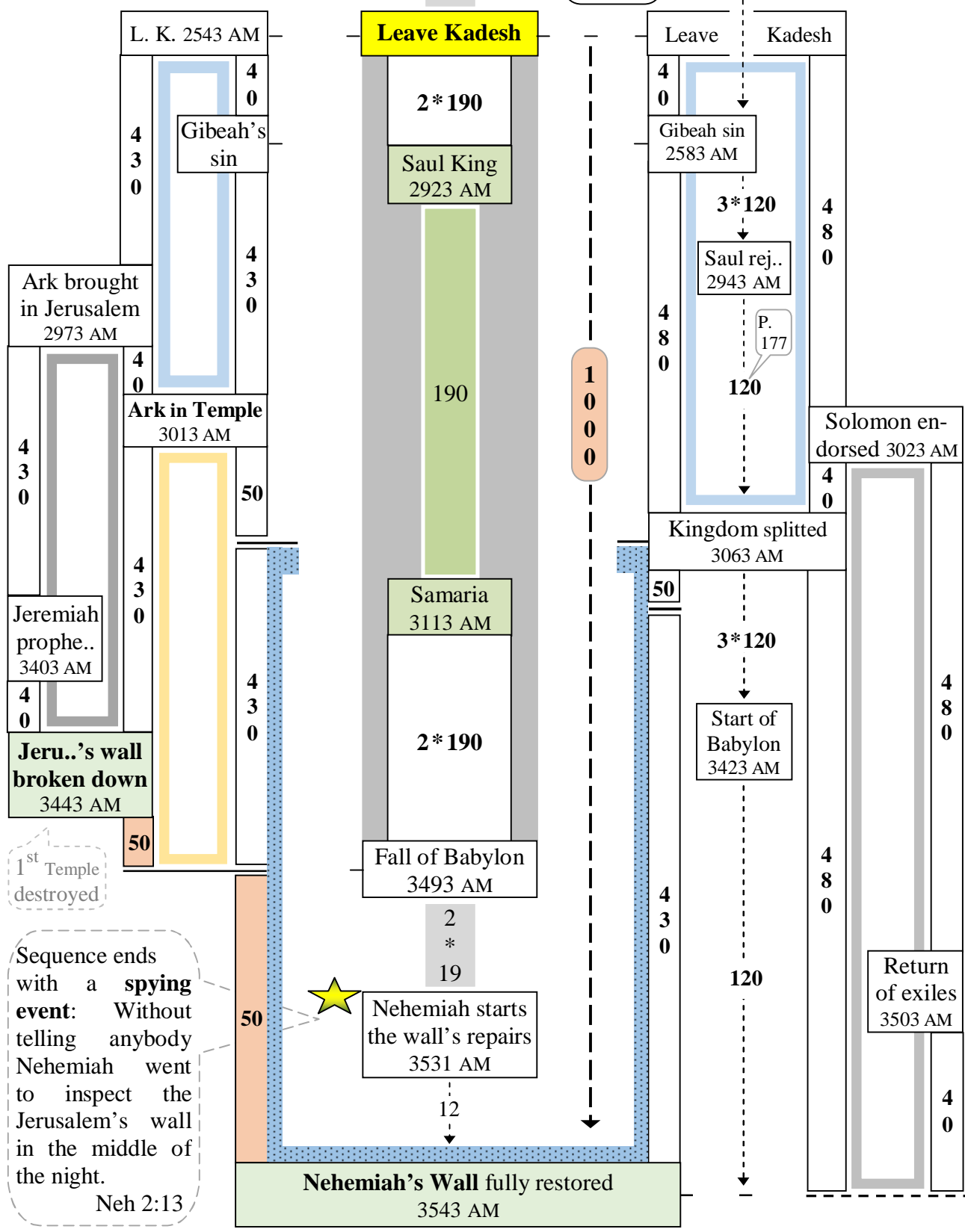

Sequence ends with a **spying event**: Without telling anybody Nehemiah went to inspect the Jerusalem's wall in the middle of the night.
Neh 2:13

→ Pilgrimage of fathers and sons

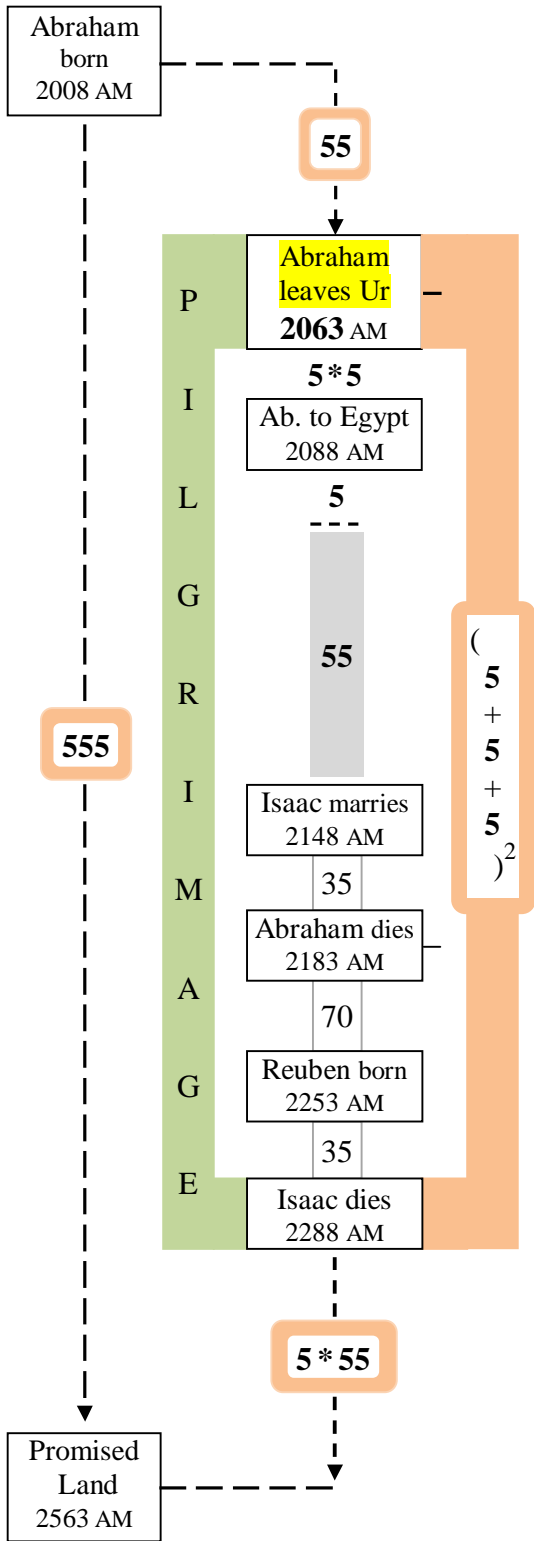

There is no specific statement in the Bible to help us figure out when Abraham left Ur and started his pilgrimage ...

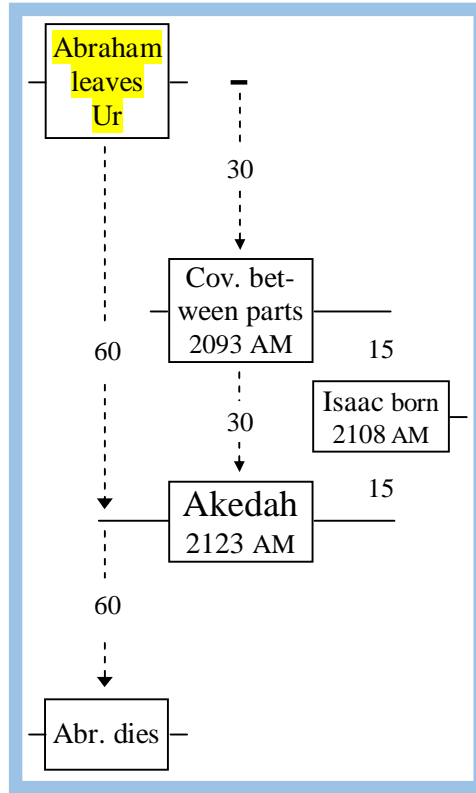

... However we can speculate that it happened in 2063 AM as it is strongly suggested by this figure. This new date (2063 AM) will lead us to some surprising discovery.

For instance, we saw earlier that the northern tribes of Israel went into Exile in 3323 AM. This is exactly 20 * 63 years after Abraham own Exile from Ur in 2063 AM.

Abra. Leaves Ur 2063 AM

20 * 63

Exile of Israel 3323 AM

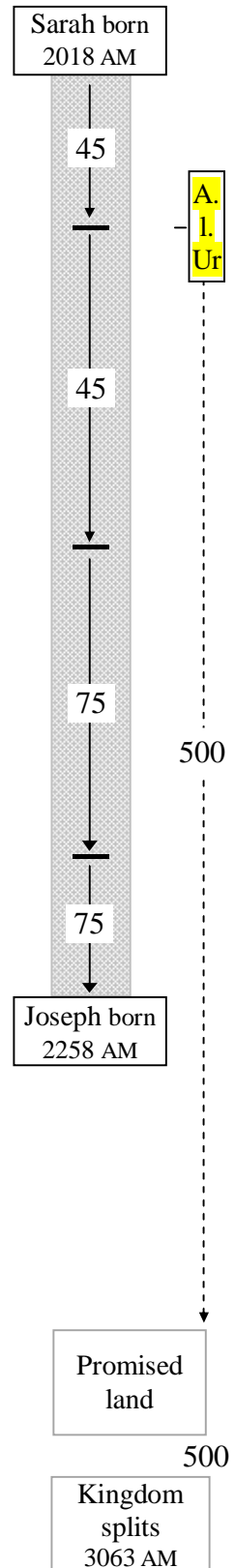

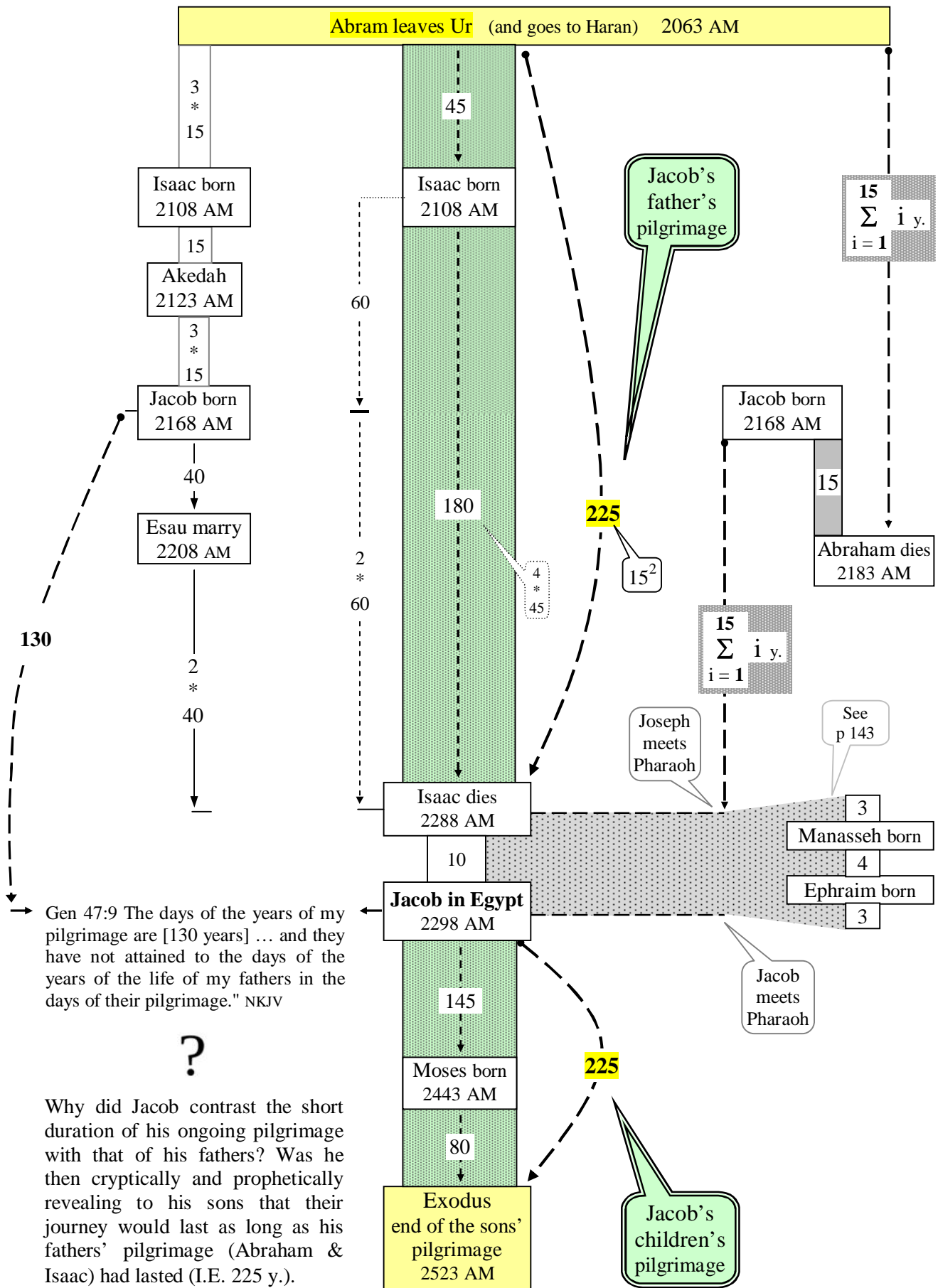

Gen 47:9 The days of the years of my pilgrimage are [130 years] ... and they have not attained to the days of the years of the life of my fathers in the days of their pilgrimage." NKJV

?

Why did Jacob contrast the short duration of his ongoing pilgrimage with that of his fathers? Was he then cryptically and prophetically revealing to his sons that their journey would last as long as his fathers' pilgrimage (Abraham & Isaac) had lasted (I.E. 225 y.).

→ **When did Abraham marry Sarah ?** Establishing which year Abraham got married to Sarah is a very speculative task ss there are absolutely no direct information to clarify the point. However, we have seen in this chronology that each biblical event always fits in a strong network of patterns and finding many of these around the year 2033 (wedding year?) should be a clue in itself. You decide.

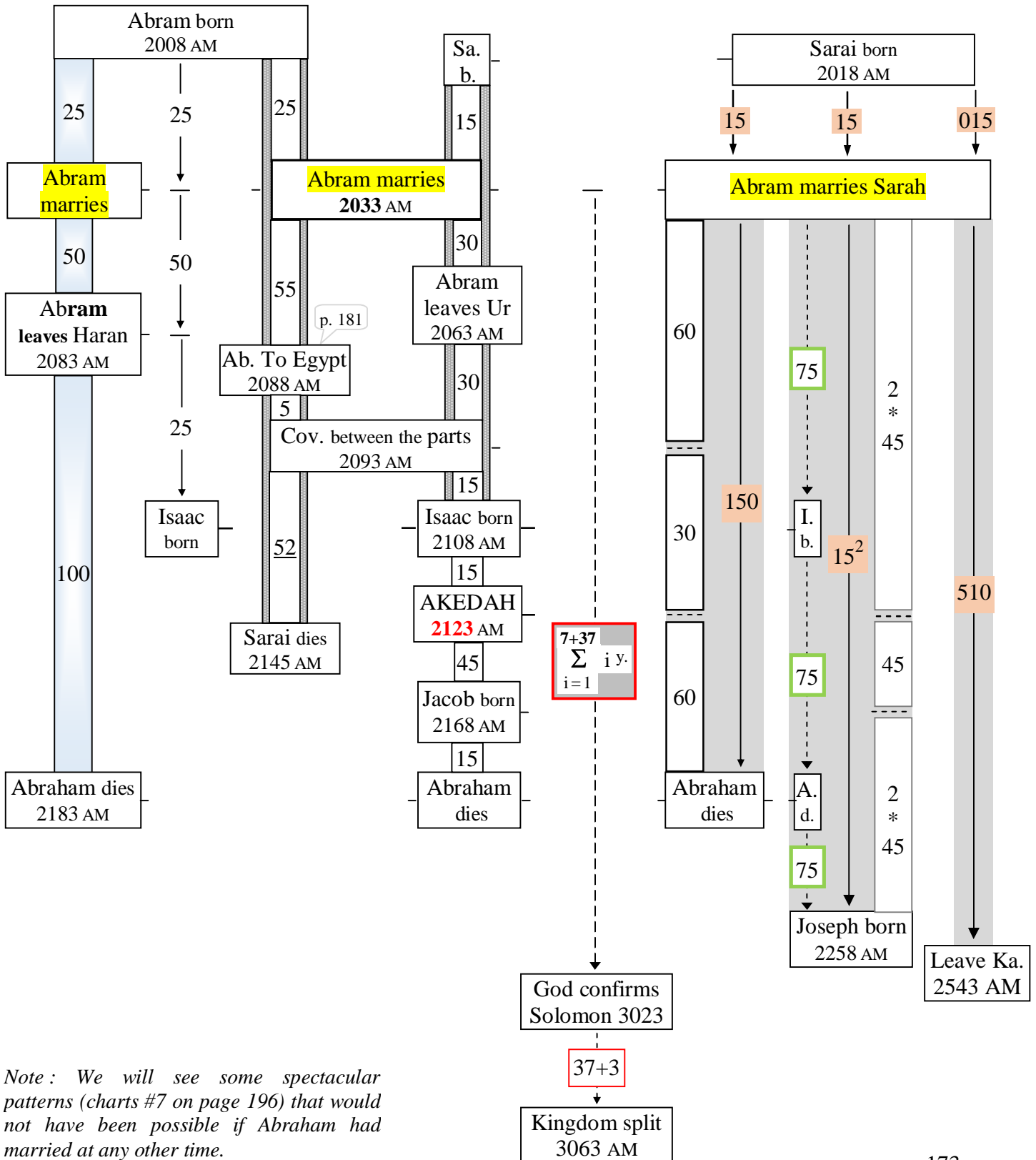

Note: We will see some spectacular patterns (charts #7 on page 196) that would not have been possible if Abraham had married at any other time.

➔ Understanding Judah & Israel EXILE

❖ About Judah's Exile (to Babylone)

God had clearly told Judah (collective name for the two tribes of Benjamin and Judah) that **she** wouldn't be spare for her sins. Contrary to some commentator's belief, Ezekiel portraying of Judah 40 years of sin was not a way to erase their fault. Judah would have to pay some price itself.

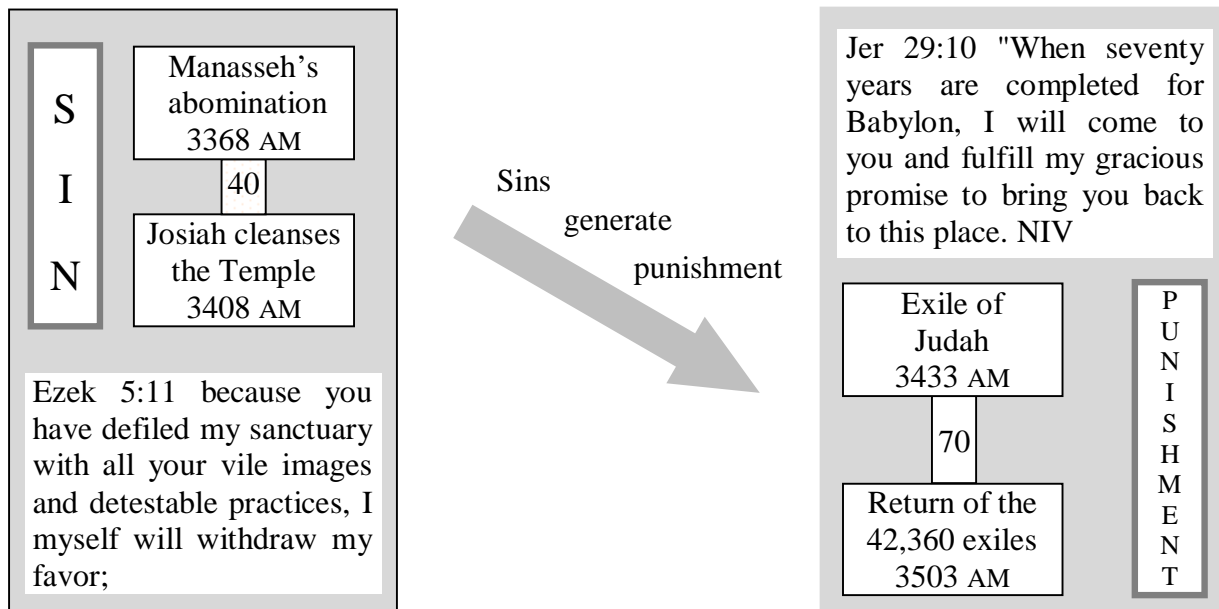

Problem: According Isaiah 40:2 the 'penalty time' generated by the 40 years of sin should have been twice that time (i.e. **80** years).

- Isa 40:2 proclaim to her that her hard service has been completed, that her sin has been paid for, that she has received from the LORD's hand **double** for all her sins. NIV

If the Exile was the punishment why did it last only 70 years? Are we missing something?

If we look carefully at the next chart we see that Judah's suffering was not over at the end of the 70-year captivity (exile). When the people came back from exile in 3503 AM, they had to go through 10 years (3503-3513 AM) of privation because the land was then in the 60th year of her 70-year rest (desolation of the land). (In others words even though the people were back to a land that had flowed with milk and honey in the past, they were going to wait a further 10 years before they could see any new crop in the fields)

Understand the following two very important points:

1. The 70-year of Exile (3433-3503 AM) and the 70-year of land desolation (3443-3513 AM) are two different period that partially overlap.
2. During the 70-year desolation, the land was not producing any crop. This inactivity was a compensation for the previous 490 years of 'non stop' exploitation..

Therefore the people of Judah were punished during 80 years and it came in two parts: 70 years of exile (3433-3503 AM) followed by 10 years of privation (3503-3513 AM).

Dan 9:11 Yes, all Israel has transgressed Your law, and has departed so as not to obey Your voice; therefore **the curse and the oath written in the Law of Moses the servant of God have been poured out on us**, because we have sinned against Him. NKJV

Judah received **DOUBLE** (i.e. 80 years) for her 40 years of sin

Jer 16:18 I will repay them **double** for their wickedness and their sin, because they have defiled my land with ... and have filled my inheritance with their detestable idols."

2 Chron 36:21 to fulfill the word of the LORD by the mouth of Jeremiah, until the land had enjoyed her Sabbaths. As long as she lay **desolate** she kept Sabbath, to fulfill **seventy years**.

Return of the 42,360 exiles 3503 AM

Hag 2:17 I struck all the work of your hands with **blight, mildew and hail**

Foundation of 2nd Temple 3510 AM

Hag 1:9 "Because **of my house, which remains a ruin,**

Const.. 2nd Temple 3513 AM

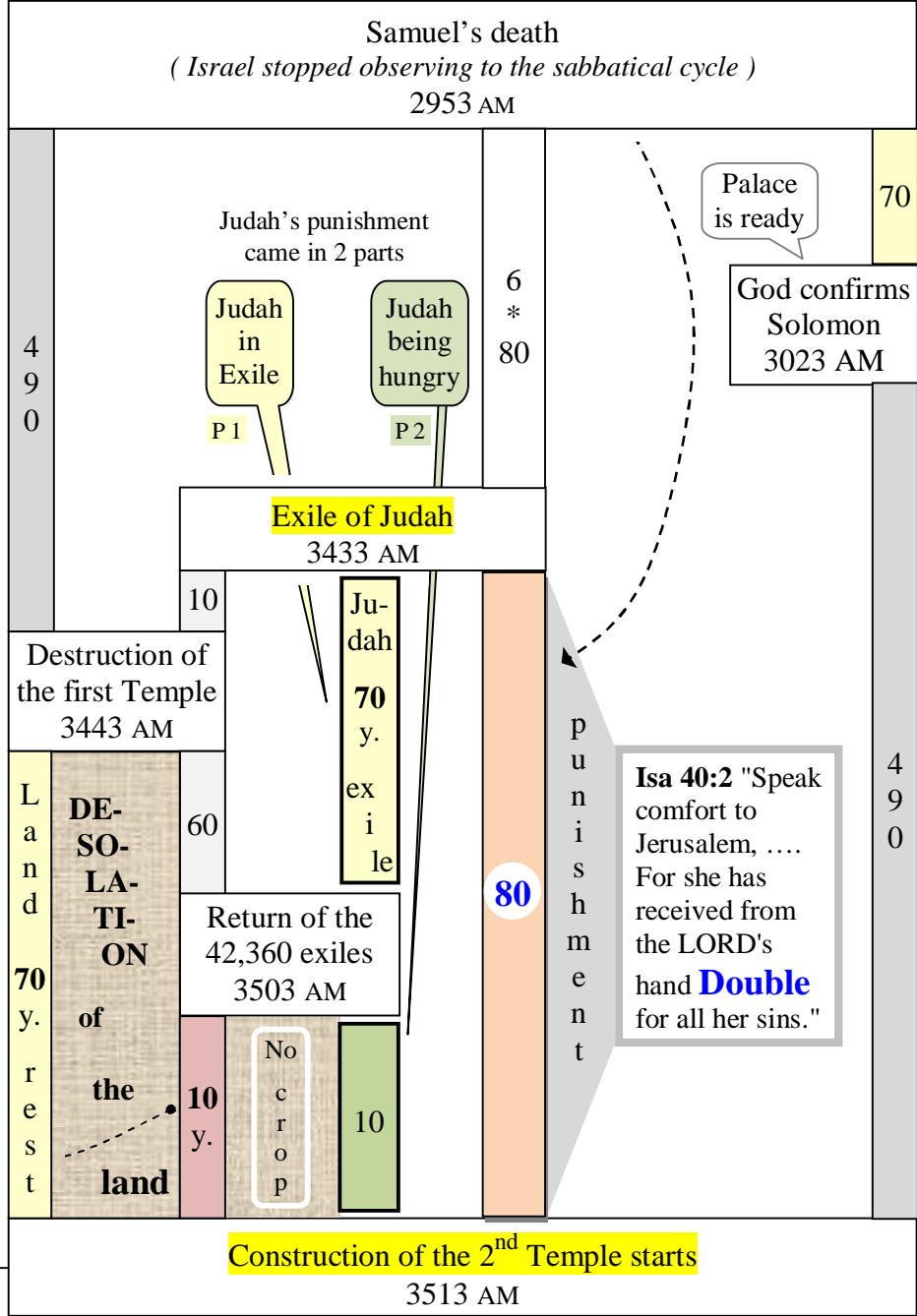

❖ About Israel's Exile and its later disappearance (to Assyria)

Much has been said about the fact that Israel (northern 10 tribes) was punished '7 times over' for its evil behaviour. It is doubtful anybody ever understood it correctly.

- Lev 26:18 If after all this you will not listen to me, I will punish you for your sins seven times over.

When Lev. 26:18 uses '7 times over' we should ask ourselves '7 times over' what? And the obvious answer that should come to mind is: '7 times over' the previous period of time during which ISRAEL HAD ALREADY been PUNISHED. We need to understand that the full punishment is given in two parts. There was to be a punishment during an initial period of time and, if it didn't work (they still didn't return to YHVH), then, the people would be punished again but this time **the 'penalty time' would be increased 7 times over.**

I am going to speculate that King Saul was rejected at the exact midpoint –**2943 AM**– (see next page) of his 40-year reign (2923-2963 AM). This event had initiated a **380 year** period of punishment whose end (3323 AM) should have brought some forgiveness from God but instead was marked by the northern tribes going into exile. Did those Israelites from the northern tribes ever come back from their exile? If you are among those who believe, as I do, that these northern Israelites are still in exile, and that they should be distinguished from the 'exiles' of Judah who came back with Zerubbabel in 3503 AM (page 174), then, ask yourself the following question: **Why haven't they come back yet to reclaim their¹⁰² land?** I suggest that God had prevented them to do so because they never repented during the initial '380-year' phase (2943 AM - 3323 AM) of the punishment (see Amos 4:6-12). They are now serving the second phase of that punishment and they won't be back until the whole '7 times over' had elapsed.

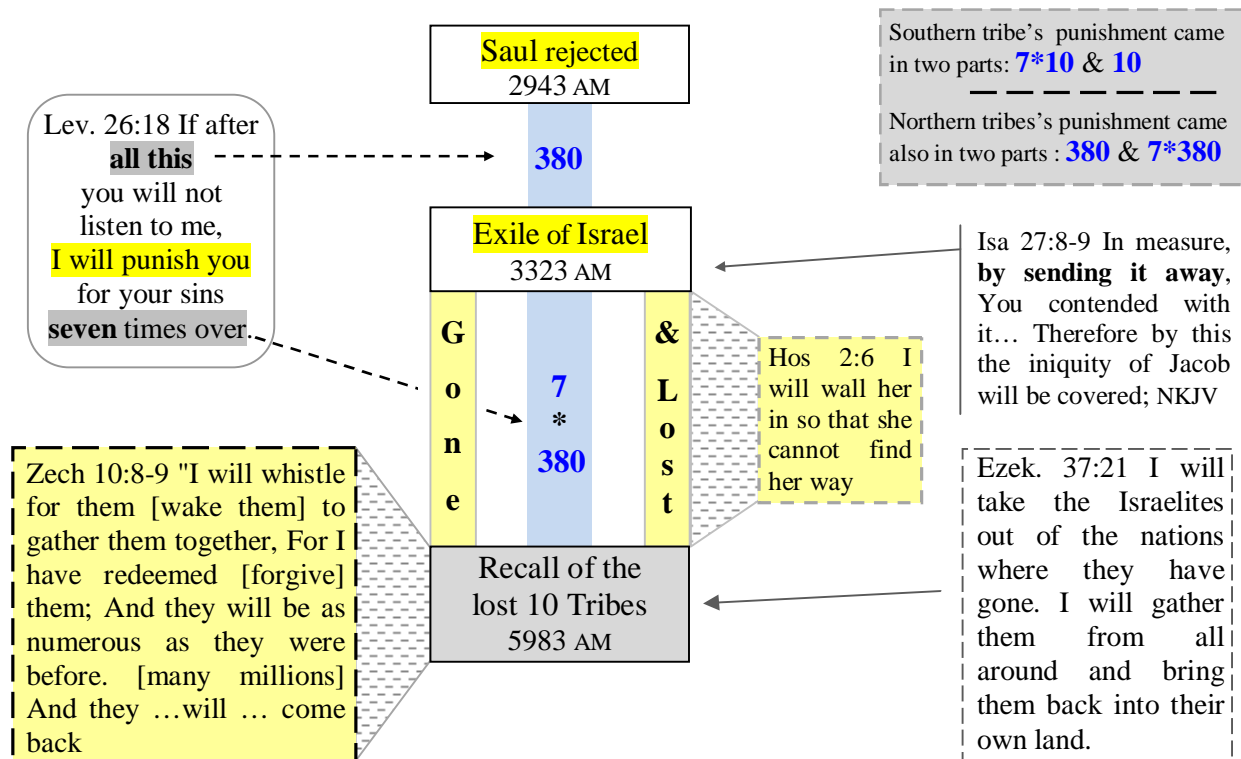

¹⁰² Gen 17:8 Also I give to you [Abraham] and your descendants [**southern and northern tribes**] after you the land in which you are a stranger, all the land of Canaan, as an everlasting possession; and I will be their God."

By postulating that Saul was rejected (1 Sam 15:23) in 2943 AM we come across many patterns. **Important:** When Saul was rejected by God it didn't mean he wouldn't reign some more years. ...

... Rejection was about his posterity not being allowed to reign over the 12 tribes.

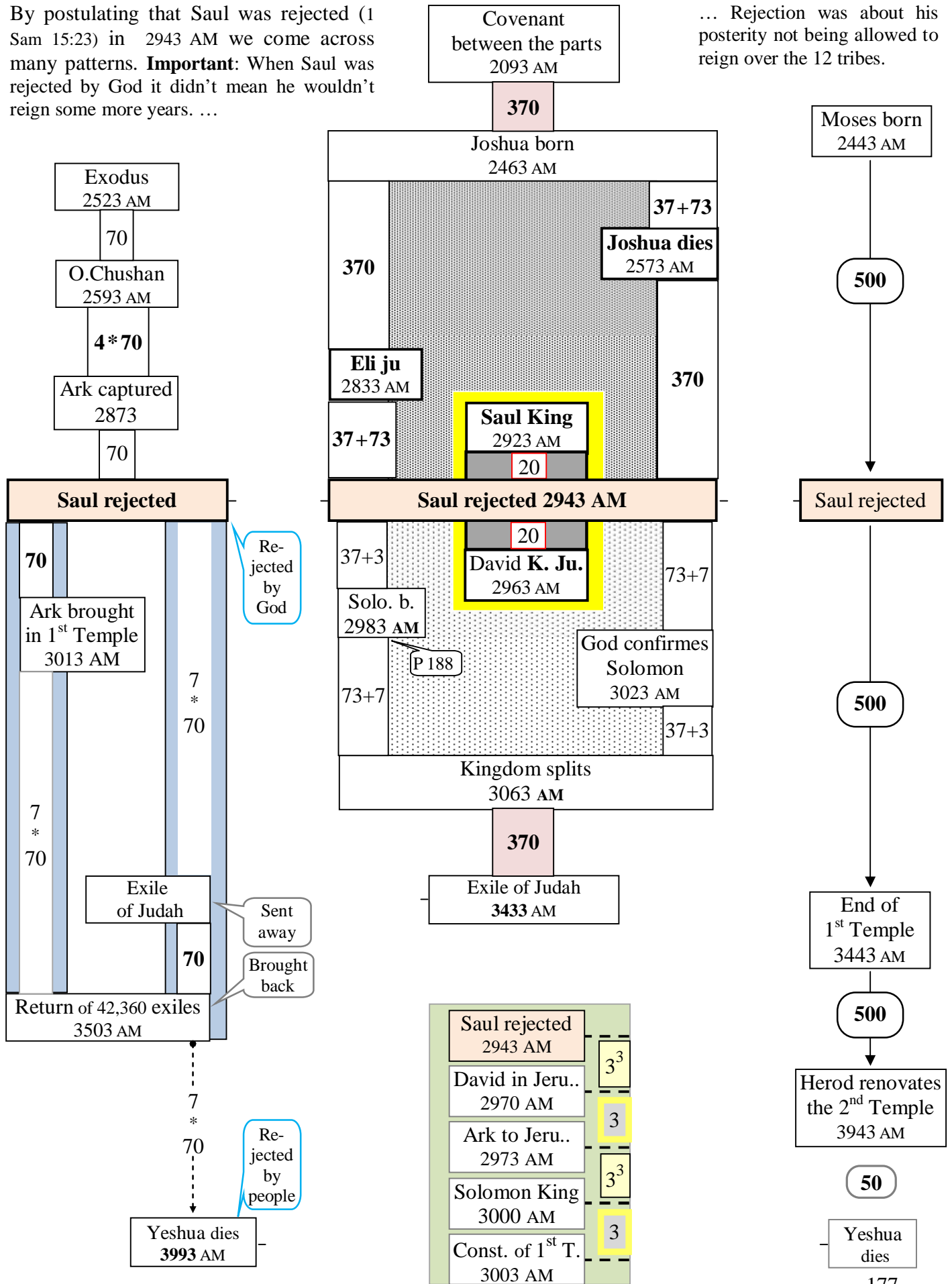

Acts 7:17 "But when the time of the promise drew near which God had sworn to Abraham, the people grew and multiplied in Egypt NKJV

Abraham dies
2183 AM

The promise : Gen 15:14-15 they shall come out with great possessions.
Now as for you [Abraham], **you shall go to your fathers in peace**

F
u
l
f
i
l
l

380 years

P
r
o
m
i
s
e

Lev 26:13 I am the LORD your God, who brought you out of the land of Egypt

Ps 78:56-58 But they put God to the test and rebelled against the Most High; they did not keep his statutes. Like their fathers they were disloyal and faithless

7 oppressions
Chushan, Eglon, Jabin, Midian, Abimelech., Ammon, Philistines.
and no matter what, people kept rejecting God

Promised Land
2563 AM

D
i
s
o
b
e
y

380

Lev 26:14 But if you do not obey Me, and do not observe all these commandments

Saul is rejected
(first king of Israel)
2943 AM

Lev 26:17 I will set My face against you, and you shall be defeated by your enemies

And the northern kingdom became lost (10 tribes), **they even forgot their own identity**

Hos 7:13 **I long to redeem them but they speak lies against me.**

P
u
n
i
s
h
e
d

380

Initial punishment

Exile of Israel
3323 AM

Lev 26:18 If after all **this** you will not listen to me,

Hos 12:14 But Ephraim has bitterly provoked him to anger; ... and [the Lord] will repay him for his contempt

And God rejected them

Hos 1:10 'You are not my people.'

D
i
s
a
p
p
e
a
r

7 * 380

Extended punishment 7 times over

Lev 26:18 I will punish you for your sins **seven times over.**

Hos 6:2 After two days he will revive us; on the third day he will restore us.

(If day = 1000 years, then the end of the (7*380 years) would be within the 3rd day.)

? Recall ?
of the 10 tribes
5983 AM

Jer 31:18 I have surely heard Ephraim's moaning: 'You disciplined me like an unruly calf, and I have been disciplined. **Restore me**, and I will return,

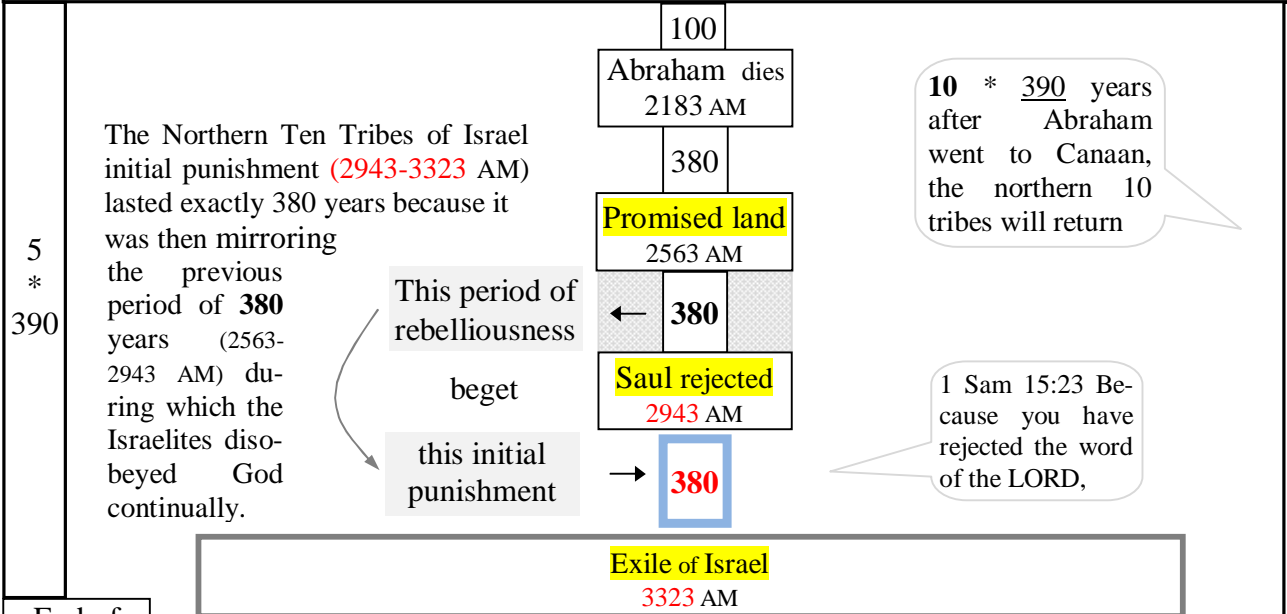

End of 2nd Temple 4033

Can we reasonably believe that the northern exiles will ever be back?

The people of the northern kingdom of Israel were carried away by Assyrians. The people of the southern kingdom of Judah were carried away by Babylonians.

God promised that He would gather His people

Paid special attention to Jeremiah: 23:3 I myself will gather the remnant of my flock out of all the countries where I have driven them. 23:4 **'none would be missing'**.

We know that the tribes of Judah & Benjamin came back from Babylon after their 70-year exile (see p 175).

But the Northern 10 tribes never came back from the Assyrians' captivity. It is even believed that in due course they were scattered into many nations.

Nevertheless God said **'none would be missing'**

N.B. This 'exile' will end only when the people will collectively 'and miraculously' learn who they really are.

Rom 11:25 that **blindness in part is happened to Israel, until the fullness of the Gentiles be come in.**

Where are the wandering children (Lost tribes) of the northern 10 tribes today?

While there is no definite consensus some researchers point to England, USA, Canada, France, Netherlands, Scandinavia, Finland, Ireland, Switzerland, Belgium, Australia, New Zealand. (It goes without saying that not all the inhabitants of these countries would be descendants of Israelites.).

The Hebrew word 'Brit-Am' means "Covenant of the people" (Isa 42:6). Is it why the British got the name Great-Britain? Notice that they also call themselves **Anglo-Saxons**. Are the 'Saxons' from 'Isaac's sons'?

Are names like Denmark, London, Danube, Dardanelles, Edinburgh, the Don's river in Scotland and many others locations, a testimony for the tribe of Dan as it was leaving his trail across Europe?

Gen 49:17 Dan will be a serpent by the roadside



For more on the subject:
-Judah's Sceptre and Joseph's birthright by J. H. Allen.
-Yair Davidy's research

10 * 390

7 * 380

The repetitive usage of the number '38' between the 'Covenant of Circumcision' and the 'Recall of the Lost Tribes' is a powerful argument that add credibility to the following chronological structure.

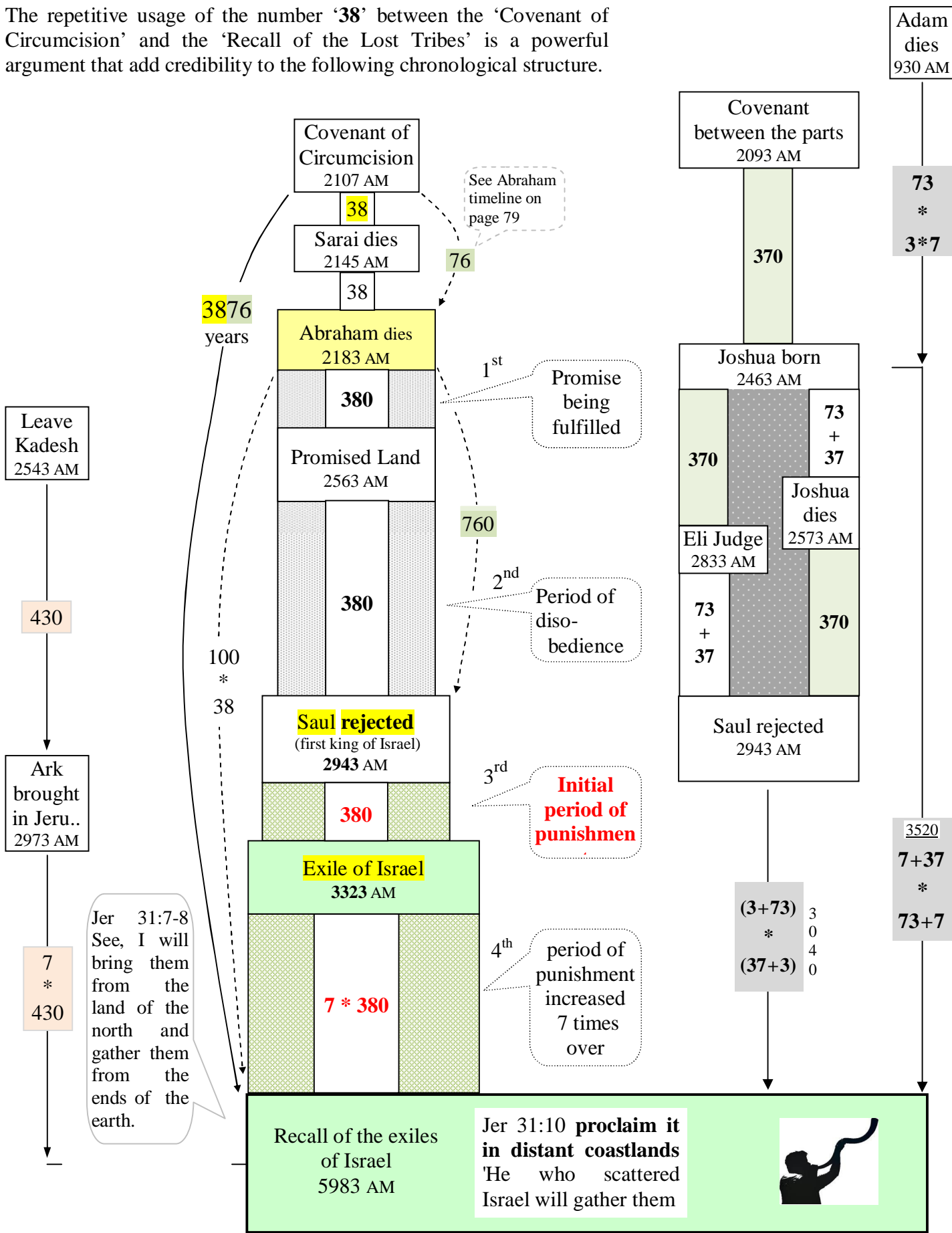

A very attractive supposition Part 1: When did Abraham go to Egypt?

Abraham left Haran to go to Canaan in 2083 AM. The Covenant of the parts was ratified in 2093 AM. Sometime between 2083 and 2093 AM Abraham went to Egypt

Gen 12:10 Now there was a famine in the land, and Abram went down to Egypt to live there for a while

Now lets suppose Abraham went to Egypt in **2088 AM** (the following 2 patterns seem to confirm it)

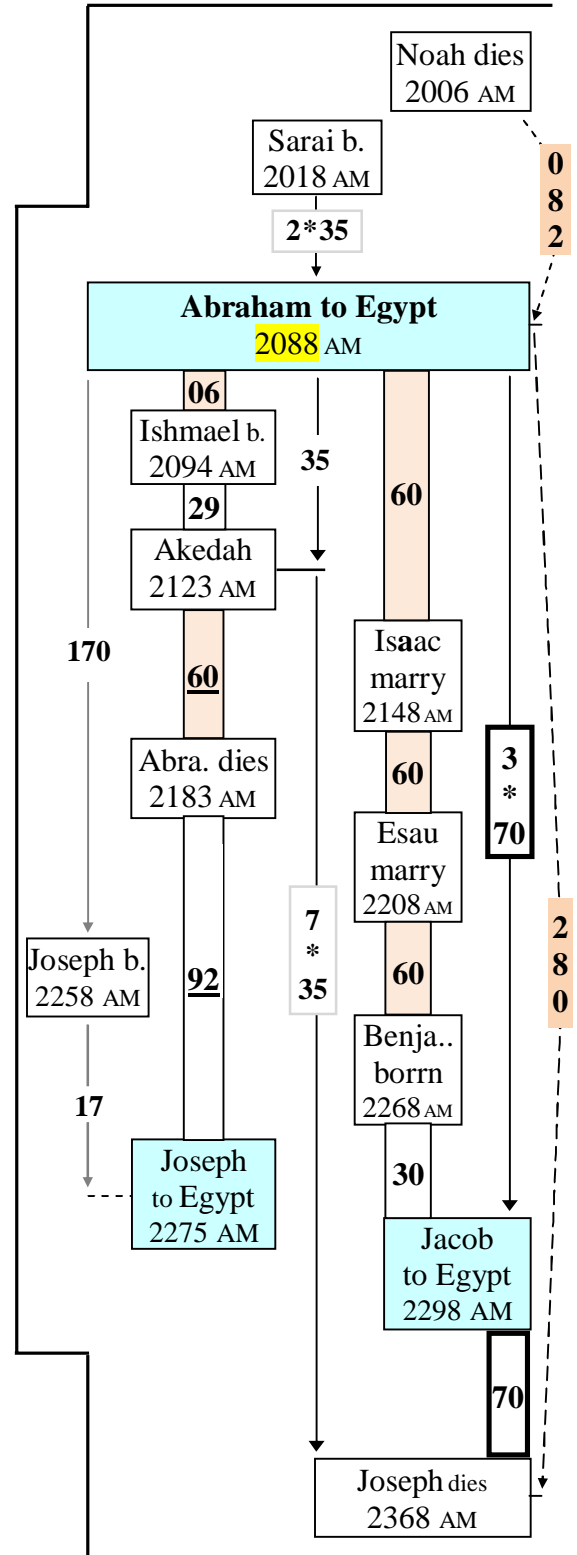
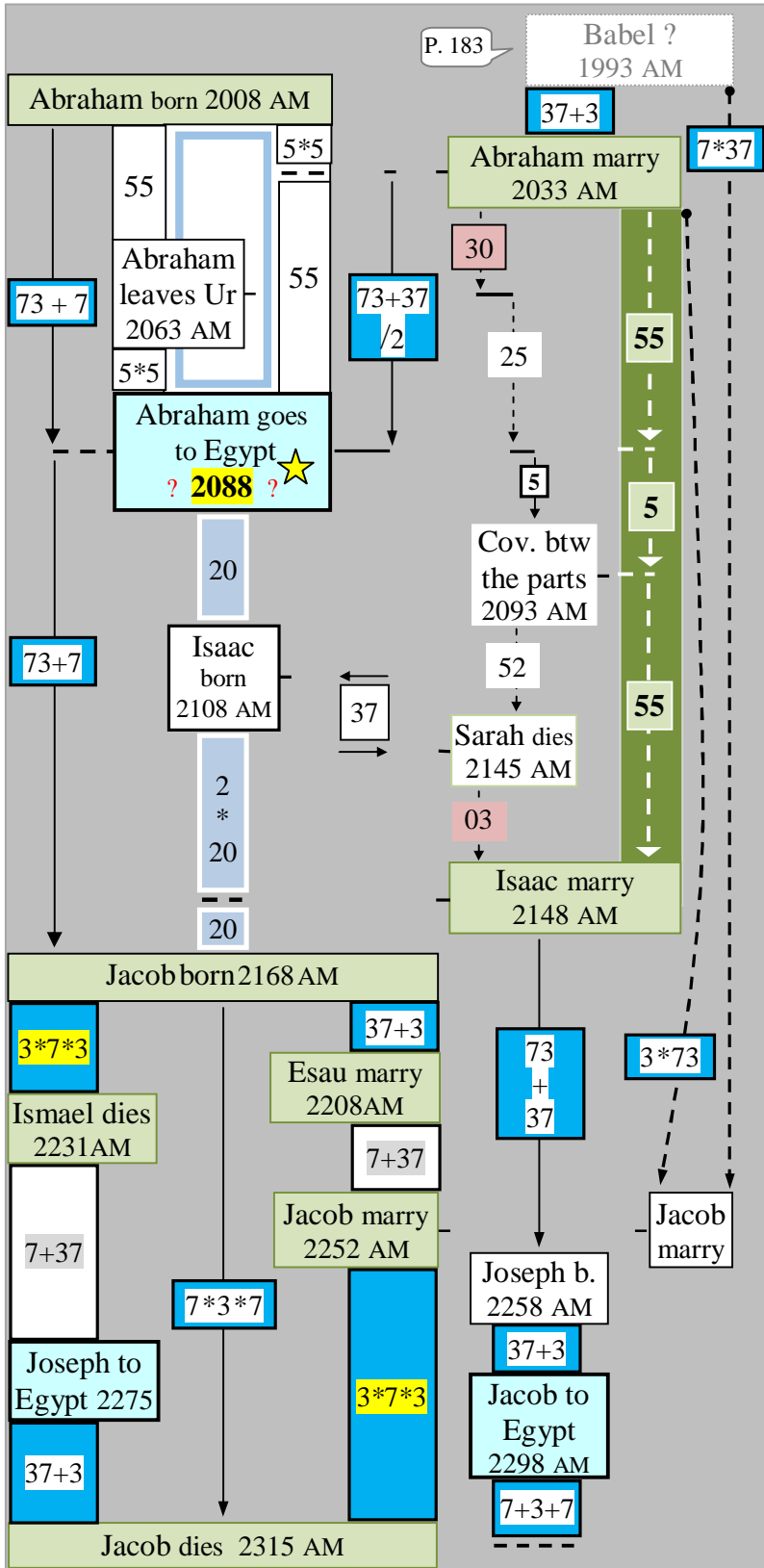

If, as suggested here, Abraham really went to Egypt in **2088 AM**, then one can say the Israelites will symbolically come out of it 3895 years later (2088-5983). Notice how you can reverse **3895** and obtain **5983**, the year of the recall.

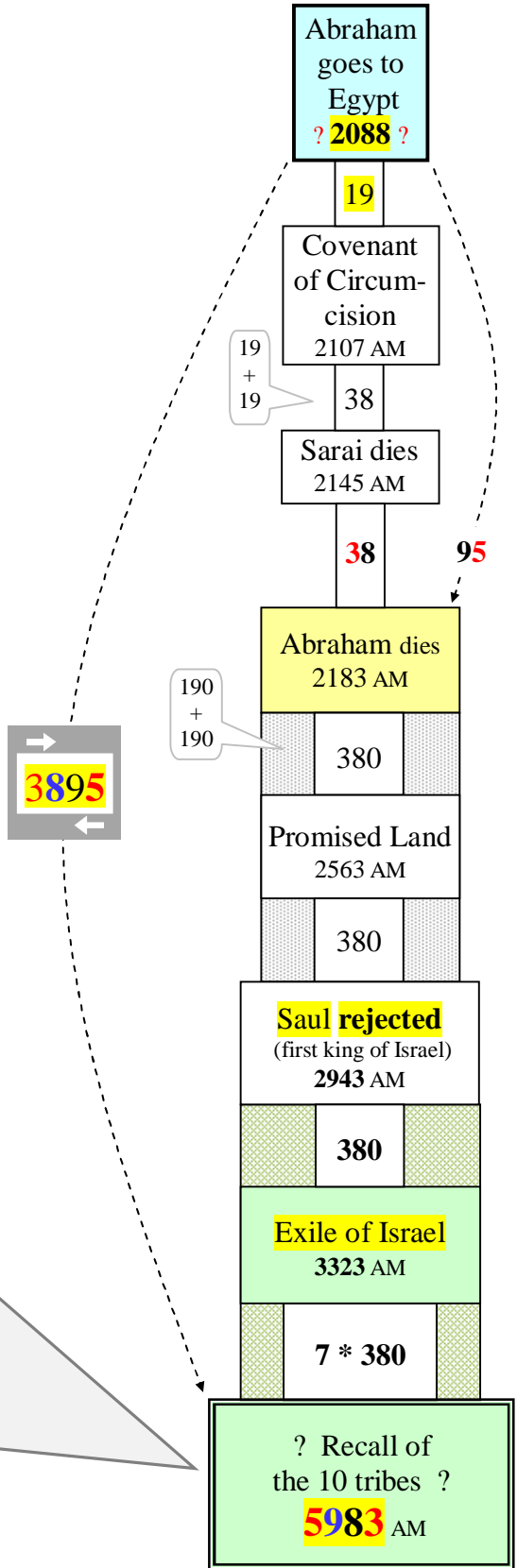

It has not happened so far.

Even today, in spite of a massive return to Israel, Jews can still be found all over the world. Why should it be different for the descendant of the others 10 tribes. There is absolutely no reason to believe that the Lost Israelites are already occupying the land of their ancestors.

Unless Ezek 36:24 has been misinterpreted,

Ezek 36:24 "For I will take you out of the nations; I will gather you from all the countries and bring you back into your own land. NIV

A change greater than Exodus will occur (or will be initiated in some ways) **in 5983 AM.**

A very attractive supposition

Part 2: Figuring out Babel's timing

To the previous sequence of events associated with the Sin of Israel, let's graft a **second 95 years** segment by postulating that the scattering at Babel took place in 1993 AM.

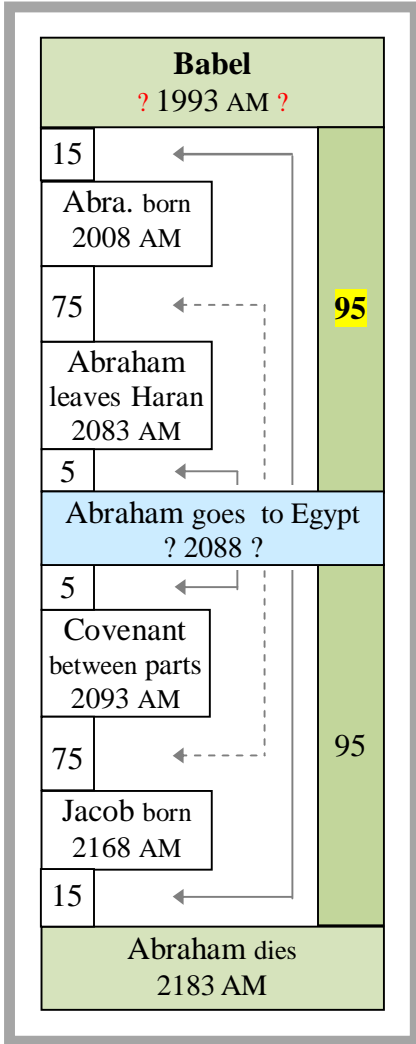

On the right side there are 7 events separated in time by either 380 years, one of its multiples (7*380) or one of its divisors (95). Notice that the sequence starts when God sent the people **all over the earth** (at Babel) and ends when He will recall the 10 tribes of Israel to bring them back from their **all over the earth** exile.

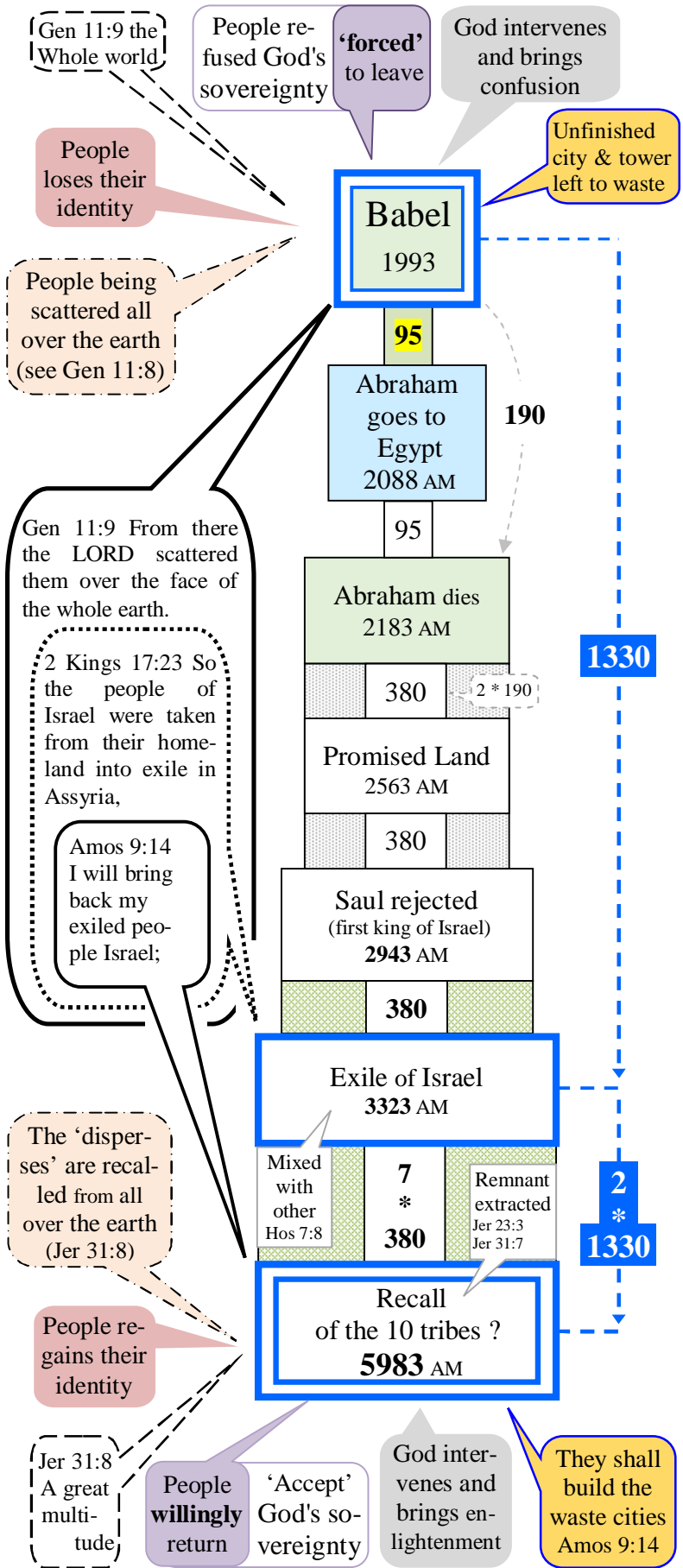

➔ From Babel to Daniel's 70th week

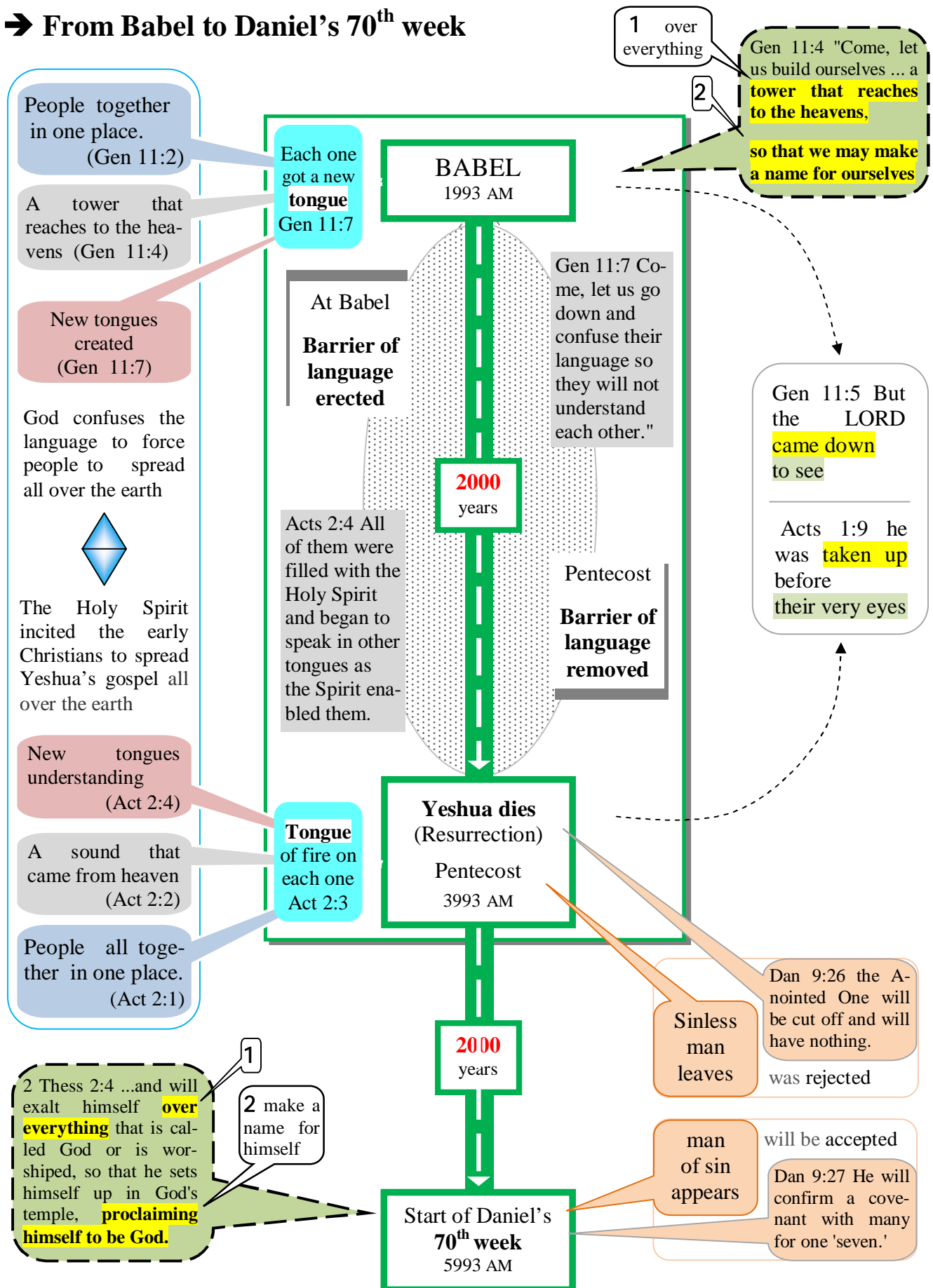

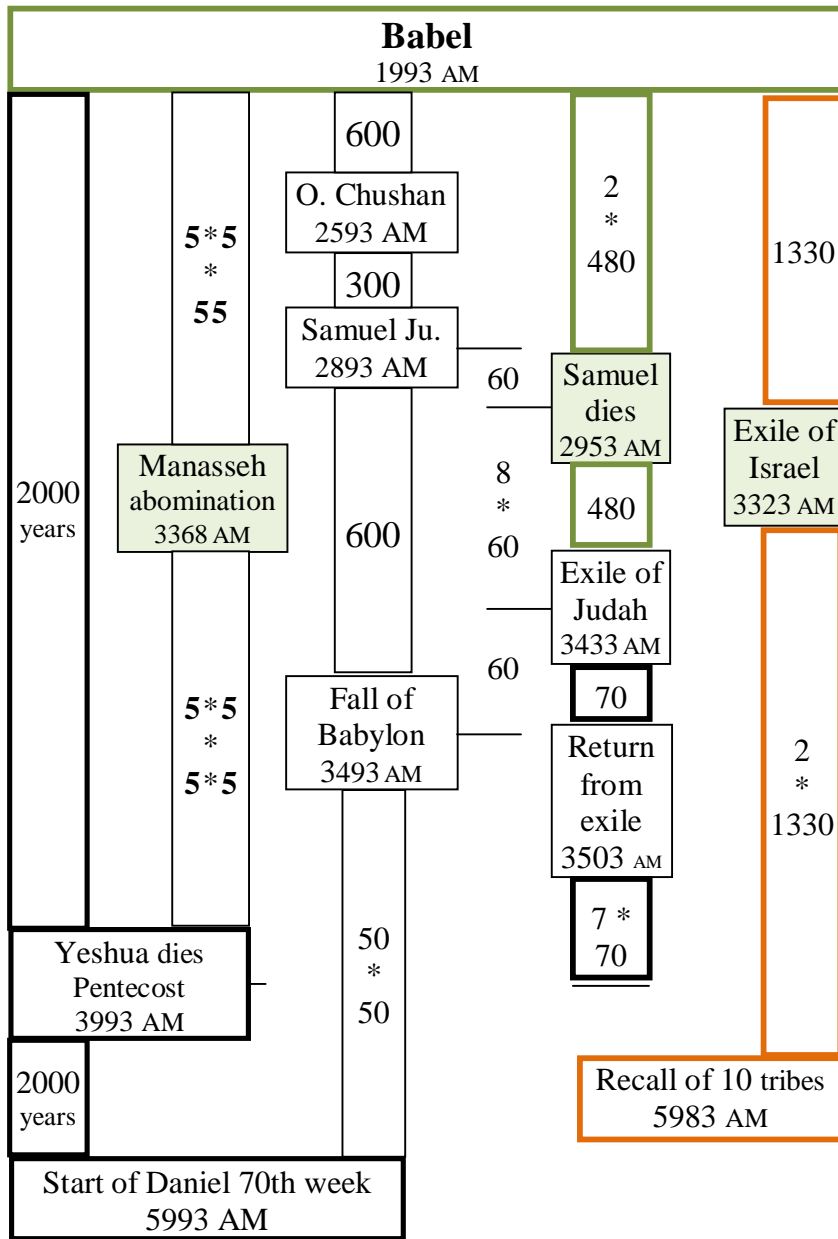

Here is some information kindly supplied by my very knowledgeable friend Noel Rude on the connection between Babel, the exile of Israel, and Pentecost

The rabbis noticed a play on words (with the Hebrew בָּלַל *bālal*) connecting the confusion at Babel with the mingling of Ephraim (and his fellows) with the nations.

Genesis 11:9 Therefore is the name of it called Babel; because the LORD did there confound [בלל/συνέχεεν] the language of all the earth: and from thence did the LORD scatter them abroad upon the face of all the earth.

Hosea 7:8 Ephraim, he hath mixed himself [יִתְבּוֹלֵל] among the people; Ephraim is a cake not turned.

The miracle of Pentecost (3993 AM) **exactly 2000 years** later is linked by verb (συνέχεεν) from the Septuagint:

Acts 2:6 Now when this was noised abroad, the multitude came together, and were confounded [συνεχύθη], because that every man heard them speak in his own language.

Noel Rude says that 1Kings 11:31 connects ten men (ten tribes?) and “all the languages of the nations”:

Also: Zechariah 8:23 Thus saith the LORD of hosts; In those days *it shall come to pass*, that ten men shall take hold out of all languages of the nations, even shall take hold of the skirt of him that is a Jew, saying, We will go with you: for we have heard *that God is with you*.

BABEL

People wanted to make a **name** for themselves. God **confused** their **language**. And He **scattered** them **over the world**.

This ended up in an exile involving the whole world.

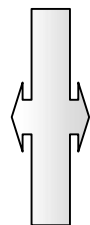

RECALL of the Northern Ten Tribes

The Lost tribes have become many nations speaking many **languages**. God will remove the **confusion** about their **identity**. And God will **gather** them **from all around**. Eze 37:21

The whole world will witness the lost tribes being recall from exile.

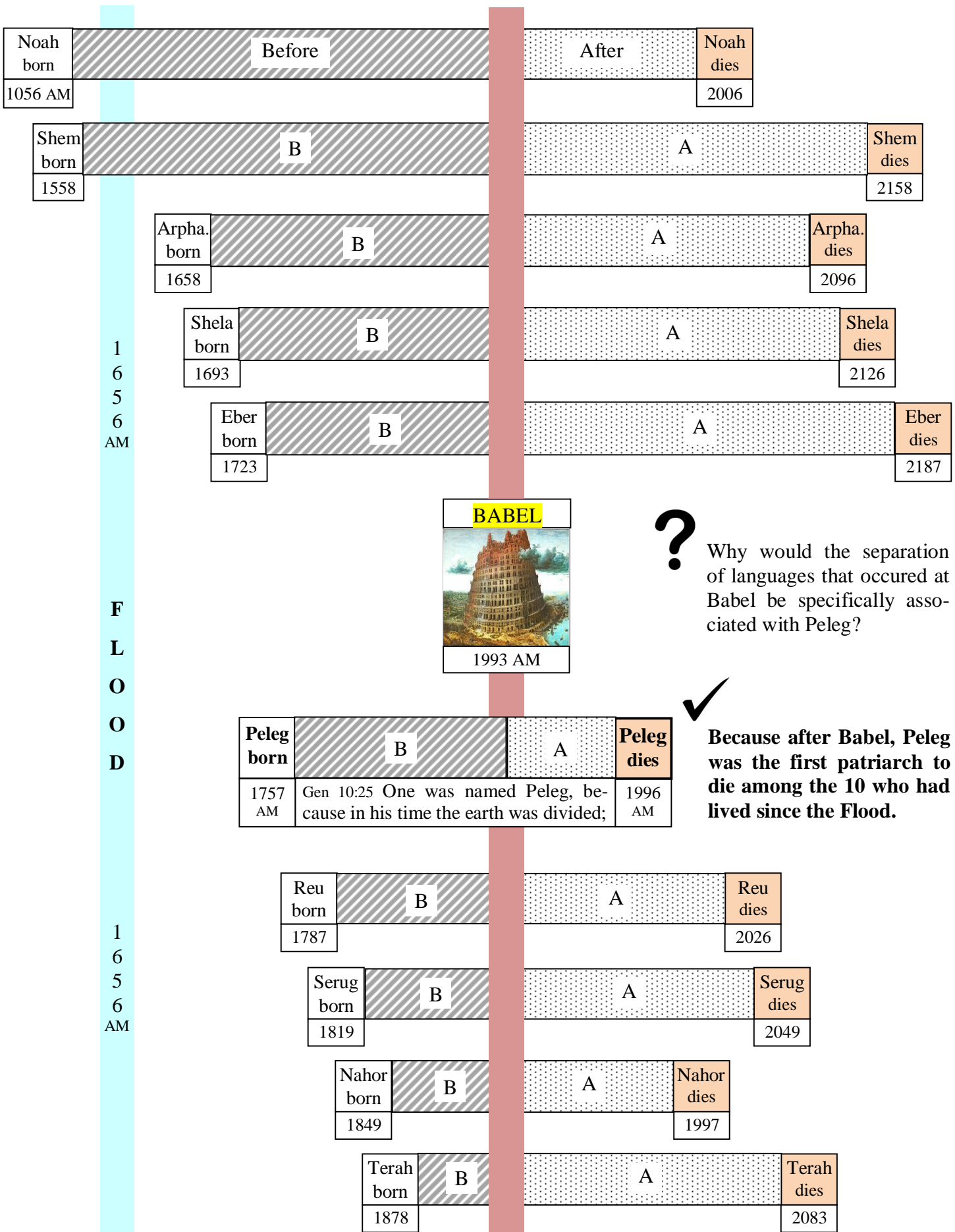

1
6
5
6
AM

F
L
O
O
D

1
6
5
6
AM

? Why would the separation of languages that occurred at Babel be specifically associated with Peleg?

✓ Because after Babel, Peleg was the first patriarch to die among the 10 who had lived since the Flood.

❖ A fitting timeline for Samson ❖

The present chart shows that Samson lived his whole life during the Philistines' oppression.

Judg 13:5 ...set apart to God from birth, and he will begin the deliverance of Israel from the hands of the Philistines.

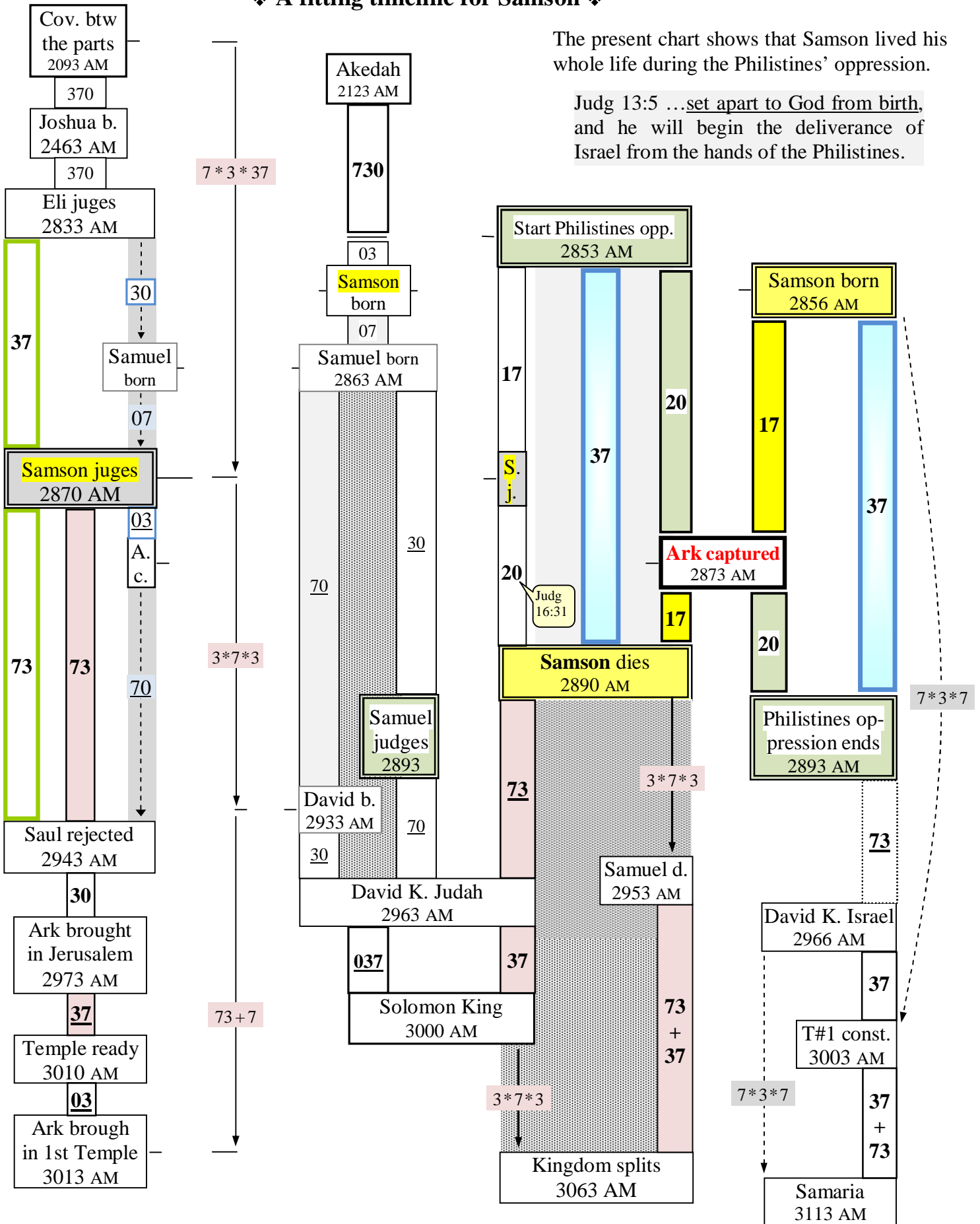

See chart 25 on p. 214 for more

➔ Was Solomon 17 years old when he became king? Yes.

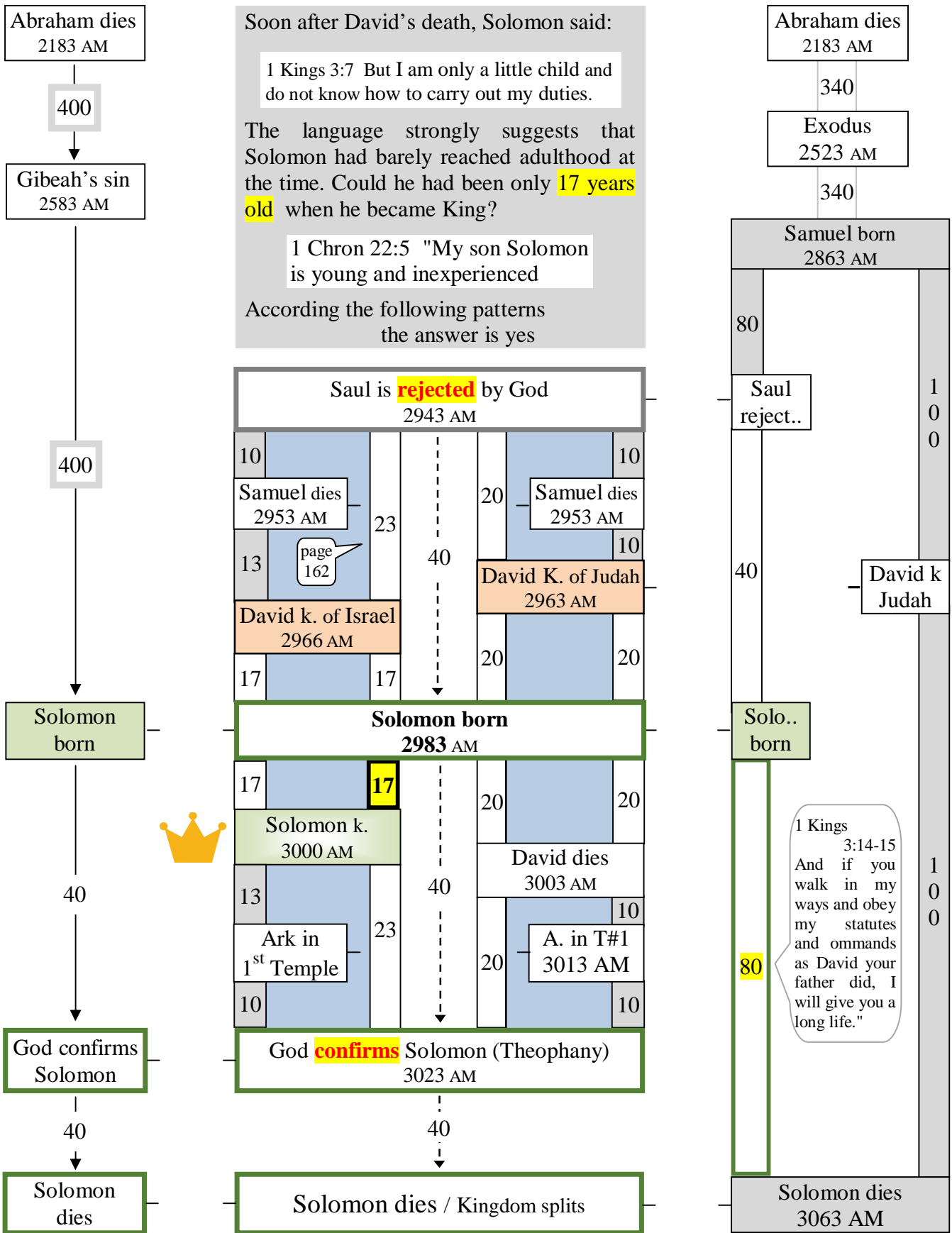

The Bible timeline unsealed in 28 charts

The following set of charts highlights the extreme variety of patterns obtained when the chronology of the biblical events is rightly understood.

It will become quite obvious after seeing the first few charts that most of the events are not



restricted to the design of a single pattern but are part of an elaborate network of them.

It will also be obvious that these events needed to be judiciously setted to occur at the right time in order to allow the emergence of so many stunning patterns.

The open mind christians will agree with me

No human architect could have conceived a system with such complexity while integrating more than one hundred events whose occurrence spanned a period of six thousand years.

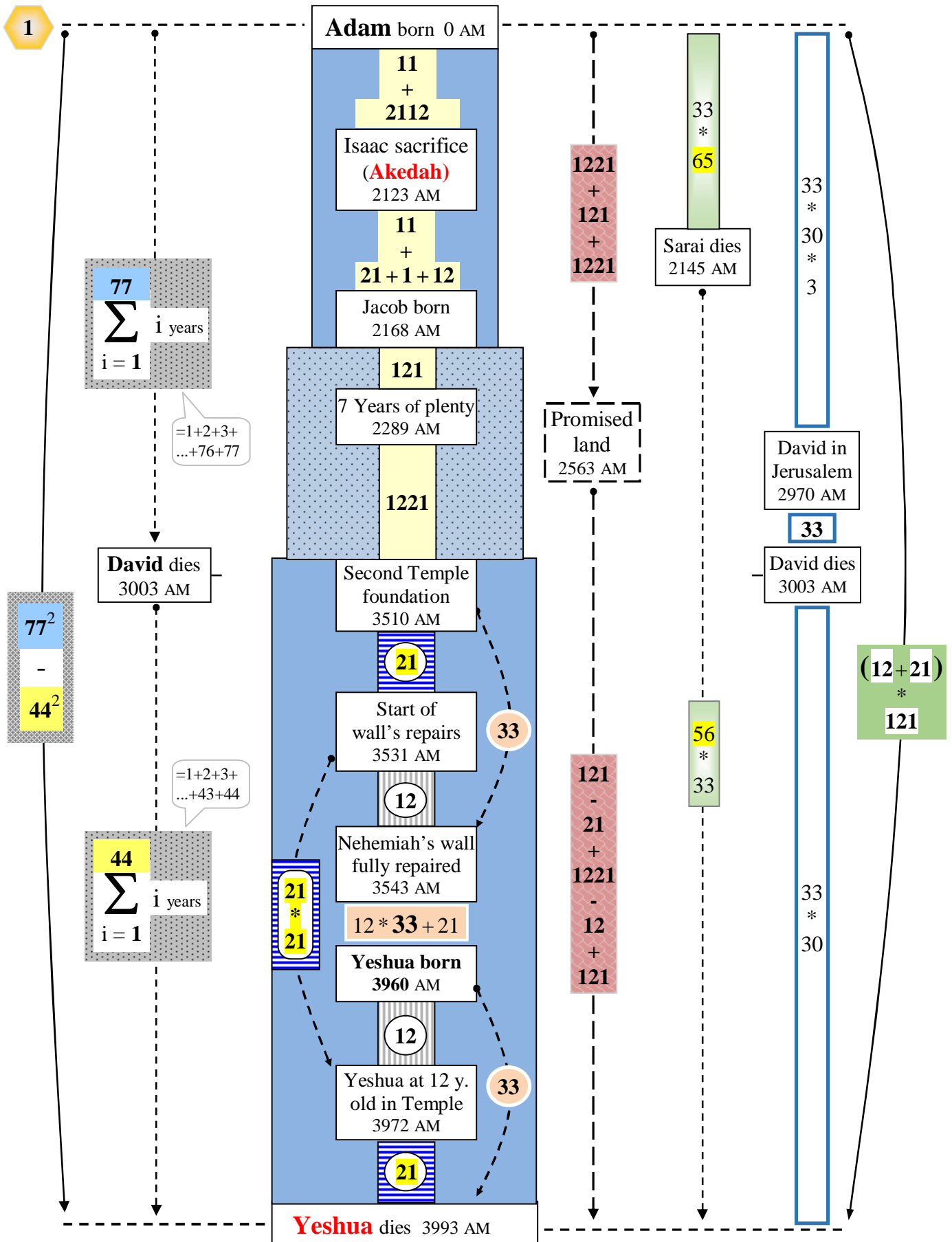

4

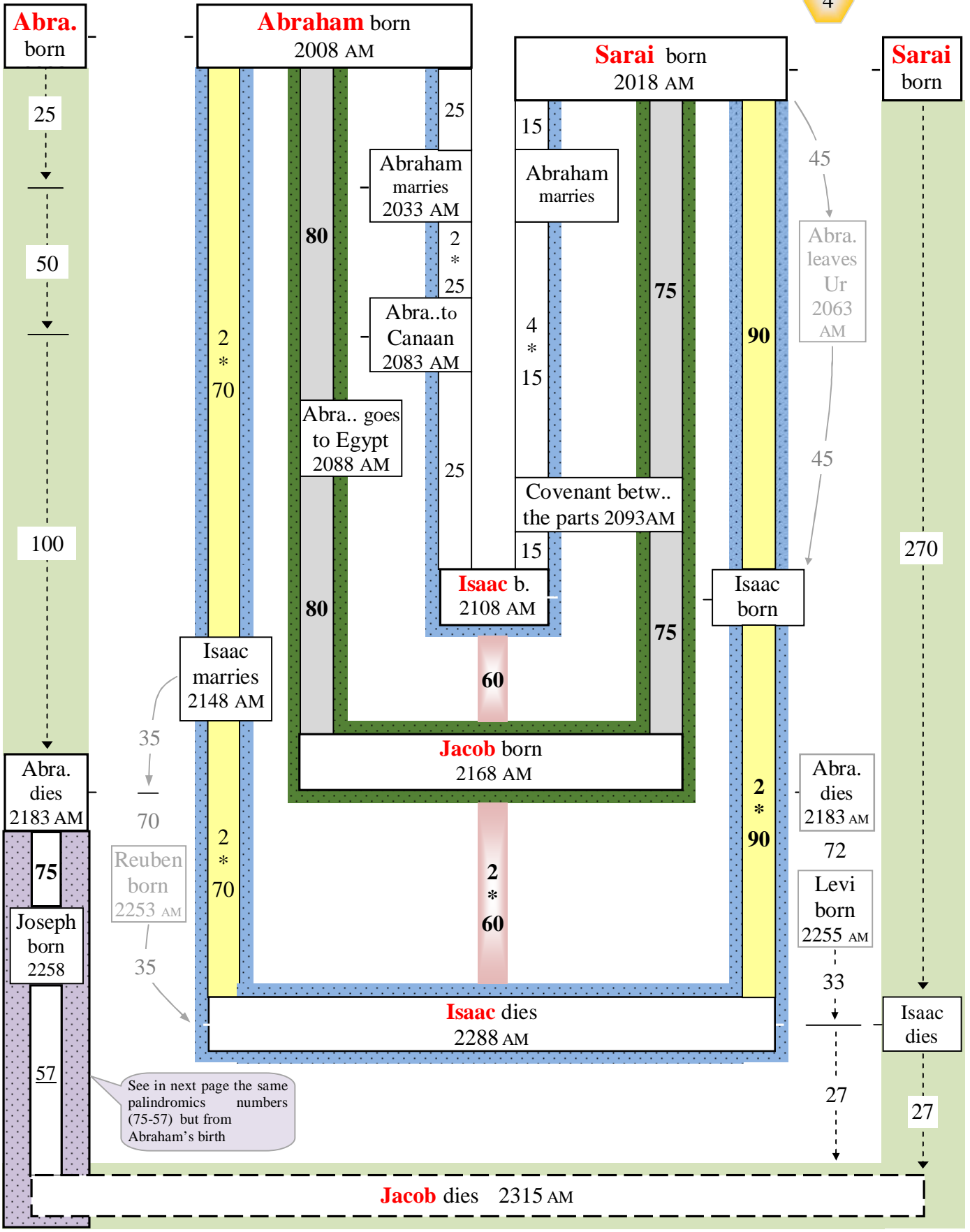

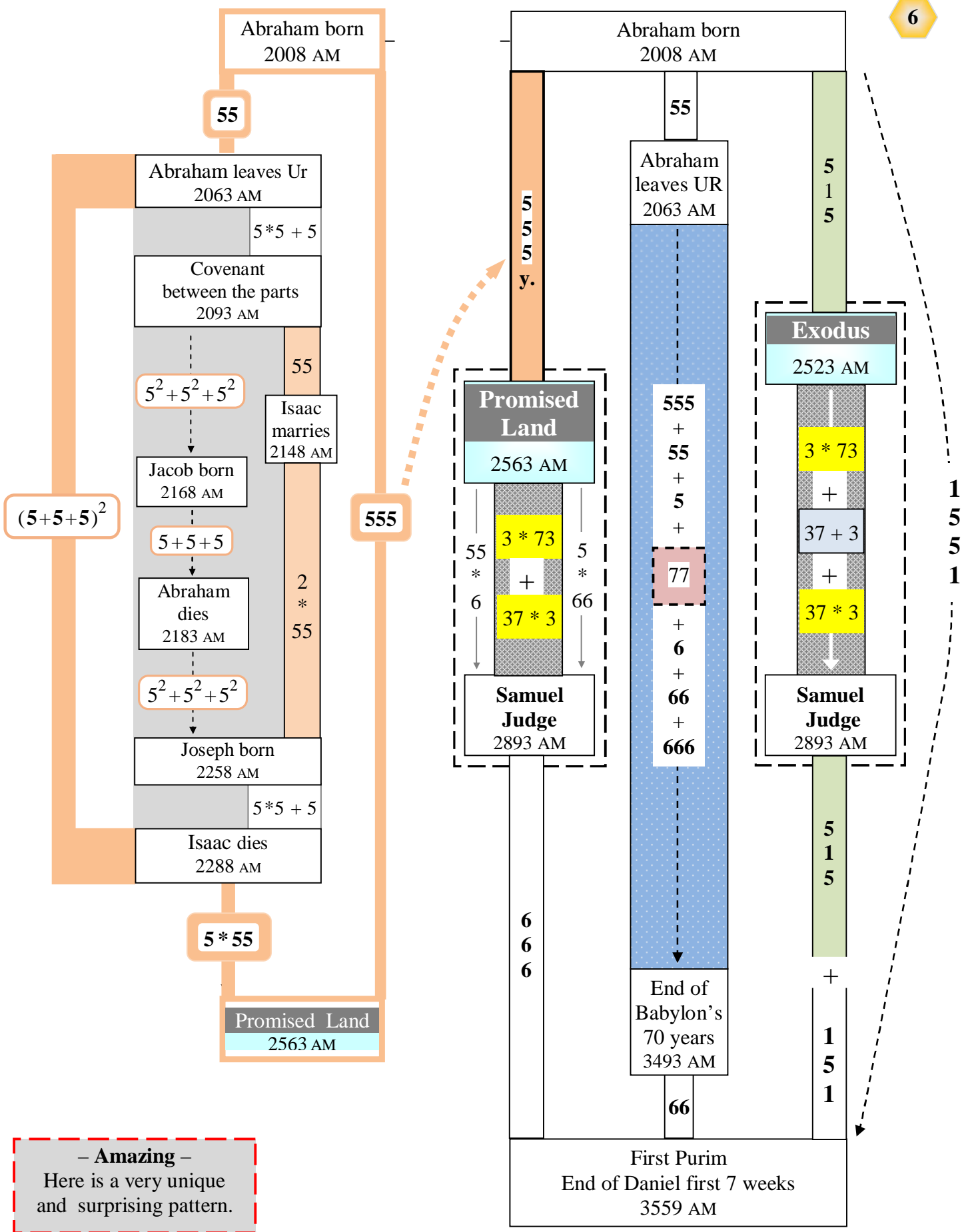

– Amazing –
Here is a very unique and surprising pattern.

Abram marries

2033 AM

7

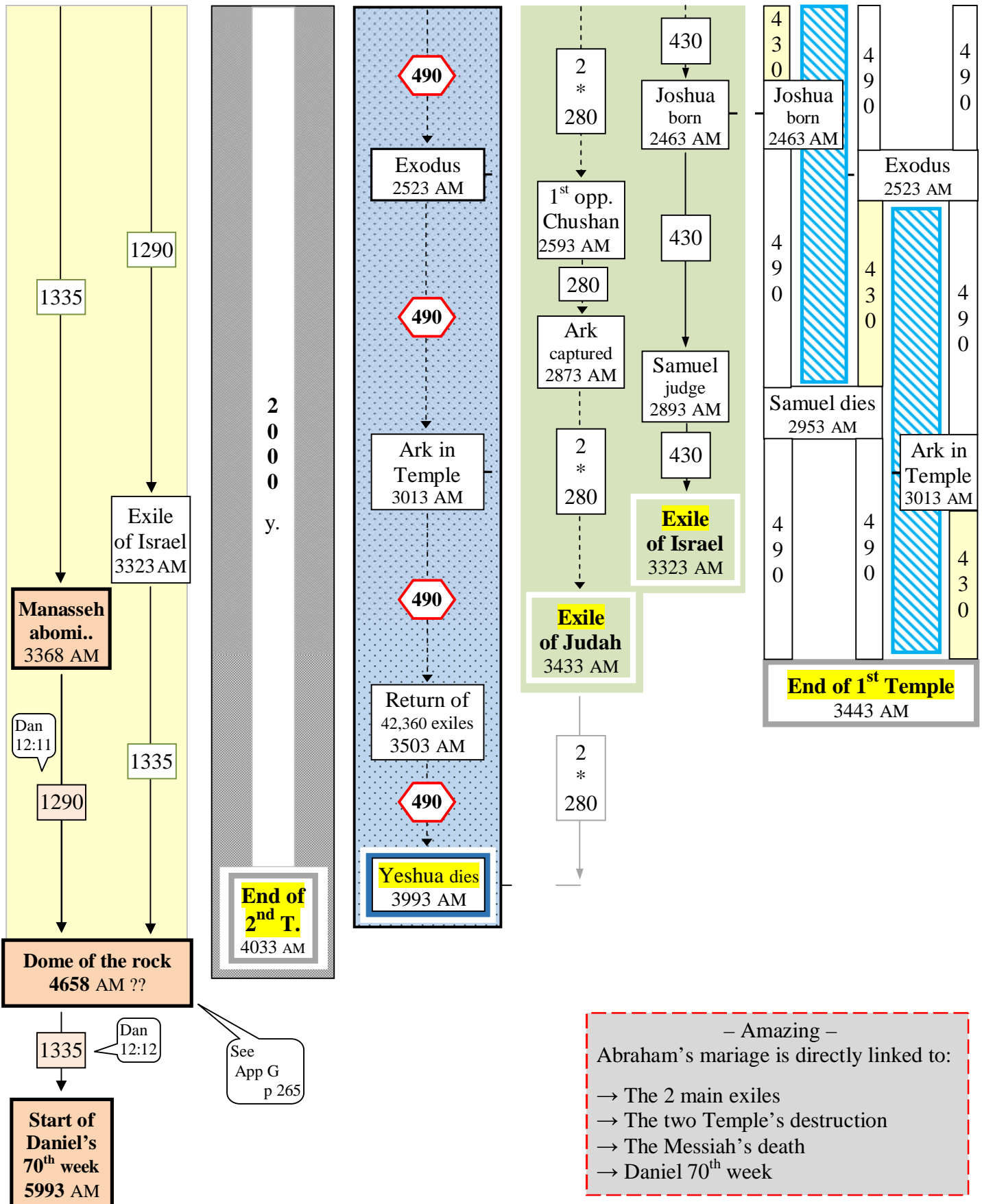

See App G p 265

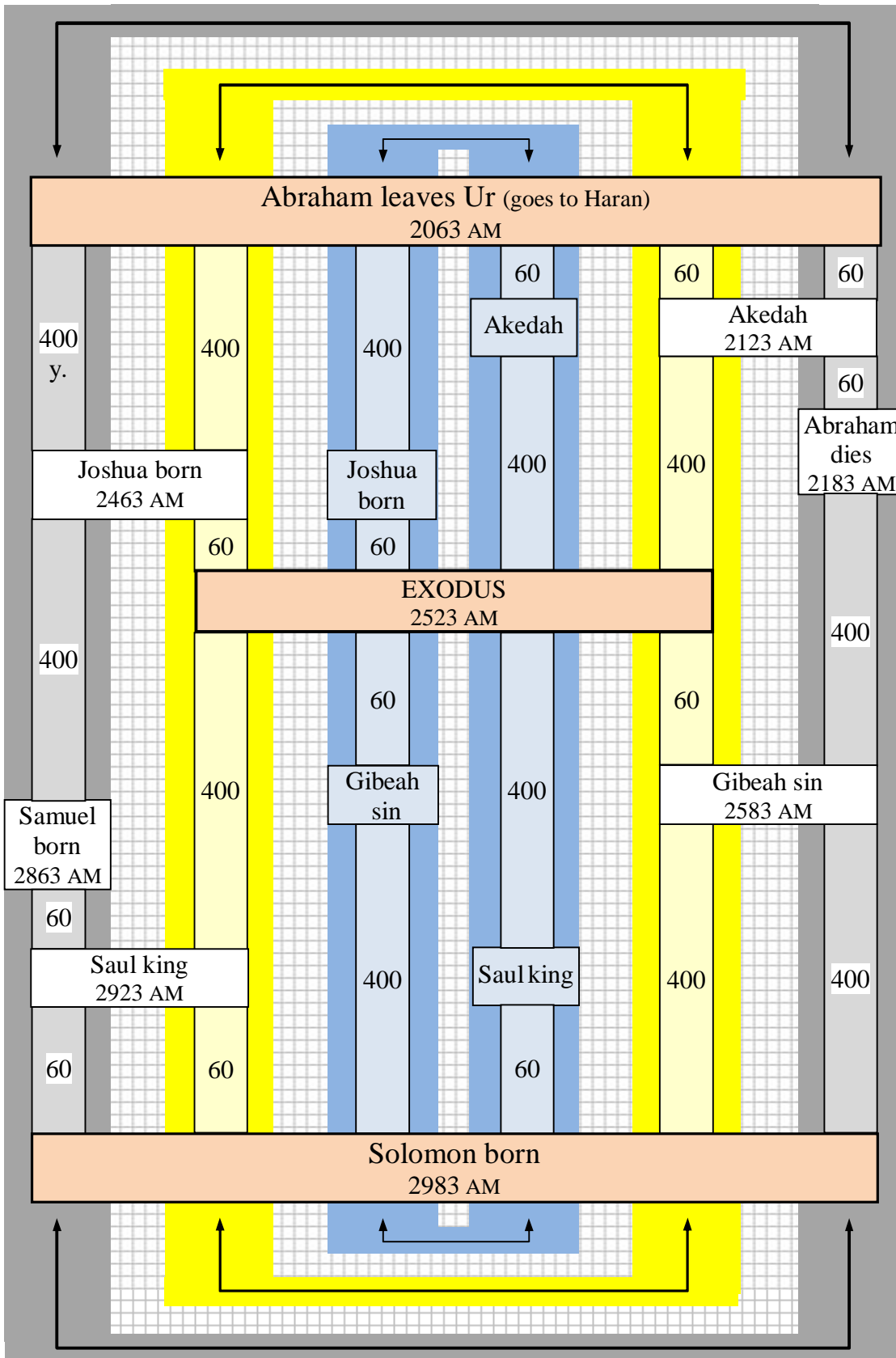

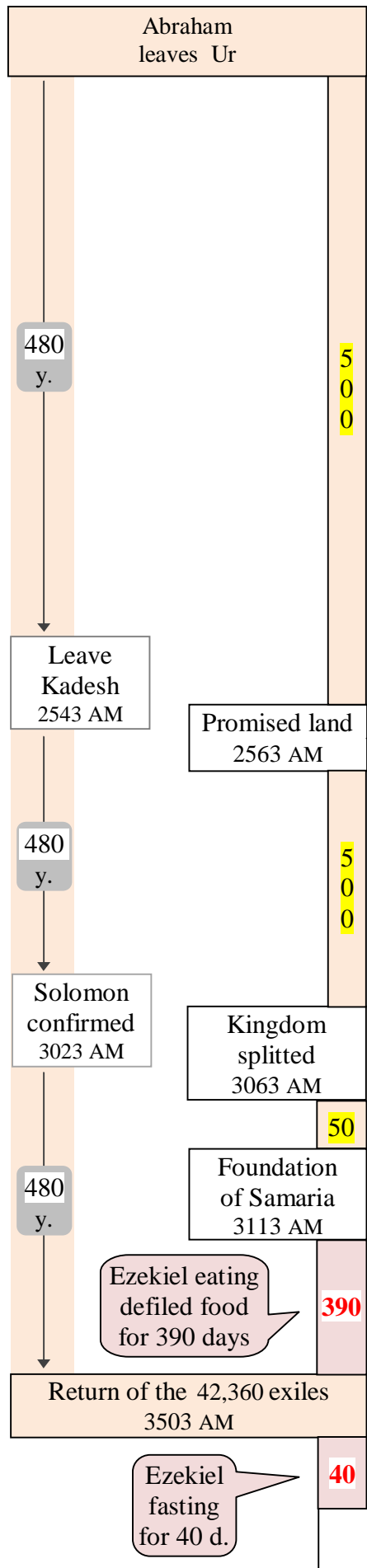

9

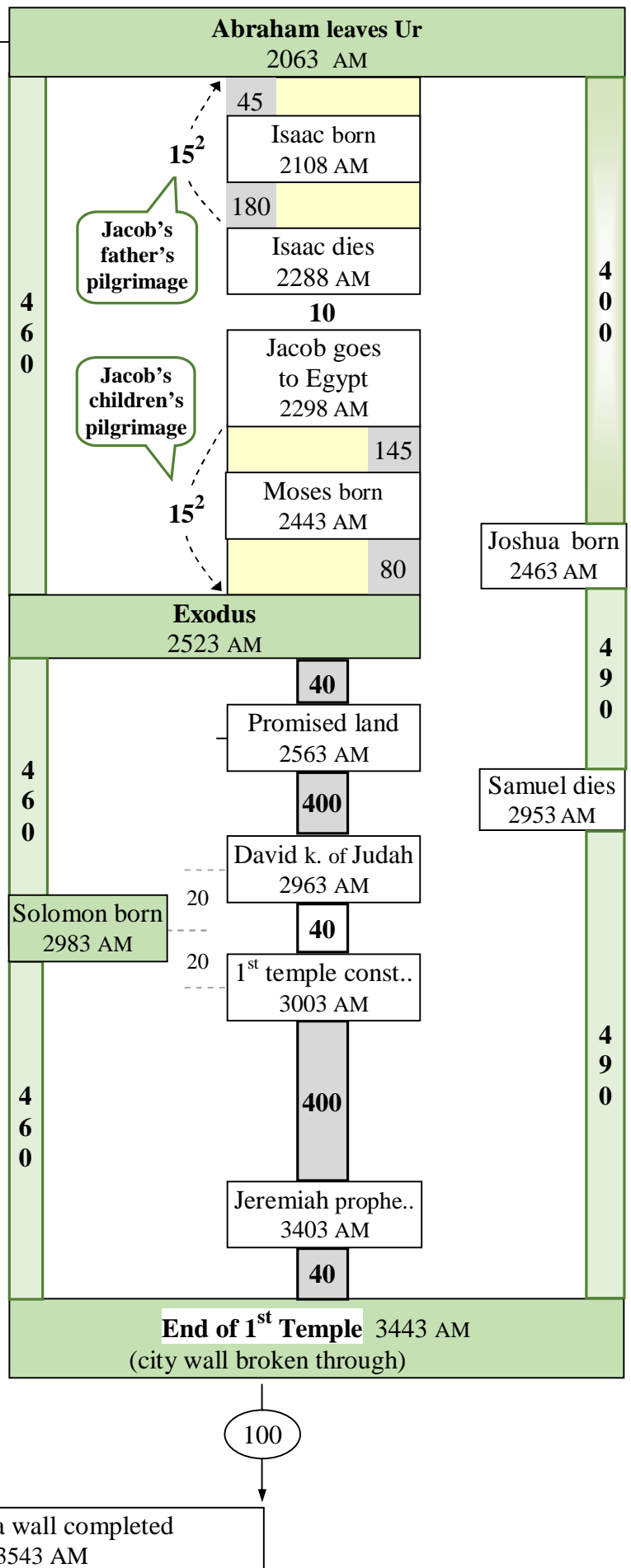

10

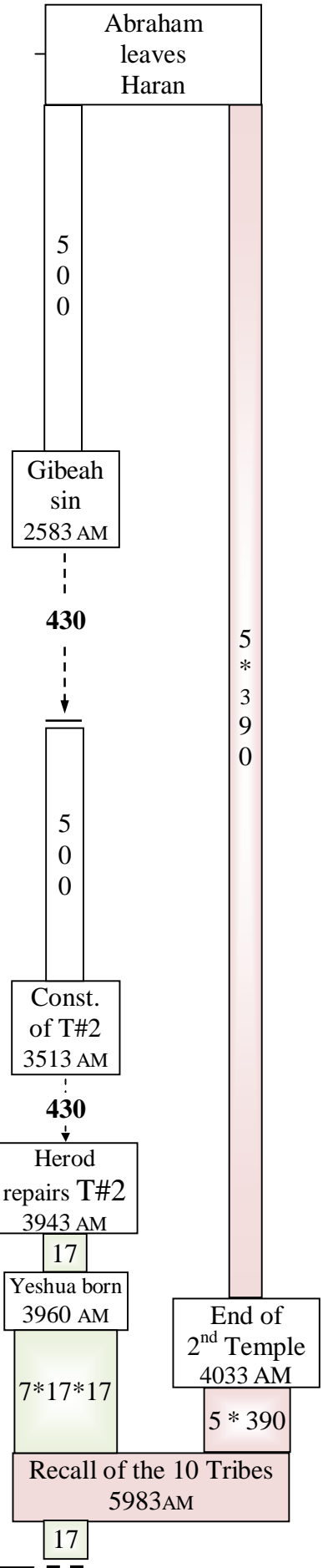
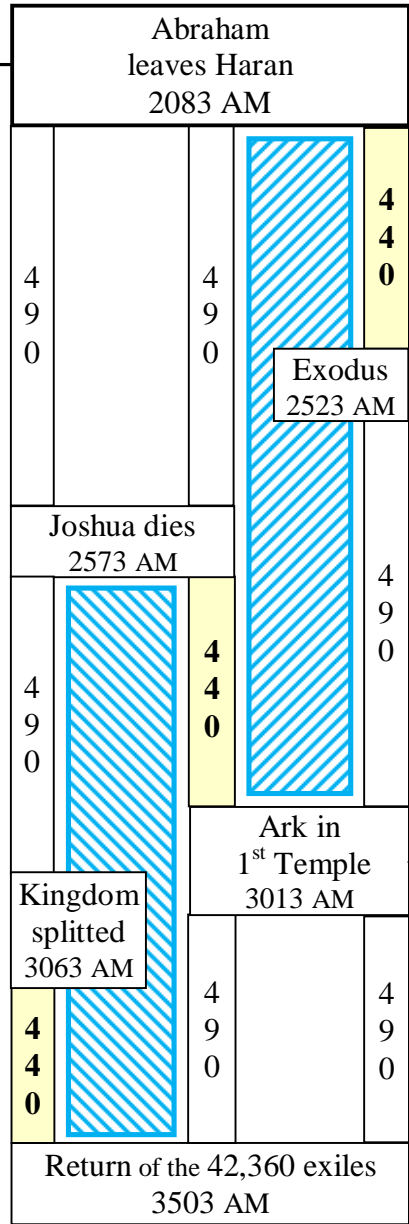
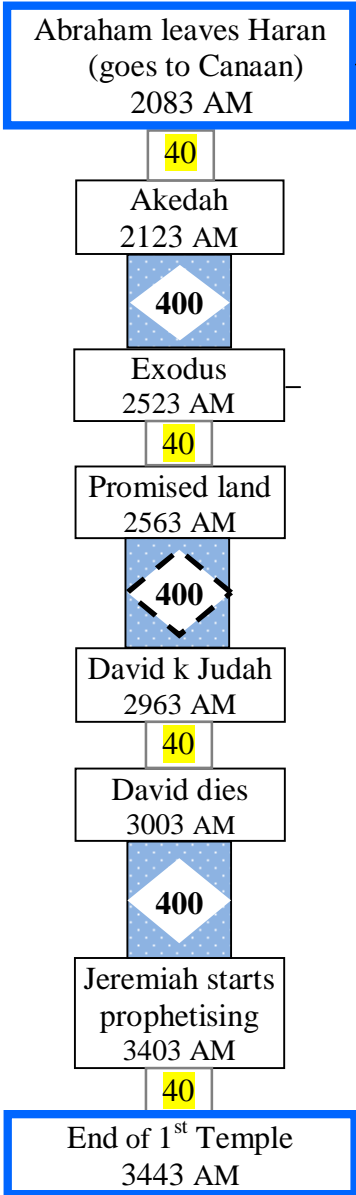

7th Millenium 6000 AM

Covenant between the parts

2093 AM

12

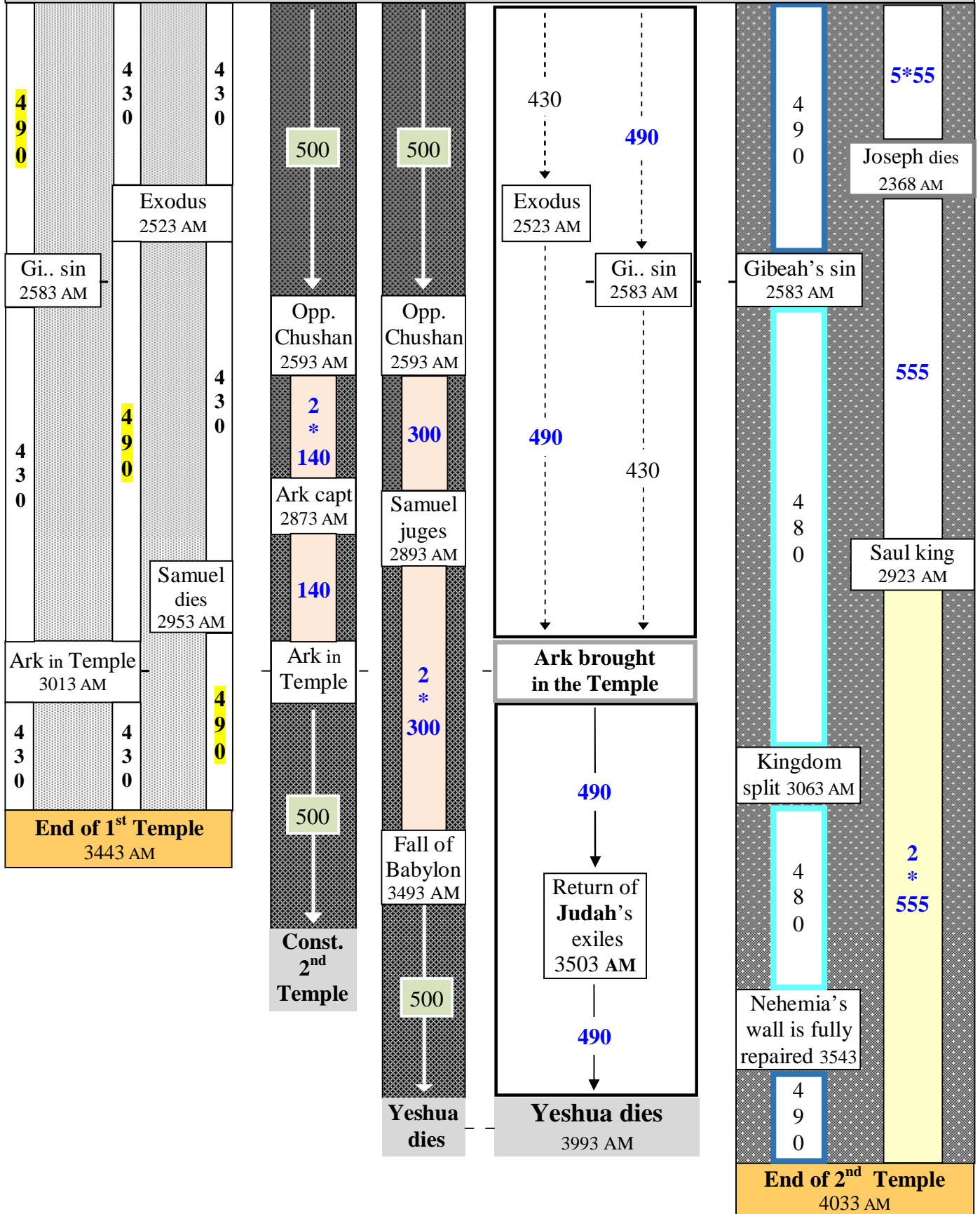

AMAZING PALINDROMES

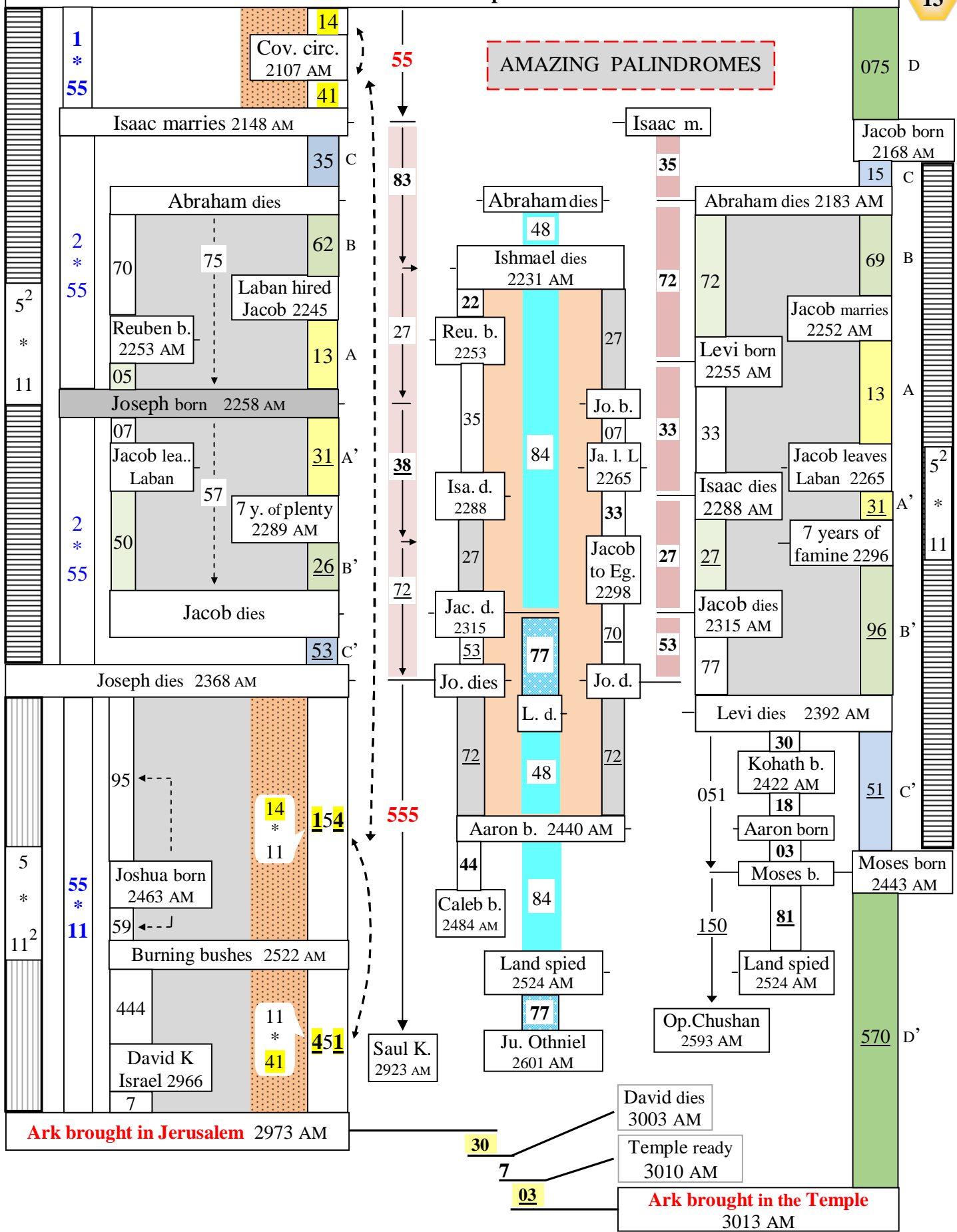

Symmetry & Palindromes

14

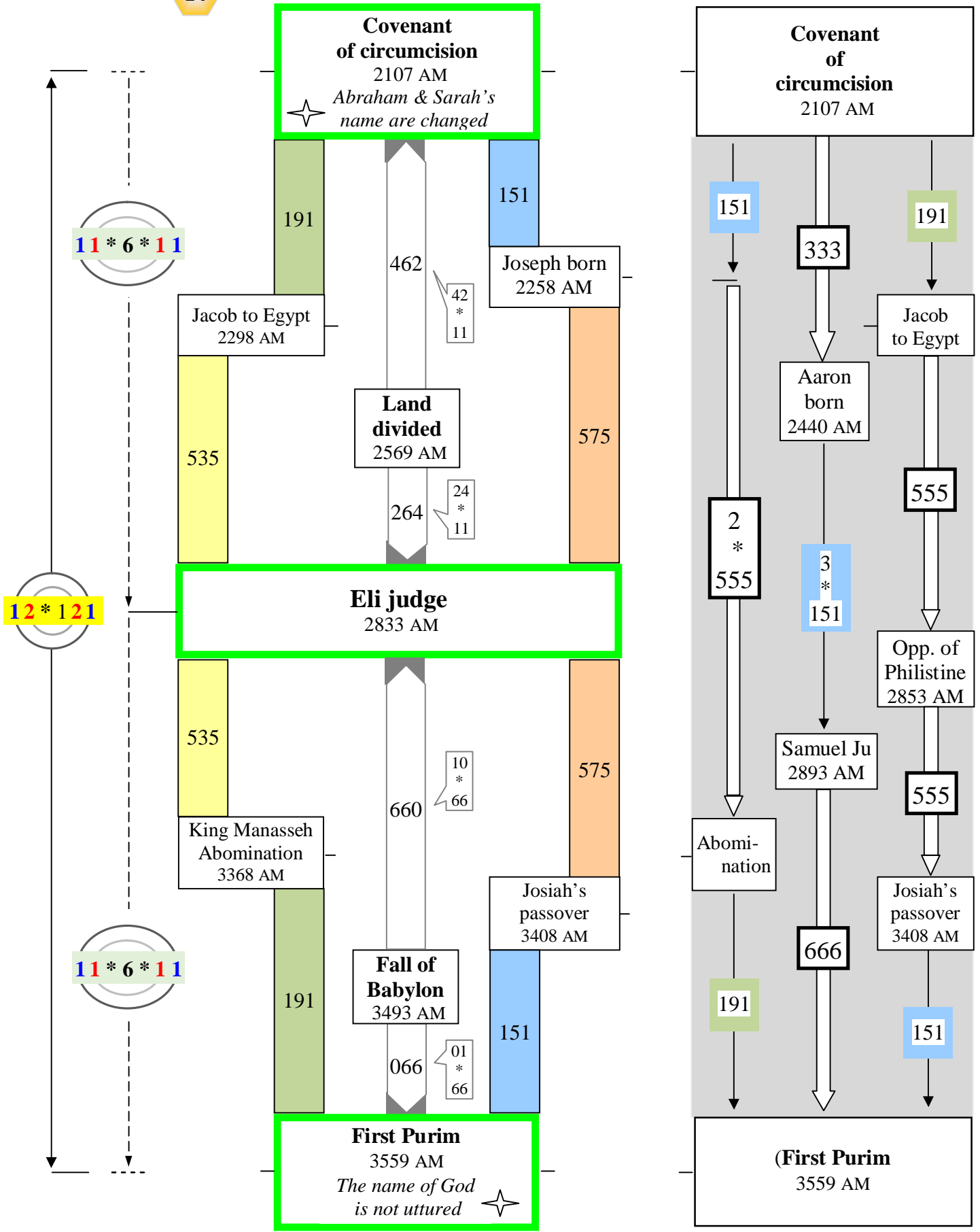

15 Binding of Isaac (AKEDAH) 2123 AM

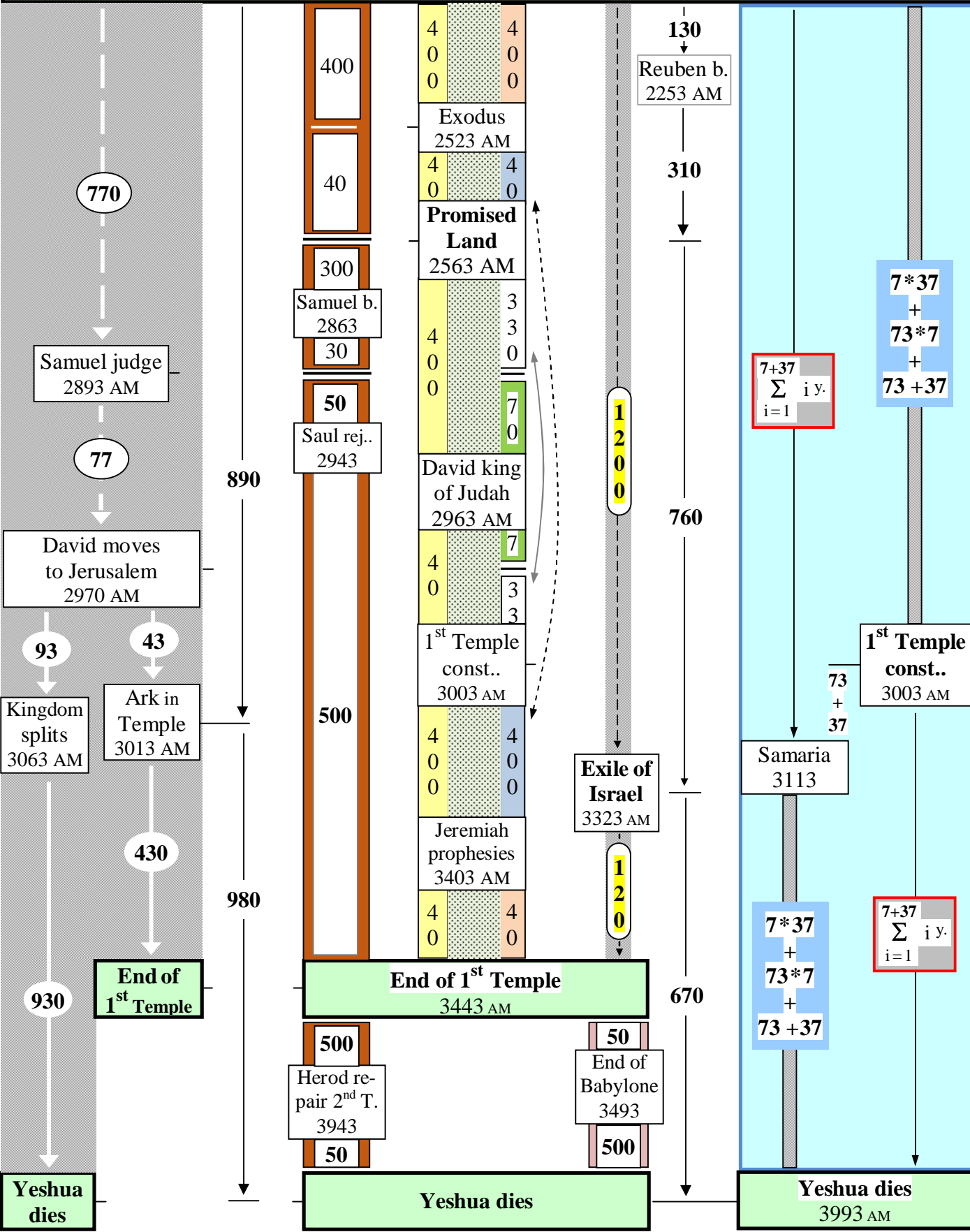

AKEDAH

Binding of Isaac 2123 AM

(a ram "with head in a thicket of thorns" replaced a man)

Two servants were involved Gen 22:3,6
 Angel called from heaven Abraham, Abraham Gen 22:11

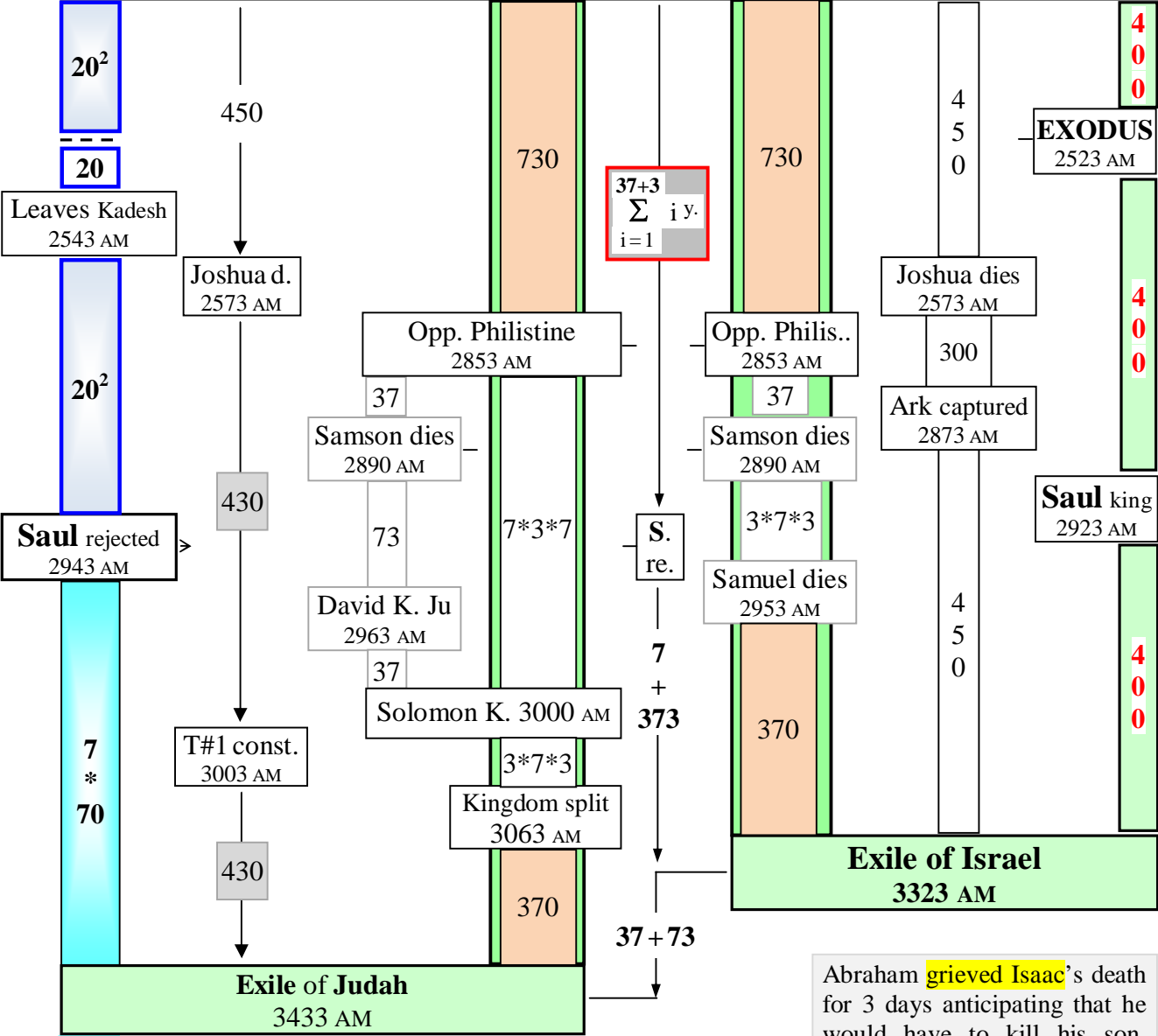

Return of the 42,360 exiles 3503 AM

7 * 70

Yeshua dies
 (a man with a crown of thorns on his head, replaced the Passover's LAMB) 3993 AM

Two robbers were involved Matt 27:38

At the last instant, Jesus cried out to heaven, My God, my God Mark 15:34

Abraham grieved Isaac's death for 3 days anticipating that he would have to kill his son. Grieving suddenly ends

During their sacrifice, Isaac and Yeshua were bound to the wood they had carried on their back. **Isaac was chosen 4 days before akedah.** See Gen 22:3-4 'early the next.. + on the 3rd day' = 4 day
 Yeshua the 'passover lamb' was chosen 4 days before the cross.
Both came to Jerusalem on a donkey and they were both sacrificed on Moriah. Gen 22:2 | 2 Chr 3:1

The apostles grieved Yeshua's death for 3 days because they didn't believe he would resurrect. Grieving suddenly ends

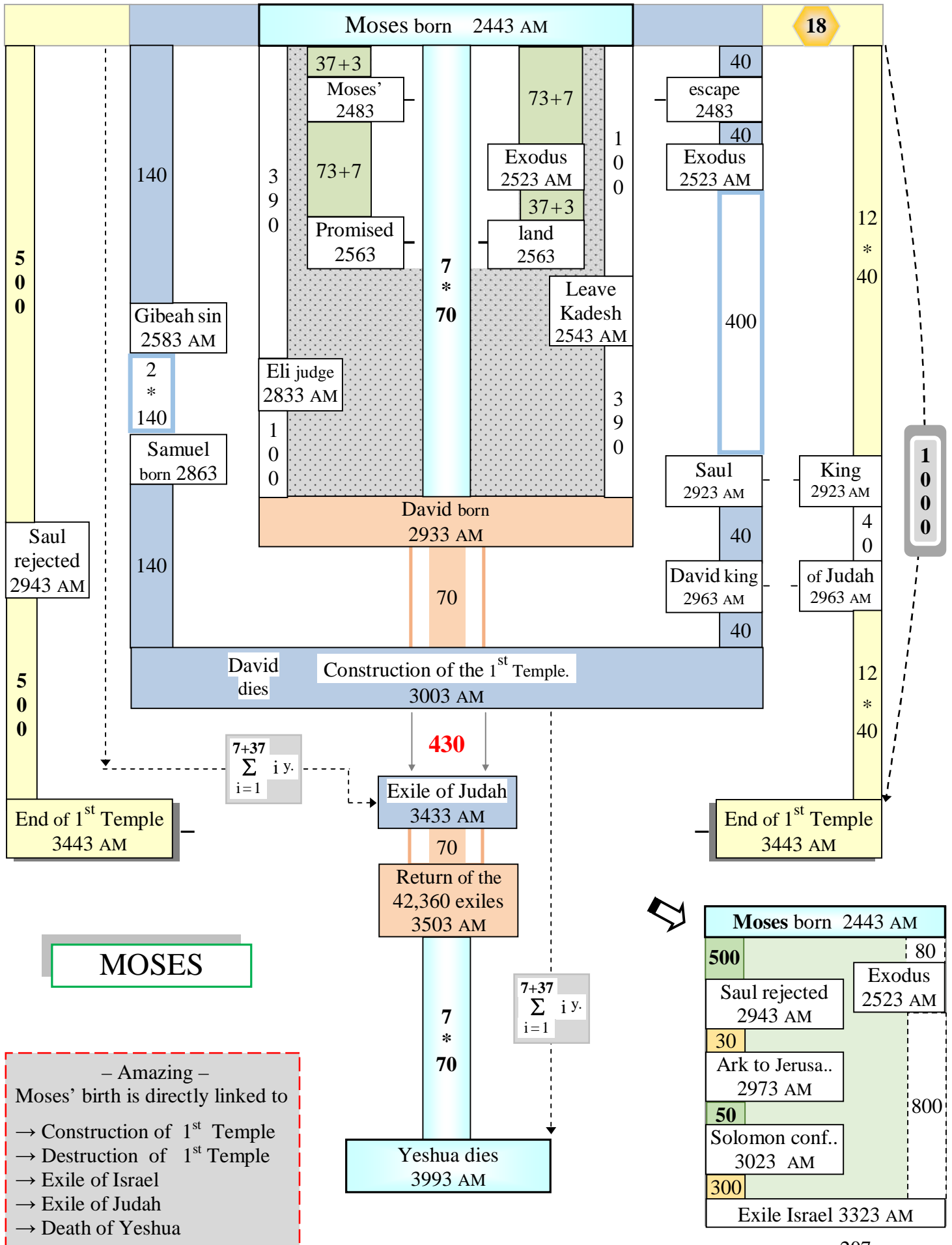

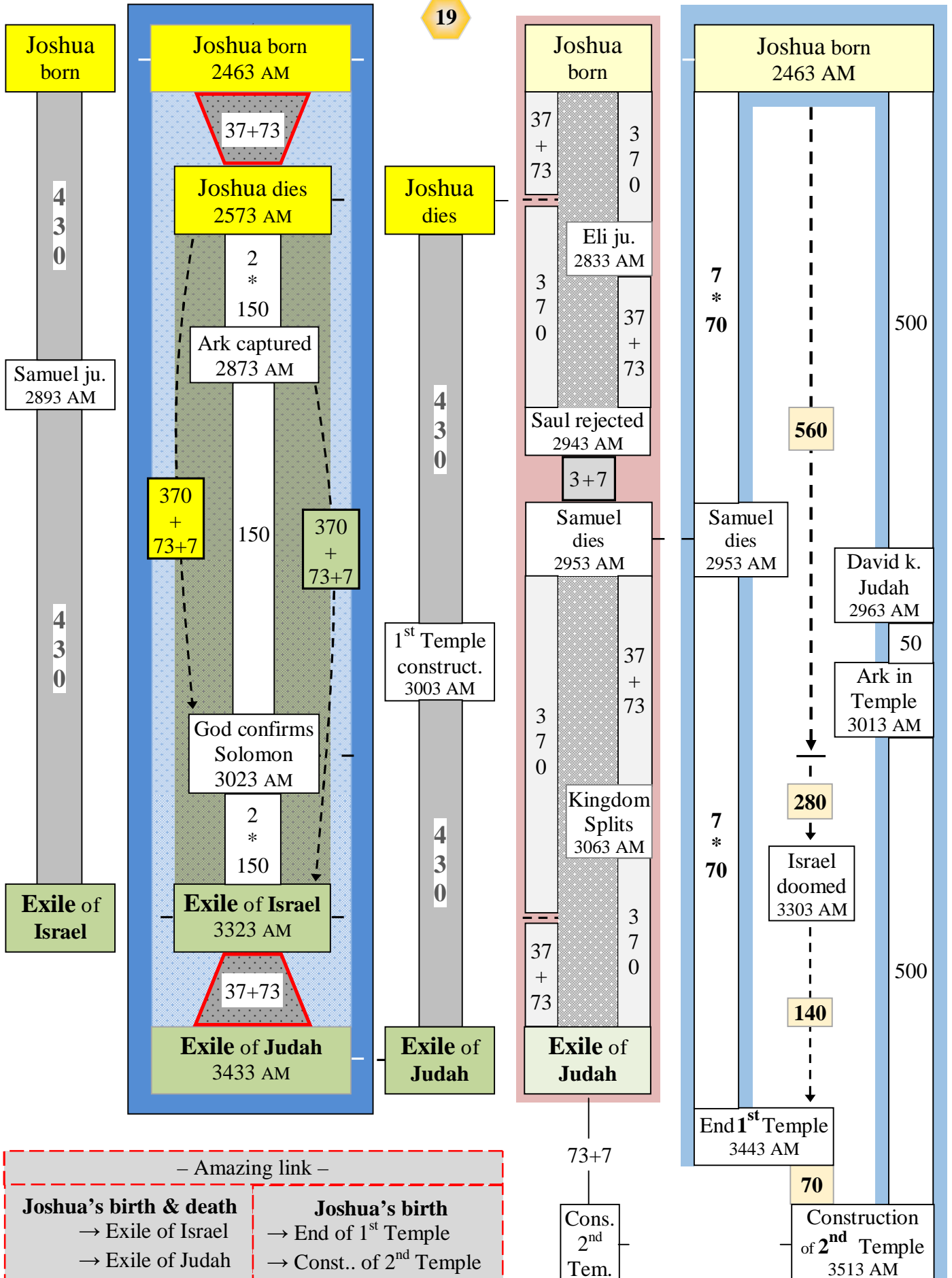

- Amazing link -

Joshua's birth & death

- Exile of Israel
- Exile of Judah

Joshua's birth

- End of 1st Temple
- Const.. of 2nd Temple

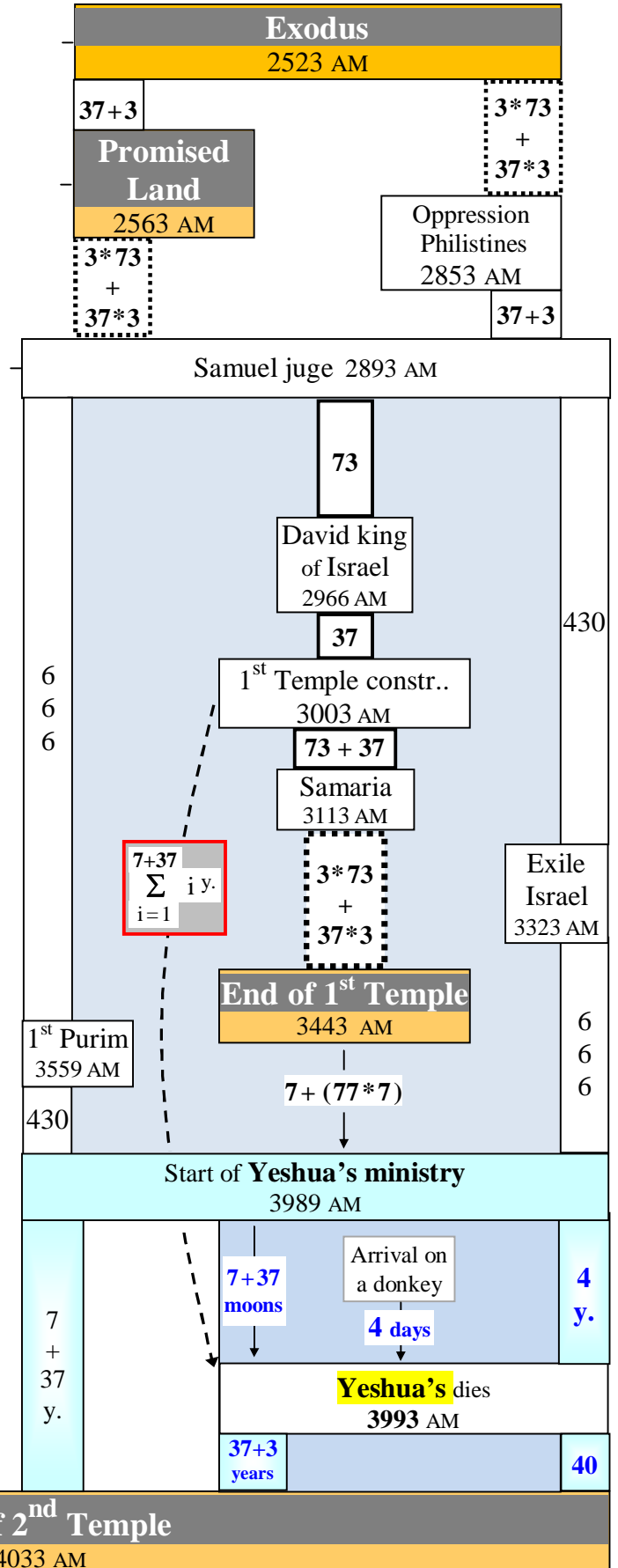
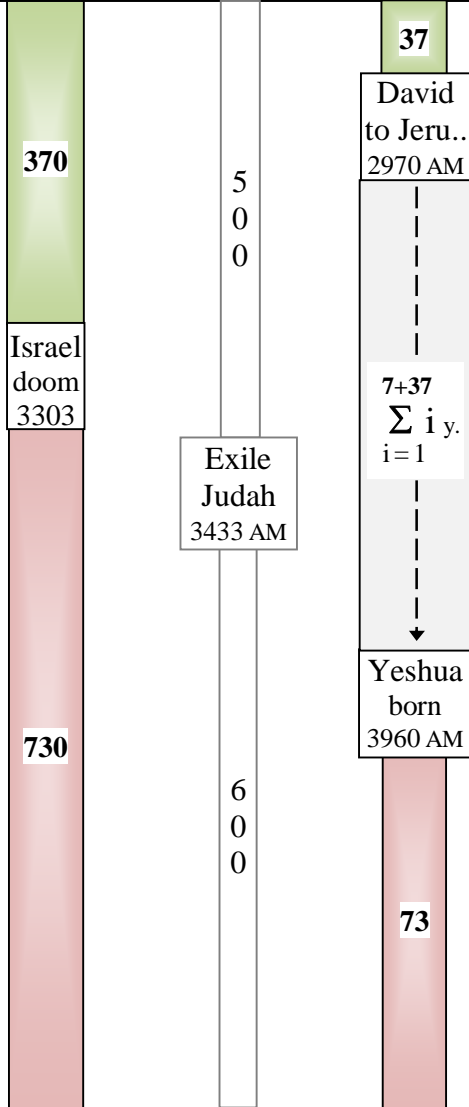
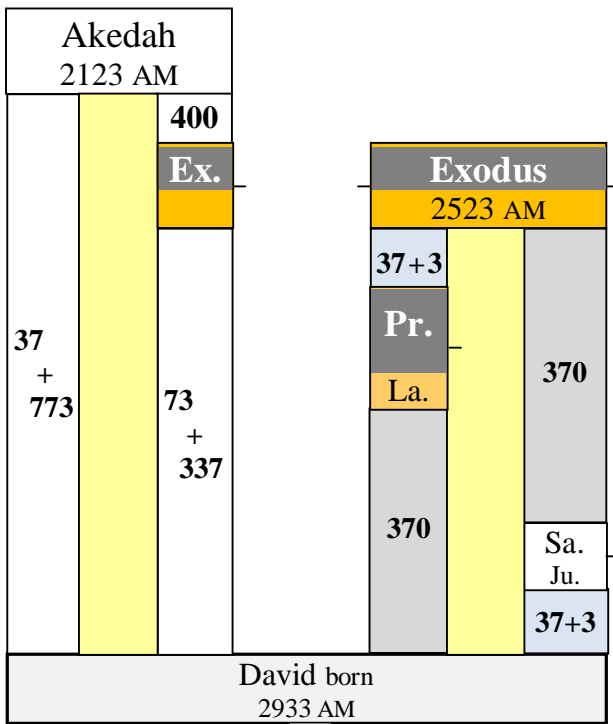

EXODUS & PROMIDED LAND

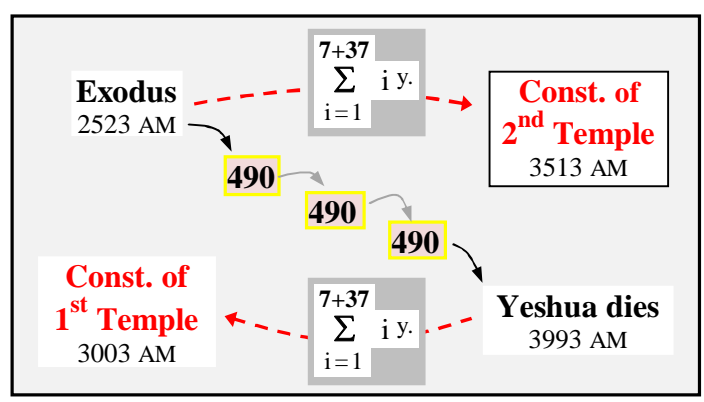
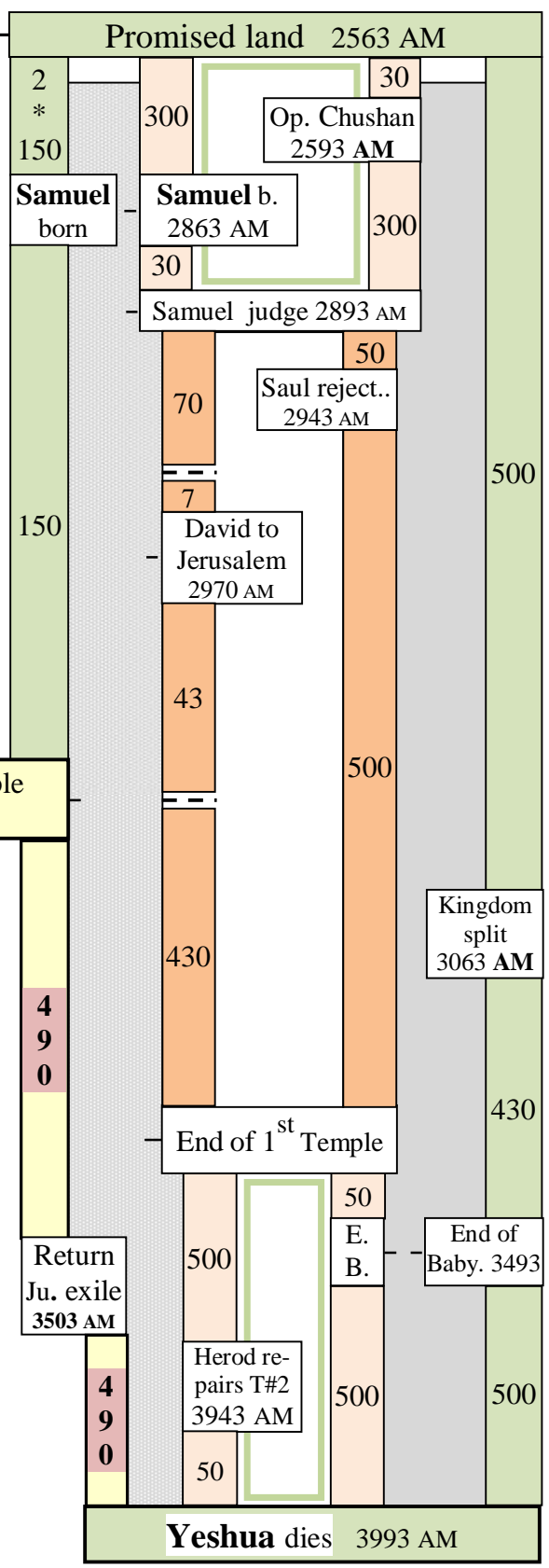
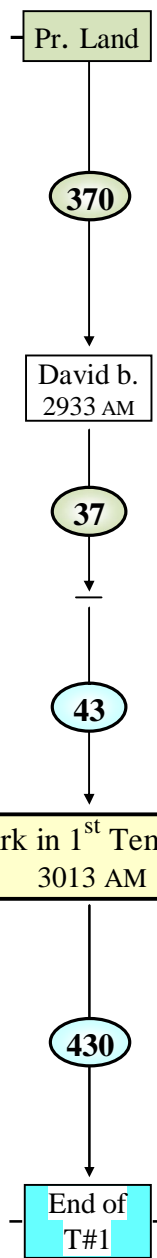
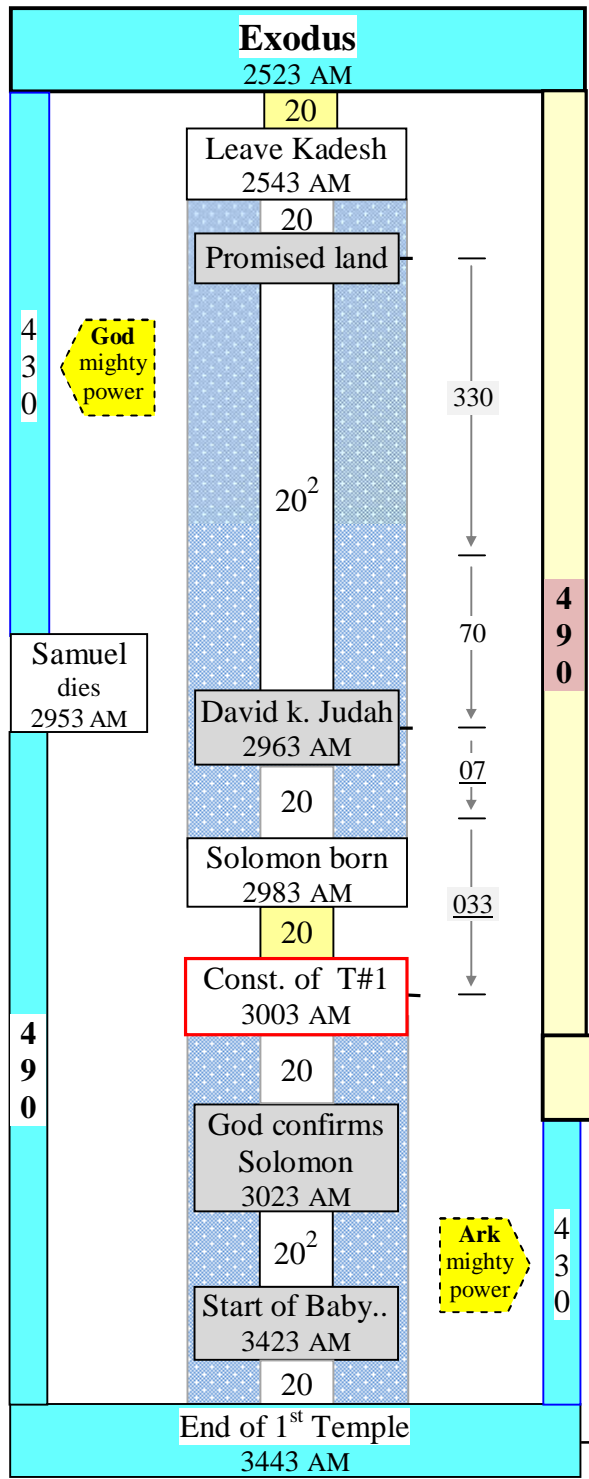

Judges & Oppressions

2563 AM Promised Land

30 y.

2 * 52	8	Opp. #1 Chushan	a 48	2593 AM	8	48	48	2 * 48	12 ²
				2601 AM	Ju. Othniel 40				
	18	Opp. #2 Eglon	b 56	2641 AM	18	47 +	49		
				2659 AM	Ju. Ehud 80 18				
20	Opp. #3 Jabin		2677 AM	20					
52			c 52	2697 AM	Ju. Deborah 40				
			12	2737 AM	GAP			12	
2 * 52	7	Opp. #4 Midian	d 50	2749 AM	7	47	48	3 * 48	12 ²
				2756 AM	Ju. Gideon 40				
	3	Opp. #5 Abimelech	e 54	2796 AM	3	48			
				2799 AM	Ju. Tola 23				
			2822 AM	Ju. Jair 22					
V9 + X7 = 2*8	18	9 Opp. #6 Ammon 9	v 9	2844 AM	18	49	49	3 * 48	12 ²
				2853 AM					
W6 + Y10 = 2*8		40	Opp #7 Philistines	w 6	2862 AM	Ju. Jephthah 6			
				x 7	2868 AM	Ju. Ibzan 7			
				y 10	2875 AM	Ju. Elon 10			
				z 8	2885 AM	Ju. Abdon 8			

2893 AM Juge Samuel

30 y

2923 AM Saul King

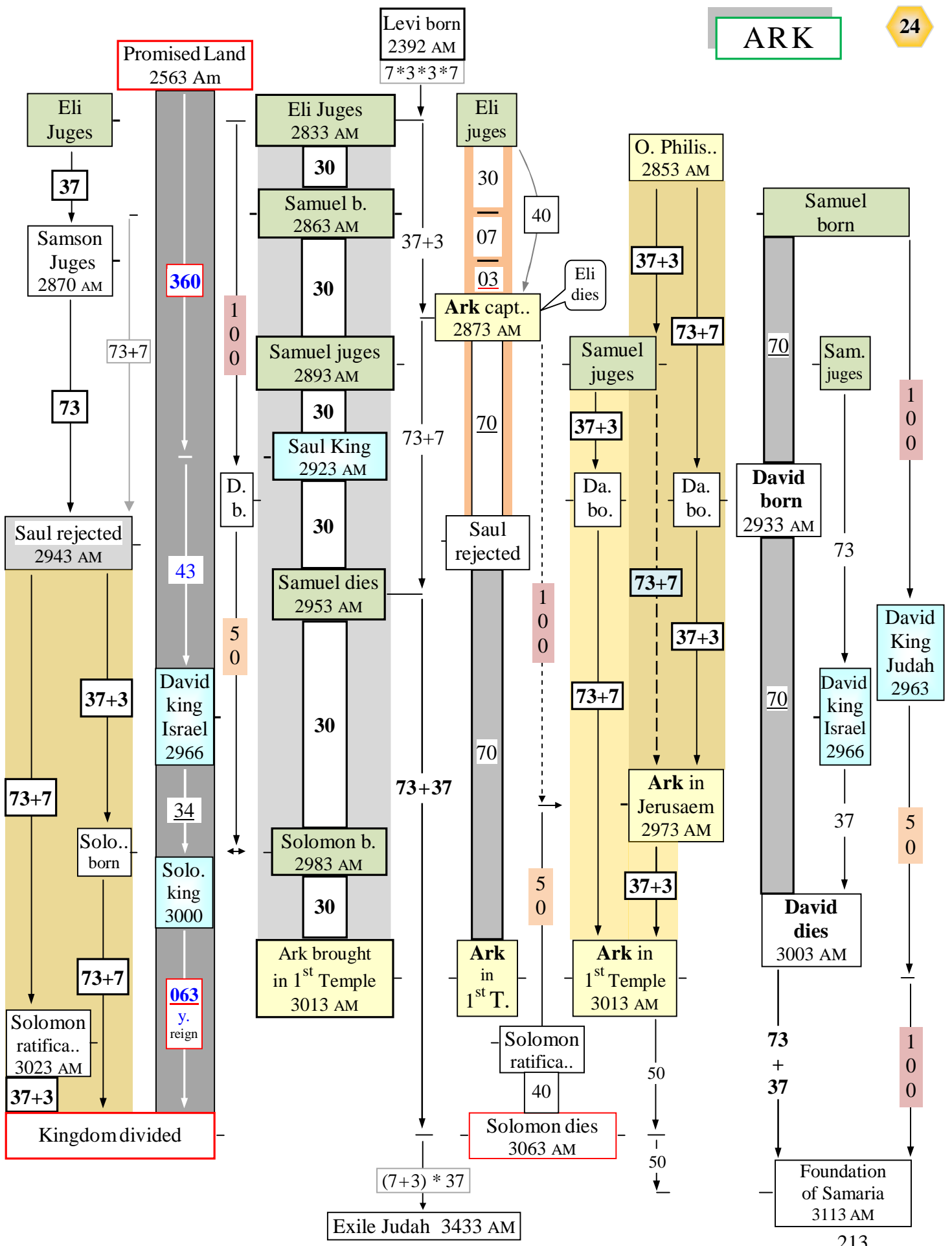

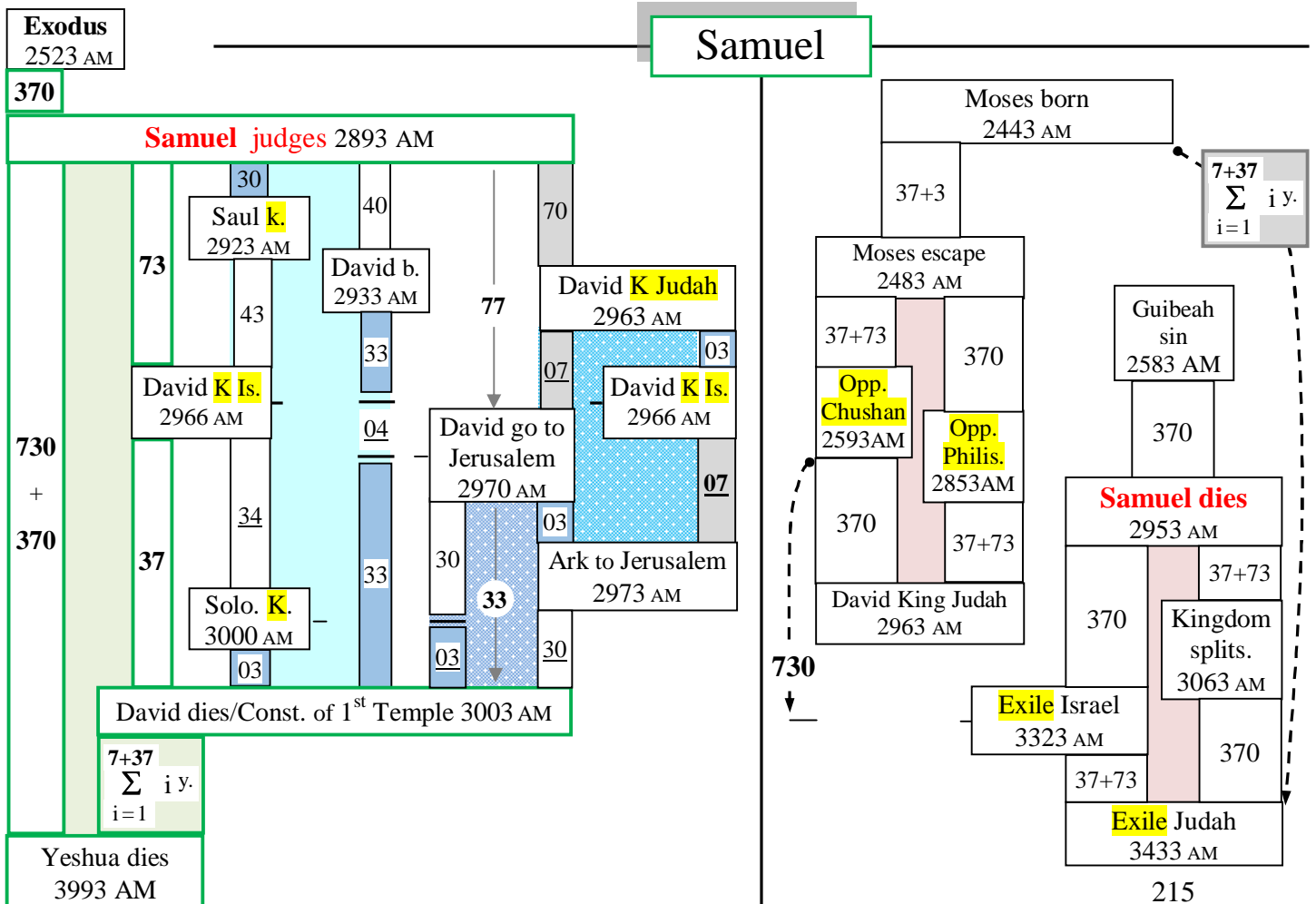
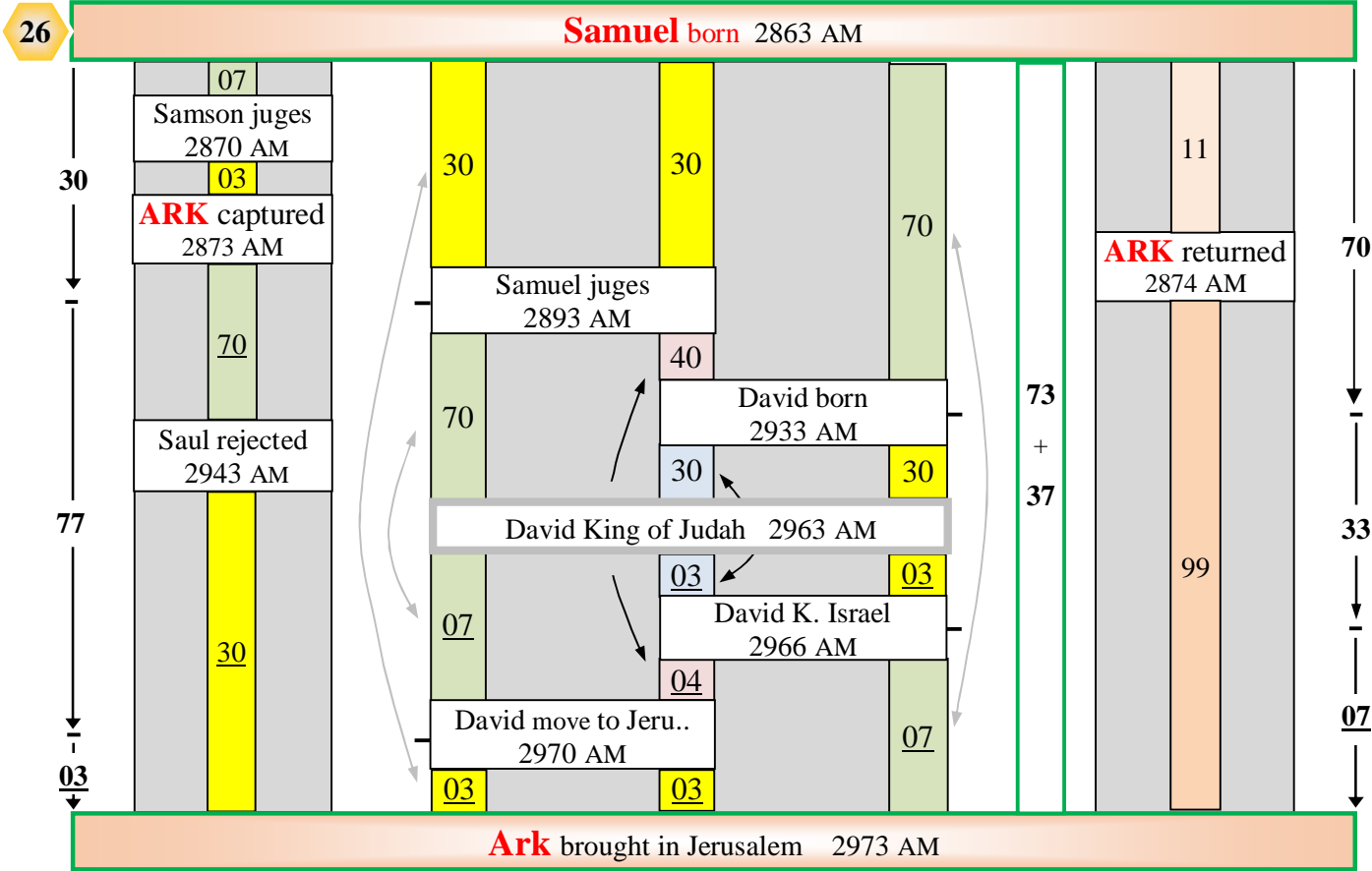

28

**Daniel
70 WEEKS**

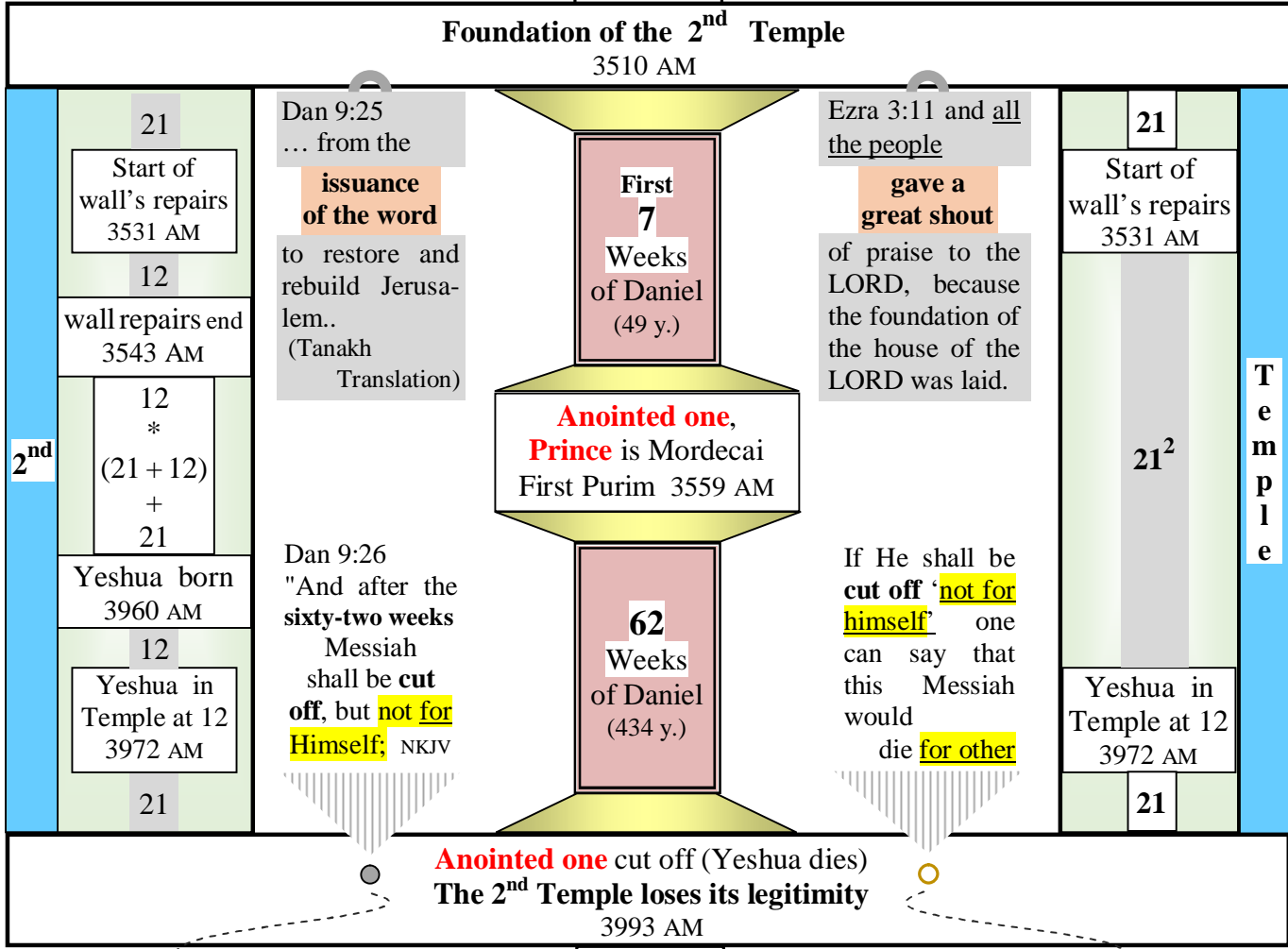
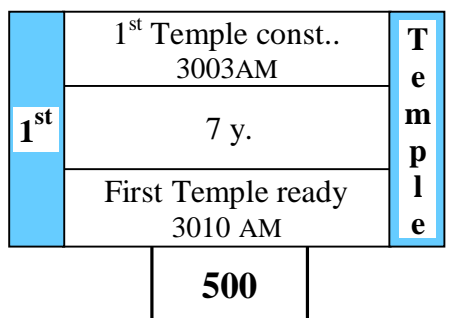

Isa 53:8 ... for he was **cut off** out of the land of the living KJV

- Amazing -
Perfect integration
of Daniel 's **70 weeks**

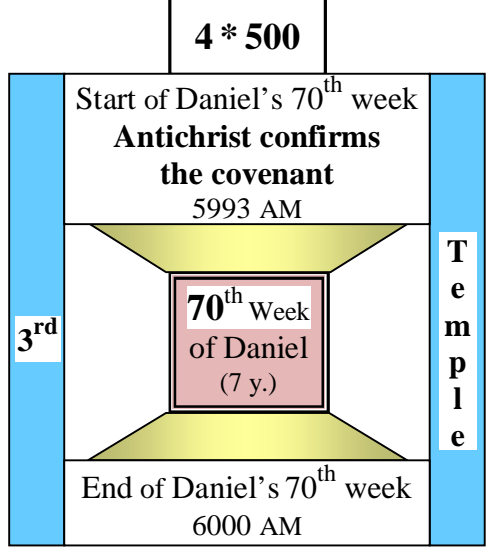

John 11:51-52 Jesus would die for the Jewish nation, and not only for that nation but also for the scattered children of God	1 John 2:2 He is the atoning sacrifice for our sins, and not only for ours but also for the sins of the whole world.
---	---

Conclusion

In the present book Ezekiel 4-5 has been used to unlock the Bible's chronology in so many ways that we have now the proper date of more than 190 different events.

There is no doubts in my mind that Adam, the first man, was created in 3963 BC.

However, I don't believe anymore that Genesis 1 advocates that the creation of the earth (and the universe for that matter) occurred over 6 days and took place at the time of Adam (i.e. a mere 6000 years ago). Here is what make me change my mind.

In a lecture called "**A Tale of Two Names: From the Garden to the Flood**", Rabbi David Foreman, says: if Gen 1 was meant to clarify how the creation of the world took place it did a poor job. The description of what happened on each of the first 3 days terminates with the statement: "and there was evening, and there was morning". How was it relevant? There was nothing in the sky to mark the passage of time. And how to explain the confusing and unrealistic sequence of events of the third and fourth day? For instance, on day 3 the vegetation and trees are created even though the sun has not been created yet. Without heat from the sun the temperature that prevailed on earth was somewhere near minus 270 degrees, in that kind of cold any living plant would have been annihilated instantly. Why didn't Genesis report the creation in a sequence that would have satisfied everybody? Are we looking at it the wrong way?

The Bible is primarily a guidebook. When Genesis talks about the creation it is from the **perspective of guidance not from the perspective of chronological order** or science book. To understand Genesis 1 you first need to imagine the nothingness of the pre-creation world. Can your mind picture a world without air, without matter, without light; a vast empty space without boundary? At this point no words can crystallized your thought, right? Human intellect is limited by our physical world therefore the Torah had to use a metaphor to talk about the 'nothingness' of the pre-creation world. In Gen 1:1 the **water world**'s reference is meant to represent the **absence of universe**.

- Gen 1:2 And the Spirit of God was hovering over the face of the waters. NKJV

(Note: When God recreated the world during Noah's flood, 'water' was used again (this time it was not a metaphor) to denote the absence of world.

- Gen 8:1 And God made a wind to pass over the earth, and the waters subsided. NKJV

Rabbi Foreman argues that the traditional reading of Gen 1:1-3

Gen 1:1-3 In the beginning God created the heavens and the earth. 2 The earth was without form, and void; and darkness was on the face of the deep. And the Spirit of God was hovering over the face of the waters. 3 Then God said, "Let there be light"; and there was light. NKJV

should rather be:

Gen 1:1-3 "In the beginning **when** God created the heavens and the earth.' **when** the earth was without form, **when** there was darkness **when** the Spirit of God was hovering of the water ... God **created light**."

God very **first creation** was "**light**" and He called that light '**Day**' and by opposition He called the darkness '**night**'. Notice the symmetry of Gen 1:5,

Gen 1:5A God called the light Day, and the darkness He called Night.

=

Gen 1:5B So the evening and the morning were the first day

It seems that God, in Genesis 1:5, give us a definition of what a 'DAY' is.

What should we tell an ignorant person to help him discern when the ‘morning’ begin? Paying attention to the next six points (list from the most important to the less) would surely help.

- | | |
|--------------------------------------|-----------------------------------|
| 1. Darkness is replaced by light | 4. The sun comes out |
| 2. The dome of the sky turns to blue | 5. The bird can suddenly be heard |
| 3. The plants open up | 6. People and animals wakeup |

Notice that in each case a transformation occurs, a reversal takes place. Each morning, we witness, with our ‘ignorant person’, six ‘creative’ processes and each one describes the transition from the night to the morning. Amazingly those six creative processes matched the ‘6 days’ of Gen 1:

1. Gen 1:3-5 Then God said, "Let there be **light**"; and there was light. ... So the evening and the morning were the first day. NKJV
2. Gen 1:6-2:1 Then God said, "Let there be a **firmament** in the midst of the waters, ... So the evening and the morning were the second day.
3. Gen 1:11-13 Then God said, "Let the earth bring forth grass, **the herb that yields seed, and the fruit tree that yields fruit according to its kind**, .. the third day.
4. Gen 1:16-19 Then God made two great lights: **the greater light** to rule the day, and the lesser light to rule the night. ... So the evening and the morning were the fourth day.
5. Gen 1:21-23 So God created **every winged bird** according to its kind. ... So the evening and the morning were the fifth day.
6. Gen 1:24-29 Then God said, "Let the earth bring forth the living creature according to its kind: ... "Let Us make **man** in Our image ... So the evening and the morning were the sixth day. NKJV

There is no way we could really understand how God created the world and we should stop assuming that Gen 1 is a simplistic and confusing blueprint of how He did it. Again, let’s keep in mind that the Bible is a guide book, not a science book. Gen 1 enumerates the elements of a memorial that take the form of six dawns (six ‘yom’). Ever since the creation of Adam, each morning, we have the possibility to witness the unfolding of these 6 ever renewing dawns coming together in a symphony that proclaim the glory of the one true God.

- Ps 72:19 Praise be to his glorious name forever; may the whole earth be filled with his glory. NIV

Does it mean that Adam was not created almost 6000 years ago (i.e. 3963 BC) ? No.

By supplying us with an abundance of chronological values the Bible encourages us to create a timeline between the origin of Adam and the End time. Are these Bible values accurate? The considerable amount of stunning patterns shown so far in this book confirms each of these values. By analogy if you assemble a jigsaw puzzle and obtain a harmonious picture, it would be inconceivable to think that some of the pieces you used didn’t belong to the box.

What I have exposed in this book is evidence of Intelligent design. It would be irrational to claim that the existence of so many patterns is the fruit of chance. The numerical patterns that I have uncovered depend on the exact timing of the events used to build them and, in many cases, the pattern would literally collapse if some value were modified by as little as one single year.

There is only one possible conclusion to this chronology. It is by the willpower of YHVH, the great architect of our universe, that mankind’s progression across the last 6000 years, was subtly being stirred to make possible the emergence of so many self-validating mechanisms.

Yves Péroquin

Appendix A From Adam to Abraham's family tree

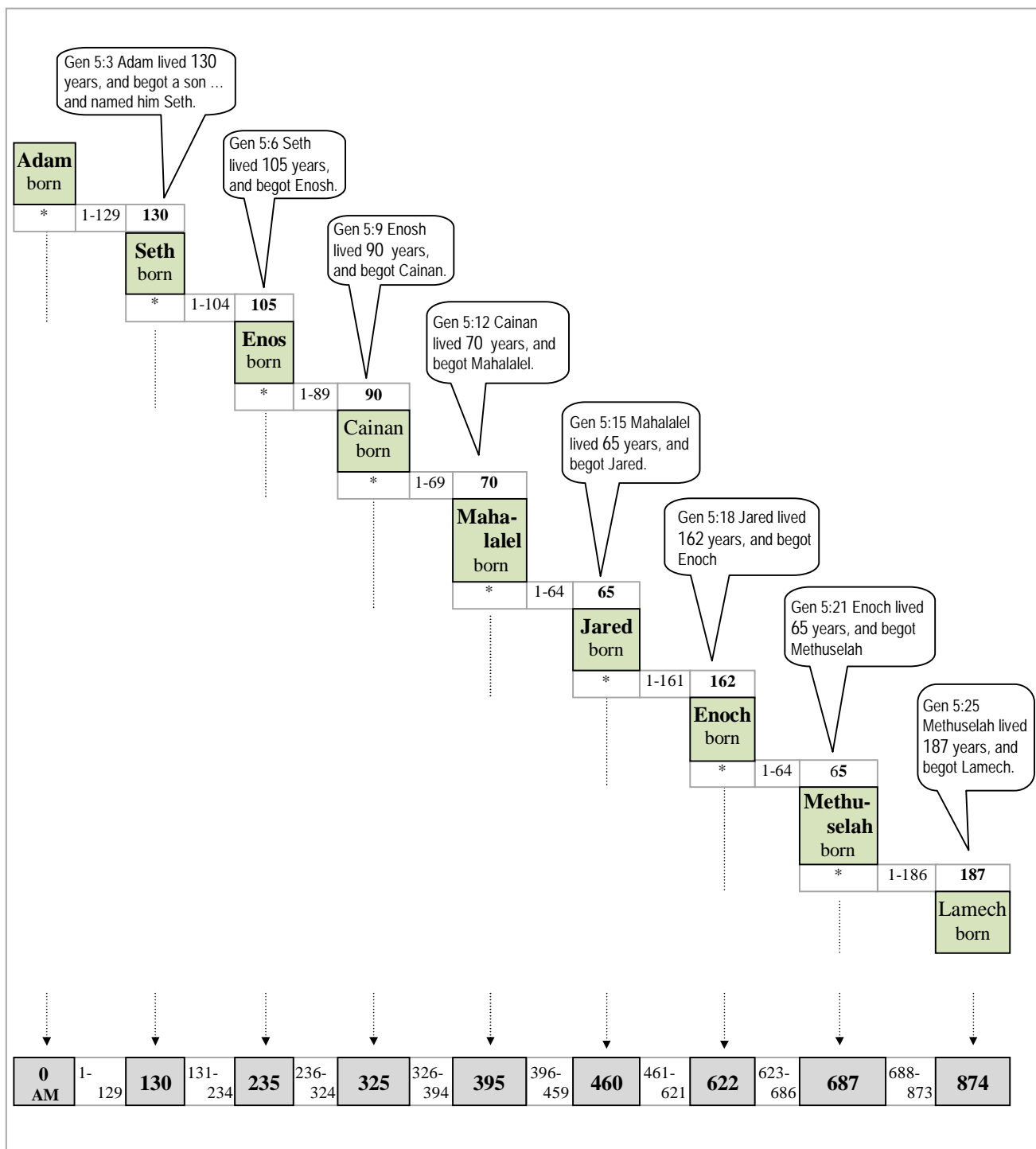

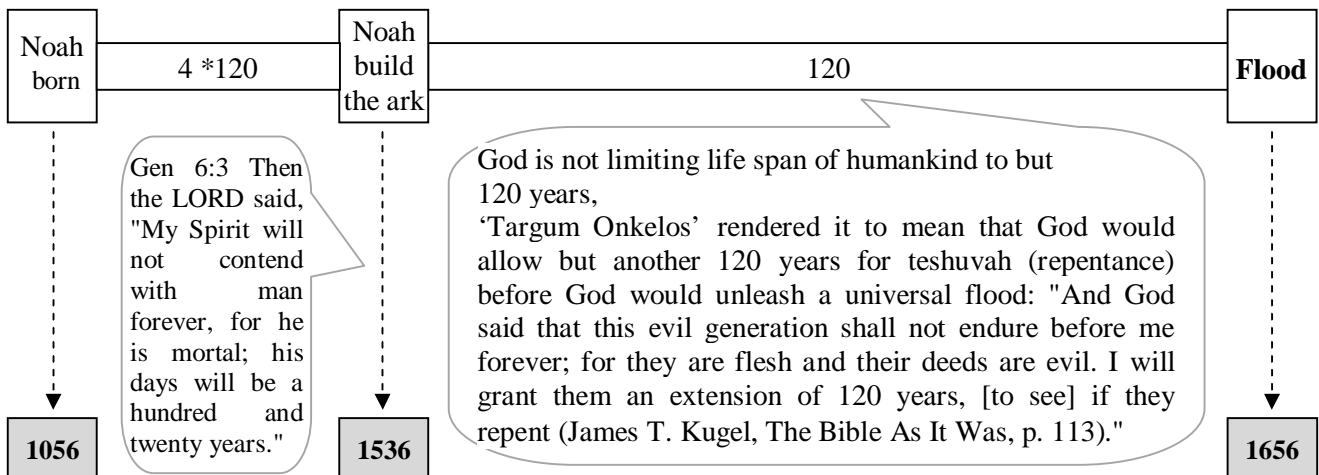
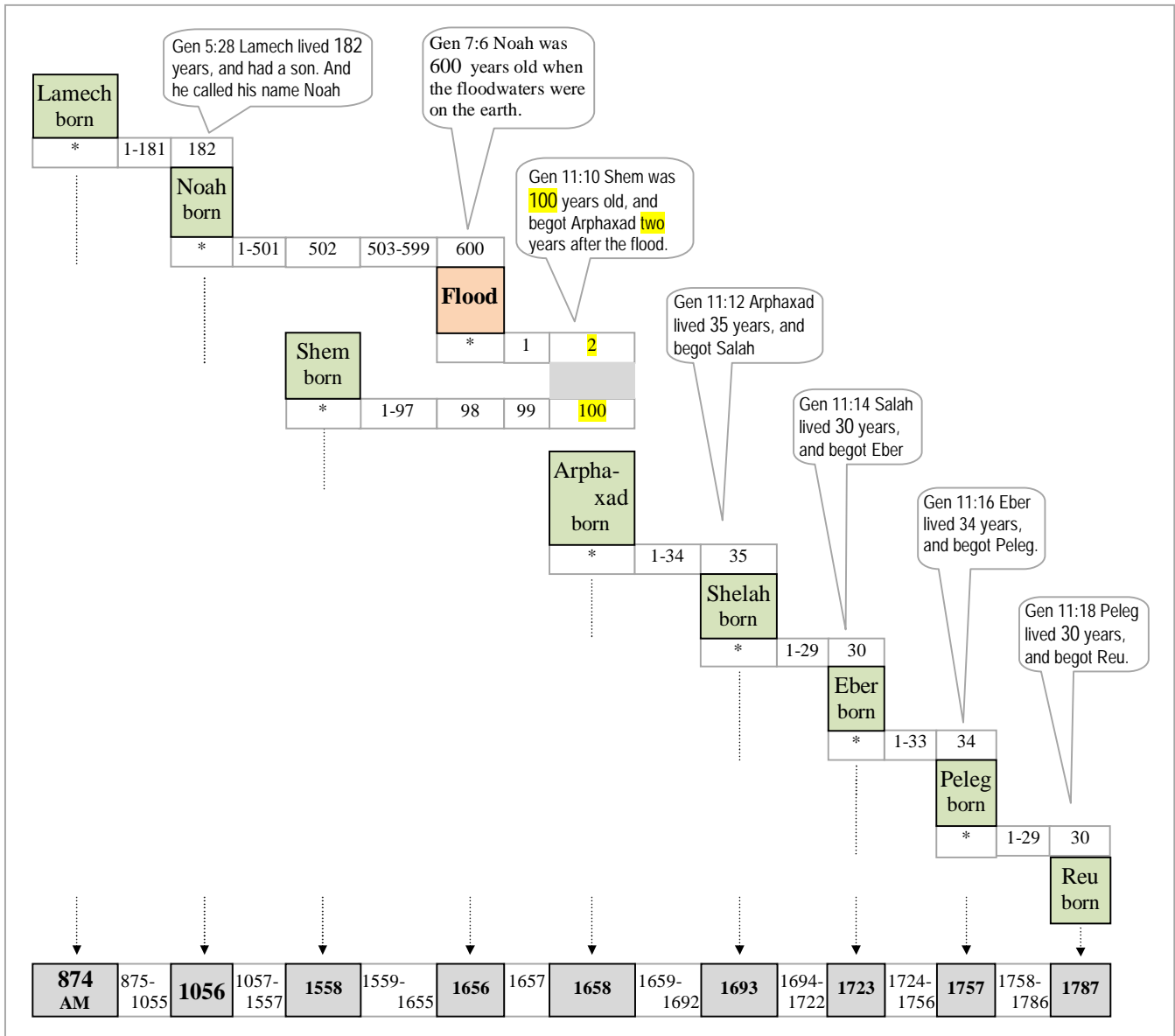

1056 AM	1057 - 1756	1757	1758 - 1786	1787	1788 - 1818	1819	1820 - 1848	1849	1850 - 1877	1878	1879 - 1995	1996	1997 - 2005	2006
----------------	-------------	------	-------------	------	-------------	------	-------------	------	-------------	------	-------------	------	-------------	------

Noah born														Noah died
*	1-700	701	702-730	731	732-762	763	764-792	793	794-821	822	823-939	940	941-949	950

Gen 9:29 all the days of Noah were 950 years

	Peleg born											Peleg dies
*	1-29	30	31-61	62	63-91	92	93-120	121	122-238	239		

Gen 11:18-19 Peleg had lived 30 years, ... after lived 209 y.

122-205	206	207-238
Babel		
1879 - 1992	1993 AM	1994 - 1995

Reu born

*	1-31	32
---	------	----

Gen 11:18 Peleg lived 30 years, and begot Reu.

Gen 11:20 Reu lived 32 years, and begot Serug.

Serug born

*	1-29	30
---	------	----

Gen 11:22 Serug lived 30 years, and begot Nahor.

Nahor born

*	1-28	29
---	------	----

Gen 11:24 Nahor lived 29 years, and begot Terah

Terah born

*	1-117	118	119-127	128	129	130	131-204	205
---	-------	-----	---------	-----	-----	-----	---------	-----

Gen 11:32 So the days of Terah were 205 years, and Terah died in Haran.

Gen 12:4 Abram was 75 years old when he departed from Haran. (at Terah's death)

Terah dies
Abram leaves Haran

Abram born

*	1-74	75
---	------	----

1056 AM	1057 - 1756	1757	1758 - 1786	1787	1788 - 1818	1819	1820 - 1848	1849	1850 - 1877	1878	1879 - 1995	1996	1997 - 2005	2006	2007	2008	2009 - 2082	2083
----------------	-------------	------	-------------	------	-------------	------	-------------	------	-------------	------	-------------	------	-------------	------	------	-------------	-------------	------

Abraham's family tree

When was Abraham born?

- Gen 11:32 Terah lived 205 years, and he died in Haran.
- Gen 12:4 So Abram left, as the LORD had told him; and Lot went with him. Abram was seventy-five years old when he set out from Haran.

According the previous two verses Abraham was 75 years old when he left Haran “at his father’s death”.

First conclusion : Abraham was born when Terah was 130 years old (205 – 75).

However, according to the next verse, Abraham was born when Terah was 70 years old.

- **Gen 11:26** After Terah had lived 70 years, he became the father of Abram, Nahor and Haran.

Sec. conclusion : Abraham could have been born when Terah got 70 years old.

Given these two conclusions cannot be right at the same time there must be a way to reconcile Gen 11:32, 12:4 and 11:26?

First, unless Terah was the father of triplet, and it is very unlikely given the absence of any Bible’s comment on such an extraordinary fact, you have to admit that **Gen 11:26** only say that Terah got his first son when he was 70, the other two sons came to him in the latter years. But, if this is the case, wouldn’t it mean that Abraham, the first name to be listed, was born when Terah was 70? No. Being the first in the list doesn’t mean that he was the first born. There is a precedent worth to be examined.

From the following two verses you could be inclined to think that **Shem** was Noah first son, after all he is listed first¹⁰³ in both cases.

- Gen 5:32 After Noah was 500 years old, he became the father of **Shem**, **Ham** and **Japheth**.
- Gen 10:1 This is the account of Shem, Ham and Japheth, Noah's sons, NIV

However, here it is clearly said that **Japheth**, not **Shem**, was the oldest son of Noah.

- Gen 10:21 Sons were also born to Shem, whose older brother was **Japheth**;

Back to Abraham. The readers would correctly point to the fact that Gen 11:32,12:4 don’t especially say that Abraham left Haran at the death of Terah. I agree with the reader, Gen 12:4 doesn’t say it, but, **Stephen, under inspiration did.**

- Acts 6:5 They chose Stephen, a man full of faith and of the Holy Spirit;
- Acts 7:4 "So he left the land of the Chaldeans and settled in Haran. **After the death of his father**, God sent him to this land where you are now living.

In 2008 AM, the 130 years old Terah (born in 1878 AM), got his son Abram.

¹⁰³ Could have been done as a sign of the future prominence of the individual.

Terah had 3 children: Abam, Nahor, Haran

- Gen 11:26 After Terah had lived 70 years, he became the father of **Abram**, **Nahor** and **Haran**.

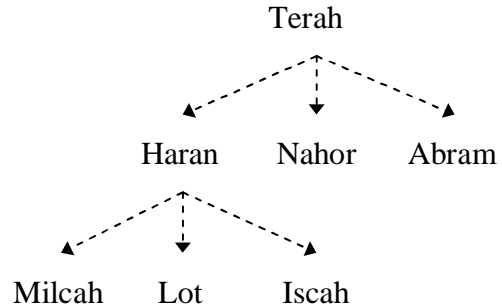

Haran, Abram's brothers, had also three children: Lot, Milcah and Iscah

- Gen 11:27 And Haran became the father of Lot.
- Gen 11:29 ... Haran, the father of both Milcah and Iscah.

It is believe among jewish sages that **Iscah is none other than Sarai**¹⁰⁴ (the girl who would become Abraham's wife). Both names, **Iscah and Sarai**, means "princess". Sarai is therefore the sister of Milcah and the niece¹⁰⁵ of Abram.

Immediately **after mentionning Haran's death** the Bible tell us that Abram took a wife called Sarai and Nahor took also a wife called Milcah.

- Gen 11:28-29 And Haran died before his father Terah in the land of his nativity, in Ur of the Chaldees. And Abram and Nahor took them wives: the name of Abram's wife was Sarai; and the name of Nahor's wife, Milcah, the daughter of Haran, the father of Milcah, and the father of Iscah.

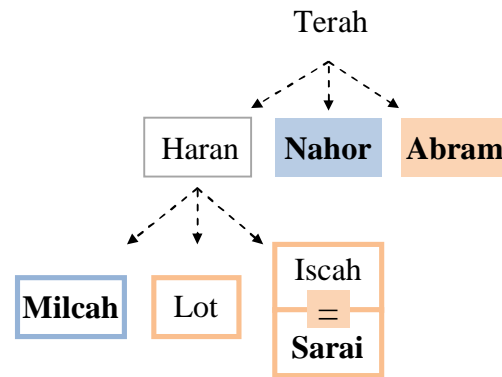

Beside this strange situation (two brothers marrying their nieces), we also learn that Abraham developed a father-son relationship with his nephew Lot.

- Gen 12:5 He took his wife Sarai, his nephew Lot,
- Gen 13:1 So Abram went up from Egypt to the Negev, with his wife and everything he had, and Lot went with him.

It is clear here that, after their father's death, the three children of Haran became the responsibility of their two uncles Abram and Nahor. But why?

Now wouldn't it shed more light on the whole situation if Haran had been the eldest son of Terah, the one born when he was 70 years old? If it was the case we could argue that the two youngest brothers (Nahor and Abraham) assumes the 'unwritten moral obligation' to provide for their oldest brother's posterity.

¹⁰⁴ The structure of Gen 11:29 also imply that Iscah and Sarai are the same one.

¹⁰⁵ Doesn't it contradict Gen 20:12 where Abram says that Sarai was his half sister?

- Gen 20:12 And yet indeed she is my sister; she is the daughter of my father, but not the daughter of my mother; and she became my wife. KJV

I asked the opinion of Rabbi David Foreman about this question and here is his answer:

<< its a euphemism of niece; i.e. she is his "sister" in the sense that she is the daughter of his brother. You find a similar expression with Lot, when Abraham says "anashim achim anachnu" we are brothers. It doesn't mean literally brothers, it means we have a "brother like" relationship, in the sense that you are the son of my brother >>

Did you ever wonder why, twenty years before the call of Abraham to leave Haran in 2083 AM (Gen 12), Terah took Abraham, Lot & Sarai and left Ur? As far as we know there was no call involve at that time. Why did they left Ur in 2063 AM? I believe they left Ur because of what happened at Babel. As a clue to this both stories directly follow each other in Gen 11.

- Gen 11:31-32 Terah took his son Abram, his grandson Lot son of Haran, and his daughter-in-law Sarai, the wife of his son Abram, and together they set out from Ur of the Chaldeans

A common reaction when reading the Tower of Babel story (Gen 11) is to assume that God miraculously whisked the people all around the land. But it has not to be the case. The dispersion could have been done in a more subtle way. In my chronology Terah left Ur 70 years after Babel. This fact should be view as another clue. A period of 70 years between two events is never meaningless in the Bible.

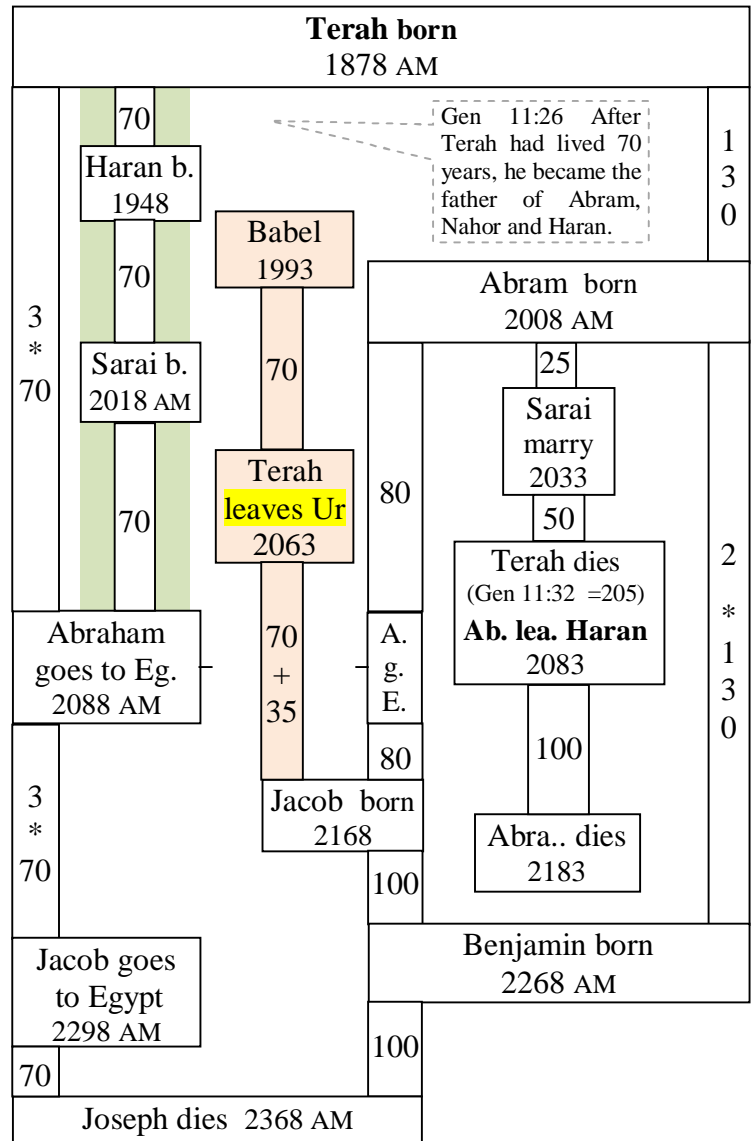
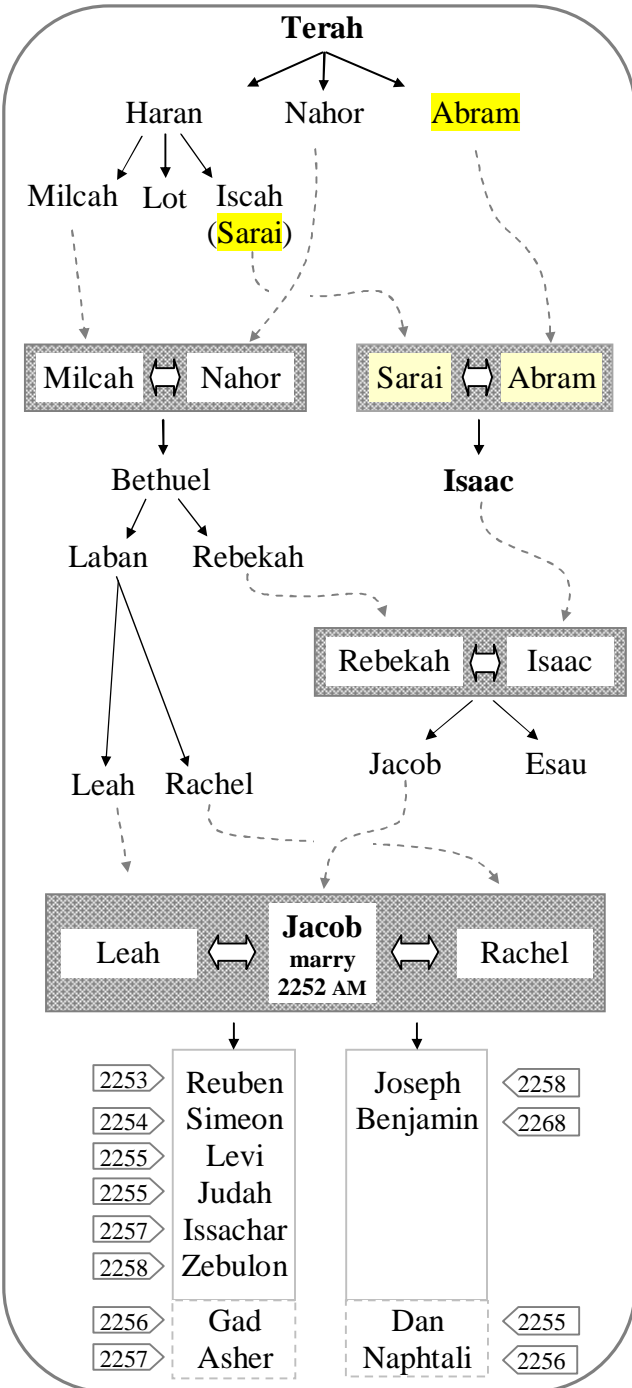

The next four charts speculate on the **number of days** between a series of related events. The result is quite amazing. It is unlikely that these charts could be validated by any means, however the simple fact that the events could be separated by the proposed number of days make the suggestion a very compelling possibility.

Appendix B Counting with New moons and Days

Can we find out the exact date (month and day) of every Biblical event? Lets try to find out patterns that would give us this **hidden** information. Here is what we know: (Note: M2D17 means 2nd month 17th day)

Supplied by the Bible			found in the present work	
Event	Date	Ref	Year , month and day	
The Flood	M2D17	Gen 7:11	1656 AM	M2D17
Opening of the Ark	M2D27	Gen 8:14	1657 AM	M2D27
Covenant of parts	M1D15	ref Exo 12:41	2093 AM	M1D15
Reuben mandrake	Early spring	Gen 30:14	2257 AM	M2D17
Exodus	M1D15	Num 33:3	2523 AM	M1D15
Arrival to Sinai	M3D1	1 Sam 6:1	2523 AM	M3D1
Set the Tabernacle	M1D1	Exo 40:2	2524 AM	M1D1
Leave Sinai	M2D20	Num 10:11	2524 AM	M2D20
Land spied	Summer	Num 13:24	2524 AM	M4D30
Aaron dies	M5D01	Num 33:38	2562 AM	M5D2
Mose dies	M11	Deut 1:3	2562 AM	M11D26
Promised Land	M1	Josh 4:19	2563 AM	M1D1
Const 1 st Temple	M2 (ZiF)	1 King 6:1	3003 AM	M2D16
Ark in 1 st Temple	Near 7 th month	1 King 8:2	3013 AM	M6D8
Exile of Judah	Spring	2 Chron 36:10	3433 AM	M3D12
End of Jerusalem	M5D7	2 King 25:8	3443 AM	M5D8
Build an Altar	M7	Ezra 3:1/3:8	3508 AM	M7D1
Foundation of 2 nd Temple	M2 of the 2 nd year (after altar)	Ezra 3:8	3510 AM	M2D1
Const 2 nd Temple	M6D24	Hag 1:15	3513 AM	M13D25
2 nd Temple ready	Adar 13	Ezra 6:15	3517 AM	M1D13
Nehemiah wall end	M6D25	Neh 6:15	3543 AM	M6D25
First Purim	M12D13	Est 9:1	3559 AM	M12D14
Yeshua in T. at 12	Around M2	Luc 2:46	3972 AM	M2D3
Yeshua death	M1D14	John 18:39	3993 AM	M1D16
End of 2 nd Temple	M5D7	Tradition	4033 AM	M5D6

The next 23 charts have been built using the number of days ‘☉’ and the number of New moons ‘☾’ between the different events. Each count were obtained with the help of the Julian day associated with the event.

The julian day is a unique, sequential, integer number tagged to each day of the Gregorian calendar. Ex May 1, 1870 BC has julian day J1,038,525. Working with Julian day greatly simplifies the task of obtaining the number of days between two dates, or, if there is a need, finding a new date by going forward and backward a number of days from a known date. To find out the number of New moon between two events we need to find the Julian day of the new moon following the first event and the Julian day of the new moon preceding the second event. The difference between the two values, divided by 29.5305888, represent the number of New moon between these two events.

NOTE: It is unlikely that the following charts could be validated by any means, however the patterns that will be exposed are truly amazing and the fact that all the dates supplied by the Bible (see previous table) have been scrupulously integrated, make them convincing.



EDEN hypothesis

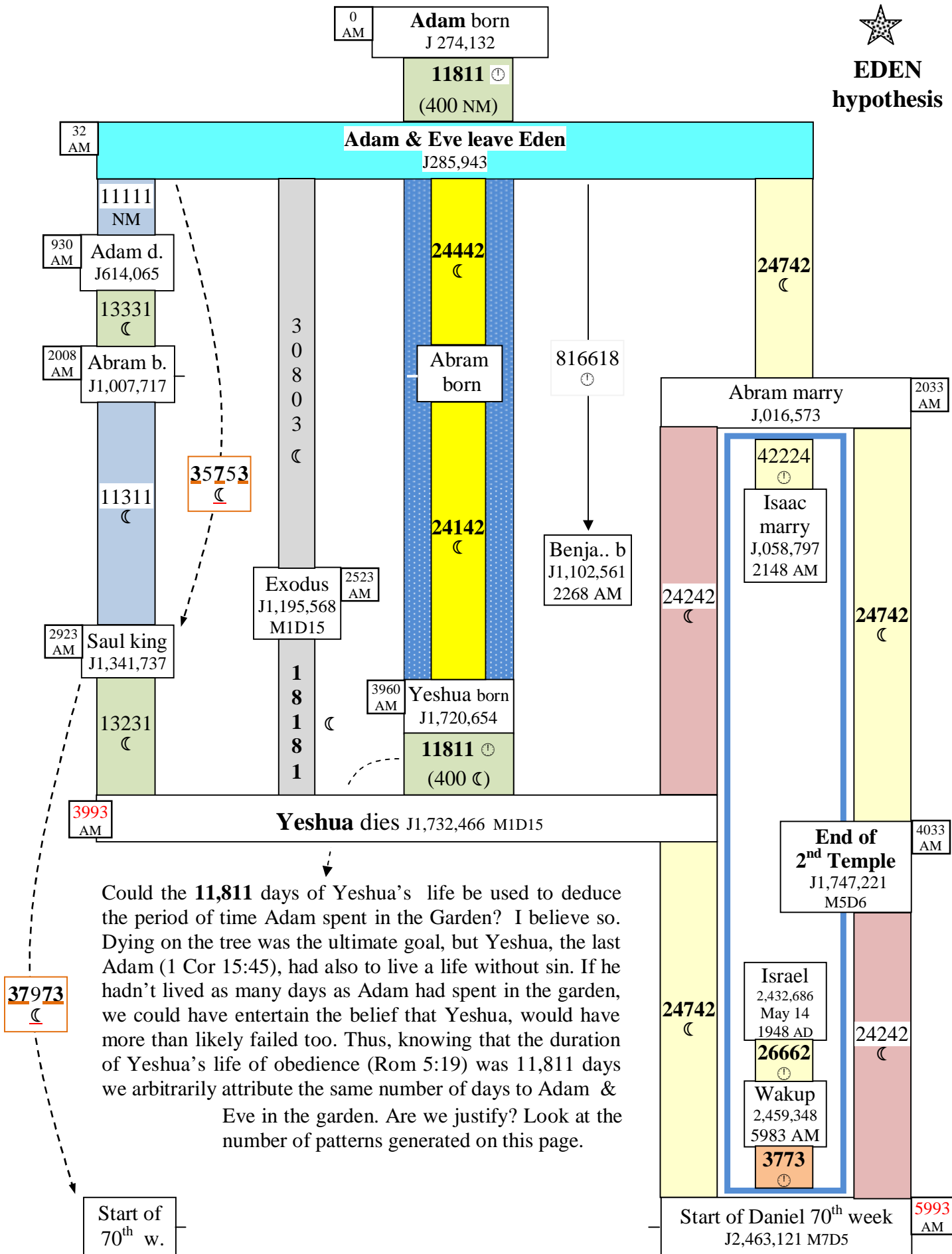

Gen 6:3 ...his days will be 120 years."

★ Noah

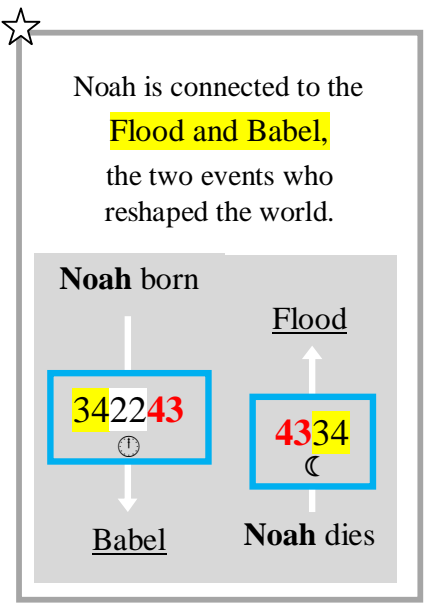
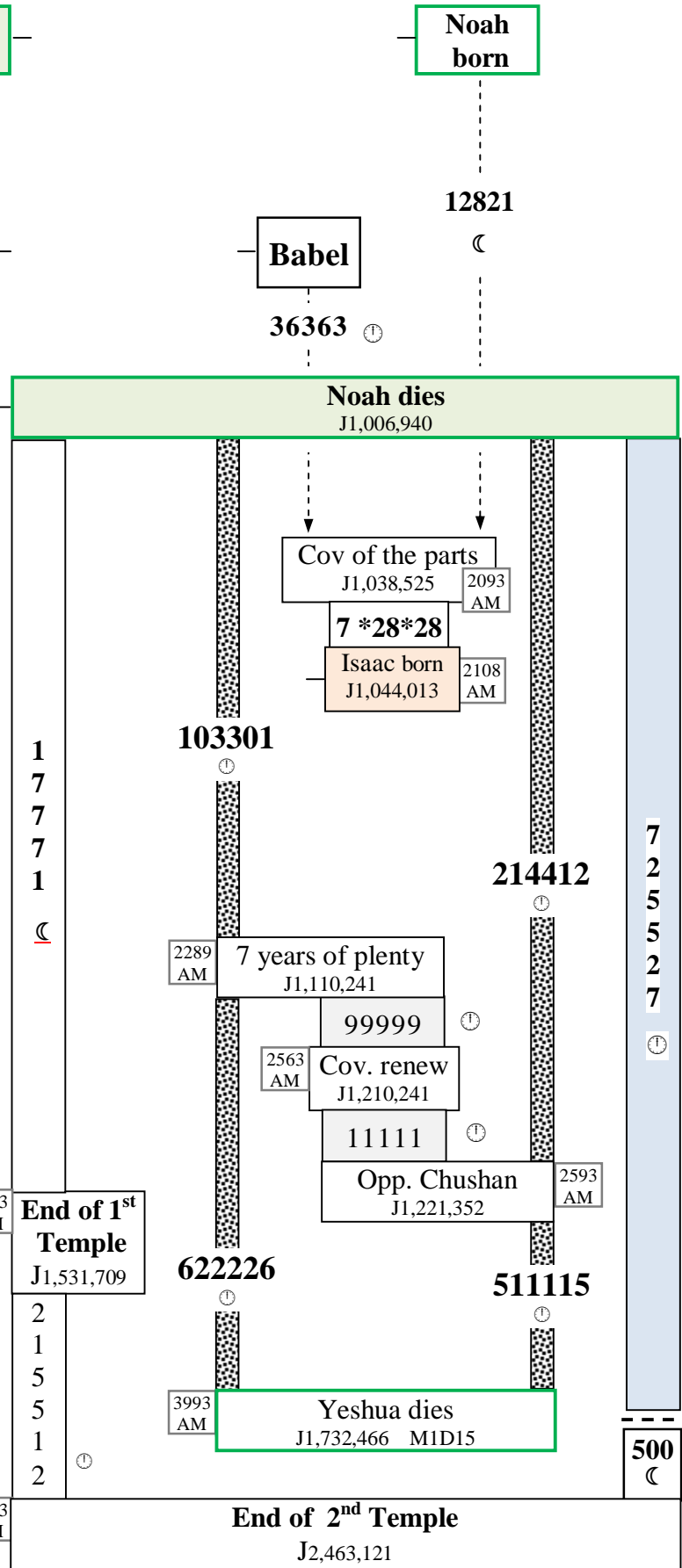
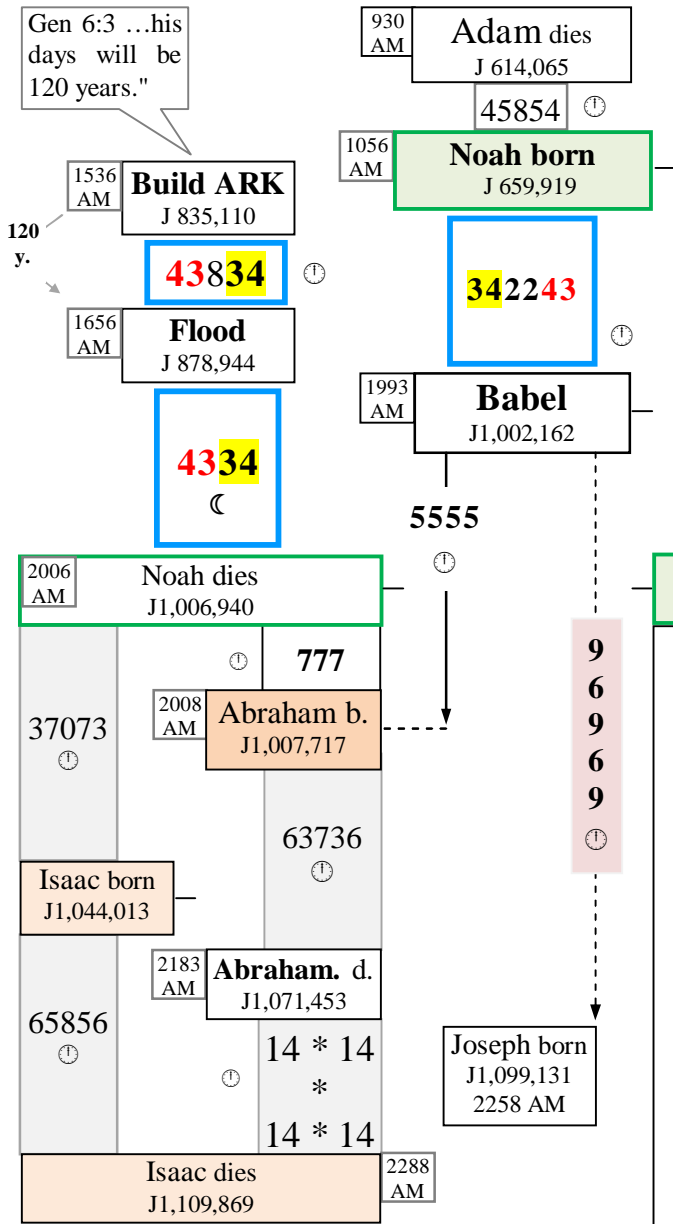

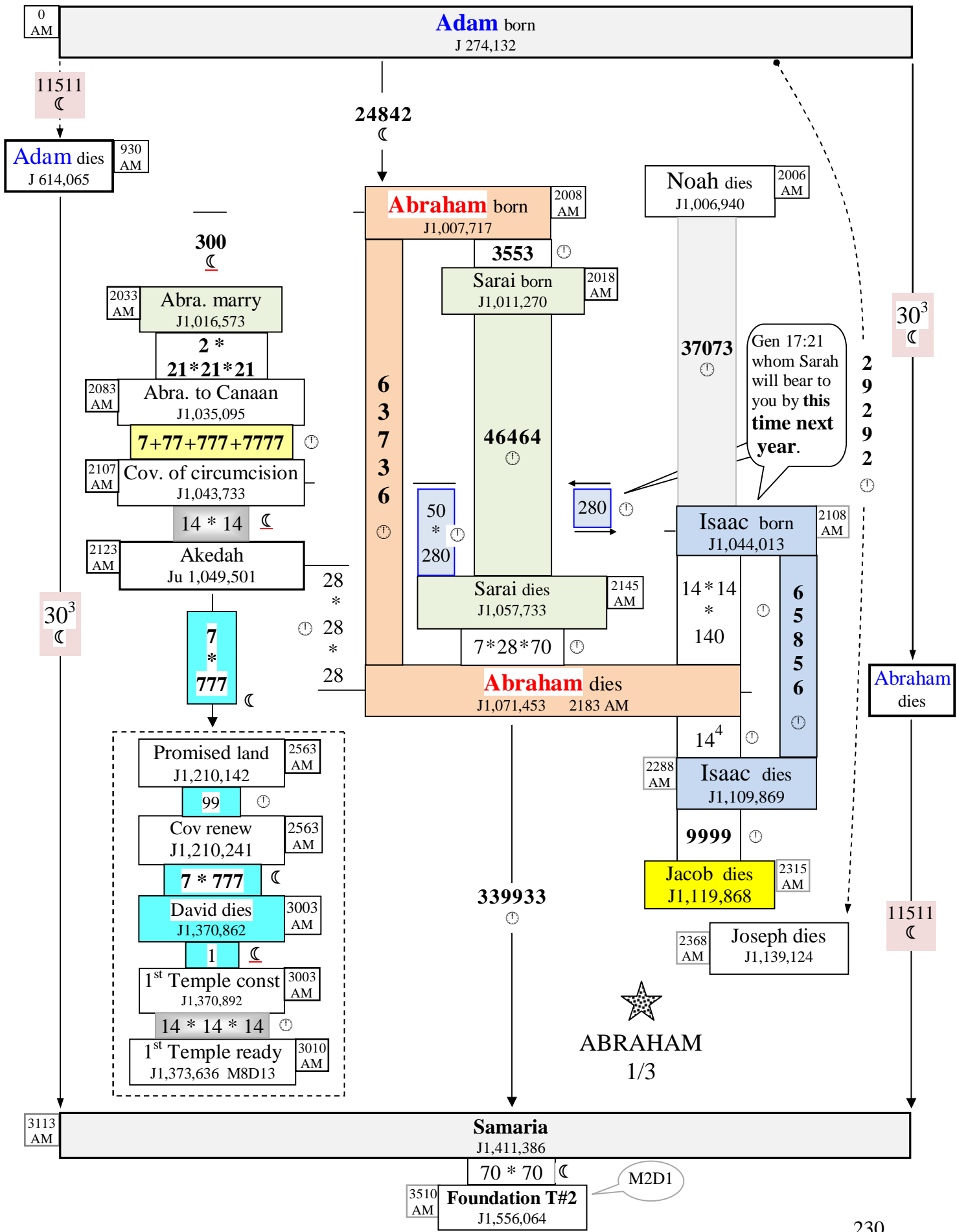

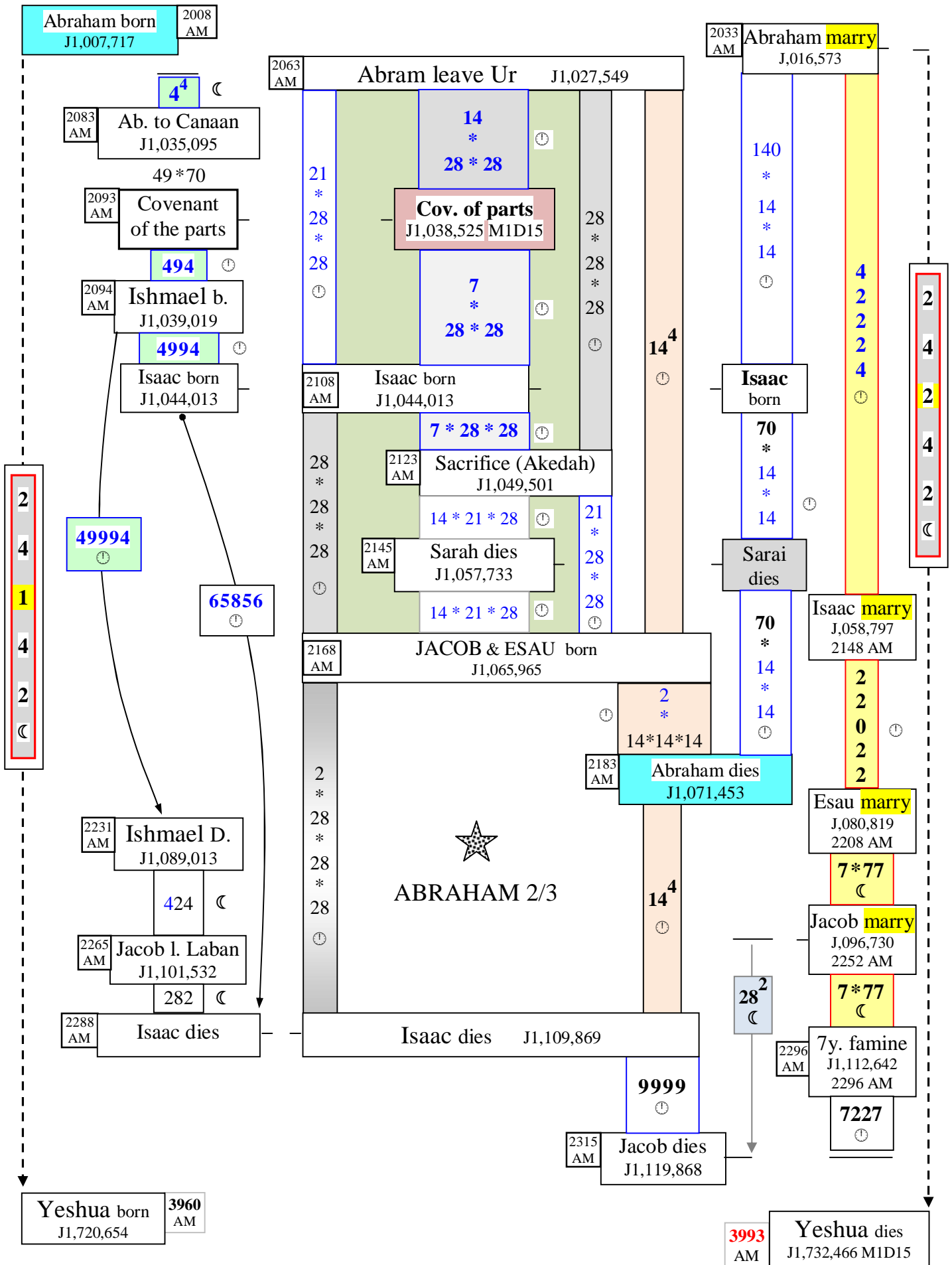



ABRAHAM
3/3

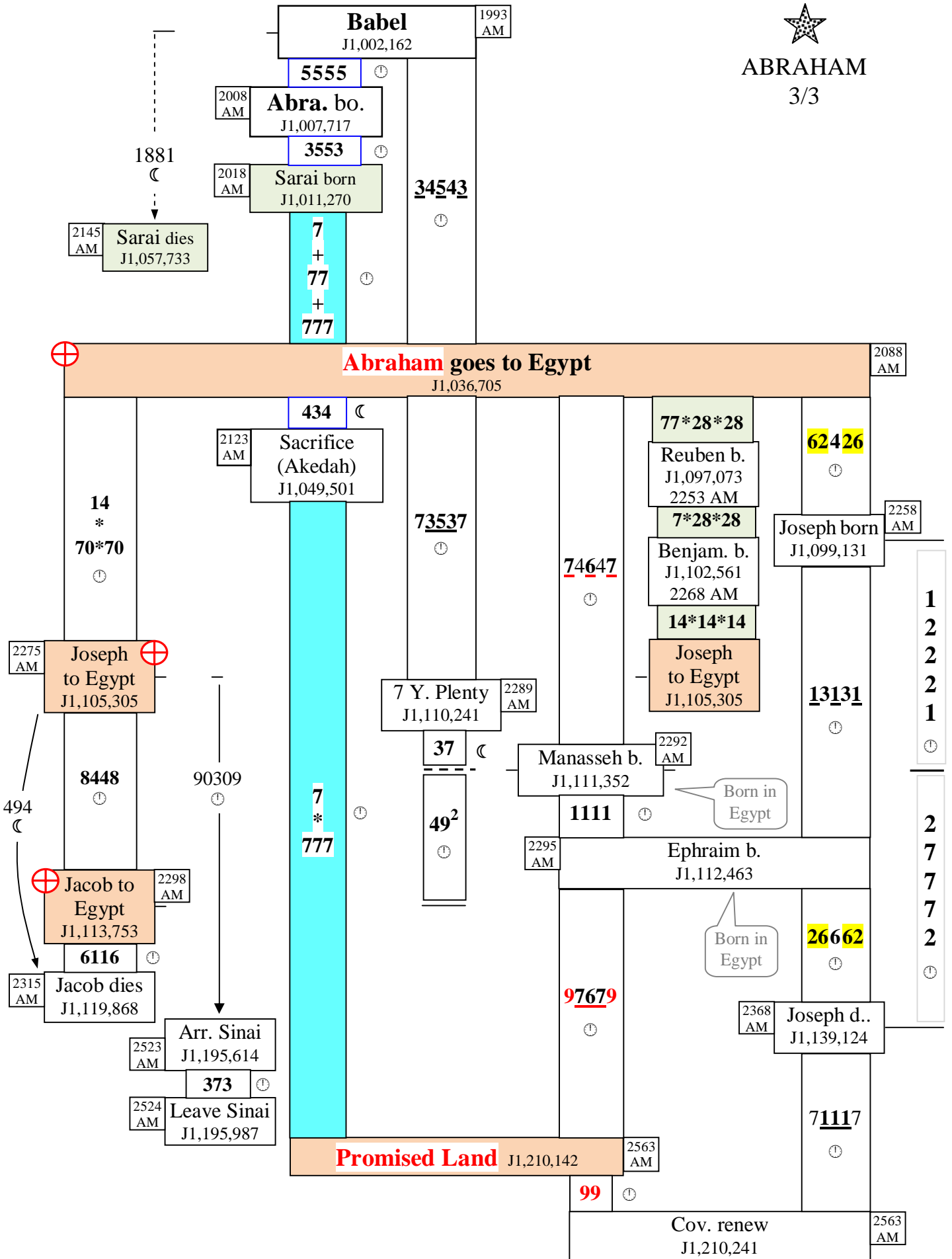

28,000
+
2,800
+
280
+
28



JACOB 2/3

All the events on this page occurred on the same day of the week

Abraham dies
2183AM
J 1,071,453

Jacob marry J 1,096,730 2252 AM
1 * 7 * 49

Reuben 1 Born J 1,097,073 M5D3

2253 AM

280 + 28

Simeon 2 Born J 1,097,381 M3D15

2254 AM

280 + 28

Levi 3 Born J 1,097,689 M1D28

2255 AM

280 + 28

Judah 4 Born J 1,097,997 M12D12

2255 AM

4

*

7

49

⌚

70 * 28

⌚

M2D17 Gen 30:14 Wheat harvest

2 * 28

Mandrakes J 1,098,445 2257 AM

2

*

7

49

⌚

70 + 28

⌚

Joseph 11 Born J 1,099,131 M12D24

2258 AM

10 * 7 * 49

Rachel

35 * 7 * 14

Benjamin 12 Born J 1,102,561 M2D20 2268 AM

Leah

Bilhah

Zilpah

Leah

28,000
+
2,800
+
280
+
28

⌚

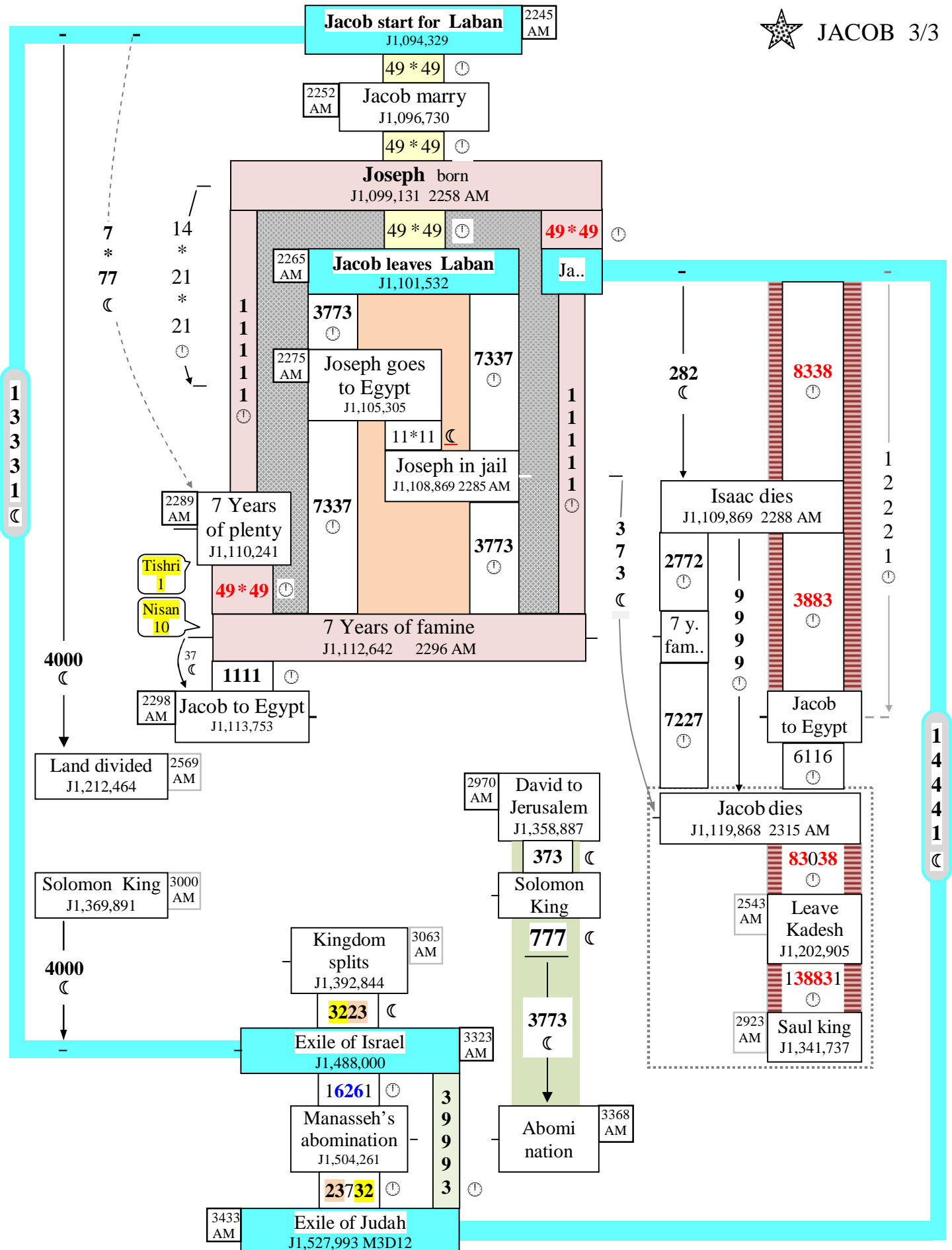



Levite's dynasty 1/3

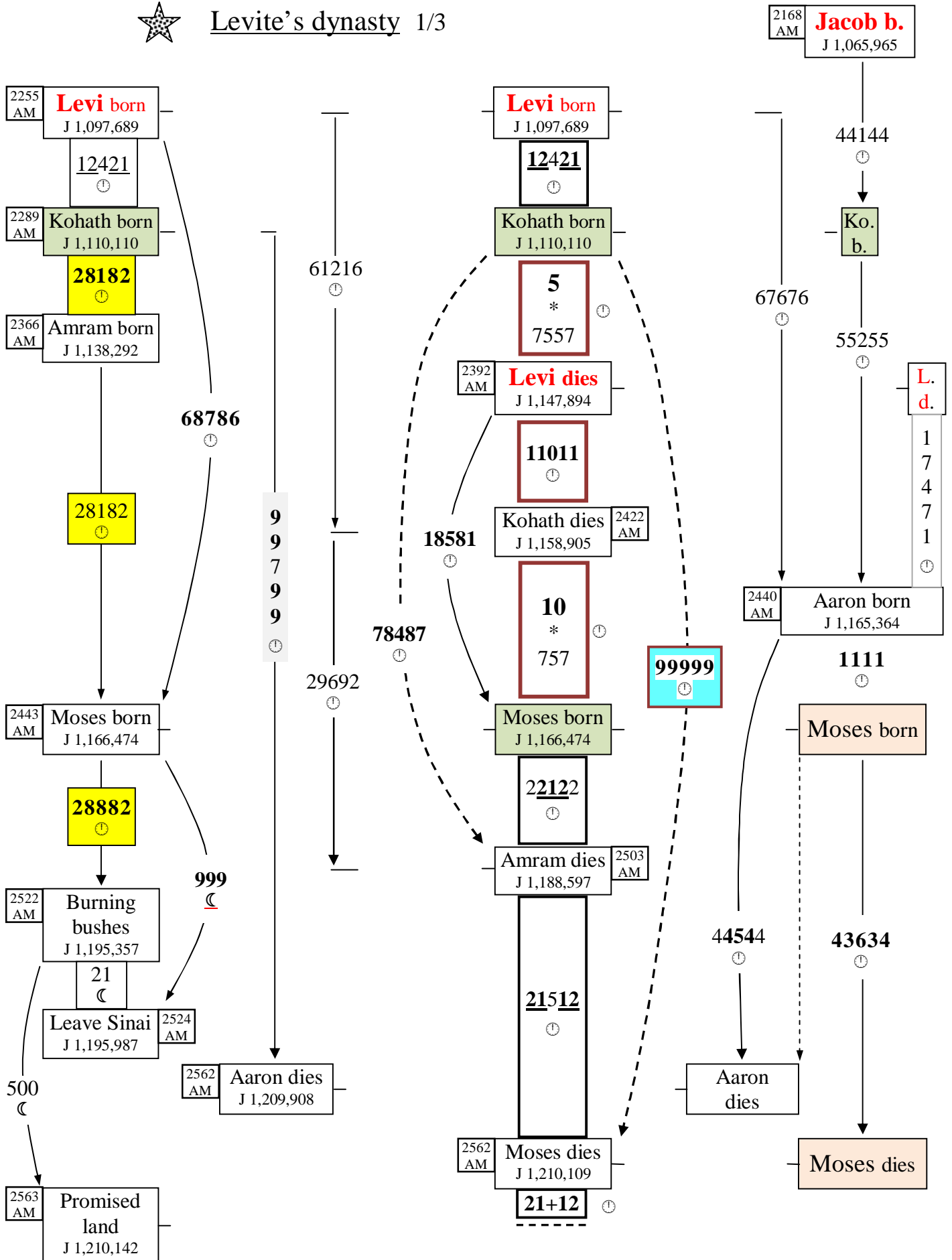



Levite's dynasty 3/3

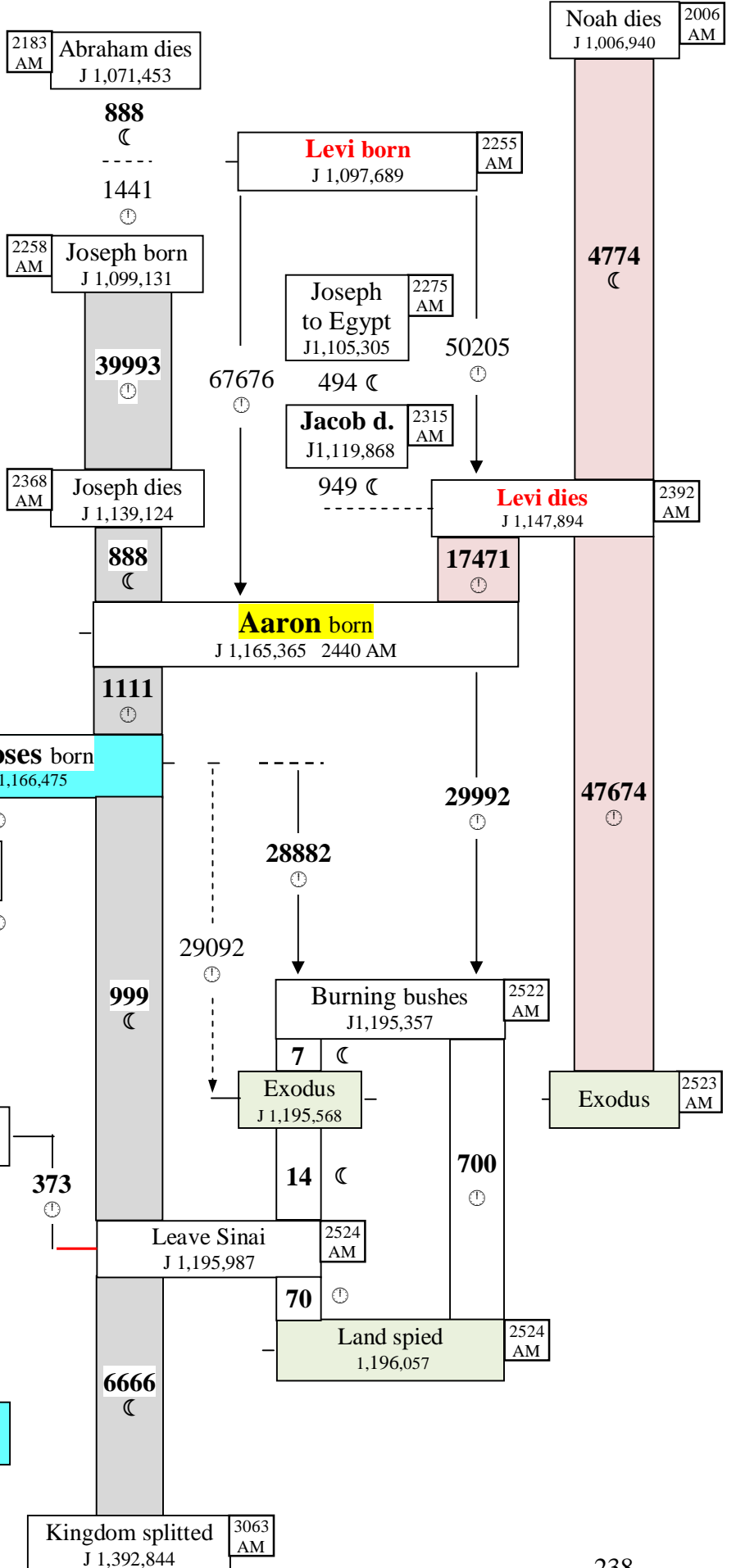
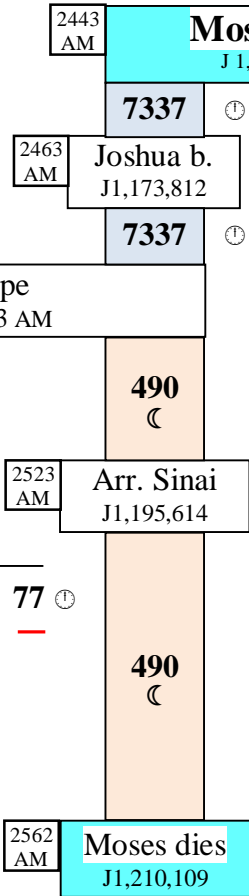
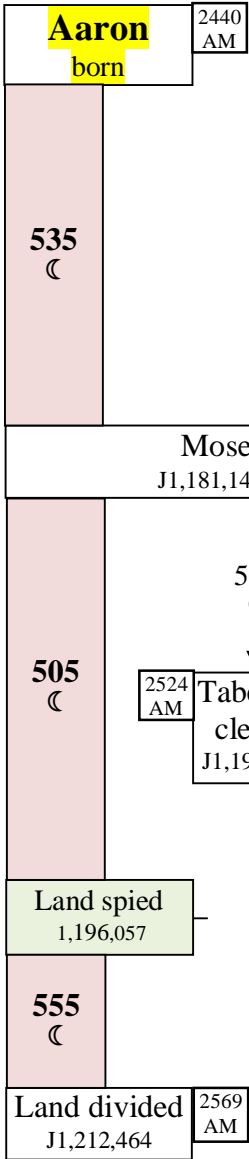
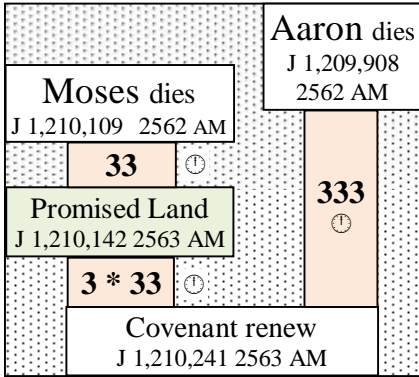

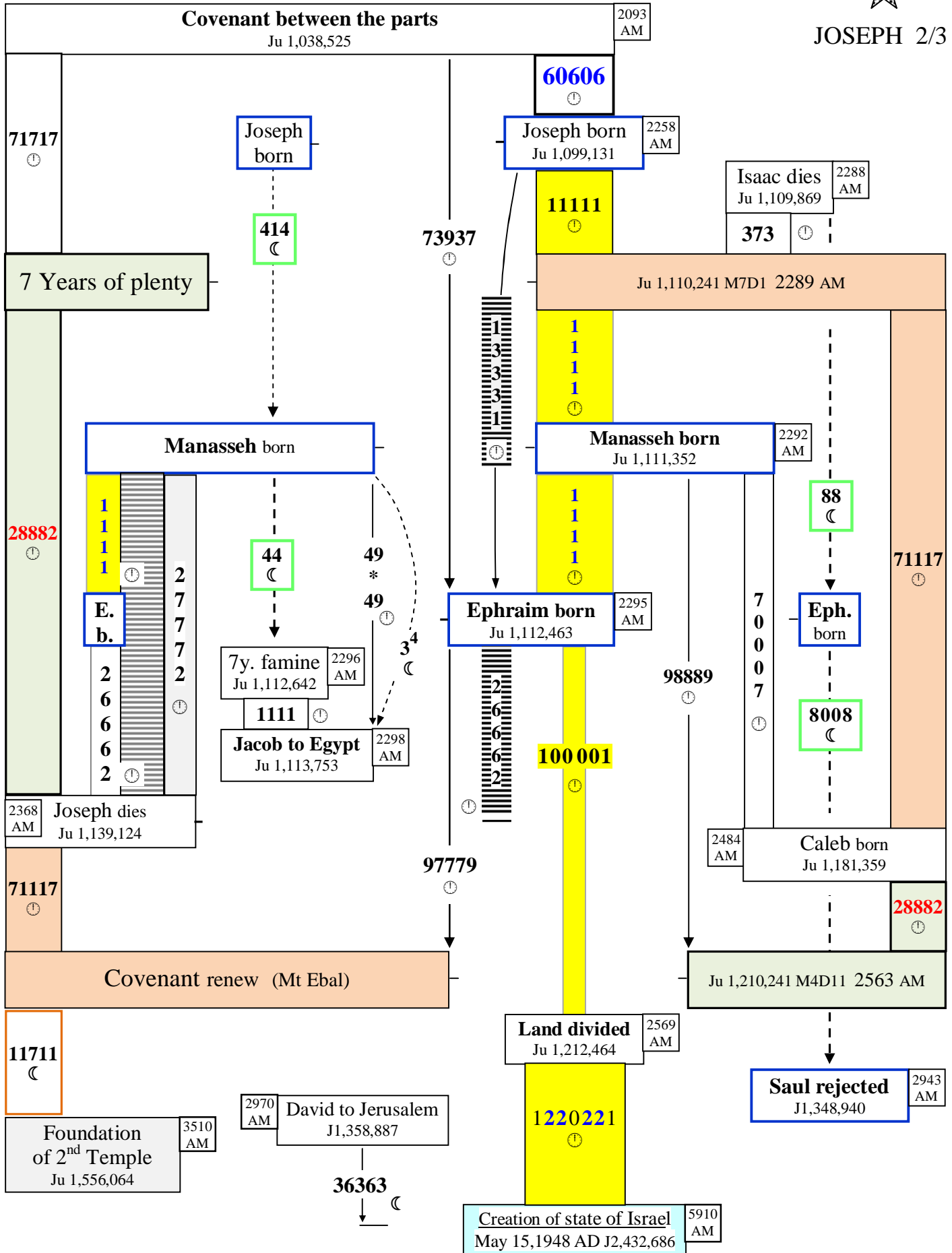

★
JOSEPH 3/3

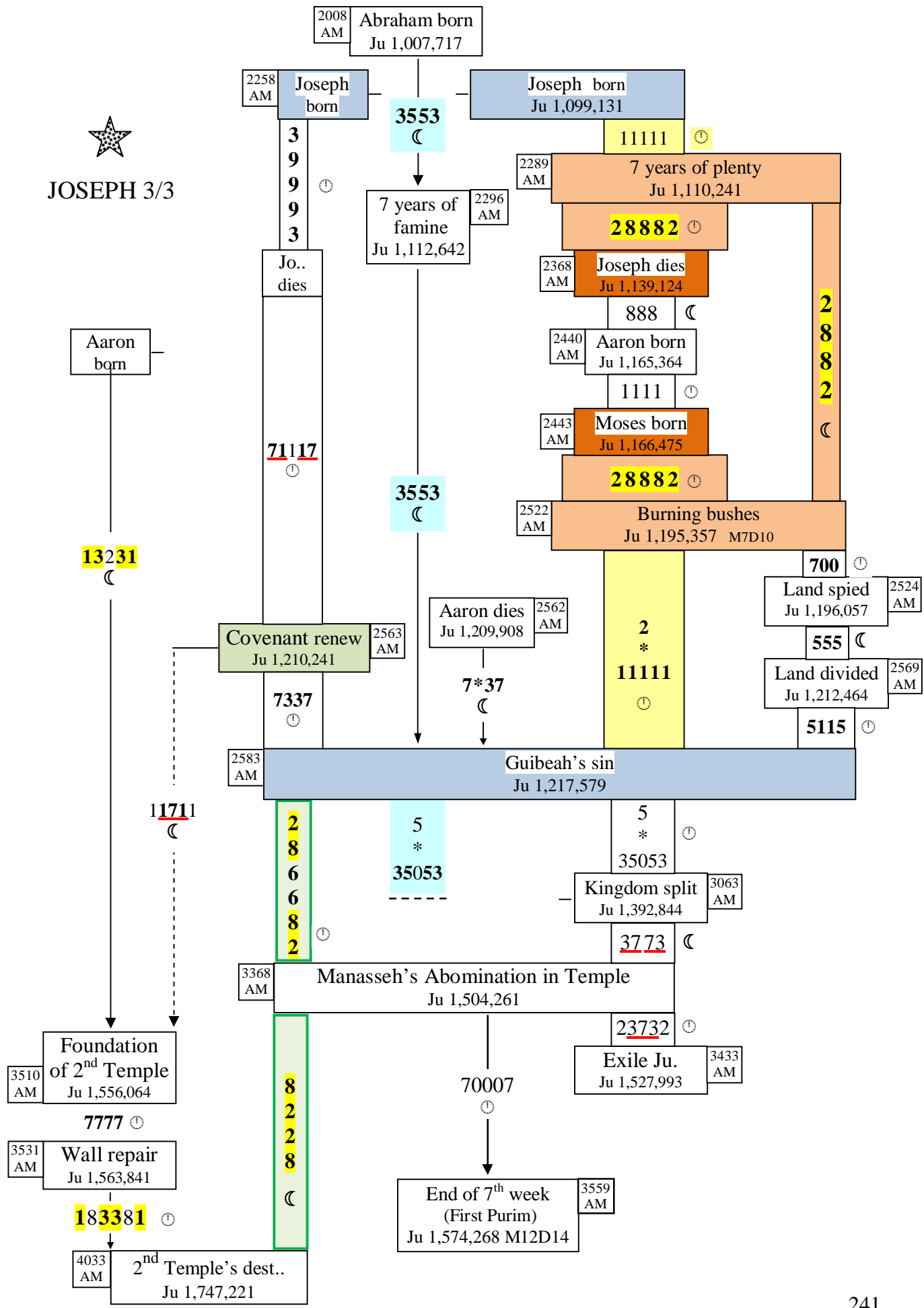



EXODUS

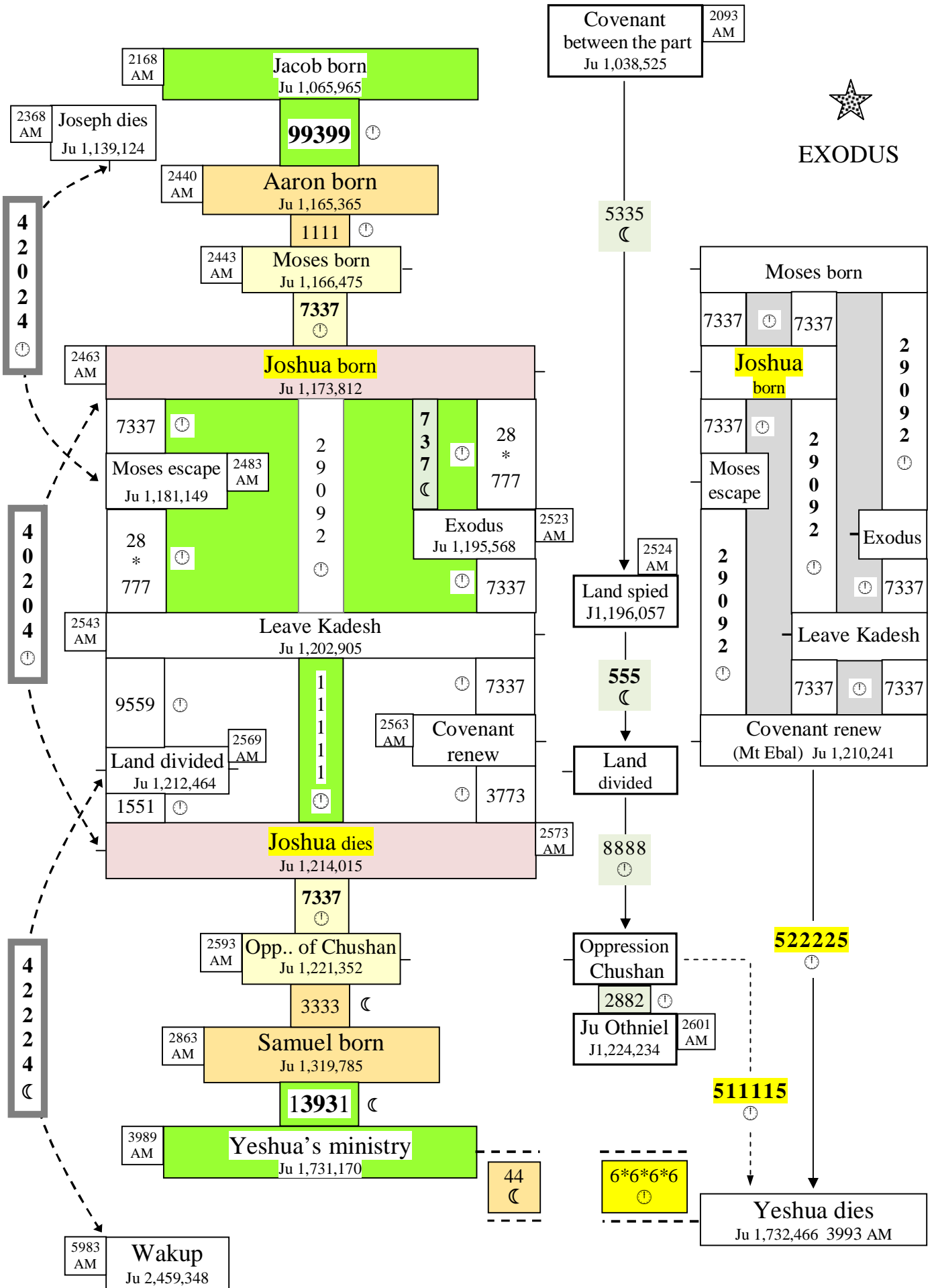

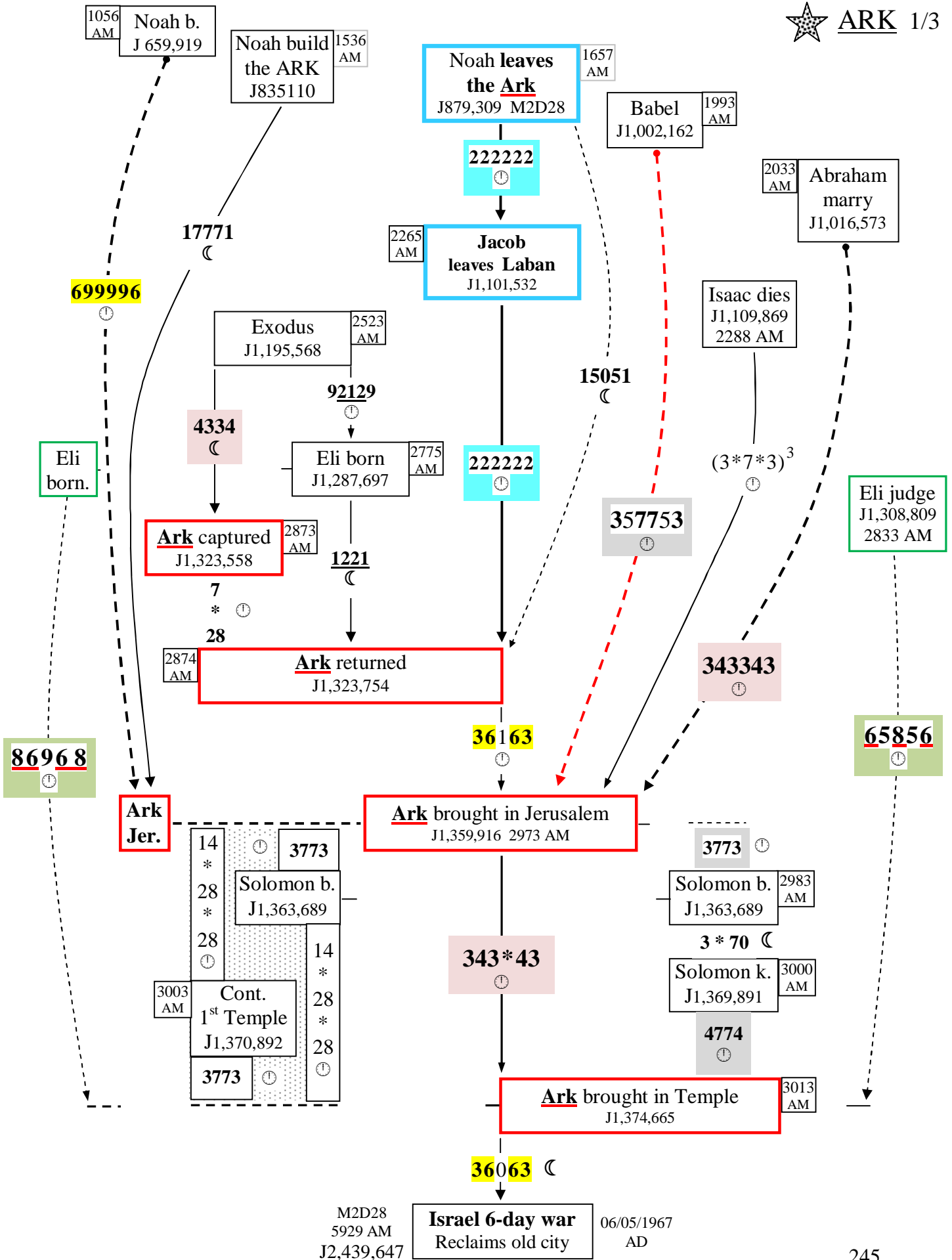



ARK 2/3

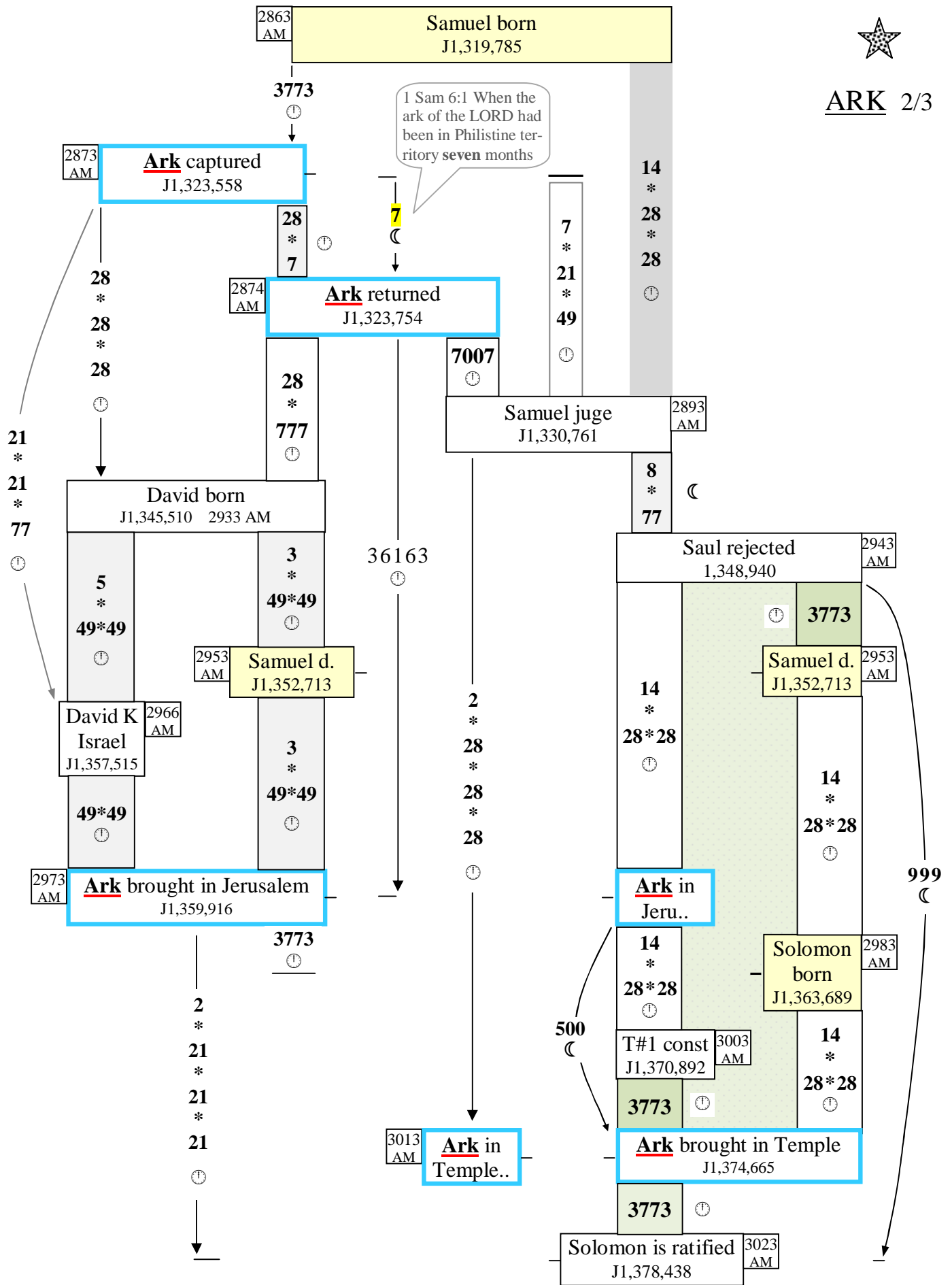



DAVID

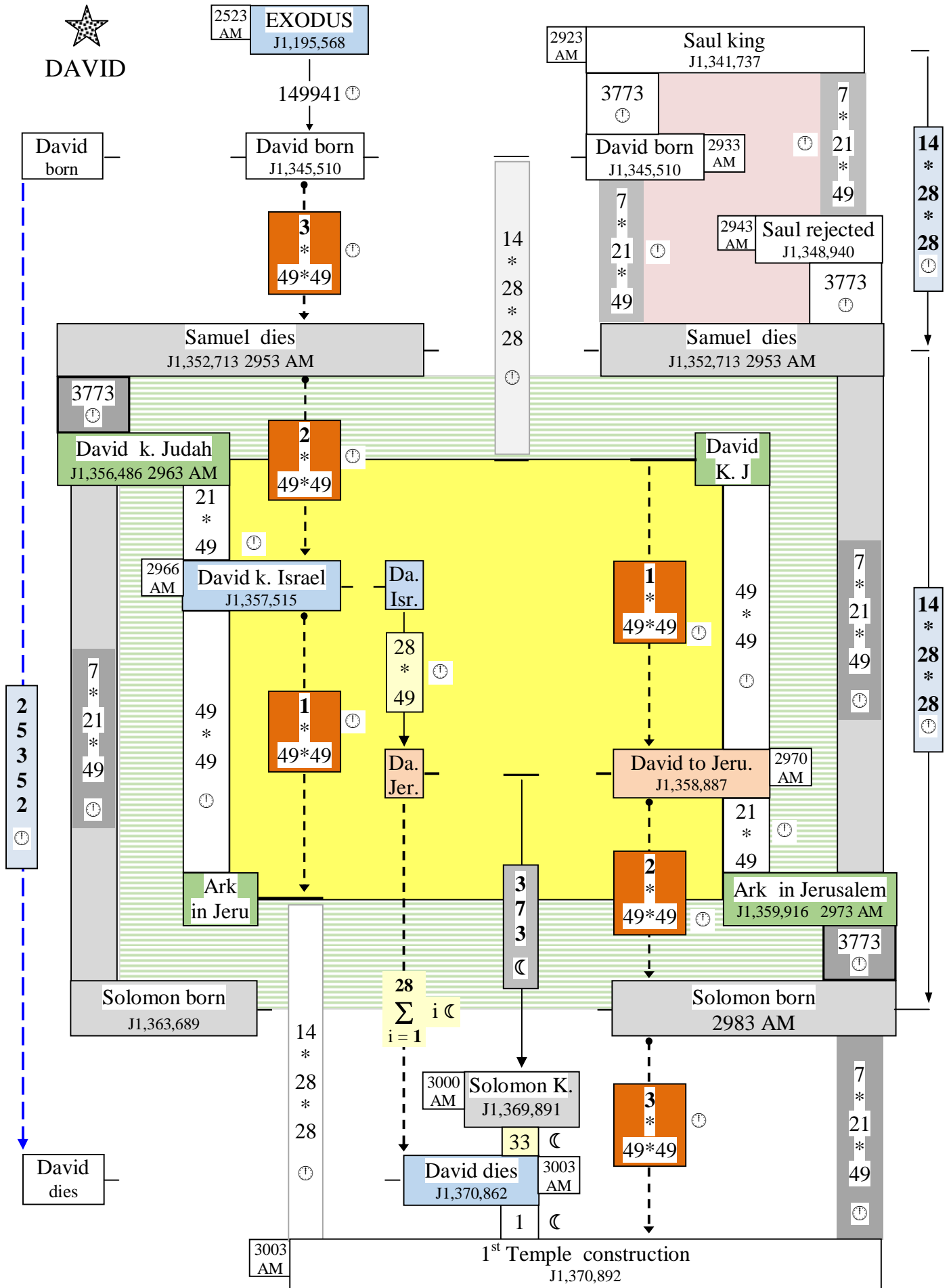



Post Exile 1/2

Ex.

Hag 1:15 on the twenty-fourth day of the sixth month in the second year of King Darius. NIV

Note: According to the Bible the **construction of the 2nd Temple** started on M6D24. What I suggest is **M13D25**. It is unlikely that the Bible is in error but not impossible. I have no satisfactory explanation.

2275 AM Joseph to Egypt J1,105,305

Exodus J1,195,568 2523 AM

15351 ☾

7 * 14 * 49 * 70

End of 1st Temple J1,531,709 3443 AM

21912 ☾ 21912 ☾

3503 AM Return of 42,360 exiles J1,553,662

2442 ☾

4*4*4 ☾

New altar J1,555,503 3508 AM

3510 AM Foundation of 2nd Temple J1,556,064

Foundation of 2nd Temple

2442 ☾ Foundation of 2nd Temple

3883 ☾

12621 ☾

1441 ☾ Const.. 2nd Temple J1,557,506 3513 AM

4994 ☾ Foundation of 2nd Temple

Const.. 2nd Temple M13D25

12221 ☾

6336 ☾ Neh. repairs the wall

1111 ☾ 2nd Temple is ready J1,373,636 MID13 ☆

11 * 929 ☾

215512 ☾

282 ☾

4444 ☾ End of Neh. Wall 1,568,285 3543 AM

8338 ☾

5225 ☾ 2nd Temple is ready J1,373,636 MID13 ☆

7777 ☾

3 * 2112 ☾

9669 ☾

Nehemiah repairs the wall J1,563,841 3531 AM

15651 ☾

End 7th week J1,574,268 3559 AM

183381 ☾

End of 2nd Temple J1,747,221 4033 AM

End of 2nd Temple J1,747,221

☆ Ezra 6:15 points to Adar 3 in 6th year of Darius. I got Adar 13 on 5th year of Darius. ??

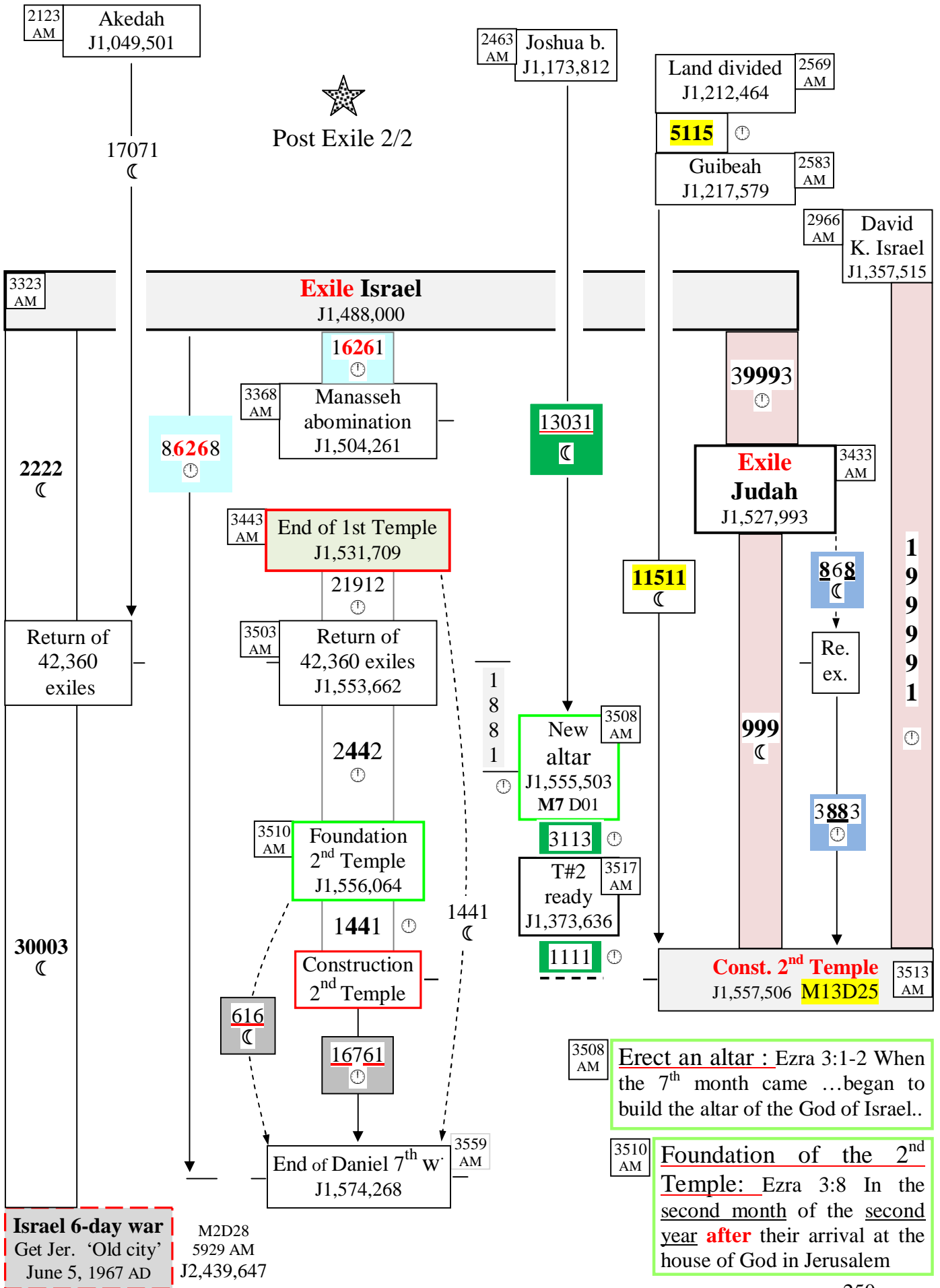

Israel 6-day war
 Get Jer. 'Old city'
 June 5, 1967 AD

M2D28
 5929 AM
 J2,439,647

3508 AM Erect an altar : Ezra 3:1-2 When the 7th month came ...began to build the altar of the God of Israel..

3510 AM Foundation of the 2nd Temple: Ezra 3:8 In the second month of the second year **after** their arrival at the house of God in Jerusalem

Appendix D

Synchronizing the Hebrew and the Gregorian calendar

It is only once the whole internal Bible's chronology has been figured out, when each event is properly positioned on the timeline 0 to 6,000 AM, that an external Gregorian date is needed but for the sole purpose of synchronizing both the 'AM' and the 'Gregorian' calendars. We saw on page 155 that Yeshua was born in 3960 AM of the Hebrew calendar. According to a research of Ernest Martin¹⁰⁶, based on the apparent motion of several celestial bodies (Sun, Moon, Jupiter, Venus, Mercury, Mars, Regulus) Yeshua was born in 3/2 BC on the Gregorian calendar. Using it (**3960 AM = 3/2 BC**) as an anchoring point, we can, without difficulties, figure out the Gregorian date corresponding¹⁰⁷ to the origine (0 AM) of the Am calendar.

If 3960 AM = 3/2 BC
 then 0 AM = 3/2 BC - 3960
 i.e. **0 AM = 3963/3962 BC**

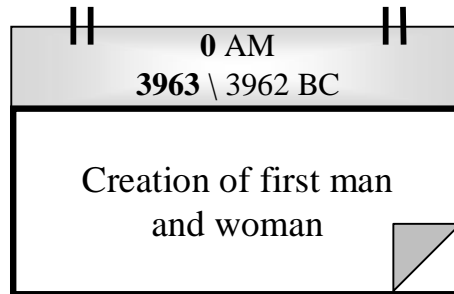



The following facts show that '3963'¹⁰⁸ is not a meaningless value:

Is it a coincidence that the earth's radius at the equator is **3963** miles? (same as year of man's creation)

By rotating the two middle digits of **3963** we still obtain 3963.

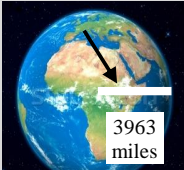
Is-it also a coincidence that the highest peak in Israel, Mount Meron in the upper Galilee, is **3,963** feet high.





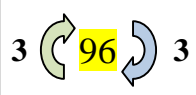

On his webpage, Tony Badillo makes a convincing case that Jachin and Boaz, the two pillars of the Temple (1 King 7:21) represent David and Solomon. As shown here, these two kings have also a role of pillar in the present chronology.

2963 AM	David King of Judah	1000 / 999 BC
3000 AM	Solomon King of Israel	963 / 962 BC

¹⁰⁶ The birth of Christ recalculated by Ernest Martin.

¹⁰⁷ Once both calendars (Gregorian and AM) are synchronized, it is a simple matter to figure out the gregorian date of every event addressed in the present book. (see Appendix F next page)

¹⁰⁸ German protestant mathematician and historian 'Philip Melanchthon' came to the same conclusion in his Chronicle: "The world was created in **3963 B.C.**" - **Philip Melanchthon 1497-1560**

Appendix E

The Bible's timeline

AM	Gregorian Calendar BC/AD	EVENT	Bible Ref.	More details
0	3963/3962 BC	Adam born		
130	3833/3832 BC	Seth born	Gen 5:3	
235	3728/3727 BC	Enosh born	Gen 5:6	
325	3638/3637 BC	Kenan born	Gen 5:9	
395	3568/3567 BC	Mahalalel born	Gen 5:12	
460	3503/3502 BC	Jared born	Gen 5:15	
622	3341/3340 BC	Enoch born	Gen 5:18	
687	3276/3275 BC	Methuselah born	Gen 5:21	
874	3089/3088 BC	Lamech born	Gen 5:25	
930	3033/3032 BC	Adam dies	Gen 5:5	
987	2976/2975 BC	Enoch dies	Gen 5:23	
1042	2921/2920 BC	Seth dies	Gen 5:8	
1056	2907/2906 BC	Noah born	Gen 5:28	
1140	2823/2822 BC	Enosh dies	Gen 5:11	
1235	2728/2727 BC	Kenan dies	Gen 5:14	
1290	2673/2672 BC	Mahalalel dies	Gen 5:17	
1422	2541/2540 BC	Jared dies	Gen 5:20	
1536	2427/2426 BC	Noah starts building the Ark	Gen 6:3 (1656 -120)	
1558	2405/2404 BC	Shem born	Gen 11:10	
1651	2312/2311 BC	Lamech dies	Gen 5:31	
1656	2307/2306 BC	Methuselah dies Flood	Gen 5:27 Gen 7:6	
1658	2305/2304 BC	Arphaxad born	Gen 11:10	
1693	2270/2269 BC	Shelah born	Gen 11:12	
1723	2240/2239 BC	Eber born	Gen 11:14	
1757	2206/2205 BC	Peleg born	Gen 11:16	
1787	2176/2175 BC	Reu born	Gen 11:18	
1819	2144/2143 BC	Serug born	Gen 11:20	

AM	Gregorian Calendar BC/AD	EVENT	Bible Ref.	More details	
1849	2114/2113 BC	Nahor born	Gen 11:22		
1878	2085/2084 BC	Terah born	Gen 11:24		
1948	2015/2014 BC	Haran born	This work		P. 225
1993	1970/1969 BC	Babel	Inference		P. 183
1996	1967/1966 BC	Peleg dies	Gen 11:19		
1997	1966/1965 BC	Nahor dies	Gen 11:25		
2006	1957/1956 BC	Noah dies	Gen 9:29		
2008	1955/1954 BC	Abram born	Gen 12:4		P. 141
2018	1945/1944 BC	Sarai born	Gen 17:17 2108 - 90		P. 142
2026	1937/1936 BC	Reu dies	Gen 11:21		
2033	1930/1929 BC	Abram marries	Inference		P. 173
2049	1914/1913 BC	Serug dies	Gen 11:23		
2063	1900/1899 BC	Abram leaves Ur (goes to Haran)	Inference		P. 171
2083	1880/1879 BC	Terah dies / Abram leaves Haran and goes to Canaan	Gen 11:32/12:4 2008 + 75		
2088	1875/1874 BC	Abraham goes to Egypt	Inference		P. 181
2093	1870/1869 BC	Pregnant Hagar ran away Covenant between the parts	Gen 16:3-4 2083 +10		P. 79
2094	1869/1868 BC	Ishmael born	This work	P. 79	
2096	1867/1866 BC	Arphaxad dies	Gen 11:13		
2107	1856/1855 BC	Covenant of circumcision	Gen 17:24 2008 + 99	P. 79	
2108	1855/1854 BC	Isaac born	Gen 17:17 (2008 + 100)	P. 142	
2123	1840/1839 BC	Binding of Isaac (AKEDAH)	2523 - 400	P. 84	
2126	1837/1836 BC	Shelah dies	Gen 11:15		
2145	1818/1817 BC	Sarai dies	Gen 23:1 2018 + 127		
2148	1815/1814 BC	Isaac marries	Gen 25:20 2108 + 40	P. 173	
2158	1805/1804 BC	Shem dies	Gen 11:11		

AM	Gregorian Calendar BC/AD	EVENT	Bible Ref.	More details
2168	1795/1794 BC	Jacob/Esau born	Gen 25:26 2108 + 60	P. 142
2183	1780/1779 BC	Abraham dies	Gen 25:7 2008 + 175	P. 79
2187	1776/1775 BC	Eber dies	Gen 11:17	
2208	1755/1754 BC	Esau marries	Gen 26:34 2168 + 40	
2231	1732/1731 BC	Ishmael dies	Gen 25:17 2094 + 137	
2245	1718/1717 BC	Jacob hired by Laban	Gen 31:41 2265 - 14 - 6	P. 144
2252	1711/1710 BC	Jacob marries Leah and Rachel	Gen 29:20 2245 + 7	
2253	1710/1709 BC	Reuben born	Gen 29:31 2252 + 1	P. 225
2255	1708/1707 BC	Levi born	(third son) 2253 + 2	
2258	1705/1704 BC	Joseph born	Gen 41:46 2288 - 30	P. 172
2259	1704/1703 BC	End of first 14 years	Gen 30:25 2258 + 1	
2265	1698/1697 BC	Jacob leaves Laban	Gen 31:41 2245+7+7+6	
2268	1695/1694 BC	Benjamin born	Inference	P. 142
2275	1688/1687 BC	Joseph goes to Egypt	Gen 37:2 2258 + 17	P. 142
2285	1678/1677 BC	Joseph sent to jail	Inference	P. 142
2286	1677/1676 BC	Joseph helps the chief baker	Gen 41:1 2288 - 2	P. 142
2288	1675/1674 BC	Isaac dies Joseph meets Pharaoh	Gen 35:28 2108 + 180 Gen 41:25 2289 - 1	P. 142
2289	1674/1673 BC	Start of 7 years of plenty Kohath born (Appendix C)	Gen 41:53 2296 - 7	P. 142
2291	1672/1671 BC	Manasseh born	Inference	P. 142

AM	Gregorian Calendar BC/AD	EVENT	Bible Ref.	More details
2295	1668/1667 BC	Ephraim born	Inference	P. 142
2296	1667/1666 BC	Start of 7 years of famine	Gen 45:10 2298 - 2	P. 142
2298	1665/1664 BC	Jacob in Egypt	Gen 47:28 2315 - 17	P. 144
2315	1648/1647 BC	Jacob dies	Gen 47:28 2168 + 147	P. 142
2366	1597/1596 BC	Amram born	Appendix C	
2368	1595/1594 BC	Joseph dies	Gen 50:26 2258 + 110	P. 142
2392	1571/1570 BC	Levi dies	Exo 6:16 2255 + 137	
2422	1541/1540 BC	Kohath dies	Appendix C	
2440	1523/1522 BC	Aaron born	Ex 7:7 2443 - 3	
2443	1520/1519 BC	Moses born	Deut 34:7 2563 - 120	P. 161
2463	1500/1499 BC	Joshua born	Josh 24:29 2573 - 110	P. 161
2483	1480/1479 BC	Moses escape from Egypt	Act 7:23 2443 + 40	P. 55
2484	1479/1478 BC	Caleb born	Josh 14:7 2524 - 40	P. 19
2503	1460/1461 BC	Amram dies	Appendix C	
2522	1441/1440 BC	Burning bushes	2523 - 1	P. 169
2523	1440/1439 BC	EXODUS	2093 + 430	P. 84
2524	1439/1438 BC	Tabernacle set up Leaves Sinai Land spied	Ex 40-17 2523 + 1	P. 169
2543	1420/1419 BC	Leaves Kadesh Barnea	Inference	P. 169
2563	1400/1399 BC	Aaron & Moses die Promised Land	Num 14:33-34 2523 + 40	P. 19
2569	1394/1393 BC	Land divided	Josh 14:10 2484 + 85	P. 19

AM	Gregorian Calendar BC/AD	EVENT	Bible Ref.	More details
2573	1390/1389 BC	Joshua dies	Act 13:16-20 2123 + 450	P. 161
2583	1380/1379 BC	Gibeah Sin	2973 - 390	P. 65
2593	1370/1369 BC	#1 Opp. Chushan	Inference	P. 161
2601	1362/1361 BC	Judge Othniel	Judg 3: 8 2593 + 8	P. 166
2641	1322/1321 BC	#1 Opp. Eglon	Judg 3:11 2601 + 40	P. 166
2659	1304/1303 BC	Judge Ehud	Judg 3:14 2641 + 18	
2677	1286/1285 BC	#3 Opp. Jabin	2659 + 18	P. 166
2697	1266/1265 BC	Judge Barak	Judge 4:3 2677 + 20	P. 166
2737	1226/1225 BC	12 years Gap no judges, no oppressions	Inference	P. 165
2749	1214/1213 BC	#4 Opp. Midian	Judg 6:1 2756 - 7	P. 166
2756	1207/1206 BC	Judge Gideon	Judg 8:28 2796 - 40	P. 166
2775	1188/1187 BC	Eli born	1 Sam 4:15 2873 - 98	
2796	1167/1166 BC	#5 Opp. Abimelec	Judg 8:22 2799 - 3	P. 166
2799	1164/1163 BC	Judge Tola	Judg 10:2 2822 - 23	P. 166
2822	1141/1140 BC	Judge Jair	Judg 10:3 2844 - 22	P. 166
2833	1130/1129 BC	Eli judge	1 Sam 4:18 2873 - 40	P. 55
2844	1119/1118 BC	#6 Opp. Ammon	Judg 10:8 2862 - 18	P. 166
2853	1110/1109 BC	#7 Opp. Philistines	Judg 13:1 2893 - 40	P. 166
2856	1107/1106 BC	Samson born		P. 187
2862	1101/1100 BC	Judge Jephtah	Jug 12:7 2868 - 6	P.166
2863	1100/1999 BC	Samuel birth	Inference	P 161
2868	1095/1094 BC	Judge Ibzan	Judg 12:9 2275 - 7	P 166

2870	1093/1092 BC	Judge Samson		P. 187
2873	1090/1089 BC	Ark is captured	2483 + 390	P. 55
2874	1089/1088 BC	Ark is returned	1 Sam 6:1 2873 + 7 mo.	
2875	1088/1087 BC	Judge Elon	Judg 12:11 2885 - 10	P. 166
2885	1078/1077 BC	Judge Abdon	Judg 12:14 2893 - 8	P. 166
2890	1073/1072 BC	Samson dies	Jud 16:31 2870 + 20	P. 187
2893	1070/1069 BC	Samuel judges	1 Sam 7:2 2873 + 20	P. 55
2923	1040/1039 BC	King Saul (40 y.)	Act 13:21 2963 - 40	P. 55
2933	1030/1029 BC	David born	2 Sam 5:4-5 2963 - 30	P. 55
2943	1020/1019 BC	Saul rejected ????	Inference	P. 177
2953	1010/1009 BC	Samuel dies	2523 + 430	P. 64
2963	1000/999 BC	King David (over Judah) Ish- Bosheth king over Israel	1 Chron 29:27 3003 - 40	P. 162
2965	998/997 BC	King Ish-Bosheth dies	2 Sam 2:10	P. 162
2966	997/996 BC	David king Israel	This work	P. 162
2970	993/992 BC	David moves to Jerusalem	2 Sam 5:4-5 2963 + 7	P. 55
2973	990/989 BC	Ark brought in Jerusalem	1 Chron 15:1 2970 + 3	P. 65
2983	980/979 BC	Solomon born	Inference	P. 188
3000	963/962 BC	King Solomon (17 years old) (will reign 63 years)	1 Kings 6:1 3003 - 4 th year	P. 188
3003	960/959 BC	Start of first Temple const.	2 Sam 5:4-5 2523 + 480	P. 55
3010	953/952 BC	1 st Temple is ready	1 Kings 7:38 3003 + 7	P. 55
3013	950/949 BC	Ark brought to Temple	3010 + 3	P. 65
3023	940/939 BC	Solomon is ratified by God Palace is ready	1 Kings 7:1 3010 + 13	P. 103
3063	900/899 BC	Solomon dies/Kingdom split K Rehoboam South Kingdom #1 K Jeroboam North Kingdom #1	1 Kings 11:42 3023 + 4 0	P. 103

AM	Gregorian Calendar BC/AD	EVENT		More details
3080	883/882 BC	K Abijah SK2		A.O.W
3082	881/880 BC	K Asa SK3		A.O.W
3084	879/878 BC	K Nadab NK2		A.O.W
3085	878/877 BC	K Baasha NK3		A.O.W
3108	855/854 BC	K Elah NK4		A.O.W
3109	854/853 BC	K Zimri NK5 K Tibni NK6 K Omri NK7		A.O.W A.O.W A.O.W
3113	850/849 BC	Foundation of Samaria	3503 - 390	P. 71
3120	843/842 BC	K Ahab NK8		A.O.W
3123	840/839 BC	K Jehoshaphat SK4		A.O.W
3140	823/822 BC	K Jehoram SK5 K Ahaziah NK9		A.O.W
3141	822/821 BC	K Joram NK10		A.O.W
3151	812/811 BC	K Ahaziah SK6		A.O.W
3152	811/810 BC	Q Athaliah SK7 K Jehu NK11 K Joash SK8		A.O.W A.O.W A.O.W
3175	788/787 BC	K Jehoahaz NK12		A.O.W
3189	774/773 BC	K Jehoash NK13		A.O.W
3191	772/771 BC	K Amaziah SK9		A.O.W
3206	857/856 BC	K Jeroboam II NK14		A.O.W
3233	830/829 BC	K Uzzia SK10		A.O.W
3271	692/691 BC	K Zecharia NK15		A.O.W
3272	691/690 BC	K Shallum NK16 K Menahem NK17		A.O.W
3283	680/679 BC	K Pekahiah NK18		A.O.W
3285	678/677 BC	K Pekah NK19 K Jotham SK11		A.O.W
3302	661/660 BC	K Ahaz SK12		A.O.W
3303	660/659 BC	ISAIAH foretells that Ephraim will be broken (Israel doom)	Isa 7:8-9 3368 - 65	P. 96
3314	649/648 BC	K Hoshea NK20		A.O.W

AM	Gregorian Calendar BC/AD	EVENT		More details
3317	646/645 BC	K Hezekiah SK13	A.O.W	A.O.W
3323	640/639 BC	EXILE of Israel	2 Kings 18:10 3314 + 9	P. 92
3328	635/634 BC	Hezekiah's Passover	3368 - 40	A.O.W
3333	630/629 BC	K Manasseh SK14	3443 - 110	P. 16
3368	595/594 BC	Manasseh sets an ABOMINATION in the Temple	3333 + 35	P. 16
3388	575/574 BC	K Amon SK15	2 kings 21:19 3390 - 2	P. 16
3390	573/572 BC	K Josiah SK16	2 kings 22:1 3421 - 31	P. 16
3403	560/559 BC	Jeremiah prophesies	Jer 25:1-3 3390 + 13	P. 57
3408	555/554 BC	Josiah's Passover	2 Kings 23:23 3390 + 18	P. 57
3421	542/541 BC	K Jeohaz SK17 K Jehoiakim SK18	2 Kings 23:36 3432 - 11	P. 16
3423	540/539 BC	Start of Babylon 70 years	Jer 25:11 3493 - 70	P. 170
3424	539/538 BC	King Nebuchadnezzar		
3432	531/530 BC	K Jehoiachin SK19 K Zedekiah SK20	2 Chron 36:11 3443 - 11	P. 57
3433	530/529 BC	EXILE of Judah	2 King 24 :13-17	P. 71
3443	520/519 BC	<u>End of first Temple</u> (start of 70 years of desolation)	3013 + 430	P. 63
3493	470/469 BC	Fall of Babylon's empire King Darius (the mede)	3063 + 430	P. 102
3502	461/460 BC	King Cyrus	3503 - 1	P. 128
3503	460/459 BC	Return of the 42,360 exiles (end of Judah's exile)	Jer 29:10 3433 + 70	P. 71
3508	455/454 BC	Exiles set an Altar	3510 - 2	P. 250
3510	453/452 BC	<u>Foundation of 2nd Temple</u> (start of Daniel's 70 weeks)	3503 + 7	P. 128
3511	452/451 BC	King Darius (Artaxerxes)	3502 + 9	P. 121
3513	450/449 BC	Construction of 2 nd Temple starts	3511 + 2	P. 128

AM	Gregorian Calendar BC/AD	EVENT	Bible Ref.	More details
3517	446/445 BC	2 nd Temple is ready	Ezra 4:24,6:15 3513 + 4	P. 121
3531	432/431 BC	Start of Nehemiah's wall's repairs	Neh 2:1 3511 + 20	P. 120
3543	420/419 BC	Nehemiah's wall fully repaired	Neh 5:14 3531 + 12	P. 120
3547	416/415 BC	King Xerxes (Book of Esther)	Est 3:7 3559 -12	P. 128
3559	404/403 BC	First Purim (end of Daniel first 7 weeks)	Dan 9:25 3510 + 49	P. 128
3943	20/19 BC	Herod renovates the Temple	3513 + 430	P. 110
3960	3/2 BC	Yeshua born	Inference	P. 155
3972	10/11 AD	Yeshua in Temple at 12 years old	Luc 2:42 3960 + 12	P. 155
3989	27/28 AD	Start of Yeshua's ministry	3559 + 430	P. 138
3993	31/32 AD	Yeshua dies (end of Daniel first 69 weeks)	Dan 9:25 3510 + 483	P. 116
4033	?? 71/72 AD ??	End of 2 nd Temple	Jonah's prophecy	P. 155
4658	696/697 AD	Dome of the Rock completed ?		p. 2687
5983	2021/2022 AD	Recall of the northern lost tribes? --WAKUP--	Inference	P. 176
5993	2031/2032 AD	Start of Daniel's 70 th week	6000 - 7	P. 217

Notice that contrary to the popular belief, I have the destruction of the 2nd Temple in **71 AD**. Have I been careless somehow in my chronology? Do you know that the Jewish sage cannot make their mind if the Temple came down in 69 or 70 AD? In fact the Talmud says that the Temple stood 420 years and the Jewish sage debate if it means that it was destroyed in its 420th year, or after it had been standing up for a full 420 years. According my chronology the Temple came down 520 years after the start of its construction. (Observe how my 520 years value is strangely similar to the Talmud 420 years. Have the earliest Talmudic writers wrongly recorded 420 years instead of 520? I believe so).

To the Jews our Gregorian year 2000 AD was equivalent to their year 5760 AM. They really seem to be offset about 200 years¹⁰⁹. Unfortunately they won't be aware of their mistake as long as they will persist denying that Yeshua was the Messiah they had been waiting for.

¹⁰⁹ R' Azariah dei Rossi, in *Me'or Einayim* (c. 1573), was likely the first Jewish authority to claim that the traditional Hebrew dating is not historically precise regarding the years before the Second Temple.

Appendix F Daniel 8:14 '2300 evenings and mornings'

Daniel Chapter 8 describes a vision in which a Goat with a single horn quickly and furiously attacks a two horns Ram (Dan 8:7-8). The bible tells us that the Ram represent the Persian (Dan 8:20) and the Goat represent the Grecian (Dan 8:21) empire.

It is a known fact that Darius III, the Persian King, was defeated 3 times by the greek army of Alexander the Great (**battles of Granicus in 334 BC, Issus in 333 BC, Gaugamela in 331 BC**). Theses battles marked the end of the Persian empire (Ram) and the consolidation of the Grecian empire (Goat).

The collapse of the Persian empire brought to an end the peaceful control they had over Jerusalem. (In the past, the Persian had facilitated the return of Judah exiles, contributed to the erection of the second Temple and allowed the rebuilding of the city.) When the Greeks invaded Asia for the first time (battle of Granicus 334 BC), an hostile period of domination over the Persian's territories and Jerusalem was initiated.

A few years ago, in a book called 'Restoring Abrahamic Faith' by James Tabor, I read about a prediction done in 1825 AD by the British Methodist Adam Clarke. According Mr. Clarke, the '2300 evenings and mornings' period mentioned in Dan 8:14, should be counted from the time of the **Battle of Granicus in 334 BC**. Unaware of it, Mr. Clarke had just linked, a century before it happened, the Greek's domination over Jerusalem and the **1967 Israel 6-day war**. During the 6-day war the Jews regained, for the first time in 2300 years, full sovereignty over Jerusalem old city and the Temple mount¹¹⁰.

Should the 2300 evenings and mornings of Daniel 8:14 be interpreted as 2300 years? I don't believe that there is a systematic 'Day for Year' principle in Bible prophecy¹¹¹. However, the key¹¹² to understand the somewhat cryptic usage of 'evenings and mornings' in Daniel's prophecy can be found in Exodus 12:6,10

- Ex 12:6 And ye shall keep it up until the fourteenth day of the same month: and the whole assembly of the congregation of Israel shall kill it in the **evening**¹¹³ KJV
- Ex 12:10 And ye shall let nothing of it remain until the **morning**; and that which remaineth of it until the morning ye shall burn with fire. KJV

Daniel 'evenings and mornings' (a forgotten idiom ??) don't represent, strictly speaking, a unit of time. It rather refers to the Passover which starts on the 14th day of the first month of the Hebrew calendar and ended in the early morning of the 15th day. Incidentally 2300 'evening and morning' (2300 Passover's sacrifices) do represent a period of time that covers 2300 years.

¹¹⁰ *We have returned to all that is holy in our land. We have returned never to be parted from it again.* -Defense Minister Moshe Dayan, upon reaching the Western Wall

¹¹¹ Indeed Ezekiel 4 uses the day = year principle but this is explicitly requested in Ezek 4:5; During Exodus God kept the Israelites 40 years in the desert because of the outcome of the 40-day spy mission. Here too the day = years is justified, see Num 14:34; In Daniel 9 we read about the 70 weeks prophecy. It should be noted here that the original expression is 70 '7' without specifying if 'days' 'months' or 'years' are intended.

¹¹² I learn this from Dan Bruce's article 'Want proof of God? Check this out'

¹¹³ **Evening** (from "haa`arbaayim" IE. Between the two evenings = middle of the afternoon)

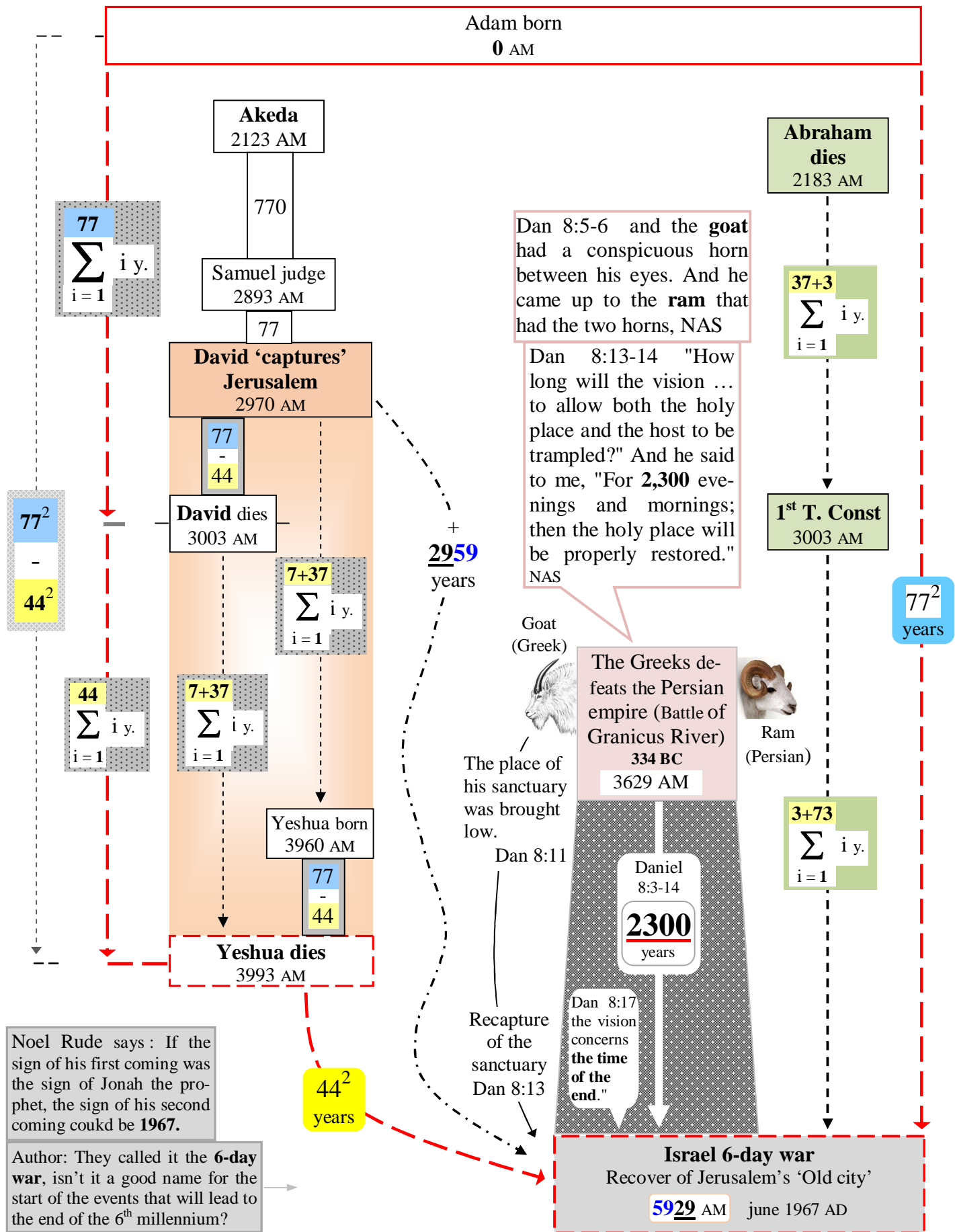

Appendix G Daniel 12:11-12

'1290 days & 1335 days'

(This topic is speculative in spite of two meaningful markers)

- Dan 12:11-12 "From the time that the **daily sacrifice is abolished** and the **abomination that causes desolation** is set up, there will be **1,290 days**. ... **Blessed is the one who waits for and reaches the end** of the **1,335 days**. NIV

The prophecy covers a period of 2625 days or years (1290 + 1335). We are not told if the units are days or years but lets assume they are years and see where that leads. According Dan 12:9 this prophecy would be understood only at the time of the end. This could mean that the prophecy will conclude at that time.

- Dan 12:9 Go your way, Daniel, because the words are closed up and sealed until the time of the end. NIV

Daniel 12:11-12					Dan 9:27
daily sacrifice is abolished	1,290 years	Abomination that causes desolation is set up	1,335 years	Blessed those who reach this point	Time of the end
2625 years					7 years

(We will see in the next appendix (H) that the time of the end overlaps with the 7 years of Daniel 70th week.)

Here is how Daniel describes the 70th week.

- Dan 9:27 During one week he will make a firm covenant with many. **For half a week he will put a stop to the sacrifice** and the meal offering. At the corner [of the altar] will be an appalling abomination ... (The Jewish Study Bible)
- Dan 11:30-31 So he shall return and show regard for those who forsake the holy covenant. And forces shall be mustered by him, and they shall **defile the sanctuary** fortress; then they shall **take away the daily sacrifices**, and **place there the abomination of desolation**. NKJV

Time of the end				
Covenant set up		Daily Sacrifice stopped		End of 70 th week
Daily sacrifice initiated	3.5 years	Abomination in the Temple	3.5 years	6000 AM
5993 AM		5996 AM		
Daniel 70th week (end time = 7 years)				

Given that the daily sacrifices mentioned in Daniel 9:27 will be brought to an 'end' half way through the 7-year covenant (when the 'abomination' is brought in the Temple), it is not unreasonable to deduce that these daily sacrifices were initiated at the very beginning of that 7 years covenant (i.e in 5993 AM as seen in p 218).

With a better understanding of the time of the end we can now have this representation of the 1,290 & 1335 years. As we can see the sequence starts in 3368 AM (5993 – 2625) and is bookmarked by two periods of **daily sacrifice**.

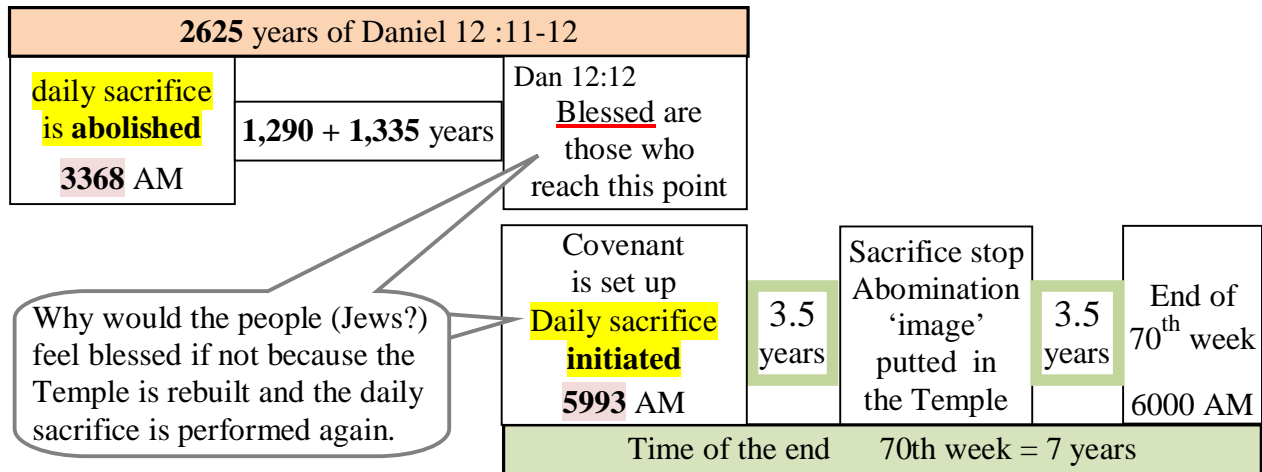

Earlier in this book we came across a very important event that took place in **3368 AM**¹¹⁴. We saw that King Manasseh setted an abomination in the Temple on this very year. The impact of this event was so important that it was at the origin of the period portrayed by Ezekiel when he was lying on his right side for 40 days. Now if bringing a blasphemous image in the Temple in 5996 AM will result in the **cessation of the daily sacrifice**, we have all the raisons to believe that the same thing happened when King Manasseh brought a carved image¹¹⁵ in the first Temple in 3368 AM.

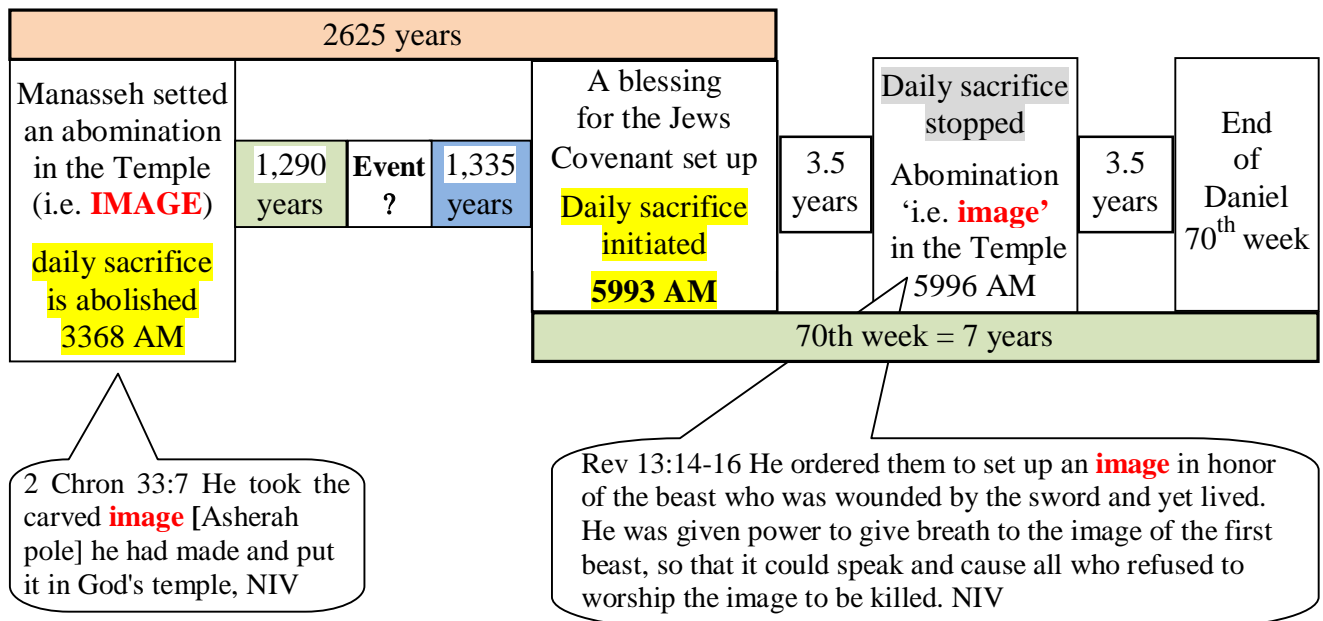

Could there be any doubts left on the origine and the end point of the period (1,290 + 1,335 years)? In each case a daily sacrifice was involved. Next page will see what kind of “abomination that causes desolation” could have taken place between the 1,290 and the 1,335 years.

¹¹⁴ See table in Appendix E on page 254

¹¹⁵ The Temple was left desecrated for 40 years and it took a lot of effort from King Josiah and the priest to purify the Temple again. It is very unlikely that any daily sacrifice was performed during that time.

Manasseh's Abomination in the Temple
daily sacrifice stopped
 3368 AM

Jer 7:30 For the children of Judah have done evil in my sight, saith the LORD: they have set their abominations in the house which is called by my name, to pollute it. KJV

2 Chron 33:7 And he [Manasseh] set a carved image, the idol which he had made, in the house of God, KJV

From the daily sacrifice abolition
 1290 years
 to the abomination 'desolation' set up

Did something of any importance happened in years 4658 AM (696/697 AD)? Do you know that the **Dome of the Rock**, occupying the central point of the Temple Mount in Jerusalem, was **supposedly** completed in **691 AD** under the order of **Umayyad Caliph Abd al-Malik**. Let's imagine that the historical date of 691 AD is a few years offset and the Dome of the Rock **was in fact completed in 696 AD (4658 AM)**.

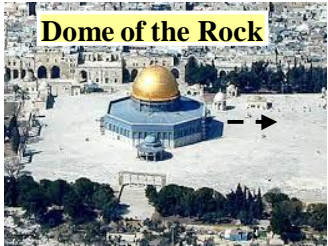

From the very beginning, the dominating presence of that shrine over Jerusalem promoted the superiority of the Islamic faith over Judaism and Christianity. It is hard not to see here a major turning point in the existence of Jerusalem.

What abomination could have been **set up** in **4658 AM (696/697 AD)** ?

To the Jews of Jerusalem and those around the world the presence of the Dome of the Rock over the city has been an **abomination ever since**.

Blessed is the one who waits for
 1335 years
 and reaches the end

Note 1: It is erroneously believed that the 'Dome of the Rock' occupies the exact location where the two Jewish Temples stood in the past. In fact the two Jewish Temples were outside and south of the present 'allege' Temple Mount.
 See **Marilyn Sams** 'The Jerusalem Temple Mount Myth'

Note 2: It doesn't mean that the 3rd Temple won't be built on that very spot given that this Temple is destined to be occupied by a false God (i.e. the Antichrist) and will be destroyed during the day of the Lord.

Start of Daniel's 70th week
Daily sacrifice initiated
 5993 AM

According Daniel 12:9 the meaning of the 1290 and 1335 years will be understood only at the time of the end. — ? → Why would it matter that the prophecy be understood only **at the time of the end**, unless the period (1290 + 1335 years) reaches that time?

Dan 12:12 **Blessed** is the **one** who waits for and reaches the end of the **1,335** days.

— ? → What could be the **blessing** at the end of the combined period of 1290 & 1335 years? Notice that the whole period started with the desecration of the Temple (thus an interruption of the sacrifice). Also notices that the blessing are addressed to the **Jews**?

*Note: The prophecy is addressed to Daniel's people of the latter day. (see Dan 10:14)
 Daniel was a Jew (Dan 1:6) so Daniel's people are Jews.*

❖ Couldn't the blessing be related to the construction of the Jewish third Temple **and the resuming of the daily Sacrifice** at that Temple?
It would make a lot of sense wouldn't it?

See an unexpected pattern in p. 196

Appendix H Daniel's 70th week

Earlier in this book we have looked at the chronology of the first 69 weeks of Daniel 70 week prophecy (see page 113 & chart 28 on page 217), we will now look at the 70th week.

- Dan 9:27 He will confirm a covenant with many for one 'seven.' In the middle of the 'seven' he will put an end to sacrifice and offering. And on a wing [of the temple] he will set up an **abomination** that causes desolation, until the end that is decreed is poured out on him." NIV **Note:** sacrifice and offering were the Temple daily ritual

Here are some interesting facts related to the 70th week:

- The ruler will confirm a 7 years' covenant at the beginning of the 70th week
- The ruler will break the covenant in the middle of that week. (i.e. after 3.5 years)
- The ruler will put an end to the sacrifice in the middle of the week
- we deduce that the **Sacrifice started** at the beginning of that week (i.e. in year 5993 AM)

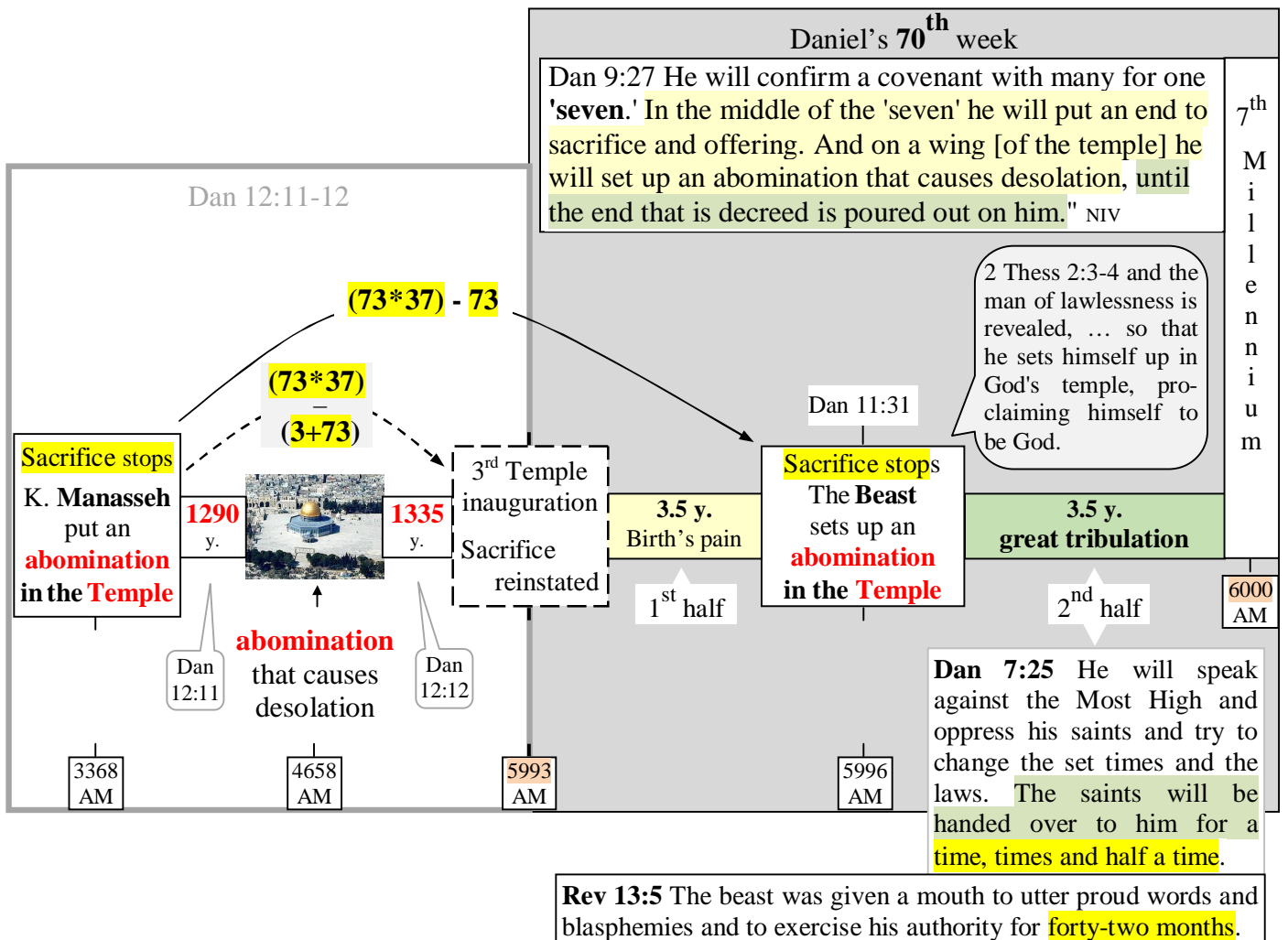

- Matt 24:3 ... "Tell us," they said, "when will this happen, and what will be the sign of your coming and of the end of the age?"
- Matt 24:15-22 "Therefore when you see the **'abomination of desolation,'** spoken of by Daniel the prophet, **standing in the holy place**" [let those who are in Judea **flee**] For then there will be **great tribulation, such as has not been since the beginning of the world until this time, no, nor ever shall be.** And unless those days were shortened, no flesh would be saved; NKJV

The first period is call the Birth pain

- Matt 24:4-8 "Watch out that no one deceives you. For many will come in my name, claiming, 'I am the Christ,' and will deceive many. You will hear of wars and rumors of wars, but see to it that you are not alarmed. Such things must happen, but the end is still to come. Nation will rise against nation, and kingdom against kingdom. There will be famines and earthquakes in various places. **All these are the beginning of birth pains.** NIV

The second period is associated with the ‘ruling’ of the beast (antichrist) . The period starts in the middle of Daniel’s 70th week, when the beast pretends to be God and sits in the Temple, and the period ends with the ‘day of the Lord’.

Start	Matt 24:15 "So when you see standing in the holy place 'the abomination that causes desolation, NIV	
	Rev 13:5 The beast was given a mouth to utter proud words and blasphemies and to exercise his authority for forty-two months. NIV	End

Note: Going backward 42 months from the beginning of the new millennium i.e. years 6000 AM (after the End time events are completed) bring us back in the middle of 5996 AM, i.e. in the middle of the 70th week of Daniel (beginning of the second period).

The day of the Lord represents the sum of events that will occur during the apocalyptic time of God's wrath. This final period will come just before the start of the 7th millennium, it will be introduced during the opening of the 7th seal and will conclude with the battle of ARMAGEDDON.

- Rev 8:1-6 When he opened the seventh seal, there was silence in heaven for about half an hour. And I saw the seven angels who stand before God, and to them were given seven trumpets. ... Then the angel took the censer, filled it with fire from the altar, and hurled it on the earth; and there came peals of thunder, rumblings, flashes of lightning and an earthquake. Then the seven angels who had the seven trumpets prepared to sound them.

Note The beast will become the supreme ruler of the world once he has broken the covenant in the middle of the 70th week. He will keep his authority until he is captured at the battle of Armageddon.

- Rev 19:19-20 Then I saw the beast and the kings of the earth and their armies gathered together to make war against the rider on the horse and his army. But the beast was captured, and with him the false prophet who had performed the miraculous signs on his behalf. NIV

Given that the beast will rule for 42 months (Rev 13:5) we can deduce that the Battle of Armageddon will occur at the very end of Daniel’s 70th week.

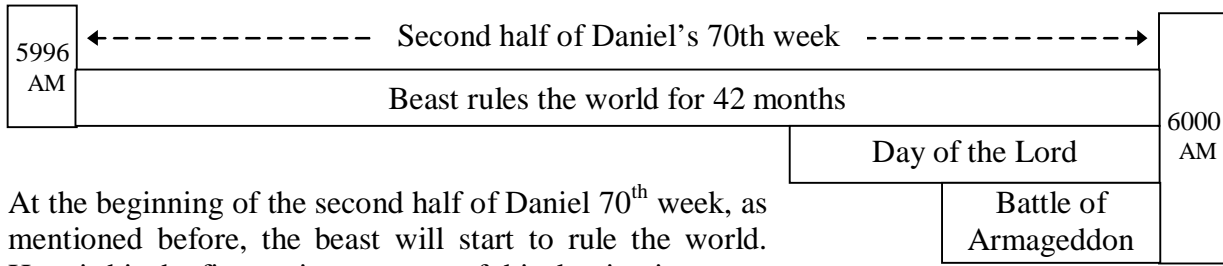

At the beginning of the second half of Daniel 70th week, as mentioned before, the beast will start to rule the world. Here is his the first major outcome of this domination.

- Matt 24:9 "Then you will be handed over to be persecuted and put to death, and you will be hated by all nations because of me. NIV
- Rev 13:7-8 He was given power to make war against the saints and to conquer them. And he was given authority over every tribe, people, language and nation. NIV

Understand here that only a specific group of people will be persecuted¹¹⁶, put to death, and hated by the whole world. The bible refer to this event as the **Great tribulation**.

- Matt 24:21 For then shall be great **tribulation**, such as was not since the beginning of the world to this time, no, nor ever shall be. KJV
- Matt 24:10-12 At that time many will turn away from the faith and will betray and hate each other, and many false prophets will appear and deceive many people.

Notice also that this persecution will be cut short

The next chart shows that the Great tribulation doesn't occupy the whole 3.5 years of the second half of the 70th week. If it was the case it would contradict Matt 24:22 who says that the tribulation was cut short.

- Matt 24:22 If those days had not been cut short, no one would survive, but for the sake of the elect those days will be shortened. NIV

And what more logical way to cut short the tribulation than having the 'day of the Lord' start immediately after?

- Rev 8:1-2 When he opened the seventh seal, ... And I saw the seven angels who stand before God, and to them were given seven trumpets. NIV

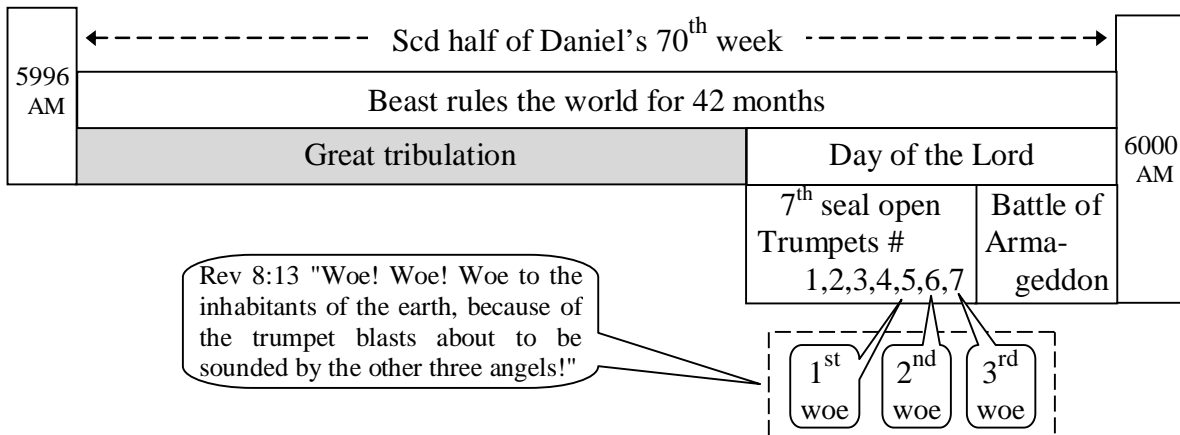

¹¹⁶ As opposed to the first period (the birth pain) when no individual would be specifically targeted. Wars and rumor of war affect people indiscriminately.

Who will be the persecuted people of the Great Tribulation? Notice that Matt 24:9-14 was given as a private answer to the disciples and it was done in a way that could have made them expect the worse for their own life in the coming years. We know now that the first century's disciples didn't have to endure any apocalyptic tribulation. Why then, did Yeshua intimate that they would?

Could it be that Yeshua's words were pointing at his own disciples because, by formulating them that way, He knew that centuries later the right group of people would understand that the words were for them? It seems to be the proper way to analyze the facts and therefore we should find out who was truly addressed in Yeshua's answer by responding to this simple question. What is the main characteristic one needs to have to be a true 'disciple' of Yeshua? Isn't it to believe the words given by Yeshua and become faithful to Him?

Therefore one can say that by extension the group of people who will be persecuted in Yeshua's answer will be those who believe in him during the second part of the 70th week of Daniel. Don't make the mistake to identify the victims of this tribulation with the Jews. The Jews don't and won't believe in Yeshua until his second coming. And don't think either that the Antichrist, the ruler of the end time, will persecute the multitude who 'will accept' his message. On the contrary those who will submit to the beast will receive a mark and will be under his protection.

- Rev 13:16-17 He also forced everyone, small and great, rich and poor, free and slave, to receive a mark on his right hand or on his forehead, so that no one could buy or sell unless he had the mark, which is the name of the beast or the number of his name. NIV

Thus, the victims of the great tribulation will be the Christians who will refuse to worship the beast. (those who will remain faithful to Yeshua).

- Rev 13:7-8 He [*the beast*] was given power to make war **against the saints** and to conquer them. And he was given authority over every tribe, people, language and nation. All inhabitants of the earth will worship the beast—all whose names have not been written in the book of life belonging to the Lamb NIV

In the previous chart the Tribulation is followed by the Day of the Lord. Now if 'the days of the tribulation' are cut short **to prevent the dramatic consequence of an ongoing persecution** and if the Day of the Lord's purpose is to punish everybody alive at the time then there must be something between these two periods that will protect the elects from having to suffer twice. If it was not the case, the following would be highly misleading

- Matt 24:13 but he who stands firm to the end will be saved. NIV
- Matt 24:31 1 And he will send his angels with a loud trumpet call, and they will gather his elect from the four winds, from one end of the heavens to the other. NIV

When Yeshua will return at the beginning of the 'Day of the Lord', his first action¹¹⁷ will be to **'rapture'** those alive (i.e. the Christians who won't wear the mark of the beast) and those who died for his name.

¹¹⁷ 2 Thess 2:1 1 Concerning the coming of our Lord Jesus Christ and our being gathered to him, NIV

←----- Second half of Daniel's 70th week -----→

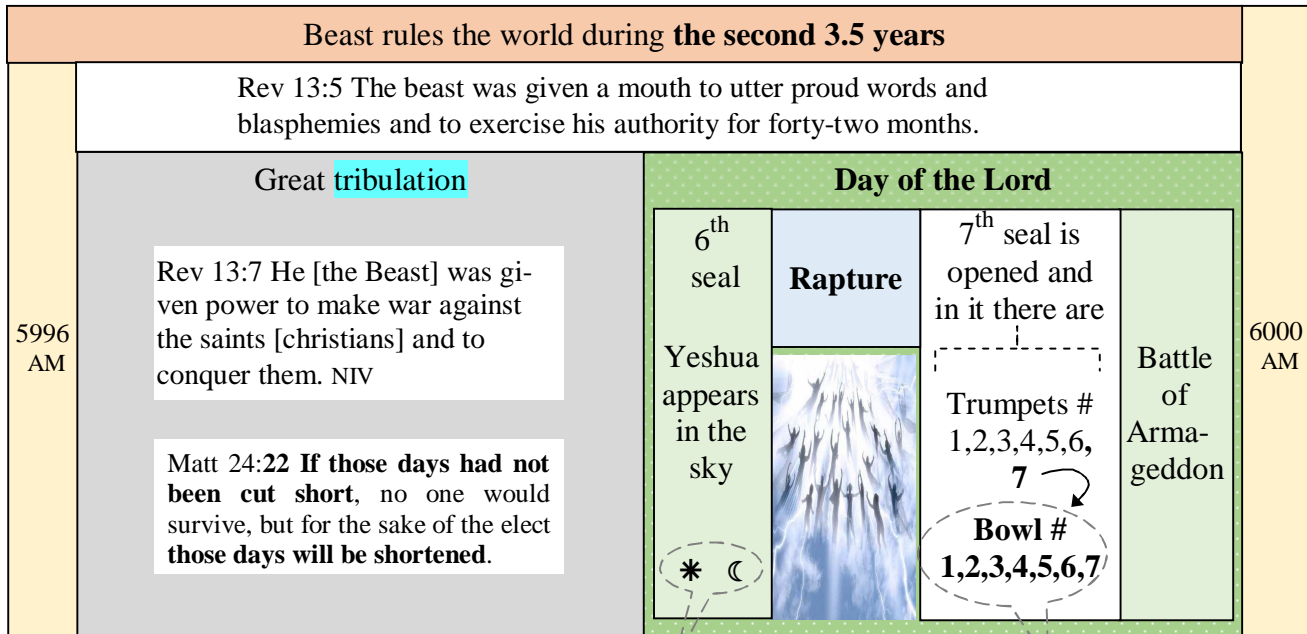

-Joel 2:31 The sun * will be turned to darkness and the moon ☾ to blood before the coming of the great and dreadful day of the LORD.
 -Acts 2:20 the sun * will be turned to darkness and the moon ☾ to blood before the coming of the great and glorious day of the Lord.
 -Matt 24:29-30 "Immediately after the distress [i.e. tribulation] of those days "the sun * will be darkened, and the moon ☾ will not give its light; the stars will fall from the sky, and the heavenly bodies will be shaken." "At that time the sign of the Son of Man will appear in the sky
 -Rev 6:12 I watched as he opened the sixth seal. There was a great earthquake. The sun * turned black like sackcloth made of goat hair, the whole moon ☾ turned blood red

Rev 15:1 seven angels with the seven last plagues—last, because with them God's wrath is completed. NIV
 Rev 16:1 saying to the seven angels, "Go, pour out the seven bowls of God's wrath on the earth." NIV

Although it was cut short, we can assume that the Great tribulation will last longer than the other events of the 2nd half of Daniel 70th week. That being said we shouldn't limit the duration of the Day of the Lord to a single 24 hours day. The 5th trumpet alone will last 5 month.

- Rev 9:1,10 he fifth angel sounded his trumpet ... They had tails and stings like scorpions, and in their tails they had power to torment people for **five months**.

The two witnesses

Rev 11:3 and I will give power to my two witnesses, and they will prophesy for 1,260 days, clothed in sackcloth." NIV

For a long time I thought the two witnesses could be two individuals, I am not so sure anymore. It is quite possible that they could be the two parts of the Bible, if it is the case they would have 'symbolically' operated for 1,260 years and their time is over.

The time of the rapture

— Feast of Trumpets on Tishri 1, 5998 AM

In their book 'The Last Shofar', Joseph Lenard & Donald Zoller develops the possibility that the rapture will happen on the Feast of Trumpets.

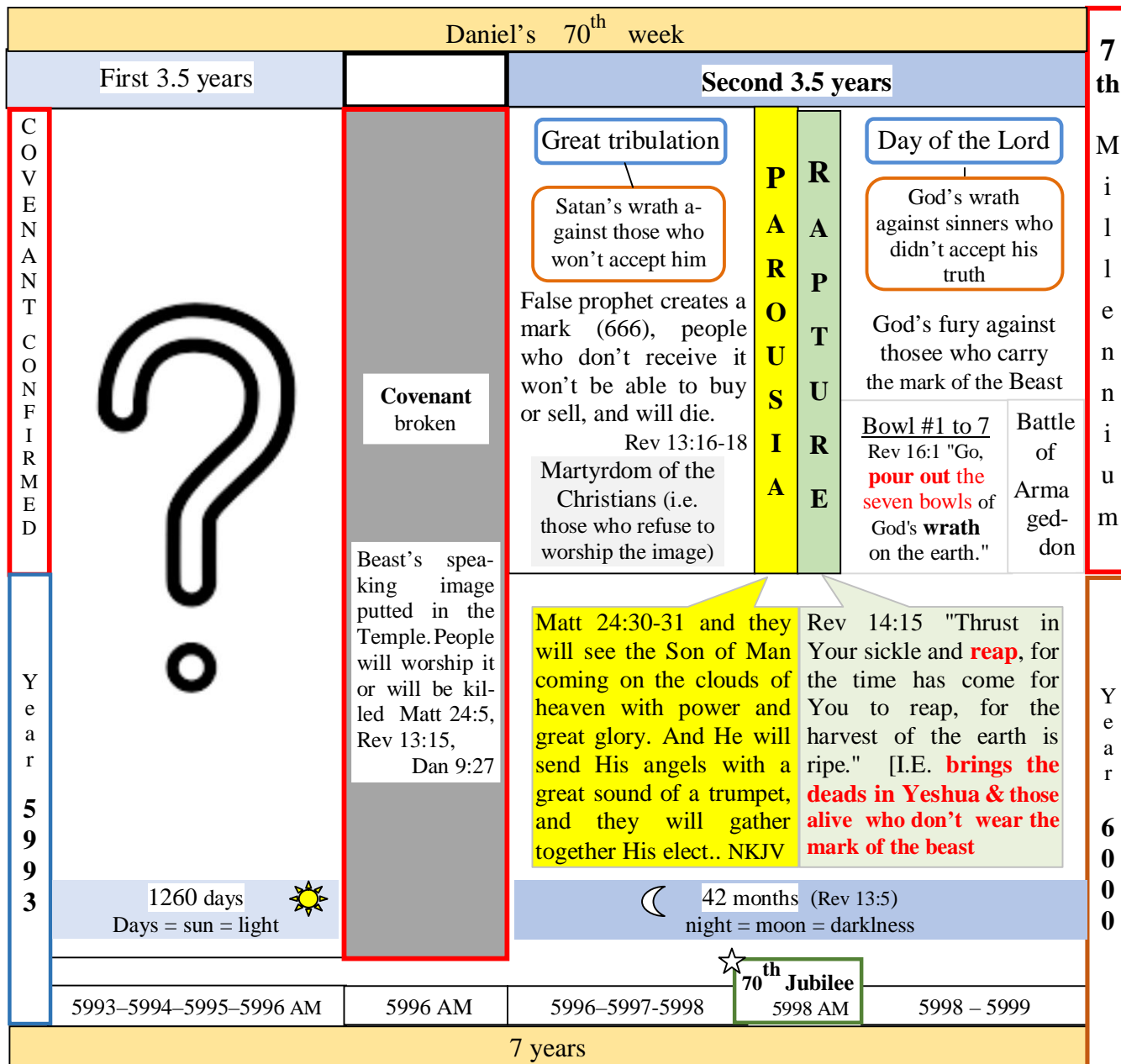

- About the Rapture -

Dan 12:1 There will be a **time of distress** such as has not happened from the beginning of nations until then. But at that time your people ... will be delivered.

Matt 24:31 And he will send his angels with a loud trumpet call, and they will gather his elect from the four winds, from one end of the heavens to the other.

1 Thess 4:16 For the Lord himself will come down from heaven, with a loud command, with the voice of the archangel **and with the trumpet** call of God, and the dead in Christ will rise first.

The notions of Pre-Wrath (Tribulation → Rapture → Day of the Lord) Is better explained by ALAN E. KURSCHNER Antichrist Before the Day of the Lord

Rapture on the Jubilee day 

1 Cor 15:52 in a flash, in the twinkling of an eye, at the last trumpet. For the trumpet will sound, the dead will be raised imperishable, and we will be changed. (on 10th day of 7th month)



Note: The 'last trumpet' mentioned here is not related to the 7 trumpets that will be sounded by the seven angels. In ancient Israel, on the day of the Jubilee (which occurs every 49 years on the day of Yom Kippur) a trumpet was blasted throughout the land

Appendix I The Kings of Israel

2923 AM K. Saul
 2963 AM K. David
 / K. Ish-Bosheth
 3000 AM K. Solomon

N. K.
 10 dynasties
 (5+5)

	Access			Non Access					
S O U T H E R N K I N G D O M	SK1	K. Rehoboam 17	3063		K. Jeroboam 22	NK1	D1	N O R T H E R N K I N G D O M	
	SK2	K. Abijah 3	3080						
	SK3	K. Asa 41	3082						
				3084	K. Nadab 2	NK2			D2
				3085	K. Baasha 24	NK3			
				3108	K. Elah 2	NK4			
				3109	K. Zimri 7d	NK5			
					K. Tibni 5	NK6			D4
					K. Omri 12	NK7			D5
				3120	K. Ahab 22	NK8			
				3140	K. Ahaziah 2	NK9			
				3141	K. Joram 12	NK10			
		SK4	K. Jehoshaphat	3123					
		SK5	K. Jehoram 8	3145					
		SK6	K. Ahaziah 1	3151					
		SK7	Q. Athaliah 6		3152	K. Jehu 28	NK11		D6
		SK8	K. Joash 40						
					3175	K. Jehoahaz 17	NK12		
					3189	K. Jehoash 16	NK13		
		SK9	K. Amaziah 29	3191					
				3206	K. Jeroboam II 41	NK14			
	SK10	K. Uzzia 52	3233						
				3271	K. Zecharia 6m	NK15			
				3272	K. Shallum 1m	NK16			
				3283	K. Menahem 10	NK17			
	SK11	K. Jotham 16	3285		K. Pekah 20	NK19	D9		
	SK12	K. Ahaz 16	3302				D10		
				3314	K. Hoshea 9	NK20			
	SK13	K. Hezekiah 39	3317						
	SK14	K. Manasseh 55	3333						
	SK15	K. Amon 2	3388						
	SK16	K. Josiah 31	3390						
	SK17	K. Jehoahaz 3m	3421						
	SK18	K. Jehoiakim 11							
	SK19	K. Jehoiachin 3m	3432						
	SK20	K. Zedekiah 11							

NOTE: This table give the the first year of each southern (SK) and northern (NK) kings of Israel. It also indicates which king was using the 'accession' or 'non-accession' year dating.
 Ex: In the access mode 3063 + 17 = 3080
 In non-access mode 3063 + 22 = 3084
 See my book: **The 44 Hebrew monarchs**
 (A Chronology of two kingdoms)

Appendix J The flood's chronology

Here are the two types of time markers supplied by the bible to chart the flood period.

Basic Value

- BV1 Rain last 40 days
Ref Gen 7:4
- BV2 Window is open 40 days after
Top of Montain became visible
Ref Gen 8:6
- BV3 Water prevailed for 150 days
Ref Gen 7:24
- BV4 First flight from the Dove 7
days after the Raven was
dismissed (deduced from the
text)
- BV5 Scd flight of the Dove 7 days
after the 1st one
ref Gen 8:10
- BV6 Third flight of the Dove 7 days
after the 2nd.
Ref Gen 8:12

Basic Date

- BD1 Ark is closed on M2D17
Ref Gen 7:11
- BD2 Ark rests on M7D17
Ref Gen 8:4
- BD3 Top of maontain is visible
on M10 D1
ref Gen 8:5
- BD4 Water is gone on M1D1
Ref Gen 8:13
- BD5 Ark is open on M2D27
Ref Gen 8:14-16

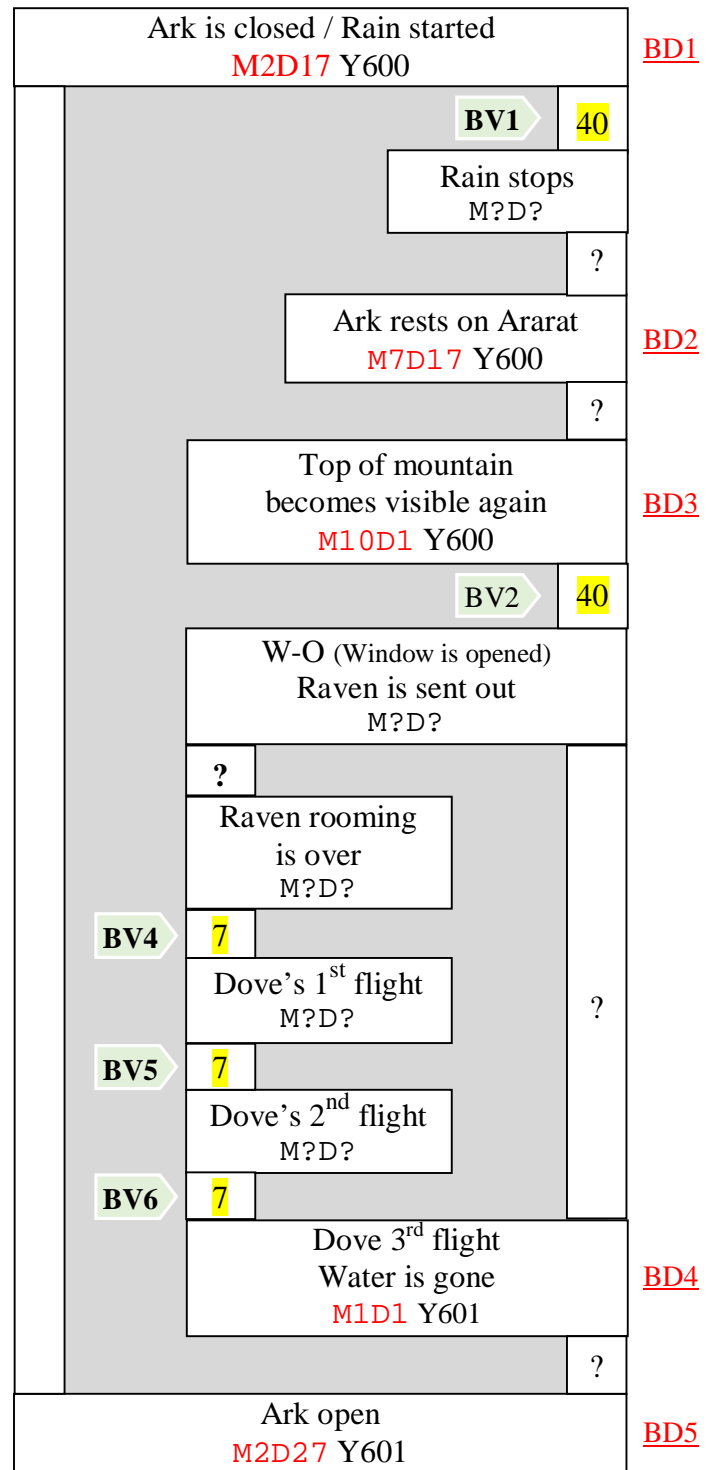

The next chart come from my in depth study of the flood. See my work '**The prevailing water of Noah's flood**'. Note: all the periods values are expressed in days unit.

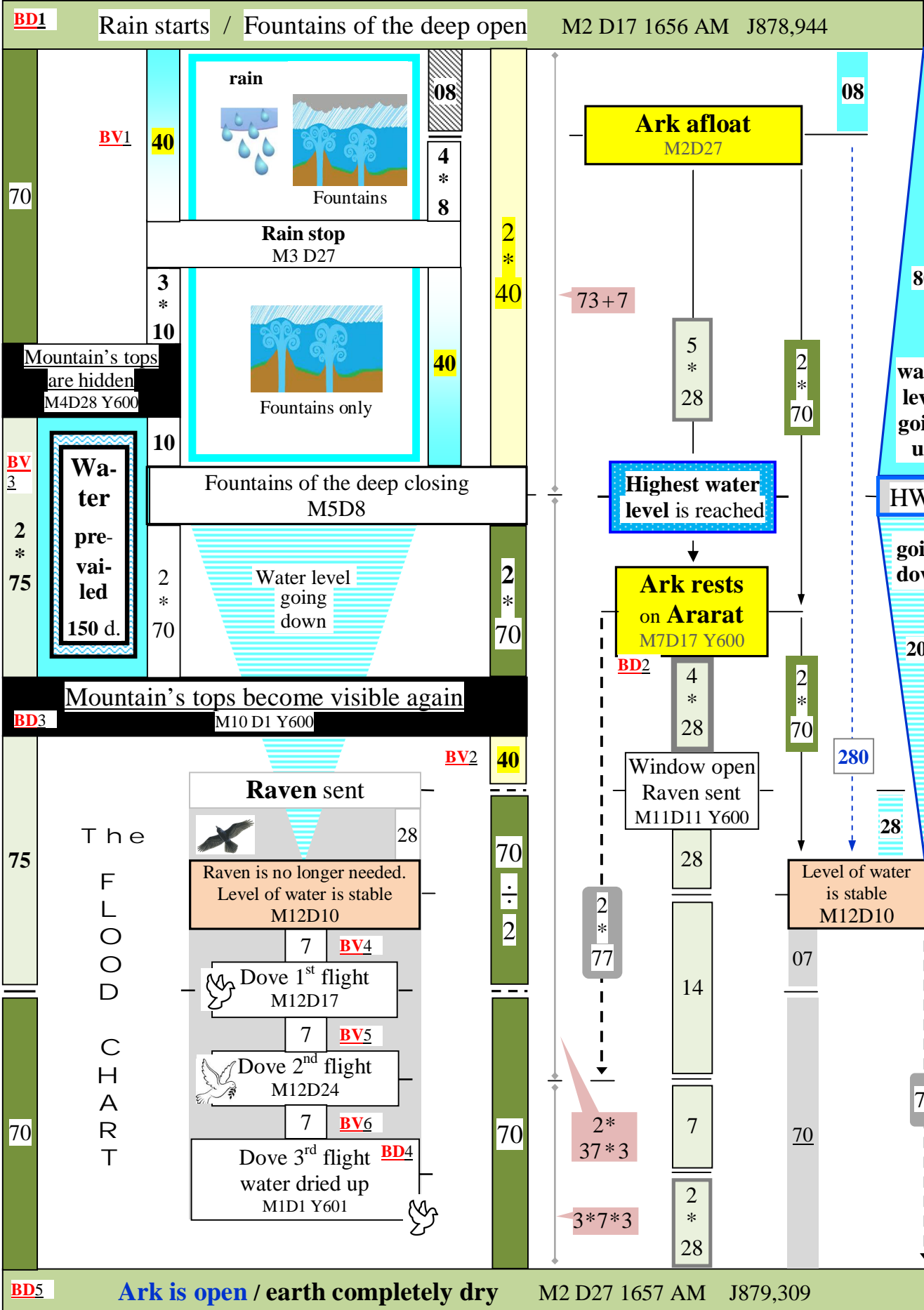

Appendix K 666 as a magic square

The following information was found by Vernon Jenkins (see article *WISDOM'S KEY* at <http://www.whatabeginning.com/>)

A 6*6 square array using numbers from 1 to 36

8	30	26	22	24	1
2	34	18	28	12	17
7	20	3	29	31	21
25	4	23	15	9	35
36	13	27	11	19	5
33	10	14	6	16	32

the sums of the numbers in the 36 cells is **666**
i.e. $(6+6+6) * 37$

the sums of the numbers in each row, each column, each diagonal are **111**
i.e. $37 * 3$

8	30	26	22	24	1	111
2	34	18	28	12	17	111
7	20	3	29	31	21	111
25	4	23	15	9	35	111
36	13	27	11	19	5	111
33	10	14	5	16	32	111
111	111	111	111	111	111	111

8	30	26	22	24	1
2	34	18	28	12	17
7	20	3	29	31	21
25	4	23	15	9	35
36	13	27	11	19	5
33	10	14	6	16	32

370
i.e. $10 * 37$

296
i.e. $8 * 37$

8	30	26	22	24	1
2	34	18	28	12	17
7	20	3	29	31	21
25	4	23	15	9	35
36	13	27	11	19	5
33	10	14	5	16	32

296
i.e. $8 * 37$

74
i.e. $2 * 37$

296
i.e. $8 * 37$

8	30	26	22	24	1
2	34	18	28	12	17
7	20	3	29	31	21
25	4	23	15	9	35
36	13	27	11	19	5
33	10	14	5	16	32

222 i.e. $6 * 37$

444 i.e. $12 * 37$

The original **square** array is subdivided in 9 squares of 4*4

8	30	26	22	24	1
2	34	18	28	12	17
7	20	3	29	31	21
25	4	23	15	9	35
36	13	27	11	19	5
33	10	14	6	16	32

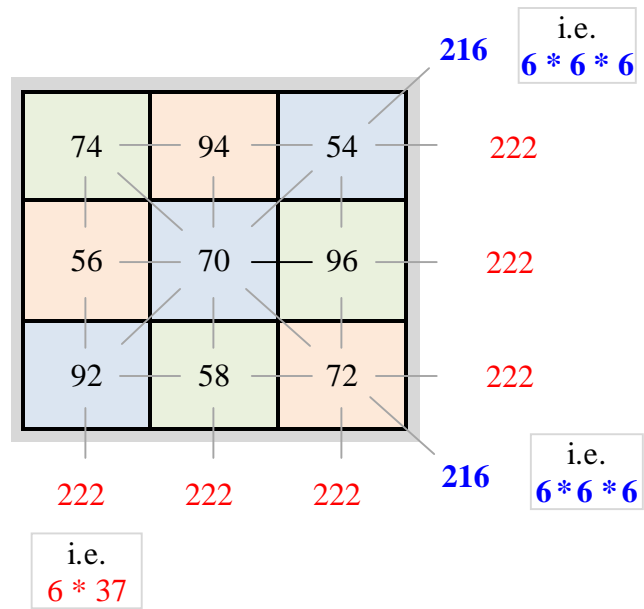

The original **square** array is subdivided in 4 squares of 3*3

8	30	26	22	24	1
2	34	18	28	12	17
7	20	3	29	31	21
25	4	23	15	9	35
36	13	27	11	19	5
33	10	14	6	16	32

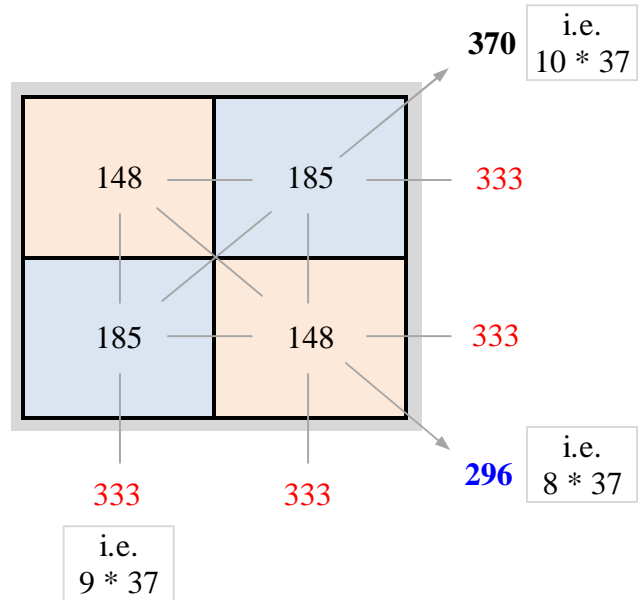
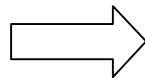

1 * 8 = 8	2 * 30 = 60	3 * 26 = 78	4 * 22 = 88	5 * 24 = 120	6 * 1 = 6
7 * 2 = 14	8 * 34 = 272	9 * 18 = 162	10 * 28 = 280	11 * 12 = 132	12 * 17 = 204
13 * 7 = 91	14 * 20 = 280	15 * 3 = 45	16 * 29 = 464	17 * 31 = 527	18 * 21 = 378
19 * 25 = 475	20 * 4 = 80	21 * 23 = 483	22 * 15 = 330	23 * 9 = 207	24 * 35 = 840
25 * 36 = 900	26 * 13 = 338	27 * 27 = 729	28 * 11 = 308	29 * 19 = 551	30 * 5 = 150
31 * 33 = 1023	32 * 10 = 320	33 * 14 = 462	34 * 6 = 204	35 * 16 = 560	36 * 32 = 1152

Numbering each row from left to right

6 * 8 = 48	5 * 30 = 150	4 * 26 = 104	3 * 22 = 66	2 * 24 = 48	1 * 1 = 1
12 * 2 = 24	11 * 34 = 374	10 * 18 = 180	9 * 28 = 252	8 * 12 = 96	7 * 17 = 119
18 * 7 = 126	17 * 20 = 340	16 * 3 = 48	15 * 29 = 435	14 * 31 = 434	13 * 21 = 273
24 * 25 = 600	23 * 4 = 92	22 * 23 = 506	21 * 15 = 315	20 * 9 = 180	19 * 35 = 665
30 * 36 = 1080	29 * 13 = 377	28 * 27 = 756	27 * 11 = 297	26 * 19 = 494	25 * 5 = 125
36 * 33 = 1188	35 * 10 = 350	34 * 14 = 476	33 * 6 = 198	32 * 16 = 512	31 * 32 = 992

Numbering each row from right to left

In the following (4) copies of our 6x6 magic square the 36 individual cells have been numbered sequentially. In all four arrangements the sum of the 36 products 'cell number x cell content' is the ...

8	30	26	22	24	1
2	34	18	28	12	17
7	20	3	29	31	21
25	4	23	15	9	35
36	13	27	11	19	5
33	10	14	6	16	32

... palindromic number

12321

or

111^2 i.e. $(37*3)^2$

1 * 8 = 8	7 * 30 = 210	13 * 26 = 338	19 * 22 = 418	25 * 24 = 600	31 * 1 = 31
2 * 2 = 4	8 * 34 = 272	14 * 18 = 252	20 * 28 = 560	26 * 12 = 312	32 * 17 = 544
3 * 7 = 21	9 * 20 = 180	15 * 3 = 45	21 * 29 = 609	27 * 31 = 837	33 * 21 = 693
4 * 25 = 100	10 * 4 = 40	16 * 23 = 368	22 * 15 = 330	28 * 9 = 252	34 * 35 = 1190
5 * 36 = 180	11 * 13 = 143	17 * 27 = 459	23 * 11 = 253	29 * 19 = 551	35 * 5 = 175
6 * 33 = 198	12 * 10 = 120	18 * 14 = 252	24 * 6 = 144	30 * 16 = 480	36 * 32 = 1152

Numbering each column from left to right

31 * 8 = 248	25 * 30 = 750	19 * 26 = 494	13 * 22 = 286	7 * 24 = 168	1 * 1 = 1
32 * 2 = 64	26 * 34 = 884	20 * 18 = 360	14 * 28 = 392	8 * 12 = 96	2 * 17 = 34
33 * 7 = 231	27 * 20 = 540	21 * 3 = 63	15 * 29 = 435	9 * 31 = 279	3 * 21 = 63
34 * 25 = 850	28 * 4 = 112	22 * 23 = 506	16 * 15 = 240	10 * 9 = 90	4 * 35 = 140
35 * 36 = 1260	29 * 13 = 377	23 * 27 = 621	17 * 11 = 187	11 * 19 = 209	5 * 5 = 25
36 * 33 = 1188	30 * 10 = 300	24 * 14 = 336	18 * 6 = 108	12 * 16 = 192	6 * 32 = 192

Numbering each column from right to left

Appendix L 77 People of authority (11 + 22 + 44)

11 Judges		22 Patriarchs		44 Monarchs			
1 Othniel	2601	1 Adam	0 AM	1 Saul	2923	1 David	2963
2 Ehud	2659	2 Seth	130	2 Ish-Bosheth	2963	2 Solomon	3000
3 Deborah	2697	3 Enosh	235	Over Israel		Over Judah	
4 Gideon	2756	4 Kenan	325	3 Jeroboam	3063	3 Rehoboam	3063
5 Tola	2799	5 Mahalalel	395	4 Nadab	3084	4 Abijah	3080
6 Jair	2822	6 Jared	460	5 Baasha	3085	5 Asa	3082
7 Jephthah	2862	7 Enoch	622	6 Elah	3108	6 Jehoshaphat	3123
8 Ibzan	2868	8 Methuselah	687	7 Zimri	3109	7 Jehoram	3145
9 Elon	2875	9 Lamech	874	8 Tibni	3109	8 Ahaziah	3151
10 Abdon	2885	10 Noah	1056	9 Omri	3109	9 Athaliah	3152
11 Samuel	2895	11 Shem	1558	10 Ahab	3120	10 Joash	3159
		-- FLOOD --	1656	11 Ahaziah	3140	11 Amaziah	3191
		1 Arphaxad	1658	12 Joram	3141	12 Uzzia	3233
		2 Shelah	1693	13 Jehu	3152	13 Jotham	3285
		3 Eber	1723	14 Jehoahaz	3175	14 Ahaz	3302
		4 Peleg	1757	15 Jehoash	3189	15 Hezekiah	3317
		5 Reu	1787	16 Jeroboam	3206	16 Manasseh	3333
		6 Serug	1819	17 Zecharia	3271	17 Amon	3388
		7 Nahor	1849	18 Shallum	3272	18 Josiah	3390
		8 Terah	1878	19 Menahem	3272	19 Jehoahaz	3421
		9 Abraham	2008	20 Pekahiah	3283	20 Jehoiakim	3421
		10 Isaac	2108	21 Pekah	3285	21 Jehoiachin	3432
		11 Jacob	2168	22 Hoshea	3314	22 Zedekiah	3432

NOTE :

See judges chronology on page 166

See patriarchs chronology in Appendix A on page 220

See kings chronology in Appendix I on page 276

Appendix M The 12 Symbolic acts found in Ezekiel 4-5

LYING ON <u>LEFT</u> SIDE (390 days) = 390 years		E Z E K I E L T U R N O V E R	LYING ON <u>RIGHT</u> SIDE (40 days) = 40 years	
L1	Ezekiel prophesies 390 days See P51 Moses' escape from Egypt (2483 AM) To Ark captured (2873 AM)		R1	Ezekiel prophesies 40 days Jeremiah starts prophesying (3403 AM) To Temple destruction (3443 AM) See P57
L2	Ezekiel bears Israel's sins 390 days See P17 Gibeah's sin (2583 AM) To Ark brought in Jerusalem (2973)		R2	Ezekiel bears Judah's sins 40 days Manasseh's Abomination (3368 AM) To Josiah's Passover (3408 AM) See P13
L3	Ezekiel eats defiled food 390 days See P67 Foundation of Samaria (3113 AM) To Return of the 42,360 exiles (3503)		R3	Ezekiel fasts 40 days Judah returns from Exile (3503 AM) To Nehemiah wall's completion 3543 see P133

(The following symbolic acts were not interrupted when Ezekiel switched side)

Combined SIDES 390 + 40 = 430		
Ezekiel lies bare arm for 430 days	C1 see p58 Exodus 2523 AM → Samuel's death 2953 AM	
Ezekiel shaves his hair 430 days	C2 see p89 Ark captured 2873 AM → Isaiah's foretelling 3303 AM	
Ezekiel holds a siege for 430 days	C3 see p27 Ark brought in the first Temple 3013 AM → Destruction of Jerusalem 3443 AM	
Ezekiel weighs and divides his hair 430 days	C4 see p97 Kingdom's split 3063 → Fall of Babylon 3493 AM	
Ezekiel hair growing for 430 days	C5 see p104 Construction of 2 nd Temple 3513 AM → Herod renovates the Temple 3943 AM	
Ezekiel is mute for 430 days	C6 see p135 First Purim 3559 AM → Start of Yeshua's ministry 3989 AM	

Wilderness Encampment

According
Vernon Jenkins

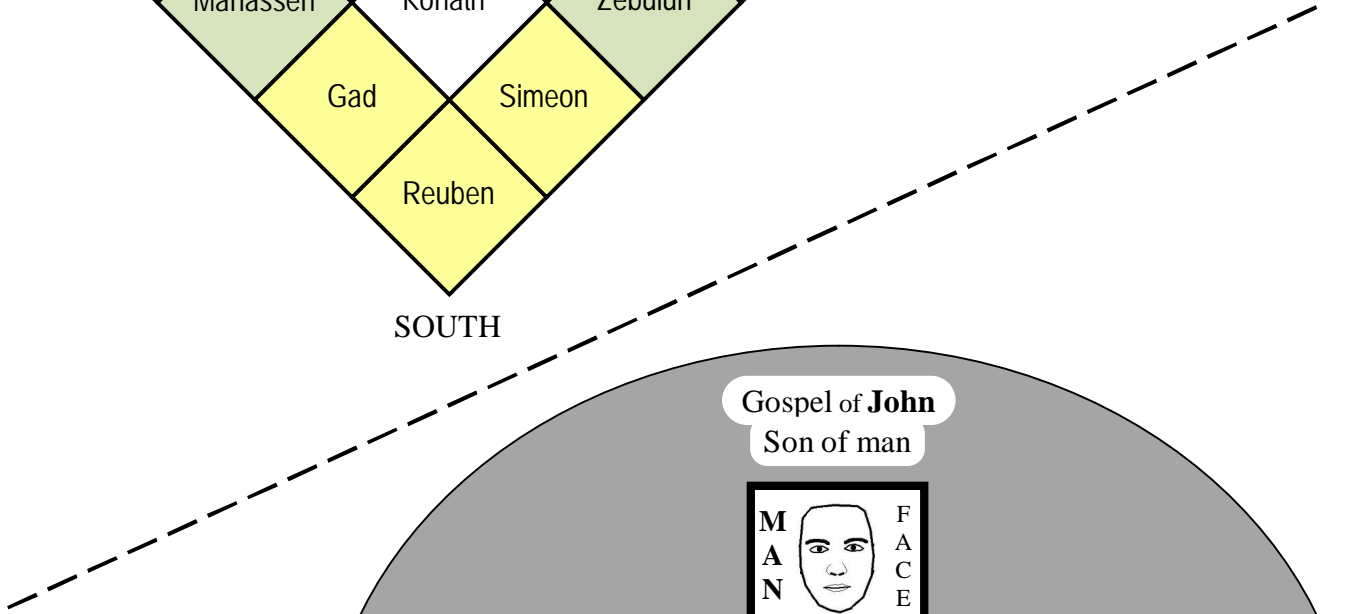
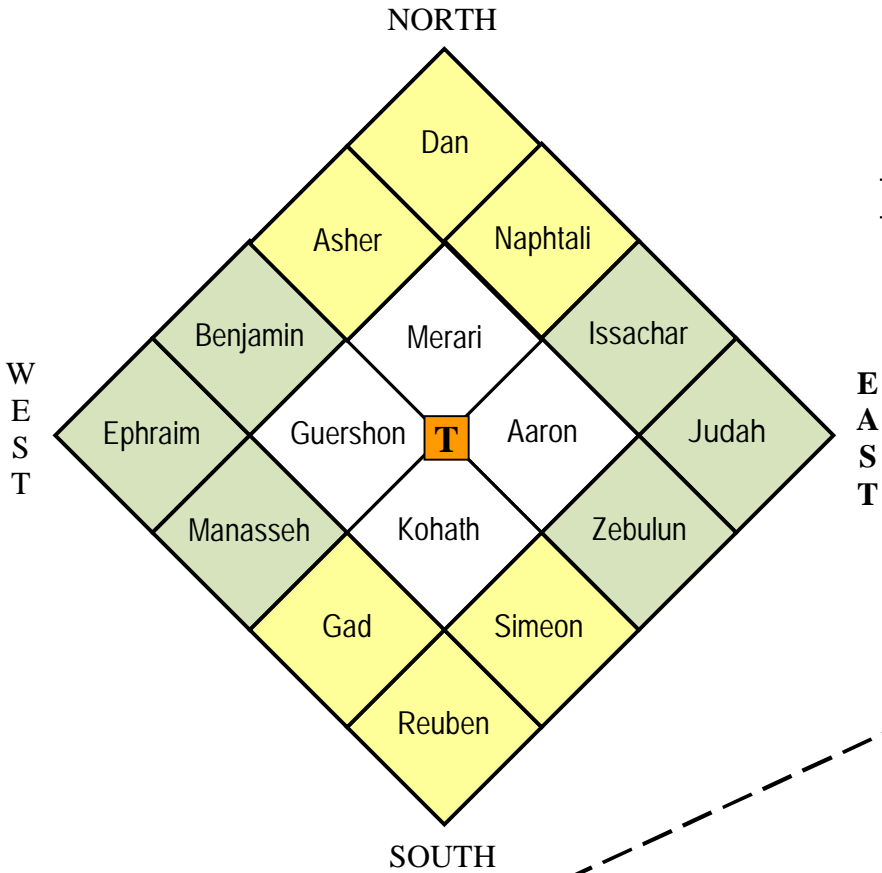

4 faces of Ezekiel 1:10 coincide with the 4 gospels

According
Darek Barefoot

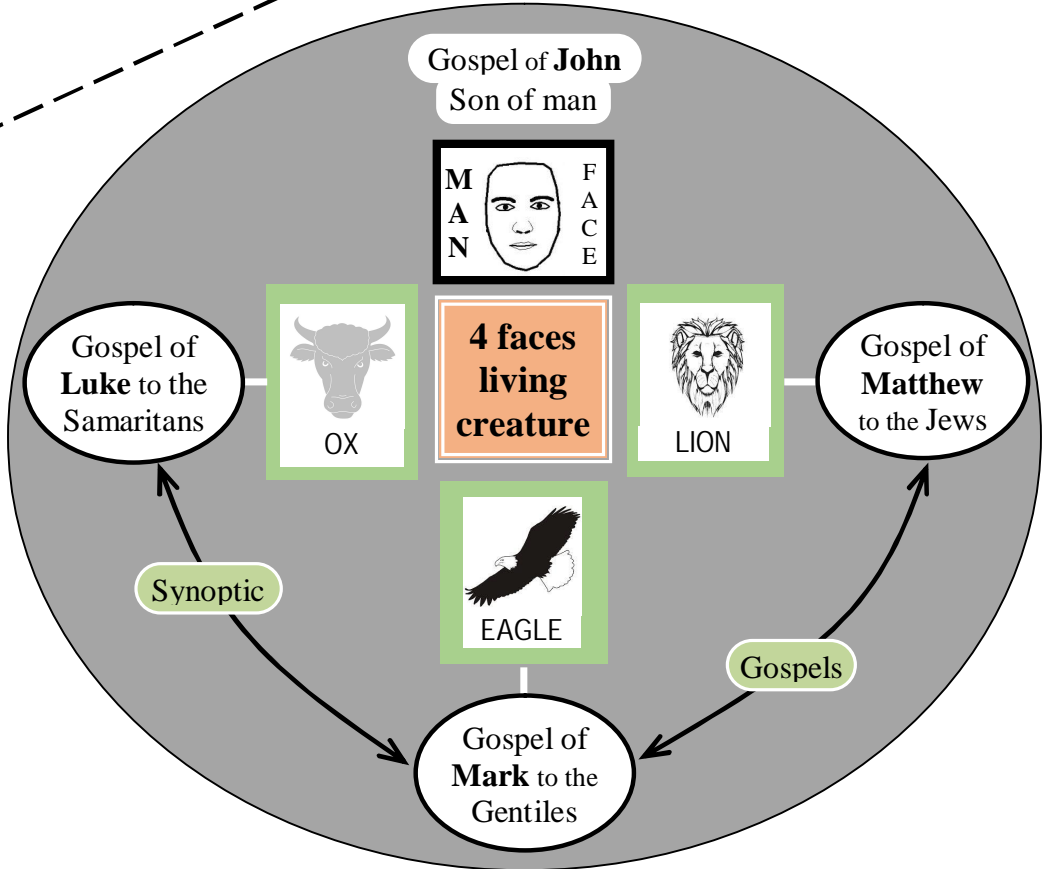

Copyright©2018 by Yves Peloquin
ALL RIGHTS RESERVED

No part of this publication may be used for commercial purposes. The readers are allowed to save, print or send this PDF to whoever they want as far as they don't alter its content.