

TEMPLE

Architectural Products

MATERIAL (please choose one):

- | | |
|--|--|
| <input type="checkbox"/> 24 GA Steel | <input type="checkbox"/> .040 Aluminum |
| <input type="checkbox"/> 22 GA Steel | <input type="checkbox"/> .050 Aluminum |
| <input type="checkbox"/> .032 Aluminum | <input type="checkbox"/> .063 Aluminum |

Other:
Color:
Finish:

Notes / Comments:

*

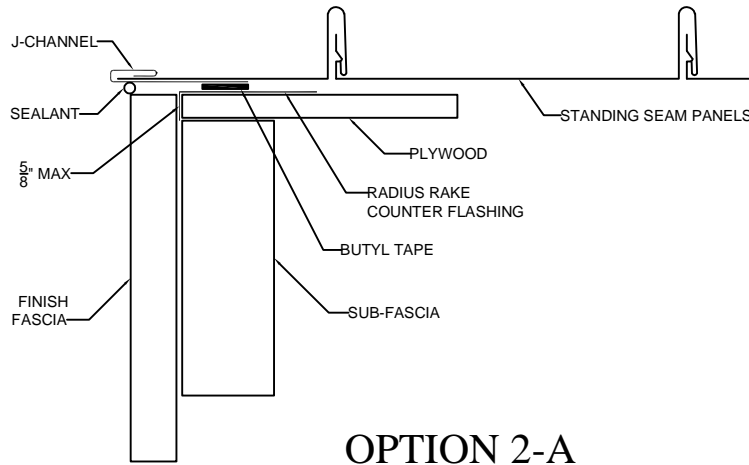

OPTION 2-A

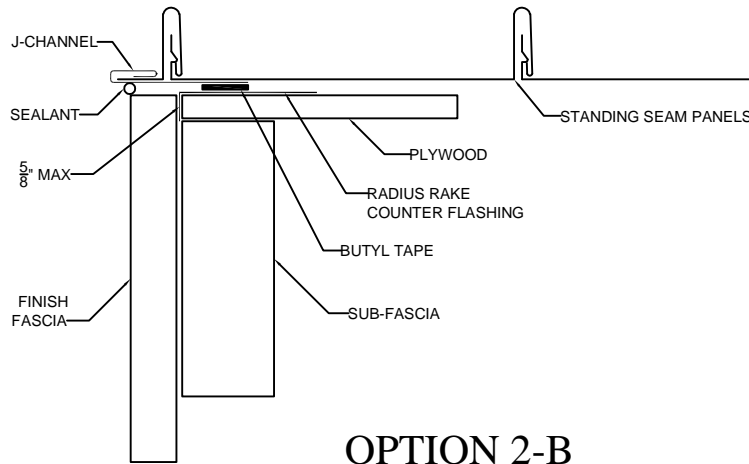

OPTION 2-B

Notes:

- 1) *Accessory Welding is only available in 040 aluminum or heavier
- 2) Written approval is required prior to fabrication, contractor is responsible for all dimensions and quantities. Fabricated items are not returnable.

Temple Architectural Products
1111 Lowell St.
Elyria, OH 44035

Phone: (440) 323-7559

Fax: (440) 412-7559

Project Name: _____

Installing Contractor: _____

Contact Name: _____

Contact number: _____

Signed Approval: _____