

WHAT ARE F.R.L.'s?

HOW THEY WORK

WHERE TO USE THEM

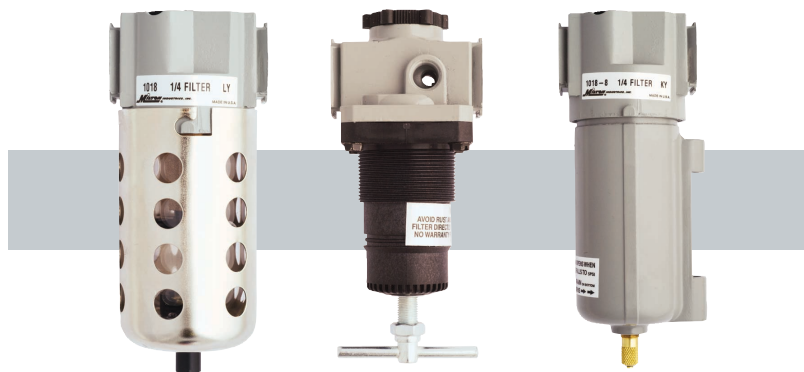

MILTON INDUSTRIES, INC.

THE QUALITY NAME

REGULATOR INSTRUCTION SHEET

AIR LINE REGULATORS -- SERIES 1/4" 3/8" 1/2" 3/4" and 1"

Standard Units: Relieving
 Maximum Inlet Pressure: 250 PSI
 Operating Temperatures 40° to 120° F

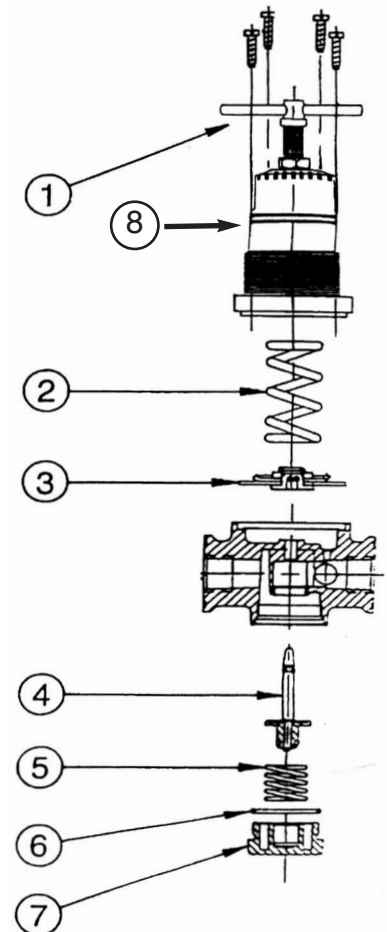
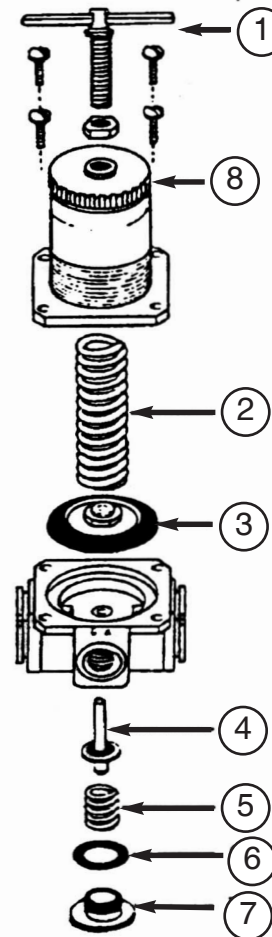

MODELS 1113, 1114, 1115
 HIGH PRESSURE 1113-8, 1114-8, 1115-8

ID #	DESCRIPTION	KIT NO.	CONTENTS
1	T-Handle	1113-11	T-Handle, lock Nut
2	Adjusting Spring Kit	1113-15	Adjusting Spring, 5-125 PSI
		1113-16	Adjusting Spring, 10-250 PSI
3	Diaphragm Repair Kit	1113-17	Relieving Diaphragm
4, 5, 6, 7	Valve Kit	1113-18	Valve Assembly, Spring, O-ring, Bottom cap
8	Bonnet Kit	1113-19	Bonnet & 4 Screws

MIDSIZE MODELS 1026, 1027
 MIDSIZE HIGH PRESSURE 1026-8, 1027-8

ID #	DESCRIPTION	KIT NO.	CONTENTS
1	T-Handle	1113-11	T-Handle, lock Nut
2	Adjusting Spring Kit	1113-15	Adjusting Spring, 5-125 PSI
		1113-16	Adjusting Spring, 10-250 PSI
3	Diaphragm Repair Kit	1113-17	Relieving Diaphragm
4, 5, 6, 7	Valve Kit	1026-18	Valve Assembly, Spring, O-ring, Bottom cap
8	Bonnet Kit	1113-19	Bonnet & 4 Screws

MICRO-FILTERS

Although the Micro-Filter is the simplest of the three basic air control devices, it is also the least understood and the one most frequently installed improperly. Read on.

How they work -These filters remove two kinds of contaminants: (1) solid, particulate matter such as rust and pipe scale and (2) water condensate. The first is removed by a nominally rated 40 micron porous sintered metal element. However, because of its unique "tortuous path" design, it will actually trap particles down to 10 microns in size (about 0.0004 inches)

The water is removed through a violent swirling action imparted to the air by a set of fixed vanes at the top of the filter. The process is exactly like that of the spin-dry cycle in a washing machine. Centrifugal force throws the water droplets against the side of the bowl where they roll down and collect at the bottom.

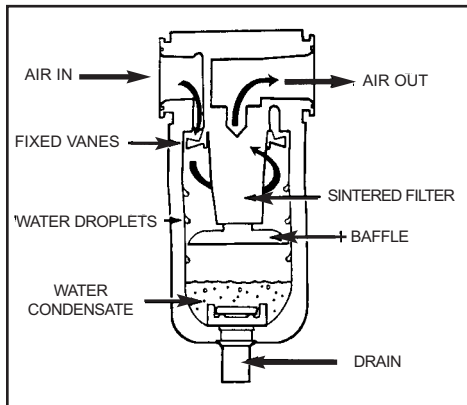

Condensate removal in a Micro-Filter.

Small is better -The more rapidly the air is swirled, the more effectively the water condensate is thrown out against the filter wall. If you pass the same volume of air (SCFM) through a small filter and a large filter, it will swirl more rapidly in the small one.

Although you may think a big filter is more effective, the reverse may actually be true if too little air passes through. Always select filter size based on your air flow or SCFM requirements.

How small is too small - As long as the pressure difference between the inlet and the outlet of the filter does not exceed 3 PSI at the required air flow (SCFM), the filter is not too small. For more information, please refer to the FRL sizing chart in the Milton Catalog, page 60.

What a filter does and doesn't do - A properly selected and installed filter removes particulate matter and water condensate. However, it does not and cannot remove water vapor from the air. Water vapor must be converted to water condensate before this type of filter can remove it (See the OTHER FILTERS section).

Water vapor and water condensate - Water vapor is an invisible gas; water condensate is a liquid, even if it is in mist or droplet form. To convert water vapor to a condensate, the air must be cooled down - actually, down to or below the "dew point."

The dew point is the temperature at which dew or water condensate forms. It varies with the RH (Relative Humidity). It's low with low RH and approaches ambient temperature with high RH.

This explains why you sometimes see water droplets or mist coming from a blow gun or paint sprayer when there is no "apparent" water in the air lines. The rapid expansion of the air as it leaves the blow gun or sprayer causes the air's temperature to drop (same principle as an air conditioning system). If this temperature falls below the dew point, the water vapor in the air line converts instantly to water condensate.

If you sometimes experience a problem like this, you will require, in addition to the Micro-Filter, a *desiccant dryer* filter (see OTHER FILTERS section).

Choosing a different drain system -

All filters (except the Mini) come with an Overnight Drain that opens when line pressure falls, after turning off the compressor, to 5 PSI. These drains can also be opened manually by pushing them sideways (poly bowls) or twisting them in the direction of the arrow (metal bowls).

You can also install an Automatic Drain Valve (Model 1168) in place of the supplied Overnight Drain Valve. These valves open automatically whenever the water level in the bowl reaches a certain point, whether the system is under pressure or not. These are good for high humidity conditions or around-the-clock systems.

Metal bowl vs. polycarbonate bowl -

The advantage of the poly bowl is in quick and easy water level checking. If you have a situation where water may fill the bowl before the overnight drain can function (e.g., high humidity), it is helpful to be able to visually check water level.

Other than this, the advantage is with the metal bowl. This is especially true if you are using synthetic oils in your compressor or have volatile solvents in the area. (See list of chemicals that are not compatible with poly bowls.)

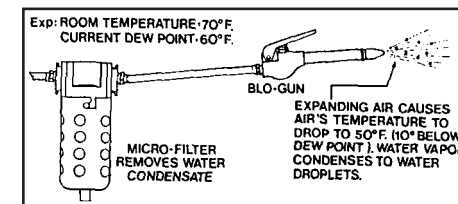

When you need a desiccant dryer

One filter is never enough - A well - designed system requires a minimum of two filters: (1) a master filter near the compressor and (2) a smaller filter at each

work station or air operated device. The master filter is usually a 1/2" NPT or larger unit.

This filter should never be installed at the output of the compressor, but rather at the output of the after-cooler or the receiving tank. These units allow the hot, high pressure air from the compressor to cool down enough to condense out much of the water vapor. The main line filter and regulator should be placed at least 20 Feet from the compressor.

The additional filter at each station, besides removing still more condensate, also traps any debris (rust and pipe scale) that may make its way down the distribution pipe. Try to locate this filter as close to the device as possible.

Installation tips - Align the filter vertically, with the drain at the bottom. Note that the air from the compressor enters the "IN" port and exits the "OUT" port. If connected backwards, the filter will still pass air but will not extract the water condensate.

Easy maintenance - Since there are no moving parts to wear out, there is little to go wrong. Periodically wash the sintered filter element in a detergent solution and blow it out; if too clogged to be washed, replace it.

OTHER FILTERS

Sometimes a Micro-Filter alone is not the answer. Although they remove much of the water, in some applications, such as spray painting, it's not enough.

When you need exceptionally dry air or essentially oil-free air, you can choose from two other filter types: (1) the desiccant dryer and (2) the oil removing filter.

The desiccant dryer filter - This is the ultimate filter for dry air; it takes over where the Micro-Filter leaves off. This filter absorbs directly, through a chemical process, the water vapor in the air.

So effectively does it remove water, that the air frequently has a dew point of 0°F or lower.

This is sufficiently dry for practically any purpose, including spray painting.

However, this drying efficiency comes with a price. The desiccant that absorbs the water vapor eventually becomes saturated with water and can no longer absorb anymore. Fortunately, you are alerted to this by a change in desiccant color - from bluish-white to pink.

When this happens, you have two choices, depending on which desiccant system you are using. If it is the rechargeable type, simply remove the desiccant, dry it in a vented oven at 275°F for two or three hours, then put it back in the filter.

If it is the disposable type, such as the Mini In-line Desiccant Dryer (Models 1173/1174), it's even easier - just throw it away.

The Mini In-line Dryer is designed for those users who do not need full-time dry air and who wish to avoid the cost of installing a rechargeable desiccant system. One Mini Dryer will supply enough bone-dry air, depending on humidity, to spray paint several cars.

Remember though, all desiccant dryers must be preceded by a Micro-Filter to remove the water condensate. In addition, they should also be preceded by an oil-removing filter (described below). Failure to do this will result in short desiccant life.

Oil-removing & Coalescing filters -

In addition to water and particulate matter, oil can also be a contaminant in an air system. This is especially true in paint spraying.

A special series of Sub-Micron Oil Removing Filters is available for this purpose. It will remove particles down to 0.9 microns (0.03 microns for coalescing filters), over forty to one hundred times as small as those extracted by the standard Micro-Filter. This is small enough to capture oil vapors (e.g., compressor blow-by) as well as water mist too fine to be removed by a standard filter.

It achieves this exceptional filtration through a white borosilicate element that can be replaced when necessary. Similar to the standard filter, these units also have an over-night drain. Since they are not intended to remove large quantities of water, they should always be preceded by a Micro-Filter.

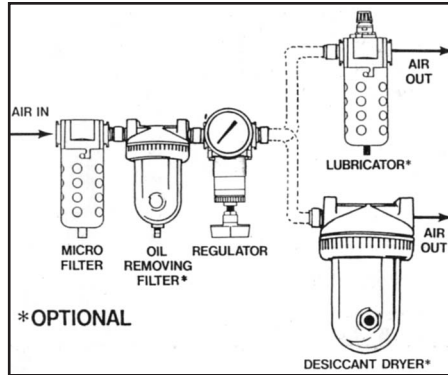

Proper sequence of F-R-L components.

REGULATORS

Regulators, despite their precision valving system, can be very long-lived devices. Ten to twenty years is not unusual.

Keep it clean - The secret to this longevity is clean air. Always, without exception, precede your regulator with a Micro-Filter and install it as close as you can get it. This is why the Piggyback Filter-Regulator or FRL Trio is such a good choice - they always come with a filter. And *never* precede a regulator with a desiccant dryer filter or a lubricator nor use Teflon tape on the "IN" port (use standard pipe dope).

That little hole in the side - This is a relieving port that allows the regulator to be used on dead-ended applications. This means that you can raise or lower the desired pressure without any air flow.

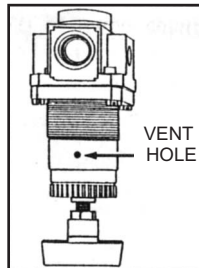

Normally, you will neither feel nor hear any air coming from this hole. If you do, it means either: (1) the regulator diaphragm has a leak, (2) the little valve under the knurled cap is dirty or (3) the regulator has been installed backwards. If, on a new installation, the regulator does not respond properly or you hear air escaping, make sure you have not reversed the IN and OUT ports - it happens.

Pressure ranges - Regulators come in two standard ranges: (1) 2 to 125 PSI and (2) 10 to 250 PSI. The maximum inlet pressure in either case is 250 PSI. A special low pressure mini-regulator is also available that covers 3 to 60 PSI. This is the same regulator that is used on the Model 1174 Desiccant Dryer system.

LUBRICATORS

These devices play a vital role in many air delivery systems. Be sure you select the type best suited to your applications.

Two types available - Lubricators come in two basic styles: (1) the drip type and (2) the wick type. The drip type is the most popular and the one best suited to the average repair shop application. The wick type is normally used for industrial applications.

The drip type - This style injects lubrication into the system by allowing oil drops periodically to drop into the air stream. The rate at which the drops enter the stream is fully adjustable. And once adjusted, the adjusting knob can be removed to prevent tampering.

The question is: How much oil to inject and how is this accomplished? For the average repair shop, 3 to 4 drops per minute is a good starting point; you can raise or lower it as you see fit. Since the lubricator delivers oil only when air is flowing, here is one method for setting the drip rate: Connect a tubeless tire valve to the system (via a tire chuck) and let the air pass through freely. This is about the same volume of air consumed by an impact wrench. Adjust the drip rate to produce 3 to 4 drops per minute.

The wick type - In this system, oil is transferred to the air stream by having the air pass over a wick saturated in oil. The amount of oil injected this way is determined by how much of the wick is exposed to the air. The normal factory setting is for 50% wick exposure. Raise or lower the wick, by opening the lubricator, for more or less oil.

The wick type lubricator requires a fairly high volume of air to function - a minimum of 30 SCFM. This is roughly equivalent to seven, 1/2-inch impact wrenches operating simultaneously. Generally speaking, compressors of 10 horsepower or less do not have the capacity to handle a wick type lubricator.

Poly bowl vs. Metal bowl - If you are using a standard lubricant, such as 10 weight non-detergent motor oil, either bowl is satisfactory. If you are using a proprietary air tool oil or a specialty lubricant, opt for the metal bowl. Some of these special lubricants may damage poly bowls. For rotary screw compressor applications use a metal bowl. Poly bowls damaged by chemicals are not covered by warranty. Always install a lubricator after a filter or regulator, never before.

**WARNING! - ALL FRL's
FOR COMPRESSED AIR
SERVICE ONLY.
NOT TO BE USED ON
LIFE SUPPORT OR
BREATHING AIR
SYSTEMS.**



FILTERS

The basic air control device for all systems. Removes solid particulate matter and water condensate. Available in a wide variety of sizes.

REGULATORS

A full line of regulators in both standard pressure (2-125 psi) and high pressure (10-250 psi). All metal construction.

LUBRICATORS

Precision lubricators to automatically provide essential oil to all your pneumatic tools. Can be adjusted to deliver the correct amount.

PIGGYBACK REGULATOR

The ideal package for a basic air control system. Same features as our standard regulator and standard Micro-Filter. Easy installation.

OIL REMOVING FILTER

Removes oil and oil vapors from the air line. Prevents oil pull-over from entering your paint spray gun and marring the paint job.

MILTON INDUSTRIES, INC.
The air management people
 See your jobber for the full product line

4500 W. Cortland Street, Chicago, Illinois 60639
 Phone: (773) 235-9400 FAX: (773) 235-3221
 Web Site: www.miltonindustries.com



A COMPLETE LINE OF COUPLERS, PLUGS, CHECK VALVES, SAFETY VALVES ...

F-R-L TRIO

A complete system for standard shop applications. Includes a standard Micro-Filter, regulator and lubricator in one easy-to-install package.

MINI F-R-L TRIO

Ideal for low air volume applications such as art studios, model shops and laboratories. Regulator, filter and lubricator also available separately.

MINI AIR STATION

A self-contained desiccant filter for spray painting. Complete with desiccant and low pressure regulator. Clips to your belt.

DESICCANT DRYER SYSTEM

For the ultimate in water-free and oil-free air you can't beat the Deluxe Desiccant Dryer System. Complete with Micro-filter, oil removing filter, pressure regulator and desiccant dryer. Ready to go with nothing else to buy.



CHEMICALS NOT TO BE USED WITH POLY BOWLS

Do not use synthetic oils or oils containing phosphate esters or chlorinated hydrocarbons. They can carry over from the compressor into the air lines and attack or crack poly bowls. Do not expose these bowls, even from external sources, to: alcohol, carbon tetrachloride, trichlorethylene, acetone, paint thinner, cleaning fluids and similar materials. These chemicals and other similar chemicals can craze or crack a poly bowl. If in doubt, use a metal bowl, especially since poly bowls damaged by chemicals are not covered by warranty.

ROTARY SCREW COMPRESSORS

For these applications use a metal bowl.

METAL BOWL LUBRICATORS

The sight glass in these units will crack if exposed to alcohol or alcohol based fluids.