

Introduction to FAIR engine

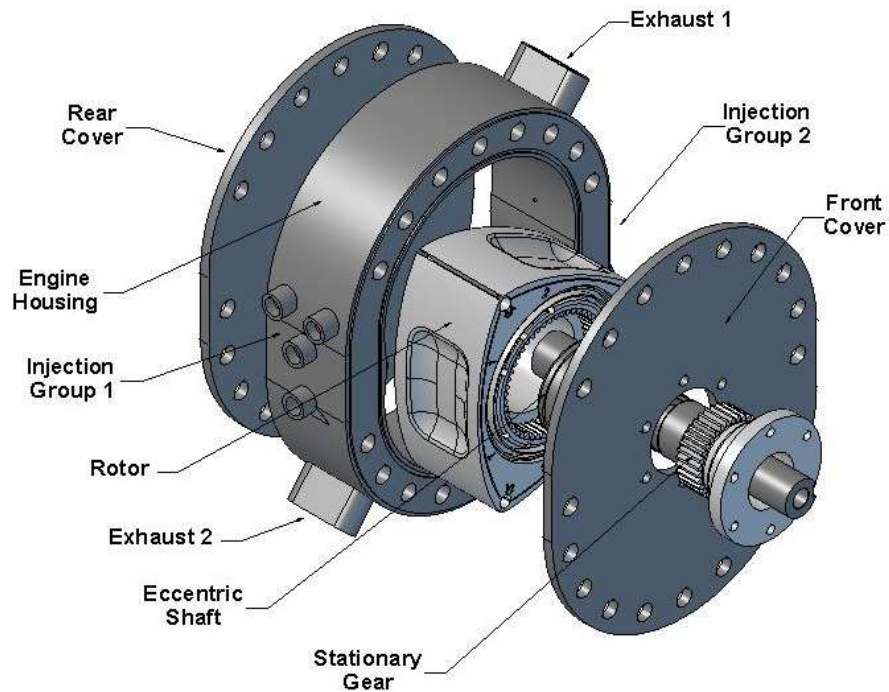

kanslab@yahoo.com

www.kanslab.com



What is a FAIR Engine

FAIR (Fuel-Air Injection Rotary) engine is an implementation of Fuel-Air Injections to a modified Wankel rotary engine. It replaces the air compression section of a Wankel rotary engine with a secondary combustion mechanism in addition to the original one. Therefore, a FAIR engine executes two combustion cycles and delivers two power strokes per shaft revolution versus a Wankel engine which delivers one power stroke per shaft revolution.

Wankel rotary engine delivers advantages of simplicity, smoothness, compactness, high revolutions per minute, and a high power-to-weight ratio. However, with a unique structure it also has many disadvantages such as apexes fatigue, slow combustion due to narrow-shaped combustion chamber, poor fuel economy and high emissions.

FAIR engine injects Oxygen Enriched Compressed Air (OECA) into the combustion chambers to accelerate the chemical reaction for thorough combustion and reduce NO_x, HC, CO, etc. emissions. Each combustion cycle starts first with a fuel injection, then air injection and sparks ignite the mixture. Ignition of the mixture depends on the air injection timing and is independent to fuel property, therefore alternate fuels can be used.

FAIR is a single thermal cycle IC engine, it may be considered as a high efficiency rocket engine with exhaust driving a rotor to generate the torque (Fig. 1).

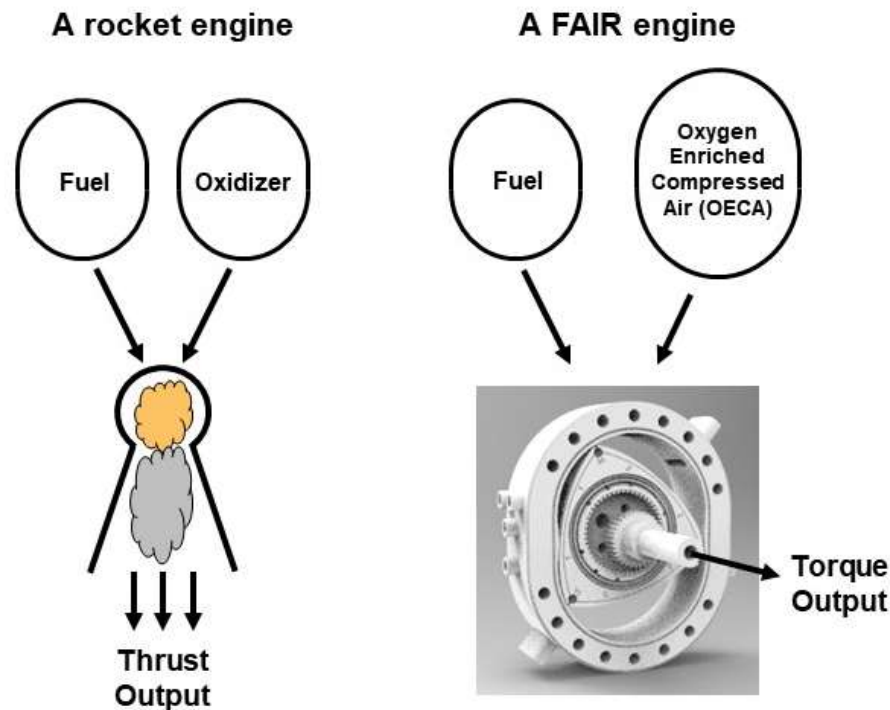

Fig. 1: A rocket engine outputs thrust and a FAIR engine outputs torque.

Oxygen enriched air injection accelerates through combustion, but the combustion generated high heat also has the potential to melt down the engine. FAIR engine uses two cooling methods: (1) air pressure regulators are built in the engine housing - when OECA drop pressure from 300 bar to 40 bar before the injection, air expansion absorbs heat. The pressure regulators function like air refrigerators to cool down the engine housing. (2) A unique maintenance pre-cycle is embedded to every combustion cycle. The evaporation of injected fuel absorbs heat around the upcoming apex and rotor before the combustion is ignited by sparks and air injection.

FAIR engine configurations

A full-blown FAIR engine with integrated air compressor (Fig. 2) may be used to replace Otto or Diesel engines for heavy duty, long-haul vehicle such as truck, bus, train, aviation, electric generator or stationary powerplant. Optional pneumatic output may be used for AIP (air independent propulsion), exoskeleton or field robot applications.

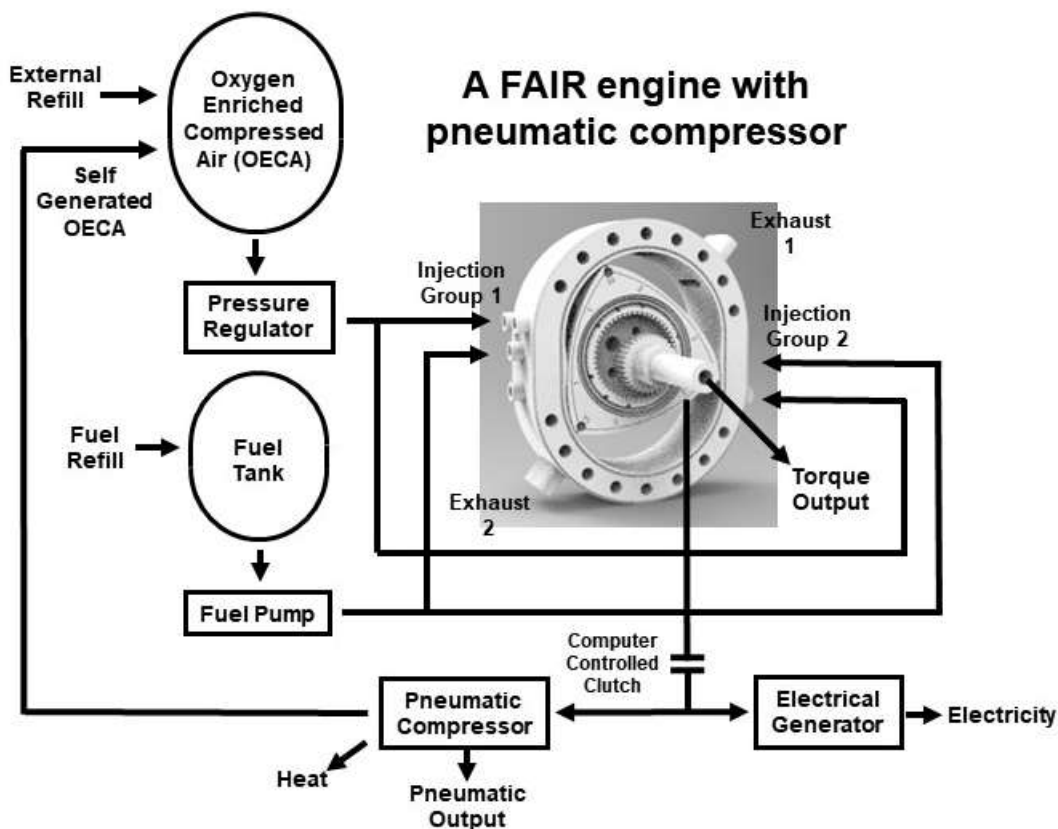

Fig. 2: A full-blown FAIR engine generates OECA with integrated air compressor and oxygen filter.

A light structured FAIR engine carries fuel (most likely propane) and OECA cylinders without air compressor (Fig. 3). It is ideal for light duty applications such as EV range extender, personal mobility, power tool, drone, robot, exoskeleton, sport equipment, electric motor replacement, ultralight, VTOL, UAV or glider powerplant, etc.

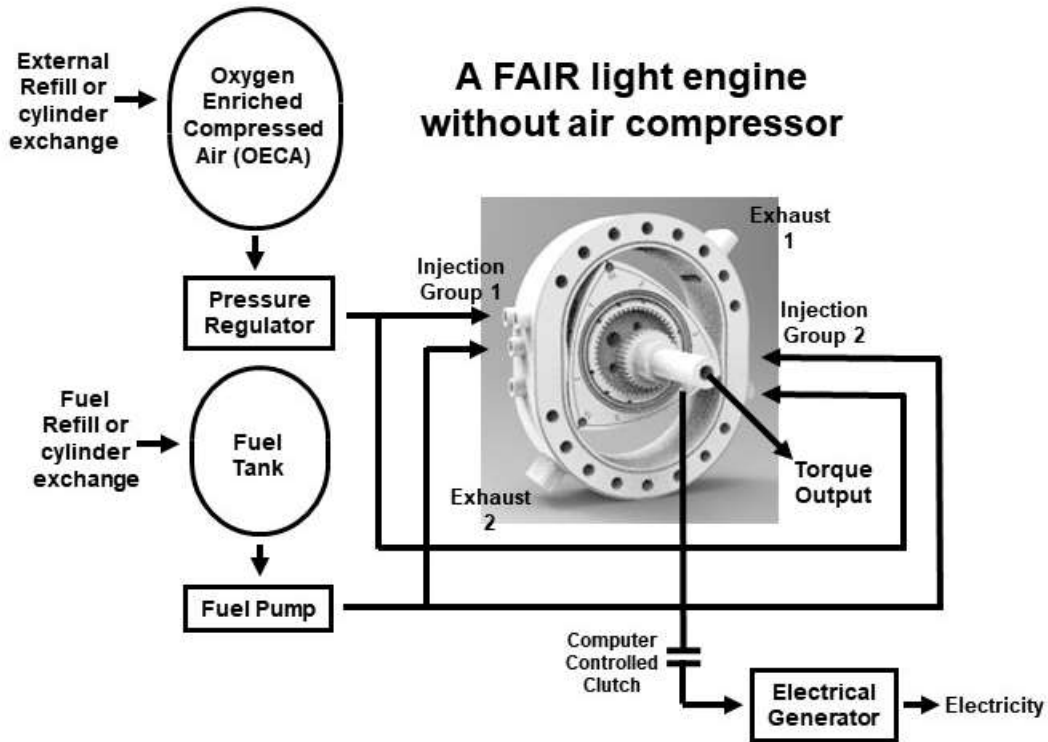
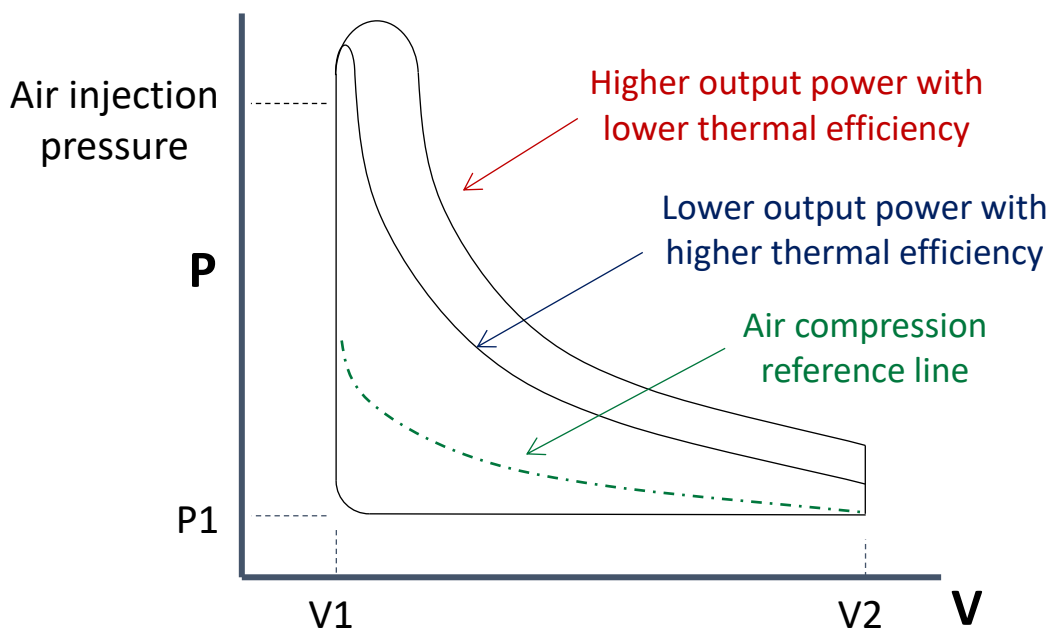

Fig. 3: A FAIR light engine depends on external refill or carried fuel and OECA cylinders.

Advantages of FAIR engine

1. High power to weight ratio with more than twice the power output than conventional Wankel engine (no air compression losses).
2. Oxygen enriched air injection enhances fuel combustion, increases thermal efficiency and reduces (NO_x, HC, CO) emissions.
3. Engine doesn't generate air compression heat. Engine housing with built in air pressure regulators functions like an air refrigerator which sinks the heat generated by high temperature combustion.
4. A maintenance sub-cycle absorbs heat with evaporating fuel to extend the life cycle of the apexes and the rotor. Engine doesn't need water jacket for cooling.
5. Hybrid power mode with air compressor offloaded which provides wide torque output range in response to various loading demands.
6. Alternate or bio-fuels can be used. The combustion solely depends on air injection timing but independent to fuel property.
7. Kinetic energy recovery by air compressor.
8. Engine starts with pneumatic power, no need for starter or heavy batteries.
9. Engine has a simple structure with only two moving parts for better reliability and less frictional losses. Low manufacturing cost due to simple engine structure.
10. AIP (Air Independent Propulsion). Engine can be operated underwater, underground or high altitude, powertrains can be built with waterproof to prevent flood damage. Also, OECA may provide life support oxygen.
11. Rotary mechanism produces low vibration and smooth output.
12. Uniflow reduces turbulence losses.
13. Emission is digitally treated in the combustion chamber rather than after treatment in the exhaust system.
14. Programmable combustion with wide output range. Flexible tradeoff between output power and thermal efficiency, output controllability allows FAIR engine to emulate electric motor for many power applications.



Disadvantages of FAIR engine

1. For all rotary engines, three-dimensional sealing results to more gas leakage than piston engines, which is a tradeoff for simplicity and smoothness.
2. Small amount of lubrication oil would be consumed.

Q & A

1. Would oxygen extraction from the air deteriorate the environment ?

No. Nothing can stop human activities, they will be done efficiently or inefficiently. Efficient execution helps preserve the environment. Oxygen will be regenerated by photosynthesizing every day.

2. Which is the most significant feature out of all advantages ?

Other than high power ratio, fuel efficiency and clean emission, the most important and unique feature of FAIR engine is the programmable combustion. By controlling Fuel-Air injections amount, output of FAIR engine is stroke-by-stroke controllable, similar to an electric motor being controlled by ESC (Electric Speed Control) signal. This controllability allows the FAIR engine to replace electric motor for precise applications such as heavy-duty Quadcopter.

Supplement:

Why Fuel-Air Injection (FAI)

Conventional piston engines have difficulties to meet today's environmental and energy efficiency challenges. Century old four-stroke engine principle uses 50% of its bandwidth for air intake and compression while the engine is supposed to deliver power, not consume power. Also, 79% of the intake air is nitrogen which impedes the combustion and creates harmful NO_x emission. These structure imperfections cause subsequent fuel inefficiency and pollution problems. Conventional engines are functional but inefficient because of:

- (1) Thermal efficiency is hampered mainly due to time sharing of the cylinder (Fig. 4). Air compression and gas expansion are two distinct processes; each has its own efficiency criteria. Since these two processes sequentially time share the same cylinder, both efficiencies are limited for optimization. Within the same cylinder, pressure after combustion is much higher than before, cylinder sharing results in high pressure exhaust being discharged into the environment with useful kinetic energy wasted and noises generated.
- (2) 79% of air content is nitrogen, intake nitrogen into cylinder not only impedes combustion but also creates harmful NO_x emission.
- (3) Complicated engine structure results in severe heat and frictional losses associated with piston rings, valves and valve-train.

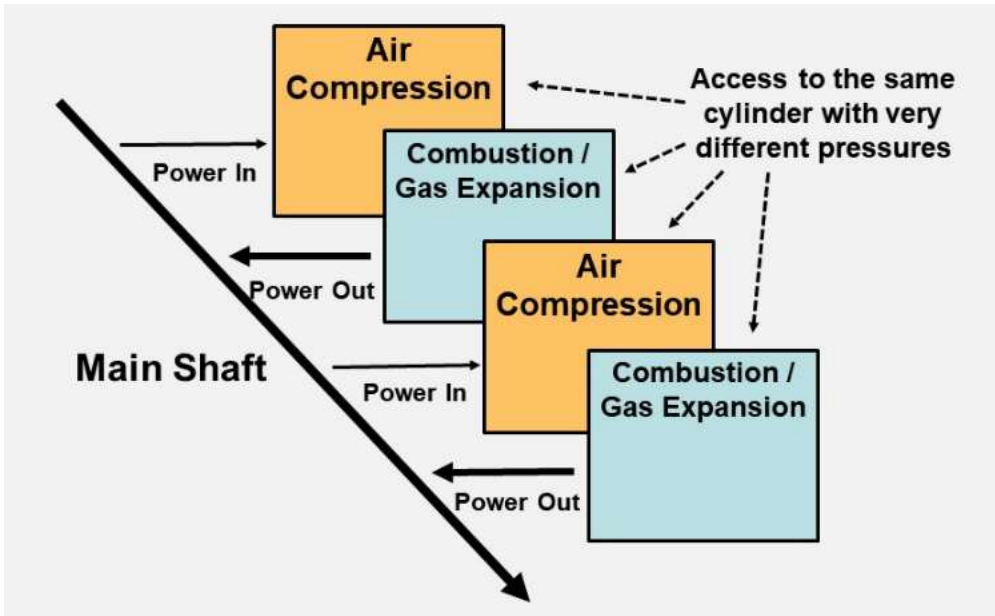
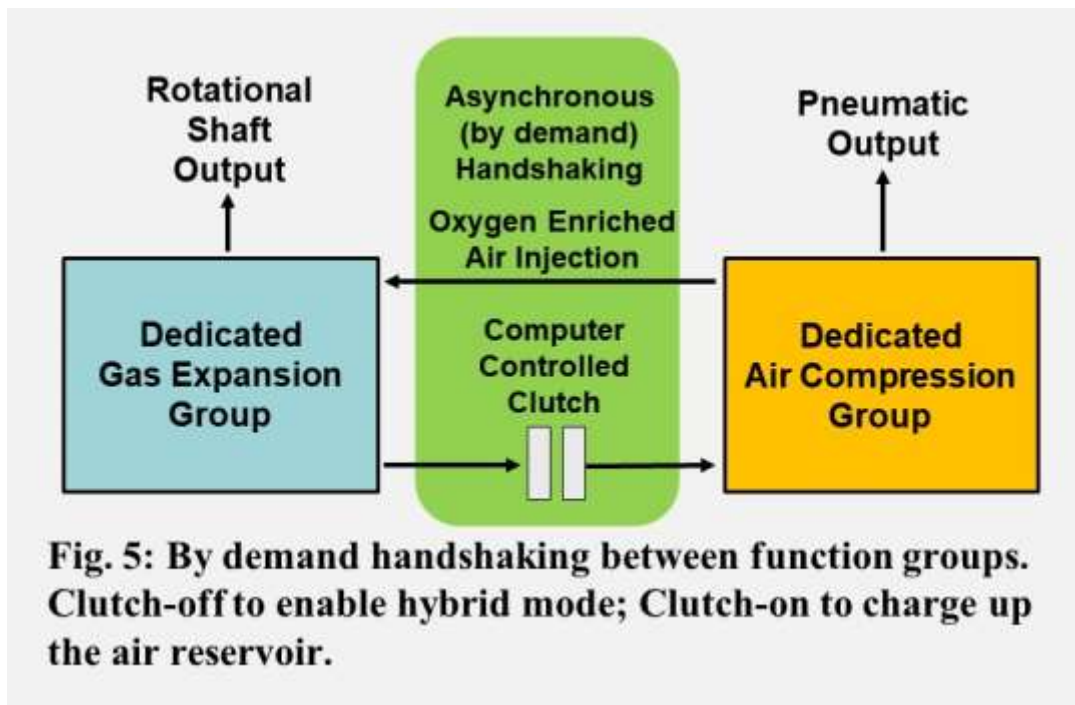

Fig. 4: A conventional cylinder sharing engine structure

FAI concept

All engines need to intake and compress air; however, conventional adiabatic air compression generates unwanted heat with valuable fuel while compressed air could be produced by cheaper renewable energy or underutilized grid power with polytropic compression (multistage compressor) in background and consumes less power. Real-time air compression misses the opportunity to preclude the nitrogen from the air. Air could pass through an oxygen enrichment process before the compression, so the injected air has higher oxygen content therefore creating less NO_x emission.

FAI (Fuel-Air Injection) engine implements pre-compressed air injection for combustion, the engine is dedicated for power delivery. FAI concept is based on discrete (simplified) engine structure (US patent 9121337, 9677468). It restructures a conventional engine and divides it into two separate, dedicated units; a gas expander (the engine) and an air compressor/filter. Two dedicated units synchronize each other with computer and sensors (Fig. 5). It is essential to have the combustion / expansion independent from the intake / compression to increase the thermal efficiency. For air compression, a dedicated air compressor provides higher compression efficiency and most importantly, nitrogen can be precluded from the compressed air. With modern nanotechnologies, run-time nitrogen preclusion filtering is practical and cost-effective.



FAI engine evolution

FAI engine is a structure reform of conventional piston engine in order to optimize thermal efficiency and reduce pollutant emission. Fig. 6 illustrates a conceptual evolution of a conventional engine into a FAI engine.

Fig. 6a represents a conventional 4-stroke 4-cylinder engine.

Fig. 6b represents a functional regrouping made to Fig. 6a.

Intake and compression strokes of cylinder 1, 2 interchange positions with combustion and exhaust strokes of cylinder 3, 4. Result of the interchanging converts cylinder 1, 2 into dedicated power stroke group and cylinder 3, 4 into dedicated air compression group. The structure regrouping results to a 2-stroke 2-cylinder engine with cylinders 3, 4 behave as air compressor loads.

Fig. 6c represents the synchronization (timing and resources) of the engine is reestablished by stored air and computer-controlled timing.

A new discrete structured engine (Fig. 6d) opens doors for optimizing to both dedicated function groups. Digital controlled fuel and air injections enable the programmable combustion, Oxygen Enriched Compressed Air (OECA) injection enhances the combustion and reduces NO_x emission.

(Conventional cylinder sharing)

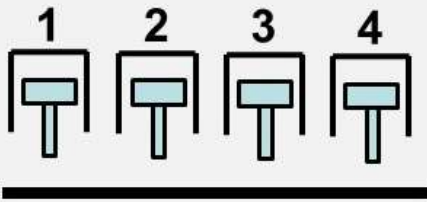

Main Shaft

Fig. 6a: A 4 stroke 4 cylinder engine

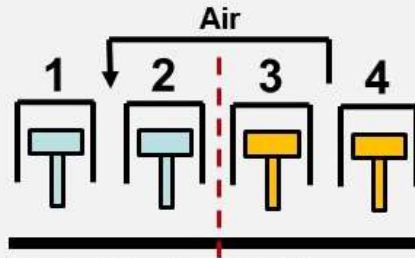

Main Shaft | Air Compressor

Fig. 6b: Functional regrouping

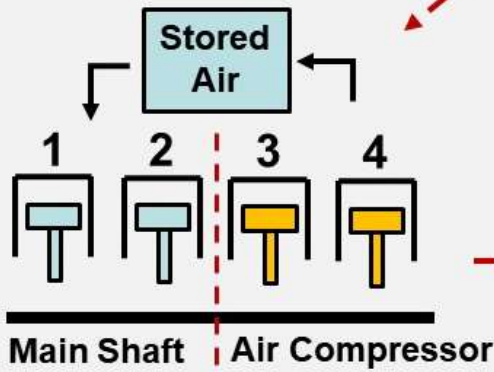

Fig. 6c: Resync the operation with stored air and computer

Optimization

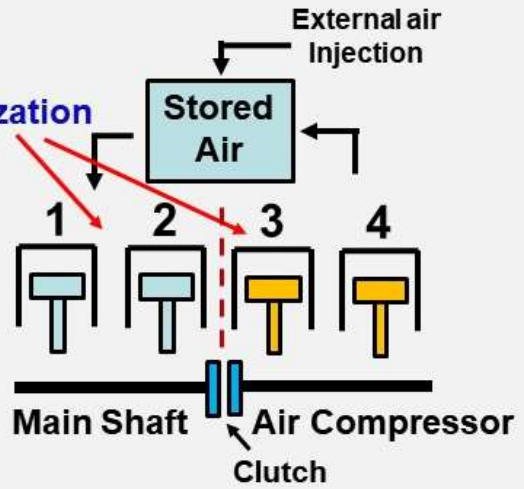

Fig. 6d: A FAI engine