



Centroid T-Series Lathe Operators Manual

CNC Software version: CNC11 V.3.16

Models: T400 & T39



- Introduction **1-1**
- Operators Panel **2-1**
- Main Screen **3-1**
- Tool Setup **4-1**
- Part zero and WCS **5-1**
- Running a Job **6-1**
- Utility Menu **7-1**
- Intercon Conversational Programming **8-1**
- Intercon Tutorials **9-1**
- CNC Program codes **10-1**
- G- Codes **11-1**
- M code functions **12-1**
- CNC Program Examples **13-1**
- Configuration **14-1**
- CNC Software Messages **15-1**

Table of Contents

CHAPTER 1 - Introduction

Window Description	1-1
Conventions	1-3
Machine Home	1-4
Lathe M and G Codes	1-5
Software Unlocks	1-6

CHAPTER 2 - Operator Panels

T-Series Jog Panel	2-1
Keyboard Jog Panel	2-5
Keyboard Shortcut Keys	2-7

CHAPTER 3 - Main Screen

Option Descriptions	3-1
---------------------	-----

CHAPTER 4 - Tool Setup

Tool Geometry Offset Library	4-1
Tool Wear Adjustment Screen	4-4
Procedures for Setting up Tools	4-5
Setting up Tool Orientation, Type, Approach	4-6
Setting up Nose Vector	4-7
Setting up X-Axis Tool Offsets for OD Tools	4-8
Setting up X-axis Tool Offsets for ID Tools	4-10
Setting up X-Axis Offsets for Drills and Taps	4-12
Setting up X-Axis Offsets for Boring Tools	4-13
Setting up Z-Axis Tool Offsets	4-13
Setting up Part Cutoff Tool Z-Offset	4-15
Setting up Nose Radius	4-16
Automatic Tool Touch-off cycles	4-17

CHAPTER 5 - Part Zero and WCS

Part Zero Menu	5-1
Setting Part Zeros	5-3
WCS Configuration Menu	5-6
Using Work Coordinate Systems	5-8

CHAPTER 6 – Running a Job

Job Run Screen with G-code Display	6-1
Run-Time Graphics	6-2
Canceling a Job in Progress	6-2
Resuming a Canceled Job	6-3
Run Menu	6-3
Power Feed	6-5

CHAPTER 7 - The Utility Menu

F2 – Update, F3 – Backup, F4 – Restore	7-1
F5 - File Ops	7-2
F6 - User Maint., F7 - Report, F8 - Options,	7-3
F9 - Logs	7-3

CHAPTER 8 - Lathe Intercon Manual

Lathe Intercon Main Menu	8-1
Lathe Intercon File Menu	8-5
Insert Operation	8-8
Linear	8-9
Arc	8-11
Drill	8-14
Tap	8-16
Thread	8-17
Profile	8-21
Turning	8-24
Groove	8-27
Cutoff	8-29
Other Operations	8-30
Graphics	8-34
Math Help	8-35
Intercon Lathe Tool Library	8-41

CHAPTER 9 - Lathe Intercon Tutorials

Lathe Intercon Tutorial #1	9-1
Lathe Intercon Tutorial #2	9-9

CHAPTER 10 - CNC Program Codes

Miscellaneous CNC Program Symbols	10-1
User and System Variables	10-5
Advanced Macro Statements	10-8

CHAPTER 11 - G Codes

G-Code Quick Reference	11-1
G-Code Descriptions	11-2

CHAPTER 12 - M-functions

M function Quick Reference	12-1
Customizable M functions	12-2
M function Descriptions	12-3

CHAPTER 13 - CNC Program Example

CHAPTER 14 - Configuration

Password	14-1
Control Configuration	14-2
User-Specified Paths	14-3
Machine Configuration	14-4
Machine Parameters	14-9
PID Menu	14-37

CHAPTER 15 – CNC11 messages







CNC11 Message Descriptions	15-1
----------------------------	------

**READ THIS MANUAL BEFORE USING THIS PRODUCT.
FAILURE TO FOLLOW THE INSTRUCTIONS AND SAFETY
PRECAUTIONS IN THIS MANUAL CAN RESULT IN
SERIOUS INJURY OR DEATH.**

All operators and service personnel must read this manual before operating CENTROID CNC control equipment and all connected machine tools.

Keep this manual in a safe location for future reference.

Throughout this manual and on associated products where applicable, in accordance with ANSI Z535, the following symbols and words are used as defined below:

 DANGER	“DANGER” with or without a red background = Hazard WILL cause death or serious injury if ignored.	 DANGER
 WARNING	“WARNING” with or without an orange background = Hazard COULD cause death or serious injury if ignored.	 WARNING
 CAUTION	“CAUTION” with or without a yellow background = Hazard MAY cause minor to moderate injury if ignored.	 CAUTION
NOTICE	“NOTICE” with or without a blue background = Indicates an action to prevent damage to the product or other materials used with product.	 NOTICE

Information provided by CENTROID relating to wiring, installation, and operation of CNC components is intended as only a guide, and in all cases a qualified technician and all applicable local codes and laws must be consulted. CENTROID makes no claims about the completeness or accuracy of the information provided, as it may apply to an infinite number of field conditions.

As CNC control products from CENTROID can be installed on a wide variety of machine tools NOT sold or supported by CENTROID, **you MUST consult and follow all safety instructions provided by your machine tool manufacturer regarding the safe operation of your machine and unique application.**

CENTROID CNC controls provide facilities for a required Emergency Stop circuit which can be used to completely disable your machine tool in the event of an emergency or unsafe condition. **Proper installation of your CNC control MUST include the necessary wiring to disable ALL machine tool movement when the Emergency Stop button is pressed.** This includes machine, servo motors, tool changers, coolant pumps, and any other moving parts. DO NOT disable or alter any safety feature of your machine or CNC control.



Never alter or remove any safety sign or symbol from your machine or CNC control components. If signs become damaged or worn, or if additional signs are needed to emphasize a particular safety issue, contact your dealer or CENTROID.

CNC Control Operating Specifications

	Minimum	Maximum
Operating Temperature	40°F (5°C)	104°F (40°C)
Ambient Humidity	30% relative, non-condensing	90% relative, non-condensing
Altitude	0 Ft. (Sea Level)	6000 Ft. (1830m)
Input Voltage (110, 220, 440 VAC, System Dependent)	-10% of Specified System Input Voltage	+10% of Specified System Input Voltage

Note: Your machine may have operating conditions different than those shown above. Always consult your machine manual and documentation.

Safety signs and labels found on your machine tool, and on CNC system components typically follow the following examples:

Warning Symbol	Hazard Severity Level & Word Message	Action Symbol
	 High Voltage Electrocution Hazard. Death by electric shock can occur. Turn off and lock out system power before servicing.	
The warning symbol identifies the potential hazard and reinforces the word message.	The severity level is one of “DANGER”, “WARNING”, “CAUTION”, or “NOTICE”. Word message includes 3 parts: hazard, consequence if warning is ignored, and action to prevent injury.	Indicates actions to prevent injury. Blue circles indicate mandatory actions to avoid harm. Red circles with diagonal slashes indicate prohibited actions to avoid harm.

CNC Machine Tool Safety

- All machine tools contain hazards from rotating parts; movement of belts, pulleys, gears, and chains; high voltage electricity; compressed air; noise; and airborne dust, chips, swarf, coolant, and lubricants. Basic safety precautions must be followed to reduce the risk of personal injury and property damage.
- Your local safety codes and regulations must be consulted before installation and operation of your machine and CENTROID CNC control. Should a safety concern arise, always contact your dealer or service technician immediately.
- Access to all dangerous areas of the machine must be restricted while the machine is in use. Ensure that all safety guards and doors are properly in place during use. **Automatically controlled machine tools may start, stop, or move suddenly at any time. Do not enter the machining area when the machine is in motion; death or severe injury may result.**
- Personal protective equipment, particularly ANSI-approved impact safety glasses and OSHA-approved hearing protection must be used. Proper handling, storage, use, and disposal of materials in accordance with manufacturer's instructions and Material Safety Data Sheets (MSDS, or your local equivalent) must be followed.
- DO NOT operate your machine or CNC control in explosive atmospheres or in environmental conditions outside of the manufacturer's specified ranges. Electrical power must meet the specifications provided by your machine and CNC control manufacturer.
- DO NOT operate your machine or CNC control if any safety systems are damaged or missing. Excessively scratched or damaged windows and guards must be replaced.
- ONLY authorized personnel should be allowed to operate the machine and CNC control. Improper operation can cause injury, death, and machine or control damage, and may void applicable warranties.
- All electrical enclosures and panels MUST be closed and secured at all times except during installation and service. Only qualified electricians and service personnel should have access to these locations. Hazards arising from high voltage electricity and heat exist in the control cabinet, and may exist even after the main disconnect is turned OFF.
- Improperly clamped or fixtured parts; improperly secured tooling; and broken parts, fixtures, and tooling resulting from machining operations at unsafe feedrates and speeds may result in projectiles being ejected from your machine, even through safety systems such as guards and doors. Always follow safe and reasonable machining practices and follow all safety precautions provided by your tooling and machine manufacturer.
- Ultimate responsibility for safe operation and maintenance of your machine and CNC control rests with shop owners and machine operators. Before performing any work or maintenance all individuals should be thoroughly acquainted with the safe operation of BOTH machine tool AND CNC control.
- Shop owners and operators are responsible for ensuring that shop and machine safety systems such as Emergency Stop and fire suppression systems are present and functioning properly, as required by local codes and regulations.

CNC Control Warning Labels



**High Voltage Electrocutation
Hazard.**

Death by electric shock can occur.
Turn off and lock out system power before
servicing.



**High Voltage Electrocutation
Hazard.**

Death by electric shock can occur.
Turn off and lock out system power before
servicing.

Chapter 1 Introduction

Window Description

The T-Series display screen is separated into five areas:

<i>DRO Display</i>		<i>Status Window</i>	
WCS #1 (G54)	Current Position (Inches)	Job Name: pawn.cnc	Program #20000
X	+0.8500	Tool: T0808	Feedrate: 100% 0.0 ipm
Z	+0.0050	Spindle: 0 A	Part Cnt: 0
			Part #: 0
			Time: 0:00:15
		<div style="border: 1px solid black; padding: 2px;"> 302 Moving... 307 Operator abort: job cancelled 301 Stopped 302 Moving... 313 Waiting for dwell time 302 Moving... Press CYCLE CANCEL to cancel </div>	
<i>Dist to Go</i>		<i>Message Window</i>	
X	-0.4500	22. M9	
Z	+0.0000	23. G96 S500.0 M3	
		24. G4 P1.0	
		25. G0 X0.85 Z0.1 T0808	
		26. X0.85 Z0.1	
		27. G94 X-0.05 Z0.005 G99 F0.01	
		28. ; --- M & G Code ---	
		29. N0006	
		30. g50s4000	
		31. ; --- Profile ---	
		32. N0007 S650.0 G0 X0.98 Z0.105	
		<i>User Window</i>	
		<i>Function Key Options</i>	
		Repeat On F3	/Skips On F4
		Rapid Off F9	

DRO display

The DRO display contains the digital readout for the current position of the tool. The display is configurable for number of axes and desired display units of measure (see Chapter 14). Use the Alt-d “Hot Key” combination to change the display between machine position and the current WCS position.

The bars under each axis are the load meters and represent the amount of power being supplied to the drive for that axis. The display of axis load meters is configured by machine parameter 143 – see Chapter 14 for specific information.

The symbol next to the X axis DRO indicates Diameter or Radius mode. The mode is configured by machine parameter 55 – see Chapter 14 for specific information. If the X axis DRO is in Diameter mode, it will look like this:



If the X axis DRO is in Radius mode, it will look like this:

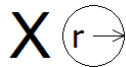

Distance to Go DRO

The distance to go DRO is located below the main DRO. This display shows the distance to go to complete the current move. The display of the distance to go is controlled by parameter 143. See Chapter 14 for details or it can be turned on by using **Ctrl+D**, see “Hot Keys” see chapter 2 for more details.

Status window

The first line in the status window contains the name of the currently loaded job file (see Chapter 3). Below the job name are the Tool Number and Tool Offset, Program Number, Feedrate Override, Spindle Speed, and Feed Hold indicators. The Feedrate Override indicator displays the current override percentage set on the Jog Panel. If your machine is equipped with a variable frequency spindle drive (inverter), the Spindle indicator will display the current spindle speed. The Feed Hold indicator displays the current status of the **FEED HOLD** button located on the Jog Panel. If **FEED HOLD** is on, then the Feed Hold indicator will indicate 'On' and can only be turned off by pressing **CYCLE START**.

The Part Count and Elapsed Time indicators are not always displayed. Pressing **CYCLE START** while a job is running will cause the indicators to appear. The Part Count indicator displays the number of times the current part has been run and upon the completion of each run, it can increment/decrement by one. If a job is canceled prematurely, the Part Count will not be incremented. The Part # counter shows how many parts have been run, with an up/down arrow displayed to indicate the counting direction. See the run menu for more information on the Part Count and Part# setting.

The Elapsed Time indicator displays the amount of time passed since **CYCLE START** was pressed. The indicator will help you to determine how long it takes to cut a particular part. The timer will not stop until the job is finished or canceled for any reason. It will continue to count for optional stops, tool changes, FEED HOLD, etc.

Message window

The message window is divided into a message section and a prompt section. The prompt section is the lowest text line in the window and will display prompts to the user. For example, the prompt 'Press **CYCLE START** to start job' is displayed on the prompt line after power up.

The message section is the top four text lines of the message window. This section will display warnings, errors, or status messages. The newest messages always appear at the bottom of the four lines. Old messages are shifted up until they disappear off the top of the message window. When this happens, a scroll bar appears. When the scroll bar is visible, use the up and down arrow keys to view older messages. See Chapter 15 for a description of the T-Series error and status messages.

Function Key Options

Options are selected by pressing the function key indicated in the box. For example, on the Main Screen, pressing the function key **F5-CAM** selects the CAM option.

User window

The information contained in this window is dependent on the operation you are performing on the control. Enter the part zeros and the tool library setup information in this window. The window is empty if you are performing no action.

For example, when the **CYCLE START** button is pressed and a job is processed correctly, up to 11 lines of G-code will be displayed in this window.

Conventions

- There are 10 function keys used by the control. They are represented by **F1, F2,...** **F10**. Keystrokes other than the function keys are represented by the capitalized name of the key in bold font. For example, the A key is written as **A** and the "Enter" key is written as **ENTER**. The "Escape" key is written as **ESC**. Key combinations such as **ALT+D** mean that you should press and hold **ALT** then press **D**.
- Data entry menus on the T-Series Control usually use **F10-Save** to save changes and **ESC** to discard changes.
- Any menu in the T-Series Control can be exited by pressing **ESC**. This will take you back to the previous menu, pressing **ESC** enough times will eventually take you back to the main screen. This also usually discards any changes you have made in that menu.
- The Centerline of the part (and Spindle) is usually considered to be $X=0$.
- The orientation of the axes are as follows: $X+$ always points *away* from the Centerline and $Z+$ always points to the right and away from the Spindle. Although the T-Series Control is able to display the $X+$ direction as either oriented up or down (set in Machine Parameter 1), most of the illustrations in this manual will show $X+$ as pointing upward, as if the tool turret is mounted behind the centerline of the spindle.

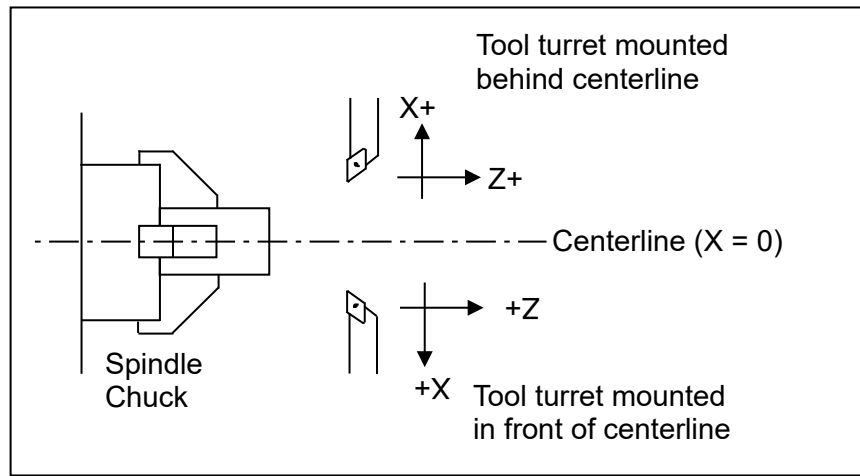

- Tools move in X and Z directions. The work piece remains in a stationary location relative to X and Z .
- **CW** stands for clockwise and **CCW** stands for counterclockwise.
- The work piece physically spins in the Spindle Chuck, the **CW** and **CCW** directions refer to the chuck spinning in those directions when viewed in the $Z+$ direction (Through the spindle towards the tailstock).
- **ID** means Inner Diameter, and **OD** means Outer Diameter.

Machine Home

When the T-series control is first started, the Main Screen will appear as below.

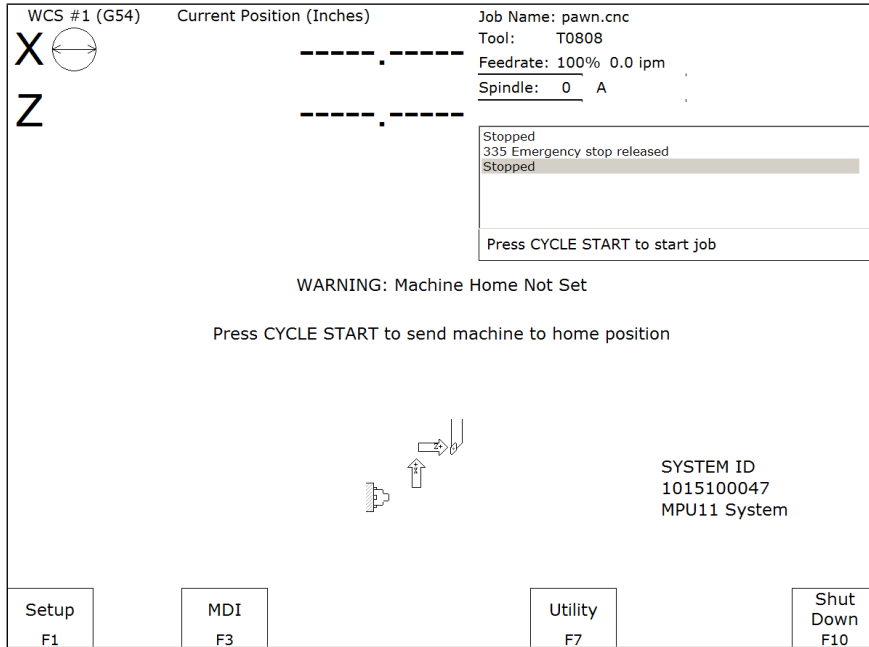

Before you can run any jobs, you must set the machine home position. If your machine has home/limit switches, reference marks or safe hard stops, the control can automatically home itself. If your machine has reference marks, jog the machine until the reference marks are lined up (see below). Then press **CYCLE START** to begin the automatic homing sequence. The control will execute the G-codes in a file called `cnc.hom` in the `c:\cnc` directory. By default, this file contains commands to home X to its plus limit and home Z to its plus limit.

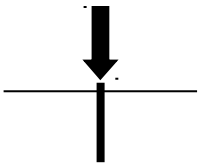

Typical Reference Marks

If your machine does not have home/limit switches or safe hard stops, the following message will appear instead.

WARNING: Machine Home Not Set

- 1) Jog all axes to their home positions
- 2) Press **CYCLE START** to set machine home

In this case you must move the machine to its home position yourself, using either the jog keys or the handwheels. Once all axes are at their home positions, press **CYCLE START** to set machine home.

Lathe M and G Codes

M00 Stop For Operator	G00 Rapid to Position
M01 Optional Stop for Operator	G01 Linear Move
M02 Restart Program	G02 CW Arc Move
M03 Spindle On Clockwise	G03 CCW Arc Move
M04 Spindle On Counterclockwise	G04 Dwell
M05 Spindle Stop	G10 Set Parameter
M07 Mist Coolant On	G20 Inch Units
M08 Flood Coolant On	G21 Metric Units
M09 Coolant Off	G22 Work Envelope On
M10 Clamp On	G23 Work Envelope Off
M11 Clamp Off	G28 Return to Reference Point
M26 Set Axis Home	G29 Return from Reference Point
M29 Set Tap Mode for G84	G30 Return to Secondary Reference Point
M30 Restart Program	G32 Constant Lead Thread Cutting
M50 C Axis Disable	G40 Cancel Cutter Compensation
M51 C Axis Enable	G41 Cutter Compensation Left/Right
M91 Move to Minus Home	G42 Cutter Compensation Left/Right
M92 Move to Plus Home	G50 Coordinate System Setting OR Maximum Spindle Speed for CSS mode
M93 Release/Restore Motor Power	G52 Offset Local Coordinate System Origin
M94/M95 Output On/Off	G53 Rapid Positioning in Machine Coordinates
M98 Call Subprogram	G54-G59 Select Work Coordinate System
M99 Return from Macro or Subprogram	G65 Call Macro
M100 Wait for PLC bit (Open, Off, Reset)	G70 Profile Finishing Cycle (after Profile Stock Removal)
M101 Wait for PLC bit (Closed, On, Set)	G71 Profile Stock Removal in Turning
M102 Restart Program	G72 Profile Stock Removal in Facing
M103 Programmed Action Timer	G73 Profile Path Repeat
M104 Cancel Programmed Action Timer	G74 End Face Peck Cutting Cycle
M105 Move Minus to Switch	G75 Outside/Inside Diameter Peck Cutting Cycle
M106 Move Plus to Switch	G76 Multi-Pass Threading Cycle
M107 Output BCD Tool Number	G80 Canned Cycle Cancel
M108 Enable Override Controls	G83 Deep Hole Drilling (Canned Cycle)
M109 Disable Override Controls	G84 Tapping (Canned Cycle)
M115,M116,M125,M126 Protected Move Probing	G85 Boring (Canned Cycle)
M120 Open data file (overwrite existing file)	G90 Outside/Inside Diameter Cutting Cycle
M121 Open data file (append to existing file)	G92 One-Pass Thread Cutting Cycle
M122 Record position(s) in data file	G94 End Face Turning
M123 Record value and/or comment in data file	G96 Constant Surface Speed (CSS mode)
M124 Record machine position(s) in data file	G97 Cancel Constant Surface Speed
M127 Record Date and Time in a data file	G98 Feed per minute
M128 Move Axis by Encoder Counts	G99 Feed per revolution
M129 Record Current Job file path to data file	
M130 Run system command	
M150 Set Spindle Position to 0 on Next Index Pulse	
M151 Unwind C axis	
M200/M201 Stop for Operator, Prompt for Action	
M223 Write Formatted String to File	
M224 Prompt for Operator Input Using Formatted String	
M225 Display Formatted String for A Period of Time	
M290 Digitize Profile	
M300 Fast Synchronous I/O update	
M1000-M1015 Graphing Color for Feedrate movement	

How to unlock software features or unlock your Control

The following are necessary to unlock software features:

1. If you are at the "Demo mode expired" screen, start at step 4.
2. Go to the Main screen of the Control software.
3. Press **F7** "Utility" and then **F8** "Option"
4. Press **F1** "Unlock Option". (You may need to enter the password – usually 137)
5. Next, type in the Unlock # and press **ENTER**.
6. Then, type in the Unlock Value and press **ENTER**.
7. Repeat step 4, 5, and 6 for each new Unlock.

Chapter 2

Operator Panel

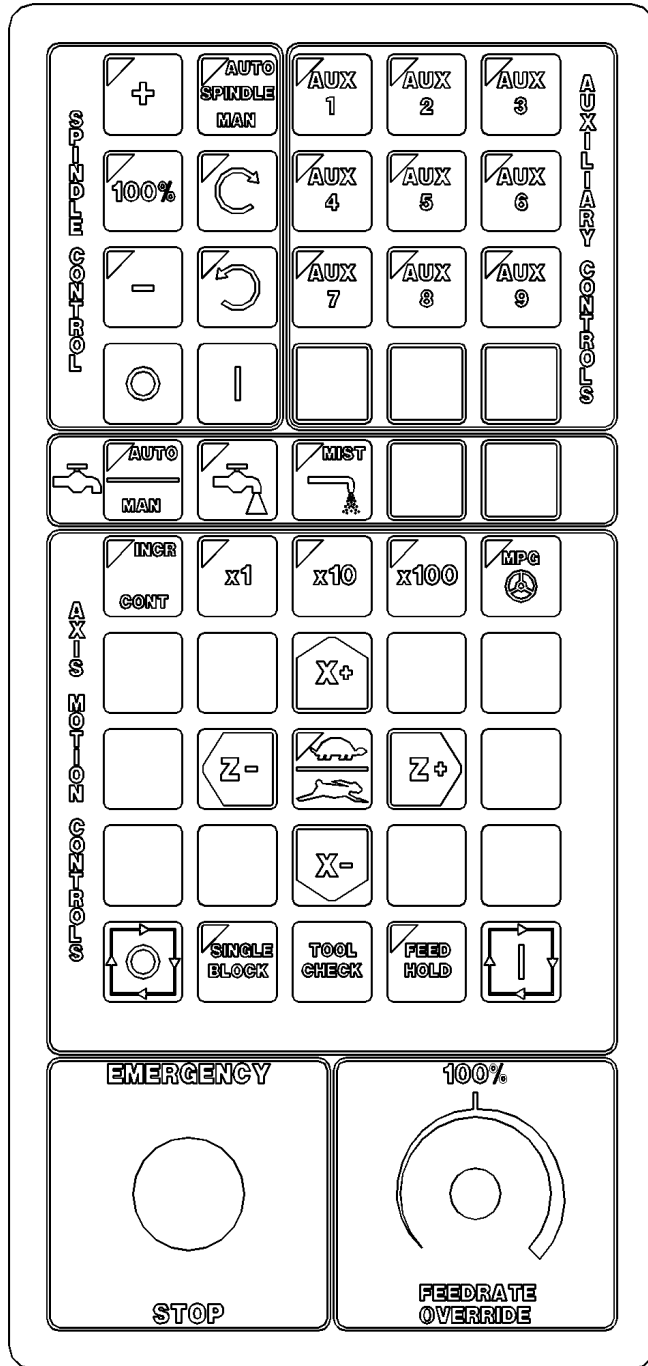

The operator panel is a sealed membrane keyboard that enables you to control various machine operations and functions. The panel contains momentary membrane switches, which are used in combination with LED indicators to indicate the status of the machine functions.

Axis Jog Buttons*

X+ X- Z+ Z-

The yellow X and Z keys are momentary switches for jogging the two axes of the machine. There are two buttons for each axis (+/-). Only one axis can be jogged at a time.

* NOTE: The jog buttons will not operate if the T-Series CNC software is not running, or if a job (a CNC program) is running.



Slow/Fast

The **slow/fast** key is located in the center of the Axis Motion Controls section and is labeled with the turtle and rabbit icon shown to the right. The turtle represents slow jogging mode. When SLOW jog is selected (LED on) and a jog button is pressed, the axis moves at the slow jog rate. If FAST jog is selected, the axis will move at the fast jog rate. See Chapter 14 for information on setting the fast and slow jog rates for each axis.

Inc/Cont

INC/CONT selects between incremental and continuous jogging. Pressing the key will toggle between these two modes. The LED is lit when INC is selected. If CONT jog is selected and an axis jog button is pressed, the axis will move continuously until the button is released.

Fig 1 - T-Series Jog Panel

*Rear mount, horizontal configuration shown. The control and jog overlay can be configured for a horizontal, or vertical machine configuration with front, rear, left or right mount tooling. See Chapter 14, Parameter 1 for further information on configuring your machine and tooling orientation.

x1, x10, x100

Press any one of these keys to set the jog increment amount. The amount you select is the distance the control will move an axis if you make an incremental jog (x1=0.0001", x10=0.0010" and x100=0.0100"). You may select only one jog increment at a time, and the current jog increment is indicated by the key that has a lit LED. The jog increment you select is for all axes; you cannot set separate jog increments for each axis. The jog increment also selects the distance the control will move an axis for each click of the MPG handwheel.



MPG

The MPG is housed in a separate hand-held unit. Press the **MPG** key to set the control jog to respond to the MPG hand wheel, if equipped. When selected, the LED will be on. Select the Jog Increment and desired axis and slowly turn the wheel. When the LED is not lit, the MPG is disabled and the jog panel is on.

NOTICE Do not spin the handwheel too quickly. Damage to the machine or part may result.

Single Block

The **SINGLE BLOCK** key selects between auto and single block mode. When the **SINGLE BLOCK** LED is on, the single block mode has been enabled. Single Block mode allows you to run a program line by line by pressing **CYCLE START** after each block. While in block mode you can select auto mode at any time. While in auto mode and a program is running you cannot select single block mode. Auto mode runs the loaded program after **CYCLE START** is pressed. Auto mode is the default (LED off).

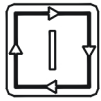

Cycle Start

When the **CYCLE START** button is pressed, the T-Series Control will immediately begin processing the current program at the beginning and will prompt you to press the **CYCLE START** button again to begin execution of the program. After an M0, M1, M2, or tool change is encountered in the program, the message

Press **CYCLE START** to continue

will be displayed on the screen, and the T-Series Control will wait until you press the **CYCLE START** button before continuing program execution.



WARNING Pressing **CYCLE START** will cause the T-Series Control to start moving the axes immediately without further warning. Be certain that you are ready to start the program when you press this button. Pressing the **FEED HOLD** button, **E-STOP**, or the **CYCLE CANCEL** button will stop any movement if **CYCLE START** is pressed accidentally.

Feedrate Override

This knob controls the percentage of the programmed Feedrate that you can use during feedrate cutting moves: lines, arcs, canned cycles, etc. This percentage can be from 0% to 200%.



CAUTION The Feedrate Override knob will not work during tapping cycles (G84) and threading moves (G32).

Feed Hold

Feed Hold decelerates motion of the current movement to a stop, pausing the job that is currently running. Pressing **CYCLE START** will continue the movement from the stopped location.



CAUTION **FEED HOLD** is temporarily disabled during tapping cycles (G84), threading moves (G32), and automatic tool changes (M6).

Tool Check

Pressing **TOOL CHECK** while a job (a CNC program) is not running will move the table to its tool change (G28) position. Pressing **TOOL CHECK** while a job is running will stop normal program movement, clear all M-functions, and automatically display the Resume Job Menu. From the Resume job menu, you will be able to change tool settings.

• **NOTE:** When a job is running, pressing **TOOL CHECK** once stops the job and allows you to manually jog the tool clear. Pressing **TOOL CHECK** a second time will cause the tool to move to its tool change (G28) position.



Cycle Cancel

Press **CYCLE CANCEL** to abort the currently running program. The control will stop movement immediately, clear all M-functions, and return to the Main Screen. It is recommended that you press **FEED HOLD** first before **CYCLE CANCEL**. If you press **CYCLE CANCEL**, program execution will stop; if you wish to restart the program you must rerun the entire program or use the search function. See search function operation in Chapter 6.

Emergency Stop

EMERGENCY STOP releases the power to all the axes and cancels the current job immediately upon being pressed. **EMERGENCY STOP** also resets certain faults if the fault condition has been fixed or cleared.

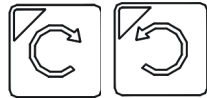

Spindle CW/CCW

The **SPINDLE CLOCKWISE/COUNTERCLOCKWISE** keys determine the direction the spindle will turn if it is started manually. If the spindle is started automatically, the direction keys are ignored and the spindle runs according to the program. The default direction is CW.



Spindle Speed +

Pressing this key will increase the spindle speed by 10% of the commanded speed in Auto spindle mode, limited by the maximum speed or 200% of commanded speed, whichever is less. For manual spindle mode, the spindle speed is increased by 5% of the maximum spindle speed (up to the maximum speed). The LED is on if the spindle speed is set above the 100% point.



Spindle Speed 100%

Pressing this key will set the spindle speed at the 100% point, which is defined as the commanded speed in Auto spindle mode, or ½ the maximum spindle speed in manual mode. The LED will be on when the spindle is at the 100% point.



Spindle Speed -

Pressing this key will decrease the spindle speed by 10% of the commanded speed in Auto spindle mode, limited to 10% of commanded speed. For manual spindle mode, the spindle speed is decreased by 5% of the maximum spindle speed down to 5% of maximum. The LED is on if the spindle speed is set below the 100% point.

Spindle (Auto/Man)

This key selects whether the spindle will operate under program control (automatic) or under operator control (manual). When the LED is lit, the spindle is under automatic control. If the LED is off, the spindle is under manual control. Pressing the **SPINDLE (AUTO/MAN)** key will toggle it from AUTO to MAN and back again. The default is AUTO mode.



Spin Start

Press the **SPIN START** key when manual spindle mode is selected to cause the spindle to start rotating. Press **SPIN START** when automatic mode is selected to restart the spindle if it has been paused with **SPIN STOP**.



Spin Stop

Press the **SPIN STOP** key when manual spindle mode is selected to stop the spindle. Press **SPIN STOP** when automatic mode is selected to pause spindle rotation and can be restarted with **SPIN START**.

NOTICE **SPIN STOP** should only be pressed during **FEED HOLD** or when a program is NOT running.

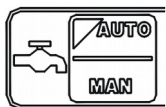

Coolant Auto/Manual

This key will toggle between automatic and manual control of coolant. In automatic mode, M7 (Mist) and M8 (Flood) can be used in G-code programs to select the coolant type to be enabled. In manual mode, flood coolant and mist coolant are controlled by separate keys. Note: When switching from automatic to manual mode, both flood and mist coolants are turned off automatically.



Coolant Flood

In manual coolant control mode, flood coolant can be toggled off and on by pressing this key. The LED will be on when flood control is selected in either automatic or manual mode.



Coolant Mist

In manual coolant control mode, mist coolant can be toggled off and on by pressing this key. The LED will be on when mist control is selected in either automatic or manual mode.

Auxiliary Function Keys (AUX1 – AUX12)

The T-Series jog panel has nine auxiliary keys, some of which may be defined by customized systems.

T-Stock In, T-Stock Out, Quill In, Quill Out, Turret Index

These buttons currently have no settings but can be added to one of the Aux keys and then programmed to control hydraulic stock clamps, Quills, or Turret index functions through the PLC. Your installer will provide you with the necessary documentation explaining the operation and functions these keys perform.

Keyboard Jog Panel

The PC keyboard may be used as a jog panel. Press **Alt-J** to display and enable the keyboard jog panel. The jog panel appears as shown below:

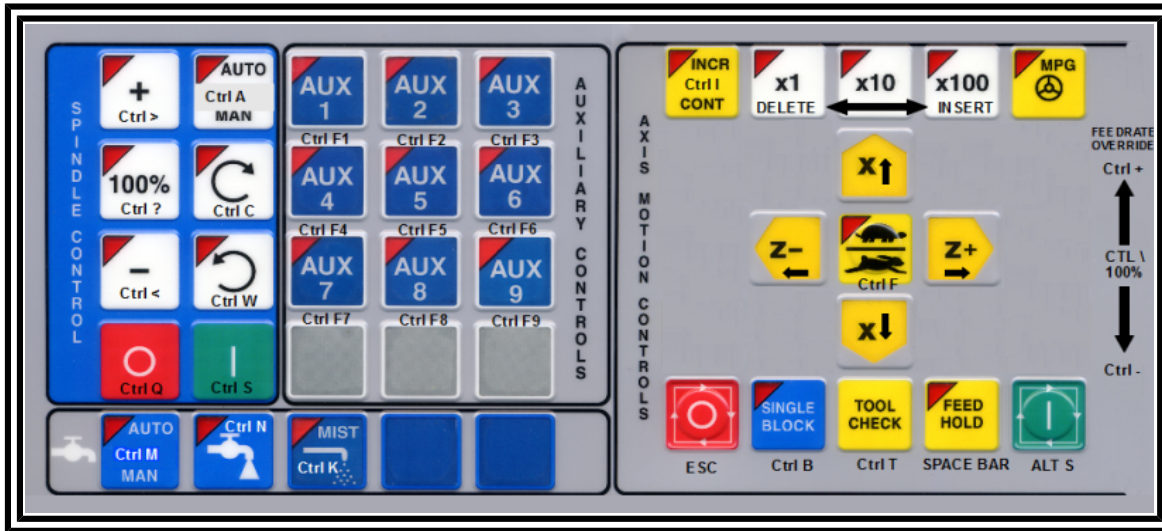











Some controls, such as coolant on/off, spindle on/off, feedrate and spindle override will work without the “jog panel” being displayed but for full functionality (and jogging) of the keyboard jog panel, the “jog panel” must be displayed on the screen. To enable keyboard jogging, parameter 170 must be set to “1”.





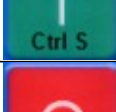

The status window in the upper right corner of the screen displays the jogging mode (continuous/incremental), incremental step size, and jog speed (fast/slow). In continuous mode, the jog keys start movement when pressed and movement stops when you release the key. In incremental mode, the axis will move the indicated incremental step amount.

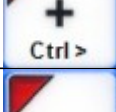
As shown in the picture above, the jog keys are located in the cursor key block to the right of the main keyboard and to the left of the numeric keypad. If a jog key controls an axis, it will be overlaid with the axis symbol (“X”, “Z”, etc.) The jog keys are the arrow keys, **Insert**, **Delete**, **Home**, **End**, **Page Up**, and **Page Down**.

The remaining keys are described below:

Legend	Key(s)	Function	Description	Availability (Notes)
	Alt S	Cycle Start	Same as Cycle Start.	Always, with few exceptions.
	Esc	Cycle Cancel	Same as Cycle Cancel.	During a job run; otherwise, Esc is used to exit menus.
	Space	Feed Hold	Turns Feed Hold on and off	Always, with few exceptions.
	Alt J	Start/Exit Panel	Invokes or exits the jog panel.	Always, with few exceptions.
	Ctrl F1 - Ctrl F12	Aux 1 – Aux 12	Executes the corresponding Aux function and signals the PLC. A custom PLC program is required to act upon jog panel signals.	Always, with few exceptions.

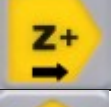
Legend	Key(s)	Function	Description	Availability (Notes)
	Ctrl M	Toggle Auto Coolant	Toggles coolant mode between auto and manual.	Always, with few exceptions.
	Ctrl N	Turns on/off Flood	Toggles Flood coolant if in manual mode	Always, with few exceptions.
	Ctrl K	Turns on/off Mist	Toggles Mist coolant if in manual mode	Always, with few exceptions.
Feedrate Override +	Ctrl +	Increase feedrate override	Increase feed rate override by 1% while held.	Jog panel, job run, graphing, and some other times
Feedrate Override -	Ctrl -	Decrease feedrate override	Decrease feed rate override by 1% while held.	Jog panel, job run, graphing, and some other times.
	Ctrl C	Selects CW Spin	Selects CW Spin dir in man mode	Always, with few exceptions.
	Ctrl W	Selects CW Spin	Selects CCW Spin dir in man mode	Always, with few exceptions.
	Ctrl A	Toggle Spindle Auto/Manual	Toggles between automatic and manual spindle operation.	Always, with few exceptions.
	Ctrl S	Spin Start	Starts spindle in selected direction if in manual mode	Always, with few exceptions.
	Ctrl Q	Spin Stop	STOPS spindle regardless of auto or manual mode.	Always, with few exceptions.
	Ctrl >	Spindle Override +1%	Increase the spindle override by 1% while held.	Always, with few exceptions.
	Ctrl <	Spindle Override -1%	Decrease the spindle override by 1% while held.	Always, with few exceptions.
	Ctrl T	Tool Check	Performs a tool check.	Always, with few exceptions.
	Ctrl I	Incremental/Continuous Jog Selection	Toggles incremental or continuous jog mode.	Available most times that jogging is available.

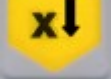
Legend	Key(s)	Function	Description	Availability (Notes)
	Ctrl F	Toggles Fast/Slow Jog mode	Toggles between Fast and Slow Jog mode	Always, with few exceptions.
	Ctrl B	Selects Single Block Mode	Selects single block mode	Always, with few exceptions.
	Delete	Decrease Jog increment	Decreases current jog increment to the next lower available increment	Always, with few exceptions.
	Insert	Increase Jog Increment	Increase current jog increment to the next higher available increment	Always, with few exceptions.
	Left arrow	Z - Jog		With on screen jog panel displayed
	Right Arrow	Z+ Jog		With on screen jog panel displayed
	Up Arrow	X+ Jog		With on screen jog panel displayed
	Down Arrow	X- Jog		With on screen jog panel displayed

MDI and the Keyboard Jog Panel

Many of the keys used by the keyboard jog panel are also possible commands to MDI. To use the keyboard jog panel functions in MDI, you must press **Alt J**. You may jog; use the handwheels, or any other jog panel function. Press **Alt J** or **Esc** to return to MDI.

Keyboard Shortcut Keys

A computer style keyboard is supplied with most systems. This keyboard can be used as a jog panel. The keyboard jog panel has many “hot keys”. Hot keys are keys that can be used at almost any time, with few exceptions. Some menus may prohibit their use. The CNC software has many other hot keys in addition to the jog panel hot keys. The hot keys are listed below.

Hot Keys

Hot Key	Action
Ctrl A	Spindle auto/manual
Ctrl N	Flood coolant on/off*
Ctrl M	Toggle Auto Man Coolant
ALT D	Switch between current position and machine position
CTRL D	Switch DRO between position and distance to go
CTRL K	Mist coolant on/off*
ALT F	Displays available system memory
ALT I	PLC diagnostics
ALT J	Enables keyboard jogging*
ALT K	Displays current ATC tool bin location



Hot Key	Action
ALT M	MDI
Ctrl T	Tool check*
ALT P	Live PID display
CTRL P	Clear max and min error display
Ctrl C	Spindle CW*
Ctrl W	Spindle CCW*
Ctrl S	Start Spindle*
Ctrl Q	Stop Spindle
ALT S	Cycle start
ALT T	Displays current motor temperature estimates
ALT V	Displays current software version #
ALT W	MPG on/off*
ALT + / ALT -	Selects next/previous WCS, cycles through WCS 1-18**
ALT 1 - ALT 0	Selects WCS 1 – WCS 10**
ALT Tab	Cycle through currently running applications
CTRL F1 - CTRL F12	Executes Aux function 1 – 12*
CTRL V	Enables/disables Stall detection in PID Configuration***
CTRL I	Creates plcstate.txt when PLC diagnostics is displayed***
CTRL E	Starts the PLC Debugger***

Notes: * This is a keyboard jog panel function.
 ** Not available during jobs or on jog panel.

Chapter 3

Main Screen

When the T-Series control is started, the first menu to appear is the Main Screen.

WCS #1 (G54)		Current Position (Inches)		Job Name: pawn.cnc					
X		+0.0000		Tool: T0808					
Z		+0.0000		Feedrate: 100% 0.0 ipm					
				Spindle: 0 A					
Dist to Go				304 MDI...					
X		+0.0000		307 Operator abort: job cancelled					
Z		+0.0000		301 Stopped					
				304 MDI...					
				307 Operator abort: job cancelled					
				301 Stopped					
				Press CYCLE START to start job					
Setup	Load	MDI	Run	CAM	Edit	Utility	Graph	Tool Wear	Shut Down
F1	F2	F3	F4	F5	F6	F7	F8	F9	F10

Option Descriptions

F1 - Setup

When you press **F1-Setup** from the Main Screen, you will be shown the Setup menu containing options related to setting up various aspects of the machine.

F1 – Part This key displays the Part Setup menus, which are explained in Chapter 5.

F2 – Tool This key displays the Tool Setup menus, which are explained in Chapter 4.

F3 – Config This key displays the Configuration menu, which is explained in Chapter 14.

F4 – Feed This key displays the Feed menu, which is discussed in Chapter 6.

F2 – Load Job

Job Name: c:\cnct\ncfiles\bracket.cnc

Use arrow keys to select file to load and press F10 to Accept.

arcs.cnc
bracket.cnc
flange.cnc
test fixture plate.cnc

Job to load? bracket.cnc

G code /ICN F1	USB/LAN F2	Details On/Off F3	Show Recent F4	Date/ Alpha F5	Edit F6	Help On/Off F7	Graph F8	Advanced F9	Accept F10
-----------------------------	----------------------	--------------------------------	-----------------------------	------------------------------	-------------------	-----------------------------	--------------------	-----------------------	----------------------

*Note: The path and/or file name may also be selected by typing the path or path and file name. A window will open automatically when you begin typing.

- F1 – G code** Allows the user to change which types of files are displayed.
- /ICN
- F2 – USB/LAN** Select a different drive from which to load files.
- F3 – Details** Displays file details including: Programmer, Description and Date Modified.
- F4 – Show** Displays a list of the 15 most recently loaded jobs.
- Recent
- F5 – Date/Alpha** Toggles the current view of files to be sorted alphabetically or by date modified.
- F6 – Edit** Opens selected file in editor.
- F7 - Help** Displays on screen help for the load screen.
- F8 - Graph** Back plots (graphs) the selected file.
- F9 - Advanced** Displays a unified file and device browser similar to Windows Explorer.
- Page Up** Move the cursor backward one page.
- Page Down** Move the cursor forward one page.
- END** Select the last file in the list.
- HOME** Select the first file in the list.
- Arrow Keys** Move the cursor in the selected direction.

F3 –MDI - MDI mode allows you to directly enter M and G-codes one line at a time. After entering the M and G-codes you wish to run, press cycle start to have the controller execute the command. When the command has finished executing the command, it will prompt you for another line. When you are finished entering commands, press ESC.

Examples:

Block? G50X0Z0 ; Set the current XZ position to 0,0

Block? M26 /Z ; Set the current Z position as Z home

F4 - Run

Press **F4-Run** to change the way your part program will run. See chapter 6 for more information concerning the run menu.

F5 - CAM

Choose **F5-CAM** from the Main Menu to enter Intercon (**Interactive Conversational**) software. When you exit Intercon software, you will return to the Control Main Screen. The posted Intercon program will be automatically loaded into CNC11.

X	Current Position (Inches)	Job Name : pawn.cnc
	+4.0000	Tool : T0700
Z	+2.0000	Feedrate : 100%
		Spindle : 0 M
		Stopped Waiting for PLC operation Stopped
		Press CYCLE START to start job
CAM Selection		
ICN - Intercon Lathe		
Manual - Operators Manual		
ICN F1	Manual F2	

F1- ICN Lathe Intercon conversational programming
F2- Manual Allows you to access the operator manual on the control

F6 - Edit

This key causes the control to load the current job into a text editor for viewing and/or editing.

When editing, care must be taken to save the file and to quit and exit the text editor before running the file (the current job). Modifying a file that is currently running as the current job is dangerous and will cause unexpected results. It is best practice to not edit any files while the machine is moving.



WARNING Editing a file (modifying and saving) **while the machine is moving** can cause personal injury or machine damage.

Also, note that the C:\CNCT directory contains configuration files and binary data. DO NOT edit these files. Doing so can cause loss of data and serious malfunctions.



WARNING Do not edit configuration data located in the C:\CNCT directory. Doing so can cause personal injury or machine damage.

F7 - Utility

From the utility menu you can view available software options, perform diagnostics, backup part and configuration files, create new directories and import or export files to and from external locations. **For further information please see chapter 7.**

F2 – Restore Report	Update your control's configuration with a <i>report.zip</i> file.
F3 – Backup Files	Backup your CNC and ICN files
F4 – Restore Files	Restore your CNC and ICN files
F5 – File Ops	Use this menu to perform file and directory operations.
F6 – User Maint	Perform user maintenance.
F7 – Create Report	Generates a backup of system configuration files called <i>report.zip</i> .
F8 – Options	Shows the software options that you have purchased or added to your control.
F9 – Logs	Shows the messages and errors that have been logged by the control.

F8 – Graph

In addition to the Main Screen, the Graph feature can be accessed from other menus like the Load Job Screen and the various Run Job menus. Use the Graph feature to show a tool path of the current program loaded. The following is a sample graph of a part:

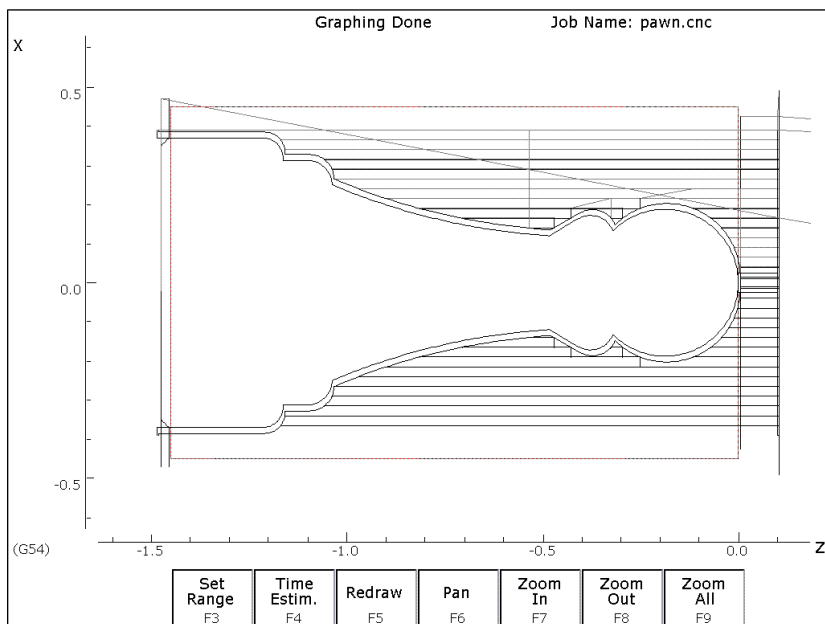

A wire frame tool path of your part should appear. Each axis is indicated by the X or Z marker, along with scales to indicate the current location of the part. Here is a list and the function of the F-Keys located on the bottom of the screen:

F3 - Set Range

Press this key to set the range of line numbers or block numbers to graph.

F4 - Time Estimation

Press this key to estimate the time needed to create the part. It takes into account accelerations and decelerations, but neglects tool change times.

F5 - Redraw

Press this key to redraw the graphics at any time.

F6 - Pan

Press this key to move the part around the graph. Once pressed, use the crosshatches to pick a location of the part that will pan to the center of the graph. Once a section is selected, press **F6-Pan** again to continue panning.

F7 - Zoom In

Press this key to zoom into the part relative to the center of the graph.

F8 - Zoom Out

Press this key to zoom away from the part relative to the center of the graph.

F9 - Zoom All

Press this key to view the entire part fit inside the graph.

*Note: Use the FEEDRATE OVERRIDE knob to control the speed of the graphing. To pause the tool path, turn the knob counter-clockwise until it stops. Turn the knob clockwise to resume drawing. On the offline demo software, the simulated FEEDRATE OVERRIDE knob is controlled by pressing either Ctrl + or Ctrl -.

F10 - Shutdown

Press **F10-Shutdown** to enter the Shutdown menu. This menu allows you to park the machine, poweroff the control, start a command window or exit CNC11.

F1 - Park

Press **F1-Park** to park the machine at the end of the day for quicker machine homing at startup. Once F1-Park is selected, The **Cycle Start** key must be press to start machine movement. The park feature homes each axis, at the maximum rate, to ¼ motor revolutions from its home position. The Z-axis is moved first, and then all the other axes are done.

F2 - Poweroff

Press **F2-Poweroff** to properly shutdown the control. With most controls, this action turns off the control once the system has prepared itself to be shutdown. Just like a desktop computer, the control should be properly shutdown before turning off the power in order to reduce the risk of corrupting data on the hard drive.

NOTE: This option will only turn off the control. The machine itself will still need to be manually turned off. Once the screen says Power Off it is safe to turn off the main disconnect.

F6 - System Prompt

This brings up the Windows command line interface. Type the command **exit** to exit the command window.

F9 - Exit CNC11

Press **F9-Exit CNC11** to exit CNC11 software.

Chapter 4

Tool Setup

Three menus are involved in tool setup:

- Tool Geometry Offset Library – specifies tool and offset definitions to be associated with each tool
- Tool Wear Adjustment Screen – allows operator to make tool wear adjustments for each tool
- Lathe Intercon’s Tool Library – Lathe Intercon’s version of the Tool Geometry Offset Library

Only the first two menus will be discussed in this chapter. See Chapter 8 for a description of Lathe Intercon’s Tool Library. For information on setting up tool offsets see the section “Procedures for Setting up Tools” later in this chapter.

Tool Geometry Offset Library

To get to this screen from the Main Screen, press **F1-Setup** ► **F2-Tool Offset**. On this screen, you can define the characteristics and offsets to be associated with each tool.

WCS #1 (G54) Current Position (Inches) Job Name: pawn.cnc

X  **+0.0000** Tool: T0000

Z **-0.2976** Feedrate: 6% 0.0 ipm

Spindle: 0 A

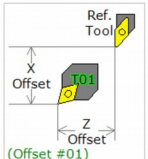
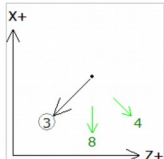
Tool Library

Off. #	Tool Loc	Tool Orient	Tool Type	Approach	X Offset	Z Offset	Nose Radius	Nose Vector	Spin Dir	Max Spin	Coolant	Description
01	T01	OD	Turn	Rear	-1.0113	-0.1260	0.0312	3	CW	500	Flood	turning tool
02	T02	OD	Turn	Rear	-1.0765	-3.4310	0.0312	4	CW	600	Mist	
03	T03	OD	Groove	Rear	-0.4656	-0.8823	0.0150	3	CW	700	Flood	Grooving tool
04	T04	OD	Thread	Rear	0.1568	0.0030	0.0000	8	CW	800	Flood	Threading tool
05	T05	OD	Cutoff	Rear	0.0125	0.7520	0.0312	3	CW	0	Flood	Cut off tool
06	T06	OD	Turn	Rear	0.0000	0.0000	0.0000	2	CW	0	Flood	
07	T07	OD	Turn	Rear	0.0000	0.0000	0.0000	2	CW	0	Flood	
08	T08	OD	Turn	Rear	0.0000	0.0000	0.0000	3	CW	0	Flood	
09	T09	OD	Turn	Rear	0.0000	0.0000	0.0000	0	CW	0	Off	
10	T10	OD	Turn	Rear	0.0000	0.0000	0.0000	0	CW	0	Off	

X Diam: 2.3000 Z Ref: 3.0000 Entry mode: absolute

Measure Tool
F2

Abs Inc
F4

Tool Wear
F9

Save
F10

Offset # (Tool Offset): This non-editable field serves as the row number reference into the Tool Library. In a CNC program, the number contained in the rightmost 2 digits of the T command is used to activate a Tool Offset (for example **T0102** activates Tool Offset #02). Activating a Tool Offset simply means that the tool offset data values (such as X and Z Offsets, Nose Radius, and Nose Vector) on that row become the active modals until the next T command.

Tool Loc (Tool Number): This is the Tool Number (01-99) that is associated with the Tool Offset. Normally, a single Tool Offset is associated with a single tool, but if a single tool is used in multiple ways, then it is possible for multiple Tool Offsets to be associated with that tool. To associate multiple Tool Offsets to a single tool, enter the same Tool Number on multiple rows.

Tool Orient: This is the tool operation direction, which generally describes the direction in which the tool points. It also implies the orientation of the work surface. Choices here are OD (outer diameter), ID (inner diameter), FFace (front face), and RFace (rear face).

Tool Type: This field describes the tool’s general shape and intended operation. Use “Custom” if the tool does not match any of the available tool types.

Approach (from): This field is the tool approach direction. This indicates which side of work piece centerline the tool must travel *from* in order to start operation on the work piece. For gang tool lathes (parameter 163=1), the approach direction is independently set for each tool. For non-gang tool lathes, this field is locked to the same approach direction for every tool and cannot be modified, and such an approach direction is based on the lathe’s overall machine orientation (as set in parameter 1).

X Offset: This field defines the X offset distance away from the established tool measurement radius or diameter. (See X Diam/Radius as described below.)

Z Offset: This field defines the Z offset distance away from the Z reference position. (See Z Ref as described below.)

Nose Radius: This field tells the control the distance to adjust when cutter diameter compensation (G41 or G42) is activated.

Nose Vector: This field tells the control how the tool is oriented in the machine. See the section titled “Setting the Nose Vector” later in this chapter for a more in-depth explanation.

Spin Dir (Spindle Direction): This is spindle direction for the tool. Toggle between off, clockwise, and counterclockwise.

Max Spin (Max. Spindle Speed (G50)): The maximum spindle speed for the tool. A G50 is posted with the tool change using this value as the S parameter. If the value is zero, the G50 value from the Setup screen is used.

Coolant: Specify the coolant for each tool. Toggle between off, flood and mist

Description: This field contains the user-entered text description of the tool. This field is not essential for machine operation.

X Diam/Radius: This field defines the diameter or radius from which the X offsets of tools are to be measured. This diameter is usually created by a skim cut as part of the tool measuring procedure. (See the Procedures for Setting Tool Offsets section later in this chapter.) To set the X diameter field, cursor over to the X offset column and press **F1 – X Diam.** and follow the instructions.

Z Ref: This field is the Z reference position from which the Z offsets of tools are to be measured. To set the Z reference field, cursor over to the Z offset column and press **F1 – Z Ref.** and follow the instructions.

Entry Mode: You can toggle between absolute input and incremental input using the **F4-Abs/Inc** key. The Entry Mode affects values entered in the X offset, Z offset, Nose Radius, X Diam/Radius, and Z Ref fields. If the Entry Mode is Incremental, then the value that you enter will be **added** to currently affected field. If the Entry Mode is Absolute, then the value that you enter will change the field to that value.

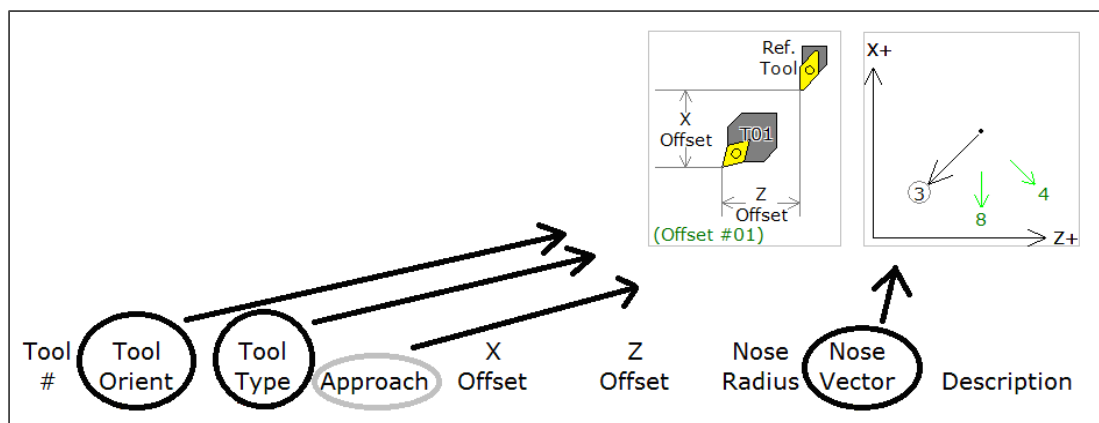

The settings for **Tool Orient**, **Tool Type**, and **Approach** contribute to the appearance of the help diagrams on the upper right side of the screen. This will help you select a proper **Nose Vector** for the tool.

F1 – X Diam/Rad or Z Ref

Press this key to establish the X Radius or Diameter for Tool measurement or to establish the Z reference. To establish the X Radius or Diameter, move the cursor to the X Offset column and press this key and then follow the

instructions. To establish the Z reference, move the cursor to the Z offset column and press this key and then follow the instructions.

If Auto Tool Measure (extra-cost option) is set up and enabled, you can establish the X Radius/Diameter and/or the Z reference with a tool touch-off device. When you press this key (after moving the cursor to the proper X or Z offset column) you will be prompted for a choice to do this either automatically with a or manually. On this prompt, choose F1-Auto if you want to do this automatically with a tool touch-off device.

F2 – Measure Tool

Press this key to access a sub-menu for making X and/or Z offset measurements of a tool.

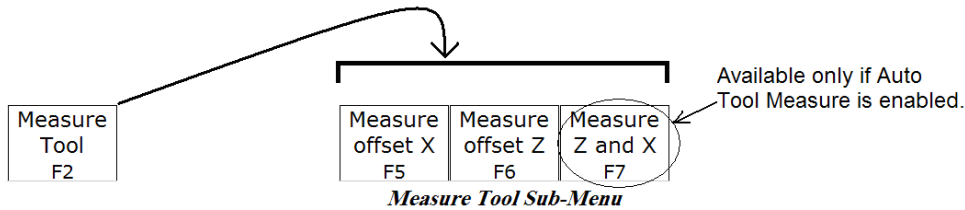

The sub-menu choices will behave slightly differently depending on whether or not Auto Tool Measure (extra-cost option) is set up and enabled. This sub-menu is used in the tool measuring procedures later in this chapter.

Sub-Menu key	Auto Tool Measure <u>not</u> enabled	Auto Tool Measure enabled
F5	Manually measure X offset using current X position.	Prompt with a choice to do either Manual measure of X offset or Auto Tool Touch-off cycle.
F6	Manually measure Z offset using current Z position.	Prompt with a choice to do either Manual measure of Z offset or Auto Tool Touch-off cycle.
F7	<i>(this choice will not show up)</i>	Do Auto Tool Touch-off cycle starting with Z and then X.

F3 – ATC (Automatic Tool Change)

If you have an automatic tool changer installed, you can press this key to change tools.

F4 – Abs/Inc

This toggles the Entry Mode between Absolute and Incremental. (See “Entry Mode” as described above.)

F5, F6, F7, F8 – Increment/Decrement by small amount

To make small incremental adjustments to an X offset, Z offset, or Nose Radius value, use the arrow keys to select the value to be adjusted and press one of these keys. A small amount (as stated on the key’s label) will be added to or subtracted from the affected field.

F9 – Tool Wear

This is an alternate way to get to the Tool Wear Adjustment screen (see next section).

F10 – Save

When you are done with modifications, press this key to save the changes.

Tool Wear Adjustment Screen

To get to this screen from the Main Screen, press **F9-Tool Wear**. This screen allows you to make tool wear adjustments for each tool. Adjustment values entered here will be **added** to the corresponding fields in the Tool Geometry Offset Library to obtain the final offset value to be used by the control during a job run.

WCS #1 (G54)		Current Position (Inches)		Job Name: pawn.cnc				
X		+0.0000		Tool: T0000				
Z		-0.0046		Feedrate: 111% 0.0 ipm				
				Spindle: 0 A				
				Stopped 335 Emergency stop released Stopped				
Tool Wear Adjustment								
Tool	X	Z	(Description)					
T01	0.0000	0.0000	Tool1 description					
T02	0.0000	0.0000	Tool2 description					
T03	0.0000	0.0000	...etc...					
T04	0.0000	0.0000						
T05	0.0000	0.0000						
T06	0.0000	0.0000						
T07	0.0000	0.0000						
T08	0.0000	0.0000						
T09	0.0000	0.0000						
T10	0.0000	0.0000						
Entry mode: absolute								
Clear All F1	Tool Offset F2	ATC F3	Abs Inc F4	+ .001 F5	- .001 F6	+ .0001 F7	- .0001 F8	Save F10

Tool (Offset #): This is the **offset** number. Although this number *usually* corresponds to a tool number and is prefixed with a “T”, this is **not** always a tool number. However, if you only associate tool numbers with the same numbered offset, and then this field would correspond to the tool number. This field is just a display label and cannot be modified.

X: This is the distance adjustment for the corresponding X Offset field in the Tool Geometry Offset Library.

Z: This is the distance adjustment for the corresponding Z Offset field in the Tool Geometry Offset Library.

(Description): This field is displayed on this screen for your convenience. It cannot be modified here. To modify this field, press **F2 – Tool Offset** to go to Tool Geometry Offset Library (described in the previous section) or go into Lathe Intercon’s Tool Library (see Chapter 8).

Entry Mode: You can toggle between absolute input and incremental input using the **F4-Abs/Inc** key. The Entry Mode affects values entered in the X and Z adjustment fields. If the Entry Mode is Incremental, then the value that you enter will be **added** to current value in that field. If the Entry Mode is Absolute, then the value that you enter will be the value entered in that field.

F1 – Clear All

This key will set all X and Z adjustment values in all rows of this menu to 0.

F2 – Tool Offset

This is an alternate way to get to the Tool Geometry Offset Library (described in the previous section).

F3 – ATC (Automatic Tool Change)

If you have an automatic tool changer installed, you can press this key to change tools.

F4 – Abs/Inc

This toggles the Entry Mode between Absolute and Incremental.

F5, F6, F7, F8 – Increment/Decrement by small amount

To make small incremental adjustments to the X and Z adjustment fields, use the arrow keys to select the value to be adjusted and press one of these keys. A small amount (as stated on the key's label) will be added to or subtracted from the affected field.

F10 – Save

When you are done with modifications, press this key to save the changes.

Procedures for Setting up Tools: Introduction

Follow these five steps to successful CNC turning:

1. Determine the tools necessary to machine the part by analyzing the print.
2. Setup the tool geometry characteristics and the offsets for each tool. (**This Chapter**)
3. Program the part using Intercon. (Chapter 8, Lathe Intercon Manual)
4. Set the X and Z Part Zero positions on the stock to be machined. (Chapter 5)
5. Graph the part to check for programming errors, and machine the part.

Tool offsets let the control know the difference in position for each tool being used. Since different tools are at different positions, each tool will have its own specific offset value in X and Z. For a multi-tool job, it is critical that the X and Z offsets for each tool are set at the proper values.

We will use the control to determine the difference in location of each tool by simply defining a position from which to measure each individual tool. If you have a tool touch-off device you can use the auto tool measure feature (see end of this chapter). But, if you do not have a tool touch-off device, the easiest method is to make a skim cut and then touch each tool off of the newly measured skim cut diameter. The control will record the distance that each tool had to move to touch off the known diameter. Once the X and Z offset information is known for each tool, a multi-tool program can be run with success.

Before doing the procedures in the ensuing sections, make sure:

1. The “Entry Mode” field in the Tool Geometry Offset Library is toggled to “absolute”.
2. The control is in Diameter mode (set Machine Parameter 55 to 0)
3. The adjustment values in the Tool Wear Adjustment Screen (described earlier in this chapter) are all zeroed out for the tools, which will be involved in the measurement process.

Setting up Tool Orientation, Tool Type, and Approach

STEP 1: Open the Tool Geometry Offset Library

On the T-Series Control Main Screen, press: **F1-Setup ► F2-Tool Offset**.
Move cursor to the row of the tool you want to set up.

STEP 2: Set the Tool Orientation:

Move cursor to the Tool Orient column. Choices here are:

- OD (outer diameter) – Tool is designated to work on outside surfaces; tool is facing toward centerline
- ID (inner diameter) – Tool is designated to work on internal surfaces; tool is facing away from centerline
- FFace (front face) – Tool is designated to work on front-facing surfaces, tool is facing Z-
- RFace (rear face) – Tool is designated to work on rear-facing surfaces, tool is facing Z+

Because the choice of Tool Orientation limits the choices available in the Tool Type field (in Step 3), Tool Orientation should be set **before** the Tool Type.

STEP 3: Set the Tool Type:

Move cursor to the Tool Type column. Choices here are:

- OD tool types: Turning, Grooving, Threading, Cutoff
- ID tool types: Turning, Grooving, Threading, Drill, Tap, Bore, Ream
- Front Face tool types: Turning, Grooving, Drill, Tap, Bore, Ream
- Rear Face tool types: Turning, Grooving

Choose 'Custom' if the tool is not any of the main ones listed.

STEP 4: Set Approach (for Gang Tool lathes only):

Choose the tool's Approach direction, which is the side of the work piece the tool needs to approach *from* in order to start operation on the work piece. If your machine is not a gang tool lathe, then skip this step.

- For a horizontal gang tool lathe, the choice is either Front or Back.
- For a vertical gang tool lathe, the choice is either Left or Right.

Observe the effect on the help diagrams:

Step 2: Tool Orient = OD
Step 3: Tool Type = Turn
Step 4: Approach = Rear

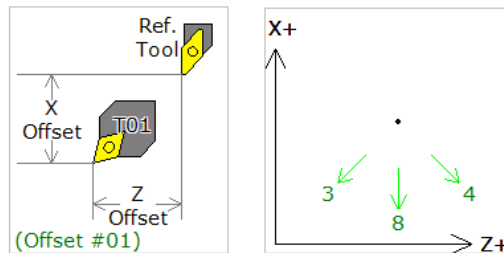

As you toggle through the choices of these fields, you will notice that the help diagrams in the upper right part of the screen dynamically change according to your choices. The left help diagram shows the tool's general shape and orientation, as well as its relationship to the reference tool (which is the "Tool used for Measurement" mentioned later in this chapter). The right help diagram shows the suggested possible tool nose vectors for the choices made in Steps 2, 3 and 4.

Setting up the Nose Vector

Entering the Nose Vector for your tool will tell the control how that tool is oriented in the machine. This is needed for calculating cutter compensation and for determining how to retract the tool during cutting cycles.

- NOTE: It would be beneficial to have the Tool Orient, Tool Type, and Approach fields already set up for the tools involved before setting the nose vector.

Move the cursor to the row of the tool you want to set up, and then move the cursor to the Nose Vector column. Select numbers 1 through 8. You can use the help diagram on the upper right side of the screen to help you to determine the proper nose vector number. The suggested possible nose vector numbers are determined by the Tool Orientation, Tool Type, and Approach.

If you choose the one of the suggested nose vector numbers, the number on the diagram will be circled like this:

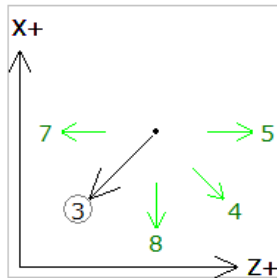

However, if you enter a nose vector number that is not suggested, it will appear crossed out like this:

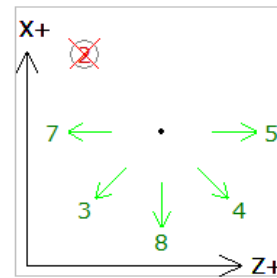

Note that the diagram's suggestions may not cover all cases. Therefore, the user interface of the Tool Geometry Offset Library will allow you to enter a nose vector number that is not suggested by the diagram.

For further information on how the nose vector is used during Cutter Compensation, see G40, G41, G42 in Chapter 11.

Manual Measurement of X-Axis Tool Offsets for OD Tools

- NOTE: Before you begin, the adjustment values in the Tool Wear Adjustment Screen (described earlier in this chapter) should be all zeroed out for the tools which will be involved in the steps below.
- NOTE: Also it would be beneficial to have the Tool Orient, Tool Type, Approach and Nose Vector fields already set up for the tools involved.

STEP 1:

Chuck up a piece of stock, and use the Jog buttons to make a skim cut (Figure 1). Leave the tool set at this X position.

- NOTE: Start spindle by switching to manual mode, press **Spin Start** button, and adjust RPM with the spindle override knob.

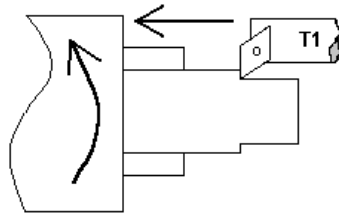

Figure 1

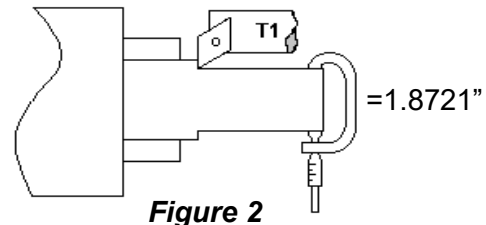

Figure 2

STEP 2:

Measure the new skim cut diameter, as shown in Figure 2.

STEP 3: Open the Tool Geometry Offset Library

On the T-Series Control Main Screen, press: **F1-Setup** ► **F2-Tool Offset**.

STEP 4: Set the X Measurement Diameter

Move the cursor to the X Offset column and press **F1-X Diam** and enter the diameter measured in Step 2 into the "Establish the X Diameter field", then press **F10-Save** to accept. The X-Measurement Diameter for OD tools is now set.

WCS #1 (G54) Current Position (Inches) Job Name: pawn.cnc
 X $+0.0000$ Tool: T0000
 Z -0.2976 Feedrate: 6% 0.0 ipm
 Spindle: 0 A

Establish the X Diameter for Tool Measurement

- 1) Load the tool to be measured
- 2) Enter the X Diameter
- 3) Press F10 to save value

--> 1.8721

Off. #	Tool Loc	Tool Orient	Tool Type	Approach	X	Z	R	Use	Spin	Motor Dir	Description	
01	T01	OD	Custom	Rear						3	CW	custom
02	T02	OD	Custom	Rear						2	CW	custom
03	T03	OD	Groove	Rear						3	CW	groove
04	T04	FFace	Bore	Rear	2.0000	0.3000	0.0500			3	CW	boring tool
05	T05	FFace	Drill	Rear	2.1306	0.4000	0.0500			7	CW	drill
06	T06	OD	Cutoff	Rear	2.1306	-0.3000	0.0000			8	CW	this is tool 6
07	T07	ID	Tap	Rear	4.1306	0.1000	0.0000			8	CW	tool 7
08	T08	ID	Ream	Rear	2.9985	-0.2652	0.0000			3	CW	reamer
09	T09	ID	Custom	Rear	0.0000	0.0000	0.0000			0	CW	custom tool
10	T10	OD	Custom	Rear	0.0000	0.0000	0.0000			0	CW	

X Diam: 0.9999
 Z Ref: -0.2976

Entry mode: absolute

X Diam	Measure Tool	Abs Inc	+ .001	-.001	+ .0001	-.0001	Tool Wear	Save
F1	F2	F4	F5	F6	F7	F8	F9	F10

Figure 3

STEP 5: Measure the X-Offset

Press **F2-Measure Tool** then **F5-Measure Offset X** to measure the X-offset of the tool used to make the skim cut. The value appears in the X Offset field.

WCS #1 (G54) Current Position (Inches) Job Name: g75test.cnc
 X ± 0.0000 Tool: T0000
 Z -0.2976 Feedrate: 70% 0.0 ipm
 Spindle: 0 A

Ref. Tool
 X Offset
 Z Offset (Offset #03)

X+
 3
 8
 4
 Z+

Tool Library

Off. #	Tool Loc	Tool Orient	Tool Type	Approach	X Offset	Z Offset	Nose Radius	Nose Vector	Spin Dir	Description
01	T01	OD	Custom	Rear	1.0000	2.0000	0.2000	3	CW	custom
02	T02	OD	Custom	Rear	0.1000	0.1000	0.0500	2	CW	custom
03	T03	OD	Turn	Rear	0.0000	0.0000	0.0500	3	CW	groove
04	T04	ID	Bore	Rear	0.0000	0.0000	0.0500	2	CW	boring tool
05	T05	FFace	Drill	Rear	0.0000	0.0000	0.0500	7	CW	drill
06	T06	OD	Cutoff	Rear	0.0000	0.0000	0.0000	8	CW	this is tool 6
07	T07	ID	Tap	Rear	0.0000	0.0000	0.0000	8	CW	tool 7
08	T08	ID	Ream	Rear	0.0000	0.0000	0.0000	3	CW	reamer
09	T09	ID	Custom	Rear	0.0000	0.0000	0.0000	0	CW	custom tool
10	T10	OD	Custom	Rear	0.0000	0.0000	0.0000	0	CW	

X Diam: 1.8721
 Z Ref: -0.2976

Entry mode: absolute

X Diam	Measure Tool	Abs Inc	+ .001	- .001	+ .0001	- .0001	Tool Wear	Save
F1	F2	F4	F5	F6	F7	F8	F9	F10

Measure offset X
 F5

Figure 4

NOTES:

- Always make sure the cursor is on the correct Offset #.
- Press **F5-Measure Offset X** while the tool is **STILL** at the skim cut diameter.
- Any piece of stock can be used to set tool offsets. It is not necessary to use the actual part blank.

STEP 6: Measure the Next Tool

Touch the next tool to the new skim cut OD (the X Measurement Diameter) as shown in Figure 5, and press **F2-Measure Tool** then **F5-Measure Offset X**. Repeat this step for the rest of your OD tools.

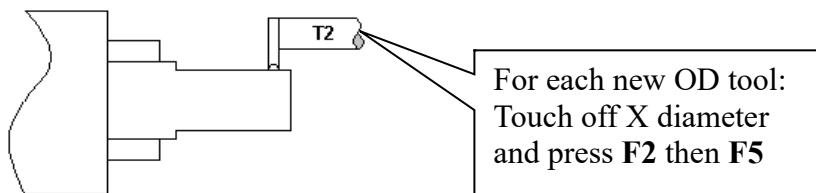

Figure 5

NOTES:

- Verify you are clear of any obstacles, then use “Tool Check” to withdraw the tool from its current position.
- Use a piece of paper to touch off the next tool to the skim cut diameter. Slow jog close to the work piece, switch to Incremental jog mode and jog in close at small increments until the tool just pins the paper to the work piece.
- If you are using an ATC, be sure that you are clear of any obstacles, then use the ATC button in the Tool Library to rotate the ATC to the next tool position.

Manual Measurement of X-axis Tool Offsets for ID Tools

After setting all OD Tool Offsets, a new Internal X Measurement Diameter should be set to measure the X offsets for all ID Tools.

- **NOTE:** Before you begin, the adjustment values in the Tool Wear Adjustment Screen (described earlier in this chapter) should be all zeroed out for the tools which will be involved in the steps below.
- **NOTE:** Also it would be beneficial to have the Tool Orient, Tool Type, Approach and Nose Vector fields already set up for the tools involved.

STEP 1:

Chuck up a piece of stock, and use the Jog buttons to make a skim cut (Figure 6). Leave the tool set at this X position.

- **NOTE:** Start spindle by switching to manual mode, press **Spin Start** button, and adjust RPM with the spindle override knob.

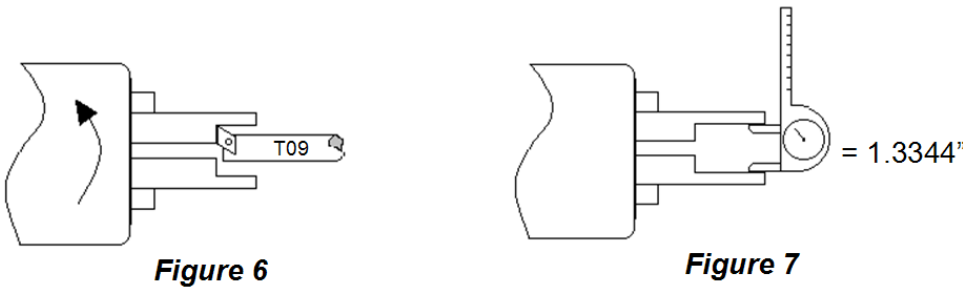

STEP 2:

Measure the new skim cut diameter, as shown in Figure 7.

STEP 3: Open the Tool Geometry Offset Library

On the T-Series Control Main Screen, press: **F1-Setup** ► **F2-Tool Offset**.

STEP 4: Set the X Measurement Diameter

Move the cursor to the X Offset column and press **F1 - X Diam**, enter the diameter measured in Step 2 into the Establish the X Diameter field, and press **F10 - Save** to accept. The X-Measurement Diameter for ID tools is now set.

WCS #1 (G54)
Current Position (Inches)
Job Name: g75test.cnc

X

+0.0000

Z

-0.2976

X Offset Ref. Tool: 6

Establish the X Diameter for Tool Measurement

1) Load the tool to be measured

2) Enter the X Diameter

3) Press F10 to save value

--> 1.3344

Off. #	Tool Loc	Tool Orient	Tool Type	Tool Approach	Measure offset X	Measure offset Z	Measure Z and X	Tool Spin	Description
01	T01	OD	Custom	Rear				3	CW custom
02	T02	OD	Custom	Rear				2	CW custom
03	T03	OD	Turn	Rear				3	CW groove
04	T04	ID	Bore	Rear				2	CW boring tool
05	T05	FFace	Drill	Rear	0.0000	0.0000	0.0500	7	CW drill
06	T06	OD	Cutoff	Rear	0.0000	0.0000	0.0000	8	CW this is tool 6
07	T07	ID	Tap	Rear	0.0000	0.0000	0.0000	8	CW tool 7
08	T08	ID	Ream	Rear	0.0000	0.0000	0.0000	3	CW reamer
09	T09	ID	Custom	Rear	0.0000	0.0000	0.0000	2	CW custom tool
10	T10	OD	Custom	Rear	0.0000	0.0000	0.0000	0	CW

X Diam: 0.0000
Z Ref: -0.2976

Entry mode: absolute

X Diam F1	Abs Inc F4	Measure offset X F5	Measure offset Z F6	Measure Z and X F7	Tool Wear F9	Save F10
--------------	---------------	------------------------	------------------------	-----------------------	-----------------	-------------

Figure 8

STEP 5: Measure the X-Offset

Press **F2-Measure Tool** then **F5-Measure Offset X** to measure the X-offset of the tool used to make the skim cut. The measured value will appear in the X Offset field.

WCS #1 (G54) Current Position (Inches) Job Name: g75test.cnc
 X \leftrightarrow +0.0000 Tool: T0000
 Z -0.2976 Feedrate: 70% 0.0 ipm
 Spindle: 0 A

Tool Library

Off. #	Tool Loc	Tool Orient	Tool Type	Approach	X Offset	Z Offset	Nose Radius	Nose Vector	Spin Dir	Description
01	T01	OD	Custom	Rear	1.0000	2.0000	0.2000	3	CW	custom
02	T02	OD	Custom	Rear	0.1000	0.1000	0.0500	2	CW	custom
03	T03	OD	Turn	Rear	0.0000	0.0000	0.0500	3	CW	groove
04	T04	ID	Bore	Rear	0.0000	0.0000	0.0500	2	CW	boring tool
05	T05	FFace	Drill	Rear	0.0000	0.0000	0.0500	7	CW	drill
06	T06	OD	Cutoff	Rear	0.0000	0.0000	0.0000	8	CW	this is tool 6
07	T07	ID	Tap	Rear	0.0000	0.0000	0.0000	8	CW	tool 7
08	T08	ID	Ream	Rear	0.0000	0.0000	0.0000	3	CW	reamer
09	T09	ID	Custom	Rear	0.0000	0.0000	0.0000	2	CW	custom tool
10	T10	OD	Custom	Rear	0.0000	0.0000	0.0000	0	CW	

X Diam: 1.3344
 Z Ref: -0.2976

Entry mode: absolute

X Diam F1	Measure Tool F2	Abs Inc F4	+.001 F5	-.001 F6	+.0001 F7	-.0001 F8	Tool Wear F9	Save F10
--------------	--------------------	---------------	-------------	-------------	--------------	--------------	-----------------	-------------

Figure 9

NOTES:

- Verify that the cursor is highlighting the X offset field for the offset number that you are measuring.
- Press **F5-Measure Offset X** while the tool is STILL at the skim cut diameter.

STEP 6: Measure the Next Tool

Touch off all internal tools on this new internal diameter and press **F2-Measure Tool** then **F5-Measure Offset X** to measure each one. Repeat this step for all the remaining ID tools (Figure 10).

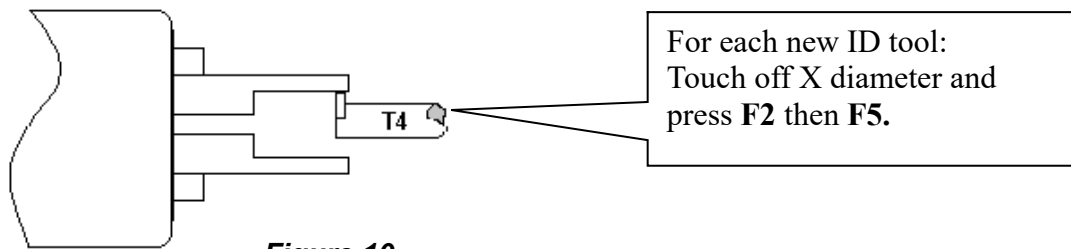

Figure 10

NOTES:

- Make sure you are clear of any obstacles, then use “Tool Check” to withdraw a tool from its current position.
- Use a piece of paper to touch off the next tool to the skim cut diameter. Slow jog close to the work piece, switch to **Incremental jog** mode and jog in close at small increments until the tool just pins the paper to the work piece.
- If you are using an ATC, move the ATC away from any obstacles, then use the ATC button in the Tool Library to index to the next tool position.

Special Cases: Sometimes it might be difficult to touch a new tool off the X Measurement Diameter set in Step 2. If this is the case, you can repeat each step from Step #1 through 5 for EACH tool, reading in a new reference position for EACH tool! In this case, you will make a new skim cut Measurement Diameter for each tool and enter in that new skim cut diameter as a new reference position for that tool. This method is more work, but if touching off a new tool to an existing reference position is very difficult, this method may be used for both OD & ID tools.

Manual Measurement of X-Axis Offsets for Drills, Center Drills, and Taps

To set drills, center drills, taps, and boring tools, sweep the tool in with an indicator to find the spindle center. Remember that the X Measurement Diameter should be set to ' 0 ' before proceeding with step 1. (See the section "Setting X-Axis Tool Offsets for OD Tools" earlier in this chapter for directions on setting an X Measurement Diameter)

- NOTE: Before you begin, the adjustment values in the Tool Wear Adjustment Screen (described earlier in this chapter) should be all zeroed out for the tools which will be involved in the steps below.
- NOTE: Also it would be beneficial to have the Tool Orient, Tool Type, Approach, and Nose Vector fields already set up for the tools involved.

STEP 1: Set the Indicator

Mount the indicator base on the spindle or put the indicator in the chuck. Move the tool towards the approximate center of the spindle. (Figure 11)

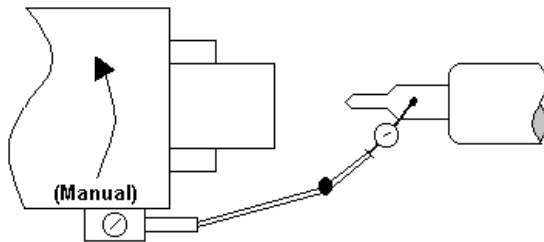

Figure 11

STEP 2: Center the Drill

Touch the indicator probe to the shank of the tool, and rotate the chuck by hand. Jog the X-axis in incremental mode until the indicator reads the same around the circumference of the tool.

STEP 3: Measure the X Offset

Press **F2-Measure Tool** then **F5-Measure Offset X** to measure the X-offset of the tool. The value appears in the X Offset field.

- NOTE: This procedure may also be used in setting ID tool offsets in cases where an initial ID skim cut is not possible.

Manual Measurement of X-Axis Offsets for Boring Tools

Since boring tools come with a manufactured offset, setting a boring tool is just like setting a drill, with a few added steps. Follow Steps 1 to 3 in the previous section above, and then do the following steps:

- NOTE: Before you begin, the adjustment values in the Tool Wear Adjustment Screen (described earlier in this chapter) should be all zeroed out for the tools which will be involved in the steps below.
- NOTE: Also it would be beneficial to have the Tool Orient, Tool Type, and Approach fields already set up for the tools involved.

STEP 4: Find the Tool Offset

Look up the tool manufacturer's offset for the tool being measured.

STEP 5: Switch to Incremental mode

With the X Offset field highlighted for the tool being measured, press the **F4 - Abs/Inc** key until the "Entry Mode:" field on the screen reads "incremental".

STEP 6: Enter the Given Offset

Multiply the manufacturer's offset by negative two (-2), and type the number into the X Offset field. The value you type should appear as being added to the measured X offset already measured.

- NOTE: Remember to press the **F4 - Abs/Inc** key to toggle the Entry Mode back to "absolute" when you are done.

Manual Measurement of Z-Axis Tool Offsets

- NOTE: Before you begin, the adjustment values in the Tool Wear Adjustment Screen (described earlier in this chapter) should be all zeroed out for the tools which will be involved in the steps below.
- NOTE: Also it would be beneficial to have the Tool Orient, Tool Type, Approach, and Nose Vector fields already set up for the tools involved.

STEP 1:

Chuck up a piece of stock, and use the Jog buttons to make a skim cut (Figure 12) OR if the surface is true, touch off the end as shown in Figure 13.

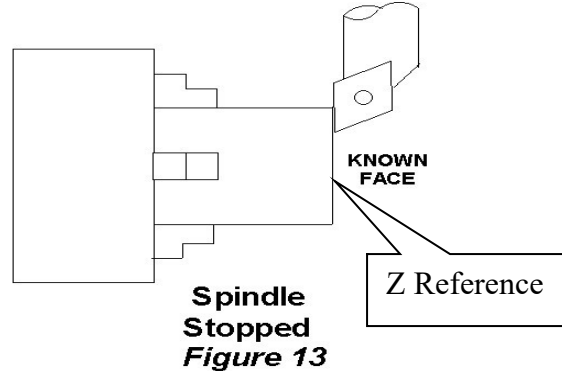
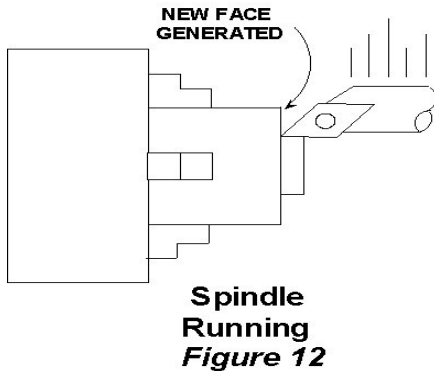

STEP 2: Open the Tool Geometry Offset Library

On the T-Series Control Main Screen, press: **F1-Setup ► F2-Tool Offset**.

STEP 3: Set the Reference:

Make sure the Z column is highlighted, press **F1 - Z Ref.** and then **F10 - Save** to accept this as the reference.

STEP 4: Measure the Tool Offset

Without moving the Z-position of the tool that you just used to set a reference point, press **F2-Measure Tool** then **F6-Measure Offset Z** to measure the Z-offset of that tool (it should result in 0 as its offset), as seen in figure 14.

WCS #1 (G54) Current Position (Inches) Job Name: g75test.cnc
 X  +0.0000 Tool: T000
 Z -0.2976 Feedrate: 70% 0.0 ipm
 Spindle: 0 A

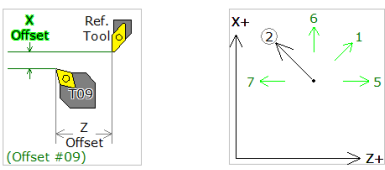

Tool Library

Off. #	Tool Loc	Tool Orient	Tool Type	Approach	X Offset	Z Offset	Nose Radius	Nose Vector	Spin Dir	Description
01	T01	OD	Custom	Rear	1.0000	2.0000	0.2000	3	CW	custom
02	T02	OD	Custom	Rear	0.1000	0.1000	0.0500	2	CW	custom
03	T03	OD	Turn	Rear	0.0000	0.0000	0.0500	3	CW	groove
04	T04	ID	Bore	Rear	0.0000	0.0000	0.0500	2	CW	boring tool
05	T05	FFace	Drill	Rear	0.0000	0.0000	0.0500	7	CW	drill
06	T06	OD	Cutoff	Rear	0.0000	0.0000	0.0000	8	CW	this is tool 6
07	T07	ID	Tap	Rear	0.0000	0.0000	0.0000	8	CW	tool 7
08	T08	ID	Ream	Rear	0.0000	0.0000	0.0000	3	CW	reamer
09	T09	ID	Custom	Rear	0.0000	0.0000	0.0000	2	CW	custom tool
10	T10	OD	Custom	Rear	0.0000	0.0000	0.0000	0	CW	

X Diam: 1.3344
 Z Ref: -0.2976
 Entry mode: absolute

X Diam F1	Measure Tool F2	Abs Inc F4	+ .001 F5	- .001 F6	+ .0001 F7	- .0001 F8	Tool Wear F9	Save F10
--------------	--------------------	---------------	--------------	--------------	---------------	---------------	-----------------	-------------

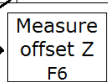

Figure 14

STEP 5: Measure the Next Tool Z-Offset

Load the next tool and bring it to the reference point (as shown in Figure 13). Press **F2-Measure Tool** then **F6-Measure Offset Z**, and then repeat for all remaining tools.

- NOTE: Make sure the cursor is on the correct Offset number being measured before pressing **F2-Measure Tool** then **F6-Measure Offset Z**.

Manual Measurement of Part Cutoff Tool Z-Offset

- NOTE: Before you begin, the adjustment values in the Tool Wear Adjustment Screen (described earlier in this chapter) should be zeroed out for the tools that will be involved in the setup as described below.
- NOTE: Also it would be beneficial to have the Tool Orient, Tool Type, Approach, and Nose Vector fields already set up for the tools involved.

Load the part cutoff tool and bring it to the stock face (Figure 15). With the menu highlighted in the Z Offset column at the correct offset number, press the **F2-Measure Tool** then **F6-Measure Offset Z** key.

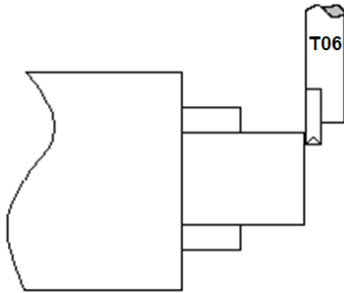
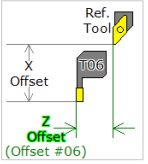
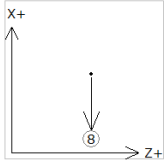

Figure 15

If the part cutoff tool is 0.125 wide and you want the back side of the tool to be set at Z-Zero, then highlight the Z-offset of the tool being adjusted and press the **F4 - Abs/Inc** key to toggle to incremental mode.

WCS #1 (G54) Current Position (Inches) Job Name: g75test.cnc
 Tool: T0000
 Feedrate: 70% 0.0 ipm
 Spindle: 0 A

X +0.0000
Z -0.2976

Tool Library

Off. #	Tool Loc	Tool Orient	Tool Type	Approach	X Offset	Z Offset	Nose Radius	Nose Vector	Spin Dir	Description
01	T01	OD	Custom	Rear	1.0000	2.0000	0.2000	3	CW	custom
02	T02	OD	Custom	Rear	0.1000	0.1000	0.0500	2	CW	custom
03	T03	OD	Turn	Rear	0.0000	0.0000	0.0500	3	CW	groove
04	T04	ID	Bore	Rear	0.0000	0.0000	0.0500	2	CW	boring tool
05	T05	FFace	Drill	Rear	0.0000	0.0000	0.0500	7	CW	drill
06	T06	OD	Cutoff	Rear	1.3000	-0.125	0.0000	8	CW	this is tool 6
07	T07	ID	Tap	Rear	0.0000	0.0000	0.0000	8	CW	tool 7
08	T08	ID	Ream	Rear	0.0000	0.0000	0.0000	3	CW	reamer
09	T09	ID	Custom	Rear	0.0000	0.0000	0.0000	2	CW	custom tool
10	T10	OD	Custom	Rear	0.0000	0.0000	0.0000	0	CW	

X Diam: 1.3344
 Z Ref: -0.2976

Entry mode: incremental

Z Ref F1	Measure Tool F2	Abs Inc F4	+0.001 F5	-0.001 F6	+0.0001 F7	-0.0001 F8	Tool Wear F9	Save F10
-------------	--------------------	---------------	--------------	--------------	---------------	---------------	-----------------	-------------

Figure 16

Type in **-0.125** and press **ENTER**. The value of -0.125 will be added to the value measured in Step 1.

- NOTE: Remember to press the **F4 - Abs/Inc** key to toggle the Entry Mode back to “absolute” when you are done.

Automatic Tool Touch-Off cycles (extra-cost option)

Pressing **F2-Measure Tool** will give you access to a sub-menu used for measuring X and/or Z offset measurements of a tool. When Auto Tool Measure (extra-cost option) is set up and enabled, the functions under this sub-menu will give the operator an additional choice of doing X and Z offset measurements automatically using a Tool Touch-Off device.

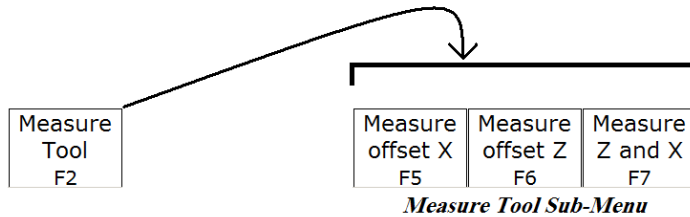

Sub-Menu key	Function
F5 – Measure Offset X	Prompt operator with a choice to do either Manual measure of X offset or Auto Tool Touch-off cycle to measure X offset.
F6 – Measure Offset Z	Prompt operator with a choice to do either Manual measure of Z offset or Auto Tool Touch-off cycle to measure Z offset.
F7 – Measure Z and X	Do Auto Tool Touch-off cycle to measure both Z and X offsets (doing Z first).

The rest of this section will concentrate on the 3 Auto Tool Touch-off cycles accessed under these 3 keys.

Auto Tool Touch-off Cycle to Measure X Offset (F5)

This cycle will do a single axis measuring move along the X axis. The +/- axis movement directions are initially determined by the tool's Nose Vector and secondarily by its Approach Direction, but you can change the X measurement direction by pressing **F1 Orient** on the dialogue box. It is important to position the tool in the correct location before starting this cycle. To run this cycle from the Tool Geometry Offset Library, first jog the tool to the correct location and press:

F2-Measure Tool ► F5-Measure Offset X ► CYCLE START.

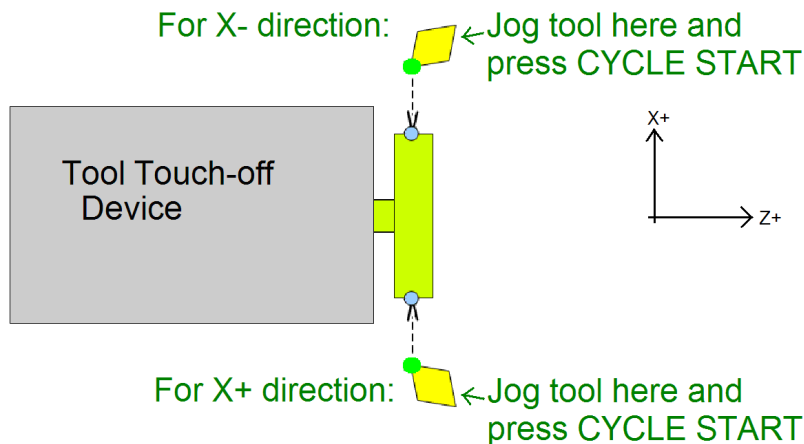

Auto Tool Touch-off Cycle to Measure Z Offset (F6)

This cycle will do a single axis measuring move along the Z axis. The +/- Z direction is determined primarily by the tool's Nose Vector and secondarily by its Approach Direction. It is important to position the tool in the correct location before starting this cycle. To run this cycle from the Tool Geometry Offset Library, first jog the tool to the correct location and press:

F2-Measure Tool ▶ F6-Measure Offset Z ▶ CYCLE START.

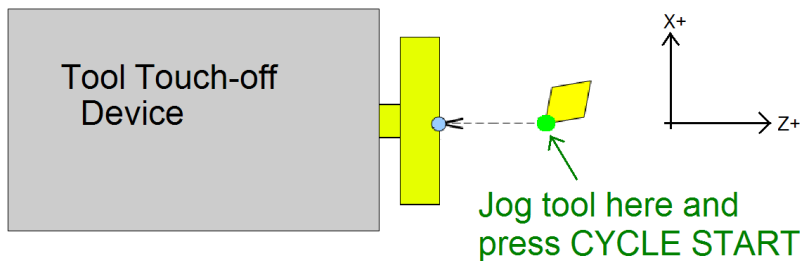

Auto Tool Touch-off Cycle to Measure both Z and X Offsets (F7)

This cycle combines the measurement of X and Z offsets into one cycle. The +/- axis movement directions are initially determined by the tool's Nose Vector and secondarily by its Approach Direction, but you can change the X measurement direction by pressing **F1 Orient** on the dialogue box. To run this cycle from the Tool Geometry Offset Library, first jog the tool to the correct location and press:

F2-Measure Tool ▶ F7-Measure Offset Z and X ▶ CYCLE START.

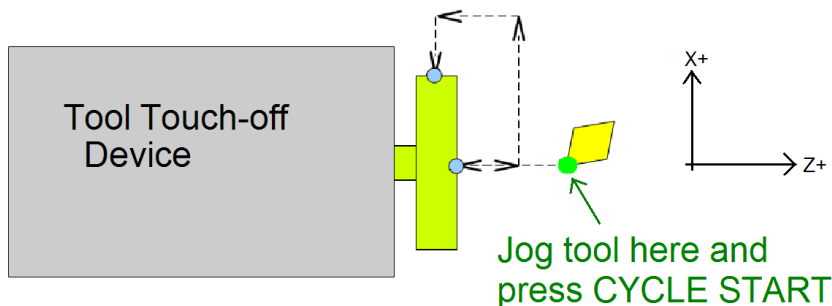

Chapter 5

Part Zero and WCS

Part Zero Menu

To get to the Part Zero menu from the Main Screen press **F1 – Setup** then **F1 – Part**.

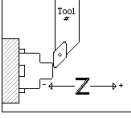
WCS #1 (G54) Current Position (Inches)		Job Name: pawn.cnc	
X 	+0.0000	Tool: T0101	Feedrate: 100%
Z	+0.0000	Spindle: 0 M	Inc. 0.0001
		Coolant	
Stopped			
Set Z Part 0/Position			
1) Jog to Touch Off on Part 2) Edit the Value if Necessary 3) Press F10 to Set Position			
	Axis	Part Position	Tool Number
	Z	0.0000	1
WCS #1 (G54)			
Prev WCS F6	Next WCS F7	Set X F8	WCS Table F9
Set F10			

The Part Zero menu fields and screen elements are described below:

Axis: This field shows which axis the Part Zero is being set up for. When the Part Zero menu is first brought up, the Z axis will be shown. Press **F8 – Set X** to access the Part Zero menu for the X axis.

Position: This field allows you to establish a non-zero offset between where the tool is and where you want the origin to be. On the X-axis, this is either a diameter or radius distance away from the part centerline that the tool tip is touching.

- NOTE: The part centerline is usually considered to be where the X axis position is 0.

Tool Number: This field allows you to tell the control what tool offset number (see the Offset Library in Chapter 4) is being used while setting the Part Zero position. Although this number is called a “Tool Number”, this is **not** a tool number. However, if you only associate tool numbers with the same numbered offset, then this field would correspond to the tool number.

- NOTE: The Offset Library must be up to date before setting the Part Zeroes.

Set All WCS: This field appears only if you are modifying the Part Zero for the X axis.

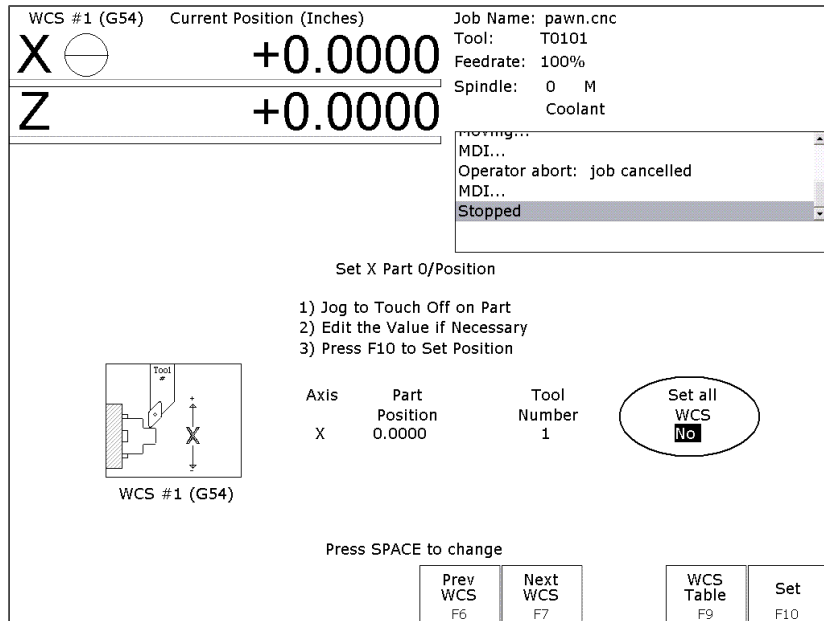

Press <SPACE> to toggle between “Yes” and “No”. If this field is toggled to “Yes” then this field specifies that the position that you enter will be copied to all the X axis Part positions in every Work Coordinate System. This will cause all Work Coordinate systems to have the same X axis Part Zero. This feature is a convenience, since the centerline position of a part is usually set at X=0, regardless of which WCS is currently active. If this field is toggled to “No” then only the currently selected WCS will be affected.

F6 – Previous WCS

This key will select the previous Work Coordinate System. If you will be using multiple work coordinates, you must set up a new set of Part Zeros for each work coordinate. Each work coordinate represents a different Part Zero. You can use this key to cycle through all available Work Coordinate Systems. Note that WCS #1-6 are standard, but WCS #7-18 are an extra-cost option.

F7 – Next WCS

This key is like the **F6 – Prev WCS** key (see above) except that this key will cycle forward to the next work coordinate system. You can use this key to cycle through all available Work Coordinate Systems. Note that WCS #1-6 are standard, but WCS #7-18 are an extra-cost option.

F8-Set X

To get access to the Part Zero menu for the X axis, press **F8 – Set X**. Setting the X axis Part Zero is given special treatment in a sub-menu because it is not done very often (See the section titled “Setting X Axis Part Zero” later in this chapter).

F9 - WCS

Pressing this key will bring up the WCS Configuration menu, which will let you conveniently view and modify the Work Coordinate Systems. See the WCS Configuration Menu section for a further explanation.

F10 – Set

Pressing this key will cause the part position that you entered to be set.

Setting Part Zeros - Introduction:

Setting the Part Zero for a part establishes a local coordinate system with its origin at the centerline of the part. In T-Series controls, this coordinate system considers X+ as always pointing away from the centerline and Z+ always pointing to the right and away from the spindle.

Setting Z-Axis Part Zero (Z₀)

STEP 1:

Jog the tool to the stock surface and take a skim cut across the face (Figure 1), or touch off of the known surface (Figure 2) and leave the tool setting at this Z position.

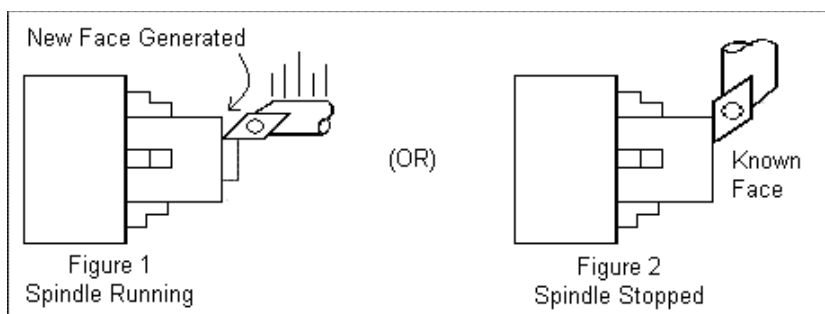

• **NOTE:** In the case of Figure 1, start the spindle by switching to manual mode, press Spin Start button, and adjust RPM with the spindle override.

STEP 2:

On the T-Series Control, from the Main Screen, press **F1 – Setup** then **F1 – Part**. This will bring you to the Z-axis Part Zero menu.

WCS #1 (G54) Current Position (Inches)		Job Name: pawn.cnc	
X	+0.0000	Tool: T0101	
Z	+0.0000	Feedrate: 100%	Inc. 0.0001
		Spindle: 0 M	Slow Jog
		Coolant	
Stopped			
Set Z Part 0/Position			
1) Jog to Touch Off on Part			
2) Edit the Value if Necessary			
3) Press F10 to Set Position			
	Axis	Part Position	Tool Number
WCS #1 (G54)	Z	0.0000	1
Prev WCS F6	Next WCS F7	Set X F8	WCS Table F9
Set F10			

STEP 3:

Type 0.000 (or the known position of the surface you are touching off) into the Part Position field. Press Enter.

• **NOTE:** If, for example, you need to take a 0.05" face cut off of your part, type 0.05 into the Part Position field on the menu. Z-Zero will now be 0.05" deeper into the part from the existing face.

STEP 4:

Enter the Tool Number of the tool being used, and then press the **F10 – Set** key. Part Zero is now set for the Z-axis. All the other tools set up in the Tool Library (Chapter 4) are now automatically set to this new Z-axis Part Zero.

Setting X-Axis Part Zero (X₀)

● **NOTE:** Since the X axis Part Zero is usually defined to be the Centerline of the part, there is usually no need to set it up again when doing a different part. An ideal situation would be that you program all parts to have a Centerline of X=0, and thus you would need to set up the X axis Part Zero for every WCS only one time during the whole life of the machine.

STEP 1:

Chuck up the stock to be machined. Jog the reference tool (in this case, an OD turning & facing tool) to the stock surface and take a skim cut across the surface (Figure 3), or touch off of the known surface (Figure 4) and leave the tool setting at this X position.

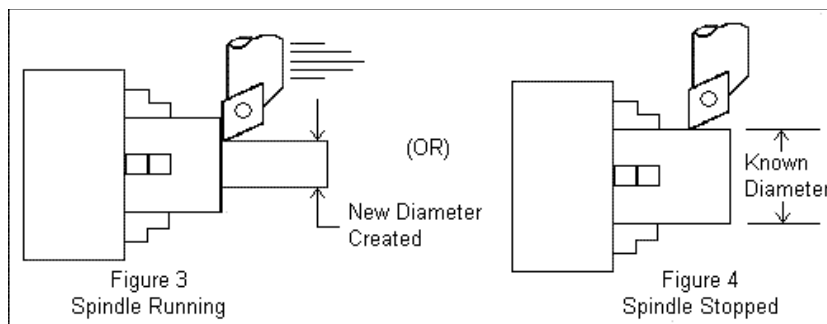

● **NOTE:** In the case of Figure 3, start the spindle by switching to manual mode, press Spin Start button, and adjust RPM with the spindle override.

STEP 2: Measure the resulting diameter

On the T-Series Control, from the Main Screen, press **F1 – Setup**, **F1 – Part**, then **F8 - Set**. **F6 – Prev WCS** and **F7 – Next WCS** keys can be used to select the work coordinate.

● **NOTE:** There are 18 different work coordinates that can be used (1 through 6 are standard; 7 through 18 are an extra-cost option). See “Setting a WCS” later in the chapter.

STEP 3:

Enter the OD measurement taken in Step 2 into the Part Position field, and press Enter.

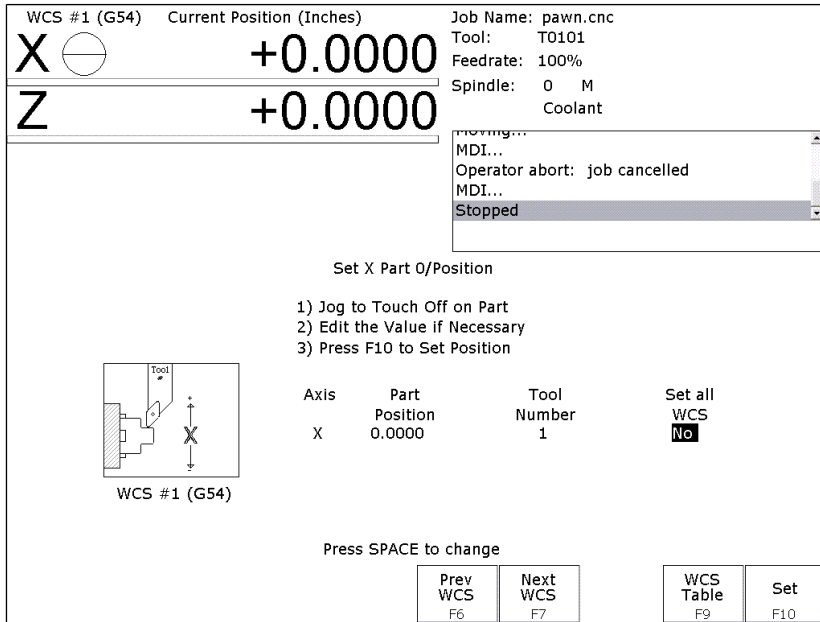

● **NOTE:** Depending on how your control is set, this value can be a diameter or a radius. See Chapter 14, Machine Parameter 55 for further details.

STEP 4:

Enter the Tool Number of the tool being used, and then press the **F10 - Set** key. Part Zero is now set for the X-axis. All the other tools set up in the Tool and Offset Libraries (Chapter 4) are now automatically set to this new X-axis Part Zero.

OPTIONAL STEP:

If you want all Work Coordinate systems to have the same X axis Part Zero, then toggle the “Set all WCS” field to “Yes” and press **F10 - Set**. This will copy the position that you entered to all the X axis Part positions in every Work Coordinate System. This feature is a convenience, since the centerline position of a part is usually set at X=0, regardless of which WCS is currently active.

WCS Configuration Menu

To get to the WCS Configuration menu from the Main Screen, **F1 – Setup, F1 – Part**, then **F9 – WCS Table**. When you enter this screen, the DRO display will automatically switch over to machine coordinates as an aid to entering numbers. All the values on this screen are represented in machine coordinates. X values are radius dimensions, even if the machine is in diameter mode (set in Machine Parameter 55). Note that WCS #1-6 are standard, but WCS #7-18 are an extra-cost option.

There are 2 sections in this menu, Reference Return Points and the Work Coordinate Systems, which define the individual Part Zeros.

F1 – Reference Return Points 1, 2, 3, and 4

This option will let you modify the positions of the reference return points (in machine coordinates). See G30 in Chapter 11 for more information on how to use these return points.

Machine

X

Z

Current Position (Inches)

+0.9974

+0.0001

Job Name: pawn.cnc

Tool: T0101

Feedrate: 100% 0.0 ipm

Spindle: 0 A

335 Emergency stop released

Stopped

Axis	Return #1 (G28)	Return #2 (G30)	Return #3 (G30 P3)	Return #4 (G30 P4)
Z	0.0000	0.0000	0.0000	0.0000
X	0.0000	0.0000	0.0000	0.0000
N	0.0000	0.0000	0.0000	0.0000
N	0.0000	0.0000	0.0000	0.0000
N	0.0000	0.0000	0.0000	0.0000
N	0.0000	0.0000	0.0000	0.0000
N	0.0000	0.0000	0.0000	0.0000
N	0.0000	0.0000	0.0000	0.0000

Save

F10

The G28 position (Return #1) is of interest because it specifies the Tool Check position and the usual Tool Change position. The Tool Check position is the machine coordinate position that the machine will move to when the **TOOL CHECK** button is pressed. Also, the G28 position is the usual position at which tool changes occur during a job run. You can change the G28 position if you would like the Tool Check position and tool changes to occur somewhere else.

F2 – Origins of Work Coordinate Systems

This option lets you specify the locations (in machine coordinates) of the origins of the work coordinate systems. However, the preferred method for setting these values is to use the Part Zero Setup screen. The other 12 work coordinate systems are viewed by pressing **F1 – Next Table**.

Machine	Current Position (Inches)	Job Name: pawn.cnc				
X	+0.9974	Tool: T0101				
Z	+0.0001	Feedrate: 100% 0.0 ipm				
		Spindle: 0 A				
<div style="border: 1px solid black; padding: 2px; margin: 5px 0;">335 Emergency stop released Stopped</div> <div style="border: 1px solid black; padding: 2px; margin: 5px 0; text-align: center;">Press CYCLE START to start job</div>						
Axis	WCS #1 (G54)	WCS #2 (G55)	WCS #3 (G56)	WCS #4 (G57)	WCS #5 (G58)	WCS #6 (G59)
Z	0.00000	0.00000	0.00000	0.00000	0.00000	0.00000
X	0.00000	0.00000	0.00000	0.00000	0.00000	0.00000
N	0.00000	0.00000	0.00000	0.00000	0.00000	0.00000
N	0.00000	0.00000	0.00000	0.00000	0.00000	0.00000
N	0.00000	0.00000	0.00000	0.00000	0.00000	0.00000
N	0.00000	0.00000	0.00000	0.00000	0.00000	0.00000
N	0.00000	0.00000	0.00000	0.00000	0.00000	0.00000
N	0.00000	0.00000	0.00000	0.00000	0.00000	0.00000
N	0.00000	0.00000	0.00000	0.00000	0.00000	0.00000
N	0.00000	0.00000	0.00000	0.00000	0.00000	0.00000
Next Table F1		Save F10				

Using Work Coordinate Systems

These different part zero positions are typically used to reduce setup and/or programming time. There are a number of creative ways the WCS can be used to simplify lathe machining. The 18 work coordinates and the G-codes are shown below. Regular WCS #1-6 are standard, but extended WCS #7-18 are an extra-cost option.

Regular WCS		Extended Work Coordinate Systems		WCS	
WCS	G-Code	WCS	G-Code	WCS	G-Code
WCS #1	G54	WCS #7	G54 P1	WCS #13	G54 P7
WCS #2	G55	WCS #8	G54 P2	WCS #14	G54 P8
WCS #3	G56	WCS #9	G54 P3	WCS #15	G54 P9
WCS #4	G57	WCS #10	G54 P4	WCS #16	G54 P10
WCS #5	G58	WCS #11	G54 P5	WCS #17	G54 P11
WCS #6	G59	WCS #12	G54 P6	WCS #18	G54 P12

At any time that you see the Digital Read Out (DRO) for the X and Z current position, you will see a display of which WCS the control is currently using in the upper left hand corner of the screen right above the DRO (See the figure below). The DRO always displays the tool position from the WCS that is being used.

WCS currently in use is shown on most menus

WCS #1 (G54) Current Position (Inches)

X **+0.0000**

Z **+0.0000**

Job Name: pawn.cnc
 Tool: T0101
 Feedrate: 100% Inc. 0.0001
 Spindle: 0 M Slow Jog
 Coolant

Stopped

Set Z Part 0/Position

- 1) Jog to Touch Off on Part
- 2) Edit the Value if Necessary
- 3) Press F10 to Set Position

WCS #1 (G54)

Axis	Part Position	Tool Number
Z	0.0000	1

Prev WCS F6	Next WCS F7	Set X F8	WCS Table F9	Set F10
----------------	----------------	-------------	-----------------	------------

To change the WCS being used:

- From the T-series control Main Screen, press: **F1 – Setup, F1 - Part**.
- Now press **F6 – Prev WCS** or **F7 – Next WCS**, and the WCS number will change in the upper left corner of the display.

The WCS will change to the next position - if you were on WCS#1 and press **F7 – Next WCS**, it will change the DRO to WCS#2. Simply press **F6 – Prev WCS** or **F7 – Next WCS** until the WCS displayed is the one you want to use. After that you can set up the new WCS using the part setup menus for X and Z to define a new Part Zero position with this WCS. See the section “Setting Part Zeros” in this chapter and the two sections after that for step-by-step instructions of how to zero out your part. Once a WCS is set, the control will remember this position as the Part Zero for that WCS until you change it, even if the control is shut off.

F3 – Work Envelope

Use the **F3 – Work Envel** key to specify the '+' '-' work envelope locations (in machine coordinates) used in conjunction with the G22 G code. The Z, X and I, J parameters specified in the G22 code are stored here, so subsequent G22 codes do not need to specify the limits unless they change.

Note: The work envelope will only work in programmed moves. You will still be able to jog outside of the work envelope.

Chapter 6

Running a Job

To start the currently loaded job, go to the Main Screen and press the **CYCLE START** button on the jog panel. If your control is not equipped with a jog panel, press **ALT-S** on the keyboard.

Active Job Run Screen with G-code Display

If the Run-Time Graphics option is set to Off, the following screen is displayed while a job is running:

WCS #1 (G54)		Current Position (Inches)		Job Name: pawn.cnc																																																																									
X	⊖	+0.5800		Tool: T0808	Program # 10000																																																																								
Z		-0.7521		Feedrate: .0250lpr	Part Cnt: 0																																																																								
				Spindle: 20 M	Part #: 0																																																																								
				Coolant	Time: 0:00:07																																																																								
<div style="border: 1px solid black; padding: 2px;"> Stopped Processing... Moving... Press ESC to cancel </div>																																																																													
<table border="0"> <tr> <td colspan="2">Dist to Go</td> <td></td> <td></td> <td></td> <td></td> </tr> <tr> <td>X</td> <td>⊖</td> <td>+0.0000</td> <td>30.</td> <td>g50s4000</td> <td></td> </tr> <tr> <td>Z</td> <td></td> <td>-0.2857</td> <td>31.</td> <td>; --- Profile ---</td> <td></td> </tr> <tr> <td></td> <td></td> <td></td> <td>32.</td> <td>N0070 S650.0 G0 X0.98 Z0.105</td> <td></td> </tr> <tr> <td></td> <td></td> <td></td> <td>33.</td> <td>G1 X0.78 Z0.105 F0.025</td> <td></td> </tr> <tr> <td></td> <td></td> <td></td> <td>34.</td> <td>G71 U0.025 R0.001</td> <td></td> </tr> <tr> <td></td> <td></td> <td></td> <td>35.</td> <td>G71 P80 Q180 U0.015 W0.005</td> <td></td> </tr> <tr> <td></td> <td></td> <td></td> <td>36.</td> <td>; --- Linear ---</td> <td></td> </tr> <tr> <td></td> <td></td> <td></td> <td>37.</td> <td>N0080 S700.0 X-0.05 Z0.1 G99 F0.05</td> <td></td> </tr> <tr> <td></td> <td></td> <td></td> <td>38.</td> <td>; --- Linear ---</td> <td></td> </tr> <tr> <td></td> <td></td> <td></td> <td>39.</td> <td>N0090 X-0.05 Z0.0 F0.004</td> <td></td> </tr> <tr> <td></td> <td></td> <td></td> <td>40.</td> <td>; --- Linear ---</td> <td></td> </tr> </table>						Dist to Go						X	⊖	+0.0000	30.	g50s4000		Z		-0.2857	31.	; --- Profile ---					32.	N0070 S650.0 G0 X0.98 Z0.105					33.	G1 X0.78 Z0.105 F0.025					34.	G71 U0.025 R0.001					35.	G71 P80 Q180 U0.015 W0.005					36.	; --- Linear ---					37.	N0080 S700.0 X-0.05 Z0.1 G99 F0.05					38.	; --- Linear ---					39.	N0090 X-0.05 Z0.0 F0.004					40.	; --- Linear ---	
Dist to Go																																																																													
X	⊖	+0.0000	30.	g50s4000																																																																									
Z		-0.2857	31.	; --- Profile ---																																																																									
			32.	N0070 S650.0 G0 X0.98 Z0.105																																																																									
			33.	G1 X0.78 Z0.105 F0.025																																																																									
			34.	G71 U0.025 R0.001																																																																									
			35.	G71 P80 Q180 U0.015 W0.005																																																																									
			36.	; --- Linear ---																																																																									
			37.	N0080 S700.0 X-0.05 Z0.1 G99 F0.05																																																																									
			38.	; --- Linear ---																																																																									
			39.	N0090 X-0.05 Z0.0 F0.004																																																																									
			40.	; --- Linear ---																																																																									
Feed -1% F1	Feed +1% F2	Repeat On F3	/Skips On F4	Feed Hold F7	Rapid On F9																																																																								

On this screen, the following F-keys are available:

- F1 – Feed (-1%)** Decrease feedrate override by 1%. This key only appears if jog panel is set to keyboard jogging.
- F2 – Feed (+1%)** Increase feedrate override by 1%. This key only appears if jog panel is set to keyboard jogging.
- F3 – Repeat On/Off** Toggle the repeat feature for part counting. For more information, see **F3** under the Run Menu section later in this chapter.
- F4 – Skips On/Off** Enable/Disable block skips. For more information, see **F4** under the Run Menu section later in this chapter.
- F5 – Auto** This key will only appear in Single Block mode. When you press this key, it turns on Auto mode and disables Single Block mode. The key will disappear upon pressing it because once Single Block mode is disabled, it cannot be re-enabled unless you stop the job. For more information, see **F5** under the Run Menu section later in this chapter.
- F6 – Stops off** This key will only appear if Optional Stops is on. When you press this key, it turns off Optional Stops. This key will disappear upon pressing it because once Optional Stops is turned off, it cannot be re-enabled unless you stop the job. For more information, see **F6** under the Run Menu section later in this chapter.
- F7 – Feed Hold** Turn feed hold on/off. This key only appears if jog panel is set to keyboard jogging.
- F8 – Graph** Switch to run-time graphics screen. This key only appears if the run-time graphics option is turned on.
- F9 – Rapid On/Off** Turn rapid override on/off.

For information on other keys that are available while a job is running, see Chapter 2.

Run-Time Graphics Screen

When a job is running with Run-Time Graphics set to On, the following screen is displayed:

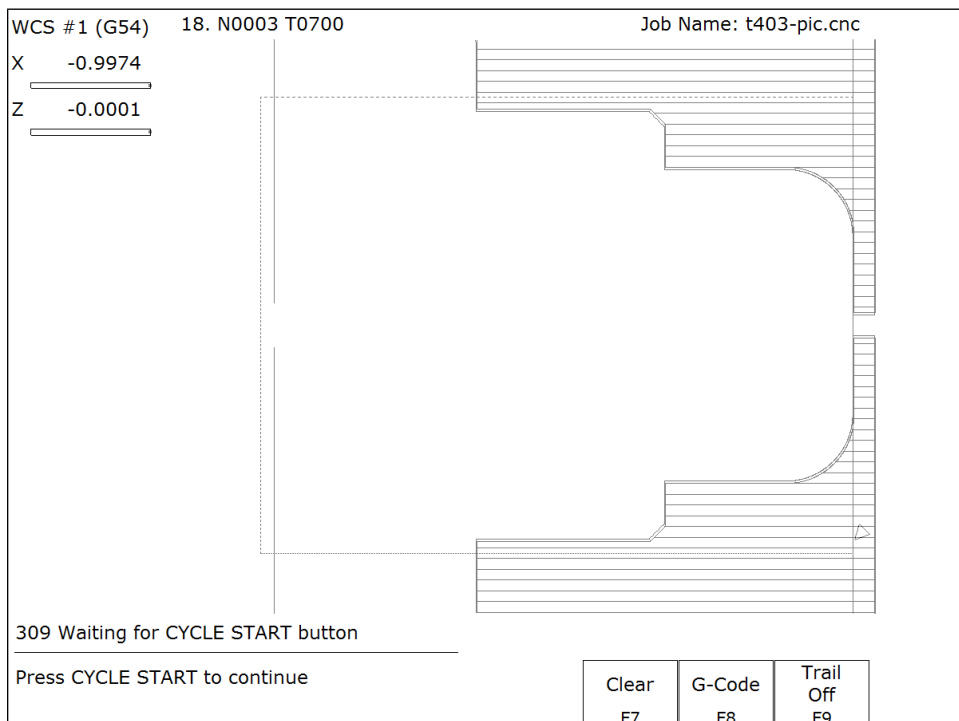

The following keys are available while the job is running in Run Time Graphics.

- F7 – Clear** Clears the trail up to the tool’s current position in the program.
- F8 – G-Code** Switch to the Job Run Screen with G-Code display.
- F9 – Trail On/Off** Turn on/off the tool trail display.

Canceling a Job in Progress

There are three conventional ways to cancel a currently running job (CNC program). When a job is canceled using any of the following methods, the job's progress will be recorded. This allows the user to restart the job using the Resume Job option or the Search and Run option.

CYCLE CANCEL

Pressing this key while a job is running will cause the control to abort the currently running job. The control will stop movement immediately, clear all M-functions, and return to the main screen. Hitting the escape key on the keyboard is the equivalent to hitting “CYCLE CANCEL.”

TOOL CHECK

Pressing this key while a job is running will cause the control to stop the normal program movement, turn off the spindle, clear all M-functions, and go the Run menu screen. Make sure the tool will clear the part before pressing **Tool Check** a second time, which will move the X and Z-axes to their home position. The control will then automatically go to the resume job screen.

EMERGENCY STOP (E-Stop)

Pressing the EMERGENCY STOP button while a job is running will cause the control to abort the currently running job. The control will stop movement immediately, clear all M-functions, and return to the main screen. Also, the power to all axes will be released.

Resuming a Canceled Job

If a job is canceled using one of the methods described above, it can be resumed in one of three ways.

CYCLE START

Pressing the **CYCLE START** button will restart the job at the **BEGINNING** of the part program.

Note: Before performing a **F1-Resume Job** or **F2-Search** the tool may need to be positioned in X and Z for cycles that start down inside an ID or behind a shoulder.

Resume Job – F1 from the Run menu

Restart the canceled job at or near the point of interruption. See the next section in this chapter entitled “**Run menu**” for more information.

Search – F2 from the Run menu

Restart at a specified point in the part program. See the next section in this chapter entitled “**Run menu**” for more information.

Run menu

Press **F4-Run** from the main screen to access the Run menu. From this menu, the operator can restart a canceled job or change the way the job will run.

WCS #1 (G54)		Current Position (Inches)		Job Name: pawn.cnc		Tool: T0800		Feedrate: 100% 0.0 ipm		Spindle: 0 A			
X		+0.0000		<div style="border: 1px solid black; padding: 2px;"> 304 MDI... 307 Operator abort: job cancelled 301 Stopped 304 MDI... 307 Operator abort: job cancelled 301 Stopped Press CYCLE START to start job </div>									
Z		+0.0000											
C		+0.0000											
Run													
Single Block Mode:		Off		Run-Time Graphics:		Off							
Optional Stops:		Off											
Block Skips:		Off											
Job Repeat:		On											
Part Count:		<input type="text" value="0"/>											
Resume Job	Search	Repeat Off	/Skips On	Block	Stops	Graph	Rapid Off	RTG On/Off					
F1	F2	F3	F4	F5	F6	F8	F9	F10					

F1 - Resume Job

Press **F1-Resume Job** in the run screen to go to the resume job screen. If the job was canceled by pressing **Tool Check**, the control will go to the resume job screen automatically. From this screen, the user can modify tool offsets and the tool library, turn single block mode on and off, turn optional stops on or off, graph the partially completed job, or start the partially completed job.

The resume job option is not always available. The following situations will cause the resume job option to be unavailable:

- Loading a new job.
- Running a job to completion.
- Parse errors in the job.

Editing or reposting the job file.
Loss of power while a job is running.

F2 - Search

Invoking this option will bring you to the “Search and Run” menu. This menu will allow you to specify the program line, block number, or tool number at which execution of a program is to begin. Program lines are numbered from the top of the file down with the first line numbered 1. To enter a block number place an "N" in front of the number. To enter a tool number place a "T" in front of the number. Pressing **CYCLE START** from here would start the program at the point you specified.

An extra option unique to the “Search and Run” screen is the **F1-Tool Change** “Do Last Tool Change” function. This key toggles the tool change option as shown on screen. A "YES" tells the control to perform a tool change so that the tool specified for the line or block has the tool indicated in the program. A "NO" uses the currently loaded tool, regardless of what tool is specified for the line or block being searched.

NOTE: You cannot search into a subroutine.

F3 – Repeat On/Off

This key toggles the repeat feature for part counting. When part counting is in effect and Repeat is on, the job will be automatically run again until the specified number of parts have been run. The On or Off label indicates the state to which the repeat feature will toggle to when pressed. It does not indicate the current state. The current state is indicated in the user window above.

Part Count: this prompt is used to set the required number of parts. Positive values set the part counter to count up and negative values configure the part count to count down. For example, if 10 is entered in the Part Count prompt, the Part Cnt in the status window changes to 10 and the Part # changes to 0 with an upward arrow indicator. When a job is completed, the Part # will increment to 1. If repeat is on, the job will automatically start again and keep running until the Part # has reached the Part Cnt. If a -10 is entered in the Part Count prompt, the Part Cnt in the status window changes to 10 and the Part # changes to 10 with a downward arrow indicator. When a job is completed, the Part # will decrease to 9 and if repeat is on, the job will automatically start again and keep running until the Part # has reached 0.

F4 - /Skips On/Off

This function toggles the block skip feature. When block skipping is on, G-code lines that start with a forward slash character ‘/’ are skipped (not processed). Note that because of the way a job is processed (in a pre-processed buffered fashion) the effect of this key may be delayed if you press it while a job is running. The On or Off label indicates the state the /Skips feature will toggle to when pressed. It does not indicate the current state. The current state is indicated in the user window above.

F5 - Block Mode

Turns Single Block mode on and off. This is similar to pressing AUTO/BLOCK. If Single Block mode is on, CNC11 will stop after each block in your part program and wait for you to press **CYCLE START**. Note that Auto mode is the default mode. If you use this key to turn on Single Block mode and then run a job, Auto mode will be re-instated when the job ends. The current state of this setting is indicated in the user window above.

F6 - Optional Stops

Turns Optional Stops on and off. If Optional Stops are on, any M1 codes that appear in your program will cause a wait for **CYCLE START** (just like M0). If Optional Stops are off, M1 codes will be ignored. Note that the default mode for Optional Stops is off. If you use this key to turn on Single Block mode and then run a job, Optional Stops will be set to off when the job ends. The current state of this setting is indicated in the user window above.

F8 - Graph

Graphs the part. For more information, see the "**F8 - Graph**" section in chapter 3. If this feature is invoked from the Run and Search screen or the Resume Job screen, then the graphics will show exactly where the searched line or block begins. Dotted lines indicate the portion of the part that is skipped. Solid lines indicate the portion of the part that will be machined.

F9 – Rapid On/Off

This function key toggles Rapid Override. The On or Off label indicates the state to which the Rapid Override feature will toggle when pressed. It does not indicate the current state. In the Rapid Override On state, the speed of rapid moves (G0) can be adjusted by the Feedrate Override knob. In the Rapid Override Off state, the speed of rapid moves will be at full speed (max rate).

F10 – RTG On/Off

This function key toggles the Run-Time Graphics option. If the option is turned on, Run-Time Graphics automatically starts when the **CYCLE START** button is pressed. This option must be turned on for Run-Time Graphics to be used. If the option is turned off, Run-Time Graphics cannot be started while a job is running.

Power Feed

Press **F4-Feed** from the Setup menu to access the Power Feed screen. This screen is used to command axis movement. All the operations available on the Power Feed screen may also be performed in MDI with the appropriate M and G codes.

F1 - Absolute Power Feed

Press **F1-Abs** to move an axis to an absolute position, at a specified feedrate.

F2 - Incremental Power Feed

Press **F2-Inc** to move an axis an incremental distance, at a specified feedrate.

F3 - Free XZ

Press **F3-Free** to release power to the X and Z motors, allowing you to use your machine manually.

F4 - Power XZ

Press **F4-Power** to apply power to the X and Z motors, allowing you to use your machine in CNC mode.

Chapter 7

The Utility Menu

To get to the Utility Menu, press **F7 - Utility** at the CNC software Main Screen. The model will vary depending on your T-Series Control model.

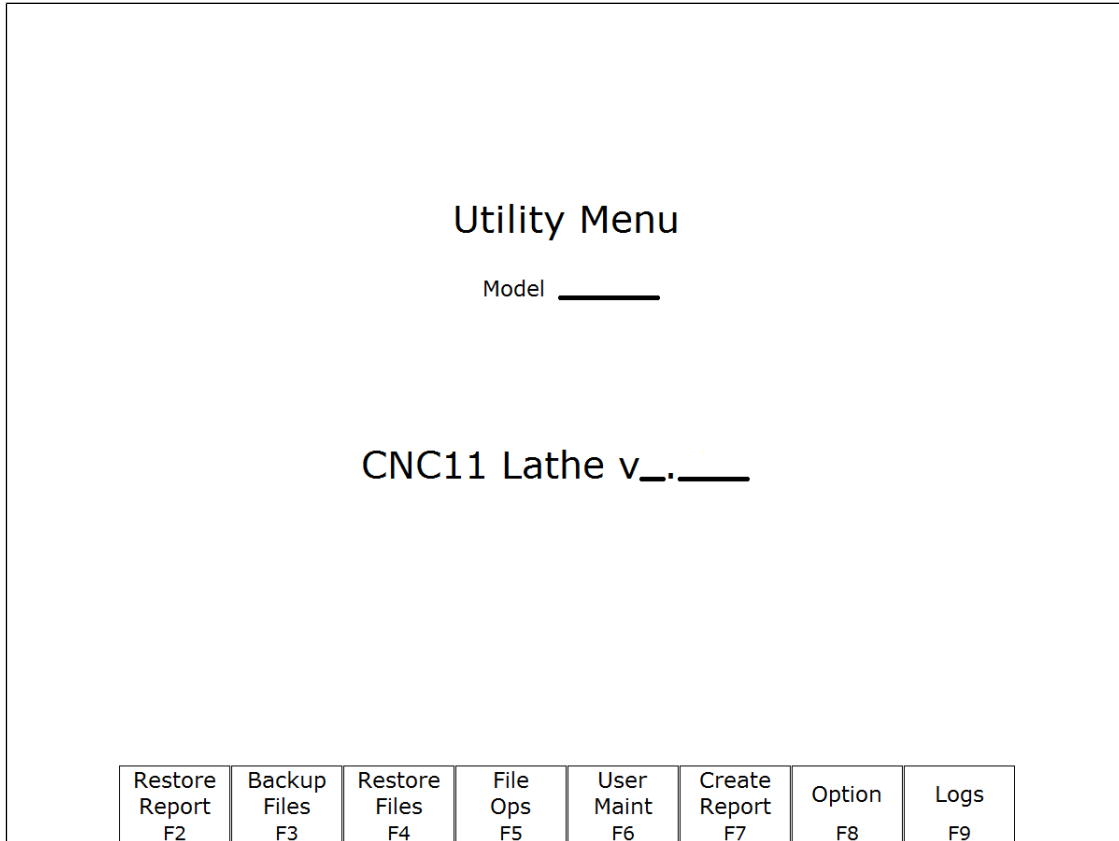

F2 – Restore Report This option is used primarily for restoring a system configuration from a previously saved *report.zip* file (See **F7 – Create Report**).

F3 – Backup Files This creates an archive file “cnc_backup.zip” containing CNC program files and Intertercon part program files from the following directories and their subdirectories: ncfiles directory, c:\icn_lath, and any other directories mentioned in the pathl.ini configuration file.

F4 – Restore Files Use this option to restore the data previously backed up with **F3 – Backup Files**. (Note that this feature will not work with backups created by control software prior to version 3.04.)

F5 – File Ops Use this menu to perform file and directory operations such as: Importing and Exporting (copying) files to and from the control, rename or delete files, create or delete directories.

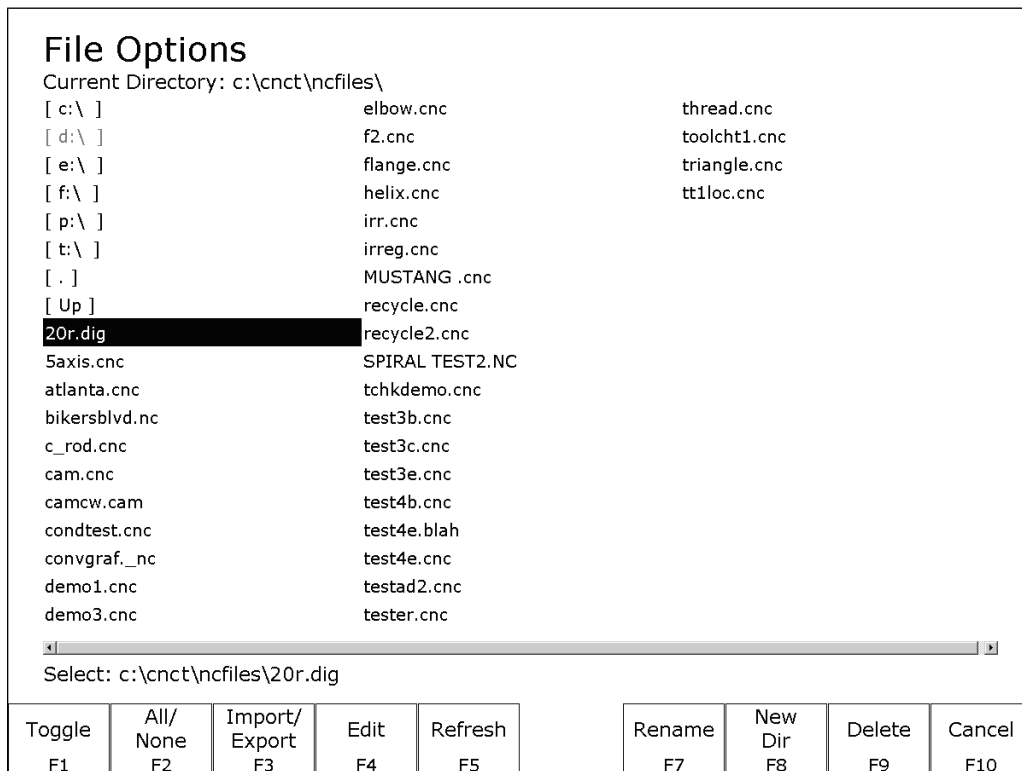

- F1 – Toggle** Press once to select or press again to unselect a single file.
- F2 – All /None** Press once to select all or press again to unselect all files.
- F3 – Import/
Export** Import or Export selected files.
- F4 – Edit** Opens selected file in editor.
- F5 – Refresh** Refresh file list. Use after inserting a new USB storage device
- F7 - Rename** Rename selected file or directory.
- F8 - New Dir** Create a new directory in the current folder.
- F9 - Delete** Deletes selected file or directory.
- Page Up** Move the cursor backward one page.
- Page Down** Move the cursor forward one page.
- End** Select the last file in the list.
- Home** Select the first file in the list.
- Arrow Keys** Move the cursor in the selected direction.

F6 – User Maint

Use this menu to perform user maintenance such as checking an axis for excessive drag or setting backlash

F1 – Drag The Drag Factor utility is used to determine if an axis has an excessive amount of drag. To run a drag test, use the **F1** key to select the axis which you wish to test, position the axis at or near the home position and press **CYCLE START**. The axis will move back to the home switch then traverse the entire range of travel for the axis moving to the opposite limit and returning to home while moving the slow jog rate. If excessive friction (drag) is encountered an error message will be displayed. When the test completes, use **F8-Graph** to display the results. The red horizontal lines indicate the bounds acceptable limits for the machine as it is currently configured.

F2 - Lash (Backlash Compensation) In order to insure an accurate measurement always set the backlash compensation in the control to zero before attempting to measure the physical lash in an axis.

F7 – Create Report Generates a backup of system configuration files called *report.zip* and copies it to the specified location. Your dealer may then use the disk for servicing and troubleshooting purposes. To restore the configuration files from the report disk, press **F2 – Restore Report** from the Utility menu.

F8 – Options Shows the software options that you have purchased or added to your control. On this screen you can also enter unlock codes for software options that you have purchased. This page will also display the PLC programs, PIC type, and System ID #.

F9 – Logs Shows the messages and errors that have been logged by the control.

F1 – Errors Displays the error/message log. Use **PgUp, PgDn, Home, & End** to view and **ESC** to exit.

F2- Stats Displays counts of errors logged. Use **PgUp, PgDn, Home, & End** to view and **ESC** to exit.

F3 – Export Exports the log to a destination of your choosing.

Chapter 8

Lathe Intercon

Introduction

Intercon (Interactive Conversational) software for Lathes allows you to quickly create a lathe part program right at the control without having to be a G-code expert. Intercon will prompt you to enter values from your print that describes the geometry of the part. Intercon will display graphics of the part as you are creating it, helping you to quickly proceed through part programming.

Lathe Intercon Main Menu

When you access Intercon through the **F5-CAM** option in the CNC11 Main screen, the part program will be displayed if the current job loaded in CNC11 has an associated Intercon program. If the job file in CNC11 did not have an associated Intercon program, the **F1-File** menu will be displayed. See the “Lathe Intercon File Menu” section later on for a description of the file menu.

Intercon Lathe					Current Part: pawn.lth					
Operation #	Type	X (D)	End Z	Tool						
0001	;Demo Lathe Part									
0002	; tool #8 - 55 degree turning tool									
0003	; tool #7 - .125 wide cut off tool									
0004	; not .125 wide change Z tool 7									
0005	Facing	0.8500	0.1000	08						
0006	G50s4000									
0007	Profile									
0008	Linear	-.07500	0.1000	07						
0009	Linear	-.05000	0.1000	07						
0010	Linear	0.05000	0.0000	07						
0011	Arc CCW	0.0000	-.0000	07						
0012	Arc CCW	0.2658	-.03198	07						
0013	Linear	0.3264	-.04088	07						
0014	Arc CW	0.2400	-.04837	07						
0015	Linear, CR	0.5000	-.10375	07						
0016	Linear	0.6250	-.10375	07						
0017	Linear, CR	0.6250	-.11625	07						
0018	Linear	0.7400	-.11625	07						
0019	Finish Pass	0.7400	-.14850	07						
0020	Profile End	0.9500	0.1000	08						
0021	Cutoff	0.7500	0.1000	08						
0022	End Prog	0.8400	-.14750	07						
		0.8400	-.14750	07						
					Status					
					Stock Diameter	X:	0.9000			
					Stock Length	Z:	1.4500			
					Tool Num/Offset	:	T0808			
					Nose Vector	:	0			
					Feedrate	:	0.0100 F/R			
					Spindle Speed	:				
					Spindle Dir.	:	500 CSS			
					Cutter Comp	:	CW			
					Coolant Type	:	None Off			
File	Modify	Insert	Cut	Paste	Copy	Copy Menus..	Graph	Setup	Post	
F1	F2	F3	F4	F5	F6		F8	F9	F10	

While in the Lathe Intercon Main Menu, use the up and down arrow^{F7} keys to highlight the desired operation.

F1 - File

Press **F1-File** to display the File Menu. See the “Lathe Intercon File Menu” section later in this chapter for a description of the file menu.

F2 - Modify

Press **F2-Modify** (or the **ENTER** key) to make changes to the highlighted operation. This will display the Edit Operation Menu for the highlighted operation. Use the **Page Up** and **Page Down** keys to move between operations and highlight the operation you want to modify while in the Edit Operation Menu. See the “Insert Operation” section later in this chapter for a description of each operation type.

F3 - Insert

Press **F3-Insert** to insert an operation above the currently highlighted operation. See the “Insert Operation” section later in this chapter for details.

F4 - Cut

Choosing **F4-Cut** will cut (remove) the highlighted operation from the program. The operation that is cut is placed onto the clipboard stack. Attempting to cut a profile start or end operation will cut the entire profile.

F5 - Paste

Choosing **F5-Paste** will paste the last operation that was cut or copied into the clipboard stack into the current program line that is before the highlighted operation. A number on the second line of the Paste key indicates the number of operations that are currently in the clipboard stack. If the top of the clipboard contains a profile, the entire profile will be pasted.

F6 - Copy

Choosing **F6-Copy** will copy the highlighted operation into the clipboard stack and advance the cursor to the next operation.

F7 – Copy Menus...

Choosing **F7-Copy Menus...** will display these options:

F1-Copy Menu - allows a range of operations to be copied. Specify the Start Block, End Block, and Destination in the prompts that appear in the Copy Menu. The range of operations is copied into a location that precedes the destination block.

F2-Move Menu - allows a range of operations to be moved. Specify the Start Block, End Block, and Destination in the prompts that appear in the Move Menu. The range of operations is moved into a location that precedes the destination block.

F3-Cut, F4-Paste, F5-Copy perform the same actions as described above.

F9-Clear Clipbrd - removes all operations in the clipboard stack.

F8 - Graph

Press **F8-Graph** to display a graphic preview for the part. See the “Graphics” section later in this chapter for details.

F9 - Setup

Press **F9-Setup** to change the part setup. The following window will be displayed on the screen. Use the up and down arrow keys to select between fields. Note that there are more fields than what the menu can show, so if you go beyond the bottom of the screen, the fields will scroll up revealing more Intercon Setup items. Press **F1-Toggle** to toggle between options when necessary and press **F10-Accept** to accept the setup when you are finished. You can also access the Tool Library from here by pressing **F6-Tools**. Press the **ESC** key to cancel and return to the File menu. **NOTE: Additional fields can be accessed by pressing by pressing the down arrow key or page down key**

Intercon Lathe v3. ___		Current Part: Part1.lth			
Intercon Setup					
Comment Generation	:	Enabled			
Clearance Amount	:	0.1000			
G71/G72 Profile Rough Cut Depth Increment	:	0.1250			
G71/G72 Profile Rough Cut Escape Amount	:	0.0010			
G71/G72 Profile Rough Cut Escape Angle	:	45.0000			
G70 Profile Finish Multi/Single pass behavior	:	Multi-pass			
Peck Retract Amount	:	0.1000			
G74 X Relief Amount	:	0.0000			
G75 Z Relief Amount	:	0.0000			
Thread Min. Cut Depth	:	0.0010			
Thread Chamfer Amount	:	0.0000			
Chamfer Blend Radius	:	0.0100			
Spindle/Coolant Delay	:	3.00			
Max Spindle Speed (G50)	:	300			
Modal Linear	:	No			
Modal Arc	:	No			
Modal Drill/Bore/Tap	:	Yes			
Suppress G28 for tool change	:	No			
Help Icons always on	:	No			
X Coordinate Input Mode	:	Diameter			
Taper Angle Input Fields	:	Yes			
<table border="1" style="width: 100%; text-align: center;"> <tr> <td style="width: 33%;">Toggle F1</td> <td style="width: 33%;">Tools F6</td> <td style="width: 33%;">Accept F10</td> </tr> </table>			Toggle F1	Tools F6	Accept F10
Toggle F1	Tools F6	Accept F10			

Comment Generation: Toggle between Enabled and Disabled. When comment generation is enabled, Intercon will insert a comment before each block describing the operation type. Disabling comment generation reduces the size of the file.

Clearance Amount: Set the distance away from the part you want to position when changing from a rapid to a feedrate move. This amount applies to both the X and Z-axes. Adjust this value to adjust the retract amount in a threading cycle (G76).

G71/G72 Rough Cut Depth Increment: Enter the amount of material to remove per pass in a profile cycle. Value is always a radius amount.

G71/G72 Rough Cut Escape Amount: Enter the distance to retract after a cutting pass has been made in a profile cycle. The values are always a radius amount.

G71/G72 Rough Cut Escape Angle: Enter the angle of retract (in degrees) after a cutting pass has been made in a profile cycle.

G70 Profile Finish Multi/Single pass behavior: Toggle between Multi-Pass and Single Pass behavior for profile finish pass. In Multi-Pass mode, a Finish Pass operation will perform multiple incremental finish cuts each at the specified "Depth of Cut" away from each other. In Single Pass mode, a Finish Pass operation will perform 1 finish cut at the specified "Depth of Cut" away from the final finish profile.

F9 – Setup (continued)

Peck Retract Amount: Enter the distance to retract after a cutting move has been made in the peck drilling cycle, peck cut off cycle and grooving cycle.

G74 X Relief Amount: Enter the relief amount for the X-axis in a Grooving cycle. This is the amount the tool moves away from the material in the X-axis direction before making rapid moves to position for the next cut.

G75 Z Relief Amount: Enter the step over amount for the Z-axis in a Grooving cycle. This is the amount the tool moves away from the material in the Z-axis direction before making rapid moves to position for the next cut.

Thread Min. Cut Depth: Enter the minimum amount you want removed for a pass in the threading cycle.

Thread Chamfer Amount: Enter the number of turns to taper from the thread depth to the surface of the work piece.

Chamfer Blend Radius: Enter the radius to use when rounding the corners of a chamfer when blend chamfer is selected.

Spindle/Coolant Delay: Enter the amount of time in seconds that you want the lathe to wait for the spindle to get up to speed and the coolant to begin flowing.

Max Spindle Speed (G50): Enter the maximum spindle speed for posted Intercon programs. Posts a G50 at the beginning of the program if the value entered is greater than zero.

Modal Operations (Linear, Arc, Drill/Tap): Toggle between yes or no. Entering yes will cause the same type of operation to be automatically inserted after the initial operation has been accepted.

Surpress G28 for Tool Change: Toggle between yes or no. Entering “no” will allow Intercon to post a G28 on a tool change operation to return the tool to the G28 position. Gang tooling setups usually require this option to be set to “yes”.

Help Icons always on: Toggle between yes or no. Selecting “yes” means that help information will always be displayed when editing operations. “No” means that you will have to press a key to get help. Whether set to “yes” or “no”, help screens can always be toggled on or off by pressing the **F5-Help** key when editing an operation.

X Coordinate Input Mode: Toggle between radius and diameter. You can select to enter the coordinates as radius amounts or as diameter amounts.

Taper Angle Input Fields: Toggle between hide and display. When you select hide, the fields that correspond to polar coordinates will not be shown. When you select display, the fields that correspond to polar coordinates will be shown.

Modal Input Fields: Toggle between hide and display. When you select hide, modal fields will not be shown. When you select display, modal fields will be shown.

DRO Units / Machine Units: Sets the units of measure, either Inch or Millimeter. It is recommended that these 2 fields be toggled together to the same units.

Stop Spindle During Tool Change: Toggle between Yes and No. Select “Yes” if you want the spindle to be shut off during a tool change. Select “No” if you want the spindle to be left on while doing a tool change.

Stop Coolant During Tool Change: Toggle between Yes and No. Selecting “Yes” will cause the coolant to be shut off during a tool change. Selecting “No” will cause the coolant to be left on while doing a tool change.

Cutter Comp Look-ahead: This sets the number of segments that can be parsed ahead when Cutter Comp is turned on.

F10 - Post

Press **F10-Post** to post a part program. Posting a part program generates the G-codes for the program. After the program is posted, you will be returned to the control software’s Main Screen where the G-code program will be loaded and you can press **CYCLE START** to run the job. The Intercon program will be automatically saved.

Esc - Quit

Press **Esc** to quit Intercon. You will be prompted to save changes if any were made. You will be returned to the control software’s Main Screen.

Teach Mode

The X and Z keys will fill in a field with the current position for the related axis. This feature works when editing most fields in an operation. Press **F9-Teach Mode** when editing an operation to display a DRO.

Lathe Intercon File Menu

Press **F1-File** while in the Intercon Main Menu to access the File Menu. The screen will look something like the example below:

Intercon Lathe		Intercon File Menu		Current Part: pawn.icn	
Directory: c:\icn_lathe					
File	Programmer	Description	Date Modified		
[[c:\]		Drive			
[[..]		Parent directory			
Pawn	John Q. Public	Demo Pawn Part	06-Oct-2006		
Shaft	John Q. Public	Demo Shaft Part	06-Oct-2006		
Pipethread	John Q. Public	Demo Pipe Thread Part	06-Oct-2006		
New F1		Load F2		Save F3	
		Save As		Delete F5	
					Details On/Off

F1 - New

F4

Press **F1-New** to create a new file; you will be prompted to save changes to the currently loaded part program. Press “Y” to save changes or “N” to continue without saving changes. Choosing **F1-New** will display the “New file:” prompt above the function keys. Type the name of the new file, then press **F10-Accept** or the **ENTER** key to accept the new name. After accepting the new name, the program header information can be entered.

F2 - Load

Press **F2-Load** to load an existing program. You will be prompted to save changes to the currently loaded part program. Press “Y” to save changes or “N” to continue without saving changes.

Load file from CNC hard drive c:\icn_lath
 Use arrow keys to select file to load and press F10 to Accept.

File	Programmer	Description	Date Modified
[.]		Parent directory	06-Oct-2006
pawn	John Q. Public	Demo Pawn Part	06-Oct-2006
anny-en2	John Q. Public	Demo Encoder Shaft	06-Oct-2006
pipethread	John Q. Public	Demo Pipe Thread	19-Nov-2006

Job to load? bracket.cnc

G code	Floppy	Details	Show	Date/	Edit F6	Help	Graph F8	Advanced	Accept F10
---------------	---------------	----------------	-------------	--------------	-------------------	-------------	--------------------	-----------------	----------------------

F9

Load Menu

To navigate the files in the load menu, use the arrow keys to move the cursor around and highlight the file to be loaded. The **HOME**, **END**, **PAGE UP** and **PAGE DOWN** keys can be used to navigate the list of files. Names that are bracketed, for example [..], are the names of directories in the current directory, which is displayed at the top of the screen.

It is also possible to load a file by typing the name of the program to be loaded. When typing has started, the characters appear in the “File to load:” prompt above the function keys. Different drives and directories can be accessed by typing in the path at the “File to load:” prompt, or by pressing **F10** or **ENTER** on a bracketed directory name. When loading a new file, a prompt will be displayed asking whether to save the existing file if there was one.

Additional viewing and loading options are available through the F-Key menus which are detailed below:

F1 – G code/ICN

Allows user to toggle the view between the Intercon files present in either c:\icn_lath or c:\cnct\ncfiles.

F2 – Floppy USB/LAN

Provides options for loading Intercon files from USB devices, floppy and LAN drives.

F3 – Details On/Off

The **F3 - Details On/Off** option changes the format of the display such that each file or directory is on a separate line and there are columns displayed for Programmer, Description, and Date Modified, i.e., the information that is contained in the program header operation.

Load Menu (continued)

F4 – Show recent

Use the **F4 – Show Recent** option to show the 15 most recently loaded Intercon and g-code files. It is important to remember that even though g-code files are displayed on this screen, **ONLY** Intercon files should be loaded from this screen. **WARNING!!!** Attempting to load a g-code file from the “Show Recent” screen will cause an error which will discard the current Intercon program. All unsaved changes will be lost. If you should accidentally load a g-code file, press escape to return to the main Intercon menu.

F5 – Date/Alpha

Use **F5 Date/Alpha** to view files either alphabetically or by date modified. By default, programs are listed in ascending alphabetical order.

F6 – Edit

Opens the selected file in Intercon for editing.

F7 – Help On/Off

Displays on screen help for the load menus.

F8 – Graph

Graphs the selected file.

F9 - Advanced

Displays file menu in a comprehensive “all in one” format similar to Windows Explorer

Lathe Intercon File Menu (continued from page 8-6)

F3 - Save

Press **F3-Save** to save the current part program under its current name.

F4 - Save As

Press **F4-Save As** to save the current part program under a different name or to a different drive/directory. This allows you to make changes to a program and save the file under a different name so the original program remains unchanged. The name can be up to 8 characters long, but it cannot contain the symbols +=\[]'./;<>? in the filename. If the new name already exists, a prompt will be displayed as a warning and will give the option to overwrite the existing file or return to enter a different name.

F5 - Delete

Press **F5-Delete** to delete a file. After **F5-Delete** is pressed, the screen will appear as in the **F2-Load** option where the same keys can be used to navigate the files. A yes/no prompt will appear after accepting a file for deletion for final confirmation.

F9 – Details On/Off

Turns Intercon part file information display on or off.

Insert Operation

Press **F3-Insert** or **Insert** key to access the Insert Operation Menu. From this menu, you can add operations to a part program.

Intercon Lathe					Current Part: ANNY-EN2.LTH				
Operation #	Type	End X(D)	Z	Tool	Select operation to insert...				
0010	:shaft of encoder A-Y								
0020	Turning	0.8500	0.1000	05					
0030	Profile	0.7500	0.1000	05					
0040	Linear	-0.0500	0.1000	05					
0050	Linear	-0.0500	0.0000	05					
0060	Linear, BL	0.3900	0.0000	05					
0070	Linear	0.3900	-1.3750	05					
0080	Linear, CR	0.7500	-1.3750	05					
0090	Linear	0.7500	-2.6500	05					
0100	Finish Pass	0.9500	0.1000	04					
0110	Profile End	0.7500	0.1000	04					
0120	Thread	0.4900	0.3000	04					
0130	Groove	0.8500	-2.0000	07					
0140	End Prog	0.8500	-2.0000	07					

Line	Arc	Drill	Tap	Thread	Profile	Turn	Groove	Cutoff	Other
F1	F2	F3	F4	F5	F6	F7	F8	F9	F10

The operation is added before the currently highlighted operation. The block number is shown to the left. The operations you can insert are listed at the bottom of the screen. Pressing the function key that corresponds to an operation will bring up the Edit Operation Menu for that operation.

NOTE: For operations that use negative side tooling (see chapter 4) X values will be negative, such as starting and ending diameters in a turning cycle. Roughing and finishing tools are the same and the user is required to do tool positioning for tool changes.

F1 - Linear

Press **F1-Line** at the Insert Operation Menu to insert a linear operation.

```

Edit Operation
#0050 Linear
Linear type      : Feedrate
End:            X: 0.5000
End:            Z: -3.0000
Taper angle     : 0.00
Length          : 0.0000
Connect Type    : None
Connect Radius  : 0.0000
Chamfer Length  : 0.0000
Tool Num/Offset: T0101
Feedrate        : 500.0000 f/r
Spindle Speed   : 1000 CSS
Cutter Comp     : None

```

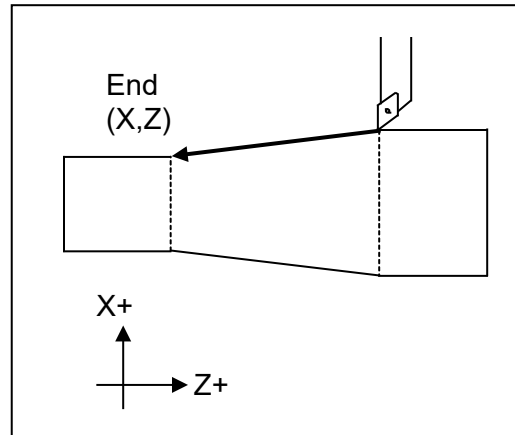

Press **F1-Toggle** or **Space** key to toggle between "Rapid" and "Feedrate" options when necessary and then use the **Up** and **Down** arrow keys to move between fields and fill in the rest of the required information. Once complete press **F8-Graph** to check your work and **F10-Accept** to accept the entries. Use the up and down arrow keys to move between fields. Press **ESC** to cancel and return to the Insert menu.

The destination of the linear move can be given in terms of the end point coordinates or as the counterclockwise angle from the 3 o'clock position to the line and the length of the line (polar coordinates). Press **F3-Modal Display** to hide modal fields. Press this key again to show those fields. Press the **F4** key to hide the polar coordinates. Press this key again to display those fields.

Linear Type: Enter the type of linear move you want to make (Rapid or Feedrate). This field can be toggled between Rapid and Feedrate. A rapid move is a non-cutting positioning move made at the maximum rate. A feedrate move is a cutting move made at the programmed feedrate. When performing a cutting operation, this must be toggled to Feedrate.

End X: Enter the X coordinate of the end position of the linear move. You can toggle between absolute and incremental position. When toggled to absolute, enter the absolute position, with reference to the part zero. When toggled to incremental, an INC will appear next to the entry. In this mode, enter the X distance from the preceding end position.

End Z: Enter the Z coordinate of the end position of the linear move. You can toggle between absolute and incremental position. When toggled to absolute, enter the absolute position, with reference to the part zero. When toggled to incremental, an INC will appear next to the entry. In this mode, enter the Z distance from the last preceding end position.

Angle: The destination can also be determined with an angle from the three o'clock position. Enter this angle in conjunction with the length to determine the end point of the linear move.

Length: Enter the length of the linear move. The length, along with the previously entered angle, will be used to calculate the end point of the move.

Connect Type: When two feedrate moves are performed consecutively, you can choose the style in which they are connected. You can toggle this field between the following options: None, Bl Chamf (Dist), Chamf (Dist), Bl Chamf (Len), Chamf (Len), or Radius. When set to none, the linear operations are connected at the point of intersection. There are now two chamfer types: Distance and Length. For Distance Chamfers the operator specifies the amount of distance to be removed from the ends of the two linear segments. The chamfer connects the two shortened segments. If a Length Chamfer is chosen, the linear moves are connected by a chamfer of a specified length. Both chamfer types have a blended version. When blend chamfer is chosen, the linear moves are connected by a chamfer with rounded corners. When radius is chosen, a rounded corner connects the two linear moves.

- NOTE: Chamfers and blend chamfers in programs created with pre 8.10 Intercon are Length chamfers.
- NOTE: Chamfer and blend chamfer cannot be used to connect to an arc.

Connect Radius: Enter the radius of the rounded corner used to connect two feedrate moves.

Chamfer Distance: Enter the Distance to be removed from the end of each linear segment.

Chamfer Length: Enter the length of the chamfer you want to connect two linear feedrate moves.

Tool Num/Offset: Enter the tool number and offset number used. The first two digits is the tool number; the last two digits is the offset number. You can also press F2 to go to the tool library to select another tool and/or make changes to the tool library. Then, press F10 to accept.

Feedrate: Enter the desired cutting feedrate. You can toggle between feed/min and feed/rev.

Spindle Speed: Enter the desired spindle speed. You can toggle between RPM or CSS. When toggled to RPM, a constant RPM will be maintained. When toggled to CSS, a constant surface speed will be maintained.

Cutter Compensation: Set cutter compensation in Chapter 11 for more details. You can toggle between None, Right and Left.

F2 - Arc

Press the **F2-Arc** to insert an arc operation.

```

Edit Operation
#0060 Arc
Arc Type      : CP&EP
End:          X: 0.5000
              Z: -3.2500
Center:       X: 0.5000
              Z: -3.1250
Direction     : CW
Connect Radius : 0.0000
Tool Num/Offset : T0101
Feedrate      : 500.0000 f/r
Spindle Speed : 1000 CSS
Cutter Comp   : None

```

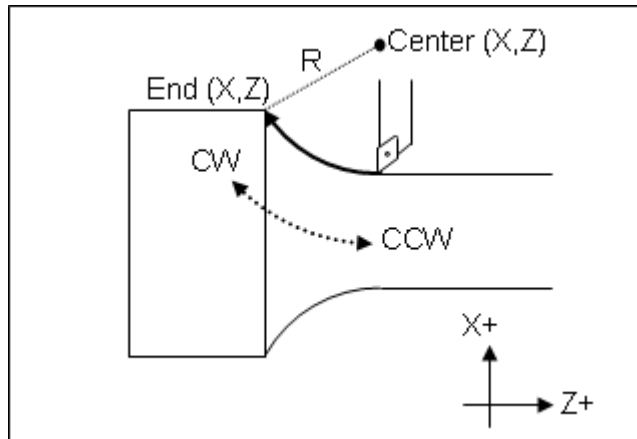

Use the up and down arrow keys to move between fields. Press **F1-Toggle** or **Space** bar to toggle between options when necessary and press **F10-Accept** to accept the information entered. Press **ESC** to cancel and return to the Insert Menu. Press **F3-Modal Display** to hide modal fields. Press this key again to show those fields.

Type: Intercon allows you to specify the arc in one of four ways. You can specify the arc by its end point and radius (EP&R), by its center point and angle (CP&A), by its center point and end point (CP&EP), or by its mid point and end point (3-Point). The fields displayed will depend on the type specified.

EP&R – End Point and Radius

End X: Enter the X coordinate of the end of the arc. You can toggle between absolute and incremental position. When toggled to absolute, enter the absolute position, with reference to the part zero. When toggled to incremental, an INC will appear next to the entry. In this mode, enter the X distance from the preceding end position.

End Z: Enter the Z coordinate of the end of the arc. You can toggle between absolute and incremental position. When toggled to absolute, enter the absolute position, with reference to the part zero. When toggled to incremental, an INC will appear next to the entry. In this mode, enter the Z distance from the preceding end position.

Radius: Enter the radius of the arc. Blend chamfer and chamfer cannot be used to connect to arc or to connect an arc to another item.

Direction: Enter the direction you want the arc to be cut. Toggle between clockwise and counterclockwise.

Connect Radius: Enter the radius to use when blending an arc with another arc or a linear cut. Entering a value in this field will cause the moves to be connected by a rounded corner with this radius.

Tool Num/Offset: Enter the tool number and offset number you want to use. The first two digits is the tool number; the last two digits is the offset number.

Feedrate: Enter the desired cutting feedrate. You can toggle between feed/min and feed/rev.

Spindle Speed: Enter the desired spindle speed. You can toggle between RPM or CSS. When toggled to RPM, a constant RPM will be maintained. When toggled to CSS, a constant surface speed will be maintained.

Cutter Compensation: Set cutter compensation in Chapter 11 for more details. You can toggle between None, Right and Left.

CP&A – Center Point and Angle

Center X: Enter the X coordinate of the center of the arc. You can toggle between absolute and incremental position. When toggled to absolute, enter the absolute position, with reference to the part zero. When toggled to incremental, an INC will appear next to the entry. In this mode, enter the X distance from the last point.

Center Z: Enter the Z coordinate of the center of the arc. You can toggle between absolute and incremental position. When toggled to absolute, enter the absolute position, with reference to the part zero. When toggled to incremental, an INC will appear next to the entry. In this mode, enter the Z distance from the last point.

Angle: Enter the angle of the arc.

Direction: Enter the direction you want the arc to be cut. Toggle between clockwise and counterclockwise.

Connect Radius: Enter the radius to use when blending an arc with a linear cut or another type of arc. Entering a value in this field will cause the arc and a linear move to be connected by a rounded corner with this radius.

Tool Num/Offset: Enter the tool number and offset number you want to use. The first two digits is the tool number; the last two digits is the offset number.

Feedrate: Enter the desired cutting feedrate. You can toggle between feed/min and feed/rev.

Spindle Speed: Enter the desired spindle speed. You can toggle between RPM or CSS. When toggled to RPM, a constant RPM will be maintained. When toggled to CSS, a constant surface speed will be maintained.

Cutter Compensation: Set cutter compensation in Chapter 11 for more details. You can toggle between None, Right and Left.

CP&EP – Center Point and End Point

End X: Enter the X coordinate of the end of the arc. You can toggle between absolute and incremental position. When toggled to absolute, enter the absolute position, with reference to the part zero. When toggled to incremental, an INC will appear next to the entry. In this mode, enter the X distance from the last point.

End Z: Enter the Z coordinate of the end of the arc. You can toggle between absolute and incremental position. When toggled to absolute, enter the absolute position, with reference to the part zero. When toggled to incremental, an INC will appear next to the entry. In this mode, enter the Z distance from the last point.

Center X: Enter the X coordinate of the center of the arc. You can toggle between absolute and incremental position. When toggled to absolute, enter the absolute position, with reference to the part zero. When toggled to incremental, an INC will appear next to the entry. In this mode, enter the X distance from the last point.

Center Z: Enter the Z coordinate of the center of the arc. You can toggle between absolute and incremental position. When toggled to absolute, enter the absolute position, with reference to the part zero. When toggled to incremental, an INC will appear next to the entry. In this mode, enter the Z distance from the last point.

Direction: Enter the direction you want the arc to be cut. Toggle between clockwise and counterclockwise.

Connect Radius: Enter the radius to use when blending an arc with a linear cut or another type of arc. Entering a value in this field will cause the arc and a linear move to be connected by a rounded corner with this radius.

Tool Num/Offset: Enter the tool number and offset number you want to use. The first two digits is the tool number; the last two digits is the offset number.

Feedrate: Enter the desired cutting feedrate. You can toggle between feed/min and feed/rev.

Spindle Speed: Enter the desired spindle speed. You can toggle between RPM or CSS. When toggled to RPM, a constant RPM will be maintained. When toggled to CSS, a constant surface speed will be maintained.

Cutter Compensation: Set cutter compensation in Chapter 11 for more details. You can toggle between None, Right and Left.

3-POINT (Start Point, Mid Point, and End Point)

Mid X: Enter the X coordinate of a point on the arc between the start point and the end point. You can toggle between absolute and incremental position. When toggled to absolute, enter the absolute position, with reference to the part zero. When toggled to incremental, an INC will appear next to the entry. In this mode, enter the X distance from the last point.

Mid Z: Enter the Z coordinate of a point on the arc between the start point and the end point. You can toggle between absolute and incremental position. When toggled to absolute, enter the absolute position, with reference to the part zero. When toggled to incremental, an INC will appear next to the entry. In this mode, enter the Z distance from the last point.

End X: Enter the X coordinate of the end of the arc. You can toggle between absolute and incremental position. When toggled to absolute, enter the absolute position, with reference to the part zero. When toggled to incremental, an INC will appear next to the entry. In this mode, enter the X distance from the last point.

End Z: Enter the Z coordinate of the end of the arc. You can toggle between absolute and incremental position. When toggled to absolute, enter the absolute position, with reference to the part zero. When toggled to incremental, an INC will appear next to the entry. In this mode, enter the Z distance from the last point.

Direction: Enter the direction you want the arc to be cut. Toggle between clockwise and counterclockwise.

Connect Radius: Enter the radius to use when blending an arc with a linear cut or another type of arc. Entering a value in this field will cause the arc and a linear move to be connected by a rounded corner with this radius.

Tool Num/Offset: Enter the tool number and offset number you want to use. The first two digits is the tool number; the last two digits is the offset number.

Feedrate: Enter the desired cutting feedrate. You can toggle between feed/min and feed/rev.

Spindle Speed: Enter the desired spindle speed. You can toggle between RPM or CSS. When toggled to RPM, a constant RPM will be maintained. When toggled to CSS, a constant surface speed will be maintained.

Cutter Compensation: Set cutter compensation in Chapter 11 for more details. You can toggle between None, Right and Left.

F3 - Drill

Press the **F3-Drill** key to insert a Drill operation. This operation allows you to either do normal Drilling or off-center Boring operations. Both the Drilling and Boring type operations are actually the same, except in the types of tools used and position X field.

N0050 Drill	
Type	: Drill
Position	X: 0.0000
Z Surface Height	: 0.0000
Depth	Z: 0.0000 INC
Depth Increment	: 0.1000
Retract Amount	: 0.0100
Rapid Clearance	: 0.1000
Dwell Time	: 0.0000
Tool Num/Offset	: T0000
Plunge Rate	: 0.0000 F/M
Spindle Speed	: 0 RPM
Pre/Post Cycle Pos.	: Approach & Retract
AP/RT Position	X: 0.0000
AP/RT Position	Z: 0.1000

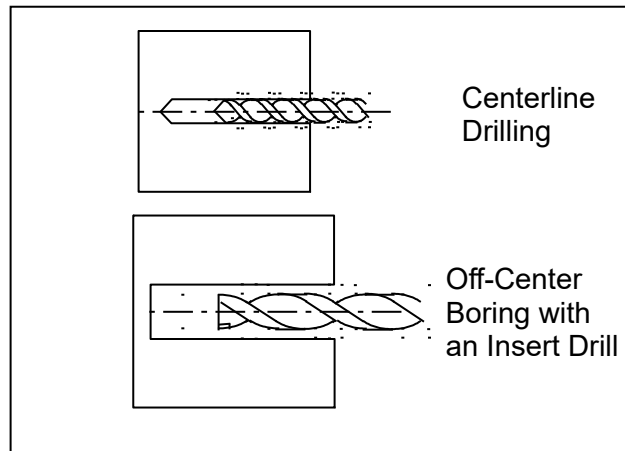

Press **F1-Type** to toggle between Bore and Drill and their various options (i.e. peck, & deep hole). If the operation is toggled into Bore mode, then you can modify the Position X coordinate, which can be specified to be off-center (usually by the tool diameter).

NOTE: Insert drills and end mills can be used to drill and bore holes into a part. In order to bore with a specific tool, it will need an offset value for that tool so diameters can be controlled. If for example a .750 diameter insert drill is used to drill a hole in a part, but the final diameter of the hole needs to be 1.250, toggle to the boring cycle and for Position X enter .750. This will offset the center of the drill to the center of the part. After the hole is in the part, use a profile or a turning cycle to finish the hole to the 1.250 diameter, using the same tool.

Press **F1-Type** to toggle between options when necessary and the **F10-Accept** key to accept the entries. Use the up and down arrow keys to move between fields. Press **ESC** to cancel and return to the Intercon Main Menu.

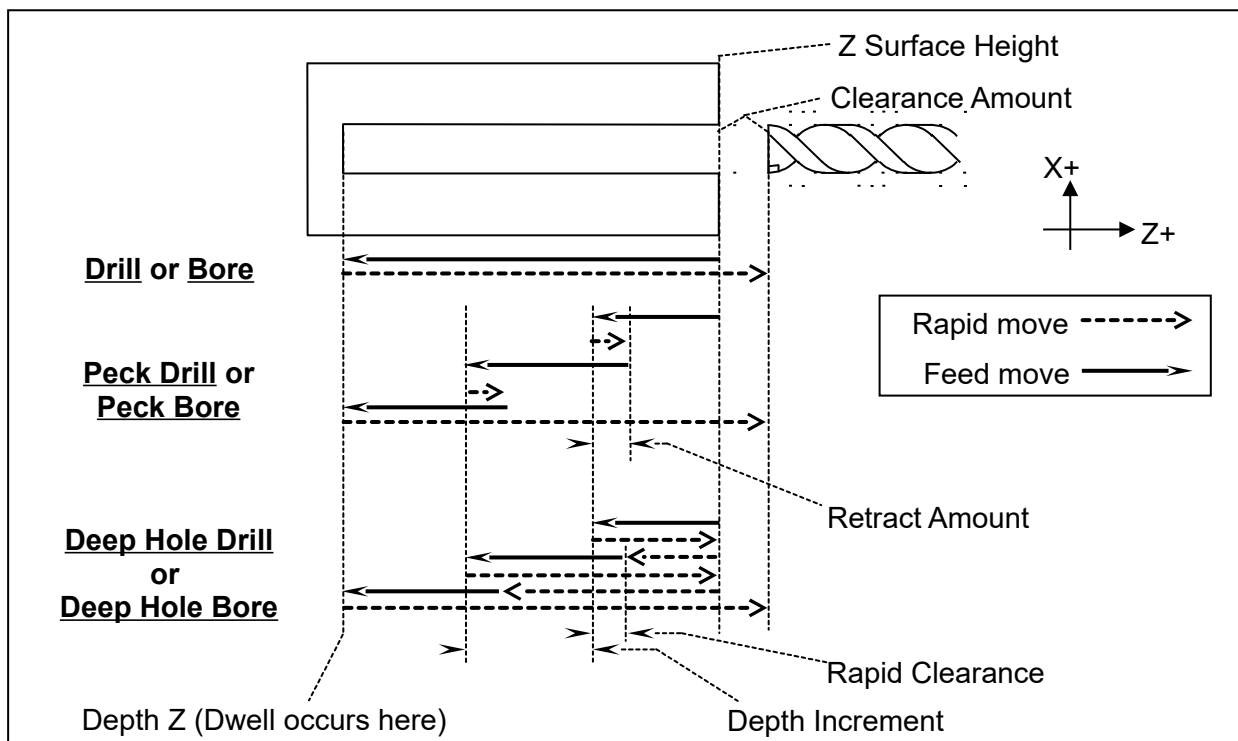

Surface Z: Enter the position of the front face of the work piece.

Type: Enter the type of Drilling or Boring you want to perform. You can toggle between Drill, Peck Drill, and Deep Hole Drill, Bore, Peck Bore, Deep Bore using the **F1-Type** key.

Position X: (Valid only while in Bore mode) Enter the diameter for the tool being used.

Depth Z: Enter the depth of the hole to drill. This is the Z distance from the surface height.

Depth Increment: Enter the cut depth increment used during the cycle. This field only applies when the type field has been set to Peck Drill, Deep Hole Drill, Peck Bore, or Deep Hole Bore.

Retract Amount: Enter the amount the drill should retract before making another incremental depth cut. This field only applies when the type field has been set to Peck Drill or Peck Bore.

Rapid Clearance Enter the amount above the uncut material the drill will rapid to on subsequent cuts. This field only applies when the type field has been set to Deep Hole Drill or Deep Hole Bore

Dwell Time: Enter the amount of time in seconds that the drill should dwell at the bottom of the hole.

Tool Num/Offset: Enter the tool number and offset number you want to use. The first two digits is the tool number; the last two digits is the offset number.

Plunge Rate: Enter the feedrate at which you want to drill the hole. Toggle between feed/min and feed/rev.

Spindle Speed: Enter the spindle speed in RPM

Pre/Post Cycle Pos.: Allows you to select if you want to move to a specified position before the cycle and/or a position after the cycle. Once toggled from "None" 2 fields appear to enter the desired position.

F4 - Tap

The tap operation allows you to tap into the parts centerline (cutting in the negative Z direction). The operation may use a floating tap holder or rigid tap, with spindle reversal, or a self-reversing tap head. Press the **F4-Tap** key to insert a center tapping operation.

```
N0020 Tap
Head Type      : Rigid
Z Surface Height : 0.0000
Depth          Z: 0.5000 INC
Threads / Inch : 12.0000
Thread Lead    : 0.0833
Dwell Time     : 0.0000
Tool Num/Offset : T0202
Spindle Speed  : 500 RPM
Pre/Post Cycle Pos. : None
```

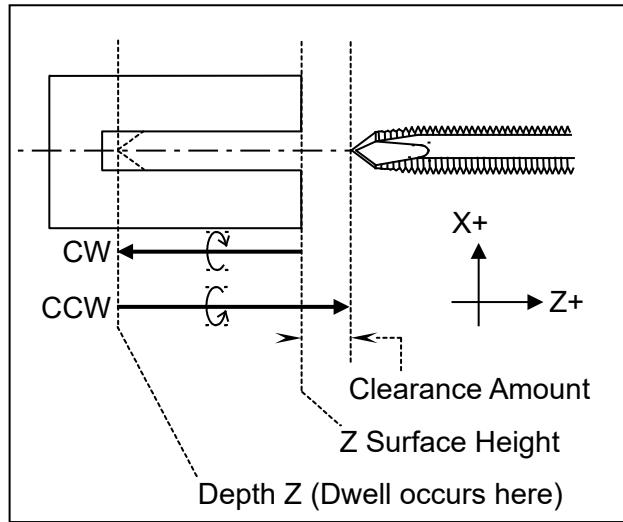

Press the **F1-Type** key to toggle between options when necessary and the **F10-Accept** key to accept entries. Use the up and down arrow keys to move between fields. Press the **Esc** key to cancel and return to the Insert Menu.

Tap Head Type: Enter the type of tap head you will be using. You can toggle between floating and reversing.

Z Surface Height: Enter the Z position of the surface you are tapping.

Depth Z: Enter the depth of the hole you want to tap. You can toggle between absolute Z and an incremental value from the parts surface. This is the Z distance from the surface height.

Thread Pitch: Enter the desired threads/unit.

Thread Lead: Enter the desired units/thread.

Dwell Time: Enter the time in seconds the tap should dwell at the bottom of the hole. This is to allow time for the spindle to reverse rotational direction. Used for Floating Tap only.

Tool Num/Offset: Enter the tool number and offset number you want to use. The first two digits is the tool number; the last two digits is the offset number.

Spindle Speed: Enter the spindle speed in RPM. A constant RPM value will be maintained.

Pre/Post Cycle Pos.: Allows you to select if you want to move to a specified position before the cycle and/or a position after the cycle. Once toggled from "None" 2 fields appear to enter the desired position.

F5 - Thread

Press the **F5-Thread** key to insert a threading cycle. This cycle allows you to create a thread on the outside or inside of your part. When you first insert a threading cycle, the screen looks something like the picture below.

N0002 Thread Cycle			
Thread Type	:	External	
Designation	:		
Class	:		
Thread Face	Z:	0.0000	
Ending	Z:	0.0000	
Minimum Cut Depth	:	0.0010	
First Cut Depth	:	0.0100	
Tool Number	:	T 0303	
Spindle Speed	:	0	RPM
Finish Pass Amt.	:	0.0000	
Num Spring Passes	:	1	
Pre/Post Cycle Pos.	:	None	
Press "Details" for more.			

Press **F7-Details** to skip thread lookup and manually enter custom thread data. Press the **F1-Type** key to toggle between options when necessary and the **F10-Accept** key to accept the entries. Use the up and down arrow keys to move between fields. Press the **ESC** key to cancel and return to the Insert Menu.

Thread Lookup

This cycle has a lookup feature that simplifies the process of creating threads. The data for standard threads have been entered into a database. You can add custom threads to this database. You can recall any previously stored thread by specifying a few key criteria:

Thread Type: Enter the thread type desired. Toggle between external, internal, external pipe, internal pipe. You can view database entries for internal/external or pipe threads but not both at the same time.

Designation: Type any part of the beginning of a standard or custom designation to view a list of matching database entries. Leave blank to match all entries from the database. To See Metric types, type M in this field.

Class: Type any part of the beginning of the class to view matching entries. Leave blank to match all classes.

When you have typed anything in Designation or Class, the screen will display the first matching entries. For example, typing "10" in the Designation field would show all entries in the database whose designations start with "10". If there is only one thread listed, simply press Enter to select it. If more than one is listed, you can choose any thread shown by using the arrow keys to move up and down in the list. If the cursor is somewhere in the thread list, you can press Page Up or Page Down to change to a different page of the thread list. When the desired thread is highlighted, press Enter to accept. Below left is an example of selecting from the list. Below right is an example of accepting the single match.

```

N0002 Thread Cycle

Thread Type      : External
Designation     : 10
Class           :

Designation      Class
10-24 UNC       2A
10-24 UNC       3A
10-28 UNS       2A
10-32 UNF       2A
10-32 UNF       3A
10-36 UNS       2A
10-40 UNS       2A
10-48 UNS       2A
10-56 UNS       2A
Showing 1 to 9 of 9 matches.

Enter search criteria, select a thread.

```

```

N0002 Thread Cycle

Thread Type      : External
Designation     : 10-40
Class           :

Designation      Class
10-40 UNS       2A
One match. Press Enter to accept.

Enter search criteria, select a thread.

```

When you press Enter, you can view the thread details. The fields will have been filled in with the values from the selected thread.

```

N0002 Thread Cycle

Thread Type      : External
Designation     : 10-40 UNS
Class           : 2A
Thread Angle    : 55.0000 °
Threads / Inch  : 40.0000
Thread Lead     : 0.0250
Major Diameter  : 0.1865
Minor Diameter  : 0.1592
Chamfer Amount  : 0.0000
Taper Amount    : 0.0000
Taper Angle     : 0.0000 °
Clearance       Z: 0.0000 INC

Press "Main" to return.

```

```

*10-40 UNS Custom
* Custom thread -- not saved.

```

You can modify any of the values, if desired. If you do, an asterisk (*) will appear next to the Designation field and it will be appended with "Custom". You may change the designation and class fields to any name that you wish. Press **F4-Save** to save the new thread in the database. If the designation and class already exist, you will be prompted to overwrite the values.

Thread (Compound) Angle: Enter the desired thread compound angle to shift the chip load to be heavier towards one side of the thread cutter. A thread compound angle of 0 means that the chip load will be even on both sides of the thread cutter. A typical value is 55°. The default value is taken from parameter 51. (See Chapter 14.)

Threads/Unit: Enter the number of threads per inch or threads per millimeter you want to cut. This field affects the Thread Lead field.

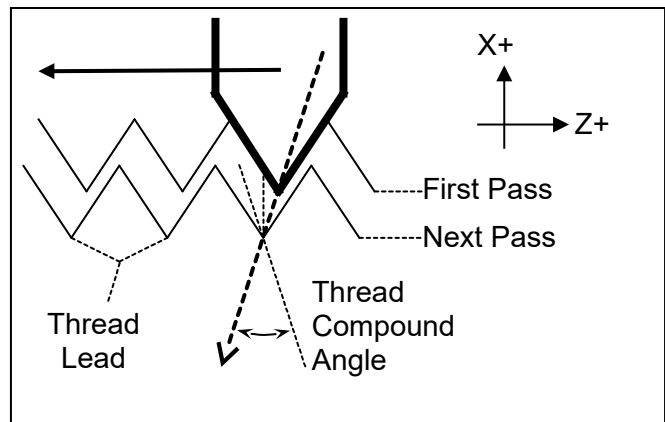

Thread Lead: Enter the width of a thread for one complete turn. This field affects the threads/unit entry.

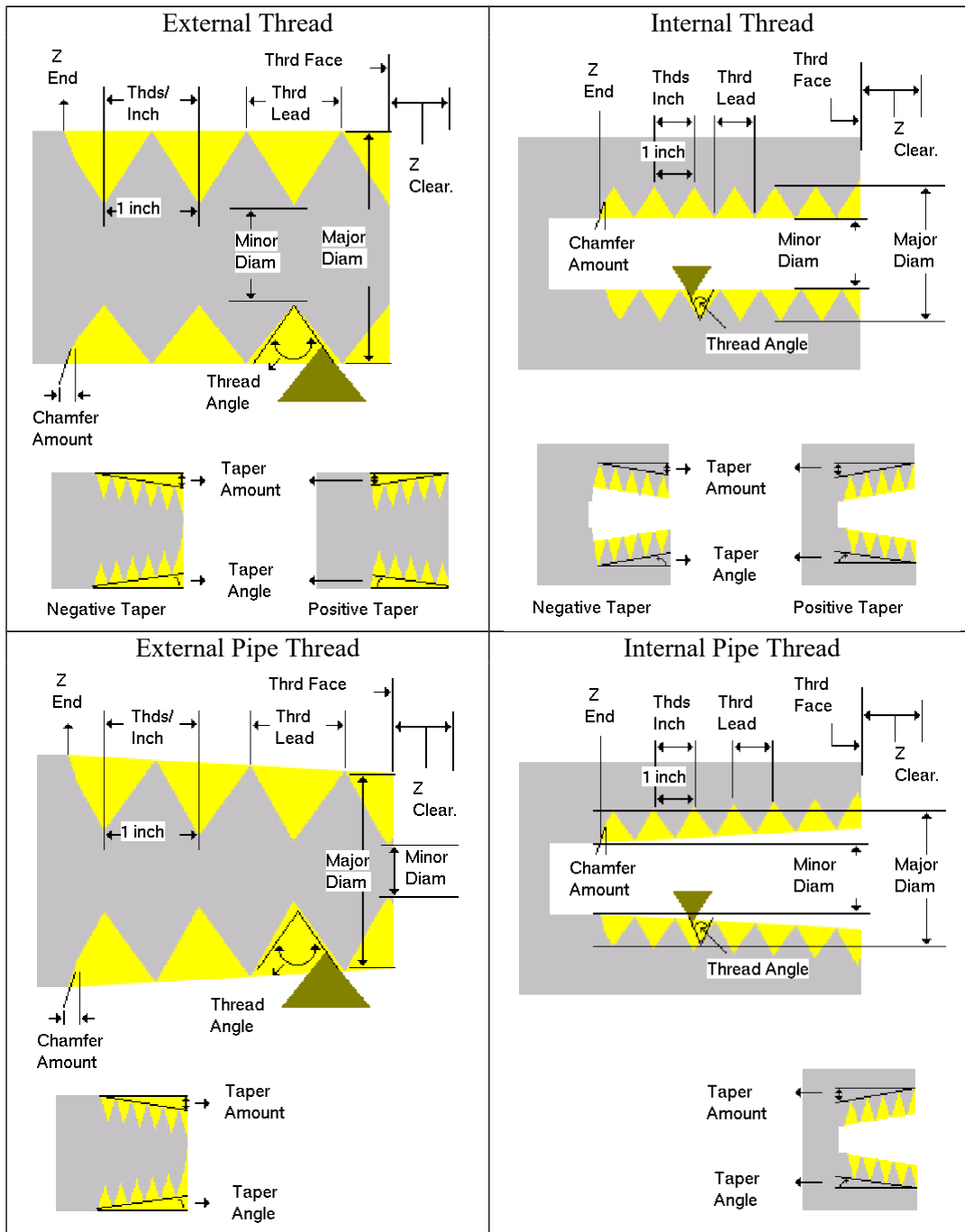

Major Diameter: Enter the major diameter of the thread you want to cut.

Minor Diameter: Enter the minor diameter of the thread you want to cut.

Note: Non-pipe threads are referenced at the thread face. Pipe thread diameters are referenced according to ANSI/ASME B1.20.1-193 (R1992). External pipe threads are referenced at E_0 , the diameter at the external thread face. For internal pipe threads, this is E_3 , the diameter at the end of the wrench make-up length (3 turns past the nominal diameter of the external pipe thread.) For external and internal pipe threads, this should be the smallest diameter on the taper.

Chamfer Amount: Enter the number of turns to take to withdraw the tool from the maximum depth to the surface. This produces a thread that tapers to the surface.

Taper Amount: Enter the amount the surface rises over the length of the surface you want to thread – normally negative amount for external, positive amount for internal. This field affects the thread angle field. For pipe threads, this value is calculated from the preset angle of 1.2812 degrees.

Taper Angle: Enter the angle that the surface tapers to – normally negative angle for external, positive angle for internal. This field affects the taper amount entry. The taper angle of pipe threads is preset at 1.2812 degrees.

Clearance Z: Enter a clearance amount, or “run-up” distance from the thread face. This clearance helps get the cutting tool is up to speed before it contacts the thread face.

The main screen contains the following fields:

Thread Face Z: Enter the Z coordinate where the threading tool will first make contact with the thread. (Use the Clearance Z field to get a run-up to this point.)

Ending Z: Enter the Z coordinate for the end of the threading cycle.

Minimum Cut Depth: Enter the minimum amount of material to remove during a pass. The threading cycle will remove larger amounts of material initially but will work down to this value.

First Cut Depth: Enter the amount of material to be removed during the first cut.

Tool Num/Offset: Enter the tool number and offset number you want to use. The first two digits is the tool number; the last two digits is the offset number.

Spindle Speed: Enter the desired spindle speed for the threading cycle. You can toggle between RPM or CSS. When toggled to RPM, a constant RPM will be maintained. When toggled to CSS, a constant surface speed will be maintained.

Finish Pass Amount: Enter the amount of material to leave for a finishing pass.

Num Spring Passes: Enter the number of passes to make at the finish diameter.

Pre/Post Cycle Pos.: Allows you to select if you want to move to a specified position before the cycle and/or a position after the cycle. Once toggled from “None” 2 fields appear to enter the desired position.

F6 - Profile

Press the **F6-Profile** key to insert a profile.

The profile operation allows you to define a profile with lines and arcs that will be produced with a cleanout cycle.
NOTE: Do not move Z until the 2nd line of the profile to avoid over and under cutting of part.

```

Edit Operation
#0030 Profile Cycle

Profile type      : Diameter
Start:           X: 1.5000
Start:           Z: 0.0000
Depth of cut     : 0.0500
Rough tool       : T0101
Rough feedrate   : 0.1000 f/r
Rough spin speed : 700 CSS
Stock to leave   X: 0.0100
Stock to leave   Z: 0.0200
Cutter Comp      : None
Rapid Between Cuts: Yes

```

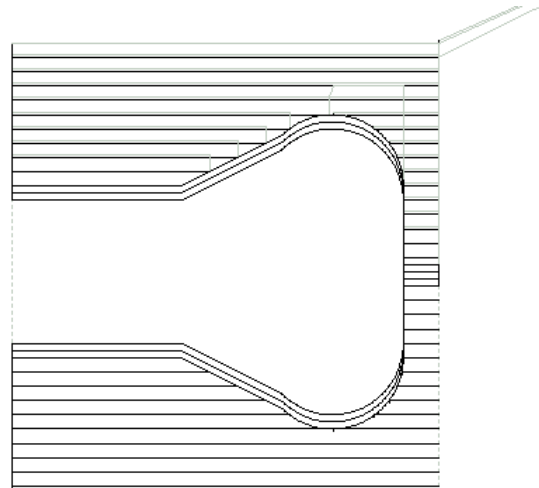

Example Profile

Press the **F1-Type** key to toggle between options when necessary. When at least one operation is present in the profile, you can press the **F10-Accept** to accept the profile.

Profile Type: Enter the type of profile you want to produce. Toggle between diameter and end face. Choosing diameter will cause the cleanout cycle to be performed along the diameter while choosing end face will cause the cleanout cycle to be performed along the face.

Start X: Enter the X coordinate of the start of the profile. Allow for clearance.

Start Z: Enter the Z coordinate of the start of the profile. Allow for clearance.

Start X and Start Z are where the tool rapids to before it starts the cleanout cycle.

● NOTE: Intercon determines whether the cleanout cycle is external or internal by the start position of the profile and the end position of the first move in the profile. If the end position of the first move is lower than the start position of the profile, the cleanout cycle is external. For external cleanout cycles, all profile operations must be lower than the start point. If the end position of the first move is higher than the start position of the profile, the cleanout cycle is internal. For internal cleanout operations, all profile operations must be higher than the start point.

Depth of Cut: Enter the amount to remove per pass per side in the cleanout cycle.

Rough Tool: Enter the tool number and offset number you want to use during the roughing portion of the cleanout cycle. The first two digits is the tool number; the last two digits is the offset number.

Rough Feedrate: Enter the desired feedrate for the roughing portion of the cycle. You can toggle between Feed Per Revolution (f/r) or Feed Per Minute (f/m). Note that this Rough Feedrate is different from the Finish Feedrates specified within each of the Line and Arc operations inside the profile.

Rough Spin Speed: Enter the desired spindle speed for the roughing portion of the cycle. You can toggle between RPM or CSS. When toggled to RPM, a constant RPM will be maintained. When toggled to CSS, a constant surface speed will be maintained. Note that this Rough Spin Speed is different from the Finish Spindle Speeds specified within each of the Line and Arc operations inside the profile.

Stock to Leave X: Enter the amount of stock to leave on the X-axis to be removed by the finishing pass(es).

Stock to Leave Z: Enter the amount of stock to leave on the Z-axis to be removed by the finishing pass(es).

Cutter Compensation: Set cutter compensation in Chapter 11 for more details. You can toggle between None, Right and Left.

After entering these fields, define the profile you want to cut out with lines and arcs. Intercon allows you to insert Lines, Arcs, and Finish Passes within a profile. Lines and Arcs are described earlier. The Finish Pass is described later.

Rapid Between Cuts: Choose whether or not the moves between rough passes are to be done as Rapid or Feedrate. You can toggle between Yes and No.

- NOTE: The Spindle Speeds and Feedrates specified within each of the individual Line and Arc operations inside the profile are not used by the roughing portion of the cycle. However they will later be utilized by the Finish Pass, if it is defined.

Finish Pass (For Profiles Only)

Intercon Lathe				Current Part: DEMO.LTH	
Operation				N0110 Finish Pass	
#	Type	End X(D)	Z	Tool	
0010	;Demo program				
0020	Rapid	3.0000	3.0000	01	Start Block : N0040
0030	Profile	3.0000	3.0000	01	End Block : N0100
0040	Linear	0.0000	3.0000	01	Depth of Cut X: 0.0000
0050	Linear	0.0000	2.7500	01	Z: 0.0500
0060	Linear	1.0000	2.7500	01	Tool Num/Offset : T0101
0070	Arc CCW, CR	2.0000	2.2500	01	Cutter Comp : None
0080	Arc CCW, CR	1.7001	1.8964	01	
0090	Linear	1.0000	1.1893	01	
0100	Linear	1.0000	0.0000	01	
0110					
0120	Profile End	3.0000	3.0000	01	
0130	End Prog	3.0000	3.0000	01	

Tool F2	Help F5	Math Help F6	Graph F8	Teach Mode F9	Accept F10
------------	------------	-----------------	-------------	------------------	---------------

The Finish Pass is a special operation that only applies to profiles. At least two operations must be present in the profile before you can insert a finishing pass. Multiple finishing passes can be inserted. Once a finish pass is inserted, you can no longer make changes in the profile without going back out to the Insert Operations Menu.

- NOTE: The number of passes made for a finish operation is determined by the greater of
 Stock to leave x (Profile Operation) OR stock to leave z (Profile Operation)
 Depth of cut x (Finish Operation) depth of cut z (Finish Operation)

Start Block: Enter the block number in the profile that the finishing pass should start on.

End Block: Enter the block number in the profile that the finishing pass should end on.

Depth of Cut Z: Enter the amount of material to remove from the Z-axis per pass. 0 will be one pass.

Depth of Cut X: Enter the amount of material to remove from the X-axis per pass. 0 will be one pass

- If both are 0, there will only be one pass.

Tool Num/Offset: Enter the tool number and offset number you want to use for the finish pass. The first two digits is the tool number; the last two digits is the offset number. This field is disabled if G28 is not used for tool changes.

Cutter Compensation: Set cutter compensation in Chapter 11 for more details. You can toggle between None, Right and Left.

- NOTE: The Spindle Speeds and Feedrates specified within each of the individual Line and Arc operations defined inside the profile will determine the Spindle Speeds and Feedrates for the Finish Pass. That is why there is no way to specify a Spindle Speed or Feedrate on the Finish Pass Operation page.

F7 – Turning

A turning cycle is a repetitive cycle used to cut an outside or inside diameter to a specified dimension within a program. To insert a turning cycle into your part program.

N0020 Turning Cycle	
Turning Type	: Diameter
Starting Diameter	: 3.0000
Ending Diameter	: 1.5000
Starting Z:	0.1000
Ending Z:	-2.0000
Taper Amount	: 0.0000
Taper Angle	: 0.00°
Depth of Cut	: 0.0500
Rough Tool	: T0101
Rough Feedrate	: 0.0500 F/R
Rough Spin Speed	: 450 CSS
Finish Pass Amt.	: 0.0000
Finish Tool	: T0101
Finish Feedrate	: 0.2500 F/R
Finish Spin Speed	: 550 CSS
Cutter Comp	: None
Return Feed Amt.	: 0.0000
Pre/Post Cycle Pos.	: Retract
Retract Position X:	0.0000
Retract Position Z:	0.0000

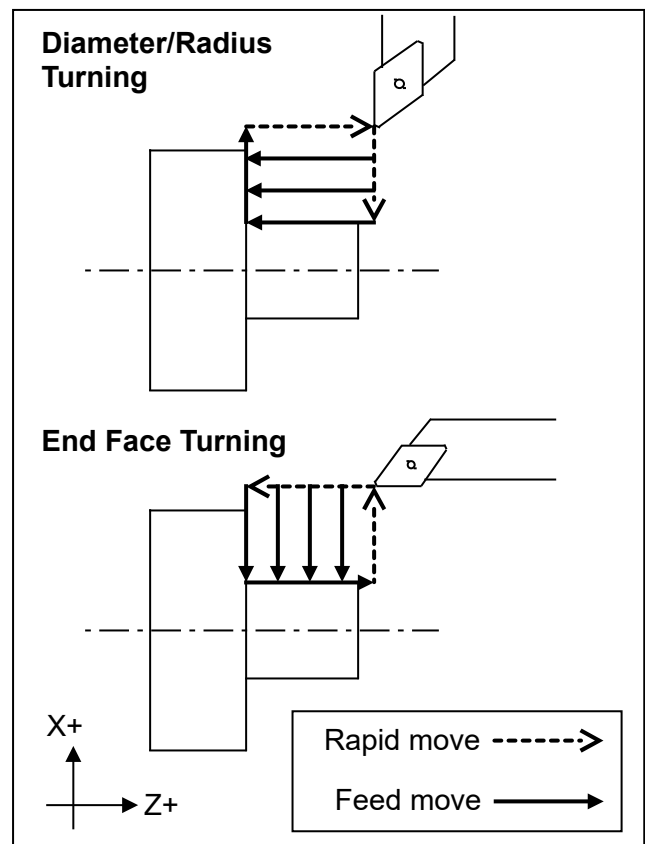

Press the **F1-Type** key to toggle between options when necessary and the **F10-Accept** key to accept the entries. Use the **up** and **down** arrow keys to move between fields. Press the **ESC** key to cancel and return to the Insert menu.

Turning Type: Enter the type of turning you want to use. Toggle between diameter/radius and end face. Choosing diameter/radius will cause the cycle to remove material in a direction parallel to the Z-axis, along the diameter or radius. Choosing end face will cause the cycle to remove material in a direction parallel to the X-axis, along the face.

Starting Diameter/Radius: Enter the diameter at which you want the cycle to start.

Ending Diameter/Radius: Enter the diameter at which you want the cycle to finish.

● **NOTE:** When turning an inside diameter, the starting diameter must be less than the ending diameter. When turning an outside diameter, the starting diameter must be greater than the ending diameter.

Starting Z: Enter the starting Z value for the turning cycle.

Ending Z: Enter the ending Z value for the turning cycle.

Taper Amount: Enter the amount that you want to taper from the starting diameter to the ending diameter. This entry affects the taper angle. For diameter turning, enter a positive value to taper from the ending diameter + taper amount to the ending diameter. Enter a negative value to taper from the ending diameter - taper amount to the ending diameter amount. For end face turning, enter a positive value to taper from end Z taper + taper amount to end Z. Enter a negative value to taper from end Z- taper amount to end Z.

- NOTE: The taper amount must be less than the depth of cut.

Taper Angle: Enter the angle you want to use to taper. This angle is used to determine the taper amount. For diameter turning, enter a positive value to taper from the ending diameter + taper amount to the ending diameter. Enter a negative value to taper from the ending diameter - taper amount to the ending diameter amount. For end face turning, enter a positive value to taper from end Z taper + taper amount to end Z. Enter a negative value to taper from end Z- taper amount to end Z.

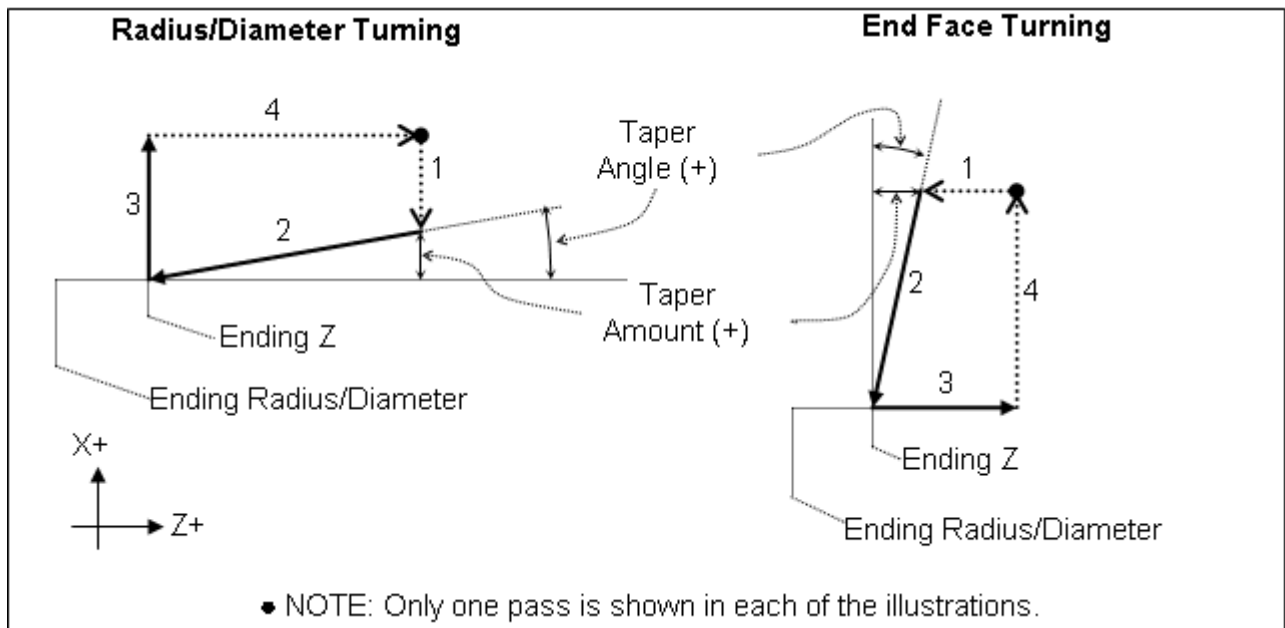

Depth of Cut: Enter the amount to remove per pass

Rough Tool: Enter the tool and offset number to use for the roughing portion of the cycle. The first two digits is the tool number; the last two digits is the offset number.

Rough Feedrate: Enter the cutting feedrate for the roughing portion of the cycle. You can toggle between feed/min and feed/rev.

Rough Spin Speed: Enter the spindle speed for the roughing portion of the cycle. You can toggle between RPM and CSS. When toggled to RPM, a constant RPM will be maintained. When toggled to CSS, a constant surface speed will be maintained.

Finish Pass Amount: Enter the amount you want the roughing portion of the cycle to leave to be removed by the finish pass. This is a radial amount. If the amount entered is zero, a finish pass will not be performed.

Finish Tool: Enter the tool and offset to use during the finishing pass. The first two digits is the tool number; the last two digits is the offset number. This field is disabled if G28 is not used for tool changes.

Finish Feedrate: Enter the cutting feedrate for the finishing pass. You can toggle between feed/min and feed/rev.

Finish Spin Speed: Enter the spindle speed for the finishing pass. You can toggle between RPM and CSS. When toggled to RPM, a constant RPM will be maintained. When toggled to CSS, a constant surface speed will be maintained.

Cutter Compensation: Set cutter compensation in Chapter 11 for more details. You can toggle between None, Right and Left.

Return Feed Amount: This is a special field that activates 3-sided turning. If the value is 0, then the normal 2-sided turning will be performed. If this value is more than 0, then 3-sided turning will be performed. On 3-sided turning, this field specifies the length of the returning feedrate move.

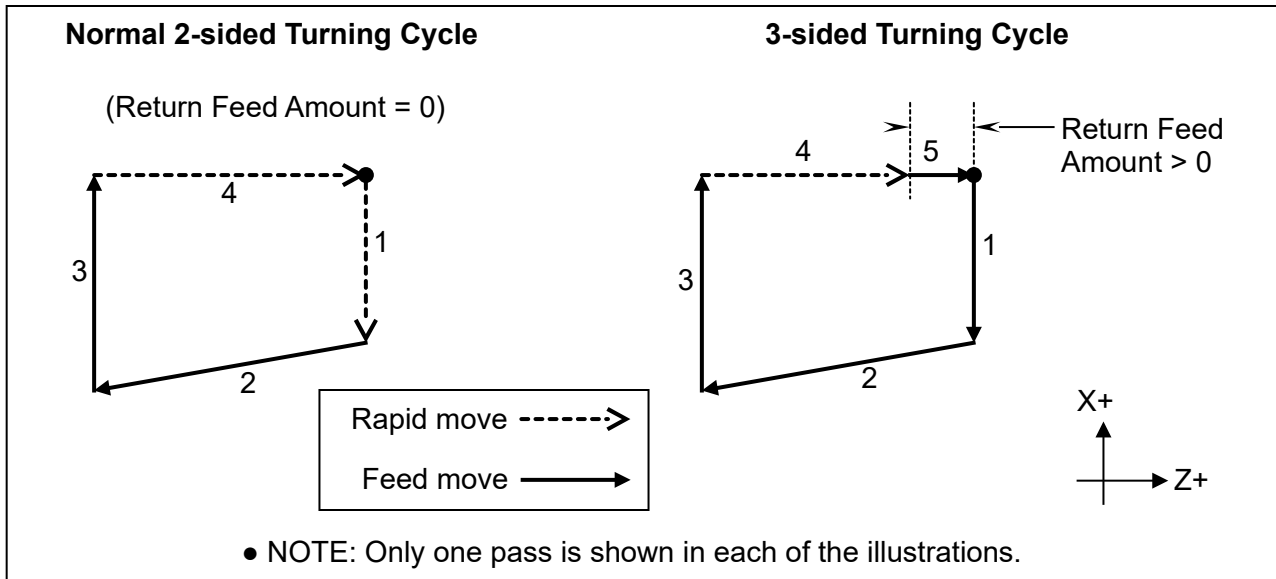

Pre/Post Cycle Pos.: Allows you to select if you want to move to a specified position before the cycle and/or a position after the cycle. Once toggled from "None" 2 fields appear to enter the desired position.

F8 - Groove

N0030 Grooving Cycle	
Type	: Outside
Diameter	
Start	: 3.0000
End	: 1.2500
Increment	: 0.1000
Width	
Start	Z: -3.1000
End	Z: -3.5000
Increment	Z: 0.0500
Corner Finish	: BI Chamf (Len)
Corner Radius	: 0.0000
Chamfer Length	: 0.0500
Rough Tool	: T0202
Rough Feedrate	: 0.0500 F/R
Rough Spin Speed	: 450 CSS
Finish Pass Amt.	: 0.1000
Finish Tool	: T0202
Finish Feedrate	: 0.0500 F/R
Finish Spin Speed	: 500 CSS
Pre/Post Cycle Pos.	: None

Groove Cut on Outside Diameter

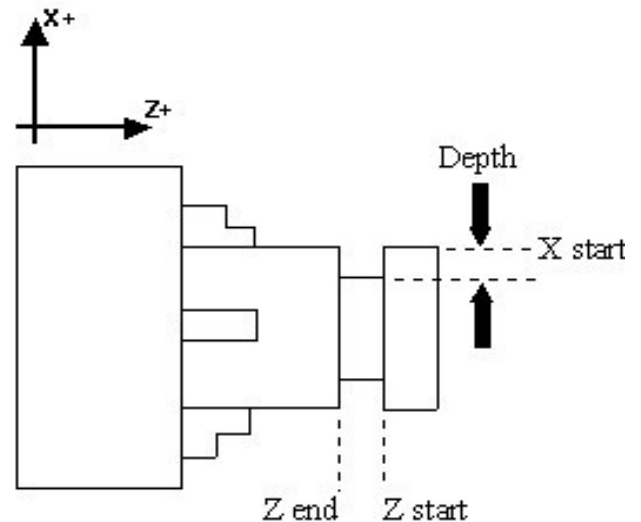

The grooving operation allows you to cut a groove of specified width and depth in a specified location. Press the **F8-Groove** key to insert a grooving operation.

Press the **F1-Type** key to toggle between options when necessary and the **F10-Accept** key to accept the entries. Use the **up** and **down** arrow keys to move between fields. Press the **ESC** key to cancel and return to the Insert menu.

Type: Toggle between four options for the type of grooving. The four options are outside, inside, front and back. Choosing outside will cause the operation to cut the groove on the outside diameter of the work piece. Choosing inside will cause the operation to cut the groove on the inside diameter of the work piece. Choosing front will cause the operation to cut the groove on the front face of the work piece (see example below). Choosing back will cause the operation to cut the groove on the back face of the work piece.

Edit Operation	
#0060 Grooving Cycle	
Type	: Front
Starting	Z: 0.0000
Depth	Z: 0.2000
Depth Increment	Z: 0.2000
Starting diameter	: 1.8000
Ending diameter	: 1.6000
Width Increment	X: 0.1000
Corner Finish	: Square
Corner Radius	: 0.0000
Chamfer Length	: 0.0000
Rough Tool Number	: T0404
Rough Feedrate	: 0.0020 f/r
Rough Spin Speed	: 600 CSS
Finish pass amt.	: 0.0050
Finish Tool Number	: T0404
Finish Feedrate	: 0.0010 f/r
Finish Spin Speed	: 600 CSS

Groove Cut on Face of Part

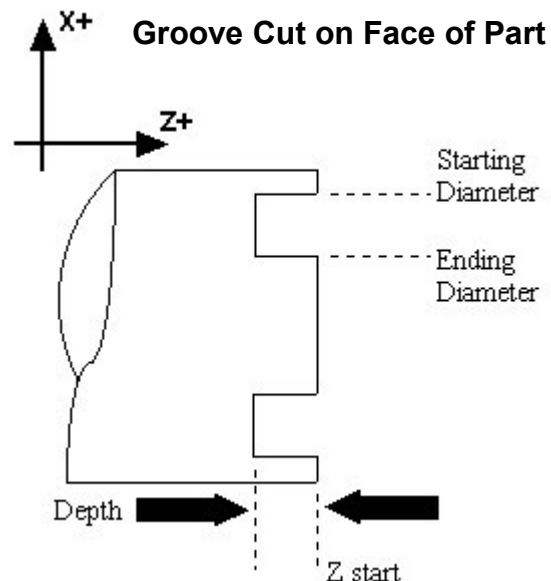

Starting Diameter/Radius: Enter the position of the surface on which the groove will be produced.

Ending Diameter/Radius: Enter the grooves ending dimension.

Depth Increment: Enter the depth increment for the grooving cycle. This is the amount removed per plunge in the peck cutting cycle used to produce the groove.

Starting Z: Enter the starting position of the groove.

Ending Z: Enter the ending position of the groove. For the outside or inside diameter, it will be a Z value. For the front or back face, this will be an X value. You can toggle between absolute and incremental position. When toggled to absolute, enter the absolute position, with reference to the part zero. When toggled to incremental, an INC will appear next to the entry. In this mode, enter the X distance from the last point.

Width Increment: Enter the width increment for the grooving cycle. This is the step over amount for the cleanout cycle used to produce the width.

Corner Finish: Enter the type of corner finish you want. Toggle between square, radius, chamfer (Distance or Length), and blend chamfer (Distance or Length). Shown below is each type of corner that will be produced for the groove.

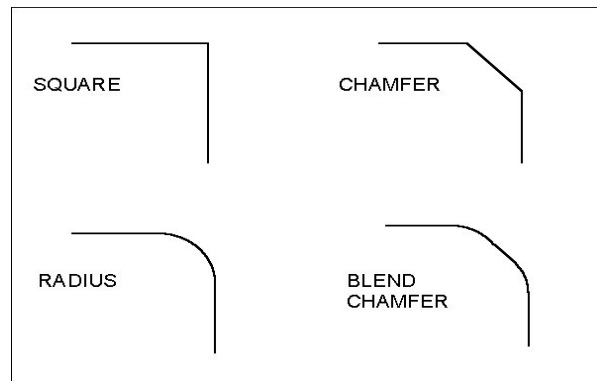

Corner Radius: Enter the radius for the rounded corner when corner finish is set to radius.

Chamfer Distance: Enter the Distance to be removed from the end of each linear segment.

Chamfer Length: Enter the length of the chamfer you want for the corner finish.

Rough Tool Number: Enter the tool number and offset number to use for the roughing portion of the cycle. The first two digits is the tool number; the last two digits is the offset number.

Rough Feedrate: Enter the cutting feedrate for the roughing portion of the cycle. You can toggle between feed/min and feed/rev.

Rough Spin Speed: Enter the spindle speed for the roughing cycle. You can toggle between RPM and CSS. When toggled to RPM, a constant RPM will be maintained. When toggled to CSS, a constant surface speed will be maintained.

Finish Pass Amount: Enter the amount you want the roughing portion of the cycle to leave to be removed by the finish pass. This is a radial amount. If the amount entered is zero, a finish pass will not be performed.

Finish Tool Number: Enter the tool number and offset number to use during the finishing pass. The first two digits is the tool number; the last two digits is the offset number. This field is disabled if G28 is not used for tool changes.

Finish Feedrate: Enter the cutting feedrate for the finishing pass. You can toggle between feed/min and feed/rev.

Finish Spindle: Enter the spindle speed for the finishing pass. You can toggle between RPM and CSS. When toggle to RPM, a constant RPM will be maintained. When toggled to CSS, a constant surface speed will be maintained.

Pre/Post Cycle Pos.: Allows you to select if you want to move to a specified position before the cycle and/or a position after the cycle. Once toggled from “None” 2 fields appear to enter the desired position.

F9 - Cutoff

N0040 Cutoff Cycle	
Type	: Peck
Peck Increment	: 0.1000
Z Position	: -3.7500
Starting Diameter	: 3.0000
Ending Diameter	: -0.0100
Corner Finish	: Bl Chamf (Len)
Corner Radius	: 0.0000
Chamfer Length	: 0.1000
Tool Num/Offset	: T0202
Feedrate	: 0.0500 F/R
Spindle Speed	: 500 CSS
Pre/Post Cycle Pos.	: Retract
Retract Position	X: 0.0000
Retract Position	Z: 0.0000

The cutoff operation allows you to cut off the part with a cutoff tool.

Press the **F1-Type** key to toggle between options when necessary and the **F10-Accept** key to save changes. Use the **up** and **down** arrow keys to move between fields. Press the **ESC** key to cancel and return to the Insert Menu.

Type: Enter the type of cut to cut off the work piece. You can toggle between continuous and peck. Choosing continuous will cause the work piece to be cutoff with a continuous cut. Choosing peck will cause the work piece to be cutoff in incremental moves.

Peck Increment: When the type field is set to peck, enter the increment amount used in cutting the part off. When the

type field is set to continuous, this field will not be shown.

Z position: Enter the Z position of the cut.

Starting Diameter: Enter the diameter at which the cutoff is to start.

Ending Diameter: Enter the diameter at which the cutoff is to finish.

Corner Finish: Enter the type of corner finish you want. Toggle between square, radius, chamfer (Distance or Length), and blend chamfer (Distance or Length). Shown below is each type of corner that will be produced for the cutoff. Corner finish will be on the start diameter.

Corner Radius: Enter the radius of the corner you want for the corner finish. This field is only shown when radius is chosen for the corner finish.

Chamfer Distance: Enter the Distance to be removed from the end of each linear segment.

Chamfer Length: Enter the length of the chamfer you want for the corner finish. This field is only shown when chamfer is chosen for corner finish.

Tool Num/Offset: Enter the tool number and offset number you want to use. The first two digits is the tool number; the last two digits is the offset number.

Feedrate: Enter the cutting feedrate to cutoff the work piece. You can toggle between feed/min and feed/rev.

Spin Speed: Enter the spindle speed for the work piece cutoff. You can toggle between RPM and CSS. When toggle to RPM, a constant RPM will be maintained. When toggled to CSS, a constant surface speed will be maintained.

Pre/Post Cycle Pos.: Allows you to select if you want to move to a specified position before the cycle and/or a position after the cycle. Once toggled from "None" 2 fields appear to enter the desired position.

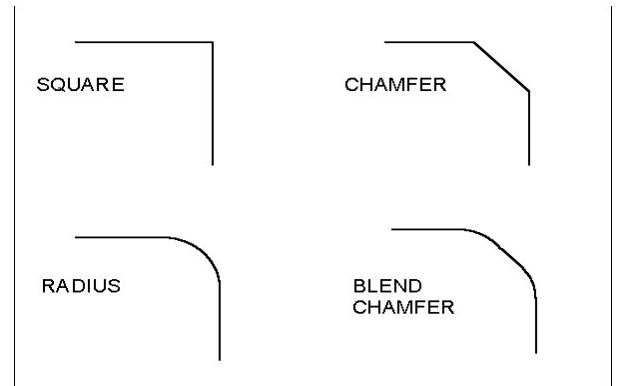

F10 - Other

The **F10-Other** key displays additional operations.

If the 3rd axis label in the machine configuration is set to 'C' and parameter 93 is set for C axis operation, or if the 4th axis label in the machine configuration is set to 'C' and parameter 94 is set for C axis operation, there will be options for C Axis and C Indexing operations shown.

The options shown at the bottom of the screen are described below. Press the **ESC** key to cancel and return to the Insert Operation Menu.

F1 - Comment

Press the **F1-Comment** key to enter a comment. The comment can be up to 35 characters long and will be displayed in the generated CNC program.

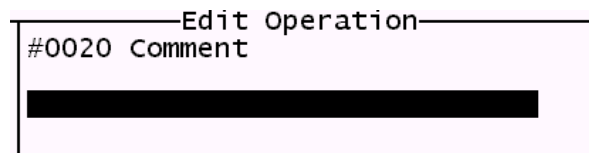

F2 – M&G Code

Press the **F2-M&G Code** key to enter M and G codes directly into the part program.

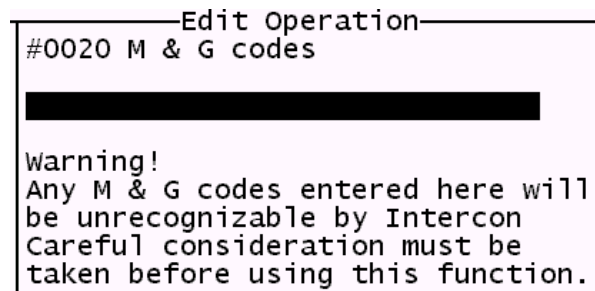

After entering the M and G codes you may press the **F10-Accept** key to accept the entry or the **ESC** key to cancel and return to the Insert Operation Menu.

F3 – C Axis

Press the **F3-C Axis** key to enter the C Axis edit operation screen.

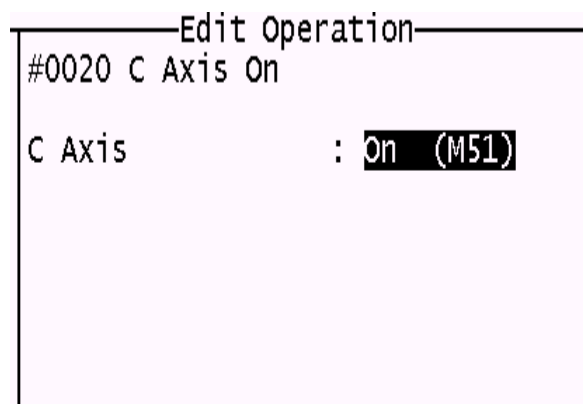

Press the **F1-Toggle** key or **space** bar to toggle between on and off. Press the **F10-Accept** key to accept the entry or the **ESC** key to cancel and return to the Insert Operation Menu.

F4 – C Index

Press the **F4-C Index** key to enter the C Indexing operation screen.

Intercon Lathe					Current Part:	
Operation #	Type	End X(D)	Z	Tool	N0002 C Axis Index	
0001	Header				Degrees	: 0°INC
0002					Minutes	: 0 INC
0003	End Prog	0.0000	0.0000	00	Seconds	: 0 INC
					Decimal Degrees	: 0.0000°INC
					Move Mode	: Rapid
					Feedrate	: 0.0000
					Brake Off M Code	: 0
					Brake On M Code	: 0
Abs Inc F1	Brake Off-On F3	Help F5	Math Help F6	Graph F8	Teach Mode F9	Accept F10

Press the **F1-Abs/Inc** key to toggle between incremental (INC) and absolute (ABS) positioning. Press the **F3-Brake Off-On** key to toggle the brake fields off and on.

Degrees: The number of degrees you want to move the C axis. This value can be positive or negative.

Minutes: The number of minutes you want to move the C axis. Values for this field are between 0 and 59.

Seconds: The number of seconds you want to move the C axis. Values for this field are between 0 and 59.

Move Mode: Rapid positioning or Feedrate move.

Feedrate: This is the degrees per minute at which to move if the aforementioned Move Mode is set to Feedrate. Otherwise this field is not used.

Decimal degrees: This is another method of entering the number of degrees. If you choose to enter the movement of the C axis with the fields listed above, the value of this field will be calculated automatically. If you choose to enter the number of degrees with this field or make changes to it, then the degrees, minutes, and seconds will be calculated or changed automatically. Values for this field can be positive or negative.

Brake On M code: The number of the M code to output for the braking function. The brake fields must be toggled on to allow the editing of this field. When the brake fields are on, code will be output to turn off the brake, position the C axis, and then turn on the brake.

Brake Off M code: The number of the M code to output for the braking function. The brake fields must be toggled on to allow the editing of this field.

Press the **F10-Accept** key to accept the entry or the **ESC** key to cancel and return to the Insert Operation Menu.

F9 – Chamfer

Press the **F9-Chamfer** key to enter the chamfer operation screen. This is a one-shot operation. It generates a cutting move from the current position at one of four angles as shown in the picture, below.

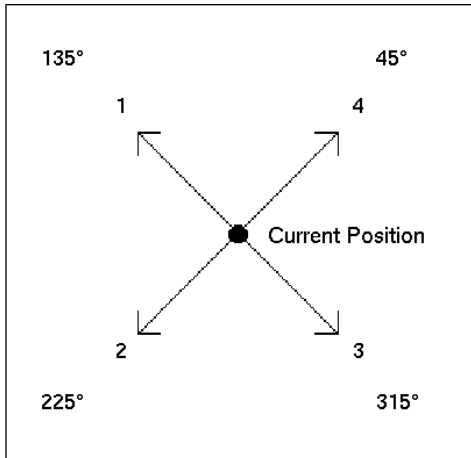

N0002 Chamfer	
Chamfer Angle	: 1 - 135
Length	: 0.0100
End	X: 0.0141 INC
	Z: -0.0071 INC
Tool Num/Offset	: T 0202
Feedrate	: 0.0100 F/R
Spindle Speed	: 500 CSS
Cutter Comp	: None

Chamfer Angle: Press the space bar or keys 1 through 4 to choose one of four angles: 135, 225, 315, and 45.

Length: If you know the length, enter it here. Intercon will calculate the End X and Z for you.

End X, End Z: Enter either X or Z; Intercon will calculate the other axis end position and length based on the selected angle.

Tool Num/Offset: In one-shot mode, this will be filled in with the current tool number.

Feedrate: Enter the cutting feedrate for the chamfer. You can toggle between feed/min and feed/rev.

Spindle: Enter the spindle speed for the chamfer. You can toggle between RPM and CSS. When toggle to RPM, a constant RPM will be maintained. When toggled to CSS, a constant surface speed will be maintained.

Cutter Compensation: Set cutter compensation in Chapter 11 for more details. You can toggle between None, Right and Left.

Press the **F10-Accept** key to accept the entry or the **ESC** key to cancel and return to the Insert Operation Menu.

F10 – Radius

Press the **F9-Radius** key to enter the radius operation screen. This is a one-shot operation. It generates an arc move from the current position in one of eight directions as shown in the picture, below.

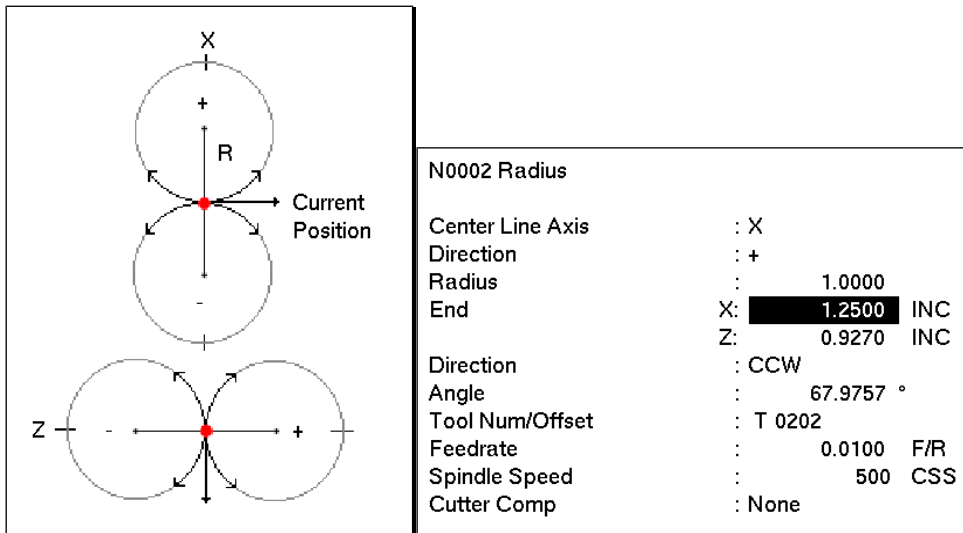

Center Line Axis: This chooses four of the eight possible arcs. X selects a center point on the X axis; Z selects a center point on the Z axis. Press the space bar to toggle or press the X and Z keys.

Direction: The direction to move on the selected axis. It is also the direction of the center point from the current position. Press the space bar to toggle between “+” and “-“. This chooses two out of four possible arcs.

Radius: The radius of the arc.

End X, End Z: If known, the end position of the arc. Intercon will calculate the other axis end point, arc direction, and angle automatically.

Arc Direction: Use the space bar to select CW (clockwise) or CCW (counter-clockwise).

Tool Num/Offset: In one-shot mode, this will be filled in with the current tool number.

Feedrate: Enter the cutting feedrate for the arc. You can toggle between feed/min and feed/rev.

Spindle: Enter the spindle speed for the arc. You can toggle between RPM and CSS. When toggle to RPM, a constant RPM will be maintained. When toggled to CSS, a constant surface speed will be maintained.

Cutter Compensation: Set cutter compensation in Chapter 11 for more details. You can toggle between None, Right and Left.

Press the **F10-Accept** key to accept the entry or the **ESC** key to cancel and return to the Insert Operation Menu.

Graphics

Press the **F8-Graph** key from the Intercon Main Menu, the File Menu, or from any Edit Operation Menu to view graphics. A wire frame of your part will appear.

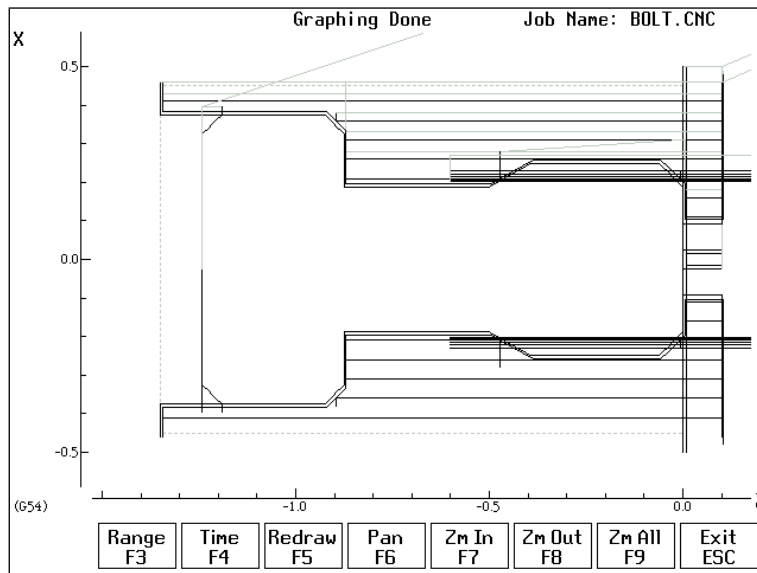

F3 - Range

Press the **F3-Range** key to graph a portion of a part program.

Set Graphing Range
Start Block: N
End Block: N

Start Block: Enter the start block number of the portion of the part program you want to graph.

End Block: Enter the end block number of the portion of the part program you want to graph.

Press the **F10-Accept** key to accept entries and the **ESC** key to cancel.

F4 - Time

Press the **F4-Time** key to get an estimate of the time it will take to produce the part.

F5 - Redraw

Press the **F5-Redraw** key to redraw the graphic.

F6 - Pan

Press the **F6-Pan** key to move the part around the graph window. After pressing this key, crosshatches will appear. Move the crosshatches around with the arrow keys. Pick a location on the part with the crosshatches and press the **F6-Pan** key to pan this to the center of the graph window.

F7 - Zoom In

Press the **F7-Zoom In** key to zoom into the part. You will zoom in to the center of the graph window.

F8 - Zoom Out

Press the **F8-Zoom Out** key to zoom out from the part. You will zoom out from the center of the graph window.

F9 - Zoom All

Press the **F9-Zoom All** key to fit the entire part within the graph window.

1 - 9, 0, Space - Feed Rate Override & Hold

If no jog panel is attached (or "Keyboard" has been selected as the jog panel type) the number keys 1 - 9 and 0 choose feed rate overrides 10% - 90% and 100%, respectively. The **space bar** toggles feed hold on and off.

Math Help

Intercon provides a math assistance function to solve the trigonometric problems common in part drawings. To enter Math Help, press **F6-Math Help** from any Edit Operation screen. The first time that you invoke Math Help, the following screen appears which shows all available *solvers*:

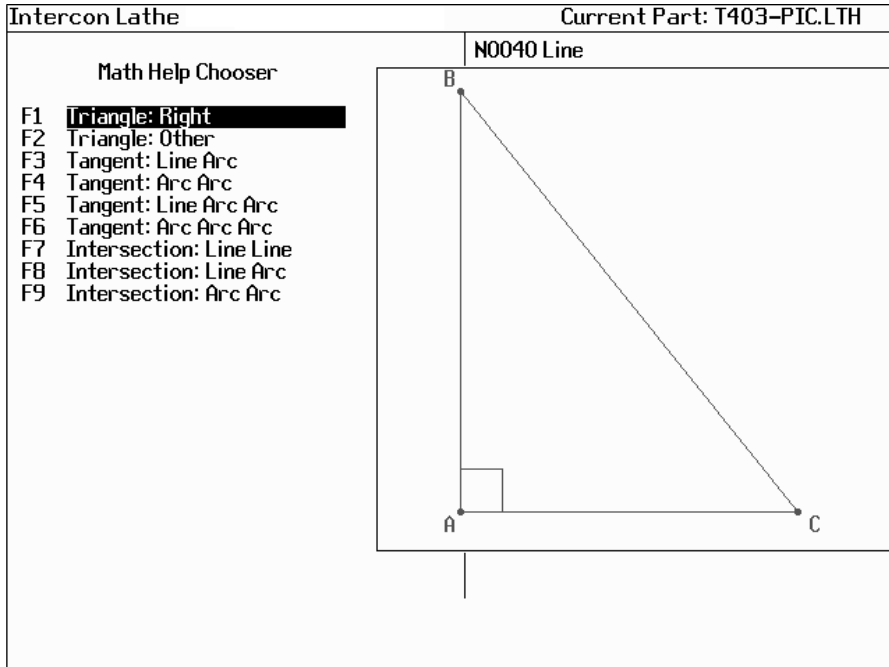

The figures on the right are a graphical representation of the highlighted solver on the left. Pressing **ENTER** will display another menu that has various fields particular to the type of problem that is being solved. The graphic below displays the Right Triangle Calculator menu. The options that are available on the function keys are the same for every type of math help solver and perform the following operations:

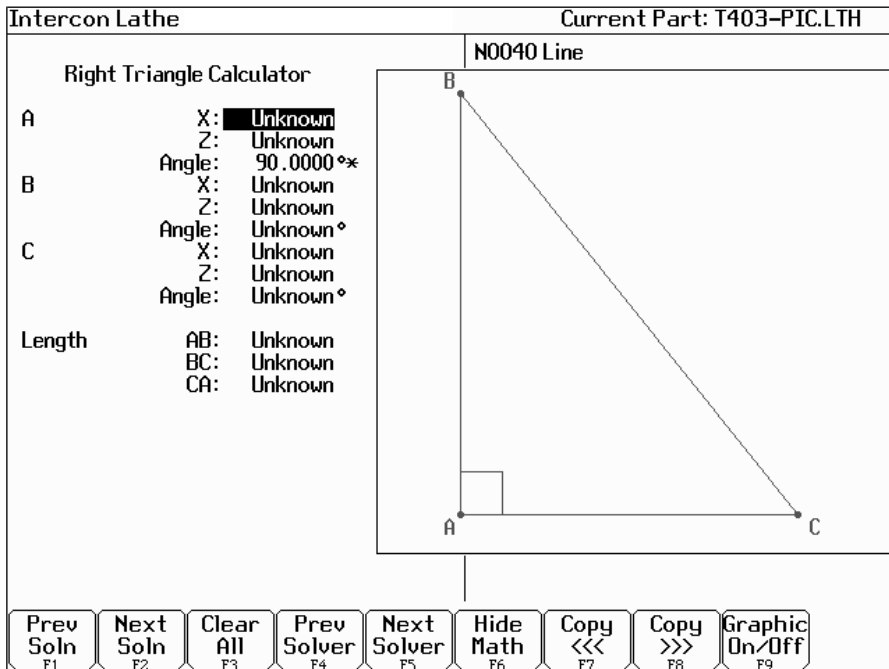

F1 – Prev Soln

F2 – Next Soln

The **Prev Soln** and **Next Soln** options will cycle backward and forward, respectively, through the available solution sets for math solvers that may have multiple solutions. A status line near the bottom left of the screen appears once a valid solution has been found. The solution status line indicates the total number of solutions and the solution number that is currently represented by the graphic display on the right. For example, in an Arc Tangent Arcs math help, the display solution status may be “- Solution 1 of 8 -“. In this case, the **Prev Soln** and **Next Soln** can be used to cycle through all eight of the solutions.

F3 – Clear All

The Clear All option removes all solutions. It sets all fields for a particular solver to UNKNOWN.

F4 – Prev Solver

F5 – Next Solver

The **Prev Solver** and **Next Solver** options cycle backward and forward, respectively, through the various math help solvers. These options are shortcuts which have the same effect as pressing **ESC** to reach the main math help menu, navigating to the previous or next math help option, and then pressing **ENTER**.

F6 – Hide Math

The Hide Math option exits math help mode and returns to the operation edit menu. Pressing **F6-Hide Math** to invoke Math Help again will restore Math Help exactly as you left it.

F7 – Copy <<<

F8 – Copy >>>

The **Copy <<<** option will move the value from the selected edit operation field into the selected math help menu field and the **Copy >>>** operation will move the value from the selected math help menu field into the selected edit operation field. For both options, the selected fields in the math help menu and the operation edit menu are advanced. If the graphical display is visible when choosing one of these options, the effect is to turn off the graphics display. Only when the graphics display is off will the Copy operations actually copy values and advance field selections.

The currently selected fields have either a box drawn around them or are highlighted depending upon which menu is active. The active menu, which is either the math operation menu on the left hand side or the operation edit menu on the right hand side, depicts the selected field by highlighting the entire field. The non-active menu displays the active field with a box drawn around it. Use the arrow keys to select fields as described below.

F9 – Graphic On/Off

The Graphic On/Off option will remove the graphical representation of the math help menu from the display. This is helpful before copying data between Intercon operations and Math Help.

↑ ↓ ← → (Arrow Keys) – Select Fields

The **LEFT** and **RIGHT** arrow keys are used to navigate between the math menu and the edit menu. The **UP** and **DOWN** arrow keys are used to navigate within a menu. To choose fields for the “Copy” option, above, use the **UP** and **DOWN** arrow keys to highlight the desired field in the menu and use the **LEFT** or **RIGHT** arrow keys to switch menus.

Other features common to all Math help operations

In some math help operations, there will be an asterisk "*" character that appears immediately to the right of a field. This character marks the field as a "given" field, which means that the value of this field will be held constant in the process of solving the math equations.

F1 –Triangle: Right

F2 –Triangle: Other

The screen will show **UNKNOWN** if the value of each parameter is not known. Math Help waits for known values to be entered, where:

- Point a, b, or c** is the coordinate value for each corner of the triangle.
- Angle A, B, or C** is the angle at each point of the triangle.
- Length of** values are the distances between the points indicated.

Continue adding all the known parameters. Select parameters using the arrow keys. When Math Help solves the remaining unknown values, the screen will display them.

F3 – Tangent: Line Arc

Given the center (C1) and radius of an arc and 1 point (LP) on a line, find the lines tangent to the arc (defined by the tangent point (T1)). You must enter the X and Y coordinates for the circle's center point, the circle's radius, and the X and Y coordinates for a point on the line.

F4 – Tangent: Arc Arc

Intercon Lathe		Current Part: T403-PIC.LTH						
Arc Tangent Arc		N0040 Line						
Circle 1	X: 0.0000 Z: 0.0000 Radius: 1.0000							
Circle 2	X: 0.0000 Z: 0.5000 Radius: 0.5000							
Tangent	X: 0.0000 Z: 1.0000							
- Solution 1 of 1 -								
Prev Soln F1	Next Soln F2	Clear All F3	Prev Solver F4	Next Solver F5	Hide Math F6	Copy <<< F7	Copy >>> F8	Graphic On/Off F9

Given the center points (CP1 and CP2) and radii (R1 and R2) of two arcs, find the point (T) at which they are tangent. You must enter the X and Y coordinates for the first circle's center point, the radius of the first circle, the X and Y coordinates for the second circle's center point, and the second circle's radius.

F5 – Tangent: Line Arc Arc

Intercon Lathe		Current Part: T403-PIC.LTH						
Line Tangent Arcs		N0040 Line						
Circle 1	X: 0.0000 Z: 0.0000 Radius: 1.0000							
Circle 2	X: 4.0000 Z: 0.0000 Radius: 1.5000							
Tangent 1	X: -0.1250 Z: 0.9922							
Tangent 2	X: 3.8125 Z: 1.4882							
- Solution 1 of 4 -								
Prev Soln F1	Next Soln F2	Clear All F3	Prev Solver F4	Next Solver F5	Hide Math F6	Copy <<< F7	Copy >>> F8	Graphic On/Off F9

Given the center points (CP1 and CP2) and radii (R1 and R2) of two arcs, find the lines (defined by T1 - T8) tangent to both arcs. You must enter the X and Y coordinates for the first circle's center point, the radius of the first circle, the X and Y coordinates for the second circle's center point, and the second circle's radius.

F6 – Tangent: Arc Arc Arc

Intercon Lathe		Current Part: T403-PIC.LTH	
		N0040 Line	
Arc Tangent Arcs			
Circle 1	X: -2.0000	Z: 0.0000	
	Radius: 1.0000		
Circle 2	X: 4.0000	Z: 0.0000	
	Radius: 2.0000		
Circle 3	X: 0.2500	Z: -3.3072	
	Radius: 3.0000		
Tangent 1	X: -1.4375	Z: -0.8268	
Tangent 2	X: 2.5000	Z: -1.3229	
- Solution 1 of 4 -			

Prev Soln F1	Next Soln F2	Clear All F3	Prev Solver F4	Next Solver F5	Hide Math F6	Copy <<< F7	Copy >>> F8	Graphic On/Off F9
-----------------	-----------------	-----------------	-------------------	-------------------	-----------------	----------------	----------------	----------------------

Given the center points (C1 and C2) and radii of two arcs and the radius of a third arc, find the center point of the third arc and the tangent points (T1 and T2). You must enter the radius of the tangent arc, the X and Y coordinates for the first circle's center point, the radius of the first circle, the X and Y coordinates for the second circle's center point, and the second circle's radius.

F7 – Intersection: Line Line

Intercon Lathe		Current Part: T403-PIC.LTH	
		N0040 Line	
Line Intersection Line			
Line 1	X1: 0.0000 *	Z1: 0.0000 *	
	X2: 5.0000 *	Z2: 5.0000 *	
	Angle: 45.0000		
Line 2	X1: 0.0000 *	Z1: 5.0000 *	
	X2: 8.0000 *	Z2: -1.0000 *	
	Angle: 323.1301		
Inter-section	X: 2.8571	Z: 2.8571	
* Given (Space to Toggle)			
- Solution 1 of 1 -			

Prev Soln F1	Next Soln F2	Clear All F3	Prev Solver F4	Next Solver F5	Hide Math F6	Copy <<< F7	Copy >>> F8	Graphic On/Off F9
-----------------	-----------------	-----------------	-------------------	-------------------	-----------------	----------------	----------------	----------------------

You must enter the X and Y coordinates for 1 point on each line, and also one of the following:

- * The X and Y coordinates for a second point
- * The X coordinate for a second point and the angle from horizontal
- * The Y coordinate for a second point and the angle from horizontal
- * The angle from horizontal only

F8 – Intersection: Line Arc

Intercon Lathe		Current Part: T403-PIC.LTH								
Line Intersection Arc		N0040 Line								
Circle	X: 0.0000 Z: 0.0000 Radius: 1.0000									
Line	X1: -2.0000 * Z1: -2.0000 * X2: 2.0000 * Z2: 0.3094 Angle: 30.0000 *									
Int. 1	X1: 0.9560 Z1: -0.2933									
Int. 2	X2: -0.2240 Z2: -0.9746									
* Given (Space to Toggle)										
- Solution 1 of 1 -										
Prev Soln F1	Next Soln F2			Clear All F3	Prev Solver F4	Next Solver F5	Hide Math F6	Copy <<< F7	Copy >>> F8	Graphic On/Off F9

Given the center (CP) and radius (R) of an arc, 1 point (LP1) and either a second point (LP2) or one coordinate (LP2 X or Y) and the angle from horizontal, find the intersection point(s) (I1 and I2).

You must enter the X and Y coordinates for the circle's center point, the circle's radius, the X and Y coordinates for one point on the line, and one of the following:

- * The X and Y coordinates of a second point on the line
- * The X coordinate of a second point and the angle from horizontal
- * The Y coordinate of a second point and the angle from horizontal

F9 – Intersection: Arc Arc

Intercon Lathe		Current Part: T403-PIC.LTH								
Arc Intersection Arc		N0040 Line								
Circle 1	X: 0.0000 Z: 0.0000 Radius: 3.0000									
Circle 2	X: 4.0000 Z: 0.0000 Radius: 4.0000									
Int. 1	X1: 1.1250 Z1: -2.7811									
Int. 2	X2: 1.1250 Z2: 2.7811									
- Solution 1 of 1 -										
Prev Soln F1	Next Soln F2			Clear All F3	Prev Solver F4	Next Solver F5	Hide Math F6	Copy <<< F7	Copy >>> F8	Graphic On/Off F9

Given the center points (CP1 and CP2) and the radii (R1 and R2) of two arcs, find the intersection point(s) (I1 and I2) of the arcs.

You must enter the X and Y coordinates for the first circle's center point, the radius of the first circle, the X and Y coordinates for the second circle's center point, and the second circle's radius.

Intercon Lathe Tool Library

You can press **F2-Tool lib** in most Edit Operations screens to enter the Tool Library Screen.

Intercon Lathe v3. — Current Part: part1.lth

Tool Library

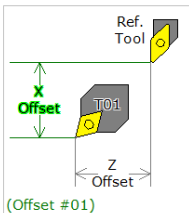
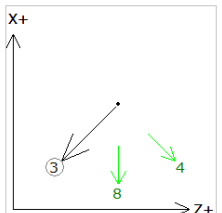
Off. #	Tool Loc	Tool Orient	Tool Type	Tool Approach	X Offset	Z Offset	Nose Radius	Nose Vector	Spin Dir	Max Spin	Coolant	Description
01	T01	OD	Custom	Rear	1.0000	2.0000	0.0200	3	CW	500	Mist	custom
02	T02	OD	Custom	Rear	0.1000	0.1000	0.0500	2	CW	600	Mist	custom
03	T03	OD	Turn	Rear	0.0000	0.0000	0.0500	3	CW	1000	Flood	groove
04	T04	ID	Bore	Rear	0.3000	0.1000	0.0500	2	CW	700	Flood	boring tool
05	T05	FFace	Drill	Rear	0.4000	0.2000	0.0000	7	CW	500	Mist	drill
06	T06	OD	Cutoff	Rear	1.3000	-0.3000	0.0010	8	CW	750	Mist	this is tool 6
07	T07	ID	Tap	Rear	0.1000	0.0000	0.0000	8	CW	150	Flood	tool 7
08	T08	ID	Ream	Rear	-0.2000	0.0000	0.0000	3	CW	500	Flood	reamer
09	T09	ID	Custom	Rear	-0.3000	-2.4665	0.0000	2	CW	20	Flood	custom tool
10	T10	OD	Custom	Rear	0.1000	1.3245	0.0000	0	CW	30	Mist	
11	T11	OD	Custom	Rear	-1.0000	4.1320	0.0000	0	Off	40	Off	
12	T12	OD	Custom	Rear	2.0000	3.1340	0.0000	0	Off	50	Off	

Entry mode: absolute

Abs Inc F4	+.001 F5	-.001 F6	+.0001 F7	-.0001 F8	Save F10
---------------	-------------	-------------	--------------	--------------	-------------

Use the up and down arrow keys to select which tool offset to edit. When editing a tool, press **ENTER** to accept the entry and to move onto the next field for that tool, or use the left and right arrow keys to move from field to field. You can also use **F5-+.001** or **F6- -.001** to adjust the offsets and nose radius values by a small increment. Absolute/Incremental entry mode for the offset values and nose radius values can be toggled with the **F4-Abs/Inc** key.

Press **F10-Accept** to accept the highlighted offset for the current operation and save any changes. Press **Esc** to cancel the offset selection. If you made changes, you will be asked if you wish to save them.

Offset # (Tool Offset): This non-editable field serves as the row number reference into the Tool Library. Use the up and down arrow keys to select a tool offset.

Tool Loc (Tool Number): Enter the tool number (01-99) that you want to associate with the tool offset number. Usually the Tool Location would be associated with the same numbered Tool Offset. For example, Tool #1 would have Location T01 and Offset 01, therefore T0101. However, there may be situations where you may want to specify 2 or 3 different offsets for tool #1. For instance, T0102 would be Location T01 and would use Offset 02 and T0103 would be location T01 and use offset 03.

Tool Orient: This is the tool operation direction, which generally describes the direction in which the tool points. It also implies the orientation of the work surface. Choices here are OD (outer diameter), ID (inner diameter), FFace (front face), and RFace (rear face).

Tool Type: This field describes the tool's general shape and intended operation. Use "Custom" if the tool does not match any of the available tool types.

Approach (from): This field is the tool approach direction. This indicates which side of work piece centerline the tool must travel from in order to start operation on the work piece. For gang tool lathes (parameter 163=1), the approach direction is independently set for each tool. For non-gang tool lathes, this field is locked to the same approach direction for every tool and cannot be modified, and such an approach direction is based on the lathe's overall machine orientation (as set in parameter 1). See Chapter 14 for information about parameters 1 and 163.

X Offset: Enter the amount to adjust the X-axis position when tool offsets are used.

Z Offset: Enter the amount to adjust the Z-axis position when tool offsets are used.

Nose Radius: Enter the nose radius of the tool. This field is used by cutter compensation, if it is turned on.

Nose Vector: Enter the nose vector of the tool. This tells Lathe Intercon how the tool is oriented in the machine. This field affects the behavior of cutter compensation, and also affects the tool retraction moves when a tool change occurs in a program.

Spin Dir (Spindle Direction): Enter the spindle direction for the tool. Toggle between off, clockwise, and counterclockwise.

Max Spin (Max. Spindle Speed (G50)): The maximum spindle speed for the tool. A G50 is posted with the tool change using this value as the S parameter. If the value is zero, the G50 value from the Setup screen is used.

Coolant: Specify the coolant for each tool. Toggle between off, flood and mist

Description: Enter a description of the tool.

Chapter 9

Lathe Intercon Tutorials

Lathe Intercon Tutorial #1

This is a step-by-step example of creating a part from a blueprint using Intercon. The tool path to be created is for turning a ball end onto a one-inch diameter piece of stock. Before beginning, be sure you are following these five steps to successful turning:

- Determine the tools necessary to machine the part by analyzing the print.
- Set the X and Z offsets for each tool. (T-Series Operator's Manual, Chapter 4)
- Program the part using Intercon. (Lathe Intercon Manual)
- Set the Part Zero position on the stock to be machined. (T-Series Operator's Manual, Chapter 5)
- Graph the part to check for programming errors, and machine the part.

This exercise begins after the print has been analyzed, the tools have been chosen, and the X and Z offsets have been set. For this particular example, the end face coordinates of the part are chosen to be X0 and Z0. The procedure outlined in the following pages will give you step-by-step instructions for programming the part (Figure 1) using Intercon.

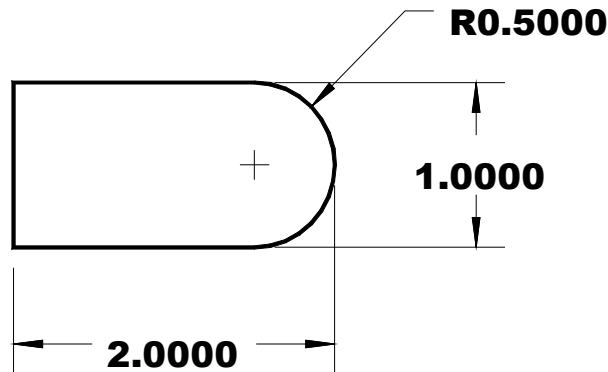

Figure 1 - Part to be Programmed

Each feature of the part will become an operation in your program. Beginning from the T-Series Control Main Screen, the following series of keystrokes will describe the step-by-step process of programming the part shown in Figure 1.

A. Create a New Part Program:

PRESS	ACTION	COMMENTS
F5	CAM	CAM Selection menu.
F1	ICN	Starts Lathe Intercon.
F9	Setup	Modify setup parameters. (See the next page.)
F10	Accept	Save modified setup parameters.
F1	File	Opens the File Menu.
F1	New	Creates a new program. Enter "demo1" as the name for the file.
F10	Accept	Accept the file name. Fill in the dialog box exactly as shown in Figure 2.
F10	Accept	Creates a new part file using the data entered.

These tutorials assume the options Modal Linear and Arc are turned on in Intercon Setup (F9 on Intercon main menu). When these options are turned on, accepting a Linear or Arc operation automatically inserts new Linear or Arc operation after it. The Esc key can be used to cancel the new operation if it is not desired and return to the operation menu. If these options are not turned on, the user must press F1 or F2 to insert a new Linear or Arc operation. The operations shown in the examples have the taper angle and modal input fields turned on. To make your entry screens look like the examples, go to the Setup screen to make sure that the parameters match the ones below. **NOTE: Additional setup options are available by pressing the down arrow key or the page down key.**

Intercon Setup	
Comment Generation	: Enabled
Clearance Amount	: 0.1000
G71/G72 Cut Depth	: 0.0500
G71/G72 Retract Amount	: 0.1000
Peck Retract Amount	: 0.0100
G74 X Relief Amount	: 0.1000
G75 Z Relief Amount	: 0.1000
Thread Min. Cut Depth	: 0.0010
Thread Chamfer Amount	: 0.0000
Chamfer Blend Radius	: 0.0100
Spindle/Coolant Delay	: 2.00
Max Spindle Speed (G50)	: 3000
Modal Linear	: Yes
Modal Arc	: No
Modal Drill/Bore/Tap	: No
Use G28 for tool change	: Yes
Help Icons always on	: No
X Coordinate Input Mode	: Diameter
Taper Angle Input Fields	: Yes
Modal Input Fields	: Yes
DRO Units	: Inches
Machine Units	: Inches
Stop spindle during tool change	: No
Stop coolant during tool change	: No

N0001 Header

Programmer : ***Your name here***

Program description:

> : Part with Ball End

Units : Inches

Stock Diameter X: 1.0000

Stock Length Z: 2.0000

WorkHolding : End Chucked

Z Face Coordinate : 0.0000

Date : 28-Jan-2005

Enter your name as programmer.

You may enter a description of the part.

In this field, hit <SPACE> to toggle between End Chucked and Between Center.

Figure 2 - New Part Dialog Box

B. Insert the First Cycle:

PRESS	ACTION	COMMENTS
F7	Turning	Creates a repetitive cycle used to cut an outside or inside diameter to a specified dimension within a specified Z range. Fill in the Edit Operation side of the screen as shown in Figure 3.
F8	Graph	Generates a graph of the part to this point, as shown in Figure 4. This preview can be used to detect problems that may occur if the part was cut now.
Esc	Escape/Cancel	Returns to the Editing window.
F10	Accept	Saves the data.

N0002 Turning Cycle	
Turning Type	: End Face
Starting Diameter	: 1.1000
Ending Diameter	: -0.0500
Starting Z	: 0.1000
Ending Z	: 0.0100
Taper Amount	: 0.0000
Taper Angle	: 0.0000 °
Depth of Cut	: 0.0900
Rough Tool	: T 0505
Rough Feedrate	: 0.0100 F/R
Rough Spin Speed	: 550 CSS
Finish Pass Amt.	: 0.0000
Finish Tool	: T 0000
Finish Feedrate	: 0.0000 F/R
Finish Spin Speed	: 0 CSS
Cutter Comp	: None
Return Feed Amt.	: 0.0000
Dwell Time	: 0.00
Pre/Post Cycle Pos.	: None

In this field, hit <SPACE> to toggle between End Face, and Diameter.

Your cycle will begin at X=1.1 in. and end at X=-0.05 in.

Your cycle will begin at Z=0.1 in. and end at Z= 0.01 in.

Press F2 to set up tools. Enter 0.0321 for nose radius, 3 for nose vector, and CW for spindle direction.

Figure 3 - Turning Cycle Operation

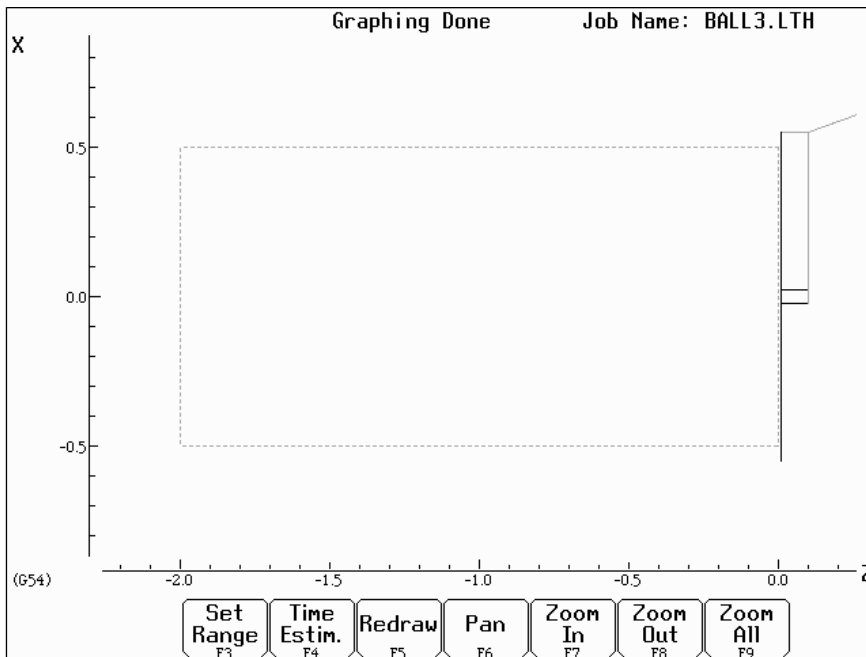

Figure 4 - First Graph of Turning Cycle

C. Create A Profile:

PRESS	ACTION	COMMENTS
F6	Profile	Defines a profile with lines and arcs that will be produced with a cleanout cycle. Fill in the Edit Operation portion of the screen as shown in Figure 5. The first profile command will create the move shown in Figure 6. NOTE: The line number displayed in the Edit operation window is the line number for the <i>end</i> of the profile (which is currently line 40).

N0004 Profile Cycle			
Profile Type	:	Diameter	In this field, hit <SPACE> to toggle between End Face, and Diameter.
Start	X:	1.0000	The profile will begin at X=1.0 in., Z=0.1 in., removing .05 in.
	Z:	0.1000	
Depth of Cut	:	0.0500	These values set how much stock the Rough Pass will leave for the Finish pass.
Rough Tool	:	T 0101	
Rough Feedrate	:	0.0100 F/R	
Rough Spin Speed	:	550 CSS	In this field, hit <SPACE> to toggle between Right, Left, and None.
Stock to Leave	X:	0.0100	
	Z:	0.0050	
Cutter Comp	:	Right	
Rapid Between Cuts	:	No	

Figure 5 - Beginning of Profile Cycle.

Note: For T1 press F2-Tool and enter 0.321 for nose radius, 3 for nose vector, and CW for spindle direction.

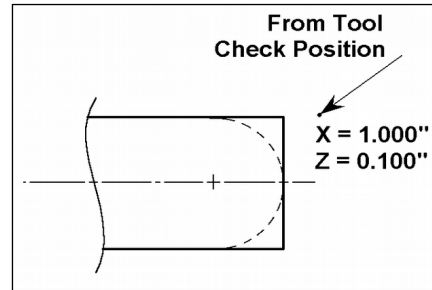

Figure 6 - First Profile Move.

PRESS	ACTION	COMMENTS
F10	Accept	Accept Profile parameters and enter into Profile Edit mode.
F1	Line	Inserts a line into your profile (Figure 8). Fill in the Edit Operation portion of the screen exactly as shown in Figure 7.

N0004 Line		
Linear Type	:	Feedrate
End	X:	-0.0500
	Z:	0.1000
Taper Angle	:	270.0000 °
Taper Length	:	0.5250
Connect Type	:	None
Connect Radius	:	0.0000
Chamfer Distance	:	0.0000
Tool Num/Offset	:	T 0101
Finish Feedrate	:	0.0100 F/R
Finish Spindle Speed	:	550 CSS
Cutter Comp	:	Right

Figure 7 - Line 1 Edit Screen (Modal and Taper displays on)

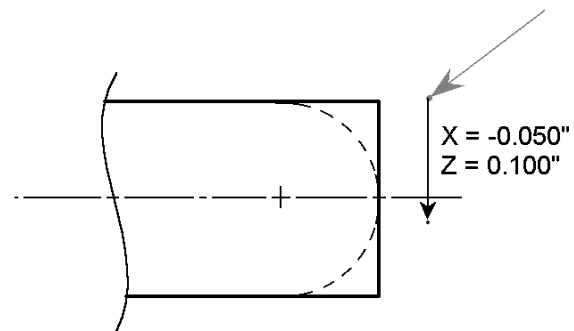

Figure 8 - First Line in Profile.

PRESS	ACTION	COMMENTS
F10	Accept	Saves the data for first Linear operation and automatically inserts another Linear operation. This linear will be the second linear in Figure 10. Fill in the Edit Operation portion of the screen exactly as shown in Figure 9. Notice that End X is 0 incremental.

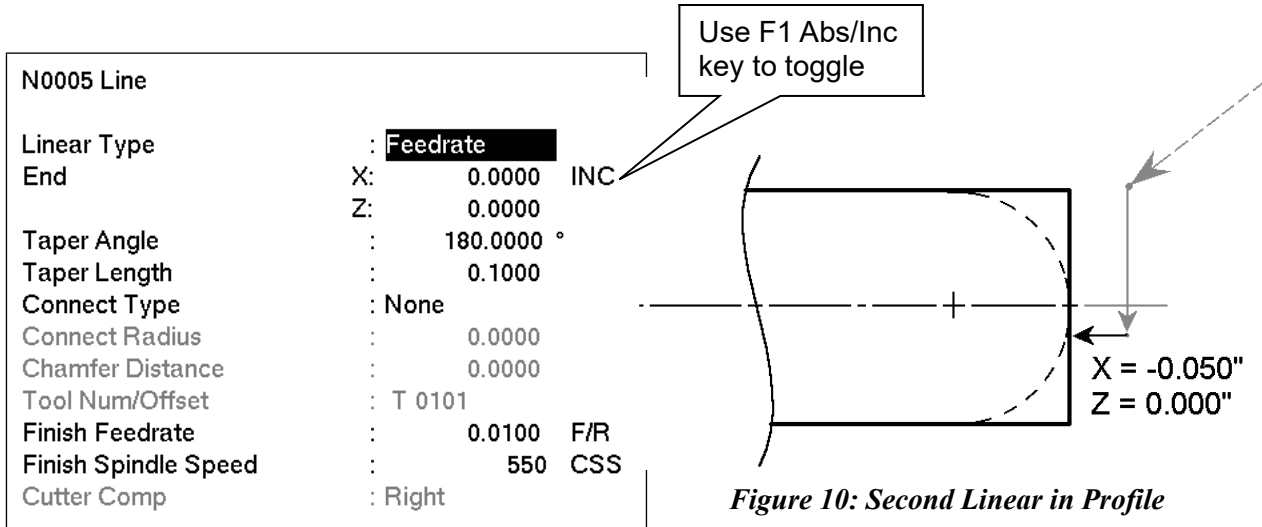

Figure 9 - Line 2 Edit Screen (Modal and Taper displays on)

Figure 10: Second Linear in Profile

PRESS	ACTION	COMMENTS
F10	Accept	Saves the data for Line 2 and automatically inserts another line operation. This next line will be Line 3 in Figure 12. Fill in the Edit Operation portion of the screen exactly as shown in Figure 11.

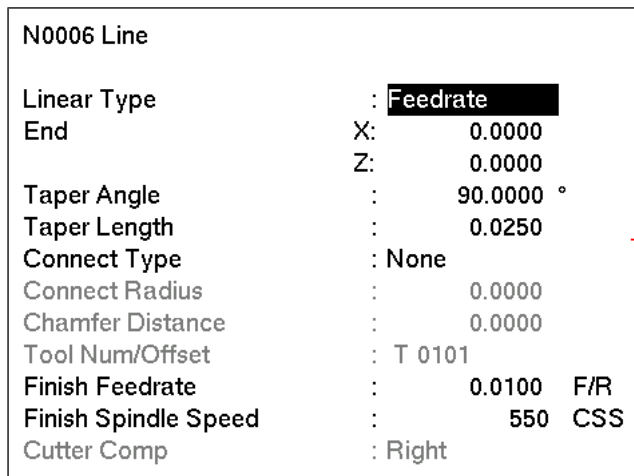

Figure 11 - Line 3 Edit Screen.

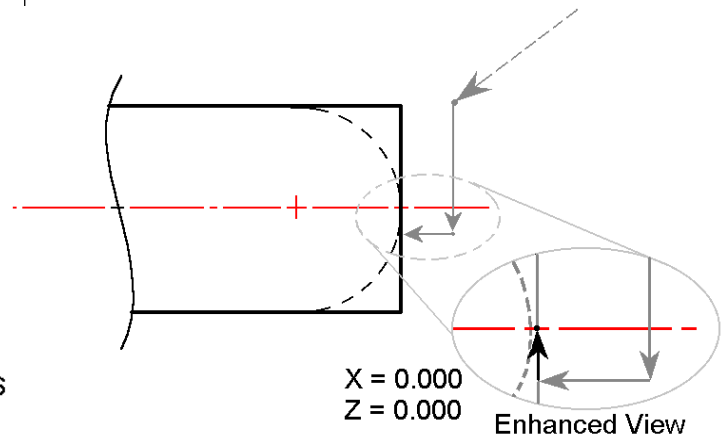

Figure 12 - Third Line in Profile.

PRESS	ACTION	COMMENTS
F10	Accept	Saves the data for Line 3 and automatically inserts another line operation
Esc	Escape/Cancel	Cancel current line operation. Return to the profile edit menu.
F2	Arc	Inserts an arc into the profile (Figure 14). Fill in the Arc Edit Operation portion of the screen exactly as shown in Figure 13.
F10	Accept	Saves the data, automatically inserts another arc operation.

N0007 Arc	
Arc Type	: EP & R
Mid	X: 0.7071
	Z: -0.1464
End	X: 1.0000
	Z: -0.5000
Center	X: 0.0000
	Z: -0.5000
Radius	: 0.5000
Angle	: 90.0000 °
Direction	: CCW
Connect Radius	: 0.0000
Tool Num/Offset	: T 0101
Finish Feedrate	: 0.0100 F/R
Finish Spindle Speed	: 550 CSS
Cutter Comp	: Right

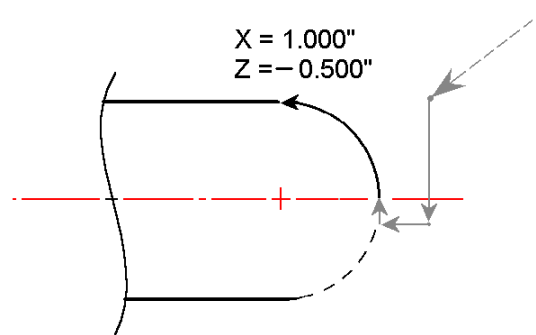

Figure 14 - Arc (0.5" Dia.) in Profile.

Figure 13 - Arc Edit Screen (Modal displayed)

PRESS	ACTION	COMMENTS
F1	Line	Inserts a fourth line into your profile (Figure 16). Fill in the Line Edit Operation portion of the screen exactly as shown in Figure 15.

N0008 Line	
Linear Type	: Feedrate
End	X: 1.0000
	Z: -0.6000
Taper Angle	: 180.0000 °
Taper Length	: 0.1000
Connect Type	: None
Connect Radius	: 0.0000
Chamfer Distance	: 0.0000
Tool Num/Offset	: T 0101
Finish Feedrate	: 0.0100 F/R
Finish Spindle Speed	: 550 CSS
Cutter Comp	: Right

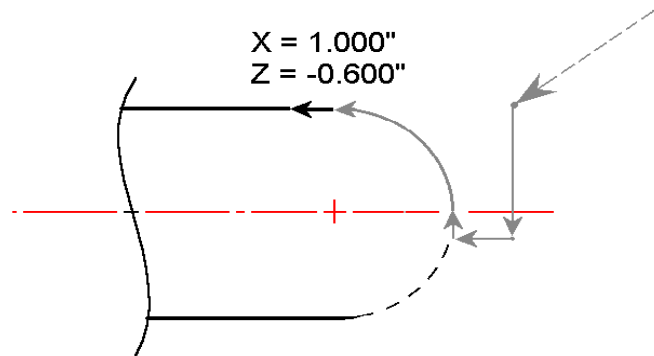

Figure 16 - Last Line in Profile.

Figure 15 - Line 4 Edit Screen

D. Include a Finish Pass:

PRESS	ACTION	COMMENTS
F10	Accept	Saves the data for Line 4, and automatically inserts another line operation.
Esc	Escape/Cancel	Cancel current line operation. Return to profile edit screen.
F3	Finish	Creates a finish pass through the whole profile to remove material left by the rough pass (Figure 18). If no Depth of Cut is set here, the finish pass will remove all the material in one pass. Fill in the Edit Operation portion of the screen exactly as shown below in Figure 17.

• Note: The depth of material left to be removed by the Finish Pass is defined in the beginning of the Profile, (shown in Figure5) in the fields marked 'Stock to Leave'.

Operation #	Type	X(D)	Z	Tool
0001	;Part with Ball End			
0002	Facing	1.1000	0.1000	05
0003	Profile	1.0000	0.1000	01
0004	Linear	-0.0500	0.1000	01
0005	Linear	-0.0500	0.0000	01
0006	Linear	0.0000	0.0000	01
0007	Arc CCW	1.0000	-0.5000	01
0008	Linear	1.0000	-0.6000	01
0009	N0009 Finish Pass			
0010	Profile End	1.0000	0.1000	01
0011	End Prog	1.0000	0.1000	01

These numbers refer to the lines in the program that mark the beginning and end of the profile.

Start Block : N0004

End Block : N0008

Depth of Cut X: 0.0000

Z: 0.0000

Tool Num/Offset : T 0505

Cutter Comp : Right

Figure 17 - Full Screen View of Finish Pass Edit Screen.

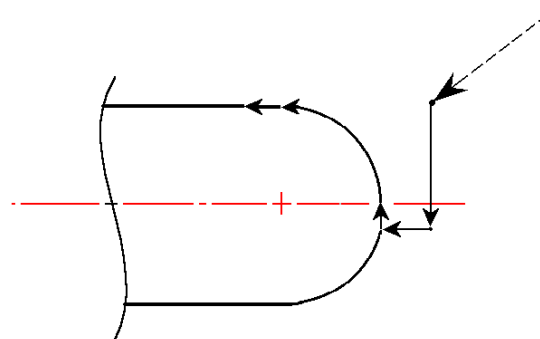

Figure 18 - Finish Pass Over Whole Profile.

E. Graph the Final Part:

PRESS	ACTION	COMMENTS
F8	Graph	Generates a graph of the finished part, as shown in Figure19. This preview can be used to detect problems that may occur if the part was cut now.

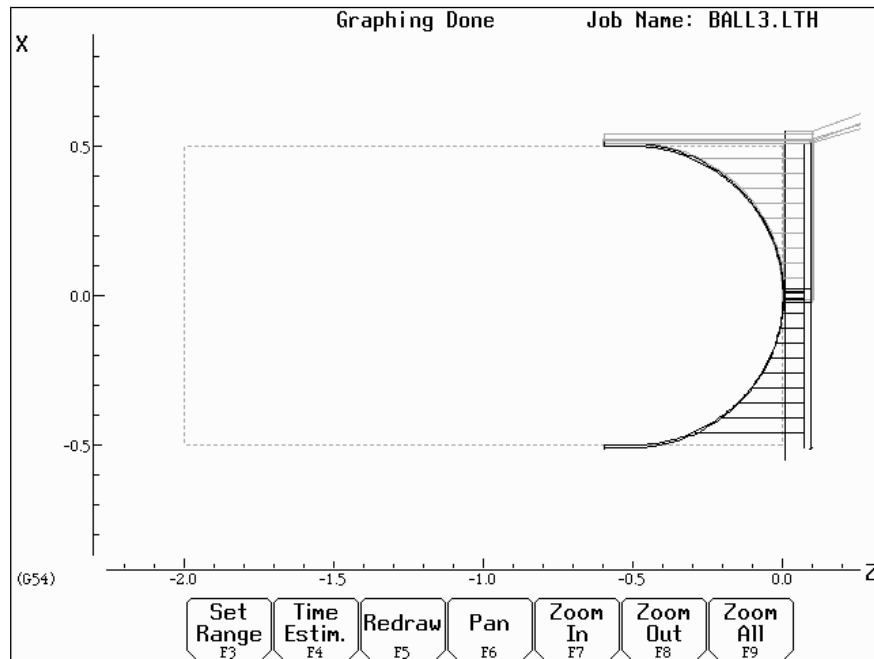

Figure 19 - Graph of Finished Part

F. Post the Part and Exit

PRESS

ACTION

COMMENTS

Esc	Escape/Cancel	Returns you to the Editing window.
F10	Accept	Saves the data, and returns to the profile editing screen.
Ecs	Escape/Cancel	Returns you to the Main Programming window.
F10	Post	Saves and posts the job to the control, creating G-codes for the program.

Lathe Intercon Tutorial #2

This is a step-by-step example of creating a part from a blueprint using Intercon. The tool path to be created is for the part shown in Figure 1. Before beginning, be sure you are following these five steps to successful turning:

- Determine the tools necessary to machine the part by analyzing the print.
- Set the X and Z offsets for each tool. (T-Series Operator's Manual, Chapter 4)
- Program the part using Intercon. (Lathe Intercon Manual)
- Set the Part Zero position on the stock to be machined. (T-Series Operator's Manual, Chapter 5)
- Graph the part to check for programming errors, and machine the part.

This exercise begins after the print has been analyzed, the tools have been chosen, and the X and Z offsets have been set. For this particular example, the end face coordinates of the part are chosen to be X0 and Z0. The procedure outlined in the following pages will give you step-by-step instructions for programming the part shown below.

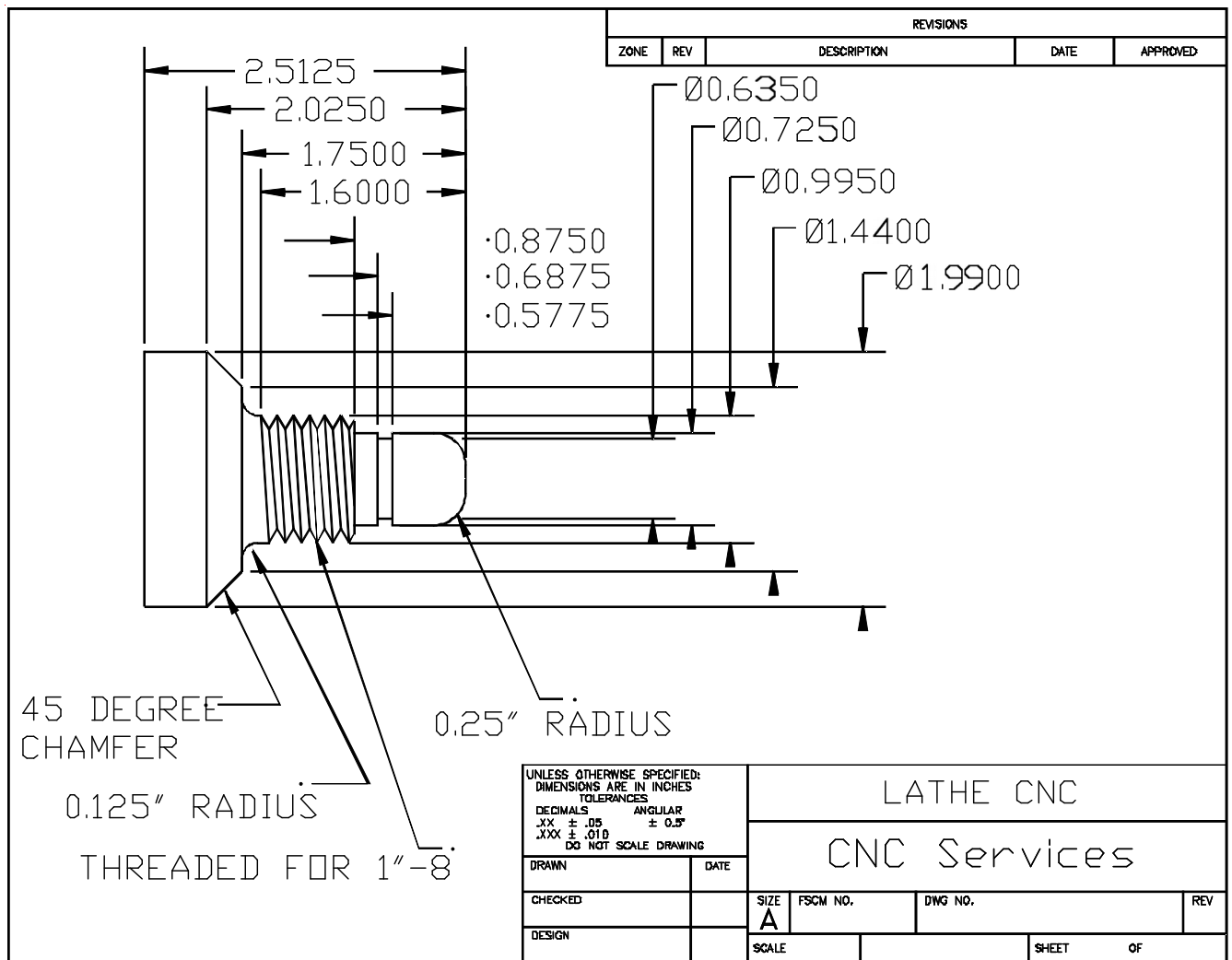

Figure 1 - Part to be Programmed.

Beginning from the T-Series Control Main Screen, the following series of keystrokes will describe the step-by-step process of programming the part shown in Figure 1.

A. Create a New Part Program:

PRESS	ACTION	COMMENTS
F5	CAM	CAM Selection menu.
F1	ICN	Start Lathe Intercon interface.
F1	File	Opens the File Menu.
F1	New	Create a new program. Enter a name for the file.
F10	Accept	Accept the file name. Fill in the dialog box exactly as shown in Figure 2.
F10	Accept	Creates a new part file using the data entered.

The screenshot shows a dialog box titled 'N0001 Header' with the following fields and values:

- Programmer : ***Your name here***
- Program description: > : Lathe ICN Tutorial #2
- Units : Inches
- Stock Diameter X: 2.0000
- Stock Length Z: 3.0000
- WorkHolding : **End Chucked**
- Z Face Coordinate : 0.0000
- Date : 28-Jan-2005

Callouts point to the following fields:

- 'Enter your name.' points to the Programmer field.
- 'You may enter a description of the part.' points to the Program description field.
- 'In this field, hit <SPACE> to toggle between End Chucked and Between Center.' points to the WorkHolding field.

Figure 2 - New Part Dialog Box

B. Insert the First Cycle:

PRESS	ACTION	COMMENTS
F7	Turning	Creates a repetitive cycle used to cut an outside or inside diameter to a specified dimension within a specified Z range. Fill in the Edit Operations side of the screen as shown in Figure 3.

The screenshot shows a dialog box titled 'N0002 Turning Cycle' with the following fields and values:

- Turning Type : **End Face**
- Starting Diameter : 2.1000
- Ending Diameter : -0.0500
- Starting Z: 0.1000
- Ending Z: 0.0000
- Taper Amount : 0.0000
- Taper Angle : 0.0000 °
- Depth of Cut : 0.1000
- Rough Tool : T 0101
- Rough Feedrate : 0.0100 F/R
- Rough Spin Speed : 600 CSS
- Finish Pass Amt. : 0.0100
- Finish Tool : T 0101
- Finish Feedrate : 0.0050 F/R
- Finish Spin Speed : 650 CSS
- Cutter Comp : None
- Return Feed Amt. : 0.0000
- Dwell Time : 0.00
- Pre/Post Cycle Pos. : None

Callouts point to the following fields:

- 'The cycle will begin at X = 2.1 inches, and end at X = -0.05 inches.' points to the Starting and Ending Diameter fields.
- 'The cycle will begin at Z = 0.10 inches, and end at Z = 0.0 inches.' points to the Starting and Ending Z fields.

PRESS	ACTION	COMMENTS
F2	Tool	Opens the Tool Library. For Tool Offset 1, set the following values: Tool Location (Tool Number) = T01 Nose Radius = .0312 Nose Vector = 3 Spin Dir = CW (See Figure 4)
F10	Accept	Sets the Tool Library for Tool Offset #1.
F10	Accept	Keeps selected values for the turning cycle.

Tool Library

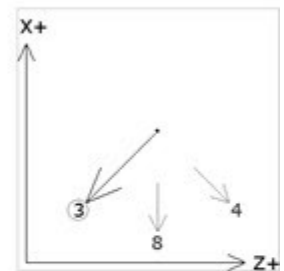
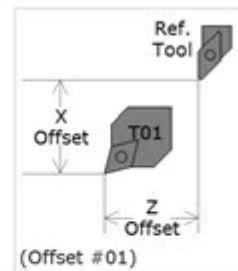

Off. #	Tool Loc	Tool Orient	Tool Type	Approach	X Offset	Z Offset	Nose Radius	Nose Vector	Spin Dir	Max Spin	Coolant	Description
01	T01	OD	Turn	Rear	0.0000	0.0000	0.0312	3	CW	0	Flood	
02	T02	OD	Thread	Rear	0.0000	0.0000	0.0000	8	Off	0	Off	
03	T03	OD	Groove	Rear	0.0000	0.0000	0.0000	8	Off	0	Off	
04	T04	ID	Bore	Rear	0.0000	0.0000	0.0000	2	Off	0	Off	
05	T05	ID	Drill	Rear	0.0000	0.0000	0.0000	7	Off	0	Off	

C. Create A Profile:

PRESS	ACTION	COMMENTS
F6	Profile	Defines a profile with lines and arcs that will be produced with a cleanout cycle. You can accept the values when at least two operations are present within the profile. Fill in the Edit Operation side exactly as shown in Figure 5. NOTE: The line number displayed in the Edit operation window is the line number for the end of the profile (which is currently line 4).

```

N0004 Profile Cycle

Profile Type      : Diameter
Start            X:      2.0000
                  Z:      0.1000
Depth of Cut     :      0.0500
Rough Tool       : T 0101
Rough Feedrate   :      0.0100 F/R
Rough Spin Speed :      500 CSS
Stock to Leave   X:      0.0100
                  Z:      0.0050
Cutter Comp      : Right
Rapid Between Cuts : No

```

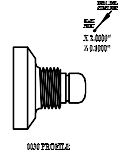

0003 PROFILE

Figure 5 - Beginning of Profile Cycle – Program Line #0003

PRESS	ACTION	COMMENTS
F10	Accept	Accept the entered values for the Profile.
F1	Line	Inserts a line into your profile. Fill in the Edit Operation portion of the screen exactly as shown in Figure 6.

```

N0004 Line

Linear Type      : Feedrate
End              X:      0.0500
                  Z:      0.1000
Taper Angle     :      270.0000 °
Taper Length    :      0.9750
Connect Type    : None
Connect Radius  :      0.0000
Chamfer Distance :      0.0000
Tool Num/Offset : T 0101
Finish Feedrate :      0.0100 F/R
Finish Spindle Speed :      600 CSS
Cutter Comp     : Right

```

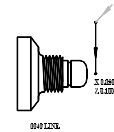

0004 LINE

Figure 6 - First Line within the Profile Cycle – Program Line #0004

PRESS	ACTION	COMMENTS
F10	Accept	Keep selected values for first line in profile. Automatically insert another line operation. Fill in the Edit Operation portion of the screen exactly as shown in Figure 7.

N0005 Line	
Linear Type	: Feedrate
End	X: 0.0500
	Z: 0.0000
Taper Angle	: 180.0000 °
Taper Length	: 0.1000
Connect Type	: None
Connect Radius	: 0.0000
Chamfer Distance	: 0.0000
Tool Num/Offset	: T 0101
Finish Feedrate	: 0.0050 F/R
Finish Spindle Speed	: 600 CSS
Cutter Comp	: Right

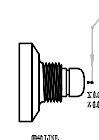

0005 LINE

Figure 7 - Second Line within the Profile cycle – Program Line #0005

PRESS	ACTION	COMMENTS
F10	Accept	Keep selected values for Line 2. Automatically insert another line operation. This line will be 0.3375 inches long and will be cut on an angle of 90 degrees with a Connect Radius of 0.250 inches. Fill in the Edit Operation portion of the screen exactly as shown in Figure 8.

N0006 Line	
Linear Type	: Feedrate
End	X: 0.7250
	Z: 0.0000
Taper Angle	: 90.0000 °
Taper Length	: 0.3375
Connect Type	: Radius
Connect Radius	: 0.2500
Chamfer Distance	: 0.0000
Tool Num/Offset	: T 0101
Finish Feedrate	: 0.0050 F/R
Finish Spindle Speed	: 600 CSS
Cutter Comp	: Right



0006 LINE (CR)

Figure 8 - Third Line within the Profile cycle – Program Line #0006

PRESS	ACTION	COMMENTS
F10	Accept	Save values entered for Line 3. Automatically insert a fourth linear operation into your profile. This line will be 0.8750 inches long, cut at an angle of 180 degrees. Fill in the Edit Operation portion of the screen exactly as shown in Figure 9.

```

N0007 Line
Linear Type      : Feedrate
End             X:      0.7250
               Z:     -0.8750
Taper Angle     :      180.0000 °
Taper Length    :      0.8750
Connect Type    : None
Connect Radius  :      0.2500
Chamfer Distance :      0.0000
Tool Num/Offset : T 0101
Finish Feedrate :      0.0050 F/R
Finish Spindle Speed :      600 CSS
Cutter Comp     : Right

```



Figure 9 - Fourth Line within the Profile cycle – Program Line #0007

PRESS	ACTION	COMMENTS
F8	Graph	Displays a preview of the part up to this point. Your graph should look like that shown in Figure 10.
ESC	Escape	Returns you to the Editing Menu
F10	Accept	Keeps selected values for Line 4. Automatically inserts a fifth linear operation into your profile. This line will be 0.1350 inches long, cut at an angle of 90 degrees, with 0007 LINE transfer connector 0.1" long. Fill in the Edit Operation portion of the screen exactly as shown in Figure 11.

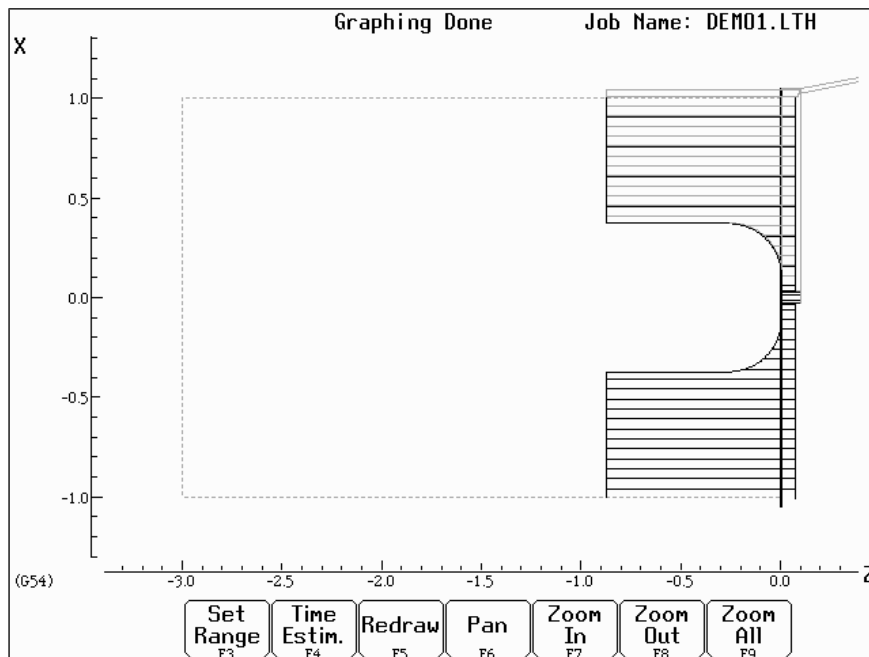

Figure 10 - Graph of Partial Profile

N0008 Line	
Linear Type	: Feedrate
End	X: 0.9950
	Z: -0.8750
Taper Angle	: 90.0000 °
Taper Length	: 0.1350
Connect Type	: BI Chamfer (Len)
Connect Radius	: 0.2500
Chamfer Length	: 0.1000
Tool Num/Offset	: T 0101
Finish Feedrate	: 0.0050 F/R
Finish Spindle Speed	: 600 CSS
Cutter Comp	: Right



0008 LINE (WITH CHAMFER)

Figure 11 - Fifth Line within the Profile cycle – Program Line #0008

PRESS	ACTION	COMMENTS
F10	Accept	Keep selected values for Line 5. Automatically insert a sixth linear operation into your profile. This line will be 0.8750 inches long and will cut at an angle of 180 degrees with a connect Radius of 0.125 inches. Fill in the Edit Operation portion of the screen exactly as shown in Figure 12.

N0009 Line	
Linear Type	: Feedrate
End	X: 0.9950
	Z: -1.7500
Taper Angle	: 180 °
Taper Length	: 0.8750
Connect Type	: Radius
Connect Radius	: 0.1250
Chamfer Distance	: 0.0000
Tool Num/Offset	: T 0101
Finish Feedrate	: 0.0050 F/R
Finish Spindle Speed	: 600 CSS
Cutter Comp	: Right

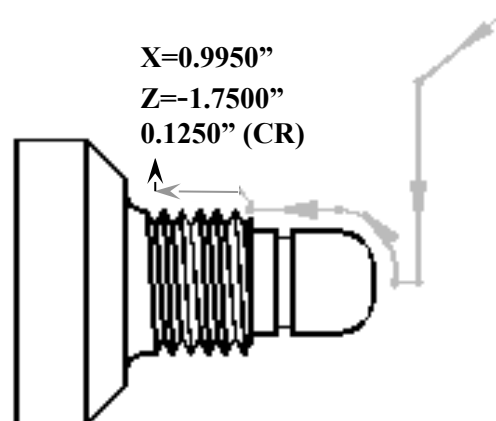

0009 LINE

Figure 12 - Sixth Line within the Profile cycle – Program Line #0009

PRESS	ACTION	COMMENTS
F10	Accept	Keep selected values for Line 6. Automatically insert a seventh linear operation into your profile. This line will be 0.2225 inches long and will cut at an angle of 90 degrees with a connect radius of 0.015 inches at the corner. Fill in the Edit Operation portion of the screen exactly as shown in Figure 13.

N0010 Line	
Linear Type	: Feedrate
End	X: 1.4400
	Z: -1.7500
Taper Angle	: 90.0000 °
Taper Length	: 0.2225
Connect Type	: Radius
Connect Radius	: 0.1500
Chamfer Distance	: 0.0000
Tool Num/Offset	: T 0101
Finish Feedrate	: 0.0050 F/R
Finish Spindle Speed	: 600 CSS
Cutter Comp	: Right

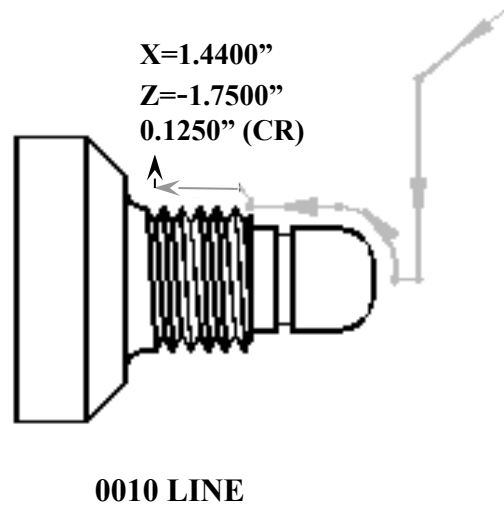

Figure 13 - Seventh Line within the Profile cycle – Program Line #0010

PRESS	ACTION	COMMENTS
F10	Accept	Keep selected values for Line 7. Inserts an eighth linear operation into your profile. This line will be 0.3889 inches long and will cut at an angle of 135 degrees, with a connect radius of 0.015 inches at the corner. Fill in the Edit Operation portion of the screen exactly as shown in Figure 14.

N0011 Line	
Linear Type	: Feedrate
End	X: 1.9900
	Z: -2.0250
Taper Angle	: 135.0000 °
Taper Length	: 0.3889
Connect Type	: Radius
Connect Radius	: 0.0150
Chamfer Distance	: 0.0000
Tool Num/Offset	: T 0101
Finish Feedrate	: 0.0050 F/R
Finish Spindle Speed	: 600 CSS
Cutter Comp	: Right

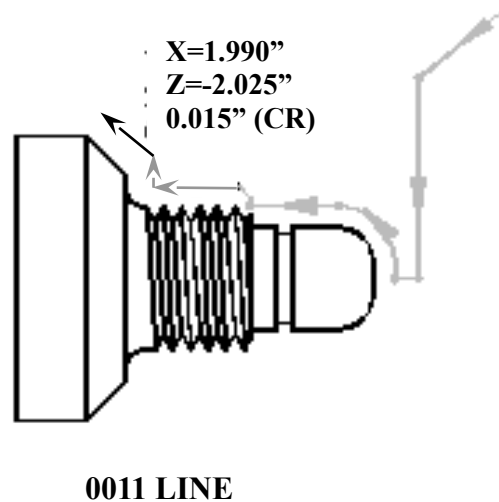

Figure 14 - Eighth Line within the Profile cycle – Program Line #0011

PRESS	ACTION	COMMENTS
F10	Accept	Keep selected values for Line 8. Inserts a ninth linear operation into your profile. This line will be 0.625 inches long and will be cut at an angle of 180 degrees. Fill in the Edit Operation portion of the screen exactly as shown in Figure 15.

```

N0012 Line
Linear Type      : Feedrate
End             : X: 1.9900
               : Z: -2.6500
Taper Angle     : 180.0000 °
Taper Length    : 0.6250
Connect Type    : None
Connect Radius  : 0.0150
Chamfer Distance : 0.0000
Tool Num/Offset : T 0101
Finish Feedrate : 0.0050 F/R
Finish Spindle Speed : 600 CSS
Cutter Comp     : Right

```

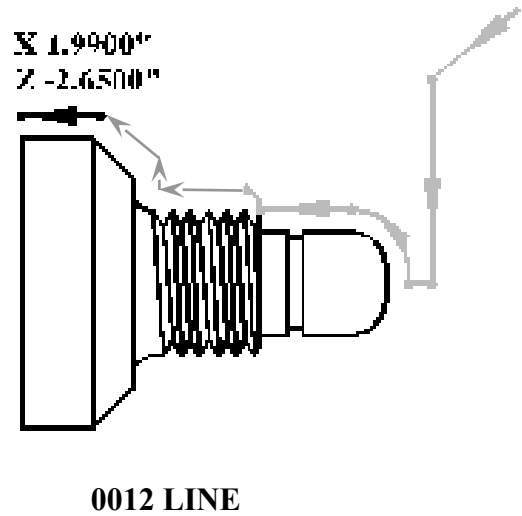

0012 LINE

Figure 15 - Ninth Line Within the Profile cycle – Program Line #0120

PRESS	ACTION	COMMENTS
F8	Graph	Displays a preview of the part up to this point. The profile to this point should look like that shown in Figure 16.
ESC	Escape	Returns you to the Editing Menu

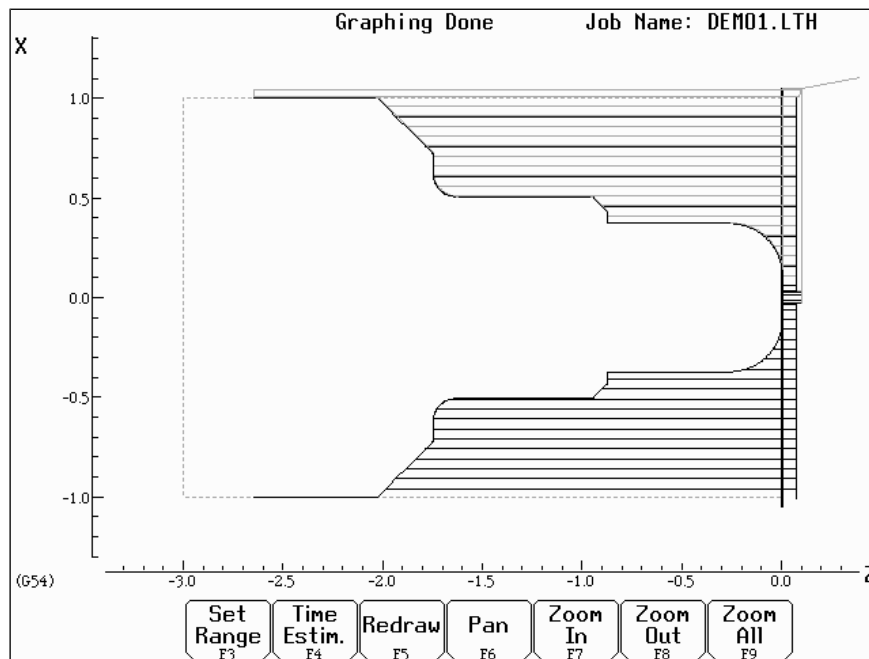

Figure 16 - Partial Graph of Profile Through Program Line #0120

PRESS	ACTION	COMMENTS
F10	Accept	Keep selected values for Line 9. Automatically inserts a tenth linear operation.

Esc	Escape/Cancel	Cancel tenth linear operation and return to profile edit menu.
F3	Finish	Inserts a finishing pass to remove any excess material left from the Rough Pass, and leave a smooth finish. Fill in the Edit Operation portion of the screen exactly as shown in Figure 17.

● **Note:** If the depth of cut for X and Z are 0 or equal to the Depth of Cut in line # 0030 (X=0.01inches, and Z=0.005 inches), the finish pass will be cut in one pass

```

N0013 Finish Pass

Start Block      : N 0004
End Block       : N 0012
Depth of Cut    X:      0.0100
                Z:      0.0050
Tool Num/Offset : T 0202
Cutter Comp     : Right
  
```

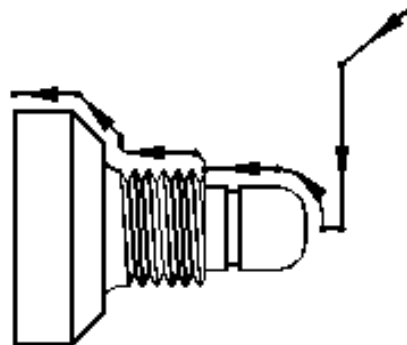

0013 FINISH PASS

Figure 17 - Finish Pass Within the Profile cycle – Program Line #0013.

PRESS	ACTION	COMMENTS
F2	Tool	Set the nose radius for Tool 2 = .0150, and the Nose Vector for Tool 2 = 3. Set the Spin Dir=CW, using the <space> bar to toggle thru the choices available.
F10	Accept	Sets the Tool Library for Tool #2.
F10	Accept	Accepts Finish Pass values.
Esc	Escape	Exits the profile edit menu.
↓	Down Arrow	Cursor down so the next operation will be inserted after the end of profile line.

D. Insert a Groove:

PRESS	ACTION	COMMENTS
F3	Insert	Insert a new operation after the end of the profile.
F8	Groove	Creates an outside groove with a depth increment (X) of 0.05 inches and a width increment (Z) of 0.025 inches, ending in a corner radius of 0.030 inches. Fill in the Edit Operation portion of the screen exactly as shown in Figure 18.

N0015 Grooving Cycle			
Type	:	Outside	
Diameter			
Start	:	0.7250	
End	:	0.6350	
Increment	:	0.0500	
Width			
Start	Z:	-0.6395	
End	Z:	-0.6875	
Increment	Z:	0.0250	
Corner Finish	:	Radius	
Corner Radius	:	0.0300	
Chamfer Distance	:	0.0000	
Rough Tool	:	T 0303	
Rough Feedrate	:	0.0030	F/R
Rough Spin Speed	:	400	CSS
Finish Pass Amt.	:	0.0020	
Finish Tool	:	T 0303	
Finish Feedrate	:	0.0015	F/R
Finish Spin Speed	:	450	CSS
Dwell Time	:	0.00	
Pre/Post Cycle Pos.	:	None	

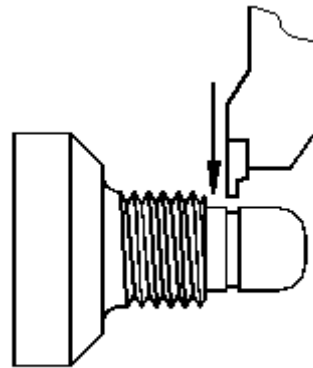

0015 GROOVING

Figure 18 - Grooving Operation – Program Line #0015.

PRESS	ACTION	COMMENTS
F2	Tool	Set the nose radius for Tool 3 = .0070, and the Nose Vector for Tool 3 = 8. Set the Spin Dir=CW, using the <space> bar to toggle thru the choices available. These same values can be set now for Tools 4 & 5, but be sure the cursor is back in the Tool 3 row before pressing F10!
F10	Accept	Sets the Tool Library for Tools #3, 4, & 5.
F8	Graph	Displays a preview of the part up to this point. The part graph should now look as shown in Figure 19.

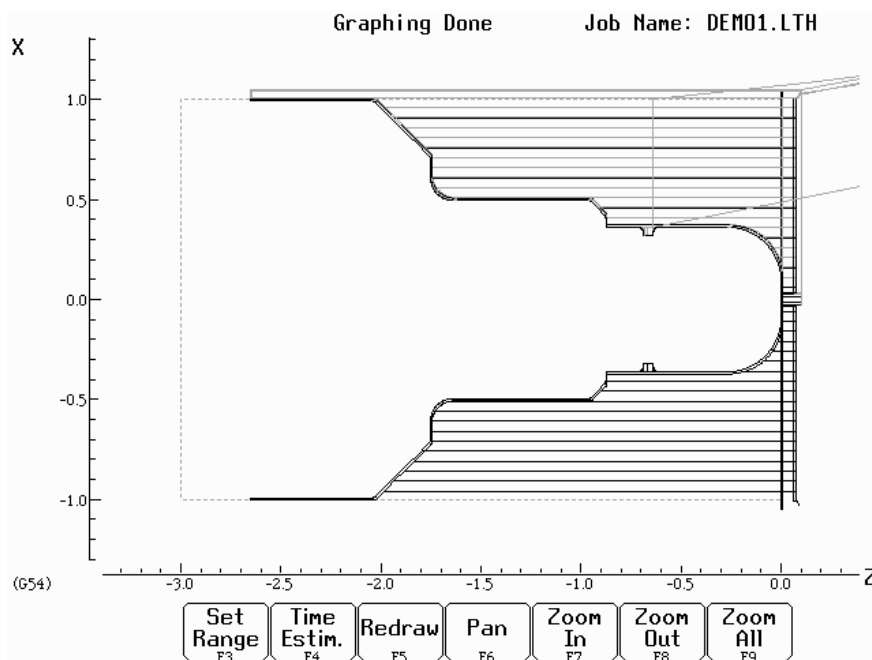

Figure 19 - Graph of Grooving Operation – Program Line #0150

PRESS	ACTION	COMMENTS
ESC	Escape	Returns to the Editing Menu.
F10	Accept	Accepts Grooving cycle.

E. Add Threads:

PRESS	ACTION	COMMENTS
F5	Thread	Places an external thread on the part with a compound angle of 60 degrees, 8 threads per inch with a thread lead of 0.125 inches. Fill in the Edit Operation section of the screen as shown in Figure 20.

```

N0016 Thread Cycle

Thread Type           : External
Designation          : 1-8
Class                 : 2

Designation          Class
1-8 UNC              2A
One match. Press Enter to accept.

Enter search criteria, select a thread.

```

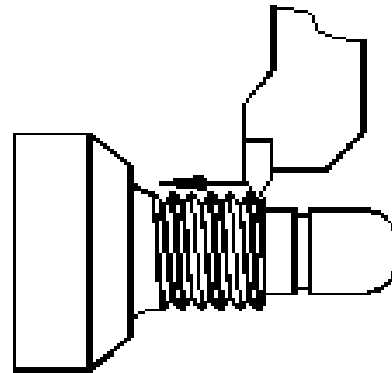

0016 THREADING

```

N0016 Thread Cycle

Thread Type           : External
Designation          : 1-8 UNC
Class                 : 2A
Thread Angle         : 55.0000 °
Threads / Inch       : 8.0000
Thread Lead          : 0.1250
Major Diameter       : 0.9905
Minor Diameter       : 0.8492
Chamfer Amount       : 1.0000
Taper Amount         : 0.0000
Taper Angle          : 0.0000 °

Press "Main" to return.

```

```

N0016 Thread Cycle

Thread Type           : External
Designation          : 1-8 UNC
Class                 : 2A
Clearance             Z: 0.3750 INC
Thread Face           Z: -0.8750
Ending                Z: -1.6625
Minimum Cut Depth     : 0.0010
First Cut Depth       : 0.0100
Tool Number           : T 0404
Spindle Speed         : 1100 RPM
Finish Pass Amt.     : 0.0010
Num Spring Passes     : 2
Pre/Post Cycle Pos.  : None

Press "Details" for more.

```

Figure 20 - Threading Operation – Program Line #0016.

PRESS	ACTION	COMMENTS
F10	Accept	Accepts values for the threading cycle.

F. Cut the Part From the Stock:

PRESS	ACTION	COMMENTS
F9	Cutoff	Cuts off the part with a cutoff tool. Continuous cut Fill in the Edit Operation section of the screen as shown in Figure 21.

N0017 Cutoff Cycle	
Type	: Continuous
Peck Increment	: 0.1000
Z Position	: -2.6375
Starting Diameter	: 2.1000
Ending Diameter	: -0.0500
Corner Finish	: Square
Corner Radius	: 0.0000
Chamfer Distance	: 0.0000
Tool Num/Offset	: T 0505
Feedrate	: 0.0020 F/R
Spindle Speed	: 450 CSS
Pre/Post Cycle Pos.	: None

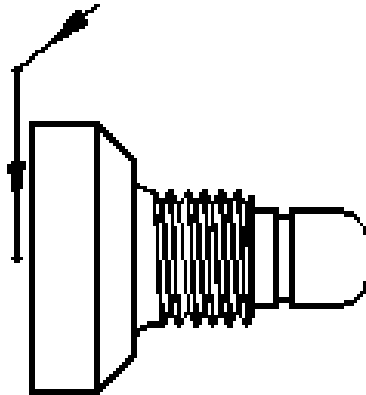

0017 CUTOFF CYCLE

Figure 21 - Cutoff Cycle Removes the Machined Part from the Stock – Program Line #0170.

PRESS	ACTION	COMMENTS
F10	Accept	Accepts values for cutoff cycle.

G. Save and Post the Program:

PRESS	ACTION	COMMENTS
ESC	Cancel	Returns you to Intercon’s main menu.
F8	Graph	Graphs the part one final time to be sure all steps were completed correctly. The final graph should be as shown in Figure 22.
ESC	Cancel	Returns you to the Intercon’s main menu.
F10	Post	Saves and posts job to control, creating G-codes for the program.

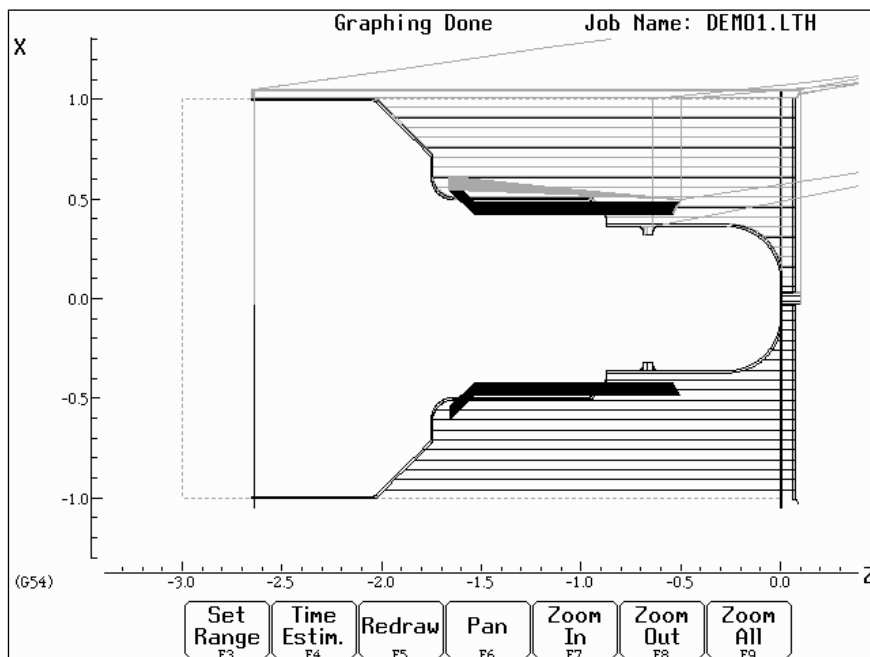

Figure 22 - Completed part

Chapter 10

CNC Program Codes

Code	Description
E,F	Feedrate or Thread Lead
N	Block Number
O	Program Number
P	Dwell Time, Subprogram Number, or General Parameter
Q	Depth Parameter or General Parameter
R	Radius, Taper, Return Point, or General Parameter
S	Spindle Speed
T	Select Tool Number and Offsets
U	Incremental X Move
W	Incremental Z Move
:	Visible Comment
;	Internal Comment
[]	Numerical Expression
\$	ASCII code substitution

The next three chapters contain a description of the CNC program codes and parameters supported by the T-Series Control. The T-Series Control has some G codes and parameters that are modal, and some that are non-modal (one shot). The G codes and parameters that are modal will stay in effect until a new G code or parameter is issued. One shots are effective for the current line only.

For example, a movement command of G01, which is modal, will remain in effect until a different movement command is issued, such as G00, G02, G03, etc.

Miscellaneous CNC Program Symbols

E, F - Feedrate or Thread Lead

In threading mode (G32, G76 and G92), E and F can specify thread lead (in units/rev). In other modes, only F can be used to specify feedrate. Feedrate is either units/rev or units/min, depending on G98/G99 mode. The feedrate override knob can be used to modify the programmed feedrate. The default feedrate is 3.0 units/minute.

Example:

```
G01 X1.0 Z-2 F0.1 ; linear cut at X1 to Z-2 at 0.1 units/rev
```

N - Block Number

Block numbers are used to identify CNC program lines. Block numbers are optional, but can be used with the Search Function (See Search option in Chapter 3) and make reading the NC files easier.

Example:

```
N1 G56 M26/Z
N2 G00 X0 Z0
```

O - Program Number

The O program number allows you to identify your program with a certain number. However, if the specified program number is 9100-9999, the G codes from the O number through the next M99 will be extracted (but not executed) and placed in a separate subprogram/macro file named Oxxxx.cnc, where xxxx is the specified program number. This separate file can later be called with M98 or G65.

Example:

```
O1521
N1 G56 M26/Z
N2 G00 X0 Z0
```

P - Parameter

P can correspond to Dwell Time, subprogram number, or a general parameter in canned cycles.

Examples:

```
G04 P1.32 ;Pause execution for 1.32 seconds
G98 P9100 L1 ;Call subprogram O9100.cnc
G10 P73 R.1 ;Set parameter #73 (G73 retract) to .1 inches
```

Q - Parameter

Q is used as a depth parameter in canned cycles or as a general parameter in canned cycles.

Example:

```
G76 X.75 Z-1.5 P.1 Q.02 F.125 ;Q Sets depth of first cut at .02"
```

R - Radius, Taper, Return Point, Parameter

R can represent the radius, a taper amount, a return point, or a general parameter. R is similar to P.

Examples:

```
G10 P5 R.0625 ;set nose radius of tool 5 = 0.0625
G90 X1.0 Z-2.0 R.25 F.0115 ;tapered cut, from 0.5" diameter to 1.0"
;diameter
```

S - Spindle Speed Setting

Specifying a spindle speed causes the automatic spindle speed setting to be immediately updated. It does not cause the spindle to start. In G97 mode (default), S specifies spindle speed in RPM. In G96 mode, S specifies surface speed in feet/min or meters/min.

Example:

```
S1400 M3 ;Starts the spindle CW at 1400 RPM
```

T - Select Tool Number and Offset Number

The T command takes the form of **Tt^{oo}**, where **tt** selects the Tool Number, and **oo** activates the Tool Offset.

If a T command selects a different **tt** number from the previous T command (or if this is the very first T command in a CNC program), then this will cause a tool change operation to be invoked. If a T command specifies the same **tt** as the previous T command but with a different **oo**, then no tool change will take place but will only activate the specified **oo** Tool Offset.

If **oo** is non-zero then this activates the tool offset data values from row **oo** of the Tool Geometry Offset Library (see Chapter 4). However, if **oo** is zero (00), then this cancels tool offsets.

Examples:

```

T0100      ;Tool change operation to Tool #01, cancel offsets
T0101      ;No tool change, but activate offsets #01
T0201      ;Tool change operation to Tool #02, keep offsets

```

U – Incremental X axis Move Command

To specify an incremental move on the X axis, use U in place of X in the command line. (See example below)

W – Incremental Z axis Move Command

To specify an incremental move on the Z axis, use W in place of Z in the command line. (See example below)

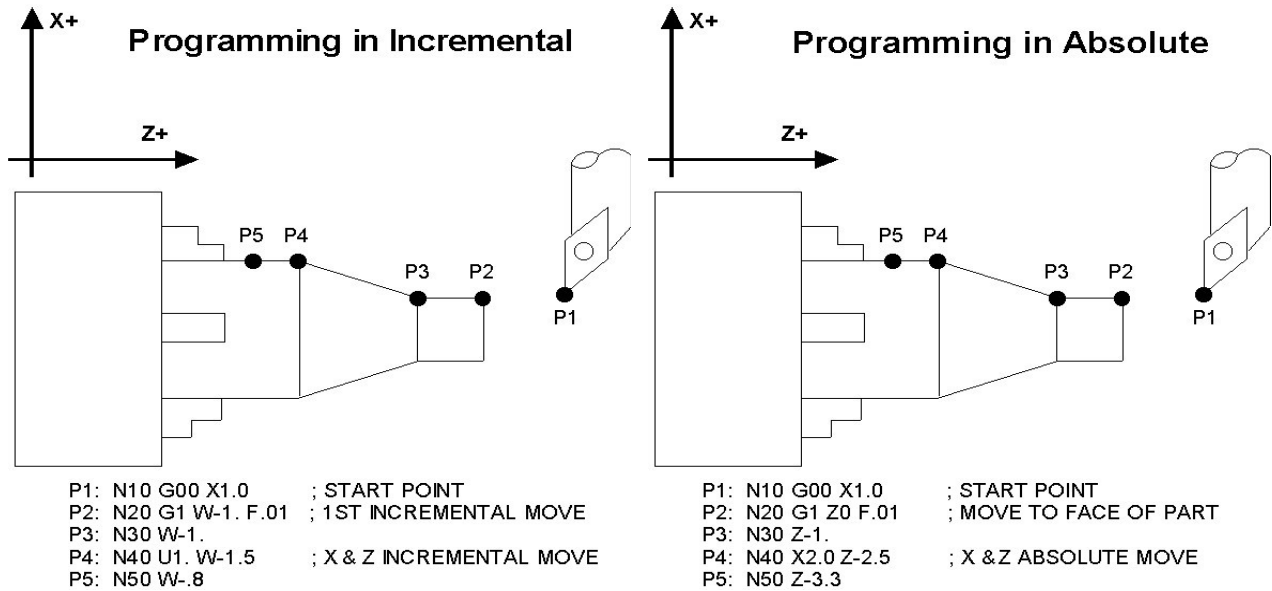

: - Visible Comment Identifier

The colon (:) is used to indicate the start of a comment line within a CNC program. The colon must be the first character on the line.

Examples:

```

: Select work coordinate 3
G56
: Rapid to part zero
G00 X0 Z0
: Visible comments will be displayed on screen with the G-codes.

```

; - Internal Comment Identifier

The semicolon (;) is used to indicate the start of an internal comment within a CNC program line. All characters after the semicolon are ignored when the program is run. Internal comments are used to document NC programs or temporarily omit the remainder of a line.

Examples:

```

G56      ; select work coordinate 3
G00      ; G00 selected with no movement

```

[] – Numerical Expression

The left bracket '[' and right bracket ']' are used to delimit a numerical expression. Numerical expressions can contain floating-point numbers or user and system variables in combination with mathematical operators and functions. The left parenthesis '(' or bracket '[' and right parenthesis ')' or bracket ']' can be used between the first left bracket and last right bracket to force operator precedence or associativity. A bracketed numerical expression can be used anywhere a number would be used. Comparison operators ('eq', 'ne', etc.) have built in rounding specified by parameter 144. Without this rounding, 'eq' would usually return "false" when comparing two numbers calculated in different ways. Comparison operators and logical operators ('!', '&&', '||') return 1.0 for "true" and 0.0 for "false".

The mathematical operators and functions are:

+	Addition (or unary positive)	#	Variable access
-	Subtraction (or unary negative)	eq or ==	Equals
*	Multiplication	ne or !=	Not equals
/	Division	ge or >=	Greater than or equals
^	Exponentiation	gt or >	Greater than
Mod or %	Modulo (remainder of a division)	le or <=	Less than or equals
abs	Absolute value	lt or <	Less than
sin	Sine (degrees)	not or !	Logical NOT
cos	Cosine (degrees)	&&	Logical AND
tan	Tangent (degrees)		Logical OR
sqrt	Square root	and	Bit-wise AND
asin	Arc Sine (degrees)	xor	Bit-wise exclusive OR
acos	Arc Cosine (degrees)	or	Bit-wise OR
atan	Arc Tangent (degrees)	~	Bit-wise complement

Examples:

```
U[13/64] W[1+3/8] ; move the X axis 13/64 (0.2031) units
                  ; and the Z axis 1 3/8 (1.375) units incrementally
X[SQRT[ABS[SIN[#101]-COS[#102]]]] ; Move X as a function of #101 and #102
```

\$ - ASCII Code Substitution

The '\$' symbol followed by an ASCII code is an alternate way of specifying a letter. Only ASCII codes 65 – 90 ('A' – 'Z') are valid. This substitution can be used where letter commands and axis labels are normally specified.

Examples:

```
G0 $88 2.0          ; Rapid move X to 2.0 ( Equivalent to G0 X2.0 )
$71 0 $[88+2] 3.0 ; Rapid move Z to 3.0 ( Equivalent to G0 Z3.0 )
M26 /$90           ; Set Z home ( Equivalent to M26 /Z )
```

User and System Variables

The '#' character is used to reference a macro or a user or system variable. For variables that can be written, the '=' is used to assign to them. General purpose user variables are #100 to #149 and #29000 to #31999.

Index	Description	Returns	R/W	
1-3	Macro arguments A-C	The floating point value if defined by a G65 call, 0.0 otherwise.	R/W	
4-6	Macro arguments I-K (1st set)		R/W	
7-9	Macro arguments D-F or 2nd set of I-K		R/W	
10	3rd I (G is invalid)		R/W	
11	Macro argument H or 3rd J		R/W	
12	3rd K (L is invalid)		R/W	
13	Macro argument M or 4th I		These can be used as private, local variables in any program or subprogram except in custom macro M functions. In custom macro M functions, the macro arguments are passed in by reference.	R/W
14	4th J (N is invalid)			R/W
15	4th K (O is invalid)			R/W
16	5th I (P is invalid)			R/W
17-18	Macro argument Q-R or 5th J-K			R/W
19-21	Macro arguments S,T,U or 6th set of I-K			R/W
22-24	Macro arguments V,W,X or 7th set of I-K			R/W
25-27	Macro arguments Y,Z or 8th set of I-K			R/W
28-30	9th set of I-K			R/W
31-33	10th set of I-K			R/W
100 - 149	User variables	Floating-point value. Initialized to 0.0 at start of job processing	R/W	
150 – 159	Nonvolatile user variables	Floating-point value saved in cnct.job.xml file.	R/W	
300-399	User string variables. These variables retain their values until the CNC software is exited	String Literal	R/W	
2400, 2401-2418	Active WCS, WCS #1-18 CSR angles (not used)	Floating point value	R/W	
2500, 2501-2518	Active WCS, WCS #1-18 Axis 1 values		R/W	
2600, 2601-2618	Active WCS, WCS #1-18 Axis 2 values		R/W	
2700, 2701-2718	Active WCS, WCS #1-18 Axis 3 values		R/W	
2800, 2801-2818	Active WCS, WCS #1-18 Axis 4 values		R/W	
2900, 2901-2918	Active WCS, WCS #1-18 Axis 5 values		R/W	
3000, 3001-3018	Active WCS, WCS #1-18 Axis 6 values		R/W	
3100, 3101-3118	Active WCS, WCS #1-18 Axis 7 values		R/W	
3200, 3201-3218	Active WCS, WCS #1-18 Axis 8 values		R/W	
3901	Parts Cut (Part #)			R/W
3902	Parts Required (Part Cnt)		R/W	
4001	Move mode	0.0 (rapid) or 1.0 (feed)	R	
4002	Constant surface speed mode	96.0 (on) 97.0 (off)	R	
4003	Positioning mode	90.0 (abs) or 91.0 (inc)	R	
4005	Feedrate mode	98.0 (units per min) or 99.0 (units per rev)	R	
4006	Units of measure	20.0 (inches) or 21.0 (metric)	R	
4014	WCS	54.0-71.0 (WCS#1-18)	R	
4109	Feedrate (F)	Floating point value	R	
4117	CSS spindle speed limit (specified by G50 S)		R	
4118	CSS spindle speed (specified by G96 S)		R	
4119	Spindle Speed (S)		R	
4120	Tool Number (“nm” in “Tnnoo”)		R	
4121	Current offset (“oo” in “Tnnoo”)	R		
4201	Job processing state	0 = normal, 1 = graph	R	

Index	Description	Returns	R/W
4202	Job Search mode	0 = search mode off 1 = searching for line number 2 = searching for block number N__ 3 = searching for Tool number 4 = resuming job	R
5021-5028	Machine Position (axis 1=5021, axis 2=5022, etc.)	Floating point value	R
5041-5048	Current Position (axis 1=5041, axis 2=5042, etc.)		R
9000-9399	Parameter values 0 – 399	See Chapter 14	R
9900-9999	Parameter values 900 – 999	See Chapter 14	R
10000	Lathe: Tool X offset amount, current offset	Floating point value	R/W
10001-10099	Lathe: Tool X offset amount, offsets 01 - 99	Floating point value	R/W
11000	Lathe: Tool Z offset amount, current offset	Floating point value	R/W
11001-11099	Lathe: Tool Z offset amount, offsets 01 - 99	Floating point value	R/W
12000	Lathe: Tool nose radius, current offset	Floating point value	R/W
12001-12099	Lathe: Tool nose radius, offsets 01 - 99	Floating point value	R/W
13000	Lathe: Tool nose vector, current offset	1 - 9	R/W
13001-13099	Lathe: Tool nose vector, offsets 01 - 99	1 - 9	R/W
14000	Lathe: Tool coolant, current tool	7, 8, 9	R/W
14001-14099	Lathe: Tool coolant, offsets 01 - 99	7, 8, 9	R/W
15000	Lathe: Tool spindle direction, current offset	3, 4, 5	R/W
15001-15099	Lathe: Tool spindle direction, offsets 01 - 99	3, 4, 5	R/W
16000	Lathe: Tool location, current offset	Floating point value	R/W
16001-16099	Lathe: Tool location, offsets 01 - 99	Floating point value	R/W
17000	Lathe: X wear adjustment, current offset	Floating point value	R/W
17001-17099	Lathe X wear adjustment, offsets 01 - 99	Floating point value	R/W
18000	Lathe: Z wear adjustment, current offset	Floating point value	R/W
18001-18099	Lathe: Z wear adjustment, offsets 01 - 99	Floating point value	R/W
19000	Lathe: nose radius wear adjustment, current offset	Floating point value	R/W
19001-19099	Lathe: nose radius wear adjustment, offsets 01 - 99	Floating point value	R/W
20001-20008	max_rate for axes 1-8		R
20101-20108	label for axes 1-8		R
20201-20208	slow_jog for axes 1-8		R
20301-20308	fast_jog for axes 1-8		R
20401-20408	screw_pitch for axes 1-8		R/W
20501-20508	lash_comp for axes 1-8		R
20601-20608	counts_per_unit for axes 1-8		R
20701-20708	accel_time for axes 1-8		R
20801-20808	deadstart_velocity for axes 1-8		R
20901-20908	delta_vmax for axes 1-8		R
21001-21008	counts_per_turn for axes 1-8		R
21101-21108	minus_limit for axes 1-8		R
21201-21208	plus_limit for axes 1-8		R
21301-21308	minus_home for axes 1-8		R
21401-21408	plus_home for axes 1-8		R
21501-21508	reversed for axes 1-8		R
21601-21608	laser_comp for axes 1-8		R
21701-21708	proportional for axes 1-8		R
21801-21808	integration_limit for axes 1-8		R
21901-21908	kg for axes 1-8		R
22001-22008	integral for axes 1-8		R
22101-22108	kv1 for axes 1-8		R
22201-22208	derivative for axes 1-8		R
22301-22308	ka for axes 1-8		R
22401-22408	num_motor_poles for axes 1-8		R
22501-22508	drive_current for axes 1-8		R
22601-22608	drive_offset_angle for axes 1-8		R

Index	Description	Returns	R/W
22701-22708	pwm_kp for axes 1-8		R
22801-22808	pwm_ki for axes 1-8		R
22901-22908	pwm_kd for axes 1-8		R
23001-23008	abrupt_kp for axes 1-8		R
23101-23108	feed_forward_kp for axes 1-8		R
23201-23208	max_error (PID) for axes 1-8		R
23301-23308	min_error (PID) for axes 1-8		R
23401-23408	at_index_pulse for axes 1-8		R
23501-23508	travel_minus for axes 1-8		R/W
23601-23608	travel_plus for axes 1-8		R/W
23701-23708	axis_home_set for axes 1-8		R
23801-23808	abs_position (in encoder counts) for axes 1-8		R
23901-23908	PID_out for axes 1-8		R
24001-24008	reference set for axes 1-8		R
24101-24108	Axis reference value for axes 1-8		R
24301-24308	dsp_positions for axes 1-8		R
24401-24408	abs_position (in encoder counts) for axes 1-8		R
24501-24508	dsp_positon in local coordinates for axes 1-8		R
24601-24608	local_probing +limit position for axes 1-8		R
24701-24708	local_probing -limit position for axes 1-8		R
24801-24808	probe_stylus compensation amount for axes 1-8		R
24901-24908	servo controlled axis indicator for axes 1-8	0 = no, 1 = yes	R
25000	DRO_display_units		R
25001	default_units_of_measure		R
25002	PLC_type		R
25003	console_type		R
25004	jog_panel_optional		R
25005	min_spin_high		R
25006	max_spin_high		R
25007	home_at_powerup		R
25008	screen_blank_time		R
25009	Displayed / Calculated spindle speed. If parameter 78 =1 and spindle encoder is mounted.		R
25010	current spindle position (in counts)		R
25011	dsp_time (in seconds)		R
25012	time (in seconds)		R
25013	clear max/min PID errors		R
25014	software type (Mill/Lathe)		R
25015	feedrate override		R
25016	spindle override		R
25017	OS	Windows/LINUX = 2; other OS = 1.0	R
25018	CNC series number (11 for CNC11)		R
25019	Software version number		R
25020	Software Beta revision number		R
25021	Digitizing boundary hit	hit = 1, not hit = 0	R
25022	last M115/116/125/126 probe trip	1 = tripped, 0 = not tripped	R
25023	Drive type	0 = Standard, 1 = Legacy DC, 2 = Legacy AC	R
25101-25108	Encoder counts away from index pulse for axes 1-8	Counts away from index pulse. Values less than 0 means that index pulse is not detected yet.	R
26001-26008	dsp_mechanical_machine_positions for axes 1-8		R
26101-26108	dsp_mechanical_local_positions for axes 1-8		R
26201-26208	local + travel limit position for axes 1-8		R
26301-26308	local - travel limit position for axes 1-8		R
26401-26404	Axis 1 reference points 1-4		R

Index	Description	Returns	R/W
26501-26504	Axis 2 reference points 1-4		R
26601-26604	Axis 3 reference points 1-4		R
26701-26704	Axis 4 reference points 1-4		R
26801-26804	Axis 5 reference points 1-4		R
26901-26904	Axis 6 reference points 1-4		R
27001-27004	Axis 7 reference points 1-4		R
27101-27104	Axis 8 reference points 1-4		R
27201-27208	ACDC drive estimated brake wattage for axes 1-8		R
27301-27308	Real motor encoder positions for axes 1-8	Motor encoder positions that accounts for lash, MPG, and scale offsets. (Note that these can be different from what is displayed as Abs Pos in the PID menu.)	R
27401-27408	Scale encoder positions for axes 1-8		R
29000-31999	User variables. These variables retain their values until the CNC software is exited.	Floating point value	R/W
50001-51312	PLC Inputs 1-1312	Jog Panel is on INP1057-1312	R
60001-61312	PLC Outputs 1-1312	Jog Panel is on OUT1057-1312	R
70001-71024	PLC Memory Bits 1-1024		R
80001-89999	Reserved		R
90001-90064	Timer 1-64 status bits		R
91001-91064	Reserved		R
92001-92064	Reserved		R
93001-93256	Stage 1-256 status bits		R
94001-94256	Fast Stage 1-256 status bits		R
95001-95256	Reserved		R
96001-96044	W1-W44 (32-bit signed integers)		R
97001-97022*	DW1-DW22 (64-bit signed integers)		R
98001-98044	FW1-FW44 (32-bit floats)		R
99001-99022	DFW1-DFW22 (64-bit floats)		R

* Since user or system variables are turned into (double) floating point values when referenced in an M- or G-code program, the 64-bit integer values lose precision when they exceed 2^{53} (9,007,199,254,740,992).

Examples:

```
#100 = #5041          ; set user variable #100 to the Z axis current position
G90 X[#5041+1+7/32] ; move the Z axis 1 7/32 units (1.2188) incrementally
#2501 = #5021        ; set WCS#1 Z value to the current Z position
#2503 =[#2503+1/8]  ; add 1/8 units (.125) to the WCS#3 Z value

; Subroutine parameter and local variable access.
G1 Z#A X#B F#F      ; move to the coordinates passed as parameters
#[Q] = #F * .10    ; Assign local variable #Q to 10% of #F
#17 = #7 * .10     ; Same statement as previous using number references.
#[C] = 0.05        ; Reassign #C. (Value passed as parameter is lost.)
```

Advanced Macro Statements

NOTICE

Branching and conditional execution are extremely powerful tools that, combined with access to system variables, allow you to do many things that would otherwise be impossible. Nevertheless, using branching and conditional execution can introduce undesirable and even unpredictable behavior into your programs. Undesirable effects can occur simply by graphing a program. The least of these undesirable effects could be entering an endless loop, failing to draw anything, or wiping out all the information in your tool library or WCS settings. It is your responsibility to make sure that undesirable things do not happen in your programs. You must monitor the job processing and search modes in your program, if necessary, and take appropriate action. Until you are confident of the actions of your program, you should step through it one block at a time to confirm your program logic.

GOTO - Branch Execution

To branch to another line within the same program or subprogram, use the statement

GOTO <expression>

Where <expression> is any expression that evaluates to a valid block number in the program. GOTO causes an immediate branch to the specified destination. Program codes preceding a GOTO on the same line will be executed normally. Any program codes following GOTO on the same line will cause an error.

If fast branching is disabled (parameter 145 = 0) then CNC11 searches forward in the program for the first matching block number and resumes searching, if necessary from the top of the program. For this reason when fast branching is disabled, backward branches take longer than forward branches and backward branch times depend on the total program size. If the program is sufficiently large, use of the GOTO statement could introduce temporary pauses.

When fast branching is enabled (parameter 145 = 1) then CNC11 remembers the locations of block numbers as it finds them during program execution. Backward branches always take place immediately. The first forward branch to a block not yet encountered will take additional time as CNC11 searches forward for the block number; however, subsequent forward branches to that block number will take place immediately. The trade-off for using fast branching is that all line numbers at a given level of program or subprogram must be unique and programs will use more memory (approximately 16kilobytes of memory for every 1000 block numbers in the program.)

IF THEN ELSE - Conditional Execution

Program symbols, G codes, M codes and GOTO commands may be executed conditionally using the IF statement. The general form of the IF statement is:

IF <expression> THEN <execute if true> ELSE <execute if false>

Where <expression> is any valid expression, <execute if true> is one or more program codes to execute if <expression> evaluates to “true” (non-zero) and <execute if false> is one or more program codes to execute if <expression> evaluates to “false” (zero). All parts of the IF statement must appear on the same line. The “ELSE <execute if false>” part of the statement is optional and may be omitted. The “THEN” may be omitted; however, <expression> must be enclosed in brackets ([]). The IF statement may follow other program codes on the same line. Compound conditionals are possible but they cannot be nested. The first THEN always pairs with the first IF. ELSE always pairs with the first <expression> that evaluates to “false”. All program codes executed are executed as part of the same block.

Examples:

```
; Branch to N200 if machine position is okay, otherwise go to N300
N100 IF #5041 LE 5.0 THEN GOTO 200 ELSE GOTO 300
; Force subprogram parameter #D to be within range.
IF [#D LE 0.005] #[D] = 0.005
; Compound conditionals
IF [#A LE 0.0] GOTO 100 ELSE IF [#A LE 2.5] GOTO 200 ELSE GOTO 300
IF [#A GE 0.0] IF [#D/#A GE 0.0] #[C] = SQRT[#D/#A]
```

INPUT – Prompt Operator for Input

The INPUT macro prompts the operator for numeric input. The general form of the INPUT statement is:

```
INPUT “<prompt>” <variable>
```

Where <prompt> is the message prompt for the operator and <variable> is the variable in which to store the input. CNC11 will display a dialog with the given prompt and space for the operator response. The operator may enter any numeric expression (see above) including variables as a response. The operator must press **CYCLE START** or **Alt-S** to dismiss the dialog. Pressing **Esc** will cancel the job.

CNC11 parses well ahead of the current execution to maximize throughput and efficiency. For this reason, an INPUT macro may prompt the operator for input immediately even though the INPUT macro is located in the middle or near the end of the job. (Use the “IF #6001” idiom to delay the prompt, if desired.) Parsing pauses while the dialog is displayed. Any statements parsed prior to the INPUT macro will have been queued and will continue to execute in the background while the prompt is displayed. Job processing will pause only if all queued statements have been executed before the operator supplies a response.

INPUT macros will not graph. If you must graph the job, first set the input variable to a default value and use a conditional to execute the INPUT only if the job is being run normally.

Use search mode cautiously with INPUT macros. To have search work properly, you may have to supply exactly the same input during the search as you did during the last actual run.

Examples:

```
; Ask operator for pocket depth. Store result in #101
; Note: this will not graph.
INPUT “Enter pocket depth” #101

; Allow job with INPUT statements to be graphed.
#101 = 0.5; Supply a default value for graphing
; Ask for operator input only if not graphing.
IF NOT #4201 THEN INPUT “Enter pocket depth” #101
```

CHAPTER 11

G Codes

G Code		Group	Description
G00	*	A	Rapid Positioning
G01		A	Linear Interpolation
G02		A	Circular or Helical Interpolation CW
G03		A	Circular or Helical Interpolation CCW
G04		B	Dwell
G10		B	Parameter Setting
G20	*	K	Select Inch Units
G21		K	Select Metric Units
G22		O	Work envelope on
G23	*	O	Work envelope off
G28		B	Return to Reference Point
G29		B	Return from Reference Point
G30		B	Return to Secondary Reference Point
G32		A	Constant Lead Thread Cutting
G40	*	D	Cutter Diameter Compensation Cancel
G41		D	Cutter Diameter Compensation Left
G42		D	Cutter Diameter Compensation Right
G50		B	Coordinate System Setting, Max. Spindle Speed Setting
G52		B	Offset Local Coordinate System
G53		B	Rapid Position in Machine Coordinates
G54		L	Select Work Coordinate System #1
G55		L	Select Work Coordinate System #2
G56		L	Select Work Coordinate System #3
G57		L	Select Work Coordinate System #4
G58		L	Select Work Coordinate System #5
G59		L	Select Work Coordinate System #6
G65		J	Call Macro
G70		B	Profile Finishing Cycle
G71		B	Profile Stock Removal in Turning
G72		B	Profile Stock Removal in Facing
G73		B	Profile Path Repeating Cycle
G74		B	End Face Peck Cutting Cycle
G75		B	Outer/Inner Diameter Peck Cutting Cycle
G76		B	Multi-Pass Threading Cycle
G80	*	B	Cancel Canned Cycle
G83		B	Deep Hole Drilling
G84		B	Tapping
G85		B	Boring Cycle
G90		A	Outer/Inner Diameter Cutting Cycle
G92		A	One-Pass Threading Cycle
G94		A	End Face Cutting Cycle
G96		H	Constant Surface Speed
G97	*	H	Constant Surface Speed Cancel
G98		I	Per Minute Feed
G99	*	I	Per Revolution Feed

NOTES:

- All the default G Codes have been marked with the symbol " * ".
- A given line of a program may contain more than one G code.
- If several G codes from one group are used in the same line, only the G code specified last will remain active.
- G codes from group B are of "one shot" type (active only in the line in which they are specified). All other G codes are modal (active until another G code of the same group is specified).

G00 - Rapid Positioning

G00 moves to the specified position at the maximum motor rate. The coordinates may be either absolute positions or incremental distances. G00 is modal and remains in effect until another positioning mode (G1, G2, G3 etc.) is commanded. G00 is the default-positioning mode.

Example:

```
G00 X0.0 Z0.0
```

This command moves both X and Z to the absolute coordinate 0.0 at maximum feedrate.

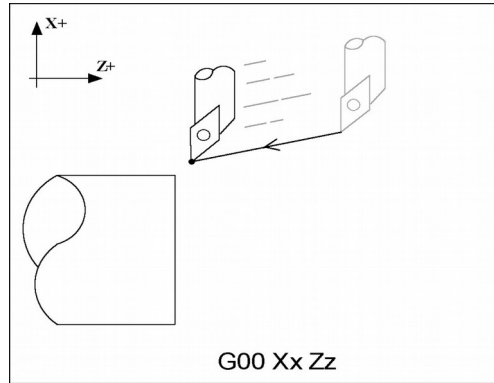

CAUTION The feedrate override knob has no effect on G00 moves unless rapid override is turned ON

G01 - Linear Interpolation

G01 moves to the specified position at the programmed feedrate. The coordinates may be either absolute positions or incremental distances. The movement will be along a straight line. G01 is modal and remains in effect until another positioning mode (G0, G2, G3 etc.) is commanded.

Example:

```
G01 X2 Z4 F10  
G01 X6 Z3 F20
```

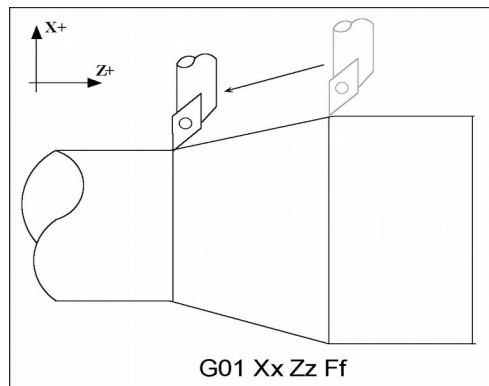

G02 & G03 - Circular Interpolation

G2 moves in a clockwise* circular motion, and G3 moves in a counterclockwise* circular motion. The X or Z position specified in the G2 or G3 command is the end position of the arc, and may be an absolute position (X, Z) or an incremental distance (U, W). G2 and G3 are modal and remain in effect until another positioning mode (G0, G1, etc.) is commanded.

Circular motion can be programmed in two different ways: specifying the final point and the radius of the arc, or specifying the final point and the parameters I and K (center point of the arc as incremental values from the start position).

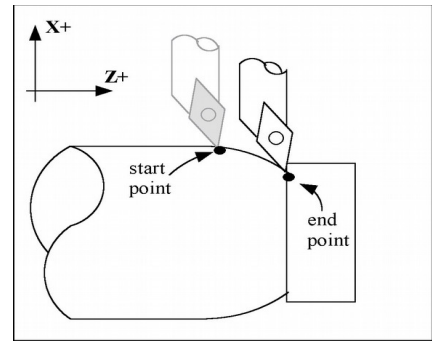

*The terms clockwise and counterclockwise can be somewhat confusing because they are relative directions which change based on one's perspective. To help conceptualize the correct perspective, always program your part and set up your tools as though the machine were a horizontal lathe with the tool post mounted in the rear and the head stock to your left.

Rules of thumb:

1. All Convex OD Arcs which move towards a more negative Z position should be programmed as CCW.
2. All Concave OD Arcs which move towards a more negative Z position should be programmed as CW.
3. All Convex OD Arcs which move towards a more positive Z position should be programmed as CW.
4. All Concave OD Arcs which move towards a more positive Z position should be programmed as CCW.
5. All Convex ID Arcs which move towards a more negative Z position should be programmed as CCW.
6. All Concave ID Arcs which move towards a more negative Z position should be programmed as CW.
7. All Convex ID Arcs which move towards a more positive Z position should be programmed as CW.
8. All Concave ID Arcs which move towards a more positive Z position should be programmed as CCW.

METHOD 1: USING FINAL POINT AND RADIUS

The commands G2 and G3 will have the following structure:

```
G2 Xx Zz Rr
G3 Xx Zz Rr
```

where x and z will be the X and Z coordinates of the final point of the arc, and r will be the radius.

Example:

```
G00 X2.0 Z1.0 ;rapid to start
                ;position X2, Z1
G02 X4.0 Z2.0 R1 ;arc to X4 Z2 with
                ;radius of 1
```

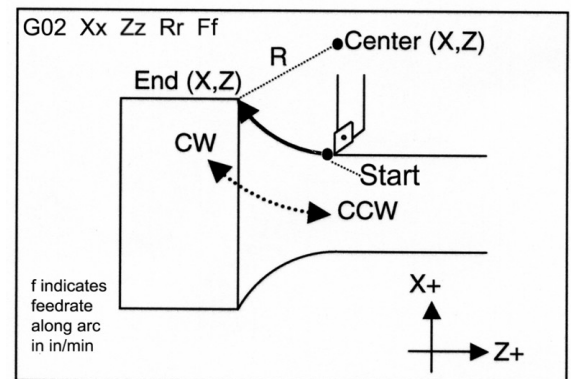

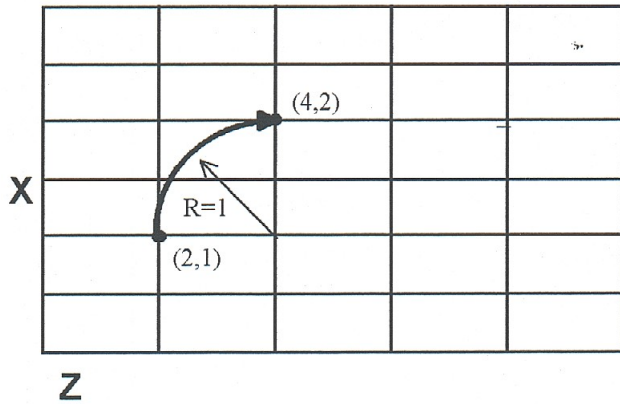

NOTE: A lathe is not usually used to cut an arc larger than 90 degrees. With the use of special tools, a lathe can cut a 180-degree arc. This is the maximum value a lathe can cut an arc. Make sure the radius chosen follows the cutting ability of the lathe.

METHOD 2: USING FINAL POINT AND PARAMETERS I & K

Another way to specify a circular operation is using the parameters I and K instead of the radius R. The parameters I and K are the **incremental** distances from the start point to the center of the arc.

$$I = X \text{ center (radius)} - X \text{ start (radius)}$$

$$K = Z \text{ center} - Z \text{ start}$$

• **NOTE:** X coordinates are diameter values, but I and R are always radius values.

Example:

```
G00 X2.0 Z1.0 ;rapid to start
;pos. X2, Z0
G02 X4.0 Z2.0 K1 ;arc to X4 Z1
with radius 1
```

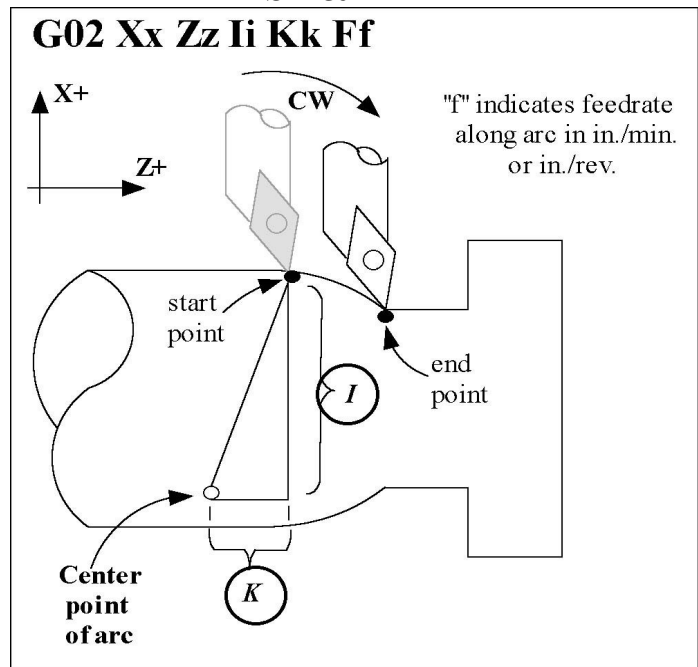

G04 - Dwell

G4 causes motion to stop for the specified time. The P parameter is used to specify the time in seconds to delay. G4 causes the block to decelerate to a full stop.

The minimum delay is 0.01 seconds and the maximum is 327.67 seconds. The dwell time is performed after all motion and M functions on the line. If the P parameter is not specified, X will be used instead. If neither P nor X is specified, the default dwell time of 0.01 seconds will be used.

Example:

```
G0 X1 Z1 ; rapid to X1 Z1
G4 P2.51 ; pause for 2.51 seconds
G0 X2 Z2 ; rapid to X2 Z2
```

G10 - Parameter Setting

G10 allows you to set parameters for different program operations.

Examples:

```
G10 P5 Z-1.1      ; Sets tool #5 z offset to -1.1 in the Offset Library
G10 P5 X-1.3      ; Sets tool #5 x offset to -1.3 in the Offset Library
G10 P5 R.25       ; Sets tool #5 nose radius to .25 in the Offset Library
G10 P5 Q3         ; Sets tool #5 nose vector to 3 in the Offset Library
G10 P1073 R.05    ; Sets machine parameter 73 to 0.05
```

G20 - Select Inch Units

G20 selects inch units, affecting the interpretation of all subsequent dimensions and feedrates in the job file. G20 does not change the native machine units as set on the Control Configuration Menu.

G21 - Select Metric Units

G21 selects metric units, affecting the interpretation of all subsequent dimensions and feedrates in the job file. G21 does not change the native machine units, as set on the Control Configuration Menu.

G22/G23 – Work Envelope On/Off

G22 turns on programmable work envelope in machine coordinates. When the machine tries to move into the forbidden area an “axis work envelope exceeded” message is displayed letting you know which line of the program is at fault. The work envelope is set with the Z and X for the ‘+’ limit and I and J for the ‘-’ limit. G22 is modal and remains on until turned off by G23 or the end of the job. The limits entered in the Z, X and I, J parameters are stored in the WCS menu under <F3> Work Envel.(see chapter 5).

G28 - Return to Reference Point

G28 moves to the first reference point, by way of an intermediate point. The location of the reference point, in machine coordinates, may be set in the Work Coordinate System Configuration menu. The intermediate point is specified in the local coordinate system, and may be at the current location (resulting in a move directly to the reference point). If an intermediate point is specified, only those axes for which positions are specified will be moved. If no axes are specified, only the X and Z axes will be moved. The location of the intermediate point is stored for later use with G29.

Examples:

```
G28 W0           ; move Z axis directly to reference point
                  ; (X doesn't move)

G28 U.5 W0       ; move X +.5, then move BOTH axes to
                  ; reference point

G28 X2 Z.1       ; move both axes to (2,0.1), then to
                  ; reference point

G28              ; move all axes to the reference point
                  ; (no intermediate point)
```

The G28 position is of great importance because it specifies the Tool Check position and the usual Tool Change position. The G28 position is the machine coordinate position that the machine will move to when the <TOOL CHECK> button is pressed. Also, the G28 position is the usual position at which tool changes occur during a job run.

G29 - Return from Reference Point

G29 moves the X and Z axes to the intermediate point stored in a preceding G28 or G30 command. It may be used to return to the workpiece. If a position is specified, the machine will move to that position (in local coordinates) after reaching the intermediate point. G29 may only be specified after G28 or G30, though there may be intervening moves.

Examples:

```
G29           ; move X and Z axes back from reference point to
              ;intermediate point
G29 X1 Z2    ; move X and Z axes to intermediate point, then move to X1 Z2
```

G30 - Return to Secondary Reference Point

G30 moves to a specified return reference point, by way of an intermediate point. The P parameter may be used to specify one of the 4 available Return Reference Points: The intermediate point is specified in the local coordinate system, and may be at the current location (resulting in a move directly to the reference point). If an intermediate point is specified, only those axes for which positions are specified will be moved. If no axes are specified, all axes will be moved. The location of the intermediate point is stored for later use with G29.

The 4 available return reference points are defined in the Work Coordinate System Configuration menu. If you issue G30 without a P parameter, it functions exactly like G28, except that by default it uses the second reference return point.

The following table shows how to issue G-codes to utilize the 4 available Return Reference Points:

Return Reference Point	G-Code	Equivalent Alternate G-Code
Return #1	G28	G30 P1
Return #2	G30	G30 P2
Return #3	G30 P3	---
Return #4	G30 P4	---

Examples:

```
G30 Z0       ; move Z axis directly to second reference point
G30 P1       ; move all axes to first reference point
```

- NOTE: G30 P1 is equivalent to G28.

G32 - Constant Lead Thread Cutting

G32 sets the constant lead thread cutting mode. During this mode, both axes are locked to the spindle encoder count. Once the encoder outputs a 1 turn signal, thread cutting is started at a fixed point so that the tool path remains unchanged for repeated thread cutting. Thread cutting follows the same tool path in rough cutting through finish cutting.

- NOTE: When G32 is used, X and Z indicate the endpoint of the cut and F indicates the lead. Also, E can be used instead of F.

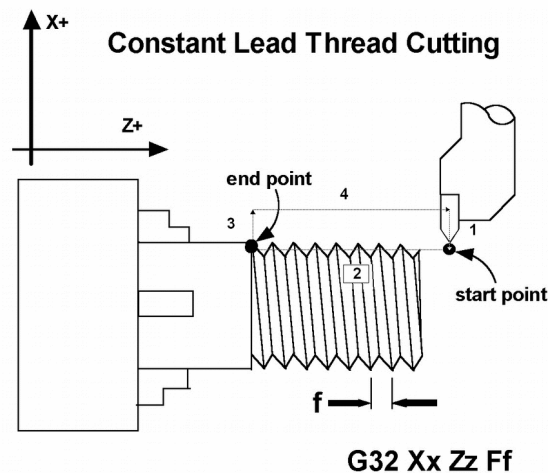

Example:

```
G00 X1.5 Z0.0      ; Step 1 - rapid move
G32 X1.5 Z-2.0 F0.125 ; Step 2 - straight
                    ; thread cut of 2 inches, lead of .125
                    ; or 8 threads per inch
G00 X1.7          ; Step 3 - Clear X-axis
G00 z0.0          ; Step 4 - Retract Z-axis
```

G40, G41, G42 –Cutter Diameter Compensation

G41 and G42 in conjunction with the selected tool (T code) apply cutter compensation to the programmed tool path. Cutter compensation is required whenever an angle or radius is being cut. G41 offsets the tool selected with the T code the amount of its nose radius, to the left of the workpiece, relative to the direction of travel. G42 offsets the tool selected with the T code the amount of its nose radius, to the right of the workpiece, relative to the direction of travel. G40 cancels G41 and G42.

Always program cutter compensation as though the machine were a horizontal lathe with the tool post mounted in the rear and the head stock to your left.

Rules of Thumb:

1. All OD moves which move towards a more negative Z should use cutter comp right.
2. All OD moves which move towards a more positive Z should use cutter comp left.
3. All ID moves which move towards a more negative Z should use cutter comp left.
4. All ID moves which move towards a more positive Z should use cutter comp right.

Example:

```
G41 T03          ; Tells the machine to compensate left the amount of the
                  ; nose radius that corresponds to T03 in the Offset
                  ; Library.
```

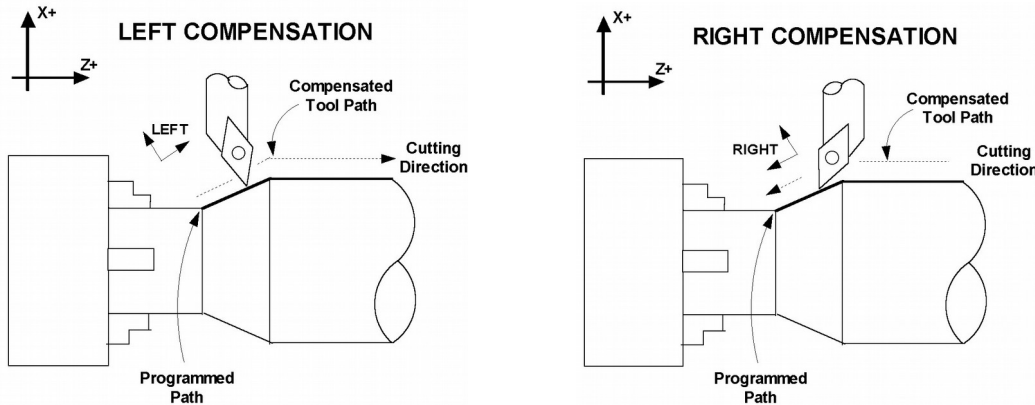

Imaginary Tool Nose

Tool nose compensation is necessary to prevent under-cutting (not cutting enough material) on diagonal lines and arcs. Tool nose compensation does not affect horizontal and vertical lines because in those cases the actual tool nose is at the same depth as the imaginary tool nose. When tool nose compensation is not used, it is the imaginary tool nose that moves to the programmed position and not the cutter. Cutter compensation adjusts for the difference in position by moving the actual tool nose to the programmed position.

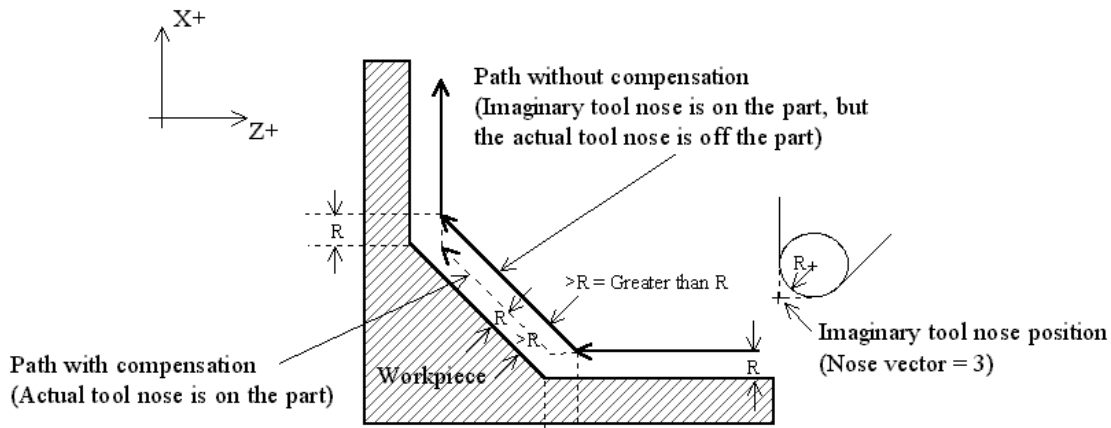

Example with tool located on back side of material.

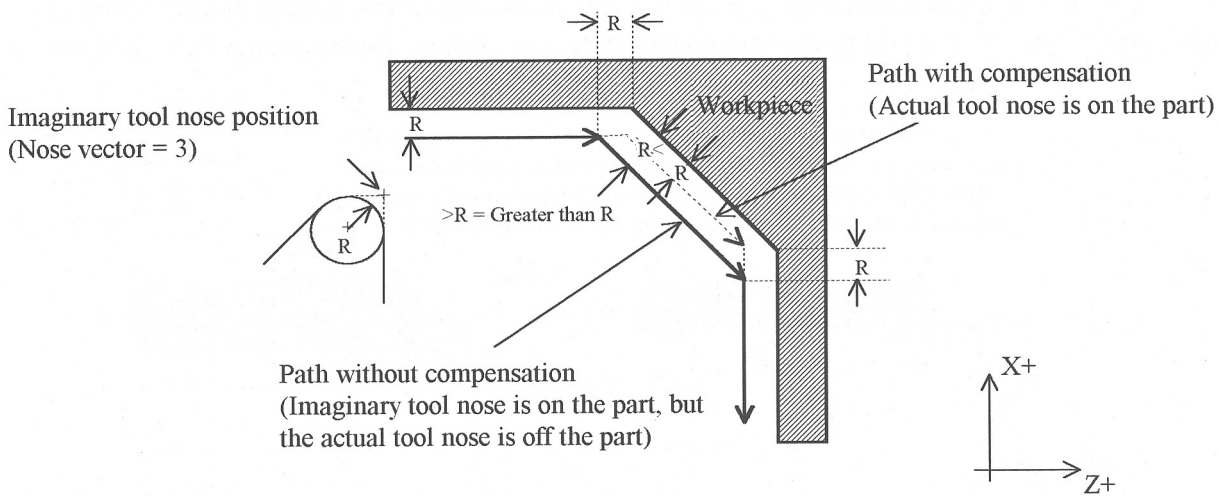

Example with tool located on front side of material.

The direction of the imaginary tool nose is related to the nose vector or direction of the tool during cutting (see Chapter 4). The following drawings show the possible imaginary tool nose directions. Imaginary Tool Nose directions (tool located in back of material):

Imaginary Tool Nose # 1 	Imaginary Tool Nose # 2 	Imaginary Tool Nose # 3 	Imaginary Tool Nose # 4
Imaginary Tool Nose # 5 	Imaginary Tool Nose # 6 	Imaginary Tool Nose # 7 	Imaginary Tool Nose # 8
Imaginary Tool Nose # 0 or 9 			

The tool nose compensation function (G41 or G42) should be in effect before the tool reaches the cutting start point..

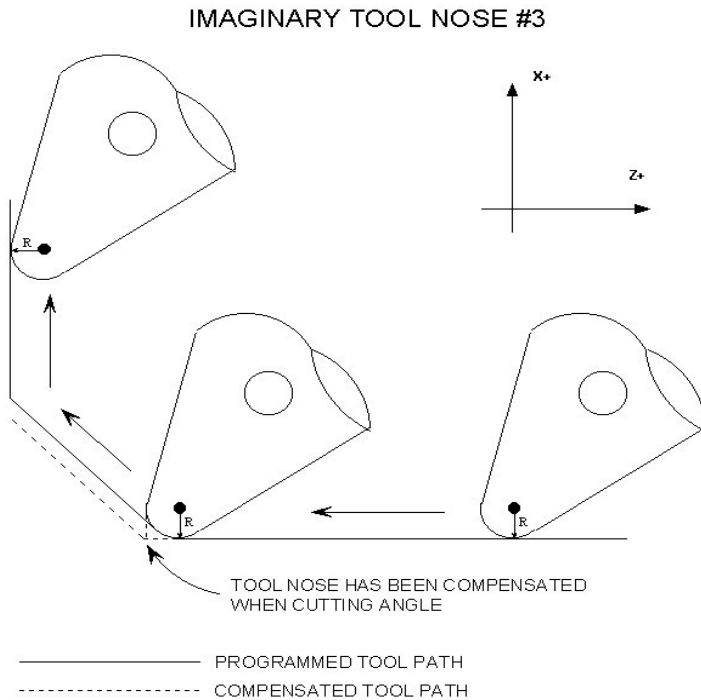

G50 -Coordinate System Setting OR Maximum Spindle Speed for CSS mode

G50 has two functions depending on the supplied parameters:

- With axis parameters, G50 sets the current absolute position to the coordinates specified OR
- With the S parameter, G50 sets the maximum spindle speed when using constant surface speed (see G96 and G97).

Examples:

```
G00 X5 Z-2 ; moves to the specified location
G50 X1 Z0 ; sets the current position to the absolute position
; specified.
G50 S2500 ; limit spindle to 2500 rpm in G96 mode, no matter how
; close X gets to 0.
```

G52 - Offset Local Coordinate System

G52 shifts the local coordinate system origin by a specified distance. Multiple G52 codes are not cumulative; subsequent shifts replace earlier ones. The G52 shift may therefore be canceled by specifying a shift of zero. If you are using multiple coordinate systems, the G52 shift amount will affect all coordinate systems.

Example:

```
G0 X0 Z0 ; move to origin
M98 P9100 ; call subprogram
G52 Z4 ; shift coordinate system 4 inches in Z
G0 X0 Z0 ; move to new origin
M98 P9100 ; call subprogram again with new coordinates
G52 Z0 ; restore unshifted coordinate system
```

G53 - Rapid Positioning in Machine Coordinates

G53 is a one-shot code that performs a rapid traverse using machine coordinates. It does not affect the current movement mode (G00-G03) or coordinate system (G54-G59).

Example:

```
G53 X15 Z0 ; move to 15,0 in machine coordinates
```

G54 - G59 - Select Work Coordinate System

G54 through G59 select among the six regular work coordinate systems (WCS #1 through WCS #6). After issuing the code, subsequent absolute positions will be interpreted in the new coordinate system.

Example:

```
G54 G00 X0 Z0 ; select first WCS, move to origin
G02 X1 Z-.5 R.5 ; cut something...
G55 G00 X1 Z1 ; select second WCS, move to X1,Z1
```

Using Extended Work Coordinate Systems: There are 12 additional work coordinate systems available as an extra-cost option. In a G-code program, these 12 additional work piece origins may be selected with “G54 P1” (WCS # 7) through “G54 P12” (WCS #18).

Regular WCS

WCS	G-Code
WCS #1	G54
WCS #2	G55
WCS #3	G56
WCS #4	G57
WCS #5	G58
WCS #6	G59

Extended Work Coordinate Systems (optional)

WCS	G-Code
WCS #7	G54 P1
WCS #8	G54 P2
WCS #9	G54 P3
WCS #10	G54 P4
WCS #11	G54 P5
WCS #12	G54 P6
WCS #13	G54 P7
WCS #14	G54 P8
WCS #15	G54 P9
WCS #16	G54 P10
WCS #17	G54 P11
WCS #18	G54 P12

G65 - Call Macro

G65 calls a macro with user-specified values. A macro is a subprogram that executes a certain operation (e.g. linear cut, threading, etc.) with values assigned to variable parameters within the operation.

Calling methods:

```
G65 Pxxxx Lrrrr Arguments
```

or

```
G65 "program.cnc" Lrrrr Arguments
```

where *xxxx* is the macro number (referring to file *Oxxxx.cnc*, 0000-9999 allowed, leading zeros required in filename, capital O, lower-case .cnc), *rrrr* is the repeat value, "program.cnc" is the name of the macro file, and *Arguments* is a list of variable identifiers and values. Arguments to macro calls are specified by using letters A-Z, excluding G, L, N, O, and P.

Macros are written just like normal programs. However, macro programs may access their arguments by using #A, #B, etc., or by using numbers: #1 for A, #2 for B, etc. (exceptions: #4-6 for I-K, #7-11 for D-H). Arguments I, J, and K can be used more than once in a macro call, with the first set of values stored as #4-6, the second as #7-9, etc., to a maximum of 10 sets.

Macros 9100 - 9999 may be embedded into a main program, using O91xx to designate the beginning of the macro and M99 to end it. The CNC software will read the macro and generate a file O91xx.cnc, but will not execute the macro. It will be executed when G65 is issued.

Example 1:

Main program:

```
G65 "TEST.cnc" A5 B3
```

Macro TEST.cnc:

```
G01 X#B Z-#A
```

This call will produce:

```
G01 X3 Z-5
```

Example 2:

Main program:

```
G65 "TEST2.cnc" I3 J-5 K0.1 I2 J-2 I0 J0
```

Macro TEST2.cnc:

```
G01 X#4 Z#5 F#6
```

```
G01 X#7 Z#8
```

```
G01 X#10 Z#11
```

This call will produce:

```
G01 X3 Z-5 F0.1
```

```
G01 X2 Z-2
```

```
G01 X0 Z0
```

G70 – Profile Finishing Cycle

The G70 finishing cycle is used for applying finish cut passes on a defined profile path by removing material purposely left behind by a previously run “roughing” cycle (G71, G72 or G73). Cutter compensation can be used with this cycle. The feedrate, spindle speed and tool can be different than those used on the “roughing” cycle.

Command Format:

G70 P_ Q_ U_ W_

P = Starting Block number of finish profile path

Q = Ending Block number of finish profile path

U = Finishing Offset in X direction *

W = Finishing Offset in Z direction

Description of P and Q:

P and Q are required parameters.

P and Q (Starting/Ending Block numbers) do not need to match those used in the “roughing” cycle.

The P and Q parameters must refer to G-code lines occurring before the G70 finishing cycle and not after.

Description of U and W:

The U and W parameters are optional and default to U0 and W0 if not specified.

U and W axis direction signs are computed automatically by the control software.

The G70 cycle has 2 different behaviors depending on the setting of Parameter 274:

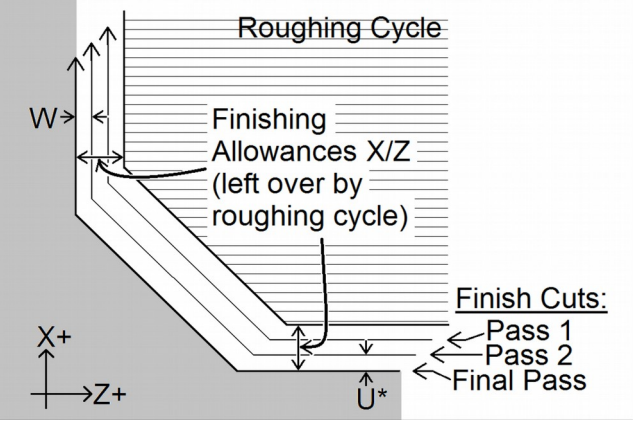
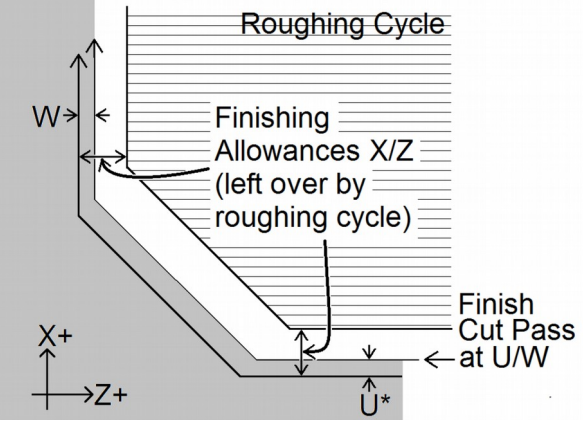
G70 Multi-pass Behavior Enabled (Parameter 247 = 0)	G70 Single Pass Mode (Parameter 247 = 1)
	
<p>The number of finish cut passes is the larger of the number of times U or W can be divided into their respective X/Z Finish Allowances from a previously run G71/G72/G73 roughing cycle. The resultant finish cut passes generated will be evenly offset from each other. The final pass will be done on the defined profile path without any X/Z offset.</p> <p>However, if U and W are not specified (or is specified as U0 W0), then a single finish cut pass will be done on the defined profile path without any X/Z offset.</p>	<p>A single finish cut pass will be done at the specified cut level. U and W sets the X/Z cut level. A non-zero U or W will leave material behind.</p> <p>This behavior is industry standard.</p>

*The U value is subject to Radius/Diameter mode of the machine (as set by Parameter 55 – see Chapter 14).

If codes such as F, S, T and G4 P_ are encountered in the profile, they will be executed by the G70 finishing cycle, unlike a “roughing” cycle such as G71, G72 or G73 which ignore them.

G71 – Profile Stock Removal in Turning

The G71 cycle removes material by using a series of cutting passes parallel to the Z axis and moving away from the Start Point. Each successive cutting pass is done at a progressively deeper turning diameter in the X axis direction incrementing away from the Start Point. The whole cycle is limited to within the confines of the Start Point and a defined profile path (specified via P and Q). The Start Point is wherever the cutter is sitting when the G71 cycle is invoked with P and Q parameters. When all the Z-parallel cuts are done, a single rough cut pass is then run along the profile path. The cycle can perform both inner and outer diameter cleanouts and the profile path can be cutter compensated. The whole cycle can be optionally offset by U and W to leave material behind in preparation for the G70 Finishing Cycle. Also the Z-parallel cuts themselves can be optionally offset by I and K to further separate them from the single rough cut pass. Note that the axis direction signs for U, W, I and K are computed automatically by the control software.

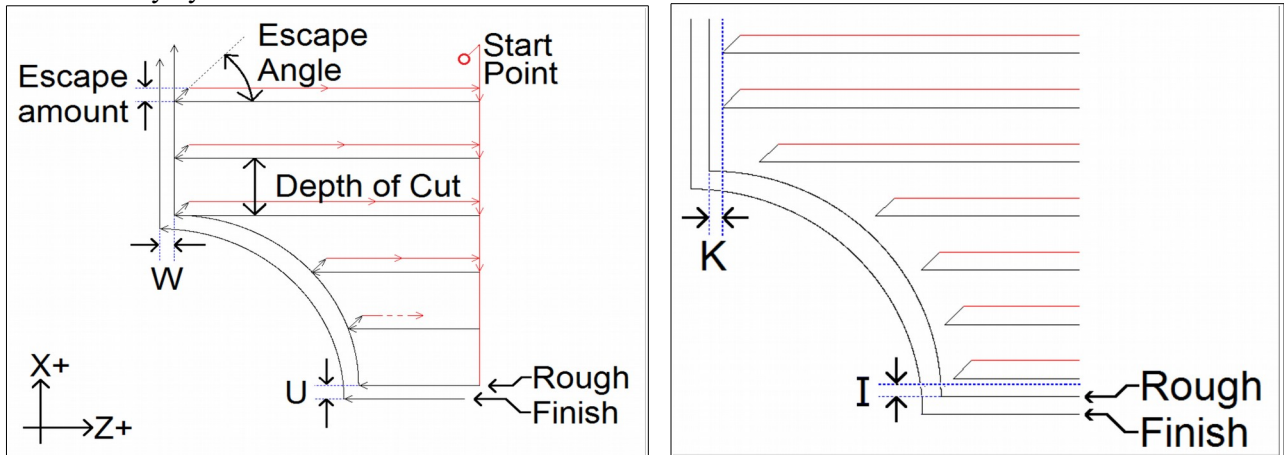

G71 has two forms:

2 Line Format	1 Line Format
Line 1: G71 U_ R_ Line 2: G71 P_ Q_ U_ W_ I_ K_ A_	G71 P_ Q_ D_ U_ W_ I_ K_ A_
Line 1 U = Depth of Cut * Line 1 R = Escape amount Line 2 P = Starting Block number of profile path Line 2 Q = Ending Block number of profile path Line 2 U = Finishing Allowance in X direction * Line 2 W = Finishing Allowance in Z direction Line 2 I = Roughing Allowance in X direction Line 2 K = Roughing Allowance in Z direction Line 2 A = Escape Angle	P = Starting Block number of profile path Q = Ending Block number of profile path D = Depth of Cut † U = Finishing Allowance in X direction * W = Finishing Allowance in Z direction I = Roughing Allowance in X direction K = Roughing Allowance in Z direction A = Escape Angle

* U values are always in radius regardless of Radius/Diameter mode of the machine (as set by Parameter 55 – see Chapter 14).

† D value is subject to the “implied floating point” re-interpretation rules of Parameters 245 and 246.

P and Q are required parameters.

U and W Finishing Allowances are optional and default to U0 and W0 if not specified.

I and K are optional and default to I0 and K0 if not specified.

The modal default for Depth of Cut is from Parameter 43.

The modal default for Escape Amount is from Parameter 44.

The modal default for Escape Angle is from Parameter 58.

The profile path needs to be defined after the G71 P_ Q_. The first and last G-code lines of the profile path must be tagged with the N block numbers so that P and Q can refer to them. If there are any G-code lines occurring after the G71 P_ Q_ and before the first G-code line of the profile path, those lines will not be run by this cycle, but they can be referenced later by a G70 P_ Q_ Finishing Cycle.

Note that any F, S, T and G4 P_ codes encountered in the profile path will be ignored by the G71 cycle.

G71 Example:

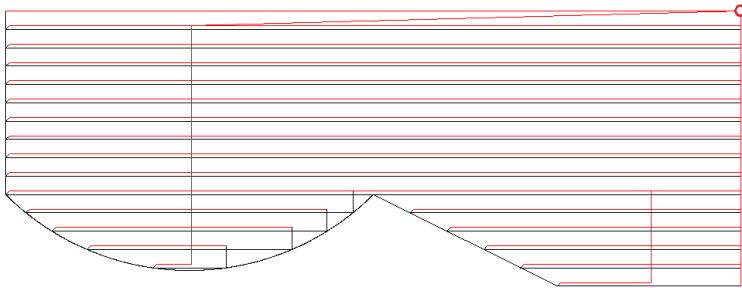

```
G0 X3 Z0 ; Rapid to Start Point
G71 U.05 R.01 ; Set Depth of Cut and Escape Amt
G71 P10 Q20 F.02 S800 ; Cleanout Profile at N10 to N20
N10 G0 X1.5 ; PROFILE first block
G1 X1.5 Z-.5 ; PROFILE
G1 X2 Z-1 ; PROFILE
G2 X2 Z-2 I.5 K-.5 ; PROFILE
N20 G1 X3 ; PROFILE last block
```

G72 – Profile Stock Removal in Facing

The G72 cycle removes material by using a series of cutting passes parallel to the X axis and moving away from the Start Point. Each successive cutting pass is done at an incrementally progressing Z face in the direction away from the Start Point. The whole cycle is limited to within the confines of the Start Point and a defined profile path (specified via P and Q). The Start Point is wherever the cutter is sitting when the G72 cycle is invoked with P and Q parameters. When all the X-parallel cuts are done, a single rough cut pass is then run along the profile path. The profile path can be cutter compensated. The whole cycle can be optionally offset by U and W to leave material behind in preparation for the G70 Finishing Cycle. Also the X-parallel cuts themselves can be optionally offset by I and K to further separate them from the single rough cut pass. Note that the axis direction signs for U, W, I and K are computed automatically by the control software.

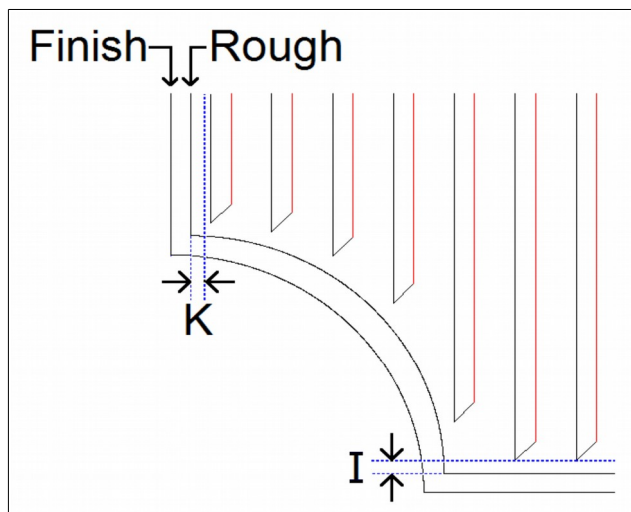
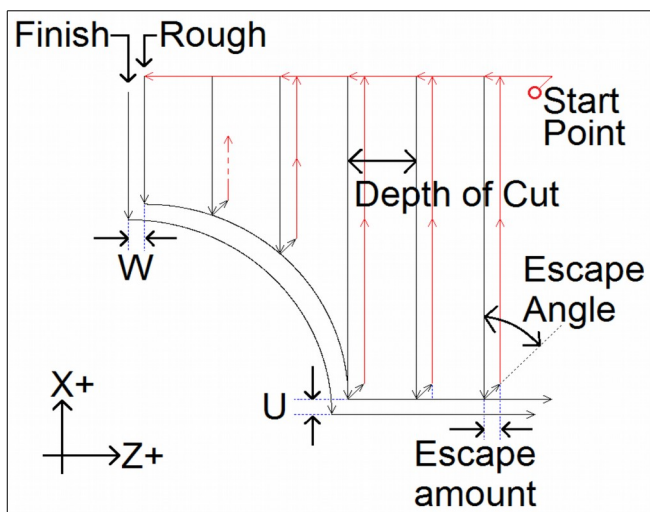

G72 has two forms:

2 Line Format	1 Line Format
Line 1: G72 W_ R_ Line 2: G72 P_ Q_ U_ W_ I_ K_ A_	G72 P_ Q_ D_ U_ W_ I_ K_ A_
Line 1 W = Depth of Cut Line 1 R = Escape amount Line 2 P = Starting Block number of profile path Line 2 Q = Ending Block number of profile path Line 2 U = Finishing Allowance in X direction * Line 2 W = Finishing Allowance in Z direction Line 2 I = Roughing Allowance in X direction Line 2 K = Roughing Allowance in Z direction Line 2 A = Escape Angle	P = Starting Block number of profile path Q = Ending Block number of profile path D = Depth of Cut † U = Finishing Allowance in X direction * W = Finishing Allowance in Z direction I = Roughing Allowance in X direction K = Roughing Allowance in Z direction A = Escape Angle

* U values are subject to Radius/Diameter mode of the machine (as set by Parameter 55 – see Chapter 14).

† D value is subject to the “implied floating point” re-interpretation rules of Parameters 245 and 246.

P and Q are required parameters.

U and W Finishing Allowances are optional and default to U0 and W0 if not specified.

I and K are optional and default to I0 and K0 if not specified.

The modal default for Depth of Cut is from Parameter 43.

The modal default for Escape Amount is from Parameter 44.

The modal default for Escape Angle is from Parameter 58.

The profile path needs to be defined after the G72 P_ Q_. The first and last G-code lines of the profile path must be tagged with the N block numbers so that P and Q can refer to them. If there are any G-code lines occurring after the G72 P_ Q_ and before the first G-code line of the profile path, those lines will not be run by this cycle, but they can be referenced later by a G70 P_ Q_ Finishing Cycle.

Note that any F, S, T and G4 P_ codes encountered in the profile path will be ignored by the G72 cycle, including the single rough cut pass at the end.

G72 Example:

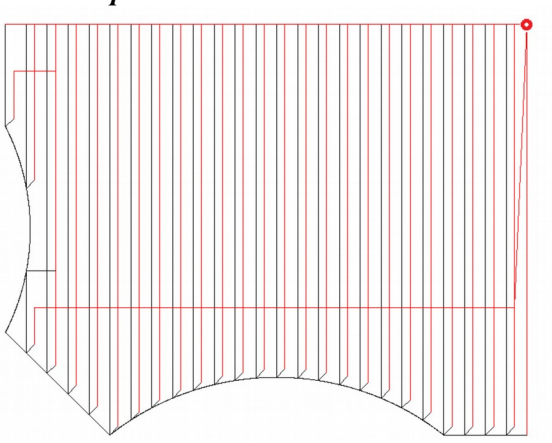

```
G0 X3 Z0 ; Rapid to Start Point
G72 W.05 R.02 ; Setup Depth of Cut and Escape Amount
G72 P11 Q22 F.01 S600 ; Cleanout Profile at N11 to N22
N11 G0 X1 ; PROFILE first block
      G1 X1 Z-.2 ; PROFILE
      G3 X1 Z-1 I-.5 K-.4 ; PROFILE
      G1 X1.5 Z-1.25 ; PROFILE
      G3 X2.5 Z-1.25 I.25 K-.5 ; PROFILE
N22 G1 X3 Z-1.25 ; PROFILE last block
```

G73 – Profile Path Repeating Cycle

The G73 cycle removes material by repeating a defined profile path (specified via P and Q) progressively deeper into the material. The profile path can be cutter compensated. The amount of material to remove is determined by the Starting Offset Amounts (in X and Z directions). The whole cycle can be optionally offset by Finishing Allowances (in X and Z directions) to leave material behind in preparation for the G70 Finishing Cycle.

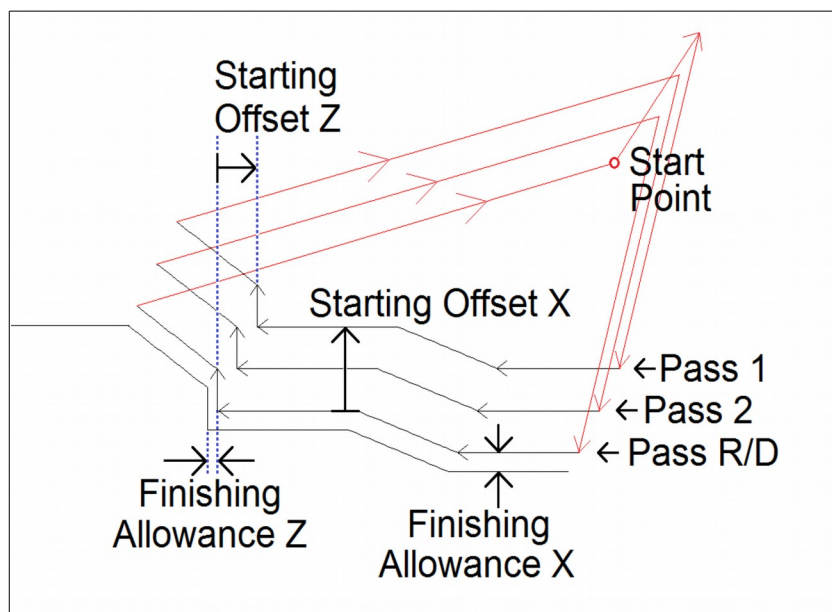

G73 has two forms:

2 Line Format	1 Line Format
Line 1: G73 U_ W_ R_ Line 2: G73 P_ Q_ U_ W_	G73 I_ K_ D_ P_ Q_ U_ W_
Line 1 U = Starting Offset Amount in X direction *† Line 1 W = Starting Offset Amount in Z direction † Line 1 R = Total number of Passes Line 2 P = Starting Block number of profile path Line 2 Q = Ending Block number of profile path Line 2 U = Finishing Allowance in X direction *† Line 2 W = Finishing Allowance in Z direction †	I = Starting Offset Amount in X direction † K = Starting Offset Amount in Z direction † D = Total number of Passes P = Starting Block number of profile path Q = Ending Block number of profile path U = Finishing Allowance in X direction *† W = Finishing Allowance in Z direction †

* U values are always radius regardless of Radius/Diameter mode of the machine (as set by Parameter 55 – see Chapter 14).

† Note that axis direction signs for U, W, I and K are computed automatically by the control software.

P and Q are required parameters.

U and W Finishing Allowances are optional and default to U0 and W0 if not specified

The profile path needs to be defined after the G73 P_ Q_ . The first and last G-code lines of the profile path must be tagged with the N block numbers so that P and Q can refer to them. If there are any G-code lines occurring after the G73 P_ Q_ and before the first G-code line of the profile path, those lines will not be run by this cycle, but they can be referenced later by a G70 P_ Q_ Finishing Cycle.

Note that any F, S, T and G4 P_ codes encountered in the profile path will be ignored by the G73 cycle.

G73 Example:

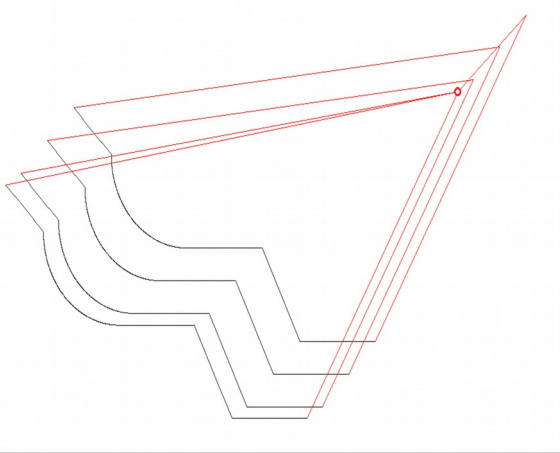

```

G0 X2.2 Z1.6 ; Rapid to Start Point
G73 U.14 W.14 R3 ; REPEAT PROF R=3x, U/W=Starting Offset
G73 P88 Q99 U.05 W.04 F.03 S500 ; REPEAT PROF P-Q, U/W=Finish Allowance
N88 G0 X.8 W-.40 ; PROFILE first block
      G1 W-.2 ; PROFILE
          X1.2 W-.1 ; PROFILE
          W-.2 ; PROFILE
      G2 X1.6 W-.2 R.2 ; PROFILE
N99 G1 X1.8 W-.1 ; PROFILE last block
G70 P88 Q99 ; FINISH CYCLE P-Q
  
```

G74 - End Face Peck Cutting Cycle

G74 is used for end face grooving and can also be used for end face peck drilling. The cycle's Z peck cutting action is used for chip breaking. When doing end face grooving, an optional X Shift and X Steper can be specified to direct the cycle to run multiple shifted groove cut passes in order to produce a groove width that is wider than the tool width. The Start Point of the G74 cycle is wherever the cutter is sitting when the cycle is invoked with a Z_ parameter †.

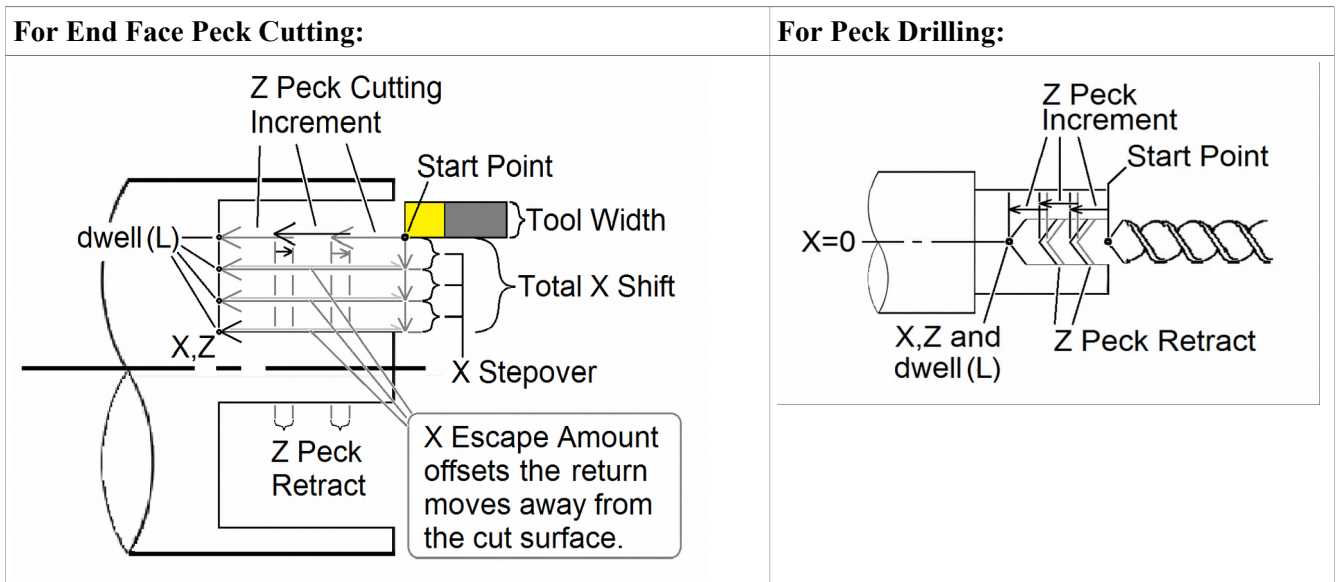

G74 has two forms:

2 Line Format	1 Line Format
Line 1: G74 R_ Line 2: G74 X_ Z_ P_ Q_ R_ L_	G74 X_ Z_ I_ K_ D_ L_
Line 1 R = Z Peck Retract Amount * Line 2 X = Final X Shift Position † Line 2 Z = Final Z depth † Line 2 P = X Stepover ‡ Line 2 Q = Z Peck Cutting Increment ‡ Line 2 R = X Escape Amount for return move Line 2 L = Dwell time at each Final Z depth	X = Final X Shift Position † Z = Final Z depth † I = X Stepover K = Z Peck Cutting Increment D = X Escape Amount for return move ‡ L = Dwell time at each Final Z depth

* The modal default for Peck Retract Amount is from Parameter 73. Note that in the 1 Line format, you cannot specify a Peck Retract Amount directly. If you are using the 1 Line format exclusively, make sure Parameter 73 is correctly set.

† Incremental X and Z positions are specified using U and W respectively. Note that if U is used it will be subject to Radius/Diameter mode of the machine (as set by Parameter 55 – see Chapter 14).

‡ P, Q and D values are subject to the “implied floating point” re-interpretation rules of Parameters 245 and 246.

Final Z depth (Z or W) and the Z Peck Cutting Increment (Q or K) are the minimal required parameters; all the others are optional.

Final X Shift Position defaults to the cycle's X Start Point if it is not specified.

X Stepover (P or I) defaults to 0 if not specified.

X Escape Amount (R or D) defaults to 0 if not specified.

Dwell Time (L) should be left out entirely if no dwell is desired because L0 will still cause a (very brief) dwell.

When doing end face grooving, the total width of the resultant groove is the total of the Tool Width added to the Total X Shift. A return move will be done after each groove cut pass (and after the dwell if it is specified). This return move will be spaced away from the cut by the specified X Escape Amount except for the very first cut pass. To prevent the grooving tool from backing up against a wall, the very first groove cut will have no X escape amount.

For centerline peck drilling, the cycle's X Start Point should be 0, and both the Final X Shift Position and the X Stepover should be 0.

G75 - Outside/Inside Diameter Peck Cutting Cycle

G75 is used for outside/inside diameter grooving. The cycle's X peck cutting action is used for chip breaking. An optional Z Shift and Z Stepmover can be specified to direct the cycle to run multiple shifted groove cut passes in order to produce a groove width that is wider than the tool width. The Start Point of the G75 cycle is wherever the cutter is sitting when the cycle is invoked with an X parameter †.

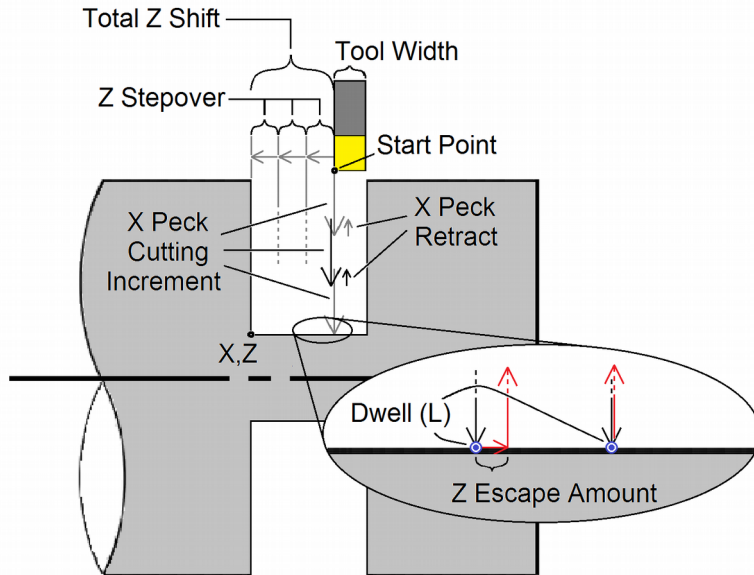

G75 has two forms:

2 Line Format	1 Line Format
Line 1: G75 R_ Line 2: G75 X_ Z_ P_ Q_ R_ L_	G75 X_ Z_ I_ K_ D_ L_
Line 1 R = X Peck Retract Amount * Line 2 X = Final X depth † Line 2 Z = Final Z Shift Position † Line 2 P = X Peck Cutting Increment ‡ Line 2 Q = Z Stepmover ‡ Line 2 R = Z Escape Amount for return move Line 2 L = Dwell time at each Final X depth	X = Final X depth † Z = Final Z Shift Position † I = X Peck Cutting Increment K = Z Stepmover D = Z Escape Amount for return move ‡ L = Dwell time at each Final X depth

* The modal default for Peck Retract Amount is from Parameter 73. Note that in the 1 Line format, you cannot specify a Peck Retract Amount directly. If you are using the 1 Line format exclusively, make sure Parameter 73 is correctly set.

† Incremental X and Z positions are specified using U and W respectively. Note that X and U are subject to Radius/Diameter mode of the machine (as set by Parameter 55 – see Chapter 14).

‡ P, Q and D values are subject to the “implied floating point” re-interpretation rules of Parameters 245 and 246.

Final X depth (X or U) and the X Peck Cutting Increment (P or I) are the minimal required parameters; all the others are optional.

Final Z Shift Position defaults to the cycle's Z Start Point if it is not specified.

Z Stepmover (Q or K) defaults to 0 if not specified.

Z Escape Amount (R or D) defaults to 0 if not specified.

Dwell Time (L) should be left out entirely if no dwell is desired because L0 will still cause a (very brief) dwell.

When this cycle is used for grooving, the total width of the resultant groove is the total of the Tool Width added to the Total Z Shift. A return move will be done after each groove cut pass (and after each optional dwell). This return move will be spaced away from the cut by the specified Z Escape Amount except for the very first cut pass (to prevent the grooving tool from backing up against a wall).

G76 - Multi-Pass Threading Cycle

In this cycle, threading is performed in successive incremental passes to a specified depth. The Start Point of the G76 cycle is wherever the cutter is sitting when the cycle is invoked with an X_ and Z_ parameter *. Optional chamfer and taper can be specified.

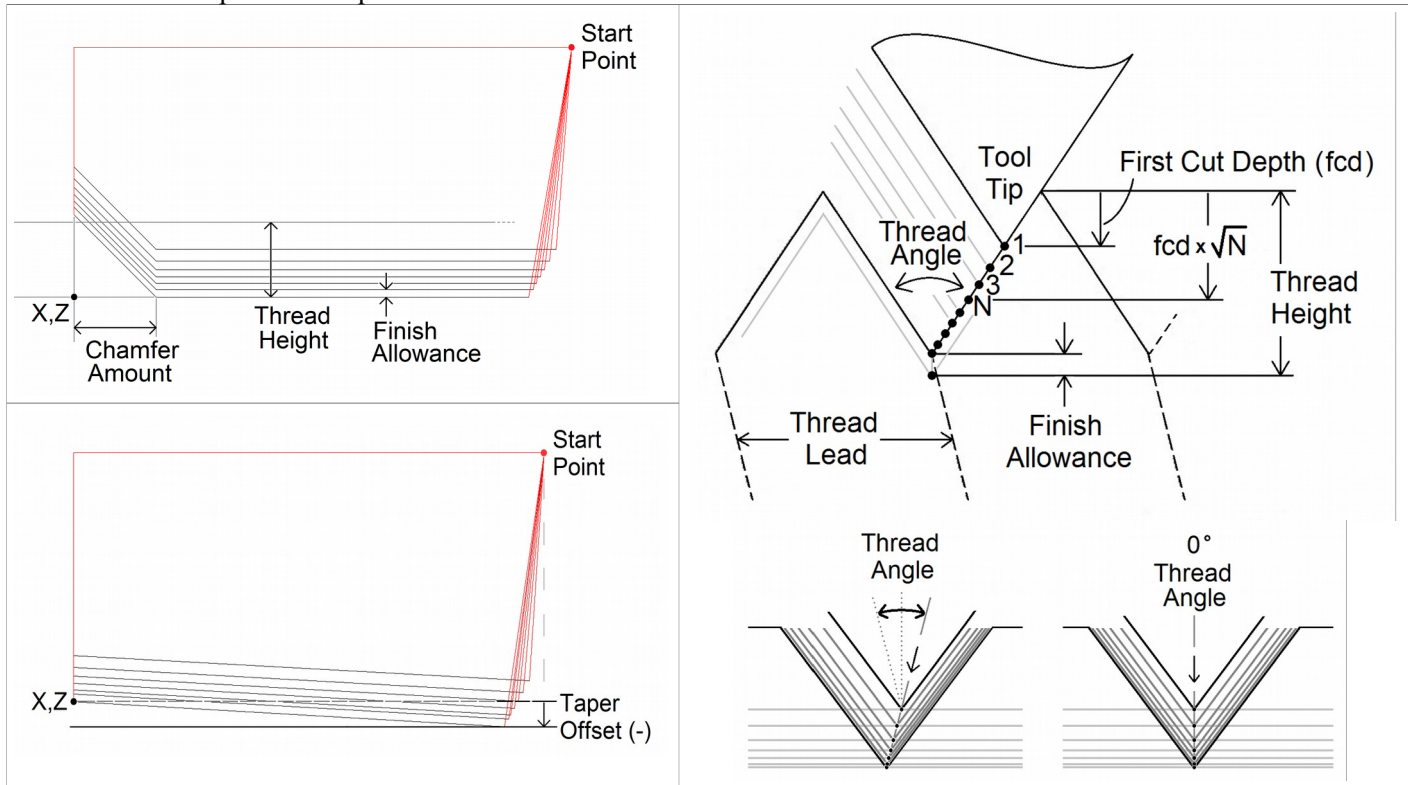

The first thread pass is done at the “First Cut Depth” and each successive incremental cut depth will be progressively less than the previous in order to account for greater chip load as the cuts get deeper. However, you can optionally specify a lower limit to this diminishing cut depth increment by specifying a “Minimum Limit Cut Depth”.

The Thread Angle dictates the chip load balance on each side of the thread cutter from one threading pass to the next. A Thread Angle of 0 means an even amount of chip load for each side of the thread cutter.

G76 has two forms.

2 Line Format	1 Line Format
Line 1: G76 Pmmrraa Q_ R_ Line 2: G76 X_ Z_ R_ P_ Q_ F_	G76 X_ Z_ K_ D_ A_ I_ F_
Line 1 P mm _____ = Finish / Spring Pass Count Line 1 P ___ rr ___ = Chamfer Amount in units of 1/10 Thread Lead Line 1 P ___ aa = Thread Angle Line 1 Q = Minimum Limit Cut Depth † Line 1 R = Finish Allowance Line 2 X = Thread Final Depth Position X * Line 2 Z = Thread Final Position Z * Line 2 R = Taper Offset (+/-) Line 2 P = Thread Height † Line 2 Q = First Cut Depth † Line 2 F = Thread Lead ‡	X = Thread Final Depth Position X * Z = Thread Final Position Z * K = Thread Height D = First Cut Depth † A = Thread Angle I = Taper Offset (+/-) F = Thread Lead ‡

* Incremental X and Z positions are specified using U and W respectively. Note that X and U are subject to Radius/Diameter mode of the machine (as set by Parameter 55 – see Chapter 14).

† P, Q and D length values are subject to “implied floating point” re-interpretation rules of Parameters 245 and 246.

‡ F is not strictly a parameter of this cycle as it is a modal value. And alternatively, the modal E value can also be used to specify Thread Lead.

The minimal required parameters for this cycle are Thread Final positions X depth and Z, First Cut Depth (Q or D), and Thread Height (P or K); all the others are optional and have a modal effect if specified. Whatever optional values are not specified, they are taken from the current modal state. In the case of the 1 Line format, some values simply cannot be specified using that format, so these unspecified values will come from the current modal values whatever they happen to be, which at the beginning of a job are initialized from Parameters 49-53.

The modal default for Finish / Spring Pass Count is from Parameter 50.

The modal default for Chamfer Amount is from Parameter 49 (specified in multiples of Thread Lead).

The modal default for Thread Angle is from Parameter 51.

The modal default for Minimum Limit Cut Depth is from Parameter 52.

The modal default for Finish Allowance is from Parameter 53.

G80 – Canned Cycle Cancel

G80 is used to cancel a canned cycle once the operation has been performed.

G83 – Deep Hole Drilling

G83 is a deep hole drilling cycle. It periodically retracts the tool to the surface to clear accumulated chips, then returns to resume drilling where it left off. The retract and return are performed at a rapid rate. Because there may be chips in the bottom of the hole, the tool does not return all the way to the bottom at the rapid rate. It slows down to federate a short distance above the bottom. This clearance distance is selected by setting parameter 83 with G10 (see example below).

Example:

```
G10 P83 R.05           ; set clearance to .05"
G83 X0 R.1 Z-2 Q.5     ; drill 2" deep hole in 0.5" steps
```

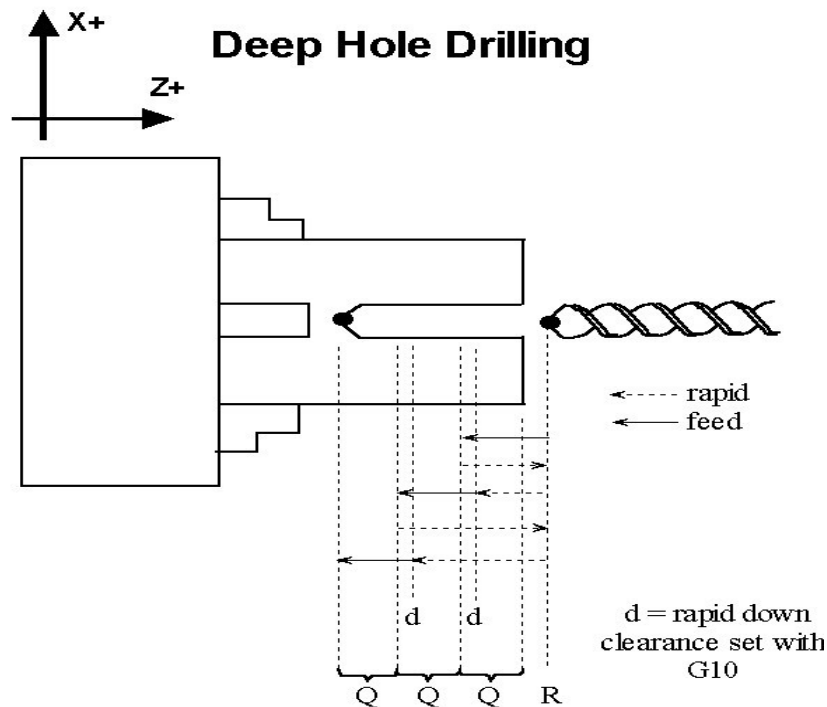

G84 – Tap/Counter Tap

G84 performs both right-hand (Tap) and left-hand (Counter Tap) cycles. The tap direction, spindle speed, spindle direction, feedrate and/or thread pitch should be set before the G84 is invoked. The tapping direction is set by calling M29 with or without a P1 parameter (see M29 in Chapter 12). G84 defaults to right-hand Tap cycle if M29 P1 is not specified beforehand. The spindle should be started beforehand using M3 (Spindle CW) for the Tap cycle, or using M4 (Spindle CCW) for the Counter Tap cycle.

For a floating tap head, the combination of the modal feedrate and spindle speed implicitly determines the approximate thread lead or pitch. However, if Rigid Tapping is enabled, a Q may be used to explicitly set the thread lead or pitch. However, because Q is not modal in the case of Rigid Tapping, you must specify Q on every line at which Rigid Tapping is to occur.

The Tap/Counter Tap cycle might cut a short distance beyond the programmed Z height as the spindle comes to a stop before reversing. When tapping blind holes, be sure to specify a Z height slightly above the bottom of the hole to prevent the tool from reaching bottom before the spindle stops. The exact distance you must allow will depend on your machine and the diameter and pitch of the tapping tool.



WARNING FEED HOLD is temporarily disabled during the tapping cycle, but it will be re-enabled at the end of the cycle.

NOTICE Pressing CYCLE CANCEL while the tap is in the hole will very probably break the tap or strip the threads in the tap hole. However, do so if it is an emergency.

G85 – Boring Cycle

G85 is used to bore a hole so that a smooth finish may be acquired. The tool will feed into depth at the specified feedrate and retract back out at the same feedrate.

G90 - Outside/Inside Diameter Cutting Cycle

G90 sets the outer/inner diameter cutting cycle command. These diameters can be specified along straight cuts or diagonal/taper cuts.

Straight Cutting

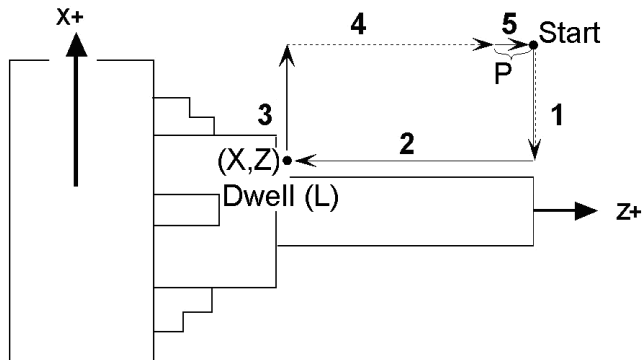

The general form of the Straight Cutting Cycle is as follows:

G90 X_ Z_ P_ L_

In incremental programming form, the X and Z can be substituted with U and W. Note that X (or U) is affected by the radius/diameter programming mode (see parameter 55 in Chapter 14). The optional parameter P specifies the length of the return feed move (segment 5 in illustration above). This cycle behaves differently depending on whether a non-zero P is specified or not. If P does not exist or is 0, then segments 1 and 4 will be rapid moves, segments 2 and 3 will be feedrate moves, and segment 5 will be omitted. If P does exist and is non-zero, then segment 4 will be a rapid move and all the other segments will be feedrate moves. The optional parameter L specifies a dwell time between segments 2 and 3.

Example:

```
G00 X2.5 Z-1.0 ; rapid to start point
G90 X1.5 Z-4.0 F0.5 L1.5 ; G90 cycle with 1.5 sec dwell at X1.5 Z-4.0
```

Taper Cutting

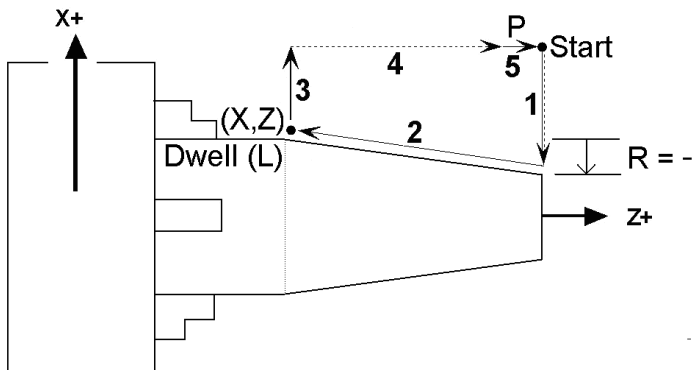

The general form of the Taper Cutting Cycle is as follows:

```
G90 X_ Z_ R_ P_ L_
```

This is actually the same as the Straight Cutting cycle (mentioned above) but with the addition of the R parameter. Parameters P and L are optional. Taper is determined by offsetting the point between segments 1 and 2 on the X coordinate by the incremental amount specified by the R parameter. Note that R is unaffected by the radius/diameter programming mode, but X is (see parameter 55 in Chapter 14). All the other parameters have the same meaning as those of the Straight Cutting cycle (mentioned above).

Example:

```
G00 X2.5 Z-1.0 ; rapid to start point
G90 X1.5 Z-4.0 R-0.25 F0.5 ; Tapered G90 cycle
```

The following table shows the relationship between the tool paths and the signs of U, W, and R during incremental programming when performing taper cutting.

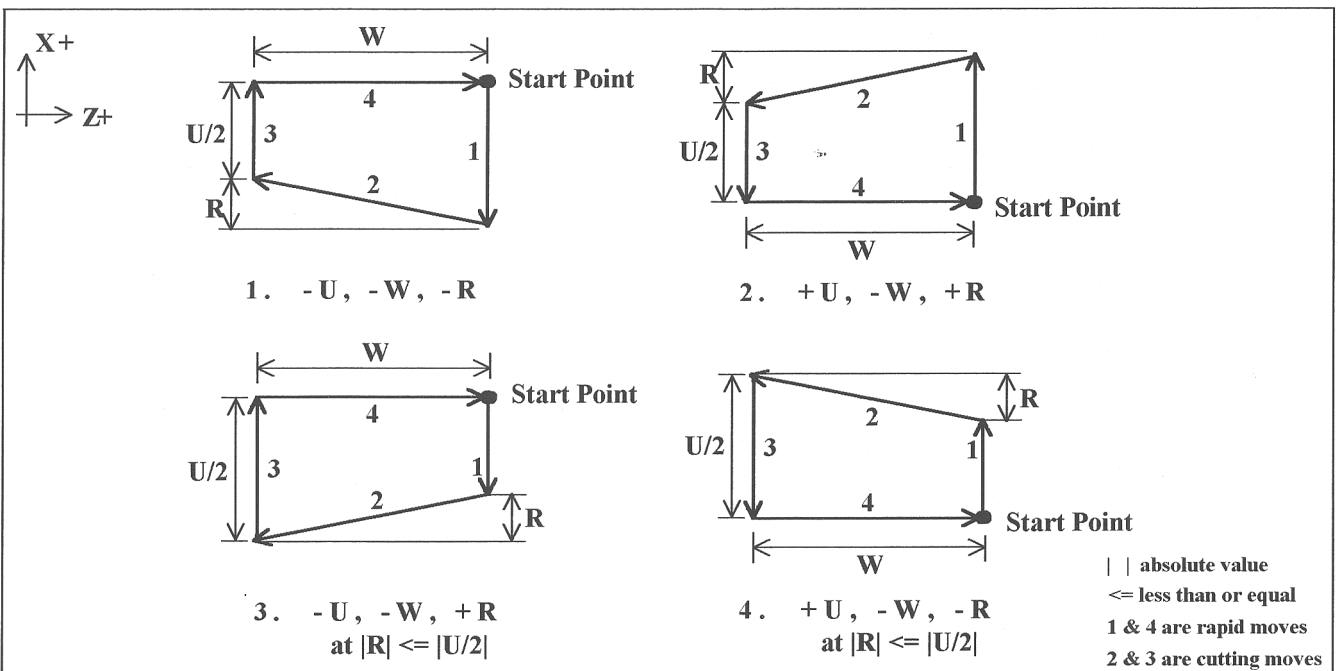

G92 - Thread Cutting Cycle

G92 sets the thread cutting cycle command. This cycle can be specified for straight thread cutting or taper thread cutting. In incremental programming, the signs of U and W will depend on the direction of the tool path when approaching the workpiece. That is, if the cutter moves in the negative X direction, then the value of U will be negative.

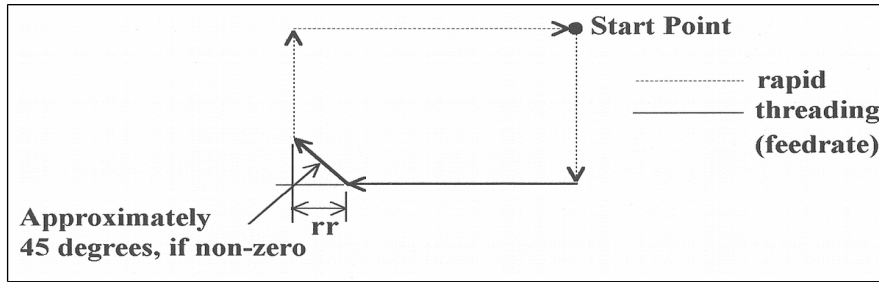

G92 is similar to G32 in that X and Z indicate the endpoint of the cut and F indicates the thread lead and X & Z are slaved to the spindle. The chamfering amount, rr, which is selected by Parameter 49 (see Chapter 14), is a multiplier of the thread lead. That is, the chamfer distance is rr times the thread lead.

Straight Thread Cutting

In this cycle, the cutter moves to the diameter indicated by X and threads in a straight line to the depth or length indicated by Z.

In the example below, the cutter first rapids to the start point located at X2.5Z-1, then rapids down to X2 at the same Z, and then cuts with the specified lead to Z-3. At Z-3, the cutter pulls out of the part the amount of the chamfering distance, then rapids back up to X2.5 and returns to the start point.

Example:

```
G00 X2.5 Z-1.0
G92 X2.0 Z-3.0 F.1
```

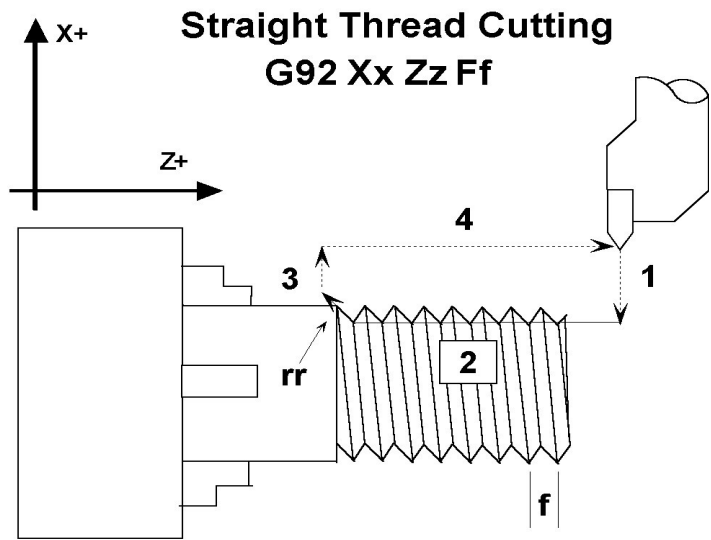

1, 3, and 4 are rapid moves. 2 is cutting move

Taper Thread Cutting

In this cycle, the cutter threads diagonally to the diameter and depth indicated by X and Z, respectively. The value of R will dictate the value of the starting diameters. A negative R will make the ending diameter equal to X and the starting diameter equal to X minus twice the absolute value of R. A positive R will make the ending diameter equal to X and the starting diameter equal to X plus twice the value of R.

In the example below, the cutter first rapids to the start point located at X3.5 Z-1, then rapids down to X2.5, the inner diameter, at the same Z, and then cuts with the specified lead to Z-3. At Z-3 the value of the outer diameter is 2.5 and the cutter pulls out of the part the amount of the chamfering distance, then rapids back up to X2.5 and returns to the start point.

Example:

```
G00 X3.5 Z-1.0  
G92 X2.5 Z-3.0 R-0.25 F.1
```

Multiple thread leads

This is done by using the formula:

$$2^{\text{nd}} - \text{nth thread lead start point} = \text{previous thread lead start point} + ((1/\text{TPI}) / \# \text{ of leads})$$

Example:

We want to produce a triple lead thread with a thread lead of 10 threads per inch (TPI). The start point for the first thread lead is 0.1000 from the face of the material being threaded.

Thread lead # 1 start point = 0.1000.

Thread lead # 2 start point = $0.1000 + ((1/10)/3) = 0.1333$.

Thread lead # 3 start point = $0.1333 + ((1/10)/3) = 0.1666$.

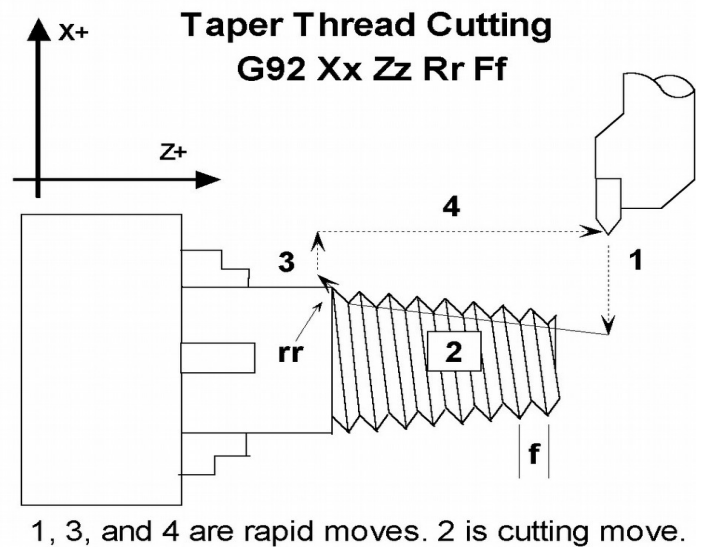

G94 - End Face Turning

G94 sets the end face turning cycle command. This cycle can be specified for straight face turning or taper face turning. In incremental programming, the signs of U and W will depend on the direction of the tool path when approaching the work piece. That is, if the cutter moves in the negative X direction, then the value of U will be negative. The L parameter can be set to allow the part to rotate at least one full revolution, at the end X position, before the tool is moved back to the starting Z position.

Straight Face Turning

In this cycle, the cutter moves to the depth indicated by Z and then cuts to the diameter indicated by X. In the example below, the cutter first rapids to the start point located at X2Z-1, then rapids to Z-1.25 at the same X, and then cuts at the specified feedrate to X1. At X1, the cutter dwells for .5 secs, then moves back to Z-1 at the same feedrate and rapids back up to the start point.

Example:

```
G00 X2.0 Z-1.0  
G94 X1.0 Z-1.25 F0.1 L.5
```

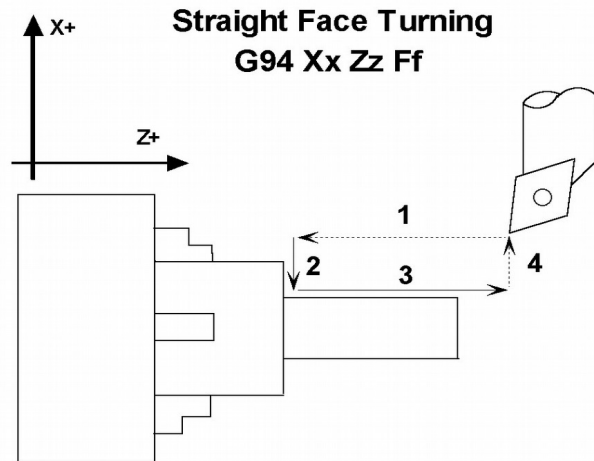

1 and 4 are rapid moves. 2 and 3 are cutting moves.

Taper Face Turning

In this cycle, the cutter cuts diagonally to the diameter and depth indicated by X and Z, respectively. The value of R will dictate the approach of the cutter to the specified Z coordinate, that is, the value of R will determine how much the cutter will stop short (positive R) or pass (negative R) Z before cutting diagonally down to the specified diameter.

In the example below the value of R is negative, thus, the cutter first rapids to the start point located at X2Z-1, then rapids to Z-1.5 at the same X, and then cuts diagonally down to X1 at the specified feedrate. At X1, the value of Z is -1.25, then the cutter moves back to Z-1 at the same feedrate and rapids back up to the start point.

Example:

```
G00 X2.0 Z-1.0  
G94 X1.0 Z-1.25 R-0.25 F0.1
```

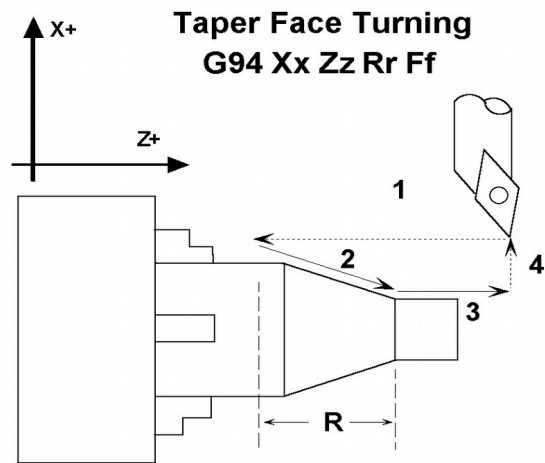

1 and 4 are rapid moves. 2 and 3 are cutting move

The following table shows the relationship between the tool paths and the signs of U, W, and R during incremental programming when performing taper face turning.

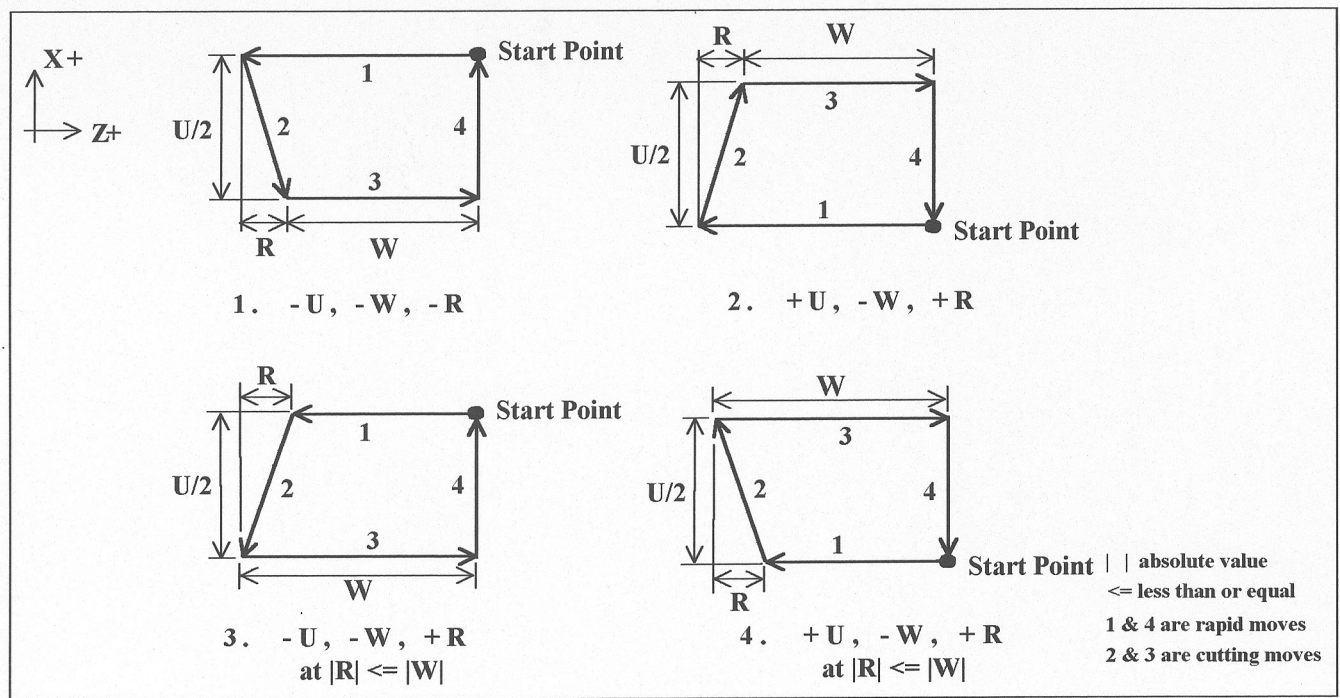

G96 & G97 - Constant Surface Speed Control & Cancel

G96 sets the mode for constant surface speed control in feet/min (sfm) or meters/min. S values are assumed as surface speed. When CSS is active, the spindle speed changes as the X position changes, to maintain a constant linear velocity at the tool tip. No matter how close X gets to X0, the spindle speed will not exceed the speed set with G50 or the machine's maximum spindle speed, whichever is less. G97 cancels the constant surface speed control.

```
G96 S800           ; sets constant surface speed to 800 feet/min
G01 X1 Z-3 F0.1
G97 S1200          ; cancels constant surface speed and sets
                   ; spindle speed to 1200 rpm
```

G98 - Feed per minute

G98 sets the cutting feedrate mode in units/minute. There are no associated parameters.

G99 - Feed per revolution

G99 sets the cutting feedrate mode in units/rev. There are no associated parameters.

Chapter 12

M functions

M-functions are used to perform specialized actions in CNC programs. Most of the T-series Control M-functions have default actions, but they can be customized with the use of macro files.

Certain restrictions apply to calling M functions:

- Only one M function per program line is permitted.
- M-functions are not allowed on the same line as a tool change (see T in Chapter 10).

Summary of M functions

M00 Stop For Operator	M94/M95 Output On/Off
M01 Optional Stop for Operator	M98 Call Subprogram
M02 Restart Program	M99 Return from Macro or Subprogram
M03 Spindle On Clockwise	M100 Wait for PLC bit (Open, Off, Reset)
M04 Spindle On Counterclockwise	M101 Wait for PLC bit (Closed, On, Set)
M05 Spindle Stop	M102 Restart Program
M07 Mist Coolant On	M103 Programmed Action Timer
M08 Flood Coolant On	M104 Cancel Programmed Action Timer
M09 Coolant Off	M105 Move Minus to Switch
M10 Clamp On	M106 Move Plus to Switch
M11 Clamp Off	M107 Output Tool Number
M13 (macro) Cutoff *	M108 Enable Override Controls
M16 (macro) Chuck ID selection *	M109 Disable Override Controls
M18 (macro) Chuck OD selection *	M115,M116,M125,M126 Protected Move Probing Functions
M19 (macro) Spindle Orient *	M120 Open data file (overwrite existing file)
M22 (macro) Extend part chute *	M121 Open data file (append to existing file)
M23 (macro) Retract part chute *	M122 Record position(s) in data file
M26 Set Axis Home	M123 Record value and/or comment in data file
M29 Set Tap Mode for G84	M124 Record machine position(s) in data file
M30 Restart Program	M127 Record Date and Time in a data file
M32 (macro) Tailstock Quill forward (out) *	M128 Move Axis by Encoder Counts
M33 (macro) Tailstock Quill retract (in) *	M129 Record Current Job file path to data file
M34 (macro) Part Catch forward *	M130 Run system command
M35 (macro) Part Catch retract *	M150 Set Spindle Position to 0 on Next Index Pulse
M41,M42,M43 (macro) Select Spindle Gear Range *	M151 Unwind C axis
M46 (macro) Door Open *	M200/M201 Stop for Operator, Prompt for Action
M47 (macro) Door Close *	M223 Write Formatted String to File
M50 C Axis Disable	M224 Prompt for Operator Input Using Formatted String
M51 C Axis Enable	M225 Display Formatted String for A Period of Time
M91 Move to Minus Home	M290 Digitize Profile
M92 Move to Plus Home	M300 Fast Synchronous I/O update
M93 Release/Restore Motor Power	M1000-M1015 Graphing Color for Feedrate movement

* M functions marked with “(macro)” actually have no standard default action, and could possibly be unimplemented and therefore unavailable on your machine. Also, their stated function is only standard on certain machines.

Macro M functions (custom M functions)

Macro M functions are M functions that have been customized with a macro file. The T-Series CNC M functions from 0 through 90 can be fully customized. No M-functions above 90 may be customized with macros. The default action listed will be performed unless that M-function has been customized.

To create a macro for an M-function, a file must be created in the C:\cnct directory. The file's name must be mfuncXX.mac where XX is the M-function number used to call the macro. M-functions 0-9 must use single digits in the filename (e.g. use mfunc3.mac, **not** mfunc03.mac). The contents of the file may be any valid M and G-codes.

The following is an example macro M-Function to turn on spindle with variable frequency drive and wait for "at speed" response.

```
M94/1 ; request spindle start
M101/50005 ; wait for up to speed signal
```

These lines would be placed in the file c:\cnct\mfunc3.mac. Each time the M-function is encountered in a program, the macro file will be processed line by line.

- NOTE: Nesting of macro M-functions is allowed, but, recursive calls are not. If a macro M-function does call itself, the default action of the function will be executed.
- NOTE: Unlike subprograms invoked with G65, macro arguments passed into a macro M function are passed in by reference. This means local changes to #1 through #33 or #A through #Z will change the their values upon return from the macro M function.
- NOTE: The M and G-codes within a macro M-function are not usually displayed on the screen as they are executed, and are all treated as one operation in block mode. If you wish to see or step through macro M-functions (e.g. for testing purposes), see Machine Parameter 10 in Chapter 14
- NOTE: The cnctch.mac file, which contains the G-code sequence for doing a customized tool change, is also considered to be an M-function Macro so that its behavior can be modified by Machine Parameter 10.

M00 - Stop For Operator

Motion stops and the operator is prompted to press the CYCLE START button to continue.

M01 - Optional Stop for Operator

M1 has no effect unless optional stops are turned on. When optional stops are on, M1 is identical to M0.

Default action:

M100/75 ; if optional stops are turned on.

M02 - Restart Program

Restarts the program from the first line. The operator is prompted to press the CYCLE START button to continue.

M03 - Spindle On Clockwise

M3 requests the PLC to start the spindle in the clockwise direction.

Default action:

M95/2

M94/1

M04 - Spindle On Counterclockwise

M4 requests the PLC to start the spindle in the counterclockwise direction.

Default action:

M95/1

M94/2

M05 - Spindle Stop

M5 requests the PLC to stop the spindle.

Default action if the spindle had been spinning CW:

M95/2

M95/1

Default action if the spindle was OFF or was spinning CCW:

M95/1

M95/2

M07 - Mist Coolant On

M7 causes the PLC to start the mist coolant system.

Default action:

M95/3

M94/5

M08 - Flood Coolant On

M8 causes the PLC to start the flood coolant system.

Default action:

M95/5

M94/3

M09 - Coolant Off

M9 causes the PLC to stop the coolant system.

Default action:

M95/3/5

M10 - Clamp On

M10 causes the PLC to activate the clamp.

Default action:

M94/4

M11 - Clamp Off

M11 causes the PLC to release the clamp.

Default action:

M95/4

M19 – Spindle Orient (Macro)

M19 has no default action, therefore a custom M19 macro must be defined for this feature to work. If defined, the M19 macro sends a request to the PLC to rotate the spindle to its pre-set orient position.

M26 - Set Axis Home

M26 sets the machine home position for the specified axis to the current position (after the line's movement).

Example:

```
M92/X ; home X axis to plus home switch
M26/X ; set machine home for X-axis there
M91/Z ; home Z-axis to minus home switch
M26/Z ; set machine home for Z-axis there
```

M29- Set Tap Mode for G84

M29 sets the tap mode for G84; either right-hand or left-hand tapping. Right-hand tap mode is the initial default at job start-up. If Left-hand tap mode is required, M29 and P1 need to be specified on the same line.

Tap Mode	Command
CW (Right-hand)	M29
CCW (Left-hand)	M29 P1

M30 - Restart Program

Restarts the program from the first line. The operator is prompted to press the CYCLE START button to continue. This has the same functionality as M2.

M41, M42, M43 – Select Spindle Gear Range (Macros)

M41, M42, and M43 have no default actions, and therefore custom macros must be defined for these M codes in order to make this feature work. If defined, these macros notify the PLC of which spindle gear range is selected according to the following table:

Macro M function	Action
M41	Select Low Gear Range
M42	Select Medium-Low Gear Range
M43	Select High Gear Range

M50 – C Axis Disable

M50 is the command to disable the C axis and it is a locked software option. When the C axis is disabled, no axis label will be present on the screen and the encoder information for the C axis is ignored. In order for the M50 command to work, the 3rd or 4th axis label must be set to 'C' with the associated parameter (93 for 3rd axis and 94 for 4th axis) set for C axis operation. In practical applications, the default behavior for the M50 command is usually modified using a custom mfunc50.mac program.

Example mfunc50.mac:

```
M95/9      ; Switch to speed mode
M50        ; Perform the default actions for C axis disable
```

M51 – C Axis Enable (Optional)

M51 is the command to enable the C axis and it is also locked as a software option.. When C axis is enabled, the C axis label will be present on the DRO and encoder information for the C axis is used to determine the position of the C axis. In order for the M51 command to work, the 3rd or 4th axis label must be set to 'C' with the associated parameter (93 for 3rd axis and 94 for 4th axis) set for C axis operation. In practical applications, the default behavior for the M51 command is modified using a custom mfunc51.mac program to ensure that the spindle has stopped before the C axis is enabled.

Example mfunc51.mac:

```
G97        ; Turn off CSS (constant surface speed)
M3 S0      ; Turn off spindle
M101/9     ; Wait for zero speed signal form inverter on INP9
M94/9     ; Switch to torque mode
M51        ; Perform the default actions for C axis enable
M151      ; Unwind C-axis position
```

Note in the above examples for M50 and M51 where the M95/9 (turn off INP41) and M94/9 (turn on INP41) commands are used, it is assumed that the plc program, conditioned upon the state of INP41, has been modified to output the appropriate hardware signals required to switch between speed and torque mode.

M91 - Move to Minus Home

M91 moves to the minus home switch of the axis specified at the slow jog rate for that axis. After the minus home switch is reached, the tool is moved back until the home switch resets. Then the next encoder index pulse is reached.

Example:

```
M91/Z      ; move the Z-axis to the minus home switch.
G50 Z-10   ; sets Z minus home switch at -10
```

M92 - Move to Plus Home

M92 moves to the plus home switch of the axis specified at the slow jog rate for that axis. After the plus home switch is reached, the tool is moved back until the home switch resets. Then the next encoder index pulse is reached.

Example:

```
M92/X      ; moves the X-axis to the plus home switch.
G50 X+10   ; Sets X plus home switch at +10
```

M93 – Release/Restore Motor Power

M93 releases or restores motor power for the axis specified. If no axis is specified, then all axes are released.

Example:

To release motor power:

```
M93/X      ; releases the X axis.
M93        ; releases the motors on all axes.
```

Example:

To restore power:

```
M93/X P1   ; restore power to the X axis motor.
M93 P1     ; restore power to the motors on all axes.
```

- NOTE: Any axis freed within a CNC program should **not** be used in that program afterwards. Incorrect positioning may result.

M94/M95 - Output On/Off

There are 128 user definable system variable bits that can be used to communicate with the PLC. M94 and M95 are used to request those system variable bits to turn on or off respectively. Requests 1-128 are mapped to the PLC as system variables SV_M94_M95_1 through SV_M94_M95_128 as shown in the following table:

On	Off	PLC bit
M94/1	M95/1	SV M94 M95 1
M94/2	M95/2	SV M94 M95 2
M94/3	M95/3	SV M94 M95 3
M94/4	M95/4	SV M94 M95 4
.	.	.
.	.	.
.	.	.
M94/128	M95/128	SV M94 M95 128

To use M94 and M95 to control a function external to the servo control, such as an indexer, the input request must be mapped to one of the PLC outputs in the PLC program. See M94/M95 function usage in the PLC section of the service manual.

Example:

```
M94/5/6 ; turns on SV_M94_M95_5 and SV_M94_M95_6.
```

* NOTE: M94 and M95 will cause prior motion to decelerate to a stop before the requested bits are turned on or off.

* NOTE: Requests 1-5, 15, and 16 are controlled by the default actions of M3, M4, M5, M6, M7, M8, M9, M10, M11, and M39. To override or disable a bit used in one of these M codes, define a custom M-function.

M98 - Call Subprogram

M98 calls a user-specified subprogram. A subprogram is a separate program that can be used to perform a certain operation (e.g. a drilling pattern, contour, etc.) many times throughout a main program.

Calling methods:

```
M98 Pxxxx Lrrrr
```

or

```
M98 "program.cnc" Lrrrr
```

where *xxxx* is the subprogram number (referring to file *Oxxxx.cnc*, 0000-9999 allowed, leading 0's required in filename, capital O, lowercase .cnc), *rrrr* is the repeat value, and "program.cnc" is the name of the subprogram file.

Subprograms are written just like normal programs, with one exception: an M99 should be at the end of the subprogram. M99 transfers control back to the calling program.

Subprograms can call other subprograms (up to 20 nested levels of calling may be used), Macro M-functions, and Macros. Macro M-functions and Macros can similarly call subprograms.

Subprograms 9100-9999 can also be embedded into a main program, using O9xxx to designate the beginning of the subprogram and M99 to end it. CNC11 will read the subprogram and generate a file O9xxx.cnc. CNC11 will not execute the subprogram until encounters M98 P9xxx.

- NOTE: An embedded subprogram definition must be placed before any calls to the subprogram.

M99 - Return from Macro or Subprogram

M99 designates the end of a subprogram or macro and transfers control back to the calling program when executed. M99 may be specified on a line with other G-codes. M99 will be the last action executed on a line. If M99 is not specified in a subprogram file, M99 is assumed at the end of the file:

Example:

```
G1 X3 M99 ;Move to X3 then return to calling program.
```

If M99 is encountered in the main job file, it will be interpreted as the end of the job. If M99 is encountered in an M-function macro file, it will be interpreted as the end of any enclosing subprogram or macro or as the end of the job.

M100 - Wait for PLC bit (Open, Off, Reset)

M101 - Wait for PLC bit (Closed, On, Set)

The M100/M101 commands wait for a PLC bit to reach a state as indicated in the table below.

Number	PLC bit	M100	M101
50001 – 51312	INP1 – INP1312	open	closed
60001 – 61312	OUT1 – OUT1312	off	on
70001 – 71024	MEM1 – MEM1024	reset	set
90001 – 90064	T1 – T64 status bits	reset (not expired)	set (expired)
93001 – 93256	STG1 – STG256 status bits	reset (disabled)	set (enabled)
94001 – 94256	FSTG – FTSG256 status bits	reset (disabled)	set (enabled)
The number ranges 1-240 can be used to reference the first eighty INP, OUT, or MEM bits. It is recommended that existing CNC10 programs and macros be converted to the new ranges for use with CNC11.			
1 – 80	INP1 – INP80	open	closed
81 – 160	OUT1 – OUT80	off	on
161 – 240	MEM1 – MEM80	reset	set

Example:

```
M101/50001 ; wait for INP1 to close
M100/60002 ; wait for OUT2 to turn off
M101/70123 ; wait for MEM123 to be set (1)
```

NOTE: The numbers assigned to the PLC bits (except 1-240) are the same as those that can be used when referencing system variables in M- and G-code programs.

M102 - Restart Program

M102 performs any movement requested, and restarts the program from the first line. The operator is **NOT** prompted to press the CYCLE START button to continue.

M103 - Programmed Action Timer

M103 is used to set up the time limit for a timed operation. If the timer is canceled (usually by M104) before the specified time limit, the program will be canceled and the message "Programmed action timer expired" will be displayed. If another M103 is issued before the time limit expires, then this time limit is nullified and the new time limit will be set up as specified by the latest occurring M103. Note also that if M0 or M1 causes the program to stop momentarily and the "M0 jogging" feature is enabled, then the timer will also be canceled without the need to issue M104.

Example:

Activate a device and wait for a response. If no response within 4.5 seconds, cancel the program.

```
M94/12 ; turn on relay
M103/4.5 ; start 4.5 second timer
M100/4 ; wait for input 4 to open
M104 ; input 4 opened, cancel timer
```

M104 - Cancel Programmed Action Timer

M104 stops the timer started by the last M103 executed.

M105 - Move Minus to Switch

M105 moves the requested axis in the minus direction at the current feedrate until the specified switch opens (if the given P parameter is positive), or until the specified switch closes (if P parameter is negative).

Example:

```
M105/X P5 F30 ; move the X axis in minus direction at 30"/min until
; the switch on INP5 opens
G92 X10 ; Sets X position to 10
M105/Z P-6 ; move the Z axis in minus direction until switch on INP6 closes
```

M106 - Move Plus to Switch

M106 moves the requested axis in the plus direction at the current feedrate until the specified switch opens (if the given P parameter is positive), or until the specified switch closes (if P parameter is negative).

Example:

```
M106/Z P3 F30 ; move the Z axis in the plus direction at 30"/min, until
; the switch on INP3 opens
G92 X10 ; Sets Z position to 10
M106/X P-3 ; move the X axis in the plus direction until the switch on INP3 closes
```

M107 - Output Tool Number

M107 sends the current tool number to the automatic tool changer, via the PLC. M107 does not set the tool changer strobe or look for an acknowledge from the changer.

Example:

```
M107          ; send request for tool to changer
M94/16       ; turn on tool changer strobe
M101/5       ; wait for acknowledge on input 5
M95/16       ; turn off strobe
M100/5       ; wait for acknowledge to be removed
```

M108 - Enable Override Controls

M108 re-enables the feedrate override and/or spindle speed override controls if they have previously been disabled with M109. A parameter of 1 indicates the feedrate override; a parameter of 2 indicates the spindle speed override.

Example:

```
M109/1/2     ; disable feedrate and spindle speed overrides
M108/1       ; re-enable feedrate override
M108/2       ; re-enable spindle speed override
```

M109 - Disable Override Controls

M109 disables the feedrate override and/or spindle speed override controls. M109 cannot be used in MDI mode.

Example:

```
M3 S500      ; start spindle clockwise, 500 rpm
M109/1/2     ; disable feedrate and spindle speed overrides
M108/1/2     ; re-enable overrides
```

M115/M116/M125/M126 – Protected Move Probing Functions

The protected move probing functions provide the capability to program customized probing routines. The structure for these commands is:

```
Mnnn /Axis pos Pp Ff
```

<i>nnn</i>	is either 115, 116, 125, or 126.
<i>Axis</i>	is a valid axis label, i.e., X, Z, etc.
<i>pos</i>	is an optional position
<i>p</i>	is a plc bit number, which can be negative.
<i>f</i>	is a feedrate (in units per minute.)
<i>L1</i>	is an option for the M115/M116 commands that prevents an error if the probe does not detect a surface
<i>Q1</i>	is an option for M115/M116 that forces the DSP probe to move a "Recovery Distance" on retries (Note: the Q1 option only applies for DSP Probes)

For M115 and M116 functions, the indicated *axis* will move to *pos* (if specified) until the corresponding plc bit *p* state is 1, unless *p* is negative, in which case movement is until the plc bit state is 0. A *p* value of 1 to 80 (or -1 to -80) specifies plc bits INP1-INP80, 81 to 160 (or -80 to -160) specifies plc bits OUT1-OUT80, and 161 to 240 (or -161 to -240) specifies plc bits MEM1-MEM80. Warnings are generated in the CNC11 message window for "Missing P value" and "Invalid P value."

If *pos* is not specified, M115 will move *axis* in the negative direction, and M116 will move *axis* in the positive direction. Note that if *pos* is specified, then it does not matter whether M115 or M116 is used.

If *pos* is not specified, the movement is bounded by the settings in the software travel limits. In the absence of software travel limits, movement is bounded by the maximum probing distance (Machine Parameter 16). In cases where *pos* is specified, it is still bounded by the software travel limits.

If the bounded position is reached before the awaited plc bit state is found, a "*Probe unable to detect surface*" error will be generated unless the *LI* option is specified.

For M125 and M126 protected move functions, the behavior is identical to that of the M115 and M116 commands, except in regards to the plc bit state. M125 and M126 will generate an "*Unexpected probe contact*" error message if the specified plc bit state is triggered, again stopping any running job.

In summary, the M115 and M116 commands are to be used when one expects contact to be made and M125 and M126 commands are to be used when one does not expect any contact to be made.

Example:

```
M115/X P-15 F20      ; Move X minus at 20ipm waiting for contact on INP15
M116/X P15 F5       ; Move X plus until no contact at 5 ipm
```

M120 - Open data file (overwrite existing file)

This M function will open the requested data file for writing. If no drive or directory is specified with the file name, then the file will be opened in the same directory as the CNC program. If the file cannot be successfully opened, then an error will be returned, ultimately terminating the job. If a data file is already open when M120 is called, that file will first be closed, then the new file opened.

Example:

```
M120 "probetst.dat"
```

M121 - Open data file (append to existing file)

This M function will open the requested file for writing at the end of the file. If no drive or directory is specified with the file name, then the file will be opened in the same directory as the CNC program. If the file does not already exist, it will be created. This is not an error. If the file cannot be successfully opened, then an error will be returned, ultimately terminating the job. If a data file is already open when M121 is called, that file will first be closed, then the new file opened.

Example:

```
M121 "c:\probetst.dat"
```

M122 - Record position(s) and optional comment in data file

This M function will write the current expected position value to the data file, in the usual format (i.e. axis label before number, 4 decimal places in inch mode, 3 decimal places in millimeter mode). Any comment that appeared on the line with M122 will be output after the position(s). With no axis arguments, M122 will write the positions of all installed axes. With axis arguments, it will write the positions only of the requested axes. Positions will be written in local (not machine) coordinates, in native machine units. If no data file has been opened with M120 or M121 before M122 is called, then M122 will return an error and terminate the job. The parameter L1 may be used to suppress the new line character normally outputted after the last position. Furthermore, the output of axis labels, comma separators, and spaces can be enabled or suppressed via machine parameter 72 (see Parameter 72 in Chapter 14).

Examples (M function and sample output):

```
M122                ->   X1.2345 Z-0.5678
M122 /Z ; at 10 ipm ->   Z-.4321 ; at 10 ipm
M122 /X/Z           ->   X-1.0000 Z0.8732
M122 /X L1         ->   X-1.5000
M122 /X             ->   X-1.5000 X-2.0000
```

M123 - Record value and/or comment in data file

This M function will write the specified parameter value (if any) to the data file, followed by any comment that appeared on the line with M123. If a P value is specified, M123 will output a numeric value (4 decimal places in inches, 3 in millimeters). If no P value is specified, then M123 outputs the comment only. If neither a P value nor a comment was specified, M123 does nothing. This is not an error. If no data file has been opened with M120 or M121 before M123 is called, then M123 will return an error and terminate the job. The parameter L1 may be used to suppress the new line character normally outputted after the last value. The R and Q parameters can be used to specify the field width and precision, respectively. Furthermore, the output of axis labels, comma separators, and spaces can be enabled or suppressed via machine parameter 72 (see Parameter 72 in Chapter 14).

Examples (M function and sample output):

```
M123 P1.2345                ->1.2345
M123 P#A ; first macro argument ->1.2345 first macro argument
M123 ; Probing X+ to surface ->Probing X+ to surface
M123                        -><nothing>
M123 ;                      -><nothing>
M123 ;; my comment         ->; my comment
M123 Q0 P1.23              ->1
M123 Q1 P1.23              ->1.2
M123 R7 Q2 L1 P1.234       ->
M123 R7 Q2 P98.765         -> 1.23 98.77
```

M124 - Record machine position(s) and optional comment in data file

Identical to M122 above except that the m124 reports machine position instead of a local WCS position.

M127 - Record Date and Time in a data file

This M function is used to write the date, time, and year to the specified data file called out by the M120 or M121.

NOTE: This function does not insert a semi-colon in front of the date. If desired, use an M123 as shown in example below.

Examples (M function and sample output):

```
M123 ;;
M121 "testdata.dat"
M127
```

If you opened testdata.dat you would see: Day of week, Month, day, time, and year.
(i.e. ;Wed Aug 29 11:56:57 2007)

M128 – Move Axis by Encoder Counts

M128 moves the requested axis by L which specifies an encoder count position.

Example:

```
M128/X L-5000 ; move the X axis to machine position -5000 counts
```

M129 - Record Current Job file path to data file

This M function is used to write the current job's file path to the specified data file called out by the M120 or M121.

Example:

Run a job named job.cnc which contains the following 2 lines:

```
M121 "output.txt"  
M129
```

If you opened the output.txt file you would see:

```
c:\cncm\ncfiles\job.cnc
```

M130 - Run system command

This allows shell commands to be called from a CNC program or MDI. M130 takes one string argument which contains the system command to execute.

For example:

```
M130 "mycommand.bat"
```

will run the batch file *mycommand.bat*.

Normally, the command will run asynchronously, meaning that the G-code program will not wait for the command to finish before continuing. However, if an L1 parameter is given, the command will prevent further G-code execution until a fault occurs (such as E-Stop).

M150 – Set Spindle Position to 0 on Next Index Pulse

M150 will cause the spindle encoder position to be reset to 0 upon the next encounter of the spindle encoder's index pulse. M150 will not generate spindle movement. As a matter of fact, the spindle needs to be commanded to move in order for M150 to work.

M151 – Unwind C axis

This M function will reset the C axis position to less than one revolution of the C axis (< 360 degrees).

Example (M51)

```
G97          ; Turn off CSS (constant surface speed)  
M3 S0       ; Turn off spindle  
M101/9      ; Wait for zero speed signal from inverter on INP9  
M94/9       ; Switch to torque mode  
M51         ; Perform the default actions for C axis enable  
M151        ; Unwind C-axis position
```

Note in the above examples for M50 and M51 where the M95/9 (turn off INP41) and M94/9 (turn on INP41) commands are used, it is assumed that the plc program, conditioned upon the state of INP41, has been modified to output the appropriate hardware signals required to switch between speed and torque mode.

Warning: The spindle must be stopped before issuing the M151 or unpredictable positions can result.

Formatted String Commands- M200, M223, M224, M225 & M290

The formatted string commands are provided to assist in custom screen and file I/O. A “*formatted-string*” is similar to the C programming language “printf” command, with various restrictions. The basic form of a *formatted-string* is a quoted string (comprised of a **single** line of up to 1024 characters) followed by a (possibly empty) list of user and/or system variable expressions. The variable expression is a '#' character followed by a number or bracketed expression. For example, given #100 = 88* (ASCII 'X'), #300 = “absolute”, and #101 = 1.2345, this string:

“The %c* axis %s position is %f” #100 #300 #101 evaluates to “The X* axis absolute position is 1.234500”

The “%c”* is replaced by the ASCII character value of user variable #100, the “%s” is replaced by the string user variable #300, and the “%f” is replaced by the value of user variable #101.

Type specifiers

The 's', 'c', and 'f' are type specifiers, with 's' specifying a string user variable, 'f' specifying a floating point user variable, and 'c' specifying a single character substitution using the integer part of a floating point user variable. There should be one user variable expression for every '%' character in the quoted string. It is also possible to specify a field width by inserting a number between the '%' and the type specifier. Example:

%20s – specifies that the substituted string is displayed in a field 20 characters long, right justified and padded with spaces on the left. Use “%-20s” for left justification.

The 'f' type can specify a precision such as:

- “%.4f” - display number rounded at the fourth decimal place.
- “%9.4f” - as above but in a field width nine characters wide.
- “%+9.4f” - as above with a '+' output if variable is positive.
- “%.0f” - display number rounded to integer

Special characters

The quoted string may contain one or more “\n”, each of which will be converted to a single newline character. Up to seven newlines can be specified in a single formatted string. However, a formatted string may not contain an embedded quote character ”” or other *printf*-style escape sequences such as '\t', '\\', or '\”’. If a quote character is desired, use a %c type specifier with a variable expression equal to 34.

User string variables #300-#399. These variables can be assigned a quoted string up to 80 characters in length and are retained until the CNC software is exited. For example,

#300 = “This is a text string of characters”

*The above method of representing an axis label should be used only when writing to an external file or for display in a message box. It is not valid if you are attempting to “build” a motion command in real-time from within the currently running g code program. If your intent is to use a variable to represent an axis label for a real-time command, you should instead use \$ as the placeholder. The parser will replace a '\$' character and the numerical expression following it with the ASCII character equivalent to the numerical expression, provided that it evaluates to the characters 'A' (65) through 'Z' (90). If the numerical expression is out-of-bounds, an “Invalid character” error occurs. Ex:

Given #100 = 88, #101 = 1, #102 = 90, #103 = 2 and #104 = 10

G1 \$[#100][#101] \$[#102][#103] F[#104] evaluates to G1 X1 Z2 F10

M200/M201 – Stop for Operator, Prompt for Action

M200 is used to pause the currently running job and prompt the operator for action. If M0_jogging is unlocked, or the control is in DEMO mode, jogging is enabled while waiting for the operator to respond. If this option has not been enabled, the behavior will default to that of a standard M0. (jogging disabled)

The syntax is: M200 *formatted-string* [[*user_var_expr*] ...]

Example:

M200 “Please jog the %c and %c axes to the desired X0, Z0 position\nPress Cycle Start to continue” #100 #101

M201 behaves exactly like M200 except that PLC bits SV_PROGRAM_RUNNING, SV_MDI_MODE, and SV_JOB_IN_PROGRESS are turned off while the prompt is displayed.

M223 – Write Formatted String to File

The M223 command writes a *formatted-string* to a file that was opened using the M120 or M121 commands. The syntax is:

M223 *formatted-string* [[*user_var_expr*] ...]

Example:

M223 “; The measured diameter of the pocket = %.4f\n” #100

M224 – Prompt for Operator Input Using Formatted String

The M224 command displays a *formatted-string* and then accepts user input. The syntax is:

M224 *lvalue_expr formatted-string* [[*user_var_expr*] ...]

Where *lvalue_expr* is a *user_var_expr* that evaluates to a user variable that can be written. If *lvalue_expr* is a string type (#300-#399) then the user input is assigned verbatim to the string. Otherwise, the user input is evaluated as any other “bracketed” numerical expression.

Example:

M224 #300 “Please enter the direction that you wish to probe in the %c axis: (+ or -)” #100

M225 – Display Formatted String for A Period of Time

The M225 command displays a *formatted-string* for a specified period of time. The syntax is:

M225 *time_expr formatted-string* [*user_var*] ...

where *time_expr* is a *user_var_expr* that evaluates to a floating point variable specifying the number of seconds to display the output, with a value of zero interpreted as indefinitely. The CYCLE_START key can be used to immediately continue running without waiting for the time to expire.

Example:

M225 #100 “Warning, %s is not selected\nPlease select %s and press Cycle Start to continue” #300 #300

M290 – Digitize Profile (Optional)

This performs a 2 axis digitize, probing along an axis while stepping over using a perpendicular travel axis. M290 expects that a file is already open with M120/121 (however, if not open, there will be no output).

The syntax is:

```
M290 /a__ #vvv /b__ #vvvv "formatted-string" Q__ R__ P__ L__
```

The first axis mentioned will be treated as the probing axis and the second will be treated as the travel axis.

Explanation of M290 Arguments:

/a +-nnn.nnn is the probing direction and max distance on axis “a”

/b +-nnn.nnn is the travel direction and max distance on axis “b” (perpendicular to probing axis)

#vvv and #vvvv (optional) are G-code variables that will be a receptacle of the very last probed position of the cycle.

"formatted-string" (optional) is the format of the output (if not mentioned, then there will be no output to file)

Q__ is the steperover along the travel direction (this is a positive quantity)

R__ (optional) is the retract/pullback amount upon interruption or completion.

P__ (optional) is the interruption PLC bit state which causes a graceful end to the cycle. (If not mentioned, then no PLC bit will checked for graceful interruption.)

L__ (optional) is the output variable to which to store the interrupt status

(0=no interruption, 1=interrupted by PLC bit P__, 2=surface not found error).

M300 – Fast Synchronous I/O update

There are 32 user definable fast system integer variables that can be used to communicate with the PLC (similar to M94 and M95), but without causing motion to decelerate to a stop* (unlike M94 and M95). The syntax is:

```
M300 /nn /vvv
```

where *nn* is 1-32 and *vvv* is a 32-bit signed integer value. The parameter *nn* (1-32) maps to system variables SV_FSIO1 - SV_FSIO32. These commands work in conjunction with a PLC program that can read the SV_FSIOx and act upon them.

Example:

```
M300 /21 /-1234 ; set SV_FSIO21 to integer value -1234
```

* NOTE: Motion will be decelerated to a stop if Smoothing is turned on (P220 = 1).

M1000-M1015 – Graphing Color for Feedrate movement

When a CNC program is graphed (F8 from the Main Screen), feedrate movements are normally plotted using the color yellow. This color setting can be changed to another color as stated in the chart below.

M Code	Feedrate Graphing Color
M1000	black
M1001	Navy blue
M1002	green
M1003	teal
M1004	orange
M1005	blue
M1006	lime
M1007	aqua

M Code	Feedrate Graphing Color
M1008	maroon
M1009	purple
M1010	olive
M1011	gray
M1012	red
M1013	fuschia
M1014	yellow
M1015	white

Changing this feedrate graphing color can be used as a method highlighting or hiding parts of a graphed CNC program, but will not affect the normal run of the program (when the CYCLE START button is pressed on the Main Screen). The limitations to using these M codes are as follows: These M codes cannot be placed on the same line as another M code, and also the rapid (G0) movement color cannot be changed.

Chapter 13

CNC Program Example

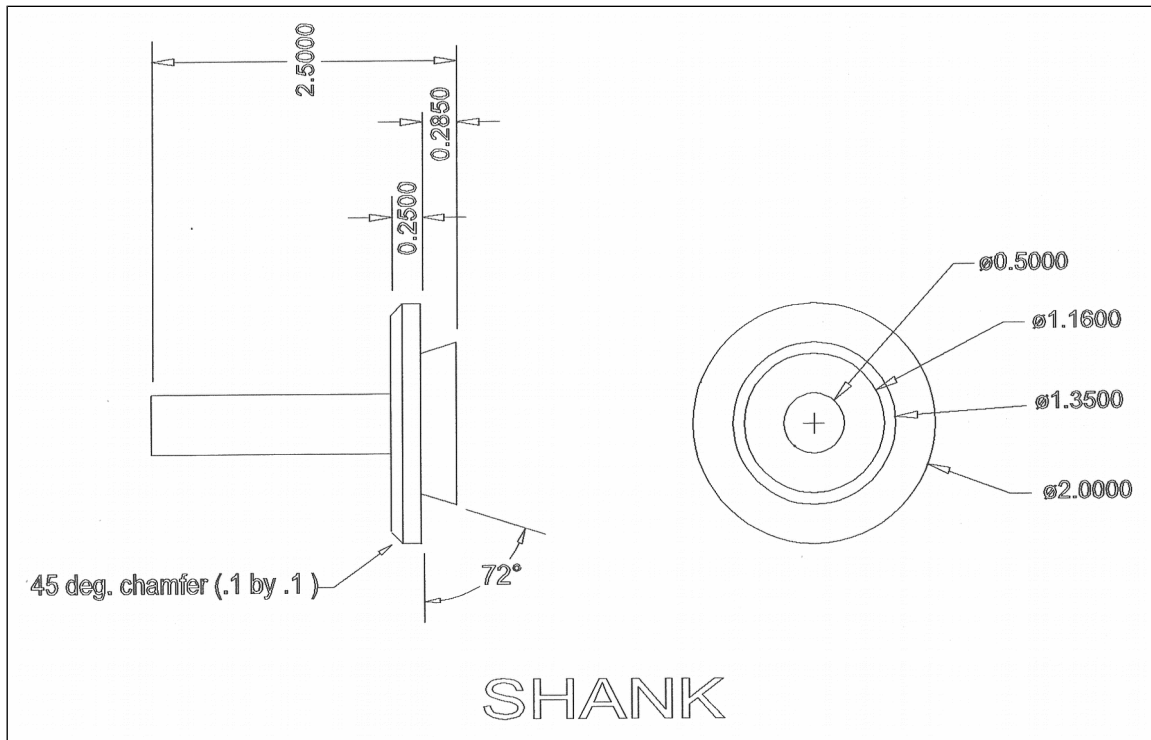

CNC Program

```

N010 G20
N015 G50 S3000
N020 G00 T0303
N025 G97 S1777 M03
N030 G00 X1.72 Z0.
N035 G96 S800
N040 X1.72
N045 G99 G01 Z-1.955 F.01
N050 X1.7901
N055 X2.02 Z-2.0699
N060 Z-2.215
N065 X2.04
N070 G00 Z0.
N075 X1.42
N080 G01 Z-1.955
N085 X1.74
N090 G00 Z0.
N095 X1.12
N100 G01 Z-1.955
N105 X1.44
N110 G00 Z0.
N115 X.82
N120 G01 Z-1.955
N125 X1.14
N130 G00 Z0.
N135 X.52
N140 G01 Z-1.955
N145 X.84
N150 G00 Z0.
N155 X.52
N160 G01 Z-1.955
N165 X.54
N170 G00 X2.1
N175 G97 S3000
N180 Z0.
N185 X.5
N190 G96 S1000
N195 G01 Z-1.965 F.003
N200 X1.7818
N205 X2. Z-2.0741
N210 Z-2.215
N215 G28 T0300
N220 M05
N225 M00
N230 G50 S3000
N235 G00 T0404
N240 G97 S1135 M03
N245 G00 X2.02 Z-2.228
N250 G96 S600
N255 X2.02
N260 G99 G01 X1.1932
N265 G00 X2.02
N270 Z-2.2392
N275 G01 X1.2005

```

N280 G00 X2.02
N285 Z-2.2503
N290 G01 X1.2078
N295 G00 X2.02
N300 Z-2.2615
N305 G01 X1.2151
N310 G00 X2.02
N315 Z-2.2727
N320 G01 X1.2224
N325 G00 X2.02
N330 Z-2.2838
N335 G01 X1.2297
N340 G00 X2.02
N345 Z-2.295
N350 G01 X1.237
N355 G00 X2.02
N360 Z-2.3062
N365 G01 X1.2444
N370 G00 X2.02
N375 Z-2.3173
N380 G01 X1.2517
N385 G00 X2.02
N390 Z-2.3285
N395 G01 X1.259
N400 G00 X2.02
N405 Z-2.3396
N410 G01 X1.2663
N415 G00 X2.02
N420 Z-2.3508
N425 G01 X1.2736
N430 G00 X2.02
N435 Z-2.362
N440 G01 X1.2809
N445 G00 X2.02
N450 Z-2.3731
N455 G01 X1.2882
N460 G00 X2.02
N465 Z-2.3843
N470 G01 X1.2956
N475 G00 X2.02

N480 Z-2.3955
N485 G01 X1.3029
N490 G00 X2.02
N495 Z-2.4066
N500 G01 X1.3102
N505 G00 X2.02
N510 Z-2.4178
N515 G01 X1.3175
N520 G00 X2.02
N525 Z-2.429
N530 G01 X1.3248
N535 G00 X2.02
N540 Z-2.4401
N545 G01 X1.3321
N550 G00 X2.02
N555 Z-2.4513
N560 G01 X1.3394
N565 G00 X2.02
N570 Z-2.4625
N575 G01 X1.3468
N580 G00 X2.02
N585 Z-2.4736
N590 G01 X1.3541
N595 G00 X2.02
N600 Z-2.4848
N605 G01 X1.3614
N610 G00 X2.02
N615 Z-2.496
N620 G01 X1.3687
N625 G00 X2.02
N630 G97 S1910
N635 Z-2.218
N640 X2
N645 G96 S1000
N650 G01 X1.1656
N655 X1.3497 Z-2.4991
N660 G28 T0400
N665 M05
N670 M30

Chapter 14

Configuration

(F3 from Setup)

WCS #1 (G54)	Current Position (inches)	Job Name: TEST.CNC
X 	+0.0000	Tool: T0000
Z	+0.0000	Feedrate: 200%
		Spindle: 0
		Feed Hold: Off
		Stopped
		Press CYCLE START to start job
Configuration		
Contrl F1	Mach. F2	Parms F3
		PID F4

General

The configuration option provides you with a means for modifying the machine and control configuration. The majority of information in this section should not be changed without contacting your dealer.



WARNING

Some of the data, if corrupt or incorrect, could cause personal injury or machine damage.

Password

When you press **F3-Config** from the Setup Menu, you may be prompted to enter a password. This level of security is necessary so that users do not accidentally change vital parameters. The original default password is distributed in the documentation provided to the owner of the machine when the control is installed. This password is changeable via parameter 42.

If you know the password, type it and press **ENTER**. If the password you enter is incorrect, a message will appear telling you the password was incorrect and the password prompt will reappear. Pressing **ESC** will remove the prompt.

If you don't know the password, simply press **ENTER**. You will be given access to the configuration options so that you can view the information. However, you will not be able to change any of the data.

Control Configuration

Pressing **F1-Contrl** from the configuration menu will display the Control Configuration menu in the edit window. The Control Configuration menu provides you with a method of changing control dependent data. Each of the fields is discussed in detail below.

If you wish to change a field, use the up and down arrow keys to move the cursor to the desired field. Type the new value and press **ENTER**, or press **SPACE** to toggle. When you are done editing, press **F10-Save** to save any changes you have made. If you wish to discard your changes and restore the previous values, press **ESC**.

WCS #1 (G54)	Current Position (Inches)	Job Name: 06.cnc
X 	+0.0000	Tool: T0000
Z	-0.2976	Feedrate: 19% 0.0 ipm
		Spindle: 0 A
<div style="border: 1px solid black; padding: 2px;">UNDEFINED PLC MESSAGE (99) 406 Emergency stop detected UNDEFINED PLC MESSAGE (39)</div>		
Control Configuration		
DRO display units:	Inches	(Inches / Millimeters)
Machine units:	Inches	(Inches / Millimeters)
Max spindle (high range):	4000.0	(1.0 to 500000.0 RPM)
Min spindle (high range):	0.0	(0.0 to 500000.0 RPM)
Machine home at pwrup:	Home Switch	(Jog / Home Switch / Ref Mark-HS)
PLC type:	Standard	(Standard / IO2 / RTK2 / None)
Jog Panel type	Jogboard	(Jogboard / Legacy / Offline)
Jog panel required:	No	(No / Yes)
Remote Drive & Directory:	E:\	
Press SPACE to change		
		<div style="border: 1px solid black; padding: 2px; display: inline-block;">Save F10</div>

DRO Display Units

This field controls the units of measure the DRO displays. The two options are ' Millimeters ' and ' Inches '. When this field is highlighted by the cursor, "Press SPACE to change" appears at the bottom of the menu. This message is explaining that pressing the **SPACE** key will toggle the value of this field between the two options.

The DRO display units do not have to be the same as the machine units of measure (explained below). This field is provided for users of the G20 & G21 codes so that they may view the tool position in terms of job units (see Chapter 11).

Machine Units of Measure

This field controls which units of measure the machine uses for each job. The two options are ' Millimeters ' and ' Inches '. Press **SPACE** to toggle the field between the two options.

This field determines the default interpretation of job dimensions and feedrates. If ' Inches ' is selected, all feedrates and dimensions will be interpreted as inches as well as any unit dependent parameters.

- **NOTE:** This field should rarely, if ever, be changed. If you wish to run a job in units other than the default machine units, use the G20 & G21 codes.

Maximum Spindle Speed (High Range)

This field sets the high range maximum spindle speed. All spindle speeds entered in a CNC program are output as percentages of this maximum value. If your machine is equipped with a multi-range drive, the control will not exceed the spindle speed set by this field while in high gear. See the Machine Parameters section for information on setting the gear ratios for medium and low gear ranges. If your machine is not equipped with a multi-range drive, this field determines the maximum spindle speed.

Minimum Spindle Speed (High Range)

This parameter is used to adjust the minimum spindle speed for the high range. This parameter allows the operator to set the minimum value for spindle speed to a value other than 0. All changes in spindle speed are made in relationship to this value, with this parameter as the minimum value. The values stored can range from 0 to 500000.0 RPM.

Machine Home at Power-up

This field controls how the machine will home at power-up. Set Machine Home at Power-up to **Limit Switch** if you are homing off of switches or safe hard stops for all axes, and wish to use the switches or stops for homing. Set Machine Home at Power-up to **Ref Mark-HS** if you are homing any axis to a fixed reference mark. In Ref Mark homing, axes that contain a zero (0) for the plus or minus home switch in the Machine Configuration designate that axis to have a Ref Mark home, while non-zero values specify Limit Switch homing. Set Machine Home at Power-up to **Jog** if you need to manually move or jog the machine to its home position. See Chapter 1 for more information about machine home.

PLC Type

This field tells the controller which PLC type is installed. The available choices are: Standard, Legacy IO2, Legacy RTK2, and None.

Jog Panel Type

This field tells the controller which type of Jog Panel is installed. The available choices are: Jogboard, Legacy, and Offline.

Remote Drive & Directory

This field sets up the remapped default drive and directory for the **F3-Remote** key in the Load Job screen. This allows you to conveniently load files from an attached computer via network (RJ-45 Ethernet) connection. The network drive must be mapped in cnc.net.

User-Specified Paths

Operators can specify paths for INTERCON files and posted INTERCON files. These paths are specified in *pathl.ini*. This file is automatically generated by CNC11 if it does not exist. The default *pathl.ini* file is:

```
INTERCON_PATH=c:\icn_lath\  
ICN_POST_PATH=c:\cnc\ncfiles\
```

Path tag	Purpose of path
INTERCON_PATH	Main directory containing *.lth files
ICN_POST_PATH	Directory INTERCON places *.cnc files created when posting *.lth files.

Machine Configuration

Pressing **F2-Machine** from the configuration menu will bring up the machine configuration menu, which provides you with a method of changing machine dependent data.

If you wish to change a field, press **F1-Jog** or **F2-Motor** to select the Jog or Motor fields, use the arrow keys to move the cursor and select the desired field. Type the new value and press **ENTER** or press **SPACE** to toggle. When you are done editing, press **F10-Save** to save any changes you have made. If you wish to discard your changes and restore the previous values, press **ESC**. Pressing **ESC** again will return you to the previous menu (Setup).

- NOTE: Although X appears on the first line of the DRO and Z appears on the second, their order is reversed on all configuration menus. X is axis 2, and Z is axis 1.
- NOTE: Some of these values are set automatically by the Autotune option (See PID Menu later in this chapter).

F1 - Jog Parameters

This screen contains jog and feedrate information. See the figure below.

Axis	Slow Jog (in/min)	Fast Jog (in/min)	Max Rate (in/min)	Deadstart (in/min)	Delta Vmax (in/min)	Travel (-) (Inches)	Travel (+) (Inches)
1	10	300	300	20.0000	20.0000	0.0000	0.0000
2	10	300	300	20.0000	20.0000	0.0000	0.0000
3	50	300	300	20.0000	20.0000	0.0000	0.0000
4	500	10000	10000	200.0000	200.0000	0.0000	0.0000
5	50	300	300	20.0000	20.0000	0.0000	0.0000
6	500	10000	10000	3.0000	3.0000	0.0000	0.0000
7	0	0	0	0.0000	0.0000	0.0000	0.0000
8	0	0	0	0.0000	0.0000	0.0000	0.0000

A description of each of these parameters is listed below.

- NOTE: Some of these values are set automatically by the Autotune option (See PID menu later in this chapter).

Slow Jog: Determines the speed of motion on an axis when slow jog is selected and a jog button is pressed. The slow jog rate cannot be set to a value greater than the maximum rate.

Fast Jog: Determines the speed of motion on an axis when fast jog is selected and a jog button is pressed. The fast jog rate cannot be set to a value greater than the maximum rate.

Max Rate: Determines the maximum feedrate of each individual axis. The feedrate on each axis can never exceed Max Rate, even if the feedrate override knob on the front panel is turned up above 100%. (See also the Machine Parameters section for the "Multi-Axis Max Feedrate" parameter that limits the feedrate along move vectors, not just each individual axis.)

- NOTE: The maximum rate may be set to a smaller value if you wish to run your machine at a slower rate.

Deadstart: Determines the speed to which an axis decelerates before stopping or reversing direction. A low setting will cause a large slowdown before reversals of direction, causing your machine to be more accurate. A high setting will cause less slowdown before reversals, but this may cause your machine to "bang" and you may lose accuracy. This parameter should not be changed.

Delta Vmax: The maximum instantaneous velocity change that will be commanded on a vector transition. This parameter should not be changed.

Travel (-): The maximum distance the axis can travel in the minus direction from the home position. Set this parameter to create a software limit that stops the axis before the fixture or tool collides with the machine.

Travel (+): The maximum distance the axis can travel in the plus direction from the home position. This parameter is especially useful when using a part or fixture larger than the lathe bed. Set this parameter to create a software limit that stops the axis before the fixture or tool collides with the machine.

F2 - Motor Parameters

This screen contains information about the motors, ballscrews, and switches installed on your machine.

Axis	Label	Motor	EncoderLash	Comp.	Limit	Home	Dir	Screw
		revs/in	counts/rev	(Inches)	-	+	-	+
1	Z	5.00000	8000	0.00000	1	2	1	2
2	X	5.00000	8000	0.00000	3	4	3	4
3	N	5.00000	8000	0.00000	5	6	5	6
4	N	0.25000	8000	0.00000	0	0	0	0
5	N	5.00000	8000	0.00000	0	0	0	0
6	N	0.25000	8000	0.00000	0	0	0	0
7	s C	5.00000	8000	0.00000	0	0	0	0
8	N	0.00000	0	0.00000	0	0	0	0



WARNING

The Motor Parameters should not be changed without contacting your dealer. Corrupt or incorrect values could cause damage to the machine, personal injury, or both.

Special function indicators: These appear, if present, between the axis number and the label. 's' – axis is the spindle, 'p\$' – axis is paired with axis '\$', '*' – pairing conflict. See Machine Parameters for more information on setting up special functions.

Label: The letter you want to use to identify the axis. The first two axes should always be Z and X. The unused entries should be labeled N.

• NOTE: Although the 3rd through 8th axes are available in the lathe software, they may be used for special tool changer and C axis applications. For C axis applications, the label must be set to C and the corresponding motor parameter (93 or 94) must have the C axis bit on.

Motor revs/inch OR Millimeters / motor rev: The number of revolutions of the motor that results in one inch of movement (if the machine is set up in inches). OR the number of millimeters that the machine will move as a result of one turn of the motor (if the machine is set up in millimeters).

Encoder counts/rev: The counts per revolution of the encoders on your servo motors.

Lash compensation: The uniform amount of backlash compensation to be applied along the whole length of the axis. Backlash can be observed during axis direction reversals and is a normal occurrence due to looseness or wear of moving parts in a machine. This parameter added to and works in conjunction with Screw Compensation (see below). Consult your machine manual or T-Series Service Manual for instructions on measuring backlash.

- NOTE: It is required that the machine be rehomed after changing Lash Compensation.

Limits: The PLC input numbers corresponding to any limit switches that you may have on your machine. Your installer should provide this information. If no limit switch is installed, this field should be set to 0.

Homes: The PLC input numbers of any Home Switches you may have. These are similar to the limit switches. If your machine does not have home switches, this field should be set to the Limit Switch value. If no home or limit switch is installed, this field should be set to 0. You may then use hard stops as homing points if you choose.

- NOTE: The Home Switch should never be physically located beyond the Limit Switch.

Direction reversed: Used to match the +/- reference of your machine to the control electronics. Toggle this value if you actually move in the Z direction (reverse) when you jog Z+.

Screw Compensation: This value indicates whether mapping ballscrew compensation is enabled. Screw Compensation is similar to Lash Compensation (see above), but has differing compensations depending on the mapped locations along the axis. Screw Compensation is added to and works in conjunction with Lash Compensation. For more information, contact your dealer. It is recommended that you enable ballscrew error compensation at all times.

- NOTE: It is recommended that a rehoming of the machine be done after changing Screw Compensation.

F3 - Find Home

Press **F3-Find Home** to move an axis to its plus or minus home switch.

F4 - Set Home

Press **F4-Set Home** to set Machine Home for an axis at its current position. This is usually performed after Find Home. This operation should not be used to set the part zero position. To set the part zero position, use the Part Setup menu as described in Chapter 5.

F5 – M Comp

This menu lets you edit the ballscrew compensation tables.

NOTICE The ballscrew compensation tables **should not** be changed without contacting your dealer. Corrupt or incorrect values could adversely affect the accuracy of the positioning of your machine.

F7 – Scales

This menu lets you set up scale encoders for the purpose of applying scale encoder correction to one or more axes.

WCS #1 (G54)		Current Position (Inches)		Job Name: pawn.cnc			
X		+0.0000		Tool: T0303			
Z		+0.0000		Feedrate: 100% 0.0 ipm			
C		+0.0000		Spindle: 0 A			
				335 Emergency stop released			
				301 Stopped			
Press CYCLE START to start job							
Scale Settings							
Axis	Label	Input	Enabled	Scale Counts/Inch	Ratio	Deadband	Velocity
1	Z	0	N	0.0000	0.0000	0	0.0000
2	X	0	N	0.0000	0.0000	0	0.0000
3	C	0	N	0.0000	0.0000	0	0.0000
4	N	0	N	0.0000	0.0000	0	0.0000
5	N	0	N	0.0000	0.0000	0	0.0000
6	N	0	N	0.0000	0.0000	0	0.0000
7	N	0	N	0.0000	0.0000	0	0.0000
8	N	0	N	0.0000	0.0000	0	0.0000
Save							
F10							

NOTICE The Scale Settings **should not** be changed without contacting your dealer. Corrupt or incorrect values could adversely affect the accuracy of the positioning of your machine.

Axis and Label are for informational purposes to indicate on which axis the scales will be applied. These values cannot be modified on this screen.

Input is the scale encoder number based on the map shown on parameters 308-315. Numbers 1-6 are on the MPU11 and 7-14 are on Optic4 drives. If spare headers are available on the Optic4, they can be used for scale feedback.

Enabled Y enables the scale and N disables the scale.

Scale Counts/Unit is the number of counts of the scale per unit of measurement. This value should come directly from the scale data sheet and should be entered in the control units. If the control is in inches, then the value should be entered in inches.

Ratio is calculated as $[(\text{Motor Encoder Counts per Rev.} * \text{Motor Rev. per Unit}) / \text{Scale Counts per Unit}]$ and cannot be modified. It shows how close the counts/unit are between the motor encoder and scale encoder.

Deadband is the number of encoder counts away from the commanded position that the scale position can be before compensating. Typically an integer multiple from 1 to 3 times the Ratio should be used.

Velocity is the number of motor encoder counts / interrupt at which the Scales should adjust the position. Typically a value of 0.5 is a good starting value. To figure out a value to use based on a units/min. speed you need to convert it. The equation is $[\text{units/min.} * \text{Motor Encoder Counts per Rev.} * \text{Rev. per unit} * (1\text{min}/60\text{ sec.}) * (1\text{sec.}/4000\text{ int})]$.

Due to the nature of scale feedback it is inherently an oscillator and by adjusting the Deadband and Velocity that oscillation can be kept to a minimum.

Scale Indicator Changing the Input, Enabled, or Scale Counts/Unit fields will cause scale compensation to be temporarily disabled. Scale compensation is also temporarily disabled during homing moves. Even though the scale is enabled in the menu, scale compensation will be disabled until the axis is rehomed. When a scale is configured for an axis, a scale indicator appears below the axis label on the DRO. It will have a green background when the scale is enabled and a red background when the scale is disabled.

X +0.0000

Machine Parameters

(F3 – ParmS from Configuration)

Machine Parameters 0 - 99									
0	0.0000	20	72.0000	40	0.0001	60	0.0000	80	0.0000
1	0.0000	21	0.0400	41	0.2500	61	0.5000	81	-1.0000
2	0.0000	22	0.0400	42	54.0000	62	115.0000	82	1000.0000
3	0.0000	23	0.0400	43	0.0250	63	1.5000	83	0.0500
4	5.0000	24	0.0400	44	0.0010	64	0.0000	84	3.0000
5	0.0000	25	0.6800	45	0.0000	65	1.0000	85	1.0000
6	1.0000	26	0.6800	46	0.0000	66	1.0000	86	0.0000
7	1.0000	27	0.6800	47	1.0000	67	1.0000	87	36.0000
8	3.0000	28	0.6800	48	0.1000	68	640.0000	88	36.0000
9	0.0000	29	150.0000	49	0.0000	69	1.7500	89	36.0000
10	0.0000	30	180.0000	50	1.0000	70	0.0010	90	36.0000
11	15.0000	31	-1.0000	51	0.0000	71	0.0000	91	0.0000
12	10.0000	32	19200.0000	52	0.0010	72	0.0000	92	0.0000
13	0.0500	33	1.0000	53	0.0100	73	0.1000	93	0.0000
14	30.0000	34	-8000.0000	54	0.0000	74	4.0000	94	0.0000
15	6.0000	35	3.0000	55	0.0000	75	0.0000	95	4.0000
16	10.0000	36	1.0000	56	32000.0000	76	0.0000	96	4.0000
17	3.0000	37	3.0000	57	0.0000	77	0.0000	97	4.0000
18	10.0000	38	0.0000	58	179.9500	78	0.0000	98	2.0000
19	0.0000	39	200.0000	59	0.0100	79	49.0000	99	2.0000

E-Stop PLC Bit Number

Prev. Table F7	Next Table F8	Save F10
----------------------	---------------------	-------------

This screen provides you with a method of changing various parameters that are used by the control. Altogether, you have access to 500 parameters spread across 5 tables. Each table gives you access to 100 parameters at a time. You can navigate between tables using the following keys: **F7-Previous Table** and **F8-Next Table**. The title at the top tells you which table you are on. If you wish to change a field in the table, use the arrow keys to move the cursor and select the desired field. A short description of the parameter will appear below the table. Type the new value and press **ENTER**. When you are done editing the fields, press **F10-Save** to accept any changes you have made and save them. Note that **F10-Save** is a single operation that will save all changes in every table that you modified. Pressing **ESC** will discard all changes in every table that you modified and will return to the previous menu [Setup].

- NOTE: Many machine parameters can also be set with the G10 G-code or by #variable assignment.

Bit-mapped parameters

Certain control parameters are defined by bit-mapped values. In order to change these parameters you must understand how bit mapping works. A bit-mapped parameter is stored as a number, representing a 16-bit value in the control. If a certain bit needs to be turned on, that bit's binary value must be added to the parameter value, if the bit needs turned off, its binary value must be subtracted from the parameter value. The values for each of the 16 bits can be seen in the table below.

Bit-Mapped Parameter Bits																
Bit	15	14	13	12	11	10	9	8	7	6	5	4	3	2	1	0
Value	32768	16384	8192	4096	2048	1024	512	256	128	64	32	16	8	4	2	1

To set bit-mapped parameters simply add together the bit values that you need to have enabled.

Examples:

Parameter value	Bit number and settings															
	15	14	13	12	11	10	9	8	7	6	5	4	3	2	1	0
0	X	X	X	X	X	X	X	X	X	X	X	X	X	X	X	X
1	X	X	X	X	X	X	X	X	X	X	X	X	X	X	X	ON
11 < 8+2+1	X	X	X	X	X	X	X	X	X	X	X	X	ON	X	ON	ON
24 < 16+8	X	X	X	X	X	X	X	X	X	X	X	ON	ON	X	X	X

The following table shows the parameters that are currently defined:

Parameter	Definition	Default
0	E-Stop PLC Bit	0
1	Machine and Jog key orientation	0
2	G-Code Interpretation Control	0
3	Modal Tool and Length Offset Control	0
4	Remote File Loading Flag & Advanced File Ops	0
5	Suppress Machine Home Setup	0
6	Auto Tool Changer installed	0
7	Display colors	0
8	Available coolant system(s)	2
9	Display language	0
10	Macro M function control	0
11	Probe PLC Input	0
14	Fast Probing Rate	Refer to text
15	Slow Probing Rate	Refer to text
16	Probing Search Distance	10
18	PLC Input Spindle Inhibit Parameter	Refer to text
20	Ambient temperature	72°F / 22°C
21-24	Motor heating coefficients for axes 1,2,3,4	Refer to text
25-28	Motor cooling coefficients for axes 1,2,3,4	Refer to text
29	Warning temperature	150°F / 65.5°C
30	Limit temperature	180°F / 82°C
31	Legacy SPIN232 Com Port	0
33	Spindle Motor Gear Ratio	1
34	Spindle Encoder Counts/Rev	8,000
35	Spindle Encoder Axis Number	0
36	Rigid Tapping Enable/Disable	0
37	Spindle Deceleration Time	10
38	Multi-Axis Max Feedrate	0
39	Feedrate Override Knob Limit	120
40	Basic Jog Increment	.0001" / .001 mm
41	Rotary Axis Jog Increment	.01°
42	Password for Configuration Menus	0
43	G71/72 Depth of Cut	0.001
44	G71/72 Escape Amount	.001
45	G74 X Axis Relief Amount	0
46	G75 Z Axis Relief Amount	0
47	G73 Repeat Count	1
49	Thread Chamfer Amount	0
50	G76 Finish Count	1
51	G76 Thread Angle	0
52	G76 Minimum Cutting Depth	0.001
53	G76 Finish Allowance	0.0

Parameter	Definition	Default
55	Radius / Diameter mode	0
56	Feedrate Override Display Properties	0
57	Use Generic Load Meter Data from PLC	0
58	G71/G72 Profile Rough Cut Escape Angle	45
61	High Power Stall Timeout	.5
62	High Power Stall PID Limit	115
63	High Power Idle PID Multiplier	1.5
64	4 th /5 th Axis Pairing	0
65-67	Spindle Gear Ratios	1
68	Minimum rigid tapping spindle speed	0
69	Duration for minimum spindle speed	1.0
70	Offset Library Inc/Decrement Amount	.001" / .02 mm
72	Data Recording M-Function Options	0
73	Peck Cutting Retract Amount	0.05
74	M-Function executed at tap hole depth	4
78	Display of spindle speed	0
80	Voltage Brake Applied Message Frequency	0
82	Spindle drift adjustment	0.0
83	Deep Hole Clearance Amount	0.05
84	M-Function executed at return to initial point of tapping cycle	3
85	“Door Open” Interlock PLC bit	0
86	Rapid/Linear vector rate limit	0
87-90	Autotune Ka Performance parameters for axes 1,2,3,4	48
91-94	Axis Properties for axes 1,2,3,4	0
95-98	Autotune / Auto Delay Move Distance for axes 1,2,3,4	2.0" / 50.8 mm
99	Cutter Diameter Compensation Look-ahead	1
100	Intercon comment generation	0
101	Intercon clearance amount	0.1
102	Intercon spindle coolant delay	3.0
104	Intercon modal line parameters	0
105	Intercon modal arc parameters	0
106	Intercon modal drilling cycle parameters	0
107	Intercon chamfer blend radius	0.01
108	Intercon polar display	1
109	Intercon modal display	1
111	Intercon no spindle stop during tool change	0
112	Intercon no coolant stop during tool change	0
114	Intercon use G28 during tool change	0
115	Intercon help	0
116	Intercon G50 max spindle speed	0
132-135	Motor Heating Coefficients for axes 5,6,7,8	Refer to text
137	Load Meter Filter Size	0
138	DRO Encoder Deadband	0
140	Message log priority level	1
141	Maximum message log lines	100
142	Message log trim amount	100
143	DRO properties (load meters, 4/5 digits, DTG)	0
144	Comparison rounding	0
145	Advanced macro options (fast branching)	0
146	Feed hold threshold for feed rate override	0
147	Number of Status Messages to keep in Operator Message Window	10

Parameter	Definition	Default
148	Miscellaneous Jogging Options	0
149	Spindle Speed Threshold	1.0
150	Backplot Graphics display options	0
154	Touchscreen options	0
155	DSP Probe Installed	0
156-159	Autotune / Auto Delay Move Distance for axes 5,6,7,8	2
163	Gang tooling	0
165	Acceleration/Deceleration Options	0
166-169	Axis Properties for axes 5,6,7,8	0
170-177	PLC parameters	0
178	PLC I/O configuration (PLC program specific)	0
179	Lube Pump Operation	0
187	Hard Stop Homing Power Limit	0
188-199	Aux key functions	0
200-207	OPTIC4 Tach Volts Per RPM	0
208-215	MPU Lash/Screw Comp Acceleration Coefficient	0.125
216	PC Based Lash Compensation on/off	0
217	PC Based Screw Compensation on/off	0
220-231	Smoothing Configuration of Feed Per Minute moves	Refer to text
236-239	Motor Cooling Coefficients for axes 5,6,7,8	0
240-241	Rigid Tapping Decel and Stepsize	0
242	Minimum Angle Threshold for application of Accel/decel in Threading moves	30
243	Threading Control	0
244	Tool Touch-off device PLC input number	0
245	G7x D/P/Q "implied float" re-interpretation threshold for Inch	99
246	G7x D/P/Q "implied float" re-interpretation threshold for MM	99
247	G70 Multiple Pass Behavior Suppression	0
248	Tool Wear Adjustment magnitude limit	.2" / 5.08 mm
252-255	Autotune Ka Performance parameters for axes 5,6,7,8	0
256	Drive mode	0
257	Tool Touch-off device connection detection PLC input	0
258	Velocity/Torque Mode override in Precision mode	0
259	Manual Axis Designation	0
261-262	Precision Mode Standoff Threshold	0
278	Spindle Speed Display Precision	0
281	Tool Touch-off Device X stylus size	Refer to text
282	Tool Touch-off Device Z stylus size	Refer to text
283	Auto Tool Touch-off safety clearance	Refer to text
284-291	Brake Resistor Wattage for ACDC Drives 1-8	50
300-307	Drive assignment to Axes 1-8	Refer to text
308-315	Encoder assignment to Axes 1-8	Refer to text
323	MPU11 Encoder Speed Filter	0
324-331	Axis Boxcar size	0
332-335	Encoder error suppression	0
336-339	Motor torque estimation for velocity mode drives	Refer to text
340-347	Precision Mode delay (in milliseconds) for axes 1-8	0
348,351,354	MPG Encoder Input 1, 2, 3	15, 0, 0
349,352,355	MPG Detents per Revolution 1, 2, 3	100
350,353,356	MPG Encoder Counts per Revolution	400
357-364	Axis Drive Max RPM	0

Parameter	Definition	Default
365	Drive power-on delay	0.0
366	Probe deceleration multiplier	2.0
367	Tool Touch-off deceleration multiplier	2.0
374	ACDC Drive Debug Log Axis Inclusion	0
375	ACDC Drive Debug Log Size	0
376	ACDC Drive Debug Log Collection Type	0
377	ACDC Drive Debug Log Trigger Type	0
378	ACDC Drive Debug Log Trigger Level	0
379	ACDC Drive Debug Log Option	0
392-394	DP7 probe parameters	Refer to text
399	AD1 arc chord tolerance adjustment	.5
900-999	PLC program parameters	--

Parameter 0 – E-Stop PLC Bit

This parameter specifies the PLC bit to which the physical Emergency Stop switch is connected. It is mainly used for ATC applications that use custom PLC messages.

PLC Type	ESTOP Input on PLC	Parameter Value
GPIO4D	Input 11	11
ALLINONE	Input 11	11
OAK	Input 11	11
RTK2/3/4	Input 11	11
PLCIO2	Input 11	11
DC3IO	Input 11	11
Servo3IO	Input 1	1

Parameter 1 – Machine and Jog Key Orientation

This parameter controls the orientation of the jog keys and graphics. The default value is 0. When the default value is active, all graphical displays will depict tooling mounted from the back.

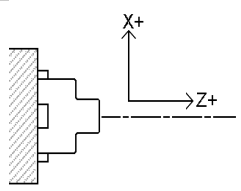
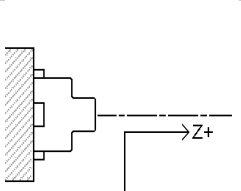
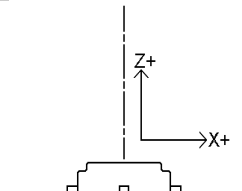
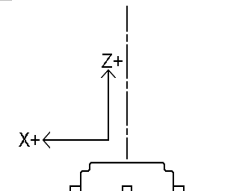
Machine Orientation				
	Horizontal	Horizontal	Vertical	Vertical
Tool mount location (if not using gang tooling)	Rear	Front	Right	Left
Parameter Value	P1 = 0	P1 = 1	P1 = 8	P1 = 9

If the X+ and X- jog key inputs need to be exchanged with each other to match the machine orientation, add 2 to one of the parameter values mentioned above. Also if the X jog keys need to be exchanged with the Z jog keys, add 4. For example, if you have a vertical lathe with tools mounted on the left, and the X jog keys are interchanged with the Z jog keys, and furthermore the X+/- jog key functions need to be flipped, then the value that needs to be entered into parameter 1 is $9+4+2 = 15$.

Parameter 2 – Dwell G-code Interpretation Control

This parameter is a bit field that controls optional interpretation of several G-codes. The following table shows the functions performed by the value entered in this parameter: Currently, only bit 2 is relevant for lathe operations, and all the other bits should be set to value = 0.

Bit	Function Description	Parameter Value
0	(Not used for Lathe)	Set to 0
1	(Not used for Lathe)	Set to 0
2	Interpret dwell time (P) associated with G4 as milliseconds rather than seconds	Yes = 4, No = 0
3	See M-series (Mill) manual for reference.	Recommended setting = 0
4	(Not used for Lathe)	Set to 0
5	See M-series (Mill) manual for reference.	Recommended setting = 0
6	Selects whether or not the default M30 will act like a default M2 (Restart Program). If set on, the default M30 will be equivalent to the default M2.	0

Parameter 3 - Modal Tool and Length Offset Control

Bit	Meaning	Parameter Value
0	Tool and Length Offset numbers will be reset upon job completion (and not remain modal and active between jobs).	Reset upon job completion = 1, Remain modal between jobs = 0
1	Unused for Lathe. This bit should be set to 0.	Should always be = 0
2	Tool Length Offset Retention option. This option prevents the current tool length offsets from being turned off when the user enters the Tool Length Offset menu. Additionally, this option will cause the current tool length offset number to be set to match the tool number when an Auto Tool Change is performed (via F7 ATC) in the Offset Library.	Yes = 4, No = 0

Parameter 4 - Remote File Loading Flag & Advanced File Ops

This parameter controls the action of the Load Job Screen when CNC job files are selected from drive letters higher than C. These drives (i.e. drives D, E, F, etc.) are presumed to be network drives or extra hard drives.

Value	Meaning
0	Job files are not copied or cached. They are run from whichever drives they reside on.
1	Job files are copied to the C drive (c:\cnc1\ncfiles) when they are loaded. The local copy is used when the job runs.
2	Turn on file caching. Job files are temporarily cached on the C drive. The cached copy is used while the job is running. The cached copy is deleted when the next job is loaded or when Parameter 4 changes to a 0 or 1.
4	Set the Advanced File load menu as default for loading files
8	Use Windows-style File Open dialogue

File caching is useful for machines with both a flash card and a hard drive. By caching job files from the hard drive on the flash card, the hard drive is not used while the job is running. As a result, the life of the hard drive is extended and the flash card does not fill up with job files.

Parameter 5 - Suppress Machine Home Setup

This parameter controls machine homing upon startup of the control. The following table details the functions controlled by this parameter:

Bit	Function Description	Parameter Value
0	Suppress the requirement to set machine home before running jobs?	Yes = 1, No = 0
1	(Unused)	----
2	Disable stall detection when CNC11 first starts.	Yes = 4, No = 0

Bit 0 suppresses the requirement to set machine home before running. If bit 0 of parameter 5 is 0, machine home must be set before jobs may be run. If bit 0 of parameter 5 is 1, machine home is not requested or required.

● NOTE: Parameter 5 Bit 0 is separate from the "Machine Home at Powerup" flag in the Control Configuration Menu. Parameter 5 Bit 0 determines **whether** you must home the machine; the "Machine Home at Powerup" flag determines **how** you will home the machine, if you must do so.

Parameter 6 - Automatic tool changer

This parameter tells the control whether you have an automatic tool changer installed on your machine. This field affects the action of the T codes in your CNC programs. It also affects whether the ATC key is present in the Tool Offset Setup.

Value	Meaning
0	Auto Tool Changer NOT Installed
1	Auto Tool Changer Installed

Parameter 7 - Display colors

This parameter determines what combination of colors will be used for display. If you have a color display, set this parameter to 0. If you have a monochrome display (especially a monochrome LCD panel) set this parameter to 1.

Parameter 8 - Installed coolant systems

This parameter is used by Intercon to determine what coolant systems are available on the machine. It should be set as follows:

Value	Meaning
1	Mist Coolant (M7) only
2	Both coolant systems
3	Flood Coolant (M8) only

Parameter 9 - Display language

This parameter determines what language will be used for menus, prompts and error messages.

Value	Meaning
0	English
1	Spanish
2	French
3	Traditional Chinese
4	Simplified Chinese
5	German
6	Swedish
7	Finnish
8	Portuguese
9	Greek

Parameter 10 - Macro M-function handling

This parameter is a 4-bit field that controls various aspects of M functions. The following table shows the functions performed by the value entered in this parameter. The default value is 0.

Bit	Function Description	Parameter Value
0	Display M & G codes in M function macros?	Yes = 1, No = 0
1	Step through M function macros in Block Mode?	Yes = 2, No = 0
2	Decelerate to stop on M105 and M106. With decel set these moves take longer and are slightly less accurate. With immediate stop these moves are faster and more accurate; however the lack of controlled deceleration can cause excessive machine vibration.	Decel = 4, Immediate Stop = 0
3	(not used on lathe)	set to 0
4	(not used) This bit was previously used for controlling the type of deceleration to stop on M115,M116,M125,M126 probing moves. This functionality is now controlled by parameter 366.	set to 0

Parameter 11 – Probe PLC Input Number and Contact State

This parameter is used for the PLC input number that is used by the probe device on M115/M116/M125/M126 probing moves. Allowable range is a single value, +/- 1 to 240 and 50001 to 51312. A Positive number indicates Closed on contact and a negative number indicates Open on contact.

NOTICE Changing this parameter can cause damage to your probe device. You should contact your Dealer or Local Tech Representative before any modifications are made.

Parameter 14 – Fast Probing Rate

The fast probing rate is used in initial surface detection moves done by Auto Tool Touch-off cycles, and is determined by the machines response time and the permitted probe deflection. The default is 10 in/min. This is a very conservative feedrate, in actual use 20 to 30 in/min is a good value and will not have any detrimental impact on accuracy in most cases.

Parameter 15 – Slow Probing Rate

The slow probing rate is used in the final measurement moves done by Auto Tool Touch-off cycles. The default setting is 1 in/min.

Parameter 16 – Maximum Probing Distance

This is the maximum distance that the probing moves (M115/M116/M125/M126 and Auto Tool Touch-off cycles) “search” for a surface in a given direction if no travel limits have been entered. The default setting is 10 inches.

Parameter 18 - PLC Input Spindle Inhibit Parameter

This parameter stores the input for the Spindle Inhibit feature. A negative value must be entered if a "normally closed" probe is to be used with the control. A positive value must be entered if a "normally open" probe is to be used with the control. The absolute value of Parameter 18 will directly reflect the PLC input the Spindle Inhibit is wired to. When this parameter is set, the Auto Tool Touch-off cycles will not run unless a Tool Touch-off device is connected.

Parameters 20-30 (also 132-135, 236-239) - Motor Temperature Estimation

These parameters are used for motor temperature estimation. Parameters 20, 29 and 30 correspond respectively to the ambient temperature of the shop, the overheating warning temperature, and the job cancellation temperature, all in degrees Fahrenheit. Parameters 21-24 and 132-135 are the heating coefficients. Parameters 25-28 and 236-239 are the cooling coefficients.

To disable Motor Temperature Estimation for an axis, set its heating and cooling coefficients to 0. For example, to disable Motor Temperature Estimation for axis 1, set Parameter 21 to 0, and set Parameter 25 to 0.

Note: Temperature estimation only applies to controls operating in Torque mode (i.e. DC brushed systems and Centroid AC systems). MPU11 systems running in Velocity mode (i.e. third party drive systems) do not use this feature, and thus should be disabled (by setting all heating and cooling coefficients to 0).

Suggested values for AC Brushless Motors and Drives						
SD Drive		SD3, SD1 750 W motors	SD3, SD1 1,2 KW motors	SD3, SD1 (finned heatsink) 1,2 KW motors	SD1 45A (finned heatsink) 3 KW motors	SD1 45A (finned heatsink) 4 KW motors
Parameters	Axes	Values	Values	Values	Values	Values
21-24	1-4	0.23	0.5	0.23	0.23	0.23
132-135	5-8	0.23	0.5	0.23	0.23	0.23
25-28	1-4	12.0	9.0	12.0	12.0	14.5
236-239	5-8	12.0	9.0	12.0	12.0	14.5
20	N/A	72	72	72	72	72
29	N/A	150	150	150	150	150
30	N/A	180	180	180	180	180

Suggested values for DC Brush Motors and Drives						
Servo Drive		9A Drive, 16 in/lb motors	12A Drive, 29 in/lb motors	15A Drive, 29 in/lb motors	15A Drive, 40 in/lb motors	25A Drive, 40 in/lb motors
Parameters	Axes	Values	Values	Values	Values	Values
21-24	1-4	0.028	0.02	0.027	0.03	0.04
132-135	5-8	0.028	0.02	0.027	0.03	0.04
25-28	1-4	0.68	0.68	0.68	0.68	0.68
236-239	5-8	0.68	0.68	0.68	0.68	0.68
20	N/A	72	72	72	72	72
29	N/A	150	150	150	150	150
30	N/A	180	180	180	180	180

Parameter 31 - Legacy SPIN232 Com Port

For values 1-255, CNC11 will attempt to open that COM port and send out spindle commands. CNC11 should be restarted after changing this value from 0 (disabled) to a valid value. Note that the baud rate is assumed to be 19200 to work specifically with a SPIN232.

Parameter 33 - Spindle Motor Gear Ratio

NOTICE The default value for this parameter is 1 and should not be changed unless you have consulted your dealer or local Technical representative!!!

Sets the gear or belt ratio between the spindle motor and the chuck in high gear range. Should be greater than 1.0 if the motor turns faster than the chuck and less than 1.0 if the chuck turns faster than the motor. Note: this value applies to high range. The ratio between high range and lower ranges is established by the gear ratio parameters (65-67).

Parameter 34 - Spindle Encoder Counts/Rev

This parameter controls the counts/revolution for the spindle encoder. The spindle encoder is required for spindle-slaved movements such as Threading, Feed-Per-Revolution moves, and Rigid Tapping, . If the encoder counts up when running CW (M3), the value of this parameter must be positive. If the encoder counts up when running CCW (M4), the value of this parameter must be negative.

Parameter 35 - Spindle Encoder Axis Number

Input from a spindle encoder is required for spindle-slaved movements such as Rigid Tapping, Threading, and Feed per Revolution movement. This parameter specifies the axis number (1 through 8) to which the spindle encoder is assigned. Encoder assignments are specified by parameters 308-315. For example, if you decide to configure the 5th axis as the spindle, and the spindle's encoder is the 1st MPU11 onboard input encoder, then Parameter 35 (this parameter) should be set to 5, and Parameter 312 should be set to 1.

Parameter 36 - Rigid Tapping Enable/Disable

This parameter is a bit field that enables or disables Rigid Tapping and its options.

Bit	Function Description	Parameter Value
0	Enable Rigid Tapping?	Yes = 1, No = 0
1	Suppress sending "Wait for Index Pulse" during Rigid Tapping?	Yes = 2, No = 0
2	Allow Spindle Override during Rigid Tapping?	Yes = 4, No = 0
3	Use Spindle Off system variable bit? (see note below)	Yes = 8, No = 0 (see note below)

Note on Bit 3: This bit enables the spindle off system variable, for mpu11 systems. Most systems will not need to set this bit. Mpu11 systems will not execute custom M5 macro commands during a rigid tap. Instead the software determines which bit, M3 or M4, to turn off to stop the spindle. Alternatively, setting bit 3 will cause the software to set the spindle off system variable bit, SV_PC_RIGID_TAP_SPINDLE_OFF. The plc program is then responsible for monitoring that bit and performing all actions in order to turn off the spindle.

Parameter 37 - Spindle Deceleration Time

This parameter is used in conjunction with parameter 36 when rigid tapping is enabled. This sets the amount of time required for the spindle to decelerate before it switches direction during a rigid tapping operation.

Parameter 38 - Multi-Axis Max Feedrate

This parameter is used to limit the feedrate along all feed-per-minute move vectors. This parameter can be used to limit the speed of multi-axis moves on machines that may have enough power to move a single axis rapidly, but starve out of power on 2 or 3 axis rapid moves. A zero in this parameter will disable this feature. Note that this feature has no effect for movement commands handled by Smoothing (P220=1).

Parameter 39 - Feedrate Override Percentage Limit

This parameter is used for limiting the upper end of the Feedrate Override Knob percentage to a value from 100% to 200%. This parameter can be used to restrict the Feedrate Override Knob effect on machines with maximum rates over 200 in/min. The Feedrate Override Knob percentage is normally allowed to go to 200%. However, on machines with high cutting speeds, if the knob is turned up to 200%, it creates overshoots on corners. If this parameter for example is set at 110, it will stop the Feedrate Override Knob from exceeding 110%, and thus cause the overshoots to disappear.

Parameter 40 - Basic Jog Increment

This parameter holds the basic jog increment for linear axes (0.0001" or 0.002 mm by default). This value works in conjunction with the x1, x10, and x100 jog keys to determine the amount to move a linear axis during incremental jogging.

Parameter 41 - Rotary Axis Jog Increment

This parameter holds the jog increment for rotary axes (0.01° by default). This value works in conjunction with the x1, x10, and x100 jog keys to determine the amount to move a rotary axis during incremental jogging.

Parameter 42 – Password for Configuration Menus

This parameter determines the password that the user must enter in order to gain supervisor access to the configuration menus.

Value	Meaning
54.0	No password required for supervisor access; the user is not prompted for a password
ABCD.ABCD	Password is 4 digits represented by "ABCD"
Any other number	Password is "137"

Parameter 43 - G71/G72 Depth of Cut

The depth of each successive cut along the Z-axis (for G71) or X-axis (for G72). The minimum value is 0.0001"; the maximum is 9999.9999"; the default is 0.01".

Parameter 44 - G71/G72 Escape Amount

The distance the cutter will move away from the just-cut surface before going back to start the next pass. The minimum value is 0; the maximum is 9999.9999"; the default is 0.

Parameter 45 - G74 X axis Relief Amount

Distance along the X axis that the cutter will move away from the surface before returning to the starting point at the end of a pass. This parameter is used only by Intercon Setup. This does not affect G74 operation.

Parameter 46 - G75 Z axis Relief Amount

Distance along the Z axis that the cutter will move away from the surface before returning to the starting point at the end of a pass. This parameter is used only by Intercon Setup. This does not affect G75 operation.

Parameter 47 - G73 Repeat Count

Number of passes to cut. The minimum value is 1; the maximum is 1000; the default is 1.

Parameter 49 - Thread Chamfer Amount

The length of the chamfer inserted at the end of threads cut with the G92 and G76 cycles, as a multiple of the thread lead. A value of 1.0 inserts a one-thread chamfer. The minimum value is 0; the maximum is 100; the default is 0. See Chapter 11 for more information on G92 and G76.

Parameter 50 - G76 Finish Count

Number of finish passes in the G76 cycle. All of the finish allowance is removed with the first finish pass; the remaining passes are spring passes over the same path. The minimum value is 1; the maximum is 99; the default is 1. See Chapter 11 for more information on G76.

Parameter 51 - G76 Thread Angle

Compound angle of the thread. The minimum value is 0; the maximum is 120; the default is 0. See Chapter 11 for more information on G76.

Parameter 52 - G76 Minimum Cutting Depth

In the G76 cycle, each successive pass has a smaller depth increment. This parameter sets the minimum depth increment. The minimum value is 0.0001"; the maximum is 999.9999"; the default is 0.0010". See Chapter 11 for more information on G76.

Parameter 53 - G76 Finish Allowance

Finish allowance left after the depth passes, to be removed by the first finish pass. The minimum is 0.0001"; the maximum is 9999.9999"; the default is 0.0100". See Chapter 11 for more information on G76.

Parameter 55 - Radius / Diameter mode

Value	Meaning
0	Diameter mode X axis positions in G-code and DRO X positions are diameter width values whose center is X0. U (incremental X) positions in G-code and X axis tool offsets are diameter difference values. Commanding X in diameter mode causes actual movement that is half of the specified X value. However, I (incremental X arc center) in G2/G3 is always a radius value, despite this parameter.
1	Radius mode G-code I, X, U, DRO X positions, and X tool offsets are specified in terms of radius. Commanding X in radius mode causes actual movement that is equal to the specified X value.

Parameter 56 – Feedrate Override Display Properties

This parameter is a 3-bit field that is used to define how the feedrate override is displayed in the status window.

Bit	Function	Parameter Value
0	Not used	
1	Display programmed rate not actual	Yes = 2; No = 0
2	Display a bar meter of percentage	Yes = 4; No = 0

Parameters 57 – Use Generic Load Meter Data from PLC

If load meters are enabled (via parameter 143) the data being displayed for each axis is normally calculated from its PID output (either real or simulated). However, if any axis has its corresponding bit set in this parameter, then the data going into the load meter will come from the PLC system variables SV_METER_1 - SV_METER_8 (corresponding to axes 1-8). Furthermore, if an axis is a spindle axis (as set by parameter 35) the load meter data will be displayed on the spindle override meter in the Status Window.

Cooperation from the PLC program is required for this feature to work. The PLC program needs to send back a value between 0.0 and 100.0 via floating point system variables SV_METER_1 - SV_METER_8 (corresponding to axes 1-8). Note that there is future support for SV_METER_9 up to SV_METER_16, but for now there is support for up to only 8 axes.

Parameter 58 – G71/G72 Profile Rough Cut Escape Angle

Each incremental pass in the rough cut portion of the G71 and G72 cycles ends with an angled feed move away from the material. This parameter sets the default angle of this angled feed move. (However, if the G71/G72 cycle is specified with an A, the A value will override this parameter.)

Parameters 61-62 - Stall detection parameters

The T-Series control will detect and report several stall conditions. The low power stall occurs if the control has been applying a specified minimum current for a specified time, and no encoder motion has been detected. This may indicate a loose or severed encoder cable. A high power stall occurs if the control has been applying at least 90% current for a specified time, and no motion greater than 0.0005" has been detected. This may indicate a physical obstruction. Note that this feature will only work with torque mode drives and not velocity mode drives.

Parameter 61 is the time limit, in seconds, for a high power stall. The default is 0.5 seconds.

Parameter 62 is the PID output threshold for a high power stall. The default is 115.

Parameter 63 - High Power Idle PID Multiplier

This parameter holds the value of a constant used for motor high power idle detection when an axis is not moving and no job is running, but there is power going into the motor to maintain its position. The default value is 1.5. This is intended for early detection of an axis if it's stopped against some abnormal resistance or not tuned correctly, such that it will probably overheat later.

Parameter 64 – Fourth/Fifth Axis Pairing

This feature enables the 4th and 5th axes to be paired together or individually be run in a slaved state with any of the other axes. This is intended to drive 2 screws on opposite sides of a table or gantry system. Set this parameter to 0 (default) to indicate that no other axis is paired with the 4th or 5th axis. In order to pair both the 4th and 5th axes on the same system add the 4th axis value with the 5th axis value. Example: 4th axis paired with the Z-axis and 5th axis paired with the 3rd axis a value of 49 would be entered into parameter 64. The axes are slaved upon power up but it is still possible to move the paired (4th or 5th) axis independently if the axis is labeled.

*** NOTE: You cannot run Autotune on paired axes.**

Value	Meaning
0	No Pairing (Default)
1	Pair 4 th axis with Z Axis
2	Pair 4 th axis with X Axis
3	Pair 4 th axis with 3rd Axis
16	Pair 5 th axis with Z Axis
32	Pair 5 th axis with X Axis
48	Pair 5 th axis with 3rd Axis
64	Pair 5 th axis with 4th Axis

Parameters 65-67 - Spindle gear ratios

These parameters tell the control the gear ratios for a multi-range spindle drive. Up to four speed ranges are supported; high range is the default. Parameters 65-67 specify the gear ratio for each lower range, relative to high range. For example, if the machine is a lathe with a dual range spindle, and the spindle in low range turns 1/10 the speed it turns in high range, then parameter 65 should be set to 0.1. Note that these values can be signed +/- . So, if switching from high range to a lower range causes the spindle encoder to count in the opposite direction, then a negative value can be used to compensate for this.

Parameter 65 is the low range gear ratio. The default is 1.

Parameter 66 is the medium-low range gear ratio. The default is 1.

Parameter 67 is the medium-high range gear ratio. The default is 1.

These parameters work in conjunction with the PLC program, which uses the states of INP63 and INP64 to signal to the CNC software which range is in effect, according to the table below.

PLC INPUT	Spindle Range			
	High Range	Medium High Range	Medium Low Range	Low Range
INP63	0	1	1	0
INP64	0	0	1	1

Parameter 68 – Minimum Spindle Speed (Rigid Tapping Parameter)

This parameter holds the value that the spindle slows down to from the programmed spindle speed towards the end of the tapping cycle. The lower the value, the more accurately the Z axis will land on target, but at the expense of possibly stalling the spindle motor which in turn will cause Z to stop short. If this value is too large, the off target error will increase. The suggested starting value is 640 rpm.

Parameter 69 – Duration for Minimum Spindle Speed Mode (Rigid Tapping Parameter)

This is the duration of time, in seconds, that the control will stay at minimum spindle speed. If the number is too small, overshoot may occur. If the number is too large, the user waits longer for the hole to be tapped at the slow speed specified by parameter 68. The suggested starting value is 1.25 seconds.

Parameter 70 - Offset Library Inc/Decrement Amount

Sets the increment and decrement amount used in the offset library.

Parameter 72 – Data M Function Options

The setting of this parameter affects the operation of the data M functions M122, M123, and M124.

Bit	Function Description	Parameter Value
0	Suppress output of axis labels by M122/M124?	Yes = 1, No = 0
1	Insert commas between positions/values with M122/M124?	Yes = 2, No = 0
2	Suppress spaces between positions/values outputted by M122/M123/M124?	Yes = 4, No = 0

Parameter 73 - Peck Retract Amount

This parameter sets the peck retract amount associated with G74 and G75. The minimum value is 0; the maximum value is 9999.9999"; the default value is 0.0500". See Chapter 11 for more information on G74 and G75.

Parameter 74 – M-function executed at tap depth (Canned Cycle Parameter)

This specifies the number of the M-function that is executed at the bottom of the Tap cycle (primarily used for reversing the spindle in preparation for pulling out of the tap hole). This also specifies the number of the M-function that is executed after the Counter Tap cycle is done (returned to the initial point). Both Tap and Counter Tap cycles are performed by G84 (see G84 in Chapter 11).

Parameter 78 – Spindle Speed Display and Operations

Bit 0 (value = 1) specifies how the spindle speed is determined and displayed in the CNC software status window. When turned on (value = 1), the spindle speed is determined by reading the encoder feedback from the axis specified according to parameter 35. Which has the number of encoder counts/revolution specified in parameter 34. When turned off (value = 0), the displayed speed is not measured; the speed is calculated based upon the programmed speed, spindle override adjustment, and gear range.

Bit 1 (value = 2) allows the control to prorate the programmed feedrate to be proportional to the spindle speed if the spindle speed ever slows down below the spindle speed threshold percent as set by parameter 149.

Bit 2 (value = 4) will turn on the “Spindle up-to-speed” function. The active modal spindle speed S at the point where the most recent M3 or M4 is invoked sets the target spindle speed for this function. This function is invoked on the first feed-per-minute move (such as G98 G1/G2/G3) following the aforementioned M3 or M4. If the actual measured spindle speed at this moment is below the spindle speed threshold percent (parameter 149) of target spindle speed, this function will pause the job at this point until the spindle speed gets up to at least this spindle speed threshold percent level.

Bit	Function	Value
0	Display actual spindle speed	Yes = 1, No = 0
1	Slave feed rate to programmed spindle speed	Yes = 2, No = 0
2	Wait for spindle to get up to speed on feed-per-minute moves	Yes = 4, No = 0

Parameter 80 – Voltage Brake Message Frequency

This parameter specifies the number of time the “450 Voltage brake applied message has to occur before we show it in the message window and message log. A value of 0 or 1 will display the message for every instance that it occurs.

Parameter 82 – Spindle Drift Adjustment (Rigid Tapping Parameter)

This value is the number of degrees that the spindle will take to coast to a stop if it is cut off while it is spinning at the spindle speed specified by parameter 68.

Parameter 83 – Deep Hole clearance amount (Canned Cycle Parameter)

Parameter 83 specifies the clearance amount used during a G83 deep hole drilling cycle.

Parameter 84 – M function executed at return to initial point of tapping cycle (Canned Cycle Parameter)

This specifies the number of the M-function that is executed after the Tap Cycle is done (returned to the initial point). This also specifies the number of the M-function that is executed at the bottom of the Counter Tap cycle (to reverse the spindle in preparation for pulling out of the countertap hole). Both Tap and Counter Tap cycles are performed by G84 (see G84 in Chapter 11).

Parameter 85 – “Door Open” Interlock PLC bit

This parameter provides a way for a system integrator to implement a safety interlock that limits rate of movement when the doors are open. This parameter specifies the PLC bit number and PLC bit polarity that indicates the “door open” condition. If the specified PLC bit is in the specified “door open” condition, then all rapids and non-Smoothing feed-per-minute movement will be limited to the slow jog rate (as specified in the Jog Parameters menu in Machine Configuration). Polarity of the “door open” condition is specified thuswise: a positive number indicates that the “door open” condition occurs when the specified PLC bit is On, and a negative number indicates that the “door open” condition occurs when the specified PLC bit is Off. Note that this parameter does not affect the spindle speed, and also does not affect threading speeds nor feed-per-revolution moves. Furthermore, this feature has no effect on feed-per-minute movement handled by Smoothing (P220=1). If this parameter is set to 0 (the default value), then this feature is disabled, and no checking for a “door open” condition is done, and consequently all movement commands will run at their normal programmed feedrates.

Parameter 86 – Rapid/Linear vector rate limit

This parameter controls the feature that imposes a limit on the number of rapid and/or feed-per-minute linear moves allowed each second. If the value of this parameter is more than 0, Rapid and/or Linear moves will be combined to prevent the aforementioned limit from being exceeded. This parameter is used for testing purposes and should be set to 0 to disable this feature. Note that this feature has no effect for movement commands handled by Smoothing (P220=1).

Parameters 87-90 (and also 252-255) - Autotune Ka Performance parameters

These parameters are used by autotune. Increasing the value will increase the Ka used by autotune which when used will increase the PID used during acceleration. The default value is 0. The maximum value is 50 and the minimum value is 0. Values for axes 1-4 are specified in parameters 87-90. Values for axes 5-8 are specified in parameters 252-255.

Parameters 91-94 (and also 166-169) – Axis Properties

These parameters may be used to set various axis properties. Properties for axes 1-4 are specified in parameters 91-94. Properties for axes 5-8 are specified in parameters 166-169.

Bit	Function Description	Parameter Value
0	Rotary/Linear Axis Selection	Rotary Axis= 1, Linear Axis= 0
1	Rotary Display Mode	Wrap Around = 2, Show Rotations = 0
2	NOT USED ON LATHE	Recommended bit value is 0
3	Suppress park function?	Don't Park = 8, Park = 0
4	C Axis Selection	C Axis = 16, Off = 0
5	Linear Display of Rotary Axis	Linear Display = 32, Default Rotary = 0
6	NOT USED ON LATHE	Recommended bit value is 0
7	For C axis prevent divide of counts per revolution by 360	Prevent Divide by 360 = 128 Divide by 360 = 0
8	NOT USED ON LATHE	Recommended bit value is 0
9	Hide axis from DRO display	Yes = 512, No = 0
10	NOT USED ON LATHE	Recommended bit value is 0

Bit 0: Turning this bit on will cause the DRO display for the affected axis to be displayed in degrees. Also this information is used by Intercon to make rotary axis support available (by setting parameter 94 to 1, indicating that the fourth axis is rotary). This bit is also used when performing inch/mm conversions: values for a rotary axis will not be converted since they are assumed to be in degrees regardless of the system of linear units.

Bit 1: This bit has no effect unless Bit 0 (mentioned above) is turned on. When this bit is turned on, a “Wrap Around” display is shown on the DRO. A “Wrap Around” Rotary Display is a display in degrees without the number of rotations shown. If this bit is turned off, the number of rotations away from 0 degrees will be shown alongside the degree display.

Bit 3: Setting this bit prevents <F1> (Park) in the Shutdown menu from parking this axis.

Bit 4: Setting this bit enables C axis control capability. The corresponding label field in the Machine Configuration should also be set to a “C”.

Bit 5: This setting overrides only the DRO display options for an axis that has bit 0 set (including the Rotary Display Mode – bit 1) so that the display does not reflect a degree symbol or any indication of the number of rotations, but appears as a linear axis.

Bit 7: By default, an axis configured as a C axis will have its counts per revolution divided by 360 before being used internally by the CNC software to provide more precise positioning for the C axis. Turning this bit on will prevent this behavior.

Bit 9: This setting will hide the affected axis from the DRO display. Note that this does not prevent such an axis from being commanded to move.

Parameters 95-98 (and also 156-159) - Autotune Move Distance / Auto Delay Calculation Move Distance

These parameters hold the maximum distance that the control will move each axis in either direction from the starting point when either Autotune or Auto Delay Calculation is run. The default value for these parameters is 2.0 inches. Values for axes 1-4 are specified in parameters 95-98. Values for axes 5-8 are specified in parameters 156-159.

Parameter 99 – Cutter Diameter Compensation Look-ahead

This parameter sets the default number of line or arc events for the G-code interpreter to scan ahead when cutter diameter compensation (G41 or G42) is active. Values of 1 to 10 are allowed for this parameter.

Parameters 100-109, 111-116 – Intercon parameters

These parameters are some of the Intercon setup parameters. See Chapter 8 for more information about these parameters. Changing values will change Intercon settings and may affect the output of the G-code program if it is re-posted.

Parameters 132-135 – Motor Heating Coefficients for axes 5-8

See parameters 20-30 for more information.

Parameters 137 – Load Meter Filter Size

This controls the number of samples used in calculating an average output for the load meter display, as a way of smoothing it out.

Parameters 138 – DRO Encoder Deadband

This controls the deadband amount (in encoder counts) used by the anti-flicker DRO filter.

Parameter 140 – Message log priority level

This parameter controls the messages that are written to the message log, which can be accessed through the **F9 - Logs** function in the Utilities menu. See Chapter 15 for the list of numbered messages. Message logging can be disabled by setting this parameter to -1. The recommended log level is 4.

Value	Which numbered messages are logged
-1	None
1	Numbered messages 0-299 and 400-499 – The most serious faults.
4	Numbered messages 0-299 and 400 and higher – The most serious faults and medium severity errors.
9	All numbered messages.

Parameter 141 – Maximum message log lines

This parameter is the number of lines that will be kept in the message log. If this parameter is set to 10,000, for example, the newest 10,000 messages will be retained. CNC11 will delete the oldest messages, trimming the log file to the given number of lines at startup and periodically while CNC11 is in an idle state. Parameter 142 controls the frequency of the log cleanup.

Parameter 142 – Message log trim amount

This parameter is the number of additional lines above the minimum that can be added to the log before it is reduced to the minimum size. Setting this parameter to a lower value will cause the log file to be trimmed to its minimum size more often. The higher the value, the less often the log will be trimmed. The speed of the disk drive and total size of the log file at the time it is trimmed will determine how long the log cleanup takes. Under most circumstances, using 10,000 and 1,000 for parameters 141 and 142 will provide a reasonable and useful log size with no noticeable effects on performance. If parameters 141 and 142 are set to excessively high values, the message "Trimming excess lines from log file" will be presented. This message will appear at startup and very infrequently when CNC11 is idle. Normal operation can proceed after the message disappears. If the delay is unacceptable, reduce the values of parameters 141 and 142.

Parameter 143 – DRO Properties (load meters, 4/5 digits, Distance To Go)

This parameter controls the display of the axis load meters and 4/5 digits DRO precision.

Bit	Function Description	Parameter Value
0	Enable Load Meters	Enable = 1, Disable = 0
1	Load Meter Outline	Enable = 2, Disable = 0
2	DRO 4/5 Digit Precision	5 digits = 4, 4 digits = 0
3	Mini DRO (Distance to Go)	Enable = 8, Disable = 0

Add the values of the desired properties. For example, use a value of 3 to display load meters with outlines. The value 11 will display load meters, outlines and the mini-DRO. The axis load meters will be colored green for values that are up to 70% of maximum power output, yellow for values between 70% and 90%, and red for values between 90% and 100%. The axis load meters appear below the DRO for each axis (see Chapter 1).

Parameter 144 – Comparison Rounding

This parameter determines the built in rounding for the comparison operators ('EQ', 'NE', 'LT', 'GT', etc.) in expressions. Rounding of comparison arguments is necessary due to extremely small errors that are part of every floating-point calculation. The result of such errors is that two floating-point values are rarely exactly equal. The value of parameter 144 represents the precision of comparison in places after the decimal point. If the parameter is set to 9.0, for example, then comparison operators will declare two numbers that differ in value by less than 0.000000005 as being equal. The value 0.0 is a special value that turns comparison rounding off. When comparison rounding is off, it is up to the G code programmer to build the precision into conditional statements, for example "IF ABS[#A - #B] LT 0.00005 THEN GOTO 100". When comparison rounding is off, the "EQ" usually returns "false". If parameter 144 is set to 9, the programmer can shorten the previous example to "IF #A EQ #B THEN GOTO 100".

Parameter 145 – Advanced Macro Properties (Fast Branching)

This parameter turns fast branching on (1) and off (0). The other bits of this parameter are reserved for future use. If fast branching is disabled, CNC11 searches forward in the program for the first matching block number and resumes searching, if necessary, from the top of the program. For this reason, backward branches take longer than forward branches and backward branch times depend on the total program size. If the program is sufficiently large, use of the GOTO statement could introduce temporary pauses.

When fast branching is enabled, CNC11 remembers the locations of block numbers as it finds them during program execution. Backward branches always take place immediately. The first forward branch to a block not yet encountered will take additional time as CNC11 searches forward for the block number; however, subsequent forward branches to that block number will take place immediately. The trade-off for using fast branching is that all line numbers at a given level of program or subprogram must be unique and programs will use more memory (approximately 16 kilobytes of memory for every 1000 block numbers in the program.)

Parameter 146 – Feed Hold Threshold for Feed Rate Override

This parameter sets the lowest value permitted as the feed rate override percentage before feed hold is engaged. Feed hold will be released when the override percentage is greater than this value.

Parameter 147 – Number of Status Messages to keep in Operator Message Window

The Operator Message Window is the box of scrolling status messages that appears in the upper right corner of the Main Screen. The number of remembered status messages can be adjusted by this parameter.

Parameter 148 – Miscellaneous Jogging Options

This parameter enables and/or disables certain optional modes of jogging.

Bit	Function Description	Parameter Value
0	Unused	Should be set to 0
1	Prohibit Keyboard Jogging	Prohibit Keyboard Jogging = 2 Keyboard Jogging allowed = 0

Note: With this parameter set to zero, you need to set parameter 170 to enable keyboard jogging.

Parameter 149 – Spindle Speed Threshold

This parameter defines the spindle speed threshold percent for the “Slave feedrate to spindle speed” function and the “Spindle up-to-speed” function, both of which are enabled and disabled via Parameter 78. It is specified as a percentage of the programmed spindle speed. For example a value of 0.8 means 80 percent of the programmed spindle speed. See Parameter 78 for more details.

Parameter 154 – Touchscreen Options

If = 1 a half-width ESC key is displayed in most menus so there is a means of exiting the menu without using the keyboard. Most of the menus have been reworked to more fully support touch.

Parameter 150 – Backplot Graphics display options

This parameter controls the various options related to backplot graphics.

Bit	Function Description	Parameter Value
0	Sets Run Time Graphics option default to ON	Enable = 1, Disable = 0
4	Display Lash/Screw Compensation	Enable = 16, Disable = 0

Parameter 155 – Probe Device Type

This parameter specifies the type of probe being used.

Value	Meaning
0	Standard Mechanical probe
1	DSP probe
2	DP-7 probe

Parameters 156-159 – Autotune Move Distance / Auto Delay Calculation Move Distance for axes 5-8

See parameters 95 – 98 for more information.

Parameter 163 – Gang Tooling

This parameter enables the tool library to select front mount or back mount tool approach for gang tooling. If set to 1 you can measure both front mount and back mount tooling.

Parameters 165 – Acceleration/Deceleration Options

This is a bit field parameter which modifies certain details of axis acceleration and deceleration when an axis stops moving, changes direction, or starts moving. The Jog Parameters screen in the Machine Configuration set the original DeadStart values for each axis. This parameter allows you to modify these DeadStart settings under certain conditions. Note that if both Bits 0 and 1 are turned on (value = 1+2 = 3), the effect is cumulative, i.e. the net effect will be that ½ DeadStart value will be used when a slave axis stops or starts up from a stop. Likewise, if both Bits 2 and 3 are turned on, the effect will be cumulative also. Note that this feature has no effect for movement commands handled by Smoothing (P220=1).

Bit	Function Description	Parameter Value
0	Use ¼ DeadStart value for a slave axis that stops or starts from a stop	Enable = 1, Disable = 0
1	Use 2 x DeadStart value for a slave axis that stops or starts from a stop	Enable = 2, Disable = 0
2	Use ¼ DeadStart value for a slave axis that reverses	Enable = 4, Disable = 0
3	Use 2 x DeadStart value for a slave axis that reverses	Enable = 8, Disable = 0
4	Limit the feedrate along the path of G2 or G3 arc moves such that the feedrate will be uniformly limited to the lesser of the maximum rate of the 2 axes involved in the circular motion.	Enable = 16, Disable = 0

Parameters 166-169 – Axis Properties for axes 5-8

See parameters 91-94 for more information.

Parameters 170-179 – PLC Parameters

These parameters are especially reserved as a space for data which is to be sent to the PLC. Parameters 177, 178, 179 have been standardized for specific applications. Parameter 177 is used for trouble shooting purposes only.

Parameters 170 – Enable Keyboard Jogging and set Feedrate over ride Control

This PLC parameter is used to enable keyboard jogging and determine whether jog panel or keyboard feedrate over ride is used. To enable keyboard jogging set parameter 148 to zero and this parameter to a 1.

Bit	Function	Parameter Value
0	Enables Keyboard jogging	Enable = 1, Disable = 0
1	Only looks at Feedrate over ride from Jog panel	Enable = 2, Disable = 0
2	Only looks at Feedrate over ride from keyboard	Enable = 4, Disable = 0

Parameter 178 – PLC I/O configuration

This parameter can be used to set switch types from NC to NO and some other options. Each Bit corresponds to a different function. All values are to be added to the current setting. For example, if you need to switch low lube to normally open add 1 to this parameter. **NOTE:** This parameter works only with specific PLC programs. The PLC program installed in the control MAY NOT be mapped as indicated below. These parameters should only be changed by a qualified factory technician. The example given below is intended for reference only:

Bit	Function	Default state	Opposite State
0	Lube Fault	Closed = OK	Add 1
1	Spindle Fault	Closed = Fault	Add 2

179 – Lube Pump Operation

This parameter can be configured to control a variety of lube pumps. The value is formatted as MMMSS, MMM for minutes and SS for seconds. Below is a table of some examples.

Type of Pump	MMM	SS	Operation
Mechanical/CAM	0	0	179=0 Power is on when machine is running a job or in MDI Mode
Electronic “lube first”	16	00	179=1600 Holds power on to the pump for 16 minutes of job or MDI time
Electronic “lube last”	16	00	179=1600 Holds power on to the pump for 16 minutes of job or MDI time
Direct Controlled Pump	30	15	179=3015 Waits for 30 min of job or MDI time, then applies power for 15 seconds.

Parameters 187 – Hard Stop Homing

This parameter is used when homing off hard stops. The value set in this parameter determines the amount of current sent to the motor while homing. Value range is 0-32000; typical value for a DC system is 16000. Note that this feature does not work with velocity mode drives.

Parameters 188-199 – Aux Key Functions

These parameters are used to assign a function to aux keys 1-12 (i.e. P188 = Aux1 ... P199 = Aux12). The following is the list of possible functions that can be executed when an aux key is pressed.

Function	Parameter Value
No Function	0
Input Z Axis Position	1
Input X Axis Position	2
Input 3rd Axis Position	3
Set Absolute Zero	4
Set Incremental Zero	5
Execute M Code file	m11*
Free Axes	14

Function	Parameter Value
Go to Power Feed Menu	15
X, Z, 3rd Set Absolute Zero	16
One Shot – Chamfer	56
One Shot – Turning	57
One Shot – Facing	58
One Shot – Radius	59
One Shot – Drill	60

For example, if you wanted Aux4 to call up the “One Shot - Turning” , you would set parameter 191 to 57.

The Input Axis Position functions must be used with the Set ABS/INC Zero functions. After entering the desired value at the input field provided by the Input Axis Position function, press an aux key assigned either the function Set ABS Zero or Set INC Zero.

* *m* is the number of the M code to execute. For example, if the parameter value is set to 7211, the file mfunc72.mac will be loaded and executed when the Aux key was pressed.

Custom overlays with the keys that represent these functions are available; contact your dealer for pricing.

Parameters 200-207– OPTIC 4 Tach Volts Per 1000 RPM

These parameters control the digital Tach output on the Optic4 boards. They are used on drives like old Fanuc velocity mode drives that require a tach input. The value put here is the volts/1000 RPM off of the motor. A negative value can be entered to invert the tach voltage compared to the encoder count derived velocity direction from the encoder.

Parameters 208-215 MPU-based Lash/Screw Compensation Acceleration Coefficient

These parameters control the speed of the Lash and/or Screw Compensation for axes 1-8. The lash will be taken up with acceleration equal to the coefficient multiplied by the acceleration rate for the axis. A value of zero would effectively disable MPU-based Lash and/or MPU-based Screw Compensation.

*NOTE: These coefficients are not used by PC-Based Lash nor PC-based Screw Compensation

Parameters 216 PC Based Lash Compensation on/off

This parameter controls which Lash Compensation Algorithm to use. The default value of 0 is recommended because it allows lash compensation to occur during any kind of motion. If PC Based lash is used then only during an MDI or programmed move (but not during jogging) will lash compensation be applied.

Function	Value
Use MPU-Based Lash Compensation	0
Use PC-Based Lash Compensation	1

*NOTE: Lash/Screw Compensation Acceleration Coefficients (parameters 208-215) are not used by PC-Based Lash Compensation.

Parameters 217 PC Based Screw Compensation on/off

This parameter controls which Screw Compensation Algorithm to use. The default value of 0 is recommended because it allows screw compensation to occur during any kind of motion. If PC-Based scw compensation is used then only during an MDI or programmed move (but not during jogging) will screw compensation be applied.

Function	Value
Use MPU-Based Screw Compensation	0
Use PC-Based Screw Compensation	1

*NOTE: Lash/Screw Compensation Acceleration Coefficients (parameters 208-215) are not used by PC-Based Screw Compensation.

Parameters 220-231 – Smoothing Configuration of Feed Per Minute moves

These parameters are used control the behavior of the Smoothing feature. In particular, parameter 220 turns Smoothing on or off. Note that Smoothing only works for feed-per-minute moves.

Parameter	Description	Recommended values	
220	Turn the Smoothing feature ON or OFF .	0 (Smoothing OFF / Exact Stop mode ON)	
221	NBpts: The number of points in the smoothing filter. The higher this value, the more rounded corners will become (see tolerance below)	5 to 10	
222	STEP: Smoothing breaks up a G code program into segments of this vector size. Use this rule of thumb: Tolerance = (Nbpts*STEP)/2.	.001 inch / .025mm	
223	Umax: Sustained safe throughput rate going to the MPU11 card.	800	
224	Centripetal control options: This bitfield parameter controls the Centripetal stage of the Smoothing module. Value 0 (default) makes Centripetal operate on all axes and disables excessive axis accel checking. Values 1 and 3 (bit 0 = 1) limits Centripetal to operate on only linear axes. Values 2 and 3 (bit 1 = 1) enables excessive axis accel checking	0 (Centripetal stage will operate on all axes and disables excessive axis accel checking.)	
226	W: Feature Width over which the Min Angle is determined.	10	
227	Min Angle: Minimum angle to smooth in degrees. Settings of 95 to 100 degrees will come to a near stop and produce sharp right angles. 60 to 85 will move continuously while rounding angles.	For Sharp corners 95 to 100 degrees	For rounded corners 60 to 85 degrees
228	S curve: Produces extra gentle stops, starts and feedrate changes, but increases job run time and may appear to pause at corners.	0 =Off completely 1 = On completely Range 0.0 to 1.0	
229	Backplot/Smoothing mode : This parameter is not used on Lathe controls.	0	
230	Curve Feedrate Multiplier: Reducing this value below 1.0 will cause the machine to move slower around curves and corners, minimizing "bangs" and overshoots. Increasing this value above 1.0 may allow you to run your machine faster if the feedrates in arcs and corners are still satisfactory.	1.0 (default value) 0.1 to 5.0 (Depending on user's preference for speed vs "bangs" and overshoots)	
231	Acceleration Multiplier: This parameter allows you to adjust the overall acceleration / deceleration rate as a means to reduce machine vibration, and noise during starting, stopping and feedrate changes. Reducing this value below 1.0 will cause more gentle accelerations and decelerations. Increasing this value above 1.0 will cause faster accelerations / decelerations.	1.0 (default value) 0.5 to 1.5 (Depending on user's preference for quickness of accelerations / decelerations)	

Parameters 236-239 – Motor Cooling Coefficients for axes 5-8

See parameters 20-30 for more information.

Parameter 240 – Rigid Tapping Accel Rate Distance

Default is .1

Parameter 241 – Rigid Tapping Rotational Step Size (Degrees)

Default is 10

Parameter 242 - Minimum Angle Threshold for application of Accel/decel in Threading moves

Default = 30

Parameter 243 – Threading Control

Bit 1 (value 2) suppresses wait for index pulse, Bit 2 (value 4) permits spindle override during threading.

Parameters 244 – Tool Touch-off device PLC input number

This parameter is the input number that the Tool Touch-off device is wired into on the PLC.

Parameters 245 – G71,G72,G74,G75,G76 D/P/Q “implied float” re-interpretation threshold for Inch units

Parameters 246 – G71,G72,G74,G75,G76 D/P/Q “implied float” re-interpretation threshold for MM units

Parameters 245 and 246 are used to resolve the ambiguities that arise due to the fact that the G71, G72, G74, G75 and G76 cycles can accept “implied floating point” forms of their D/P/Q parameters (which are specified as whole numbers). These G-codes follow the following criteria as to when to re-interpret and when not to re-interpret their D/P/Q parameters.

Assuming that a D/P/Q is a length dimension parameter of a G71, G72, G74, G75 or G76 cycle, the following table shows what happens to D/P/Q values after the re-interpretation process.

D/P/Q value characteristics	Examples	What happens in Inch mode (G20)	What happens in MM mode (G21)
Decimal point “.” is present in the D/P/Q parameter.	D01.23 P4.56 Q789.	D/P/Q values are left alone as-is because these are obviously already floating point numbers.	D/P/Q values are left alone as-is because these are obviously already floating point numbers.
D/P/Q value is a whole number beginning with a leading 0.	P0010 Q023	D/P/Q values are treated as implied floating point values with the decimal point <u>4</u> places in from the right. Effective re-interpretation using the examples would be: P0.0010 and Q0.0023	D/P/Q values are treated as implied floating point values with the decimal point <u>3</u> places in from the right. Effective re-interpretation using the examples would be: P0.010 and Q0.023
D/P/Q value is a whole number with no leading 0.	P50 Q500	If D/P/Q value is less than or equal to <u>parameter 245</u> , then the value will be left alone. If D/P/Q value is more than <u>parameter 245</u> then such a D/P/Q value will be treated as an implied floating point value with the decimal point <u>4</u> places in from the right. Assuming <u>parameter 245</u> is set at its default value of 99.0, the effective re-interpretation of the examples would be: P50 (left as is) and Q0.0500	If D/P/Q value is less than or equal to <u>parameter 246</u> , then the value will be left alone. If D/P/Q value is more than <u>parameter 246</u> then such a D/P/Q value will be treated as an implied floating point value with the decimal point <u>3</u> places in from the right. Assuming <u>parameter 246</u> is set at its default value of 99.0, the effective re-interpretation of the examples would be: P50 (left as is) and Q0.500

A summarized way of understanding the above table is:

- The criteria only applies only if D/P/Q is a length/width parameter of a G71, G72, G74, G75 or G76 cycle.
- If a decimal point is present on the D/P/Q value, then this will prevent re-interpretation because the specified numbers are already floating point.
- If the D/P/Q value is a whole number, then adding a leading 0 will force it to be re-interpreted as an implied floating point value.

- If the D/P/Q value is a whole number with no leading 0, then it will be subject to the parameter 245/246 thresholds.

Note that this special re-interpretation of D,P,Q length parameters only happens for G71,G72,G74,G75 and G76. All other letter addresses are not affected and D,P,Q parameters used in other situations outside of G71,G72,G74,G75,G76 are not affected either.

Parameters 247 – G70 Multiple Pass Behavior Suppression

This parameter adjusts the behavior of the G70 Finishing Cycle. Setting this parameter to 1 puts G70 into “industry standard behavior” mode. In this mode, a single G70 cycle will do only a single pass on the specified profile at specified offsets U and W. Setting this parameter to 0 puts G70 into multi-pass compatibility mode where U and W divides up the finish allowance purposely left behind by the G71 G72 or G73 “roughing” cycles. In this mode, multiple finish cut passes will be run (one pass for each progressively deeper division) until the final finish offset is reached. See G70 in Chapter 11 for more information.

Parameters 248 – Tool Wear Adjustment magnitude limit

This parameter sets the +/- value limit allowed to be entered into the Tool Wear Adjustment menu.

Parameters 252-255 – Autotune Ka Performance parameters for axes 5-8

See parameters 87-90 for more information.

Parameters 256 – Drive mode

This parameter indicates to the control software what mode the drives are operating under. It also controls the availability and behavior of the F5 Tune key in the PID Menu based on the drive mode.

Drive mode	Value
Torque mode. Autotune feature is enabled, accessible via F5 in PID Menu	0
Velocity mode. Autotune feature is disabled. Autotune does not work with velocity mode drives and therefore this parameter should be set to 1 to prevent access to Autotune on such machines with these drives.	1
Precision mode. This enables the Precision Mode delay parameters 340-347. This also enables the Auto Delay Calculation feature, accessible via F5 in PID Menu, which is used to automatically calculate these parameters.	2

Parameter 257 – Tool Touch-off device connection detection PLC input

This parameter stores the input for the Tool Touch-off device connection detection feature. The spindle inhibit parameter (parameter 18) must be set (non-zero) for this feature to work. The default for this parameter is 0, which disables this feature. When this parameter is set (non-zero), the Tool Measuring cycle will not run unless a Tool Touch-off device is connected. A negative value must be entered if a "normally closed" input is to be used with the control. A positive value must be entered if a "normally open" input is to be used with the control. The absolute value of this parameter will directly reflect the PLC input the Tool Touch-off device connection detect is wired to.

Parameter 258 – Velocity/Torque Mode override in Precision mode

This is an axis bitfield where setting a bit to ‘on’ allows the corresponding axis to run as if it were in velocity or torque mode, but prone to servo mismatch errors. Bit 0 (value 1) refers to axis #1, bit 1 (value 2) refers to axis #2, bit 2 (value 4) refers to axis #3, bit 3 (value 8) refers to axis #4, and so forth.

Parameter 259 – Manual Axis Designation

This parameter is a bit field that designates an axis as a manual axis regardless of its label. Bit 0 (value 1) refers to axis #1, bit 1 (value 2) refers to axis #2, bit 2 (value 4) refers to axis #3, bit 3 (value 8) refers to axis #4, and so forth.

Parameter 261 – Precision Mode Standoff Threshold

Indicates the percentage of the motor encoder counts per revolution for which standoff error must exceed before any correction is made. Setting P261 to zero disables standoff error correction. Suggested setting is = 0.01

Parameter 261 – Precision Mode Standoff Delay Time

Length in seconds that an axis must be at rest (no change in expected position) continuously before a correction is made. Suggested setting is .1

Parameter 278 – Spindle Speed Display Precision

This sets the number of digits after the decimal point to display on the Spindle Speed display in the Status Window. A setting of 0 means to show whole number spindle speeds.

Parameter 281 – Tool Touch-off Device X stylus size

Parameter 282 – Tool Touch-off Device Z stylus size

Parameter 283 – Auto Tool Touch-off safety clearance

These parameters configure the Auto Tool Touch-off cycles in the Tool Geometry Offset Library. The illustration below shows how these parameters are used to configure the Measure Z and X cycle:

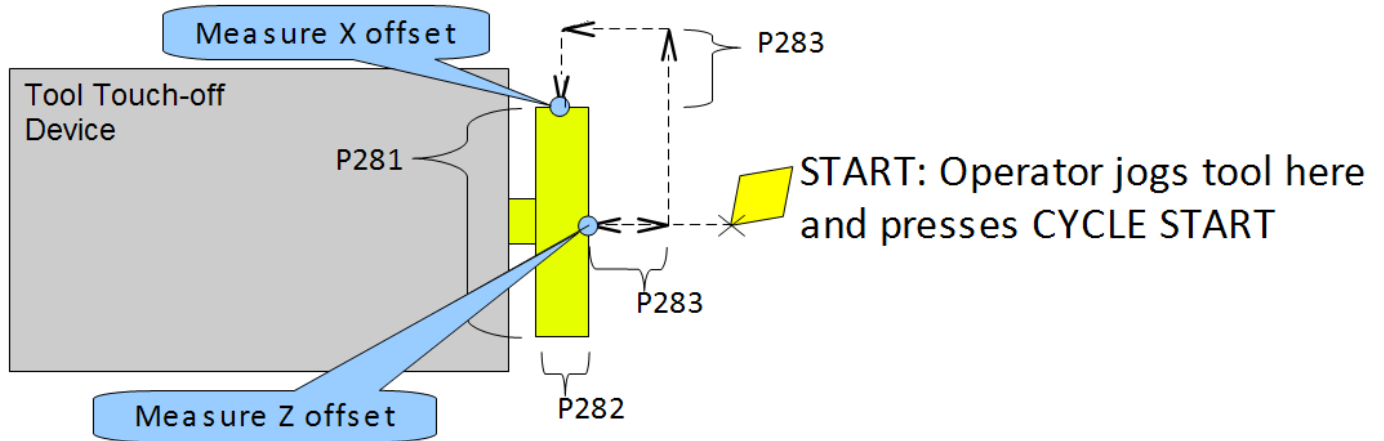

Parameter 284-291 – Brake Resistor Wattage for ACDC Drives 1-8

These parameters specify the brake resistor wattage which default to the minimum internal resistor value. If CNC11 detects that the estimated brake wattage exceeds these parameter settings, then a "470 _ axis (drive _) brake wattage exceeded" message is reported in the status window and written to the message log. These warnings may be written at most twice a minute. User variables #27201-#27208 can be used in an M- or G-code program to return the estimated brake wattage as reported by the ACDC drive to MPU11. Note that these are drive numbers, and match the LED indicator on the ACDC drive, but do not necessarily match the axes as displayed in the DRO due to the flexibility of drive mapping.

Parameter 300-307 – Drive assignment to Axes 1-8

These parameters control to what physical drive the commands for motion are sent. Parameter 300 assigns a physical drive to axis 1, parameter 301 assigns a physical drive to axis 2, and so on. The values for these parameters can be set to any value from 1-25 based on the table below. **These parameters must be set before attempting to move motors. Note that if you change any of these values, the machine must be powered down and restarted for the changes to take effect. Contact your dealer before changing these values.**

Drive Number Assignment	Drive Type and Location	Description
1,2,3,4,5,6,7,8	Drive Bus Channel 1-8	Drive types are DC3IOB, DC1, ACSINGLE, OPTIC4, and OPTICDIRECT. Other drive types may be added in the future.

Drive Number Assignment	Drive Type and Location	Description
9, 10, 11, 12	GPIO4D/RTK4 Drive Out 1-4	Drive output is implemented as outputs on the PLC bus which are updated at 4000hz.
13	RTK4 Drive Out 5	5 th output for RTK4 drive
14-16	Reserved	
17, 18, 19, 20	Legacy DC 1-4	Examples of Legacy DC drives are: QUADDRV1, SERVO1, M15DRV1, DC3IO, SERVOLV, SERVO3IO, DCSINGLE.
21,22,23,24,25	Legacy AC 1-5	Examples of Legacy AC drives are: SD1, and SD3.

Parameter 308-315 –Encoder assignment to Axes 1-8

These parameters control to which encoder the axis should look for feedback. Parameter 308 assigns an encoder to axis 1, parameter 309 assigns an encoder to axis 2, and so on. The values for these parameters can be set to any value from 1-15 based on the table below. **These parameters must be set before attempting to move motors. Note that if you change any of these values, the machine must be powered down and restarted for the changes to take effect. Contact your dealer before changing these values.**

Encoder Number	Location	Description
1	MPU11 onboard encoder 1	Encoder inputs on the MPU11.
2	MPU11 onboard encoder 2	
3	MPU11 onboard encoder 3	
4	MPU11 onboard encoder 4	
5	MPU11 onboard encoder 5	
6	MPU11 onboard encoder 6	
7	Drive Bus Channel encoder 1	Encoder inputs on Drive Bus devices. Here are some examples: One DC3IOB would occupy 3 Drive Bus Channel encoder locations numbered 7,8,9. Two DC3IOB's chained together would occupy 6 Drive Bus Channel encoder locations numbered 7,8,9,10,11,12. An OPTICDIRECT occupies 1 Drive Bus Channel encoder location. Chaining 8 OPTICDIRECTs together would occupy 8 encoder locations numbered 7-14. Legacy AC drives (such as SD1 or SD3) occupy 6 encoder locations numbered 7-12. Note that every Drive Bus device takes up a Drive Bus encoder location even if there is no encoder going to the drive.
8	Drive Bus Channel encoder 2	
9	Drive Bus Channel encoder 3	
10	Drive Bus Channel encoder 4	
11	Drive Bus Channel encoder 5	
12	Drive Bus Channel encoder 6	
13	Drive Bus Channel encoder 7	
14	Drive Bus Channel encoder 8	
15	MPU11 onboard MPG encoder	MPG connector with no index pulse

Parameter 323 – MPU11 Encoder Speed Filter

This is an axis bitfield where setting a bit to 'on' selects the low speed filters for the corresponding axis. As a general guideline, an axis's bit should be set unless that axis refers to a 3rd party drive. Bit 0 (value 1) refers to axis #1, bit 1 (value 2) refers to axis #2, bit 2 (value 4) refers to axis #3, bit 3 (value 8) refers to axis #4, and so forth.

Parameters 324-331 – Axis Boxcar Size

These parameters set the maximum sample size of the boxcar filter for each axis. For most applications these values should be set to 0 (default). For applications where the motor drives are too responsive or jumpy, these boxcar filters act as a way to smooth the PID output. They average the PID output by the entered boxcar size thus reducing PID spikes. Eg. A value of 4 would add the last 4 PID values and then divide by 4 for before output. A value of 5 would add the last 5 PID values then divide by 5 before output. Note that during PID averaging, the Error Sum is not zeroed during direction reversal. Conversely, a value of 0 disables the boxcar filter for that axis and also zeroes the Error Sum on Direction Reversal. Note also that as a byproduct of averaging by 1, a boxcar value of 1 may be used to produce a true PID output while not zeroing the Error Sum on direction reversal.

Parameters 332-335 – Encoder error suppression

These parameters control suppression of various types of encoder errors on a per encoder basis. These parameters are bitfields by encoder index, NOT axis index. The mpu11 has 15 encoder indexes. For example, to disable encoder faults for Encoder #5 on the mpu11, enter a 16 into the parameters 332 and 334. To suppress encoder faults and error messages for all 8 axes, enter 255 into each of the parameters mentioned in the following table.

Parameter	Function
332	Suppress encoder differential faults
333	Suppress encoder differential error messages
334	Suppress encoder quadrature faults
335	Suppress encoder quadrature error messages

Parameters 336-339 – Motor torque estimation for velocity mode drives

These parameters are intended to be used with velocity mode drives in order to facilitate a more accurate display of the axis load meter bars shown under each position in the main DRO display. If P336 = 0, then this feature is disabled and the normal PID output is displayed by the axis load meter bars. This feature is enabled if P336 is non-zero.

Parameter	Symbol	Function
336	G	Overall gain setting (0 = disable Motor torque estimation)
337	Ga	Absolute error gain
338	Gs	Error sum gain
339	Gd	Delta error gain

Technical details:

The axis meter bar value (V) is then calculated as: $V = \text{abs}(100.0 * G * ((Ea * Ga + Es * Gs + Ed * Gd)) / \text{integration_limit})$, where Ea is the absolute error, Es is the error sum, and Ed is the delata error from the PID algorithm and the integration_limit is from the "Limit" value set in the PID Config screen. This value V is then bound to the range 0-100.

Parameters 340-347 – Precision Mode delay (in milliseconds) for axes 1- 8

These parameters are used for synchronizing individual precision mode drives with different delays. The MPU11 will use these values and compensate for the differences in the delays. These parameters have up to a 0.25 millisecond resolution.

Parameter 348, 351, and 354 – MPG/Handwheel Encoder Input 1, 2, and 3

The encoder input for the MPG or handwheel. (1-15) See the encoder chart above. Note: PLC program interaction is needed to enable an MPG or handwheel.

Parameter 349, 352, and 355 – MPG/Handwheel Detents per Revolution 1, 2, and 3

This value is the number of clicks (detents) per revolution. It is the number of divisions or markings on the mpg or handwheel. Moving the mpg or handwheel one detent or division will cause the motor to move one jog increment (depending on the multiplier x1, x10, x100, etc). . Note: PLC program interaction is needed to enable an MPG or handwheel.

Parameter 350, 353, and 356 –MPG/Handwheel Encoder Counts per Revolution 1, 2, and 3

This value is the number of counts generated per rotation of the mpg or handwheel. Note: PLC program interaction is needed to enable an MPG or handwheel.

Parameters 357-364 – Axis Drive Max RPM for Axes 1-8

These parameters allow you to set the drive/motor max rate capability (in RPMs) for use by the PID algorithm for the calculation of the axis KV1 contribution. This value is independent from the axis Max Rate setting in the Jog Parameters menu, which is used by the control software. However, for those axes whose corresponding parameters are set to 0 (the default) the the PID algorithm will use the axis Max Rate setting in the Jog Parameters for the calculation of the axis KV1 contribution. These parameters are intended for 3rd party velocity mode drives that have a different max rate setting than that of the control software.

Parameters 365 – Drive power-on delay

This specifies the number of milliseconds that the MPU11 will wait between the moment that drive power first comes on and the start of commanded motion. However, this does not work for the case of turning off a single axis using M93, moving a different axis, and then moving the powered off axis. The default value is 0 which means no delay.

Parameters 366 / 367 – Probe / Tool Touch-off deceleration multiplier

Parameter	Function
366	Probe deceleration multiplier: This factor adjusts the deceleration rate of probing moves coming to a stop due to probe hit.
367	Tool Touch-off deceleration multiplier: This factor adjusts the deceleration rate of Tool Touch-off measuring moves coming to a stop due to tool touch detect.

Parameters 374-379 – ACDC Drive Debug Log Setting

These parameters are used by support technicians and should be left at value 0.

Parameters 392-394 – DP7 parameters

These are parameters specific to the DP7 probe and are used only if parameter 155 = 2.

Parameter	Function
392	DP7 Pullback Distance: The distance the probe moves off of the surface after a probing move.
393	DP7 Pullback Feedrate: The feedrate for the pullback move.
394	DP7 Measuring Feedrate (not used): This parameter is reserved but is not used on the Lathe.

Parameters 399 – AD1 arc chord tolerance adjustment

This parameter adjusts the precision of AD1 arcs. When Smoothing is turned off (P220 = 0) arc moves (such as G2 and G3) are generated as a string of many small linear moves that are used to closely approximate the programmed arc. These small linear moves are called arc chords. These arc chords straddle each side of the theoretical true arc path, but their distance (in encoder counts) from the path is limited by what value is set in this parameter. The default value is . 5, meaning that by default the arc chord never strays away from theoretical true arc by more than ½ encoder count.

Parameters 900-999 – PLC program parameters

These parameters are used as a way of communicating floating point values to a PLC program. The meanings of these parameters depends on how a PLC program uses them and can vary from one machine to another. One suggested use of these parameters is as a set of configuration values. The values of these parameters are saved upon modification (via a menu or CNC job) and will be retain their values even after shutdown and restart of the control software.

All remaining parameters are reserved for further expansion.

PID Menu

Pressing **F4 - PID** from the Configuration screen will bring up the PID Menu. The PID Menu provides qualified technicians with a method of changing the PID dependent data to test and configure your machine.

WCS #1 (G54)
Current Position (Inches)
Job Name: test.cnc

X
Z

+0.0000
+0.0000

Tool: T---
 Feedrate: 100%
 Spindle: +0 A

MPG Offline
 428 Check MPG cable
406 Emergency stop detected
 301 Stopped

Press CYCLE START to start job

PID Menu

Axis	Error	Sum	Delta	PID Out	Abs Pos	Max Error	Min Error
Z	0	0	0	OFF	-1	0	0
X	0	0	0	OFF	1	0	0
N*	0	0	0	OFF	1	0	0
N*	0	0	0	OFF	-1	0	0
N*	0	0	0	OFF	-1	0	0
N*	0	0	0	OFF	-1	0	0
C	0	0	0	OFF	0	0	0
N	0	0	0	OFF	0	0	0

PID Config
F1

Tune
F5

Drag
F6

Laser
F7

Drive
F8

Plot
F9



WARNING

The PID Parameters **should not** be changed without contacting your dealer. Corrupt or incorrect values could cause damage to the machine, personal injury, or both.

F1 - PID Config

This option displays the Oscilloscope tuning screen, and is intended for qualified technicians **only**. It allows technicians to modify the PID values, and to see (in real time) the effects of those modifications. Altering the PID values will cause **DRAMATIC** changes in the way the servo system operates, leading to possible machine damage. **DO NOT** attempt to change these parameters without contacting your dealer.

The general idea is to reduce the Absolute Error (ErrAbs) and the Sum of Absolute Error (ErrSum), which are both measured in encoder counts. Absolute Error tells you how far off position the machine is at any particular point in time, and the Sum is used when tuning to make sure the overall error is being reduced.

Special Note for SD3 drives: The program containing test moves (edited via F1 and run via F2 on the Oscilloscope tuning screen) must contain a dwell (G4 P__), otherwise the SD3's drive parameters will not be sent.

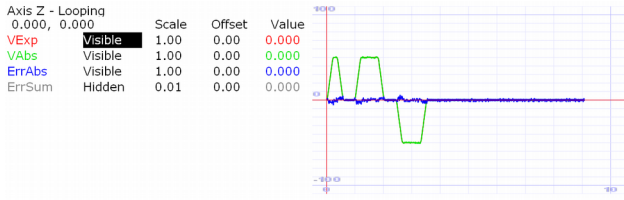

Axis	Kp	Ki	Kd	Limit	Kg	Kv1	Ka	Accel.	Max Rate
Z	0.1290	0.003052	0.7813	128000	0.0000	0.0000	0.0000	0.2000	(300.0)
X	0.1290	0.003052	0.7813	128000	0.0000	0.0000	0.0000	0.2000	(300.0)
C	0.1290	0.003052	0.7813	128000	0.0000	0.0000	0.0000	0.2000	(300.0)
N	0.5000	0.003052	0.4883	32000	0.0000	0.0000	0.0000	0.2000	(10000.0)
N	0.5000	0.003052	0.4883	32000	0.0000	0.0000	0.0000	0.2000	(300.0)
N	0.5000	0.003052	0.4883	32000	0.0000	0.0000	0.0000	0.2000	(300.0)
N	0.0000	0.000000	0.0000	0	0.0000	0.0000	0.0000	0.0000	(0.0)
N	0.0000	0.000000	0.0000	0	0.0000	0.0000	0.0000	0.0000	(0.0)

Autotune Last Run On Thu Mar 25 14:19:29 2010 v. 3.00
Autotune suggested values: 0.0000 1.0000 36.0000 0.1000 (300.0)

Edit Program	Run Program	Ranges	Toggles & Pan	Zoom In	Zoom Out	Zoom All	Change Axis	Save & Apply	Save & Exit
F1	F2	F3	F4	F5	F6	F7	F8	F9	F10

F1 – Edit Program Change the program that will run when F2 is pressed

F2 – Run Program Causes the machine to run a simple test program, while collecting data

F3 – Ranges Can be used to specify the X and Y ranges for the Oscilloscope view

F4 – Toggles & Pan Allows changes to how the collected data is displayed, and panning via the cursor keys

F5 – Zoom In Zooms in

F6 – Zoom Out Zooms out

F7 – Zoom All Fits all of the collected data into the Oscilloscope view

F8 – Change Axis Tells the MPU11 to collect data for a different axis (displayed in the top left)

F9 – Save & Apply Saves any modifications

F10 – Save & Exit Saves any modifications and exits the Oscilloscope menu

Page Up – Tweak + Allows small modifications (+1%) to the PID values while the program is running. Hold shift for a larger (+10%) modification.

Page Down – Tweak - Allows small modifications (-1%) to the PID values while the program is running. Hold shift for a larger (-10%) modification.



WARNING

Improper PID values can ruin the machine, cause personal injury, and/or destroy the motor drives!!!

F5 - Tune

This option is available only for Torque mode and Precision mode drives. See Parameter 256 earlier in this chapter for more information about Drive modes.

If the drives are in Torque mode, pressing this key will start the Autotune procedure. It is used by qualified technicians to automatically determine values for Max Rate, Accel/decel time, and Deadstart (See section Motor Configuration: Jog Parameters) as well as certain PID parameters for each installed axis. The Autotune procedure will make a series of moves on each non-paired controlled axis, traveling a limited distance (configured via parameters 95-98 and 156-159) from the initial position in all directions to determine the friction and gravity of each axis. The initial high-speed move will use half of this distance. You cannot run Autotune on paired axes. Do not run Autotune unless requested to do so by a qualified technician.

If the drives are in Precision mode, pressing this key will start the Auto Delay Calculation procedure. It is used by qualified technicians to automatically determine values for the Precision Mode delay parameters 340-347. The Auto Delay Calculation procedure will make a single move on each non-paired controlled axis, traveling a limited distance (configured via parameters 95-98 and 156-159) from the initial position. You cannot run the Auto Delay Calculation procedure on paired axes. Do not run the Auto Delay Calculation procedure unless requested to do so by a qualified technician.

F6 - Drag

This option is used by qualified technicians to determine whether your machine is binding anywhere along the axis travel. Press **F6-Drag** to begin the drag test. Press **F1** to select the axis you wish to check. Hit the **CYCLE START** button. A text file drag_x.out, or drag_z.out file is generated and stored in the c:\cnct directory. If significant drag occurs, a message will be displayed on-screen. Contact your dealer to correct the problem as soon as possible.

F7 - Laser

This option is used by qualified technicians to take automated laser measurements and create or adjust the ballscrew compensation tables using accordingly. Do not attempt to run automatic laser compensation without first contacting your dealer for details.

F8 - Drive

This menu will only appear on AC systems and only affects using SD or ACSingle drives. It is not for general viewing and definitely not for modification by any unqualified individual. For more information about this menu option, refer to the SD installation manual.

F9 - Plot

This option is used by qualified technicians to plot data.

Test

This menu only appears if the system has not yet been configured and initialized or if a new solid state disk has been installed. For more information, please contact your dealer.

Chapter 15

CNC Software Messages

CNC software startup errors and messages

Number	Message	Cause & Effect	Action
102	102 Error initializing CPU...cannot continue.	Error while sending <i>.hex</i> file. Cannot communicate with MPU11 or it is not plugged in.	Inspect MPU11 connection, or fix missing or corrupted hex file. Contact Dealer
103	Error sending setup	Unable to send setup command to MPU11. Cannot communicate with MPU11 or it is not plugged in.	Inspect MPU11 connection, or fix missing or corrupted hex file. Contact Dealer
104	Error sending PID setup	Unable to send PID setup command to MPU11. Cannot communicate with MPU11 or it is not plugged in.	Inspect MPU11 connection, or fix missing or corrupted hex file. Contact Dealer
105	<i>mpu.plc</i> file read error..cannot continue	Missing or error in <i>mpu.plc</i> .	Contact dealer Install or recompile PLC program.
106	The PC clock appears to be wrong	The time on the PC internal clock is earlier than the time recorded in a previously stored file	
199	CNC started	CNC control software has started.	

Messages issued upon exit from CNC software

Number	Message	Cause & Effect	Action
201	Exiting CNC due to a known error	MPU11 not responding, or <i>mpu11.hex</i> , <i>mpu.plc</i> is missing or damaged.	Contact dealer Check for possible software corruption
202	Exiting CNC due to a math error	A floating-point math error occurred. Possible corruption of <i>cnc.tem</i> , <i>cncm.job</i> , or <i>cncm.wcs</i> .	Contact dealer Delete corrupted files and reboot software.
204	Exiting CNC...Normal Exit	CNC control software is shutting down normally.	
222	Autotune run	added to log whenever autotune is run	

Messages and Prompts in the Operator Status Window Status messages

Number	Message	Cause & Effect	Action
301	Stopped	No operations in progress	
302	Moving...	Motors are moving while a CNC program is running	
303	Paused...	Motion is paused while a CNC program is running (FEED HOLD)	
304	MDI...	CNC software running in MDI mode	
305	Processing...	CNC software running in a mode other than MDI	
306	Job finished	Normal end of CNC program	
307	Operator abort: job canceled	ESC or CYCLE CANCEL pressed. Job is cancelled.	
308	Waiting for input #NN	M100 or M101 executing. Program will continue once specified input opens or closes.	
309	Waiting for CYCLE START button	M0, M1, M100/75, or Block Mode is executed.	Press Cycle Start
310	Waiting for output #NN	M100 or M101 executing. Program will continue once specified output opens or closes.	
311	Waiting for memory #NN	M100 or M101 executing. Program will continue once specified memory bit changes to the correct state.	
312	Waiting for PLC operation (Mnn)	PLC program not clearing PLC operation in progress	
313	Waiting for dwell time	G4 executing. Program waits for specified dwell time then continues.	
314	Waiting for system #NN	M100 or M101 executing. Program will continue once specified PLC system variable changes to the correct state.	Enter required information.
315	Searching...	Run/search in progress	
317	Waiting for automatic tool change	<i>cncrch.mac</i> executing	
318	Operator Abort probing cancelled	ESC or CYCLE CANCEL pressed while doing a probing move	
319	Probing cycle cancelled	probing cycle was cancelled	

Number	Message	Cause & Effect	Action
320	Probe stuck	probe is stuck, or probe hit an object when it wasn't expecting contact.	
322	Stall: probing cancelled	probing was cancelled because of a stall	
323	Stall: job cancelled	job was cancelled because of a stall	
324	Limit: probing cancelled	probing was cancelled because of a limit error	
325	Limit: job cancelled	job was cancelled because of a limit error	
326	Fault: probing cancelled	probing was cancelled because of a fault	
327	Fault: job cancelled	job was cancelled because of a fault	
328	Cutter comp error: job cancelled	job was cancelled because of a cutter comp error	
329	Invalid parameter: job cancelled	job was cancelled because of an invalid parameter	
330	Canned cycle error: job cancelled	job was cancelled because of a canned cycle error	
331	Threading error: job cancelled	The programmed threading move will cause an axis to exceed its maximum rate.	
332	Search Failed	Run/Search was unable to find the requested G-code line	
334	Locating position to resume job...	Run/Search is locating the job continuation point in the program	
335	Emergency Stop Released	Emergency Stop Button has been released	
336	Digitize cancelled	ESC or CYCLE CANCEL pressed during digitizing	
337	Digitize complete	A digitizing routine ran to completion	
338	Job Cancelled	ESC or CYCLE CANCEL pressed during job run	
339	Jogging...	An axis jog key is pressed and machine is moving the corresponding axis	
340	Limit (#_) cleared	A previously tripped limit switch is now in the "untripped" position	
341	Probing Cycle Finished	A probing cycle ran to completion	
342	Waiting for motion to stop	PC is waiting for the MPU11 to complete motion	
343	Waiting for stop reason reset	PC is waiting for the MPU11 to reset the stop reason (as part of the PC/MPU11 communications handshake).	
344	Feedrate modified due to spindle	The effective feedrate has been lowered because the spindle is spinning slower than the threshold percentage of the commanded spindle speed. (The threshold percentage is specified in P149.)	
345	Waiting for spindle to get up to speed	Job progress is paused until the actual spindle speed reaches the threshold percentage of the commanded spindle speed. (The threshold percentage is specified in P149.)	
346	Waiting for spindle direction	Job progress is paused until the spindle turns the commanded direction.	

Abnormal stops (faults)

Abnormal stops are detected in the following order: PLC, servo drive, spindle drive, lube, ESTOP. This means that if both the servo drive and the spindle drive have faulted, the servo drive fault message would appear.

Number	Message	Cause & Effect	Action
401	PLC failure detected	MPU11 stopped with PLC failure bit set. Job cancelled.	Check PLC fibers and PLC logic power.
404	Spindle drive fault detected	MPU11 stopped with spindle drive fault bit set. Job cancelled.	Check inverter for fault or reset spindle contactor OCR, then cycle EMERGENCY STOP
405	Lubricant level low	MPU11 stopped with low lube fault bit set. Current job will finish but nothing will work after that.	Add lube or check low lube switch wiring then cycle EMERGENCY STOP
406	Emergency Stop detected	MPU11 stopped with no fault bits set. Job cancelled.	Release Estop
407	limit (#1) tripped	MPU11 stopped with limit switch tripped. Job cancelled.	Clear limit switch
408	Programmed action timer expired	M103 time expired before M104 encountered. Job cancelled.	Find out why timer expired before specified action was completed.
409	_ axis lag	Lag Distance (Allowable Following Error) is detected on any axis for more than 1.5 seconds. All axis motion is stopped and the CNC program is aborted. The probable causes of this error are: 1. The machine is doing a very heavy cut. 2. The maximum rates or the acceleration values for the motors are set too high. 3. The motors are undersized for the application	1. If the problem is occasional heavy cuts, slowing down the cutting feedrate can solve the problem. 2. If the problem only occurs on high speed moves then either the maximum speed or the acceleration is set too high. Lower the values in the Motor Setup screen or run Autotune again to determine new values. 3. If there are persistent lag errors in normal operations, this indicates that the motors are too weak to handle the required loads. Increase the gear ratios or get more powerful motors.

Number	Message	Cause & Effect	Action
410	_ axis position error	<p>A position error > 0.25 inches is detected on any axis. All axis motion is stopped, power to the motors is released (all servo drive commands cease) and the CNC program is aborted.</p> <p>The probable causes of this error are:</p> <ol style="list-style-type: none"> 1. The motor is wired up backwards. 2. Noise is getting into the system via the motor cables (the line integrity has been violated). 3. An encoder error occurred. 	<ol style="list-style-type: none"> 1. Try to slow jog the motor and watch the DRO position. If the position on the DRO goes opposite the direction indicated on the jog button, then the motor is wired up backwards. Change the motor wiring. 2. Check the motor cabling paying particular attention to the ground connections. Replace the cable if it is damaged or repair the motor connections. 3. Jog the motor awhile, at the maximum rate, using the fast jog buttons. (Check the fast jog rate in the motor jog parameters screen to make sure it is set equal to the maximum motor rate.) If the motor seems to jump around rather than accelerate and decelerate smoothly then you are probably fighting an encoder error. Swap the motor with one from another axis and see if the error follows the motor. If it stays with the axis, replace the MPU11. If it follows the motor, replace the motor cable. If the problem still persists, replace the motor and encoder.
411	_ axis full power without motion	<p>90% Power (PID Output > 115) is applied to any axis and no motion >0.0005 inches is detected, for more than the time specified in parameter 61 (default .5 sec.). All axis motion is stopped and the CNC program is aborted.</p> <p>The probable causes of this error are:</p> <ol style="list-style-type: none"> 1. One of the axes is against a physical stop. 2. The servo drive has shutdown due to a limit switch input. 	<ol style="list-style-type: none"> 1. If the axis has run into a physical stop, use the slow jog mode to move the axis away from the stop. Determine and set software travel limits to stop machine before in runs into the hard stops. 2. If the axis is not on a physical stop, check for a tripped limit switch. If it is then the software is commanding a move into the switch but the hardware is shutting the move down. Go to the motor setup screen and enter the limit switch input number if applicable. 3. Make sure the switch input is not unstable or noisy. If it is then replace the switch. If the problem persists it may be necessary to create separate home and limit switch inputs. <p>Use slow jog to move opposite the direction causing the error and clear all limit switches. Jog toward the direction causing the error, if no motion occurs then a servo drive failure is indicated.</p>

Number	Message	Cause & Effect	Action
412	_ axis encoder differential error	An error condition was detected in the differential signal levels for this axis encoder. May indicate a loose or severed encoder cable or a bad encoder. This will stop all motion and cancel the job.	Reconnect/replace encoder or encoder cable.
417	Abnormal end of job	Job ended without reason.	
418	Search Line or Block not found	Requested search input data not found in loaded CNC file.	Type in correct data or load correct job.
419	Search line in embedded subprogram	Requested search line is found, but is part of an embedded/extracted subprogram	Use another line number
420	_ axis motor overheating	CNC software estimates that a motor has reached the warning temperature (set in Parameter 29). Motor is overheating or the temperature file is corrupted. Job will be cancelled.	Contact dealer. Determine what's causing motor to overheat or delete cnc.tem file and reboot.
421	Motor(s) too hot: job canceled	CNC software estimates that one or more motors have reached the limit temperature (set in Parameter 30). Will not be able to run until motor cools down.	Contact dealer. Determine what's causing motor to overheat or delete cnc.tem file and reboot.
422	Check Jog Panel cable	Jog panel failure or loose cable.	Reconnect jog panel cable.
428	Check MPG cable	MPG failure, loose cable, or was turned off.	Reconnect MPG cable and turn axis selector knob to an axis.
434	_ idling too high: Releasing power	Axis is not moving and no job is running but axis has stopped against some abnormal resistance. Power is released to motors.	Run an autotune to adjust motor settings.
435	_ axis runaway: Check motor wiring	Motor was in a runaway fault condition. Power to motor will automatically be shut off.	Check motor wiring
436	Servo drive shutdown	This error message is produced by hardware detection of a physical error. The servo drive hardware generates this error message if it detects either an overcurrent or overvoltage condition. The particular hardware condition is reflected on the servo drive LED's. Once the servo drive detects this error condition it stops all motion and removes power to the motors. The hardware indicates the presence of this condition to the CNC software via the servo drive fault input to the PLC.	On DC systems check status of the servo drive LED's and check fibers 4&5. If this message is displayed on an AC system check P178 bit 4 is set.

Number	Message	Cause & Effect	Action
437	Servo power removed	Axis was moving more than 300 RPM while power was supposed to be off. 1.) Motor may be wired backwards. 2.) May be a shorted servo drive. 3.) Axis motion is canceled but motor continues to move due to inertia, which is probably caused by an unbalanced axis. Power to motors is released.	Check motor wiring, servo drive, or look at Kg value in PID and make sure it's not above +/- 5.
438	Spindle slave position error	The slaved axis moved too far in the wrong direction during a spindle-slaved move (such as in rigid tapping, threading, and feed-per-revolution moves). Job is cancelled.	Check parameter 34 for wrong sign in front of encoder counts.
439	_ axis servo drive data output error	Logic power failure or loss of communication from the drive to the MPU11.	Is logic LED on? Check fiber optic cables to drive. For SD1 drives, make sure bus cables are shielded and are as short as possible. Power unit down and check drive connections.
441	_ axis overvoltage	Input power has gone higher than 340VDC and will shutdown the drive and removes power. The motor brake will engage for 5 seconds in this condition.	Check input voltage is below 340VDC. If not, incoming VAC needs lowered.
442	_ axis undervoltage	Drive input power is less than 80 VDC.	Check supply voltage.
443	_ axis commutation encoder bad	Control detected invalid commutation zone value.	Perform a motor Move Sync in the Drive menu. A Zero (0) or Seven (7) is an invalid zone. Check for: a.) Wiring problem in the encoder cable or motor end cap (broken encoder wires). b.) Encoder cable shield connected at motor end, when it shouldn't be. c.) Bad encoder. d.) Motor power cable shields not connected. e.) Drive not grounded properly.
444	_ axis overtemperature detected	Drive overtemp sensor tripped. No motor power.	The drive is being run at over capacity or the cooling fan is either not functioning or its air flow is blocked.
445	_ axis overcurrent detected	Overcurrent detected on an axis. No motor power.	Try to jog the axis. The drive will reset the current limit and try to move the motor. If the error comes back, check for a short in the motor output.
446	_ axis servo drive data input failure	Communication Checksum error. No motor power.	Check fiber optic cables. Verify continuity between drive chassis, ground strip and Earth ground.
447	_ axis (#) bad index pulse detected	Noise picked up by encoder cable or misaligned encoder. No motor power.	Remove noise or align the encoder.

Number	Message	Cause & Effect	Action
449	Manual movement detected in restricted area	Detection for this condition is currently unimplemented.	This condition should not appear.
450	Voltage brake applied	Overvoltage condition was detected. Electronic braking was applied by offloading excess voltage to dropping resistors.	Usually this error condition is innocuous even if this message occurs every once in a while in a job. However, if this message occurs in a continuous stream, contact your dealer.
451	Current brake applied	Overcurrent spike was detected on the drive.	Usually this error condition is innocuous even if this message occurs every once in a while in a job. However, if this message occurs too often, it may mean you need a higher current drive. But, if this message appears in a continuous stream, something is seriously wrong, and you should hit E-Stop to cut power to the drive and then contact your dealer.
452	PC Receive Data Error	A fatal communication error occurred between the MPU and PC. The error was detected on the PC side.	Restart the software to clear the error. If this error occurs often there may be an issue with the network configuration or the Ethernet cable.
453	CPU Receive Data Error	A fatal communication error occurred between the MPU and PC. The error was detected on the MPU11 side	Restart the software to clear the error. If this error occurs often there may be an issue with the network configuration or the Ethernet cable.
454	axis scale encoder differential error	An error condition was detected in the differential signal levels for this axis scale encoder. May indicate a loose or severed encoder cable or a bad encoder. This will stop all motion and cancel the job.	Reconnect/replace scale encoder or scale encoder cable.
455	axis encoder quadrature error	The axis encoder skipped a transition state on its count-up/count-down sequence. May indicate a bad encoder or a loose or severed encoder cable. This will stop all motion and cancel the job.	Reconnect/replace encoder or encoder cable.
456	axis scale encoder quadrature error	The scale encoder skipped a transition state on its count-up/count-down sequence. May indicate a bad encoder or a loose or severed encoder cable. This will stop all motion and cancel the job.	Reconnect/replace scale encoder or scale encoder cable.
457	Unable to find home	A commanded move was seeking either an index pulse or a hard stop, but neither was found.	Reconnect/replace encoder or encoder cable if move was seeking an index pulse. Check that hard stop was not broken off nor overrun.
461	Spindle axis is not set	An operation aborted because the spindle axis parameter (P35) has an incorrect value.	Contact dealer.
470	brake wattage exceeded	The brake wattage was exceeded on the indicated ACDC drive.	Contact dealer.

CNC syntax errors

Number	Message	Cause & Effect	Action
501	Invalid character on line NNNNN	Invalid character on CNC line. Job cancelled.	Remove character from program.
502	Invalid G code on line NNNNN	Invalid G code encountered on CNC line. Job cancelled.	Correct invalid G-code.
503	Invalid M function on line NNNNN	Invalid M function encountered on CNC line. Job cancelled.	Correct invalid M-code.
504	Invalid parameter on line NNNNN	Invalid or missing number after letter. Job cancelled.	Correct program.
505	Invalid value on line NNNNN	Value out of range (T, H, D). Job cancelled.	Correct program.
506	Only 1 M code per line	More than one M code appears on the line. Job cancelled.	Move 2 nd M-code to next line.
507	No closing quote	The closing quotation mark (") is missing. Job cancelled.	Add quotation.
508	Macro nesting too deep	Macro nesting limit exceeded on attempt to invoke a subroutine. Job cancelled.	Create a second program.
509	Option not available	Attempt to access a locked software option. Job cancelled.	Contact Dealer.
510	Too many macro arg's	Too many arguments were given in a G65 macro. Job cancelled.	Correct number of arguments.
511	Missing parameter	A parameter is required or expected but not found. Job cancelled.	Correct program.
513	Expected "="	Error in expression to left of "=", missing "=", or orphaned parameter. Job cancelled.	Correct equation.
514	Empty expression	The expression contains no operands. Job cancelled.	Correct expression.
515	Syntax error in expression	Illegal character in number, variable or function. Job cancelled.	Correct program.
516	Unmatched bracket (parenthesis)	Brackets or parentheses are paired improperly or misplaced. Job cancelled.	Correct program.
517	Evaluation stack overflow	Brackets or parentheses are nested too deeply. Job cancelled.	Correct program.
518	Undefined variable	The variable name does not exist. Job cancelled.	Correct program.
519	Too many variables	The space allotted for user-defined variables has been exceeded. Job cancelled.	Correct program.
520	Invalid variable name	The variable name contains an illegal character. Job cancelled.	Correct program.
521	Divide by zero	Attempt to divide by zero. Job cancelled.	Correct program.
522	Domain error	Imaginary number would result (square root of a negative number). Job cancelled.	Correct program.
523	Invalid value in assignment	Attempt to assign an illegal value to a system variable. Job cancelled.	Correct program.
524	Variable is read-only	Attempt to assign a value to a read-only system variable. Job cancelled.	Correct program.
525	Missing P value	P parameter is expected but is missing	Correct program.

Number	Message	Cause & Effect	Action
526	M22x Missing initial variable	M224 or M225 was not immediate followed by a #variable reference.	See Chapter 13 for syntax of M224 or M225
527	M22x initial variable parse error	M224 or M225 was immediate followed by an invalid #variable reference.	Correct program.
528	M225 String variable not allowed	M225 was immediately followed by a string #variable (which is invalid). Only numeric variables are allowed here.	Correct program.
529	M225 invalid variable	The #variable specified after the M225 was not valid, or not readable due to a machine error.	Correct program.
530	M224 invalid variable	The #variable specified after the M224 was read-only, or not writeable due to a machine error.	Correct program.
531	M22x missing initial quote	The beginning of the quoted (“) format string was not found or was in the wrong place on the G-code line.	See Chapter 13 for syntax of M200, M223, M224 or M225
532	M22x missing end quote	The format string did not end with a quote (”)	See Chapter 13 for syntax of M200, M223, M224 or M225
533	M22x embedded quote not allowed	The format string contained a quote (“) in the middle of it.	See Chapter 13 for syntax of M200, M223, M224 or M225
534	M22x character limit exceeded	The format string was too long	Correct program.
535	M22x invalid format string	The format string contained invalid format codes	Correct program.
536	M22x missing format specifier	The format code was missing the its specifier	Correct program.
537	M22x Missing Argument	A format code was specified in the format string, but its corresponding #variable argument was missing	Correct program.
538	M22x argument parse error	A format code was specified in the format string, but its corresponding #variable argument had a syntax error	Correct program.
539	M22x variable type mismatch	A string format code was specified in the format string, but its corresponding #variable argument was numeric OR a numeric format code was specified in the format string, but its corresponding #variable argument was a string	Correct program.
540	M22x variable cannot be read	A format code was specified in the format string, but its corresponding #variable argument was invalid or there was a machine error when accessing it.	Correct program.
542	M22x character limit exceeded	The resultant formatted string after all the format codes were processed was too long.	Correct program.
543	Missing L parameter	L code was missing	Correct program.

Number	Message	Cause & Effect	Action
544	Too many axes	More than 1 axis was specified with M128, OR the Simultaneous Contouring feature is not enabled. Without the Simultaneous Contouring feature, a maximum of 3 axes are allowed per G-code line.	Specify fewer axes on the G-code line OR Contact Dealer for information about obtaining the Simultaneous Contouring feature.
545	Value out of range	Parse error occurred because value was out of range	Correct the value
547	Move by counts not allowed	Cutter comp (G41/G42) was on when M128 was specified	Issue G40 (Cutter comp off) before issuing M128
548	String too long	A quoted string was too long (usually a file name was longer than its allowed limit).	Shorten the file name.
549	Line too long	A line in a G/M-code program is too long (more than 1023 characters).	Shorten the line.
550	Invalid L parameter	The value associated with the L code is invalid	Give the correct value.
551	Invalid R value	The value associated with the R code is invalid	Give the correct value.
552	File encryption error	Error while parsing encrypted G-code file.	

Cutter compensation errors

Number	Message	Cause & Effect	Action
601	Error: no compensation in MDI	G41 or G42 entered in MDI. MDI is not canceled, but cutter compensation does NOT go into effect. Remainder of line processed.	Do not use G41 or G42 in MDI.
603	Arc as first uncom. move on line NNNNN	Arc specified as first move after end of compensation (G40). Job cancelled.	First move after G40 must be a linear move.
605	Canned cycle not allowed on line NNNNN	Canned cycle attempted during compensation. Job cancelled.	Do not use cutter comp. with canned cycles.
606	G53 not allowed on line NNNNN	G53 attempted during compensation. Job cancelled.	
607	Set home not allowed on line NNNNN	M26 attempted during compensation. Job cancelled.	Do not use M26 with cutter comp.
608	Ref. point move not allowed on line NNNNN	G28, G29, or G30 attempted during compensation. Job cancelled.	Do not use return points with cutter comp.

Parameter setting errors

Number	Message	Cause & Effect	Action
701	G10 error: no R-value on line NNNNN	G10 used with no R-value. Job cancelled.	Input an R-value.
702	G10 error: invalid D on line NNNNN	Job cancelled (D0 cannot be set; it is always zero).	Change D to a valid value.
703	G10 error: invalid H on line NNNNN	G10 H0 Rxx specified. Job canceled (H0 cannot be set; it is always zero).	Change H to a valid value.

Number	Message	Cause & Effect	Action
704	G10 error: invalid P on line NNNNN	G10 used with unknown P value. Job cancelled.	Change P to a valid value.
705	G10 error: No D, H, or P on line NNNNN	G10 used without D, H, or P to assign value. Job cancelled.	Add appropriate D, H, or P value.

Canned cycle errors

Number	Message	Cause & Effect	Action
801	Error: No R point on line NNNNN	No R-value specified. Job cancelled.	Add an R-point.
802	Error: Q = 0 on line NNNNN	Q value of 0 specified (Q used for G73 and G83 only). Job cancelled.	Insert a Q non-zero value.
803	Error: No Z point on line NNNNN	No Z value specified for canned cycle. Job cancelled.	Add a Z-value.
804	Error: Ggg invalid on line NNNNN (gg = 76, 86, 87, 88)	Unimplemented canned cycle requested. Job cancelled.	Change to a valid G-code.
805	Error: No Q value on line NNNNN	Q value not specified for G73 or G83. Job cancelled.	Insert a Q-value.
806	Error: No P value on line NNNNN	P value (dwell time) not specified for G82 or G89. Job cancelled.	Add a P-value.

Miscellaneous errors

Number	Message	Cause & Effect	Action
901	Ref. point invalid on line NNNNN	G30 with invalid P value (must be 1 or 2). Job cancelled.	Change P-value to a 1 or 2.
902	No prior G28 or G30 on line NNNNN	G29 with no preceding G28 or G30.	Add a G29 or G30.
903	Warning: No coordinates for G50 on line NNNNN	G50 with no axis coordinates to set. Remainder of line processed; job continues.	Add coordinates.
905	Warning: 0 radius arc on line NNNNN	Arc move was specified with a zero radius. Move is done as a linear move; job continues.	Specify a radius.
906	Warning: unknown arc on line NNNNN	Position of arc move could not be determined from parameters. Move is done as a linear move; job continues.	Correct program.
907	_ axis travel exceeded on line NNNNN	Software travel limit would be exceeded by the requested move. Job cancelled.	Check program, part zero or tool offset.
909	Program too long: job canceled	Attempt to run a job over 1MB in length, without the unlimited program size option. Job cancelled.	Contact Dealer or break up program.
910	No subroutines in MDI	Specified O9100 - O9999 in MDI, which would begin an embedded subprogram. MDI cancelled.	
911	Illegal recursion	Attempt to execute a subprogram or macro that calls itself, either directly or indirectly. Job cancelled.	Call correct subprogram.
913	Could not open file <i>filename.ext</i>	Attempt to call a subprogram or macro, but the subprogram file does not exist. Job cancelled.	Make sure file name is correct and is in the nfiles directory.

Number	Message	Cause & Effect	Action
915	DSP window retry sN fN rN	DSP window checking failed, move will be repeated unless the maximum retries have been reached, s = number of successes, f = number of failures, r = number of times the maximum retry value has been reached	
916	Unexpected probe contact	probed tripped when a cycle did not expected contact	
917	Invalid tilt lookup table	The tilt lookup table file (tilt.tab) has an invalid format or if it is not found	
918	Probe unable to detect surface	Probe travelled maximum distance without contact, dsp window checking failed, or probe repeatability failed.	
919	DSP window failed maximum retries	DSP probe reached the maximum retry limit without a successful window	
920	Unable to clear obstacle	Probing cycle failed to clear an obstacle	
922	Out of memory	problem allocating memory	
924	File read error	Problem reading the job file, this error occurs if the file was opened successfully but there was an error while reading the file.	
925	Error reading job file	same as above at a different place in the code	
926	Failed to locate job continuation position	Job continuation from the Run Menu failed.	Do a Run/Search
927	Too many subprogram calls	Nesting level of subprograms is too high. I.e. a subprogram calls another subprogram which calls another subprogram, which calls another subprogram, etc...	
928	Error Loading Log Configuration file... Using defaults	There was an error while loading the log configuration file. Default settings will be used.	
929	Log Level set to __	The logging level parameter (P140) has been changed.	
930	Log Level Configuration file not found... Creating new configuration.	The log level configuration file was not found. A default file will be created.	Not Applicable
932	Error during Tool Check	A general error condition occurred when the Tool Check key was pressed.	
933	Log file initialized	There was an error in trimming the log file, or the log file did not exist, so a new log file has been created.	
934	Warning: Excess precision truncated	A CNC program is using axis positioning precision greater than what is displayed, and therefore the actual commanded positions are truncated. This happens when the Simultaneous Contouring feature was not enabled. This feature must be enabled for the extra precision to be acknowledged.	Contact Dealer for information about obtaining the Simultaneous Contouring feature.
935	_ axis (#) scale disabled	A scale is enabled for this axis but compensation was disabled. Scale compensation is disabled at initial power up, configuration changes, and during homing moves.	Home the machine.

Number	Message	Cause & Effect	Action
936	_ axis (#) scale enabled	A scale is enabled for this axis and compensation was enabled. This happens after homing the axis.	Not Applicable
944	MPU requested resend	The MPU requested a resend	Status Message
945	PC requested resend	The PC requested a resend	Status Message
946	PC resending	The PC is resending	Status Message
947	PC received data out of order	The PC needed to reorder data received from the MPU	Status Message
948	PC packet error	The PC received bad data from the MPU and will try to recover by requesting a resend.	Status Message
949	Drive map does not match hardware	One or more of the drive mapping parameters 300-307 is misconfigured	Contact Dealer.

Configuration Modification messages

Number	Message	Cause & Effect
111	modified: ->	An axis configuration parameter was modified.
444	modified: ->	A servo drive configuration parameter was modified.
555	modified: ->	A PID configuration parameter was modified.
556	Axis converted: ->	A PID configuration parameter was converted.
777	modified: ->	An axis configuration parameter was modified.
999	Parm # modified: ->	A machine parameter was modified.