

HARNISCH COMPANY

Architectural Hardware

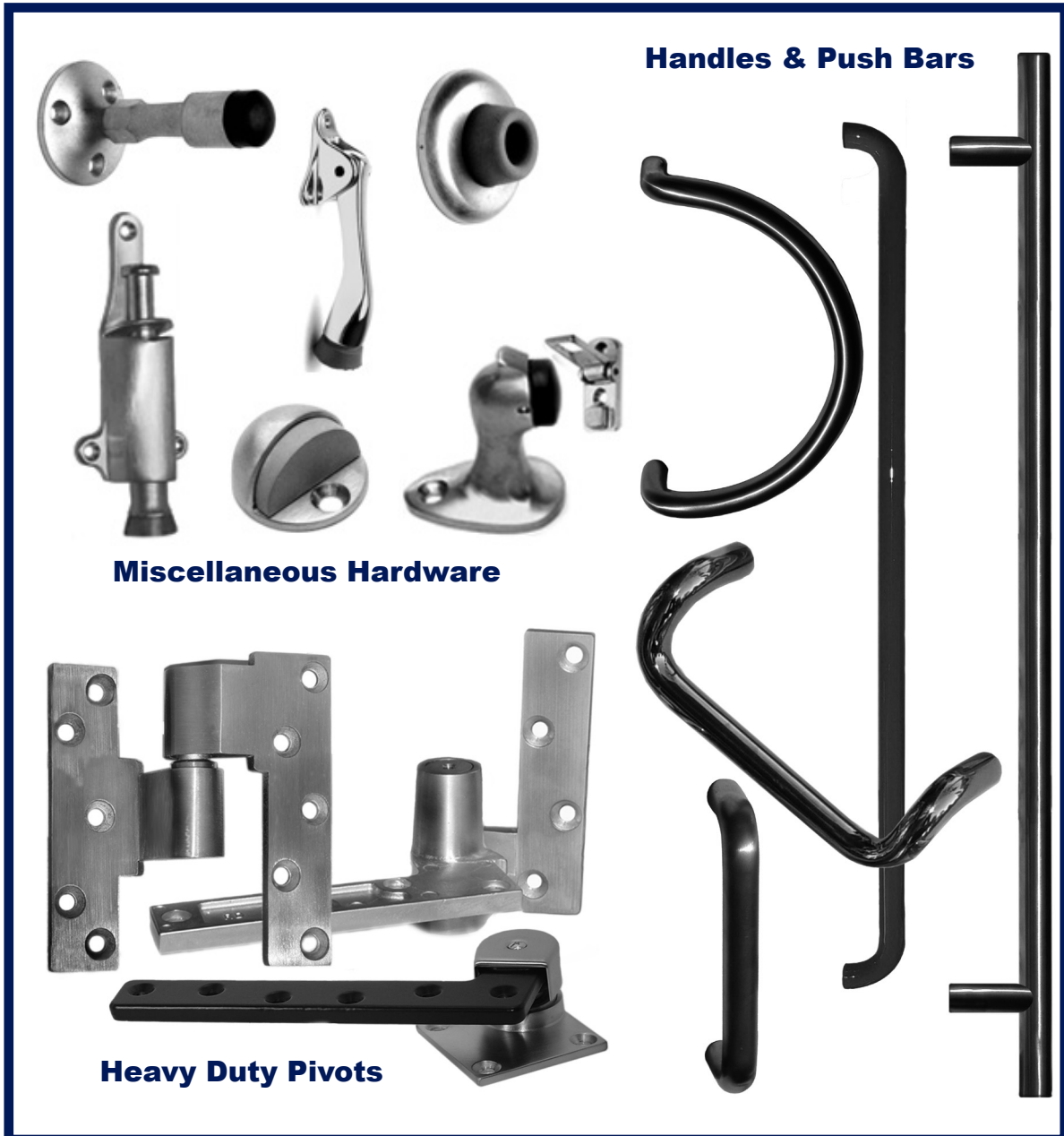

Handles & Push Bars

Miscellaneous Hardware

Heavy Duty Pivots

**7651 Woodwind Drive
Huntington Beach CA 92647**

**714-841-4486
714-841-9635 fax**

WALL STOPS



WC20
Convex
Cast Wall Bumper
2 3/8" Diameter
1 3/16" Projection



WC25
Concave
Cast Wall Bumper
2 3/8" Diameter
1 3/16" Projection



**WA-G Adhesive-Backed
Wall Bumper-Grey**
WA-W White Wall Bumper not shown
1 7/8" Diameter
3/4" Projection

MADE IN USA



**WC15 Compact Cast
Wall Bumper**
1" Diameter
9/16" Projection



WS20
Convex
Wrought Wall Bumper
2 3/8" Diameter
1 3/16" Projection



WS25
Concave
Wrought Wall Bumper
2 3/8" Diameter
1 3/16" Projection

WALL STOPS



701XP Heavy Duty Wall Stop
2 1/2" Diameter Base
3 5/8" Projection



W340 Medium Duty Wall Stop
3 1/4" Projection



W425 Medium Duty Wall Stop
4" Projection



W325 Light Duty Wall Stop
3" Projection



W300 Heavy Duty Wall Stop
1 3/8" Diameter Base
3 3/4" Projection



W450 Heavy Duty Wall Stop
2 1/4" x 3" Base
3 3/4" Projection

DOME STOP



SD30 SlipperDome Stop
1 11/16" x 4" x 5/16" Base
1" High



SD35 SlipperDome Stop
2" x 4" x 1/2" Base
1 5/16" High



FS30 Dome Stop
1 3/4" Diameter
1/8" Base



FS35 Dome Stop
1 3/4" Diameter
1/2" Base



**FS45 Universal
Dome Stop**
1 3/4" Diameter
1/4" Base



FS37 Riser
1 3/4" Diameter
3/8" Base

FLOOR STOP



F500XP Heavy Duty Floor Stop
1 9/16" X 2 7/8" Base
2" High



F600XP Heavy Duty Floor Stop
1 1/2" x 2 1/2" Base
2 11/16" High



**FB185
Heavy Duty Stop**
2" Diameter
1-1/2" High



**FB18T
Heavy Duty Stop**
2" Diameter
3-1/2" High



702XP Heavy Duty Floor Door Stop
2 1/2" Diameter
3 1/16" High



704XP Heavy Duty Floor Door Stop
2 1/2" Diameter
3 1/16" High



F650XP Heavy Duty Floor Door Stop
1 5/8" x 2 5/8" Base
1 7/8" High



FS434 Full Cushion Stop
2-3/4" High

WALL STOPS

HP20 Hinge Pin Stop
85°-125°
Cast Aluminum

W350 Heavy Duty Wall Stop
1 3/4" Diameter
2 1/4" Projection

703XP Heavy Duty Wall Door Stop
2 1/4" Diameter
3 5/8" Projection

HP30 Hinge Pin Stop
70°-100°
Heavy Duty Steel

ROLLER BUMPERS

RB400
4 1/2" Projection
2" Diameter

RB300
2 5/8" Projection
2 1/4" x 2" Base

RB600
6 1/2" Projection
2" Diameter

DOOR SILENCERS

DS64 Door Silencer
Metal Frames

DS65 Door Silencer
Wood Frames

AUTOMATIC DOOR HOLDER

Automatic Door Holder
3 11/16" x 3" Base
1 15/16" Projection

FS951
1 3/4" High

FS950
1 3/16" High

FS952
2 1/4" High

FS953
2 3/4" High

WH950 Automatic Door Holder
2 3/4" x 2 7/16" Base
2 3/16" Projection

FS900 Semi-Automatic Door Holder & Stop
2" X 3 1/2" Base
4 7/8" High

DOOR HOLDERS

Cast Iron Kick Down Door Holder

DH40

DH50
5" Arm
1 7/16" x 2 1/8" Base

Cast Brass Kick Down Door Holder

DH004
4" Arm
1 7/16" x 2 1/8" Base

DH005
5" Arm
1 7/16" x 2 1/8" Base

PlungerType Door Holder

DH3354
5 3/8" x 2 1/4" Base
1 1/4" Projection
1 1/4" Throw

DH3353
6 1/4" x 1 1/2" Base
1 7/16" Projection

ROLLER LATCHES



RL980 Roller Latch
1" X 3 3/8" Latch Face



RL320 Roller Latch Heavy Duty
2 1/4" x 1 1/8" Latch Face



RL1180 Roller Latch/Angle Stop
1 1/2" Wide Latch Face



RL380 Roller Latch Surface Mount/SS
1 3/4" x 3/4" Strike



RL360 Roller Latch Light Duty/SS
2 1/4" x 7/8" Face Plate
2 1/4" x 7/8" Strike

BALL CATCHES



CL220 Two Way Catch
2 3/16" Length



CL215 Four Way Catch
3" Length



CL210 Four Way Catch
3" Length



BC100 Adjustable Ball Catch
1 1/2" x 3/4" Face Plate
1 1/2" x 25/32" Strike

BULLET CATCHES



BC250 Bullet Catch
1/4" Diameter
3/8" Length



BC375 Bullet Catch
3/8" Diameter
1/2" Length



BC376A Adjustable Bullet Catch
3/8" Diameter
5/8" Length



BC500A Adjustable Bullet Catch
1/2" Diameter
1-1/32" Length

ROLLER LATCH STRIKES



SK1180C1 Cast Roller Strike
1 7/8" x 1 1/4"



SK980W2 Wrought Roller Strike
4 7/8" x 1 1/4"



SK980W1 Wrought Roller Strike
2 3/4" x 1 1/4"



SK980C1 Cast Roller Strike
2 1/4" x 1 11/16"

PIVOTS

3/4" Offset Pivots



MP1 Top Pivot



MP4 Heavy Duty Floor Pivot

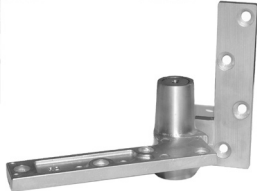

MP2 Bottom Pivot



MP3 Intermediate Pivot

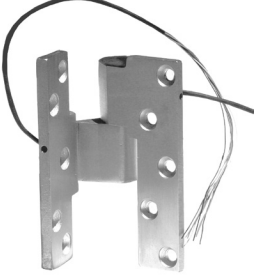

EMP3 Electrified Intermediate Pivot

DUST PROOF STRIKES

DP150 Dust Proof Strike (Floor &/or Thresh)
 1 3/8" X 2 7/8"
 1" Barrel Diameter



DP150L Dust Proof Strike
 1 3/8" X 2 7/8"
 1" Barrel Diameter



DP100 Dust Proof Strike (Threshold Only)

COORDINATOR





T200 Gravity Coordinator 7"
T300 Gravity Coordinator 9"
 5 1/2" X 1 1/8"



SURFACE BOLTS

SB103 Concealed Surface Bolt 3"
SB104 Concealed Surface Bolt 4"
SB106 Concealed Surface Bolt 6"
 1" Projection
 1" Throw



SB206 Concealed Surface Bolt 6"
SB209 Concealed Surface Bolt 9"
SB212 Concealed Surface Bolt 12"
 1" Projection
 1" Throw



FLUSH BOLTS

FB850 Extension Flush Bolt
 1" X 6 3/4" Face Plate
 3/4" Throw



FB951 Extension Flush Bolt
 1" X 6 3/4" Face Plate
 3/4" Throw
 Wood Door



FB875 Extension Flush Bolt
 1 1/4" X 6 3/4" Face Plate
 3/4" Throw







SURFACE BOLTS



SB428 Surface Strap Bolt 8"
SB4212 Surface Strap Bolt 12"(not shown)
 1/4" x 3/4" Bolt Size
 1" Bolt Throw





SB435 Surface Strap Bolt 5"
 1/4" x 3/4" Bolt Size
 1" Bolt Throw



SB538L Locking Surface Strap Bolt 8"
 1 5/8" Projection 1" Throw

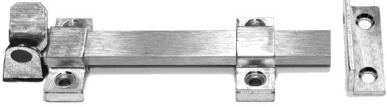

SB438 Surface Strap Bolt 8"
 1 5/8" Projection 1" Throw

SB538 Concealed Surface Bolt
 1 5/8" Projection 1" Throw



FLUSH BOLTS

FB600 Residential Flush Bolts
 1/2" Bolt Head Diameter
 1" Throw



FB600R Residential Flush Bolts
 1/2" Bolt Head Diameter
 1" Throw



SECURITY DOOR GUARDS



DG354 Security Door Guard
4 3/4" Arm



DG354EG Door Edge Guard

EDGE PULLS

EP636 Concealed Edge Pull
1" X 4 1/4" X 7/16" Size



EP465 Brass Edge Pull
3 7/8" x 3/4" x 1 5/8" Size



FLUSH PULLS

FC500 Cast Flush Pull 1 7/8" X 3"
1/8" Projection
(not shown)

FC600 Cast Flush Pull 2 1/2" x 4"
1/8" Projection

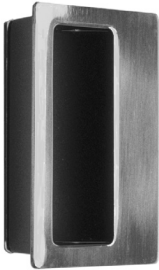
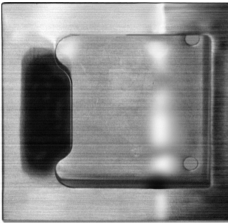

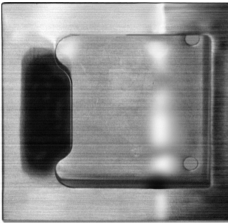

ADA

FC1460 Stainless Steel Flush Pull
Surface Mount 5" X 5"



R20 Brass Flush Pull
2-1/2" Diameter





R30 Brass Flush Pull w/Ring
2-1/2" Diameter

WARDROBE HOOKS



H250 Coat & Hat Hook
2-1/4" Height
3-1/16" Projection



H245 Hook
3-5/8" Height
3-1/16" Projection



H256 Hook
1-1/4" Height
2-1/4" Projection



H265 Triple Hook
5" Height
3-1/16" Projection



H255 Hook
1-11/16" Height
1-5/8" Projection



H260 Hook
2" Height
1-3/4" Projection



H270 Hook
7" Height
3-11/16" Projection



H275 Wardrobe Hook
3" Width
1" Projection



H280 Ceiling Hook
2-1/4" Height
3-1/4" Width

DOOR KNOCKERS & VIEWER

DK676 Door Knocker
DK676V Available w/Viewer



DV150V Door Viewer



DK150V Door Knocker w/Viewer
2 3/16" x 3 1/4" Knocker Size



SOLID DOOR PULLS - ALUMINUM, BRASS, or STAINLESS STEEL

	STRAIGHT DOOR PULL- 1" DIAMETER					
	Part No.	Materials	Projection	CTC	Overall	
	2A	1" Rnd	2 3/4"	8"	9"	
	2C	1" Rnd	2 3/4"	10"	11"	
	2E	1" Rnd	2 3/4"	12"	13"	
	STRAIGHT PULL SETS- 1" DIAMETER					
	Part No.	Materials	Projection	CTC	Overall	
	2AS	1" Rnd	2 3/4"	8"	9"	
	2CS	1" Rnd	2 3/4"	10"	11"	
	2ES	1" Rnd	2 3/4"	12"	13"	
OFFSET DOOR PULL- 1" DIAMETER						
Part No.	Materials	Projection	CTC	Overall	Offset	
4B	1" Rnd	2 3/4"	9"	10"	2 3/4"	
4C	1" Rnd	2 3/4"	10"	11"	2 3/4"	
4E	1" Rnd	2 3/4"	12"	13"	2 3/4"	
OFFSET PULL SETS- 1" DIAMETER						
Part No.	Materials	Projection	CTC	Overall	Offset	
4BS	1" Rnd	2 3/4"	9"	10"	2 3/4"	
4CS	1" Rnd	2 3/4"	10"	11"	2 3/4"	
4ES	1" Rnd	2 3/4"	12"	13"	2 3/4"	
CUSTOM "C" PULL- 1" DIAMETER						
Part No.	Materials	Projection	CTC	Overall	Offset	
C12E	1" Rnd	3"	12"	13"	8"	
OFFSET DOOR PULL- 1-1/4" DIAMETER						
Part No.	Materials	Projection	CTC	Overall	Offset	
M4E	1-1/4" Rnd	3-1/4"	12"	13-1/4"	5"	
M4K	1-1/4" Rnd	3-1/4"	18"	19-1/4"	5"	

1" DIAMETER SOLID PUSH BAR & PULL SETS

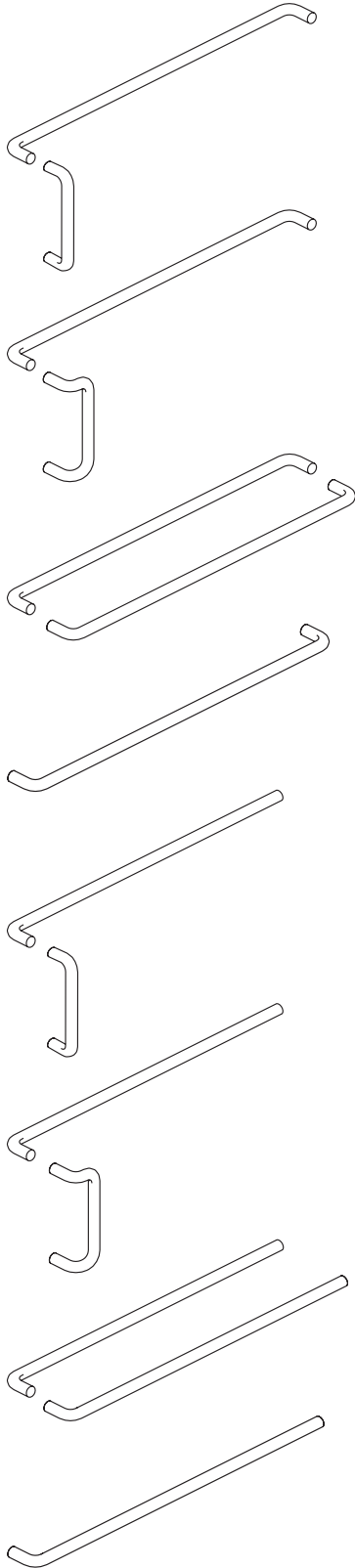

STRAIGHT PULL & DOUBLE BEND PUSH BAR SET

HANDLE/STRAIGHT CTC	DOUBLE BEND PUSH BAR CTC WITH 2-1/4" PROJECTION		
	33"	39"	VARIABLE
8"	2A233	2A239	2A23V
10"	2C233	2C239	2C23V
12"	2E233	2E239	2E23V

OFFSET PULL & DOUBLE BEND PUSH BAR SET

HANDLE/OFFSET CTC	DOUBLE BEND PUSH BAR CTC WITH 2-1/4" PROJECTION		
	33"	39"	VARIABLE
9"	4B233	4B239	4B23V
10"	4C233	4C239	4C23V
12"	4E233	4E239	4E23V

DOUBLE BEND PUSH BAR SET

DOUBLE BEND PUSH BAR CTC WITH 2-1/4" PROJECTION		
33"	39"	VARIABLE
233S	239S	23VS

DOUBLE BEND PUSH BAR

DOUBLE BEND PUSH BAR CTC WITH 2-1/4" PROJECTION		
33"	39"	VARIABLE
233	239	23V

STRAIGHT PULL & SINGLE BEND PUSH BAR SET

HANDLE/STRAIGHT CTC	SINGLE BEND PUSH BAR CTC WITH 2-1/4" PROJECTION		
	33"	39"	VARIABLE
8"	2A133	2A139	2A13V
10"	2C133	2C139	2C13V
12"	2E133	2E139	2E13V

OFFSET PULL & SINGLE BEND PUSH BAR SET

HANDLE/OFFSET CTC	SINGLE BEND PUSH BAR CTC WITH 2-1/4" PROJECTION		
	33"	39"	VARIABLE
9"	4B133	4B139	4B13V
10"	4C133	4C139	4C13V
12"	4E133	4E139	4E13V

SINGLE BEND PUSH BAR SET

SINGLE BEND PUSH BAR CTC WITH 2-1/4" PROJECTION		
33"	39"	VARIABLE
133S	139S	13VS

SINGLE BEND PUSH BAR

SINGLE BEND PUSH BAR CTC WITH 2-1/4" PROJECTION		
33"	39"	VARIABLE
133	139	13V



STRAIGHT DOOR PULL- 1" DIAMETER

Part No.	Materials	Projection	CTC	Overall
TG2A	1" Rnd	2 3/4"	8"	9"
TG2C	1" Rnd	2 3/4"	10"	11"
TG2E	1" Rnd	2 3/4"	12"	13"

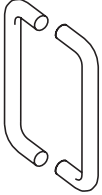

STRAIGHT PULL SETS- 1" DIAMETER

Part No.	Materials	Projection	CTC	Overall
TG2AS	1" Rnd	2 3/4"	8"	9"
TG2CS	1" Rnd	2 3/4"	10"	11"
TG2ES	1" Rnd	2 3/4"	12"	13"

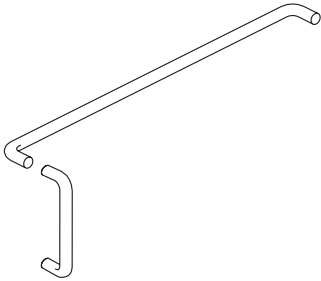

STRAIGHT PULL & DOUBLE BEND PUSH BAR SET

HANDLE/STRAIGHT CTC	DOUBLE BEND PUSH BAR CTC WITH 2-1/4" PROJECTION 27"	39"
8"	TG2A227	2A239
10"	TG2C227	2C239
12"	TG2E227	2E239

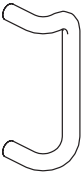

OFFSET DOOR PULL- 1" DIAMETER

Part No.	Materials	Projection	CTC	Overall	Offset
T4B	1" Rnd	2 3/4"	9"	10"	2 3/4"
T4C	1" Rnd	2 3/4"	10"	11"	2 3/4"
T4E	1" Rnd	2 3/4"	12"	13"	2 3/4"

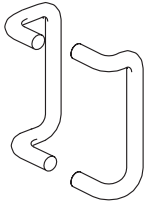

OFFSET PULL SETS- 1" DIAMETER

Part No.	Materials	Projection	CTC	Overall	Offset
T4BS	1" Rnd	2 3/4"	9"	10"	2 3/4"
T4CS	1" Rnd	2 3/4"	10"	11"	2 3/4"
T4ES	1" Rnd	2 3/4"	12"	13"	2 3/4"

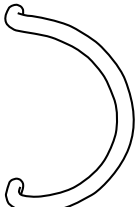

CUSTOM "C" PULL- 1" DIAMETER

Part No.	Materials	Projection	CTC	Overall	Offset
TC12E	1" Rnd	3"	12"	13"	8"

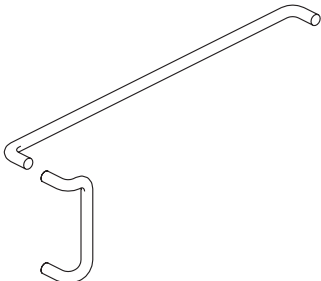

OFFSET PULL & DOUBLE BEND PUSH BAR SET

HANDLE/OFFSET CTC	DOUBLE BEND PUSH BAR CTC WITH 2-1/4" PROJECTION 33"
9"	T4B233
10"	T4C233
12"	T4E233

DOOR PULLS

Solid Brass, Bronze, Aluminum, and Stainless Steel

Solid Extruded
Brass, Aluminum,
and Stainless Steel



RP675
3/4" Round
2 3/8" Projection
6" CTC
6 3/4" Overall

Also available:
RP875-8"

RP1075-10"



FP625
3/8" X 1 1/4" Half Round
1 7/8" Projection
6" CTC
6 3/8" Overall

Also available:
FP825-8"



CP850
2" Projection
5 1/2" CTC
7 1/2" Overall



CP550
2" Projection
5 1/2" CTC
6 1/4" Overall



CP600
2" Projection
5 1/2" CTC
6" Overall



HP1000
ADA Hospital Grip
3 1/4" Projection
5 1/4" CTC
8 3/4" Overall

ADA

OVERHEAD DOOR HOLDER/STOP

9M SERIES Replacement for 9-90-900-9000 SERIES HOLDER

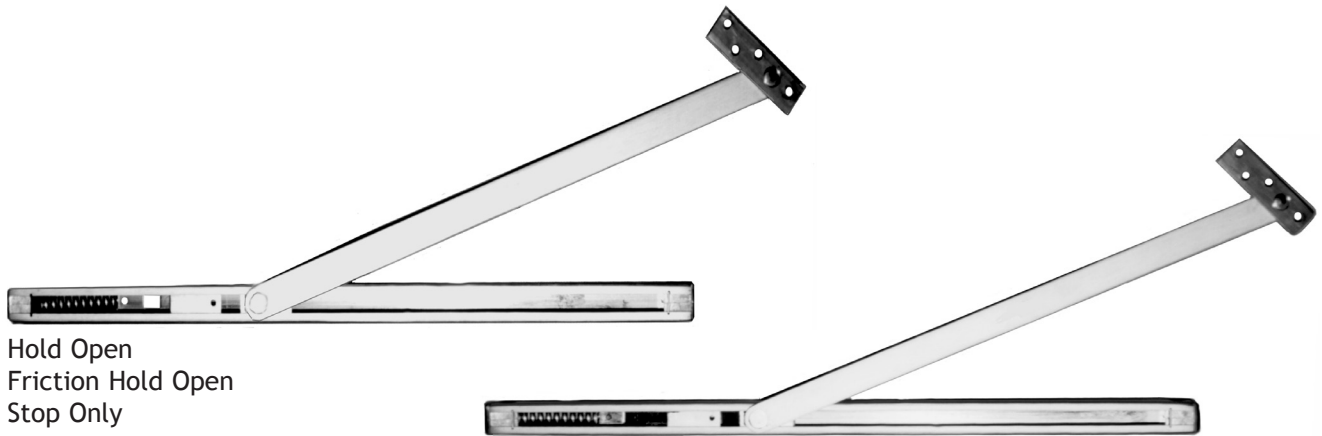

Hold Open
Friction Hold Open
Stop Only

Surface Overhead Door Holder/Stop
Heavy Duty Interior/Exterior Applications



Established in 1985, the Harnisch Company is a leading manufacturer of architectural door hardware. We specialize in supplying leading OEM manufacturers throughout North America, Europe, and Asia.

Products include:

- UL listed flush and surface bolts
- Handles and push bars
- Heavy-duty 3/4" offset pivots
- Overhead holders
- Wall and floor stops
- Roller latches



Grade One Cycle Testing



We manufacture our products to meet or exceed AAMA, BHMA, and ANSI specifications. Additionally, we produce many types of custom designed, patented, and proprietary products.

Our emphasis on quality products is supported by our state of the art equipment and facilities. Tooling capabilities include: forging, investment casting, stamping, bending and extruding. We provide US Code and BHMA finishes. Our anodizing facility yields class one electrolytically deposited finishes that meet or exceed AAMA 611-98 specifications.