

**ResMed**

Product Information Guide Winter 2017

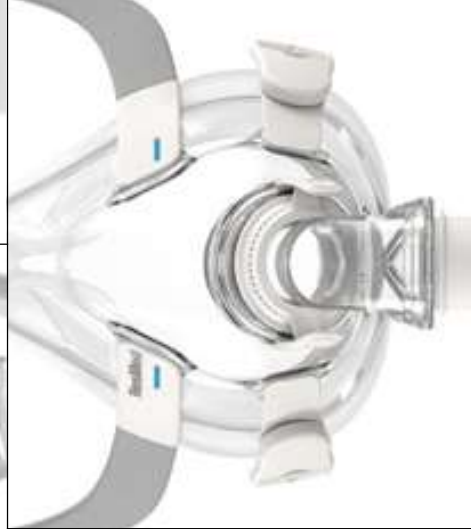

**ResMed.com**

\*Combined responses of those expressing a preference in an independent patient survey in the USA, UK, Germany, France & Australia, from April to May 2015. Visit [ResMed.com/MaskBrand](http://ResMed.com/MaskBrand).

# CPAP and APAP devices

## DEVICE LINEUP



### HCPCS codes for ResMed's CPAP/APAP devices

CODE	PRODUCT	REPLACEMENT SCHEDULE
E0601	CPAP	Mo. rental rate
A4604	Tubing w/ integrated heating	1 per 3 months
A7037	Tubing	1 per 3 months
A7038	Filter, disposable	2 per month
A7046	Humidifier chamber – replacement	1 per 6 months
A9279	Monitoring feature/device	Contact payor
E0562	Humidifier – heated	Contact payor

# CPAP

## AirSense™ 10 series



### AirSense™ 10 Elite

The AirSense 10 Elite is indicated for the treatment of obstructive sleep apnea (OSA) in patients weighing more than 66 lbs (30 kg). It is intended for home and hospital use.

- Premium CPAP therapy device with integrated humidifier, integrated cellular connectivity, patient access to myAir™ program, AutoRamp™ with sleep onset detection and EPR™ with Easy-Breathe technology
- Provides advanced event detection, including central sleep apnea and Cheyne–Stokes respiration detection, and RERA reporting as well as remote diagnostic information in AirView™ software
- Optional ClimateLineAir™ tubing with swivel connector and pulse oximetry monitoring

	US	Canada
AirSense 10 Elite with HumidAir™	<b>37205</b>	<b>37400</b>
AirSense 10 Elite with HumidAir and ClimateLineAir	<b>37206</b>	<b>37401</b>



### AirSense™ 10 CPAP

The AirSense 10 CPAP is indicated for the treatment of obstructive sleep apnea (OSA) in patients weighing more than 66 lbs (30 kg). It is intended for home and hospital use.

- Basic CPAP therapy device with integrated humidifier, integrated cellular connectivity, patient access to myAir™ program, AutoRamp™ with sleep onset detection and EPR™ with Easy-Breathe technology
- Provides usage-compliance data, AHI and leak data reporting, and access to remote diagnostic information in AirView software
- Optional ClimateLineAir™ tubing with swivel connector

	US	Canada
AirSense 10 CPAP with HumidAir	<b>37203</b>	<b>37398</b>
AirSense 10 CPAP with HumidAir and ClimateLineAir	<b>37204</b>	<b>37399</b>

# APAP

## AirSense™ 10 series



### AirSense™ 10 AutoSet™

The AirSense 10 AutoSet (self-adjusting) is indicated for the treatment of obstructive sleep apnea (OSA) in patients weighing more than 66 lbs (30 kg). It is intended for home and hospital use.

- Advanced AutoSet™ therapy device with integrated humidifier, integrated cellular connectivity, patient access to myAir™ program, AutoRamp™ with sleep onset detection, EPR™ with Easy-Breathe technology and AutoSet™ Response comfort setting
- Provides advanced event detection, including central sleep apnea and Cheyne–Stokes respiration detection, and RERA reporting, as well as remote diagnostic information in AirView™ software
- Optional ClimateLineAir™ tubing with swivel connector and pulse oximetry monitoring

AirSense 10 AutoSet with HumidAir™	US	Canada
-----	<b>37207</b>	<b>37402</b>
AirSense 10 AutoSet with HumidAir and ClimateLineAir	<b>37208</b>	<b>37403</b>



### AirSense™ 10 AutoSet™ for Her

The AirSense 10 AutoSet for Her (self-adjusting) is indicated for the treatment of obstructive sleep apnea (OSA) in patients (female patients with mild to moderate OSA when using AutoSet for Her treatment mode) weighing more than 66 lbs (30 kg). It is intended for home and hospital use.

- Advanced AutoSet therapy device with an FDA-cleared, dedicated AutoSet algorithm for female patients with mild to moderate OSA
- Includes integrated humidifier, integrated cellular connectivity, patient access to myAir™ program, AutoRamp™ with sleep onset detection, EPR™ with Easy-Breathe technology and AutoSet™ Response comfort setting
- Provides advanced event detection, including central sleep apnea and Cheyne–Stokes respiration detection, RERA reporting and access to remote diagnostic information in AirView software
- Optional ClimateLineAir™ tubing with swivel connector and pulse oximetry monitoring

AirSense 10 AutoSet for Her with HumidAir	US	Canada
-----	<b>37209</b>	<b>37404</b>
AirSense 10 AutoSet for Her with HumidAir and ClimateLineAir	<b>37210</b>	<b>37405</b>





# Bilevel devices

DEVICE LINEUP



## ResMed E0470 and E0471 devices

E0470-Bilevel without a backup rate:

- AirCurve™ 10 VA Auto
- AirCurve™ 10 S
- VPAP™ CPD

E0471-Bilevel with a backup rate:

- AirCurve 10 ST
- AirCurve 10 ASV
- AirCurve 10 ST-A

## HCPSC codes for ResMed's bilevel devices

CODE	PRODUCT	REPLACEMENT SCHEDULE
E0470	Bilevel	Mo. rental rate*
E0471	Bilevel w/ backup rate – non-invasive	Mo. rental rate*
A4604	Tubing w/ integrated heating	1 per 3 months
A7037	Tubing	1 per 3 months
A7038	Filter disposable	2 per month
A7046	Humidifier chamber – replacement	1 per 6 months
A9279	Monitoring feature/device	Contact payor
E0562	Humidifier – heated	Contact payor

\* Rate reduces 25% after third month

## Bilevel AirCurve™ 10 series



### AirCurve™ 10 S

The AirCurve 10 S is indicated for the treatment of obstructive sleep apnea (OSA) in patients weighing more than 66 lbs (30 kg). It is intended for home and hospital use.

- Fixed-pressure bilevel device that is ideal for non-compliant CPAP patients
- Features integrated humidifier, integrated cellular connectivity, patient access to myAir™ program, Easy-Breathe waveform, Vsync leak compensation, adjustable TiControl™, trigger and cycle sensitivity
- Provides advanced event detection and reporting, as well as access to remote diagnostic information in AirView™ software
- Optional ClimateLineAir™ tubing with swivel connector and pulse oximetry monitoring

AirCurve 10 S with HumidAir™	US	Canada
-----	<b>37213</b>	<b>37408</b>
AirCurve 10 S with HumidAir and ClimateLineAir	-----	-----
	<b>37214</b>	



### AirCurve™ 10 VAuto

The AirCurve 10 VAuto is indicated for the treatment of obstructive sleep apnea (OSA) in patients weighing more than 66 lbs (30 kg). It is intended for home and hospital use.

- Auto-adjusting bilevel that uses the AutoSet™ algorithm and natural comfort of the Easy-Breathe waveform to treat non-compliant CPAP patients
- Features integrated humidifier, integrated cellular connectivity, patient access to myAir™ program and a variety of technologies that improve therapy comfort
- Provides advanced event detection and reporting, as well as access to remote diagnostic information in AirView software
- Optional ClimateLineAir™ tubing with swivel connector and pulse oximetry monitoring

AirCurve 10 VAuto with HumidAir	US	Canada
-----	<b>37211</b>	<b>37406</b>
AirCurve 10 VAuto with HumidAir and ClimateLineAir	-----	-----
	<b>37212</b>	

# Bilevel

## AirCurve™ 10 series



### AirCurve™ 10 ASV

The AirCurve 10 ASV is indicated for the treatment of patients weighing more than 66 lbs (30 kg) with obstructive sleep apnea (OSA), central and/or mixed apneas, or periodic breathing. It is intended for home and hospital use.

- Adaptive servo-ventilator targeting patients' recent minute ventilation
- Features integrated humidifier, integrated cellular connectivity (including access to remote diagnostic information in AirView™ software) and patient access to myAir™ program, Easy-Breathe waveform and Vsync leak compensation
- Choice of fixed EPAP in ASV mode or auto-adjusting EPAP in ASV/Auto mode
- Optional ClimateLineAir™ tubing with swivel connector and pulse oximetry monitoring

	US	Canada
AirCurve 10 ASV with HumidAir™	<b>37215</b>	<b>37410</b>
AirCurve 10 ASV with HumidAir and ClimateLineAir	<b>37216</b>	

ASV therapy is contraindicated in patients with chronic, symptomatic heart failure (NYHA 2-4) with reduced left ventricular ejection fraction (LVEF ≤ 45%) and moderate to severe predominant central sleep apnea.



### AirCurve™ 10 ST

The AirCurve 10 ST is indicated for the treatment of obstructive sleep apnea (OSA) in patients weighing more than 66 lbs (30 kg). It is intended for home and hospital use.

- Bilevel device with backup rate that provides exceptional patient-ventilator synchrony so patients remain comfortable and well-ventilated, reducing the work of breathing
- Ideal choice for reliable, cost-effective and non-invasive ventilation, when alarms are not required
- Provides event detection and reporting, integrated cellular connectivity and patient access to myAir™ program, as well as access to remote diagnostic information in AirView™ software
- Optional ClimateLineAir™ tubing with swivel connector and pulse oximetry monitoring

	US	Canada
AirCurve 10 ST with HumidAir	<b>37306</b>	<b>37412</b>
AirCurve 10 ST with HumidAir and ClimateLineAir	<b>37307</b>	

ASV therapy is contraindicated in patients with chronic, symptomatic heart failure (NYHA 2-4) with reduced left ventricular ejection fraction (LVEF ≤ 45%) and moderate to severe predominant central sleep apnea.

# Bilevel

Non-invasive ventilation (NIV)



## VPAP™ COPD

The VPAP COPD is indicated to provide non-invasive ventilation for patients weighing more than 30 lbs (13 kg) with respiratory insufficiency such as that associated with hypercapnic chronic obstructive pulmonary disease (COPD) or obstructive sleep apnea (OSA). It is intended for home and hospital use.

- Customized therapy settings make it easy to initiate therapy
- Integrated oxygen entrainment support provides oxygen and warmed, humidified air in one line
- Configurable audio and visual alarms provide added security
- Custom therapy settings optimized for COPD

S9VPAP COPD	36034
S9VPAP COPD + H5i	36044
S9VPAP COPD + H5i and ClimateLine MAX Oxy tubing	36054



## AirCurve™ 10 ST-A

The AirCurve 10 ST-A is indicated to provide non-invasive ventilation for patients weighing more than 30 lbs (13 kg) with respiratory insufficiency or obstructive sleep apnea (OSA). It is intended for home and hospital use.

- Homecare NIV device optimized to treat patients with respiratory insufficiency
- Features iVAPS™ mode, which is designed to maintain a target alveolar ventilation by automatically adjusting pressure support
- Features integrated humidifier, integrated cellular connectivity (including access to remote diagnostic information in AirView™ software) and patient access to myAir™ program
- FDA-cleared for patients weighing more than 30 lbs (13 kg), or more than 66 lbs (30 kg) in iVAPS mode

AirCurve 10 ST-A with HumidAir™	US	Canada
AirCurve 10 ST-A with HumidAir and ClimateLineAir	28210	28219
	28211	

# Accessories

Air10™ humidification and filters

## HumidAir™ humidifier: Integrated humidifier for Air10 devices

Humidification is delivered in one easy-to-use system. Enhanced Auto option with default temperature and humidity settings pre-set at levels designed to deliver optimal comfort.



**37299** HumidAir standard tub  
**37300** HumidAir cleanable tub



**37296** ClimateLineAir heated tubing  
**37357** ClimateLineAir Oxy tubing  
**36810** SlimLine™ tubing



**37335** HumidAir side cover – gray  
(AutoSet for Her, S, VAuto, ST, ASV)  
**37303** HumidAir side cover – charcoal  
(CPAP, Elite, AutoSet, STA)



Filters – standard  
**36850** (1 pk) **36851** (2 pk)  
**36852** (12 pk) **36853** (50 pk)  
Filters – hypoallergenic  
**36855** (1 pk) **36856** (2 pk)  
**36857** (12 pk) **36858** (50 pk)  
Filter cover  
**19768** Gray  
(AutoSet for Her, AirCurve)  
**19729** Charcoal  
(CPAP, Elite, AutoSet)



# Accessories

## S9™ humidification and filters

### H5i™

- Integrates seamlessly with the S9
- Sleek and stylish design
- Easy-to-use operation and data management display
- Climate Control system automatically adjusts to environmental conditions for maximum comfort



**36900** H5i + standard chamber  
**36803** H5i water chamber (standard)



**36901** H5i + cleanable chamber  
**36800** H5i water chamber (cleanable)



**36995** ClimateLine™ tubing  
**36996** ClimateLine MAX Oxy tubing



Filters – standard  
**36850** (1 pk) **36851** (2 pk)  
**36852** (12 pk) **36853** (50 pk)  
 Filters – hypoallergenic  
**36855** (1 pk) **36856** (2 pk)  
**36857** (12 pk) **36858** (50 pk)

# Accessories

## Power

### ResMed Power Station (RPS) II kits

- All-in-one pack that provides power to ResMed ventilators and sleep therapy devices
- Provides up to 13 hours of run time on a single charge
- Weighs only 2 lbs and can be easily transported in the RPS II carry bag
- Ideal for travel or when additional mobility and freedom are required



RPS II kit for Stellar™ **249002**

RPS II kit for S9 **249004**

RPS II kit for Air10 **249009**

RPS II cable for Air10 **37343**

RPS II adapter for Air10 **37342**

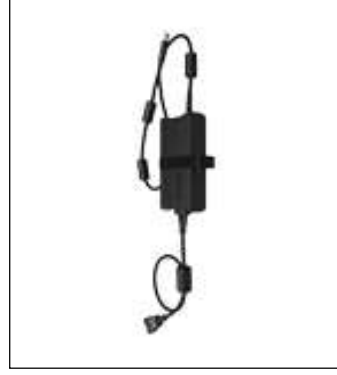

**37344** 90W PSU (Air10)



**37297** DC/DC Converter  
(Air10)



**36920** 30W PSU (S9)  
**36821** 90W PSU (S9)



**36970** DC/DC Converter (S9)

# Accessories

## Data management and oximetry



SD card protective folder

**37329** with card (10 pk)

**37330** without card (10 pk)

**36931** SD card reader



**369100** S9 complete  
oximetry kit



**36950** S9 USB adapter



**36940** S9 Oximeter adapter



**37302** Air10 oximetry module

**22374** XPOD LP oximeter

**22371** XPOD LP clip

**707560** Reusable soft sensor  
(medium) – 3 m cable

**370004** Air10 Oximetry

Complete Kit: Includes  
oximetry module, XPOD,  
XPOD clip, reusable soft  
sensor (medium)

# Limited warranty information

## For ResMed products

ResMed Ltd (hereafter 'ResMed') warrants that your ResMed product shall be free from defects in material and workmanship from the date of purchase for the period specified below.

Product	Warranty Period
<ul style="list-style-type: none"> <li>• Mask systems (including mask frame, cushion, headgear and tubing) – excluding single-use devices</li> <li>• Accessories – excluding single-use devices</li> <li>• Flex-type finger pulse sensors</li> <li>• Humidifier water tubs</li> </ul>	90 days
<ul style="list-style-type: none"> <li>• Batteries for use in ResMed internal and external battery systems</li> </ul>	6 months
<ul style="list-style-type: none"> <li>• Clip-type finger pulse sensors</li> <li>• CPAP and bilevel device data modules</li> <li>• Oximeters and CPAP and bilevel device oximeter adapters</li> <li>• Humidifier cleanable water tubs</li> <li>• Titration control devices</li> </ul>	1 year
<ul style="list-style-type: none"> <li>• CPAP, bilevel and ventilation devices (including external power supply units)</li> <li>• Humidifiers</li> <li>• Battery accessories</li> <li>• Portable diagnostic/screening devices</li> </ul>	2 years

This warranty is only available to the initial consumer. It is not transferable. If the product fails under conditions of normal use, ResMed will repair or replace, at its option, the defective product or any of its components.

This Limited Warranty does not cover: a) any damage caused as a result of improper use, abuse, modification or alteration of the product; b) repairs carried out by any service organization that has not been expressly authorized by ResMed to perform such repairs; and c) any damage or contamination due to cigarette, pipe, cigar or other smoke.

Warranty is void on product sold, or resold, outside the region of original purchase.

Warranty claims on defective product must be made by the initial consumer at the point of purchase.

This warranty replaces all other expressed or implied warranties, including any implied warranty of merchantability or fitness for a particular purpose. Some regions or states do not allow limitations on how long an implied warranty lasts, so the above limitation may not apply to you.

ResMed shall not be responsible for any incidental or consequential damages claimed to have resulted from the sale, installation or use of any ResMed product. Some regions or states do not allow the exclusion or limitation of incidental or consequential damages, so the above limitation may not apply to you.

This warranty gives you specific legal rights, and you may also have other rights which vary from region to region. For further information on your warranty rights, contact your local ResMed dealer or ResMed office.

# Recommended setup and resupply schedules

Initial setup (1st month supplies)      Compliance follow-up (2nd and 3rd month supplies)      Quarterly outreach contact (“Every 3 months” supplies)

Masks	Initial setup (1st month supplies)			Compliance follow-up (2nd and 3rd month supplies)			Quarterly outreach contact (“Every 3 months” supplies)		
	QTY	ITEM	HCPCS	QTY	ITEM	HCPCS	QTY	ITEM	HCPCS
Full face masks	1	Mask	A7030	2	Cushions	A7031	1	Mask	A7030
	1	Headgear	A7035				1	Tubing	A7037
	1	Tubing	A7037				6	Filters	A7038
	6	Filters	A7038				2	Cushions	A7031
	1	Mask	A7034	4	Cushions	A7032	1	Mask	A7034
	1	Headgear	A7035				1	Tubing	A7037
Nasal masks	1	Tubing	A7037				6	Filters	A7038
	6	Filters	A7038				5	Cushions	A7032
	1	Cushion	A7032						
	1	Mask	A7034	4	Pillows	A7033	1	Mask	A7034
Nasal pillows masks	1	Headgear	A7035				1	Tubing	A7037
	1	Tubing	A7037				6	Filters	A7038
	6	Filters	A7038				5	Pillows	A7033
	1	Pillow	A7033						

\* Remind your non-Medicare patients to check with their insurance companies for reimbursement eligibility.

\*\* Replacement schedule is based on Centers for Medicare and Medicaid Services (CMS) Local Coverage Determination for positive airway pressure (PAP) devices for the treatment of obstructive sleep apnea.

## Premium mask selector

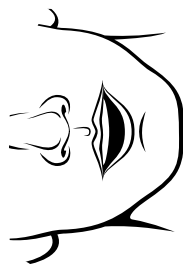

If the patient breathes through their **mouth** while sleeping:



Select the **AirFit™ F20** full face mask.



Select the **AirFit™ F20 for Her** full face mask.

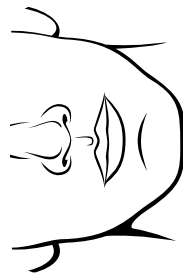

If the patient breathes through their **nose** while sleeping:



Select the **AirFit™ N20** nasal mask.



Select the **AirFit™ P10** nasal pillows mask.

Ask about masks designed especially **for Her**.

Premium mask selector



# Full face masks

MASK LINEUP



**Mirage Quattro™**  
**Mirage Quattro™ for Her**



**Quattro™ Air**  
**Quattro™ Air for Her**



**AirFit™ F10**  
**AirFit™ F10 for Her**



**AirTouch™ F20**  
**AirFit™ F20 for Her**



## HCPCS codes for ResMed's full face masks\* (excluding Mirage Liberty)

CODE	PRODUCT	REPLACEMENT SCHEDULE
A7030	Full face mask frame system	1 per 3 months
A7031	Full face mask cushion – replacement	1 per month
A7035	Headgear	1 per 6 months

## HCPCS codes for ResMed's Mirage Liberty\*

CODE	PRODUCT	REPLACEMENT SCHEDULE
A7027	Oral/nasal mask frame system	1 per 3 months
A7028	Oral cushion replacement for oral/nasal mask	2 per month
A7029	Nasal pillow replacement for oral/nasal mask	2 per month
A7035	Headgear	1 per 6 months

OTHER MASKS INCLUDE:  
**Mirage Liberty™**  
**Quattro™ FX**

\* The Medicare schedule states how often accessories can be replaced if medically necessary. Check with all payors directly to verify current coverage requirements and policies.

For all legacy mask information, visit [ResMed.com/MaskGuide](https://www.resmed.com/MaskGuide).

# AirTouch F20/AirTouch F20 for Her

## Full face mask

### Quick fitting guide

When it comes to effective sleep therapy, comfort is key. That's why the AirTouch F20 features the ResMed UltraSoft™ memory foam cushion, a breakthrough in CPAP mask comfort technology. This innovative new cushion conforms to the unique contours of each face for a truly personalized fit. It is also designed to deliver a light, breathable seal across a range of therapy pressures and reduce facial markings and potential skin irritation. Featuring a modular frame, you can conveniently switch between the AirTouch F20 UltraSoft™ and AirFit F20 InfinitySeal™ cushions until you find the best option for each patient.

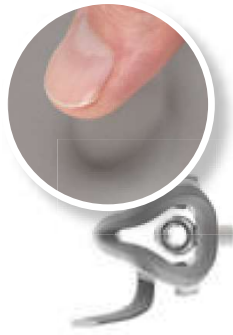

- Start by ensuring the magnets on the lower straps are unclipped.
- If they are clipped, detach them by twisting and pulling them away from the frame.



- Pull the headgear over the patient's head making sure the logo is facing outwards.



- Position the lower straps so they both sit below the patient's ears.
- Bring each of the magnets up to meet their corresponding clips on the frame.



- Adjust the fastening tabs on the upper straps until the mask feels even and stable.
- Reattach the fastening tabs.



- Repeat step 4 with the lower straps.
- Reattach the fastening tabs.



- Connect the device's air tube to the elbow, then click the elbow into the front of the mask.
- Start the device.

myAir™ Compatible with myAir™ patient engagement program when paired with most Air10™ devices.

Refer to the user guide for further instructions and complete labeling information including indications, contraindications, warnings and precautions.

# AirTouch F20/AirTouch F20 for Her

## Full face mask

### Systems and components

#### AirTouch F20

##### Complete mask system

- Small 63000**  
Includes frame, small cushion, elbow, soft sleeves and standard blue headgear with headgear clips
- Medium 63001**  
Includes frame, medium cushion, elbow, soft sleeves and standard blue headgear with headgear clips
- Large 63002**  
Includes frame, large cushion, elbow, soft sleeves and standard blue headgear with headgear clips

#### AirTouch F20 for Her

##### Complete mask system

- Small 63003**  
Includes frame, small cushion, elbow, soft sleeves and small lavender headgear with headgear clips
- Medium 63004**  
Includes frame, medium cushion, elbow, soft sleeves and small lavender headgear with headgear clips

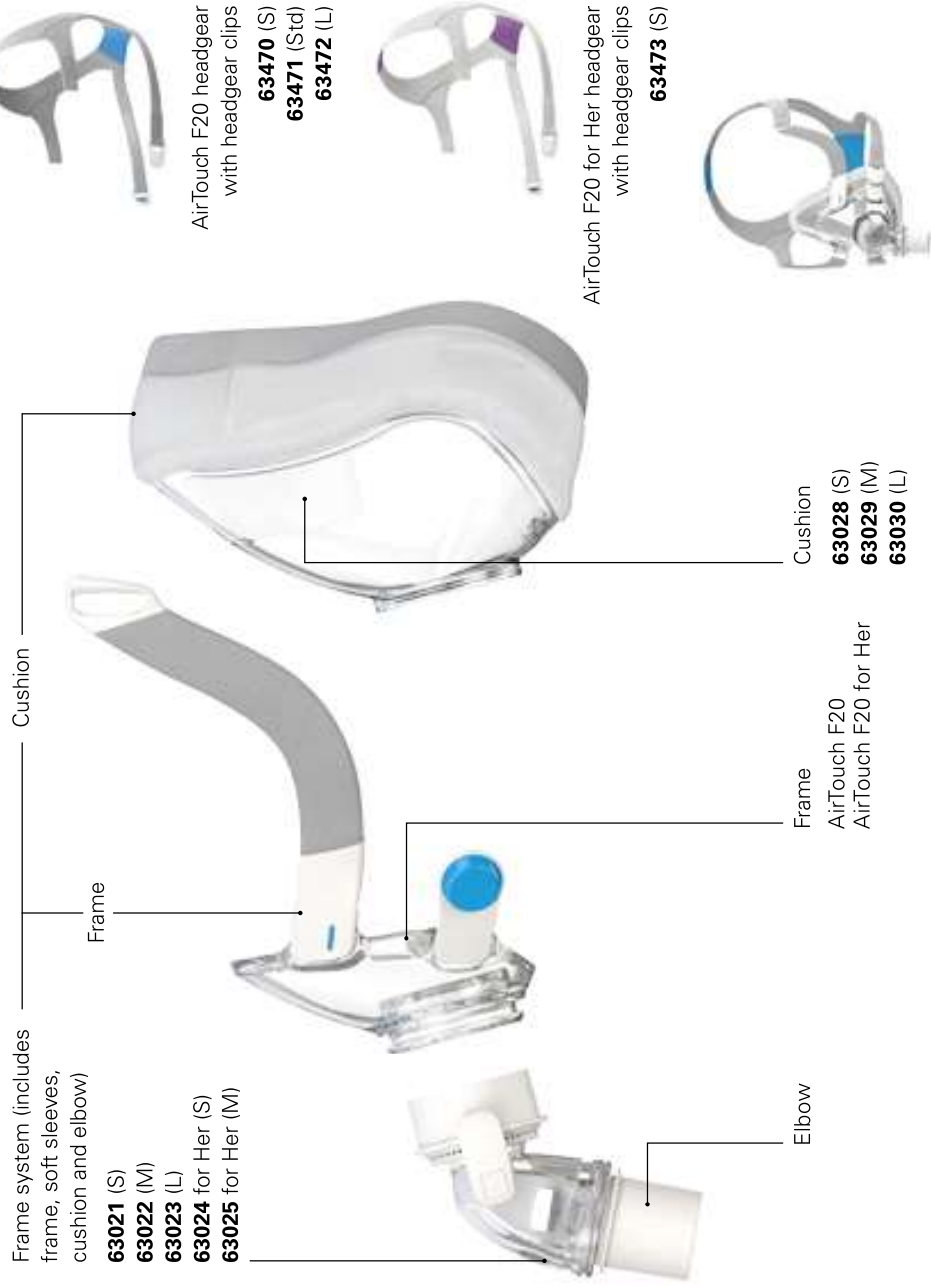

# AirFit F20/AirFit F20 for Her

## Full face mask

### Quick fitting guide

Finding the right mask fit for a broad range of patients can be challenging. That's why we created the AirFit™ 20 series – masks that are specially-designed to fit all patients, regardless of facial profile. The AirFit F20 is designed to perform across a wide range of therapy pressures, and fit a remarkable 97% of patients in a recent international fitting study.<sup>1,3</sup>



- Start by ensuring the magnets on the lower straps are unclipped.
- If they are clipped, detach them by twisting and pulling them away from the frame.



- Hold the mask to the face, ensuring the top of the mask is aligned with the top of the nasal bridge.
- Pull the headgear over the head, making sure the logo is facing outward.



- Position the lower straps so they both sit below the ears.
- Bring each of the magnets up to meet their corresponding clips on the frame.



- Adjust the fastening tabs on the upper straps until the mask feels even and stable.
- Reattach the fastening tabs.



- Repeat step 4 with the lower straps.
- Reattach the fastening tabs.



- Connect the device's air tube to the elbow, then click the elbow into the front of the mask.
- Start the device.

1 ResMed AirFit F20 internal Australian fitting study of existing CPAP patients conducted between March–April 2016.

2 ResMed AirFit F20 internal USA fitting study of existing CPAP patients conducted April 2016.

3 ResMed AirFit F20 internal EU and APAC fitting study of existing CPAP patients conducted June 2016.

**myAir™** Compatible with myAir™ patient engagement program when paired with most Air10™ devices.

Refer to the user guide for further instructions and complete labeling information including indications, contraindications, warnings and precautions.

# AirFit F20/AirFit F20 for Her

## Full face mask

### Systems and components

#### AirFit F20

##### Complete mask system

- Small 63400**  
Includes frame, small cushion, elbow, soft sleeves and standard blue headgear with headgear clips
- Medium 63401**  
Includes frame, medium cushion, elbow, soft sleeves and standard blue headgear with headgear clips
- Large 63402**  
Includes frame, large cushion, elbow, soft sleeves and standard blue headgear with headgear clips

#### AirFit F20 for Her

##### Complete mask system

- Small 63403**  
Includes frame, small cushion, elbow, soft sleeves and small lavender headgear with headgear clips
- Medium 63404**  
Includes frame, medium cushion, elbow, soft sleeves and small lavender headgear with headgear clips

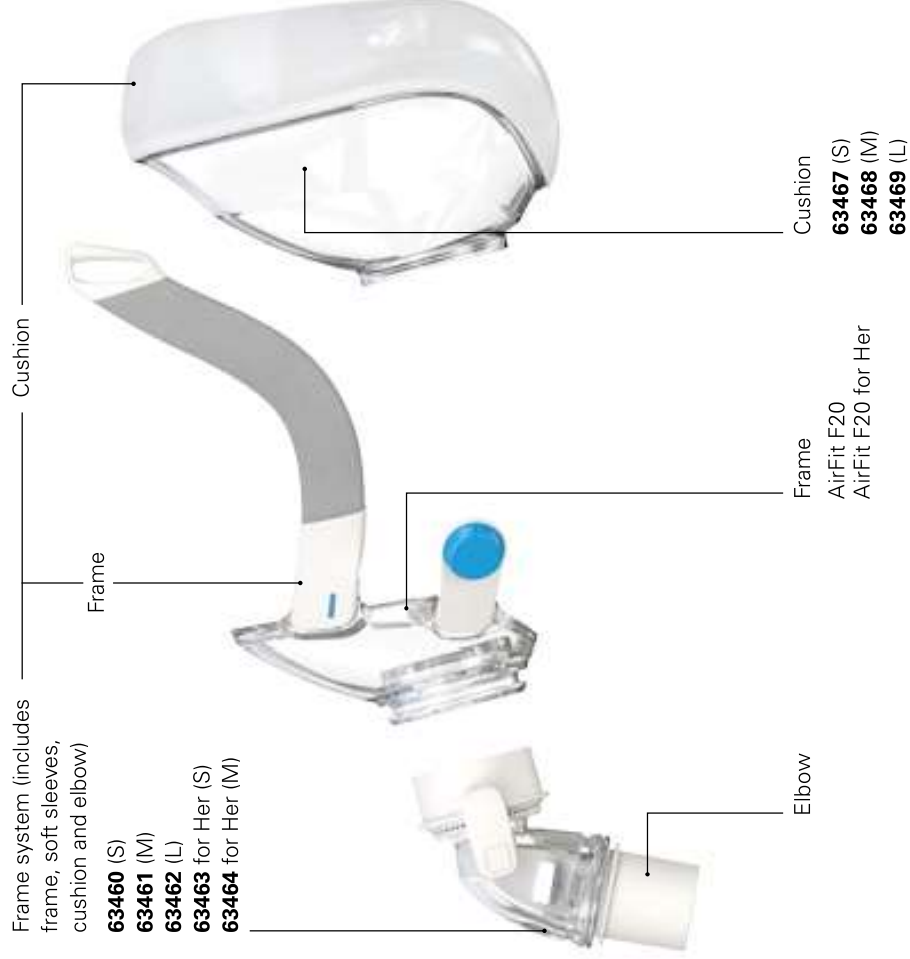



# AirFit F10/AirFit F10 for Her

## Full face mask

### Quick fitting guide

#### Visual freedom

- Delivers full face benefits in a compact offering with no forehead support – giving patients a clear line of sight.

#### Superior comfort

- The dual-wall Spring Air™ cushion fits comfortably and is designed to provide an optimal seal.
- Circular diffused venting directs exhaled air away – creating a quiet, peaceful sleeping environment.

#### Proven performance

- The unique frame and headgear work together to provide stability and performance.

#### Ease of use

- It's fast and easy to fit patients thanks to the mask's simple four-part design.

**Note:** Prior to fitting the mask, remove the **orange frame support** from the headgear and discard.

Refer to the user guide for further instructions and complete labeling information including indications, contraindications, warnings and precautions.

**myAir™** Compatible with myAir™ patient engagement program when paired with most Air10™ devices.



- Remove the elbow from the mask by pressing the side buttons and pulling it out.



- Take off the lower headgear straps and hold the cushion to the face. Align the bottom with the crease of the chin and the top with the corner of the eye.
- Then pull the headgear over the head.

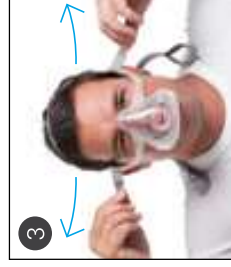

- Undo the fastening tabs on the upper headgear straps.
- Adjust both straps evenly until the mask feels stable, then reattach the tabs.



- Bring the lower straps below the ears and loop the headgear into the lower hooks on each side of the frame.

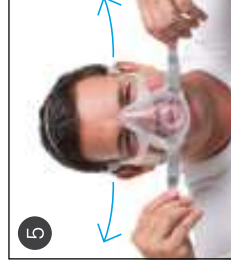

- Adjust the lower headgear straps evenly until the mask feels stable.
- The fitting should be firm yet comfortable. Do not overtighten.



- Connect device air tubing to the elbow to the mask by pressing in the side buttons, then push it into the mask.
- Turn on the device so it blows air.
- The patient now lies down to make any final adjustments if required.

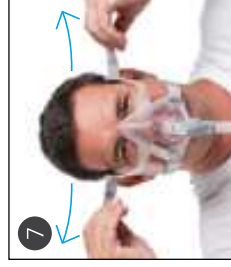

- Undo the tabs on the upper headgear straps.
- Reposition both straps evenly, only enough so a seal is achieved, then reattach the tabs.
- The mask is now ready to use.



- Optional soft sleeves may be assembled for even more comfort on the cheeks.



# AirFit F10/AirFit F10 for Her

Full face mask

**AirFit™ F10**

## Systems and components

### AirFit F10

#### Complete mask system

- Small 63101**  
Includes frame, small cushion, elbow with swivel, soft sleeves and standard blue headgear
- Medium 63102**  
Includes frame, medium cushion, elbow with swivel, soft sleeves and standard blue headgear
- Large 63103**  
Includes frame, large cushion, elbow with swivel, soft sleeves and standard blue headgear

### AirFit F10 for Her

#### Complete mask system

- X-Small 63139**  
Includes frame, x-small cushion, elbow with swivel, soft sleeves and small pink headgear
- Small 63140**  
Includes frame, small cushion, elbow with swivel, soft sleeves and small pink headgear
- Medium 63141**  
Includes frame, medium cushion, elbow with swivel, soft sleeves and small pink headgear

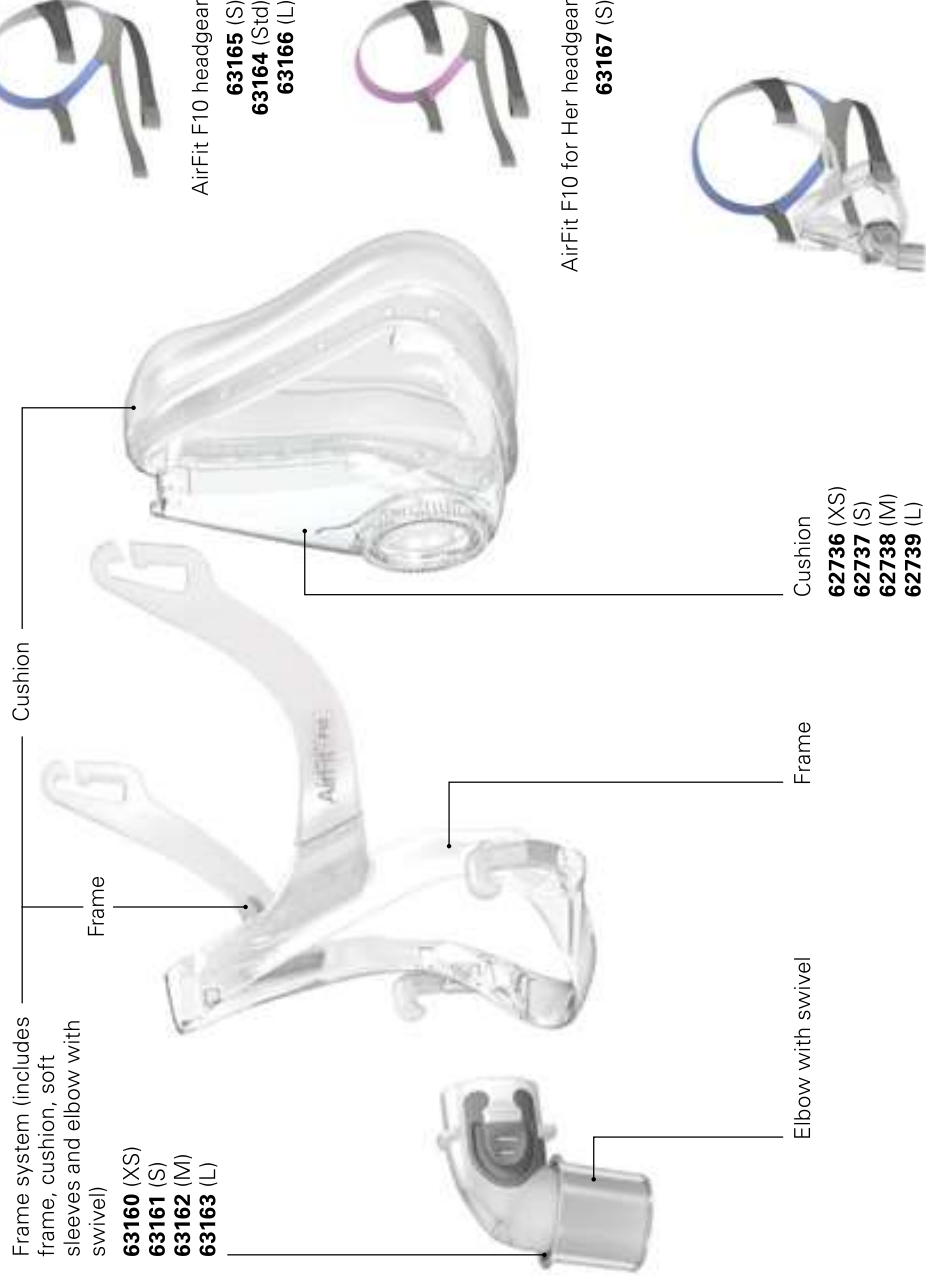

# Quattro Air/Quattro Air for Her

## Full face mask

### Quick fitting guide

#### Even more comfort

- 45% lighter than Mirage Quattro.
- Flex-wing forehead support feels light and comfortable.
- Enhanced dual-wall cushion is designed to deliver a high-performance seal.
- SoftEdge™ headgear design with premium rolled-edge fabric is designed to reduce facial marks.

#### Quick and easy setups

- Only four parts makes it fast to demonstrate and easy to train patients.
- Easy one-piece elbow with squeeze-tabs makes attaching and detaching quicker and easier.
- Headgear loops simplify attachment.

#### Improved patient usability

- Greatly reduced complexity with improved comfort and stability lowers patient callbacks.
- Light, streamlined and comfortable design helps patients accept therapy.

#### Fitting tips

- When fitting the mask, ensure that the base of the cushion sits at the crease of the patient's chin. Then swing the mask upwards towards the patient's nose.
- Be careful not to overtighten when adjusting the headgear straps.

Refer to the user guide for further instructions and complete labeling information including indications, contraindications, warnings and precautions.

**myAir™** Compatible with myAir™ patient engagement program when paired with most Air10™ devices.



- Remove the elbow from the mask by pressing in the side buttons and pulling it away. Make sure that both lower headgear straps are released.
- Ensure the base of the cushion sits in the crease of the chin and swing the mask up towards the nose, then pull the headgear over the head.



- Adjust both straps of the upper headgear evenly until the mask is stable.



- Bring the lower straps below the ears and loop the headgear into the lower hooks on the frame.



- Adjust the lower headgear straps evenly until the mask is stable.
- The fitting should be firm yet comfortable.
- Do not overtighten.



- Connect the air tubing from device to the elbow.
- Attach the elbow to the mask by pressing the side buttons and pushing the elbow into the mask.
- Turn on the device so it blows air.
- The patient lies down to make any final adjustments if required.



- Lift the mask away from the face a short distance, then put it back in position. Ensure the lower part of the cushion sits in the crease of the chin.
- Undo the fastening tabs on the upper headgear straps. Reposition both the straps evenly, only enough until a seal is achieved, then reattach the tabs.

# Quattro Air/Quattro Air for Her

## Full face mask

### Systems and components

#### Quattro Air Complete mask system

- Small 62701**  
Includes frame, small cushion, elbow with swivel and standard blue headgear
- Medium 62702**  
Includes frame, medium cushion, elbow with swivel and standard blue headgear
- Large 62703**  
Includes frame, large cushion, elbow with swivel and standard blue headgear

#### Quattro Air for Her Complete mask system

- X-Small 62740**  
Includes frame, x-small cushion, elbow with swivel and small pink headgear
- Small 62741**  
Includes frame, small cushion, elbow with swivel and small pink headgear
- Medium 62742**  
Includes frame, medium cushion, elbow with swivel and small pink headgear

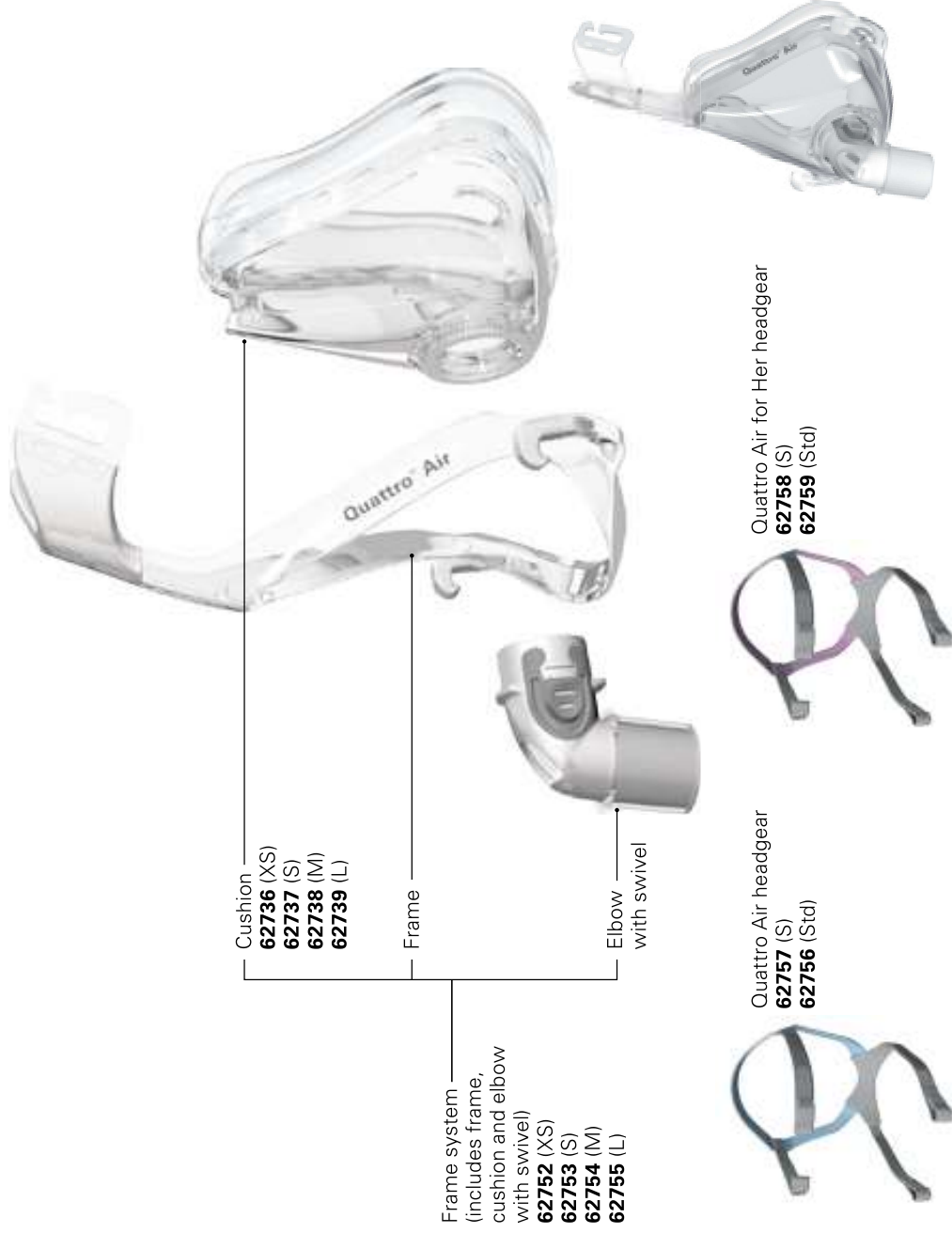

# Mirage Quattro

## Full face mask

### Quick fitting guide

#### Perfect fit

- Cushion and MicroFit dial combine to enhance seal.
- Four sizes available.

#### Personalized comfort

- Mirage dual-wall cushion with Spring Air Technology™.
- Contoured cushion at the chin area allows for jaw drop and movement.

#### Light, quiet and easy to use

- Improved built-in vents for quieter, diffused exhalation.
- Simplified elbow with an anti-asphyxia valve (AAV).
- Cushion clip with tabs for easy removal.

#### Fitting tips

- While the device is turned on, pull the mask away from the face to re-inflate the cushion; then adjust the headgear straps.
- Do not overtighten headgear straps.

myAir™ Compatible with myAir™ patient engagement program when paired with most Air10™ devices.



- Turn the MicroFit dial to position 24, where the forehead support is fully extended.



- Disconnect one headgear clip, place the mask on the face and pull the headgear over the head.



- Bring the lower straps below the ears.
- Fasten the lower headgear clip, ensuring that it clicks into place.



- Unfasten the Velcro tabs and pull the upper headgear straps evenly until comfortable.
- Do not overtighten the straps.



- Unfasten the Velcro tabs and pull the lower headgear straps evenly until comfortable.
- Do not overtighten the straps.



- Connect the main air tubing to the swivel.
- Turn on the flow generator.
- Turn the MicroFit dial until the mask is evenly and comfortably positioned on the face.
- If any air leaks are felt, re-adjust the headgear.

Refer to the user guide for further instructions and complete labeling information including indications, contraindications, warnings and precautions.

# Mirage Quattro

## Full face mask

### Systems and components

#### Complete mask system<sup>1</sup>

Extra Small **61200**  
 Small **61201**  
 Medium **61202**  
 Large **61203**

#### Frame system<sup>2</sup>

(no headgear)  
 Extra Small **61260**  
 Small **61261**  
 Medium **61262**  
 Large **61263**

#### Frame assembly<sup>2</sup>

(no headgear, no cushion)  
 Extra Small **61264**  
 Small **61265**  
 Medium **61266**  
 Large **61267**

#### Headgear

(no clips)  
 Small **16118**  
 Standard **16117**  
 Large **16119**

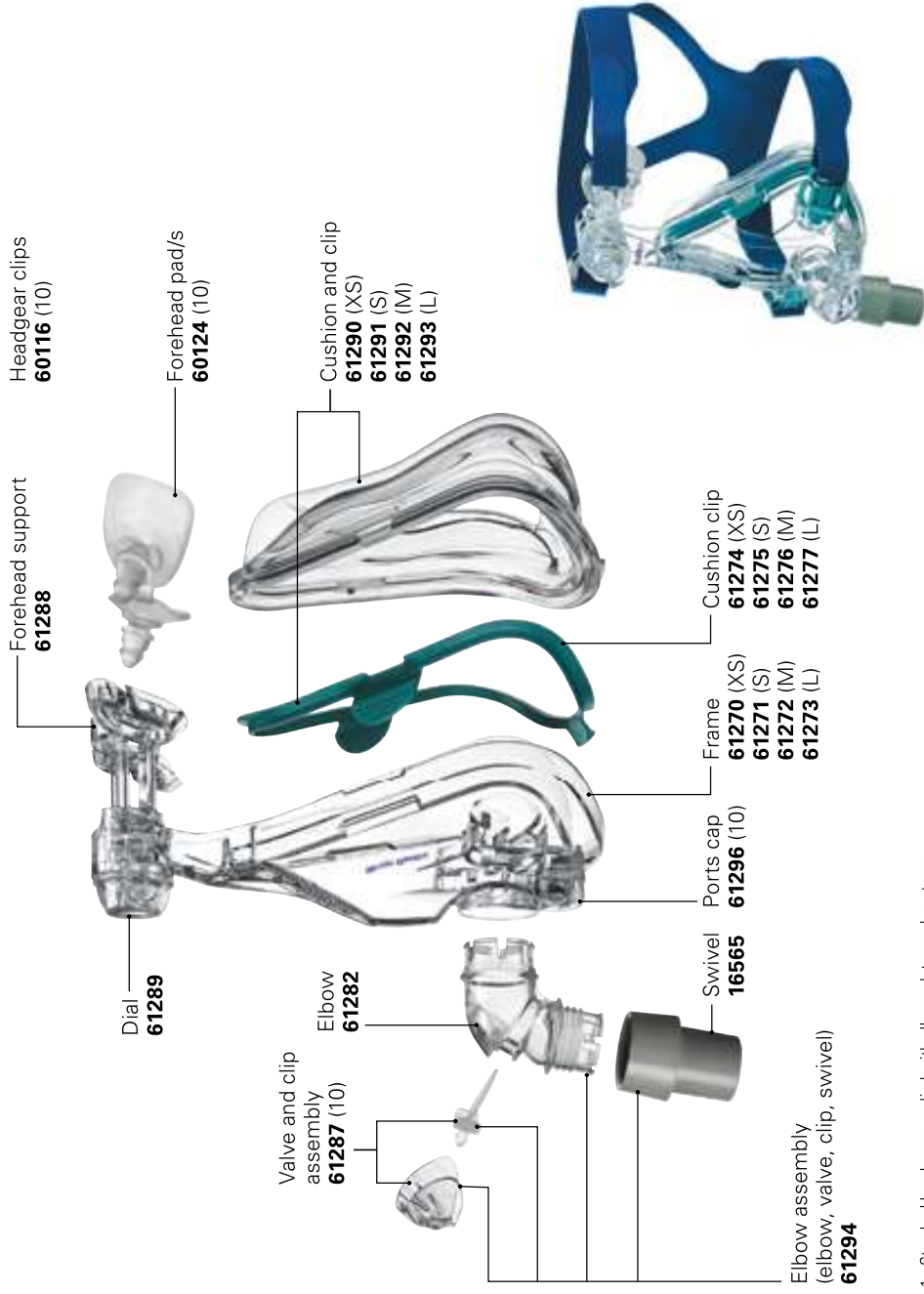

<sup>1</sup> Standard headgear supplied with all complete mask systems

<sup>2</sup> Includes headgear clips



# Mirage Liberty

## Full face mask

### Quick fitting guide

#### Less mask, more freedom

- Combines the mouth cushion and nasal pillows for free field of vision.
- Less contact with the skin, reducing chance of irritation.

#### Comfort meets performance

- Supportive headgear with stabilizing elements provides stability and comfort.
- New dual-wall pillows with trampoline action are designed to maintain seal in the nares.

#### Make it easier

- Minimal parts for easy cleaning and assembly.
- Increased fit range.

#### Fitting tips

- While the device is turned on, pull the mask away from the face to re-inflate the cushion; then adjust the headgear straps.
- Do not overtighten headgear straps.



- Place the headgear on the head and pull the mask forward onto the face.
- Make sure the headgear fits evenly on top of the head.



- Fit the mask over the mouth.
- Insert the pillows so they sit gently at the entrance to the nares.
- Fasten the lower headgear clips, ensuring they click into place.



- Adjust the upper headgear straps.
- Do not overtighten the straps.



- Adjust the lower headgear straps.
- Alternate adjustment of upper and lower straps until a comfortable and even fit is obtained.
- Do not overtighten the straps.

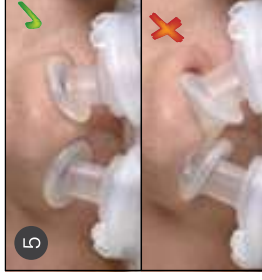

- Check that the pillows are correctly positioned at the entrance to the nostrils.



- Connect the air tubing to the swivel and the elbow to the mask frame. Ensure that they click into place.
- Turn on the flow generator.
- If any air leaks are felt, re-adjust the headgear.

myAir™ Compatible with myAir™ patient engagement program when paired with most Air10™ devices.

Refer to the user guide for further instructions and complete labeling information including indications, contraindications, warnings and precautions.



# Mirage Liberty

## Full face mask

### Systems and components

#### Complete mask system<sup>1</sup>

Small **61300**  
 Large **61301**

#### Frame system<sup>2</sup>

(no headgear)

#### Cushion Pillows

Small **61318**  
 Medium **61319**  
 Small **61320**  
 Large **61321**  
 Large **61322**  
 Large **61323**

#### Frame assembly<sup>2</sup>

(no headgear, no cushion,  
 no pillows)

Small **61325**  
 Large **61326**

#### Headgear

(no clips)

Small **61348**  
 Standard **61349**

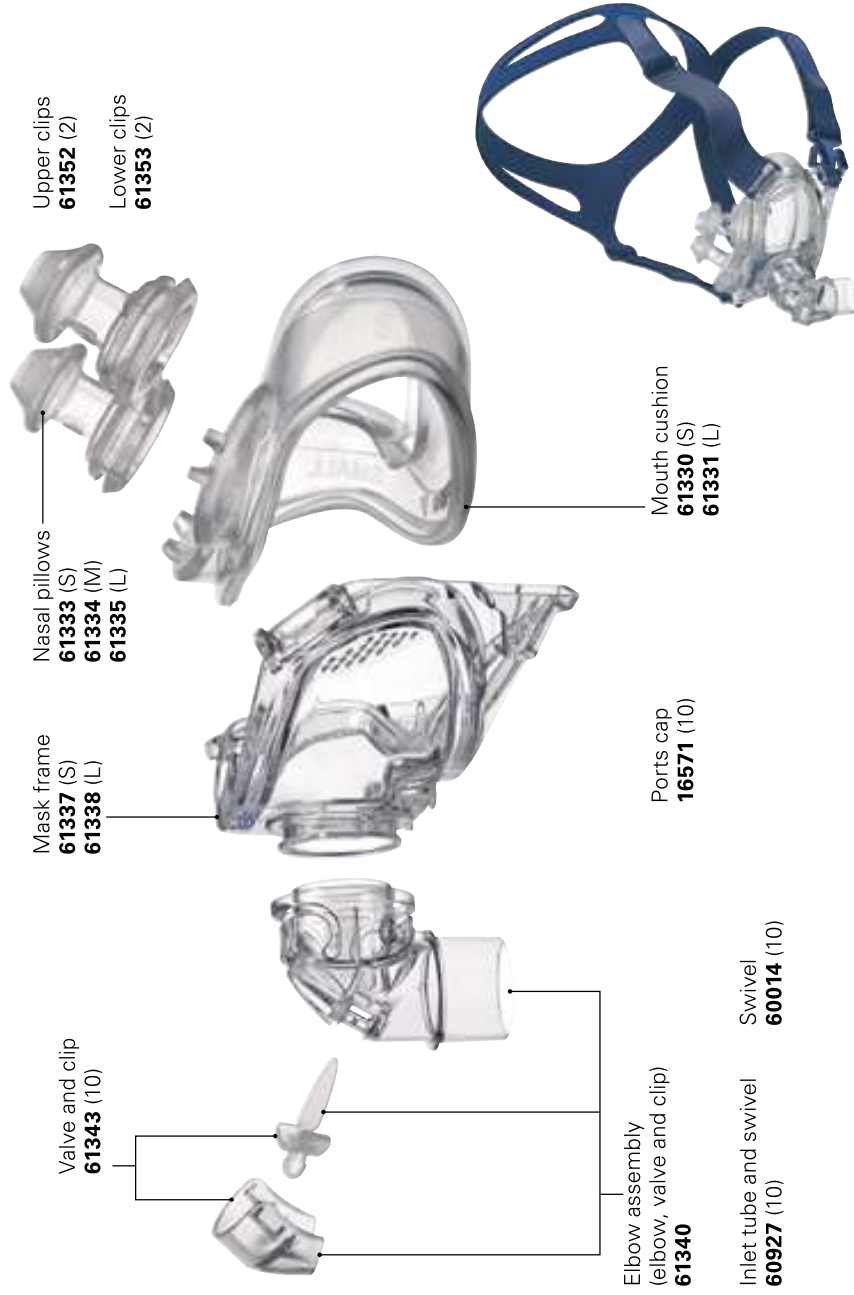

<sup>1</sup> Standard headgear supplied with all complete mask systems

<sup>2</sup> Includes headgear clips

# Quattro FX/Quattro FX for Her

## Full face mask

### Quick fitting guide

#### Easy to fit – the first time and every time

- Sizing tool and swing seal fitting technique help achieve a comfortable, effective seal.
- Seal and fewer adjustment points make it easier to fit and wear.

#### Lightweight frame and unobtrusive design

- Clear line of sight breaks down physical and emotional barriers associated with full face therapy.
- Combination of spring frame and headgear design eliminates the need for forehead support.
- Fewer points of contact with the face reduce chances of skin irritation.

#### Stable performance

- High-tech Spring Air cushion distributes pressure evenly, absorbing even the slightest movements.
- Spring Air cushion and spring frame offer excellent stability and adjustment.

#### Fitting tips

- A custom-made sizing tool is available to size patients.
- Position the cushion at an angle on the nasal bridge, then swing the lower half of the mask down against the face to seal.

Refer to the user guide for further instructions and complete labeling information including indications, contraindications, warnings and precautions.

**myAir™** Compatible with myAir™ patient engagement program when paired with most Air10™ devices.



- With both lower headgear clips released, position the cushion at an angle on the nasal bridge.



- Keeping the upper position of the mask in place, swing the lower half of the mask down against the face.



- Hold the mask firmly against the face and pull the headgear over the head.



- Connect one end of the air tubing to the swivel and the other end to the airflow device.
- Turn on the airflow device.



- Bringing the lower straps below the ears, clip the headgear into the lower part of the spring frame.



- Unfasten the Velcro®, pull the upper headgear straps evenly until they are comfortable and firm, and reattach the Velcro.



- Repeat step 5 with the lower headgear straps.

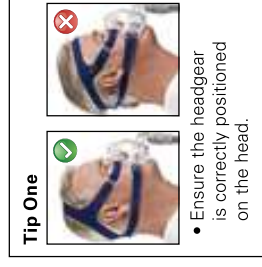

#### Tip One

- Ensure the headgear is correctly positioned on the head.



#### Tip Two

- Ensure the mask sits mid-bridge and does not encroach on the eyes.

**Note:** Prior to fitting the mask, remove the **orange frame support** from the headgear and discard.

# Quattro FX/Quattro FX for Her

## Full face mask

### Systems and components

#### Quattro FX

##### Complete mask system<sup>1</sup>

Small **61700**  
 Medium **61701**  
 Large **61702**

##### Frame system<sup>2</sup>

(headgear clips but no headgear)

Small **61724**  
 Medium **61725**  
 Large **61726**

#### Quattro FX for Her

##### Complete mask system

(standard headgear supplied with Quattro FX for Her complete mask systems)

Small **62501**  
 Medium **62502**

##### Frame system<sup>2</sup>

(headgear clips but no headgear)

Small **62513**  
 Medium **62514**

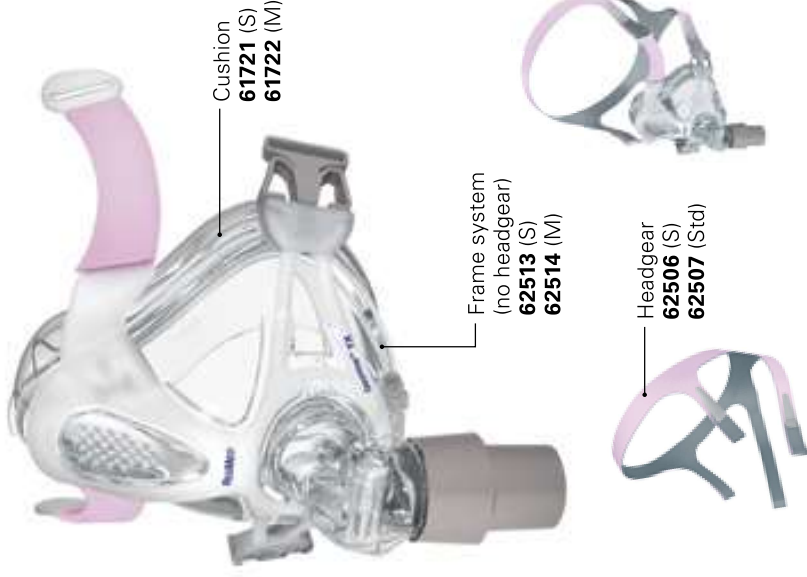

1 Standard headgear supplied with all complete mask systems

2 Includes headgear clips



# Nasal masks

MASK LINEUP



**AirFit™ N20**  
AirFit™ N20 for Her



**AirFit™ N10**  
AirFit™ N10 for Her



**Mirage™ FX**  
Mirage™ FX for Her

**OTHER MASKS INCLUDE:**

- Mirage™ SoftGel**
- Mirage Activa™ LT**
- Swift™ FX Nano**

For all legacy mask information, visit [ResMed.com/MaskGuide](http://ResMed.com/MaskGuide).

**HCPCS codes for ResMed's nasal masks\***

CODE	PRODUCT	REPLACEMENT SCHEDULE
A7034	Nasal mask frame system	1 per 3 months
A7032	Nasal cushion replacement	2 per month
A7035	Headgear	1 per 6 months

\* The Medicare schedule states how often accessories can be replaced if medically necessary. Check with all payors directly to verify current coverage requirements and policies.

# AirFit N20/AirFit N20 for Her Nasal mask

## Quick fitting guide

Everyone's face is different. But with our new AirFit™ 20 series, fitting a broad range of patients has never been easier. That's because each mask has been specially-designed to fit all patients regardless of facial profile, taking the constant guesswork out of mask selection. And with a recent international study showing the AirFit N20 fit 99% of patients<sup>1</sup>, you can trust that it will perform for your diverse group of patients.



- Start by ensuring the magnets on the lower straps are unclipped.
- If they are clipped, detach them by twisting and pulling them away from the frame.



- Pull the headgear over the head, making sure the logo is facing outward.



- Position the lower straps so they both sit below the ears.
- Bring each of the magnets up to meet their corresponding clips on the frame.



- Adjust the fastening tabs on the upper straps until the mask feels even and stable.
- Reattach the fastening tabs.



- Repeat step 4 with the lower straps.
- Reattach the fastening tabs.



- Connect the device's air tube to the elbow, then click the elbow into the front of the mask.
- Start the device.

<sup>1</sup> ResMed AirFit N20 internal international fitting study of new and existing CPAP patients, conducted Nov 2015.

**myAir™** Compatible with myAir™ patient engagement program when paired with most Air10™ devices.

# AirFit N20/AirFit N20 for Her

## Nasal mask

### Systems and components

#### AirFit N20

##### Complete mask system

- Small**  
Includes frame, small cushion, elbow with short tube and standard blue headgear with headgear clips
- Medium**  
Includes frame, medium cushion, elbow with short tube and standard blue headgear with headgear clips
- Large**  
Includes frame, large cushion, elbow with short tube and standard blue headgear with headgear clips

#### AirFit N20 for Her

##### Complete mask system

- Small**  
Includes frame, small cushion, elbow with short tube and small lavender headgear with headgear clips

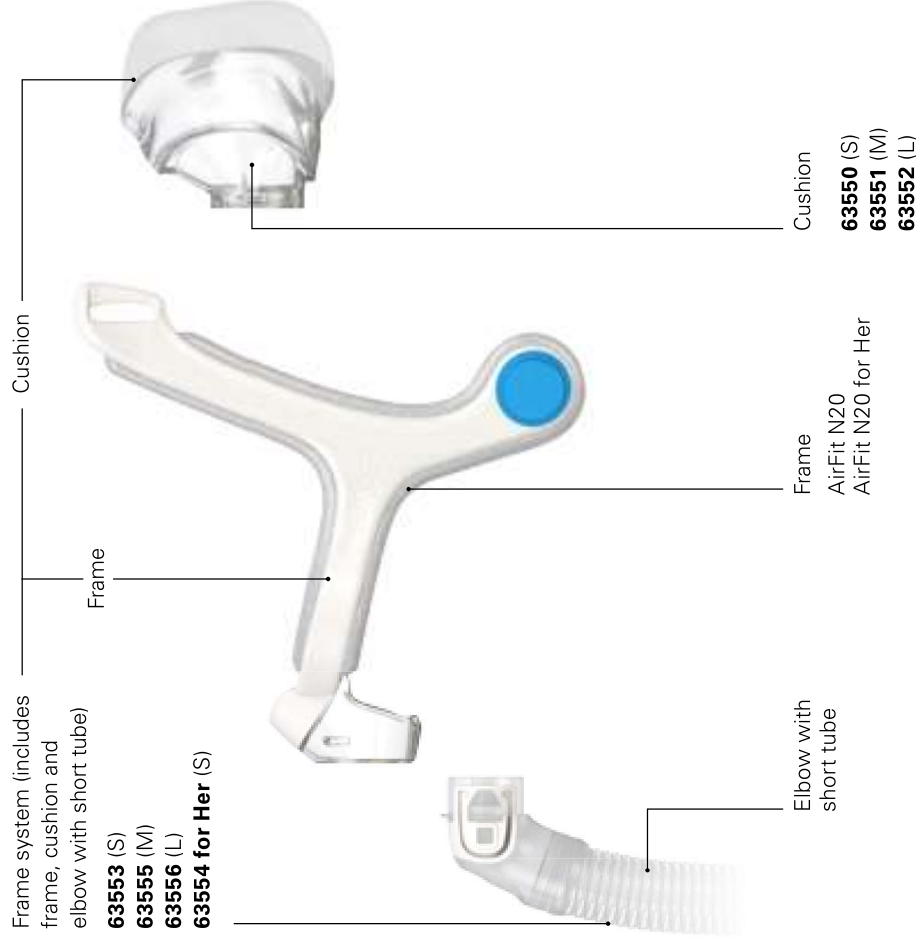



# AirFit N10/AirFit N10 for Her

## Nasal mask

### Quick fitting guide

#### Simplicity

- Self-aligning headgear clips make it simple to put on and take off.
- Intuitive key-clip cushion provides quick and accurate mask assembly.
- Lightweight, durable flexi-tube is integrated into the frame and easily accommodates 360° movement without compromising seal.

#### Comfort

- The modified dual-wall Spring Air™ cushion is designed to deliver a comfortable, high-performance seal.
- SoftEdge™ headgear and optional soft sleeves maximize comfort to deliver patient satisfaction.
- Circular diffused venting gently disperses exhaled air away from the patient and bed partner.

#### Visual freedom

- The mask's unique under-eye frame provides a clear line of sight.

#### Additional options

- Optional soft sleeves may be assembled for enhanced comfort on the cheeks.

**myAir™** Compatible with myAir™ patient engagement program when paired with most Air10™ devices.



- Ensure that the gray side of the headgear that shows the ResMed and AirFit N10 logos is facing outwards.
- Disconnect the lower straps. Line up the bottom of the cushion with the bottom of the nose.



- Place the cushion over the nose.
- Hold the mask against the face.
- Pull the headgear up and over the head.



- Bring the lower straps below the ears and attach the EasyClick clips to the outside of the frame.



- Undo the upper fastening tabs.
- Adjust the straps evenly until the mask sits comfortably just under the nose. Then reattach the fastening tabs so that they align with the upper straps.
- **Tip:** The upper straps are the key adjustments for seal and comfort. Ensure that they are not overtightened.



- Undo the fastening tabs on the lower straps. Adjust both of the straps evenly until the mask is stable, then reattach tabs.
- Connect the mask tubing to the air tubing attached to the device.
- **Tip:** The lower straps require only minimal tension for the mask to fit comfortably.





- Turn on the device so it blows air.
- Adjust the cushion and headgear until the mask sits comfortably on the nose and is not creased or twisted.
- The mask is now ready to use.

# AirFit N10/AirFit N10 for Her

## Nasal mask

### Systems and components

<p><b>AirFit N10 (Small)</b>  <b>Complete mask system</b>          (Complete system includes frame, small cushion, standard blue headgear, soft sleeves and headgear clips)  <b>63229</b></p>	<p>Frame system          (includes frame, cushion, soft sleeves and headgear clips)  <b>63231 (S)</b>  <b>63230 (Std)</b>  <b>63232 (W)</b></p>	<p>Cushion  <b>63241 (S)</b>  <b>63240 (Std)</b>  <b>63242 (W)</b></p>	<p>AirFit N10 headgear  <b>63262 (S)</b>  <b>63260 (Std)</b></p>
<p><b>AirFit N10 (Standard)</b>  <b>Complete mask system</b>          (Complete system includes frame, standard cushion, standard blue headgear, soft sleeves and headgear clips)  <b>63200</b></p>	<p>Frame</p>	<p>AirFit N10 for Her headgear  <b>63261 (S)</b></p>	
<p><b>AirFit N10 (Wide)</b>  <b>Complete mask system</b>          (Complete system includes frame, wide cushion, standard blue headgear, soft sleeves and headgear clips)  <b>63202</b></p>		<p>AirFit N10 for Her headgear  <b>63261 (S)</b></p>	
<p><b>AirFit N10 for Her (Small)</b>  <b>Complete mask system</b>          (Complete system includes frame, small cushion, small pink headgear, soft sleeves and headgear clips)  <b>63201</b></p>		<p>AirFit N10 for Her headgear  <b>63261 (S)</b></p>	

# Mirage FX/Mirage FX for Her Nasal mask

## Quick fitting guide

### One mask fits all

- One single cushion and frame size accommodates nearly all patients.

### Open view and lightweight design

- Slender, lightweight frame is strong enough to maintain stability and flexible enough to accommodate movement.
- Butterfly wing forehead support flexes to allow for a dynamic fit range; the plastic does not contact the skin.
- Compact, unobtrusive design provides a clear field of vision and feeling of lightness.

### Exceptional comfort, instant appeal

- SoftEdge headgear is kind to the face, is designed to reduce marks and discomfort.
- Dual-wall, Spring Air cushion provides even pressure distribution with extra softness at the nasal bridge.
- Diffused vent design disperses air gently and quietly away from the bed partner.

### Effortless and effective

- With just four parts, assembly, wear and care are easier than ever.
- "Wide" and "for Her" versions available to fit greater patient range.
- Flexible forehead support automatically adapts to headgear adjustment for an intuitive, easy fit.

**myAir™** Compatible with myAir™ patient engagement program when paired with most Air10™ devices.



- Prior to fitting the mask, remove the elbow from the mask by pressing the side tabs.



- Connect the elbow to the device air tubing.



- With both lower headgear straps released, hold the mask against the face and pull the headgear over the head.



- Bringing the lower straps below the ears, loop the headgear into the lower hooks on the mask frame.



- Unfasten the straps, pull the upper headgear straps evenly until they are comfortable and firm, and reattach the straps.



- Repeat step 5 with the lower headgear straps.



- Attach the combined elbow assembly and air tubing to the mask by pressing the side-tabs and pushing into the mask frame.
- Turn on the flow generator.

# Mirage FX/Mirage FX for Her Nasal mask

## Systems and components

### Mirage FX Complete mask system

Mirage FX **62103**  
Mirage FX (W) **62118**

### Frame system (no headgear)

Mirage FX **62112**  
Mirage FX (W) **62126**

### Headgear

Mirage FX **62110**  
Mirage FX (S) **62138**

### Mirage FX for Her Complete mask system

Mirage FX for Her **62128**  
Mirage FX  
for Her (S) **62109**

### Frame system (no headgear)

Mirage FX for Her **62112**  
Mirage FX  
for Her (S) **62137**

### Headgear

Mirage FX for Her **62129**

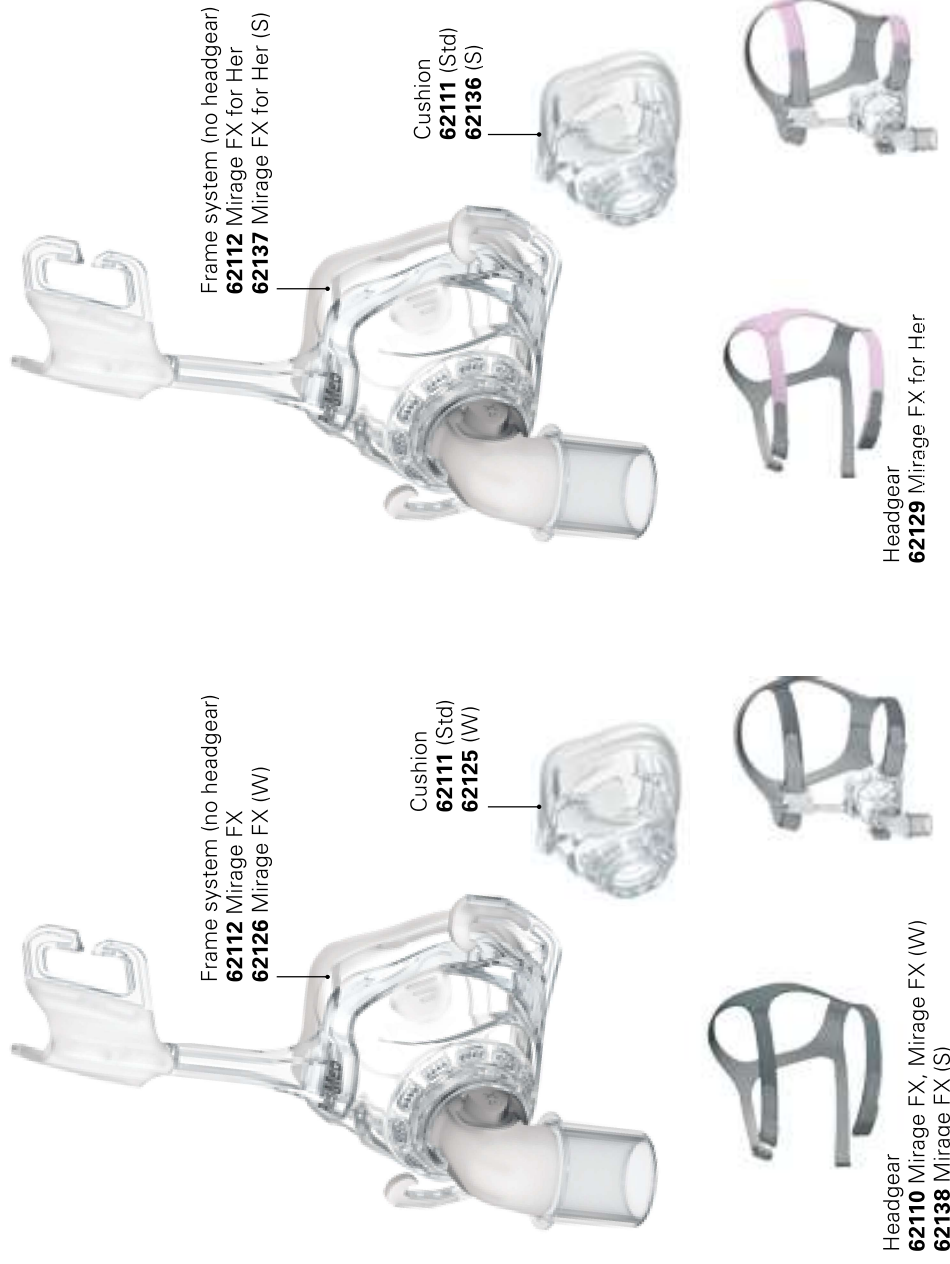

# Mirage SoftGel

## Nasal mask

### Quick fitting guide

#### Personalized comfort

- Unique DoubleGel cushion creates unparallelled softness and comfort.
- Clear gel layer conforms to the unique facial features of each individual, creating the perfect fit.
- Blue gel layer adds stability and support.

#### Customer satisfaction and compliance

- Interchangeable cushions improve patient compliance while avoiding costly mask replacements.
- First-time fit – long-term comfort.

#### Inventory efficiencies

- Interchangeable and shared components promote cost savings.
- A true multi-patient, multi-use mask suitable for repeated use in the lab.

#### Fitting tips

- Adjust the dial to correct leak at the nose.
- Adjust the bottom straps to correct leak at the top lip.
- Do not overtighten headgear straps.



- Turn the MicroFit dial to position 24, so that the forehead support is fully extended.



- Disconnect the lower headgear clip, hold the mask over the nose and pull the headgear over the head.



- Reconnect the lower headgear clip, ensuring that it clicks into place.



- Adjust the upper straps evenly. Do not overtighten.



- Adjust the lower straps to a comfortable position.



- Connect one end of the air tubing to the swivel and the other end to the flow generator.
- Turn on the flow generator.



# Mirage SoftGel

## Nasal mask

### Systems and components

#### Complete mask system<sup>1</sup>

Small **61600**  
 Medium **61601**  
 Large **61602**  
 Large Wide **61603**

#### ConvertAble pack<sup>2</sup>

Small **61604**  
 Medium **61609**  
 Large **61615**  
 Large Wide **61620**

#### Frame system<sup>3</sup> (no headgear)

Small **61626**  
 Medium **61627**  
 Large **61628**  
 Large Wide **61629**

#### Frame assembly<sup>3</sup> (no headgear, no cushion)

Small **60196**  
 Standard **60175**

#### Elbow assembly (elbow, swivel)

**16399**

#### Headgear (no clips)

Small **16118**  
 Standard **16117**  
 Large **16119**

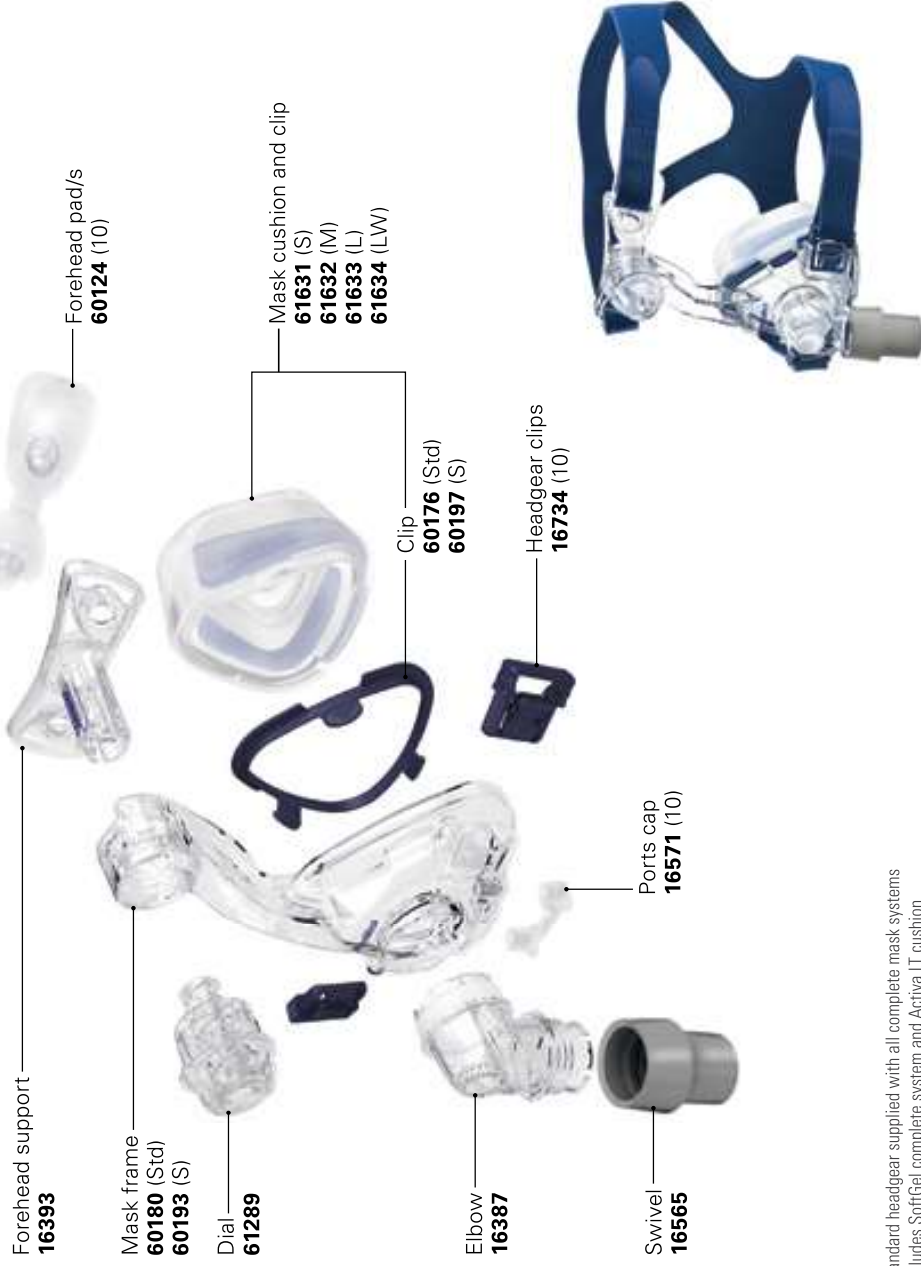

- 1 Standard headgear supplied with all complete mask systems
- 2 Includes SoftGel complete system and Activa LT cushion
- 3 Includes headgear clips

# Mirage Activa LT

## Nasal mask

### Quick fitting guide

#### Personalized fit and comfort

- The unique cushion features a compact “active cell” that automatically adjusts to accommodate user movements and varying pressures throughout the night.
- Ideal for active sleepers, ActiveCell™ technology provides dynamic defense against leaks.

#### Intuitively easy

- MicroFit dial provides easy, one-handed forehead support adjustment.
- Requires less headgear tension and adjustment designed to achieve an effective seal.
- Quick fitting and with improved compliance.

#### Quiet and diffused

- Innovative diffused vent design disperses air quietly and softly, at a short distance and away from the bed partner.
- Located on the elbow for easy cleaning and disassembly.

#### Fitting tips

- While the device is turned on, pull the mask away from the face to re-inflate cushion; then adjust the headgear straps.
- Do not overtighten headgear straps.

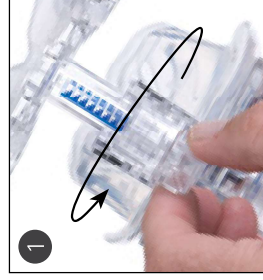

- Turn the MicroFit dial to position 24 so that the forehead support is fully extended.

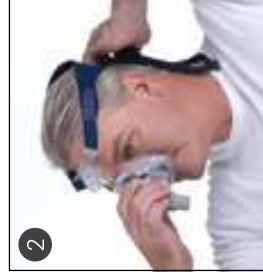

- Disconnect the lower headgear clip, hold the mask over the nose and pull the headgear over the head.
- Reconnect the lower headgear clip, ensuring that it clicks into place.



- Connect one end of the air tubing to the swivel and the other end to the flow generator.



- Allow room for the cushion to inflate. Use two fingers as a guide.



- Turn on the flow generator.



- While lying down, adjust the dial for comfort and seal.

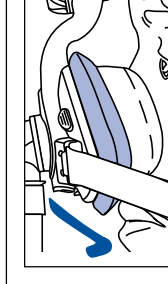

- If the mask is fitted correctly, the cushion should be smooth and the inflatable area fully inflated.

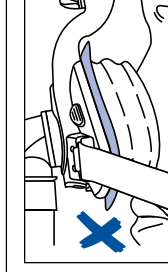

- If fitted incorrectly, the cushion will be creased and the inflatable area underinflated.



# Mirage Activa LT

## Nasal mask

### Systems and components

#### Complete mask system<sup>1</sup>

Small **60182**  
 Medium **60148**  
 Large **60149**  
 Large Wide **60150**

#### Frame system<sup>2</sup>

(no headgear)  
 Small **60195**  
 Medium **60172**  
 Large **60173**  
 Large Wide **60174**

#### Frame assembly<sup>2,3</sup>

(no headgear, no cushion)  
 Small **60196**  
 Standard **60175**

#### Headgear

(no clips)  
 Small **16118**  
 Standard **16117**  
 Large **16119**

#### Elbow assembly

(elbow, swivel) **16399**



1 Standard headgear supplied with all complete mask systems

2 Includes headgear clips

3 Small cushion compatible with Small frame only

# Swift FX Nano™/Swift FX Nano for Her Nasal mask

## Quick fitting guide

### Small in size, big on comfort

- Open, streamlined design of nasal pillows with the comfort of a nasal mask.

### Quick-fitting, minimal design

- Two-point headgear with no need for rigid frames or forehead support.
- Stylish headgear and fit range specifically for women in the Nano for Her.

### Complete comfort

- Modified dual-wall nasal cushion provides a supportive seal with greater flexibility.
- Whisper-quiet venting gently distributes air away from the patient and bed partner.

### Freedom of movement

- Ball-joint elbow rotates 360° to accommodate various sleeping positions.
- Spring-flex tubing and dual swivel reduce pull on the mask.
- Cushion tab hinges add flexibility to compensate for additional movement.

### Fitting tips

- If air is leaking, check for leak and adjust the backstrap.
- Do not overtighten headgear straps.

**myAir™** Compatible with myAir™ patient engagement program when paired with most Air10™ devices.



- Ensure that the bottom of the cushion opening aligns with the bottom of your nose, then place the mask over your nose.
- Pull the headgear over your head so it sits midway between your ears and eyes.



- Adjust the top strap for positioning, one notch at a time, until the mask is comfortably over your nose. Do not overtighten.
- **Tip:** If the cushion is putting pressure on the bottom of your nose, loosen top strap.



- The backstrap should sit just above the ears at the back of the head.
- Adjust both fasteners on the fabric backstrap at the same time.
- Ensure that the backstrap sits over your hair.



- Ensure that the mask is comfortably sealed.
- **Tip:** When adjusting for leak, adjust the backstrap.

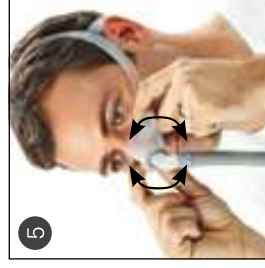

- Adjust the nasal cushion until it sits comfortably on your nose.
- Connect the free end of the short tube assembly to the air tubing of your device, then turn it on.



- If air is leaking, check for leak and adjust the backstrap.
- Your mask is now ready to use.
- **Tip:** For optimal performance, wear the tube down.



### Optional soft wraps

- Wrap each of the soft wraps around either side of the headgear, folding the top fastener over the lower one.
- The soft wraps should be positioned on your cheeks, with the fasteners on the outside.
- **Note:** For additional information, refer to the Swift FX Nano Nasal Mask User Guide.

# Swift FX Nano/Swift FX Nano for Her Nasal mask

## Systems and components

### Swift FX Nano (Standard) Complete mask system

(Complete system includes Standard cushion, Swift FX Nano headgear assembly, plus gray backstrap, soft wraps and frame assembly)

**62200**

### Swift FX Nano (Wide) Complete mask system

(Complete system includes Wide cushion, Swift FX Nano headgear assembly, plus gray backstrap, soft wraps and frame assembly)

**62251**

### Swift FX Nano for Her (Small) Complete mask system

(Complete system includes Small cushion, Swift FX Nano For Her headgear assembly, plus pink backstrap, soft wraps and frame assembly)

**62201**

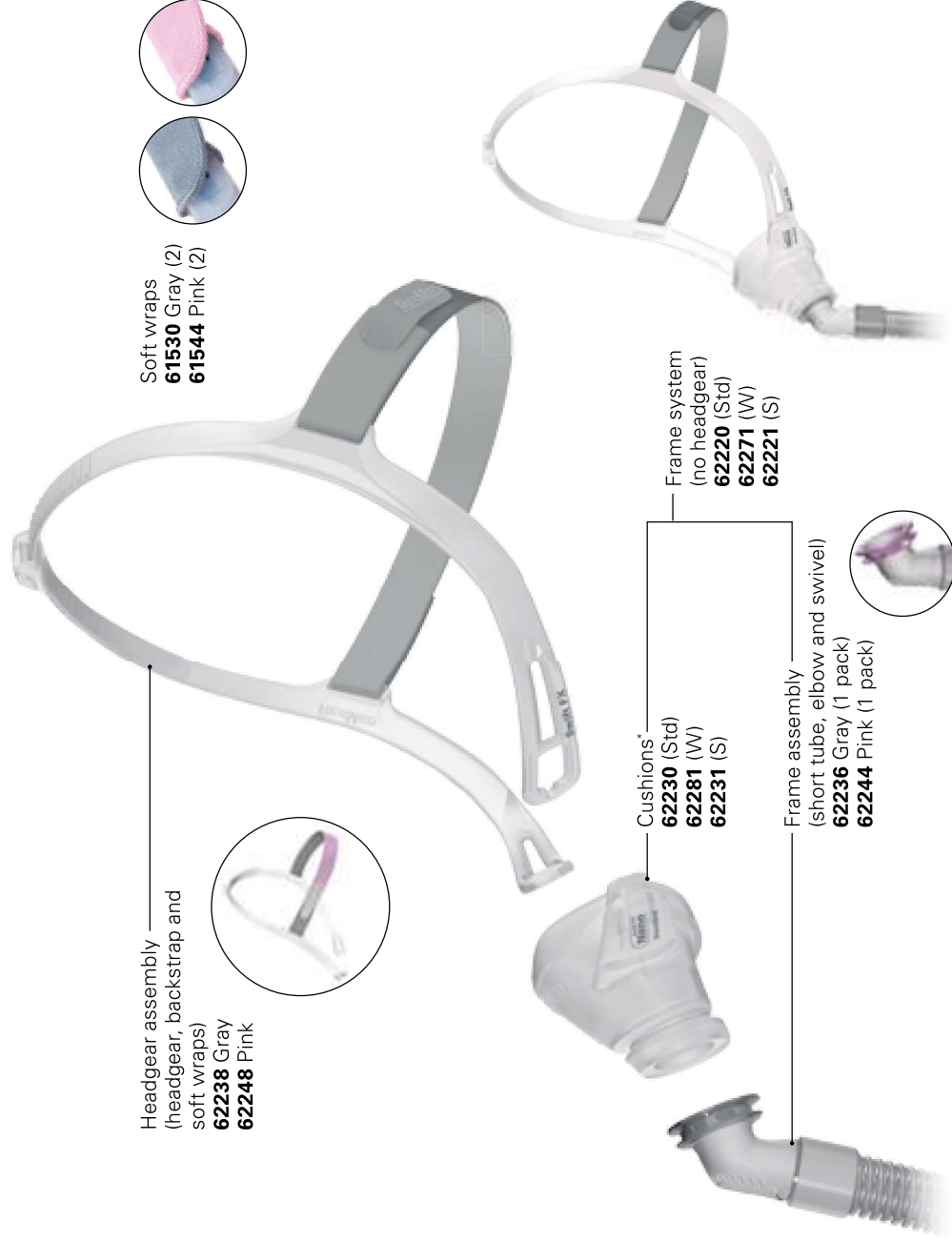

\* Note: Nano Cushions are coded by PDAC as HCPCS A7034



# Nasal pillows masks

MASK LINEUP



**AirFit™ P10**  
**AirFit™ P10 for Her**



**Swift™ FX**  
**Swift™ FX for Her**



**Swift™ FX Bella Gray**  
**Swift™ FX Bella**

## HCPCS codes for ResMed's nasal pillows\*

CODE	PRODUCT	REPLACEMENT SCHEDULE
A7034	Nasal mask frame system	1 per 3 months
A7033	Nasal pillow replacement	2 pairs per month
A7035	Headgear	1 per 6 months

\* The Medicare schedule states how often accessories can be replaced if medically necessary. Check with all payors directly to verify current coverage requirements and policies.

For all legacy mask information, visit [ResMed.com/MaskGuide](https://www.resmed.com/MaskGuide).

# AirFit P10/AirFit P10 for Her Nasal pillows mask

## Quick fitting guide

### A quieter mask to fit your sleep

- The AirFit P10 offers the reliability and performance of the Swift FX in a design that's approximately 50% lighter and 50% quieter.<sup>1</sup>
- A study found that patients slept more than 40 minutes longer per night when using the AirFit P10.<sup>2</sup>
- At just 21.4 dBA, this is ResMed's quietest pillows mask yet.<sup>1</sup>
- The QuietAir™ woven-mesh venting gently diffuses exhaled air, so it's barely noticeable to patients.

### Light and comfortable

- Comfortable and unobtrusive, the AirFit P10 is 50% lighter than our leading nasal pillows mask.<sup>1</sup>
- Lightweight flexible tube stretches and bends to allow for flexibility without sacrificing stability.
- Dual-wall nasal pillows with trampoline action and adjustable, split-strap headgear let patients move around freely without compromising seal.

### Easy to use

- The QuickFit™ elastic headgear is auto-adjusting and simple to fit, and the mask easily slips on and off without any extra steps.
- Key-clip nasal pillows seal on contact with a simple one-click action that makes assembling and cleaning the mask fast and easy.
- Each of the four pillows sizes is a different color for easy identification: pink (extra small), clear (small), gray (medium) and blue (large).

**myAir™** Compatible with myAir™ patient engagement program when paired with most Air10™ devices.

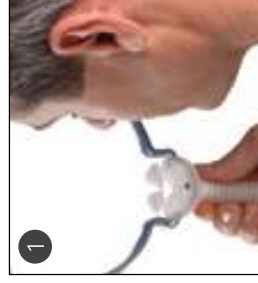

- Hold the pillows at your nose, ensuring that the pillow size indicator is on the bottom and you can see the left (L) and right (R) orientation indicators.



- Stretch the lower strap around the back of your head.
- The top strap should sit comfortably on the top of your head.

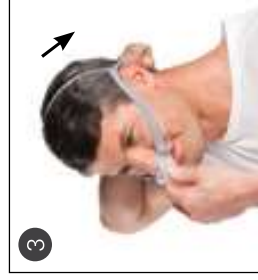

- Pull the headgear over your head by holding the lower strap.
- If adjustment is needed, simply spread the upper and lower straps apart to loosen, or draw them closer together to tighten.



- Move the mask away from your face, and then place it back again.
- Make sure the nasal pillows fit securely into your nostrils with both pillows positioned upright.



- Finally, connect the end of the mask's tube into your device's air tubing.
- Turn on your device – your mask is now ready to use.
- Wash in warm water.

**Note:** For complete user instructions, refer to the *AirFit P10 User Guide*.

1 ResMed Ref: D000-0201; eLB0798-206.  
2 ResMed Clinical Study Comparing AirFit P10 to Swift FX; FECS3 Ref: D629-117 (page 11). ResMed objective data (pressure, leak, usage, AHI).

# AirFit P10/AirFit P10 for Her

## Nasal pillows mask

### Systems and components

**AirFit P10 Complete mask system**  
 (Complete system includes frame, pillows and blue QuickFit elastic headgear.  
 S, M and L pillows included.)  
**62900**

**AirFit P10 for Her Complete mask system**  
 (Complete system includes frame, pillows and pink QuickFit elastic headgear.  
 XS, S and M pillows included.)  
**62910**

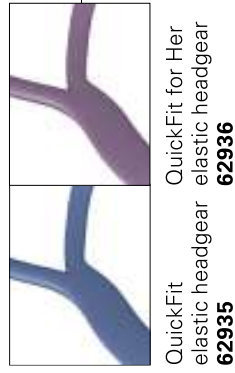

QuickFit elastic headgear **62935**  
 QuickFit for Her elastic headgear **62936**

Frame system (includes frame and pillows)  
**62920 (XS)**  
**62921 (S)**  
**62922 (M)**  
**62923 (L)**

Pillows

Frame

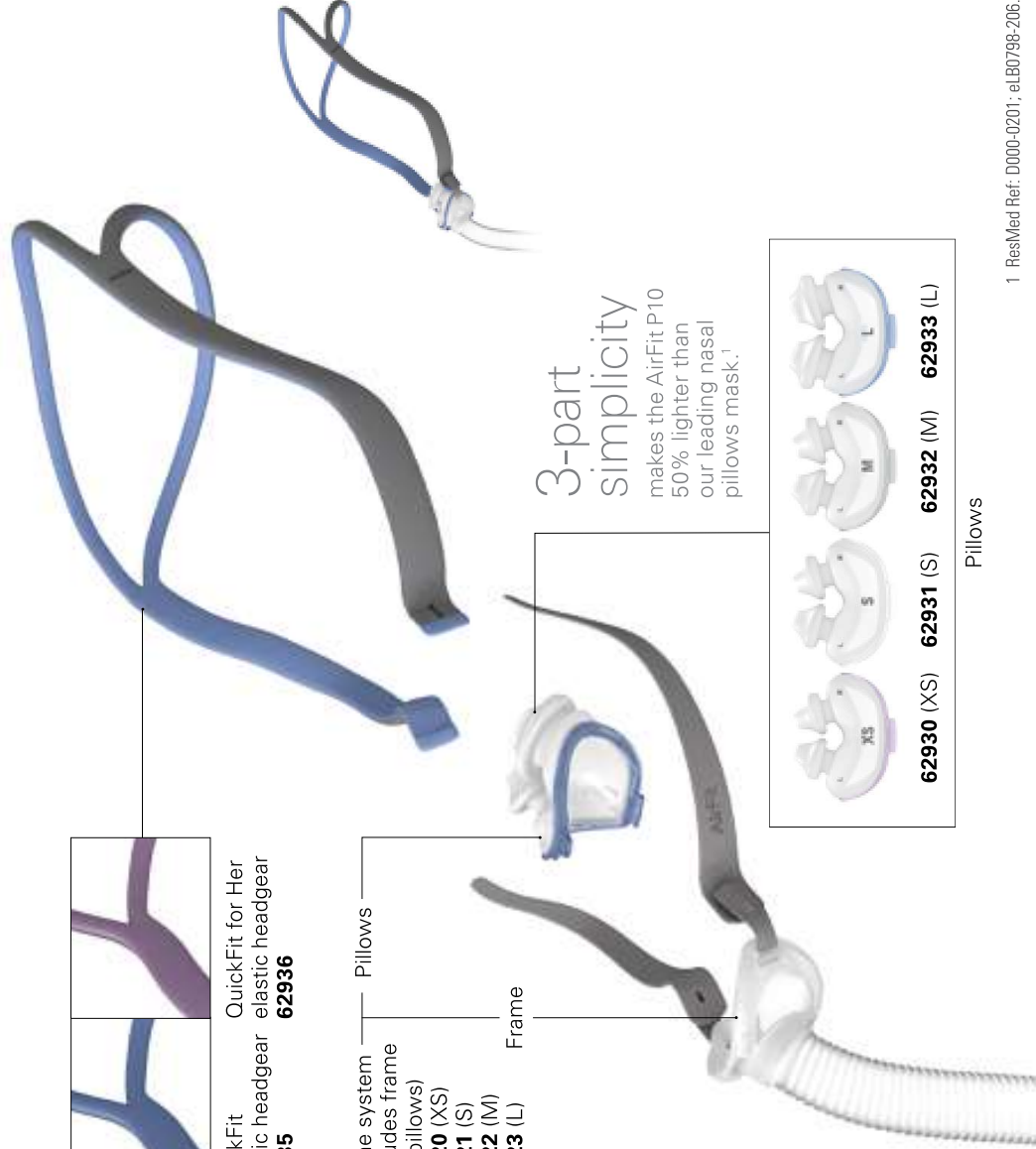

**3-part simplicity**  
 makes the AirFit P10 50% lighter than our leading nasal pillows mask.<sup>1</sup>



**62930 (XS)** **62931 (S)** **62932 (M)** **62933 (L)**

Pillows

<sup>1</sup> ResMed Ref: D000-0201; eL60798-206.



# Swift FX™/Swift FX for Her

## Nasal pillows mask

### Quick fitting guide

#### Soft comfort and stable performance

- Light and gentle fit with minimal facial contact reinforces a sense of freedom and promotes early therapy acceptance.
- Dual-wall pillows and flexible cushion base is designed to maintain seal while adapting to movement, even at high pressures.
- Revolutionary spring-flex lightweight tubing and soft, flexible headgear allow for a range of sleeping positions.

#### Intuitive fit

- Virtually instant fitting with minimal adjustment saves valuable time.
- Straightforward assembly with few parts allows for quick and convenient cleaning.

#### Inventory efficiencies

- Includes three pillow sizes to reduce inventory.
- Extra small size available for a wide fit range.

#### Fitting tips

- While the device is turned on, pull the mask away from the face to re-inflate the pillow; then adjust the headgear straps.
- Do not overtighten headgear straps.



- Holding the pillows at the nose, pull the headgear over the head.
- Headgear should sit midway between the ears and eyes.

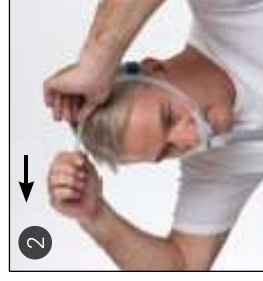

- Adjust the top strap first.
- Pull the strap through the buckle one notch at a time.
- Do not overtighten.



- Adjust the backstrap to fine-tune the fitting if necessary.
- Do not overtighten.
- The backstrap can be positioned over or under the hair.



- Swift FX pillows are designed to provide a natural fit.
- Minor adjustments can help position the pillows at the most comfortable angle in the nose.

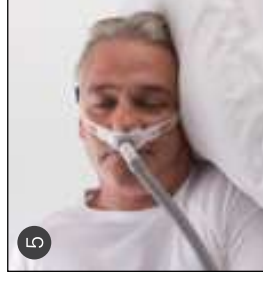

- Connect the Swift FX short tube to the device air tubing.
- Swift FX is now fitted and ready for use.



- With the device turned on, check that the nasal pillows are properly inflated. To do this, pull the nasal pillows away from the face and cheek, make sure they are inflated and reposition them in the nose.

myAir™ Compatible with myAir™ patient engagement program when paired with most Air10™ devices.

# Swift FX/Swift FX for Her

## Nasal pillows mask

### Systems and components

#### Swift FX

**Complete mask system**  
(Includes frame, headgear, soft wraps, backstrap and Small, Medium, and Large pillows.)

**61500**

**Frame system**  
(no headgear)

Extra Small<sup>1</sup>

Small

Medium

Large

**Headgear assembly**

(headgear, backstrap and soft wraps)

**61529**

#### Swift FX for Her

**Complete mask system**  
(Extra Small, Small and Medium pillows, pink backstrap and pink soft wraps)

**61540**

**Frame system**  
(no headgear)

Extra Small

Small

Medium

Large<sup>2</sup>

**Headgear assembly**

(headgear, pink and grey backstraps and pink soft wraps)

**61543**

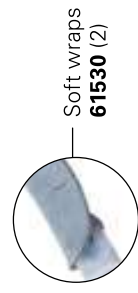

Soft wraps  
**61530** (2)



Soft wraps  
**61544** (2)

Pillows

**61520**<sup>1</sup> (XS)

**61521** (S)

**61522** (M)

**61523** (L)

Frame assembly  
(short tube, elbow and swivel)

**61528** (1)



1 Extra Small (XS) pillows sold separately  
2 Large (L) pillows sold separately

# Swift FX Bella™ Gray/Swift FX Bella

## Nasal pillows mask

### Quick fitting guide

- Style and design with you in mind**
- Soft, lightweight design with minimal facial contact promotes early therapy acceptance.
  - Exclusive Bella loops fit comfortably around the ears and stay out of hair for a streamlined look and feel.
  - Specialized fit range for men and women.

**Freedom to move and sleep on the side**

- Soft, narrow cushion makes side sleeping more comfortable.
- Spring-flex lightweight tube stretches and bends easily for increased stability.
- Flexible pillows accommodate movement in multiple directions while maintaining a stable seal.

**Intuitive fit**

- Virtually instant fitting with minimal adjustment saves valuable time.
- Straightforward assembly with few parts allows for quick and convenient cleaning.

**Convenient, quiet comfort**

- Quiet vents diffuse and direct airflow quietly and gently away from the patient and sleeping partner.
- “Lock and key” feature allows for easy attachment and detachment of Bella loops.

**Fitting tip**

- While the device is turned on, pull the mask away from the face to re-inflate the pillows; then adjust the headgear straps.

**myAir™** Compatible with myAir™ patient engagement program when paired with most Air10™ devices.



- Hold the pillows at your nose, ensuring that the ResMed logo is above the pillows facing up. Pull one strap around and behind your ear.
- Ensure that the strap lies flat and is not twisted.
- Repeat with the other strap.



- Adjust the mask fit by pulling the upper straps along the notches until a comfortable fit is achieved. Repeat with the lower straps. Do not overtighten.



- Connect the free end of the short tube assembly to the device air tubing.

For Swift FX / Swift FX for Her fitting information, please refer to the *Swift FX / Swift FX for Her* section.

# Swift FX Bella Gray/Swift FX Bella

## Nasal pillows mask

### Systems and components

#### Swift FX Bella Gray

**Complete mask system**  
(Swift FX Bella Gray complete system includes Bella Gray loops attached to the pillows frame, Swift FX headgear with blue backstrap and gray soft wraps. Also included are Small [S], Medium [M] and Large [L] pillows.<sup>1</sup>)

**61568**

#### Swift FX Bella

**Complete mask system**  
(Swift FX Bella complete system includes Bella loops attached to the pillows frame, Swift FX for Her headgear with pink backstrap and pink soft wraps. Also included are Extra Small [XS], Small [S] and Medium [M] pillows.<sup>2</sup>)

**61560**

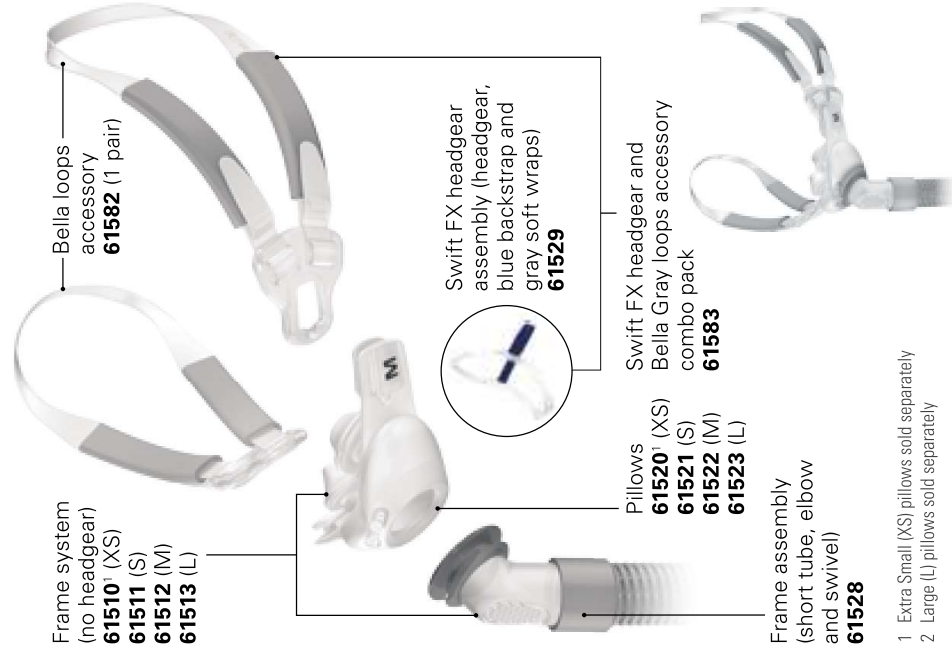

- 1 Extra Small (XS) pillows sold separately
- 2 Large (L) pillows sold separately

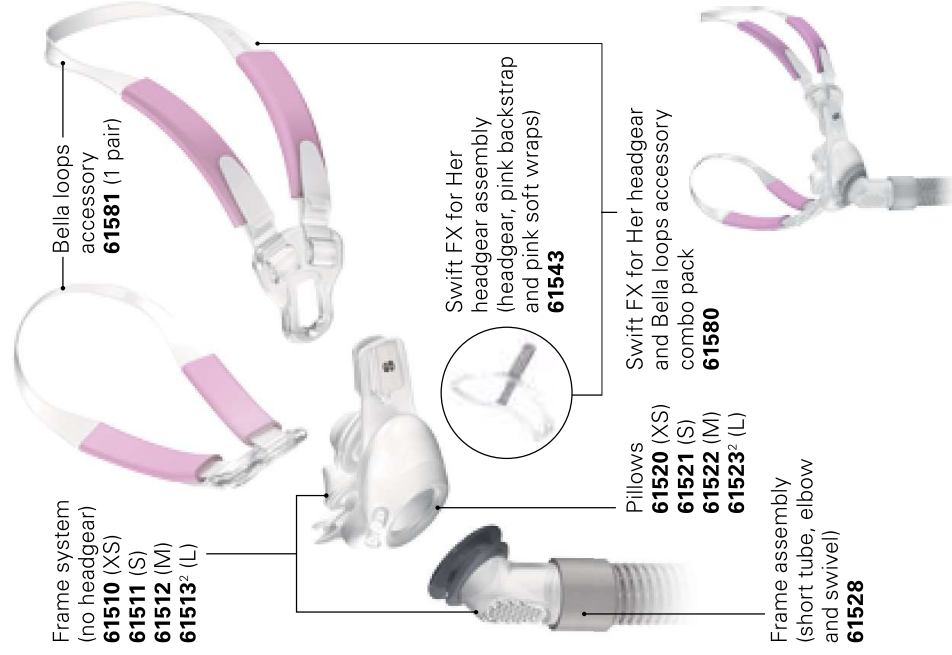



# Pediatric nasal masks

MASK LINEUP



## HCPCS codes for ResMed's pediatric masks\*

CODE	PRODUCT	REPLACEMENT SCHEDULE
A7034	Nasal mask frame system	1 per 3 months
A7032	Nasal cushion replacement	2 per month
A7035	Headgear	1 per 6 months

\* The Medicare schedule states how often accessories can be replaced if medically necessary. Check with all payors directly to verify current coverage requirements and policies.

# Pixi

## Pediatric nasal mask

### Quick fitting guide

#### Three points of adjustment

- The mask can be adjusted at the top, side and bottom straps, providing a greater range of adjustment to cater to children of various ages.

#### Out of sight

- The headgear is designed to sit away from the child's eyes and ears to reduce irritation and obstruction.

#### Clear line of sight

- Not only can the child see clearly while wearing the mask, but caregivers are also reassured and comforted by being able to see their child's eyes and more of their face.

#### Fitting tip

- When fully fitted, ensure that the top strap is not overtightened and is aligned with the top of the ears; the middle strap should sit across the back of the head aligned with the bottom of the ears.



**Pixi hint:** If fitting the mask for the first time, we recommend the child be sitting in an upright position to ensure correct fit.



- Hold the mask gently against the child's face, checking that the nose is fully enclosed by the cushion and the mouth is clear.

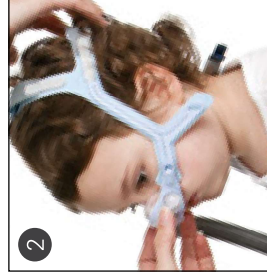

- Pull the headgear over the head and move the middle strap down until it sits across the middle of the back of the head.



- Keeping your hand on the frame to maintain correct headgear position, bring the lower headgear strap behind the back of the neck.



- Attach the lower headgear strap by holding the tab and hooking the quick-release clip onto the mask.



- If necessary, adjust the straps by removing the Velcro and gently tightening the headgear straps until comfortable. Do not overtighten.



- Connect one end of the air tubing to the swivel and the other end to the airflow device.
- Turn on the airflow device.

- For optimal results, adjust the straps starting at the bottom strap and work upward.



# Pixi

## Pediatric nasal mask

### Systems and components

**Complete mask system**  
61030

**Frame system**  
(no headgear)  
61035

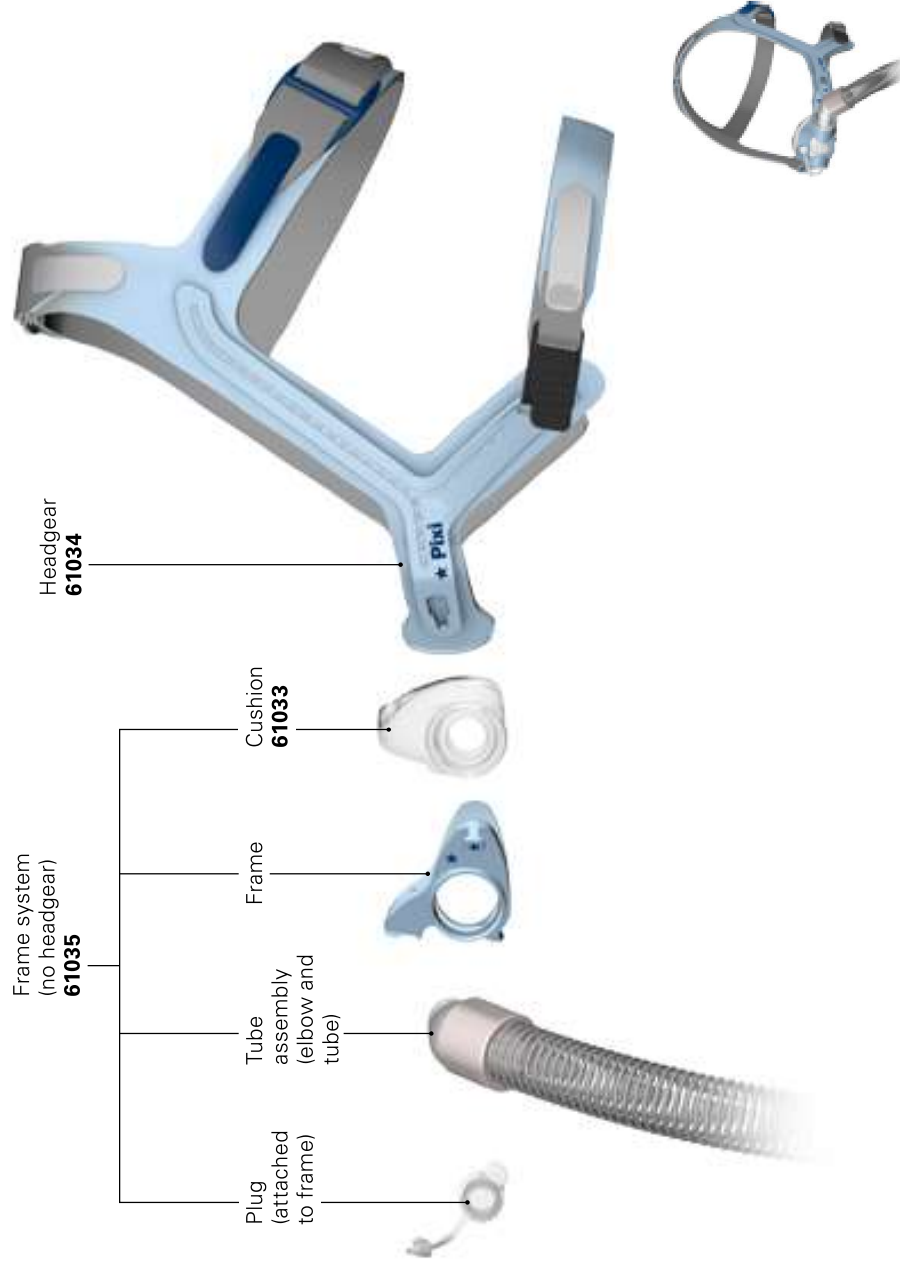

# Cleaning the mask at home

## Daily/after each use

1. Disassemble the mask according to the disassembly instructions.
2. For AirTouch: If required, wipe your cushion with a CPAP wipe or equivalent and then allow to dry. Important – do not get cushion wet.
3. Rinse the frame and elbow under running water. Clean with a soft brush until dirt is removed.
4. Soak the components (excluding AirTouch cushion) in warm water with a mild soap for up to ten minutes.
5. Shake the components in the water.
6. Brush the moving parts of the elbow and around the vent holes.
7. Brush the areas of the frame where the arms connect, and inside and outside the frame where the elbow connects.
8. Rinse the components under running water (excluding AirTouch cushion)
9. Leave the components to air dry out of direct sunlight. Make sure to squeeze the arms of the frame to ensure that excess water is removed.

## Weekly

1. Disassemble the mask. If your mask has magnets, they can remain attached to the headgear during cleaning.
2. Handwash the headgear in warm water with mild liquid detergent.
3. Rinse the headgear under running water. Inspect to ensure the headgear is clean and detergent free. Wash and rinse again, if necessary.
4. Squeeze the headgear to remove excess water.
5. Leave the headgear to air dry out of direct sunlight.



### WARNING

- Do not use aromatic-based solutions or scented oils (e.g., eucalyptus or essential oils), bleach, alcohol or products that smell strongly (e.g., citrus) to clean any of the mask components. Residual vapors from these solutions can be inhaled if not rinsed thoroughly. They may also damage the mask, causing cracks.
- Do not iron the headgear as the material is heat-sensitive and will be damaged.

## Mask/device compatibility list

This document specifies the masks compatible with ResMed's positive airway pressure devices and the mask setting, if one is required. For full details regarding the correct use of these devices, please refer to the specific User Guides.

*Note: Not all products are available in all regions.*

### Full face masks

Device	AirTouch™ F20/ AirTouch™ F20 for Her AirFit™ F20/ AirFit™ F20 for Her AirFit™ F10/ AirFit™ F10 for Her	Quattro™ Air/ Quattro™ Air for Her/ Mirage Quattro™	Quattro™ FX/ Quattro™ FX for Her	Mirage Liberty™	Ultra Mirage™	Hospital Full Face	AcuCare™ F1-4
AirStart™ 10	Full Face	Full Face	Full Face	Full Face	Full Face	Full Face	N/V
AirSense™ 10	Full Face	Full Face	Full Face	Full Face	Full Face	Full Face	N/V
AirCurve™ 10	Full Face	Full Face	Full Face	Full Face	Full Face	Full Face	N/V
Sg™ AutoSet™ / Sg™ AutoSet™ for Her / Sg™ Elite	Full Face	Full Face	Full Face	Full Face	Full Face	Full Face	N/V
Sg™ Escape™ / Sg™ Escape™ Auto	Full Face	Full Face	Full Face	Full Face	Full Face	Full Face	N/V
C-Series Tango	No setting required. Consult your clinician before changing to a different mask type.						
S7 Elite	MIR FULL	MIR FULL	MIR FULL	MIR FULL	MIR FULL	MIR FULL	N/V
S8 AutoSet Vantage	MIR FULL	MIR FULL	MIR FULL	MIR FULL	MIR FULL	MIR FULL	N/V
S8 Compact	No setting required. Consult your clinician before changing to a different mask type.						
S8 Elite / S8 Elite II	MIR FULL	MIR FULL	MIR FULL	MIR FULL	MIR FULL	MIR FULL	N/V
S8 Escape™ / S8 Escape™ II	No setting required. Consult your clinician before changing to a different mask type.						
S8 AutoSet™ II	MIR FULL	MIR FULL	MIR FULL	MIR FULL	MIR FULL	MIR FULL	N/V
VPAP™ III	MIR FULL	MIR FULL	MIR FULL	MIR FULL	MIR FULL	MIR FULL	N/V
VPAP™ III ST-A	MIR FULL	MIR FULL	MIR FULL	MIR FULL	MIR FULL	MIR FULL	N/V
VPAP Adapt SV™	FULL FACE	FULL FACE	FULL FACE	FULL FACE¹	FULL FACE	FULL FACE	N/V
VPAP™ Adapt (S9)	Full Face	Full Face	Full Face	Full Face	Full Face	Full Face	N/V
VPAP™ Adapt (S9 ASV)	Full Face	Full Face	Full Face	Full Face	Full Face	Full Face	N/V
VPAP™ Auto 25	MIR FULL	MIR FULL	MIR FULL	MIR FULL	MIR FULL	MIR FULL	N/V
VPAP™ Auto (S9)	Full Face	Full Face	Full Face	Full Face	Full Face	Full Face	N/V
VPAP™ Malibu	FULL FACE	FULL FACE	FULL FACE	FULL FACE	FULL FACE	FULL FACE	N/V

## Full face masks, continued

Device	AirTouch™ F20 / AirTouch™ F20 for Her AirFit™ F20 / AirFit™ F20 for Her AirFit™ F10 / AirFit™ F10 for Her	Quattro™ Air / Quattro™ Air for Her / Mirage Quattro™	Quattro™ FX / Quattro™ FX for Her	Mirage Liberty™	Ultra Mirage™	Hospital Full Face	AcuCare™ F1-4
VPAP™ S / VPAP™ ST	MIR FULL	MIR FULL	MIR FULL	MIR FULL	MIR FULL	MIR FULL	N/V
VPAP™ S (S9) / VPAP™ ST (S9)	Full Face	Full Face	Full Face	Full Face	Full Face	Full Face	N/V
VPAP™ ST-A (S9; iVAPS)	Full Face	Full Face	Full Face	Full Face	Full Face	Full Face	N/V
VPAP™ COPD (S9)	Full Face	Full Face	Full Face	Full Face	Full Face	Full Face	N/V
S9™ VPAP™ Tx	Full Face	Full Face	Full Face	Full Face	Full Face	Full Face	N/V
VPAP™ Tx	FULL FACE	FULL FACE	FULL FACE	FULL FACE	FULL FACE	FULL FACE	N/V
Lumis™ Tx	Full Face	Full Face	Full Face	Full Face	Full Face	Full Face	N/V
Stellar™	FULL FACE	FULL FACE	FULL FACE	FULL FACE	FULL FACE	FULL FACE	N/V
VS Ultra™ / VS Integra	✓	✓	N/V	✓	✓	✓	✓
VS™ III	✓	✓	N/V	✓	✓	✓	N/V
Astral™	N/V	FULL FACE	FULL FACE	FULL FACE	FULL FACE	FULL FACE	FULL FACE

1 SmartStop may not operate as described when using the mask with ResMed VPAP Adapt SV.  
N/V = The mask has not been validated for this device.

## Nasal masks

Device	AirFit™ N20 / AirFit™ N20 for Her AirFit™ N10 / AirFit™ N10 for Her	Swift™ FX Nano / Swift™ FX Nano for Her	Mirage™ FX / Mirage™ FX for Her	Mirage™ SoftGel	Mirage Activa™ LT	Mirage Micro™	Hospital Nasal	Pixi™
AirStart™ 10	Pillows	Pillows	Nasal	Nasal	Nasal	Nasal	Nasal	N/V
AirSense™ 10	Pillows	Pillows	Nasal	Nasal	Nasal	Nasal	Nasal	N/V
AirCurve™ 10	Pillows	Pillows	Nasal	Nasal	Nasal	Nasal	Nasal	N/V
S9™ AutoSet™ / S9™ AutoSet™ for Her / S9™ Elite	Pillows	Pillows	Nasal	Nasal	Nasal	Nasal	Nasal	N/V
S9™ Escape™ / S9™ Escape™ Auto	Pillows	Pillows	Nasal	Nasal	Nasal	Nasal	Nasal	N/V
C-Series Tango	N/V	N/V	No setting required.	No setting required.	No setting required.	No setting required.	No setting required.	N/V

## Nasal masks, continued

Device	AirFit™ N20 / AirFit™ N20 for Her AirFit™ N10 / AirFit™ N10 for Her	Swift™ FX Nano / Swift™ FX Nano for Her	Mirage™ FX / Mirage™ FX for Her	Mirage™ SoftGel	Mirage Activa™ LT	Mirage Micro™	Hospital Nasal	Pixi™
S7 Elite	N/V	N/V	STANDARD	STANDARD	STANDARD	STANDARD	STANDARD	N/V
S8 AutoSet Vantage	SWIFT	SWIFT	STANDARD	ACTIVA	ACTIVA	STANDARD	STANDARD	N/V
S8 Compact		No setting required. Consult your clinician before changing to a different mask type.						N/V
S8 Elite / S8 Elite II	SWIFT	SWIFT	STANDARD	ACTIVA	ACTIVA	STANDARD	STANDARD	N/V
S8 Escape™ / S8 Escape™ II		No setting required. Consult your clinician before changing to a different mask type.						N/V
S8 AutoSet™ II	SWIFT	SWIFT	STANDARD	ACTIVA	ACTIVA	STANDARD	STANDARD	N/V
VPAP™ III	MIRAGE	MIRAGE	STANDARD	STANDARD	STANDARD	STANDARD	N/V	N/V
VPAP™ III ST-A	MIRAGE	MIRAGE	STANDARD	STANDARD	STANDARD	STANDARD	N/V	N/V
VPAP Adapt SV™	N/V	N/V	VISTA¹	ACTIVA	ACTIVA	VISTA¹	VISTA	N/V
VPAP™ Adapt (S9)	Pillows	Pillows	Nasal	Nasal	Nasal	Nasal	Nasal	N/V
VPAP™ Adapt (S9 ASV)	Pillows	Pillows	Nasal	Nasal	Nasal	Nasal	Nasal	N/V
VPAP™ Auto 25	SWIFT	SWIFT	STANDARD	ACTIVA	ACTIVA	STANDARD	STANDARD	N/V
VPAP™ Auto (S9)	Pillows	Pillows	Nasal	Nasal	Nasal	Nasal	Nasal	N/V
VPAP™ Malibu	SWIFT	SWIFT	VISTA¹	N/V	N/V	MERIDIAN	MERIDIAN	N/V
VPAP™ S / VPAP™ ST	SWIFT	SWIFT	STANDARD	ACTIVA	ACTIVA	STANDARD	STANDARD	N/V
VPAP™ S (S9) / VPAP™ ST (S9)	Pillows	Pillows	Nasal	Nasal	Nasal	Nasal	Nasal	N/V
VPAP™ ST-A (S9 iVAPS)	Pillows	Pillows	Nasal	Nasal	Nasal	Nasal	Nasal	Pediatric
VPAP™ COPD (S9)	Pillows	Pillows	Nasal	Nasal	Nasal	Nasal	Nasal	Pediatric
S9™ VPAP™ Tx	Pillows	Pillows	Nasal	Nasal	Nasal	Nasal	Nasal	Pediatric
VPAP™ Tx	PILLOWS	PILLOWS	NASAL	NASAL	NASAL	NASAL	NASAL	N/V
Lumis™ Tx	Pillows	Pillows	Nasal	Nasal	Nasal	Nasal	Nasal	Pediatric
Stellar™	PILLOWS¹	PILLOWS¹	NASAL	NASAL	NASAL	NASAL	NASAL	Pediatric
VS Ultra™ / VS Integra	N/V	N/V	N/V	N/V	N/V	N/V	N/V	N/V
VS™ III	N/V	N/V	N/V	N/V	✓	✓	✓	N/V
Astral™	N/V	N/V	Nasal	Nasal	N/V	Nasal	Nasal	Pediatric

1 SmartStop may not operate as described when using the mask with ResMed VPAP Adapt SV / Stellar.

N/V = The mask has not been validated for this device.

## Nasal masks, continued

Device	Ultra Mirage™ II	Mirage Activa™	Mirage Vista™	Meridian	Mirage Kidsta™	Mirage Micro for Kids
AirStart™ 10	Nasal	Nasal	Nasal	Nasal	Nasal	N/V
AirSense™ 10	Nasal	Nasal	Nasal	Nasal	Nasal	N/V
AirCurve™ 10	Nasal	Nasal	Nasal	Nasal	Nasal	N/V
S9™ AutoSet™ / S9™ AutoSet™ for Her / S9™ Elite	Nasal Ultra	Nasal	Nasal	Nasal	N/V	N/V
S9™ Escape™ / S9™ Escape™ Auto	Nasal Ultra	Nasal	Nasal	Nasal	N/V	N/V
C-Series Tango	No setting required. Consult your clinician before changing to a different mask type.			N/V	N/V	N/V
S7 Elite	ULTRA	STANDARD	STANDARD	N/V	N/V	N/V
S8 AutoSet Vantage	ULTRA	ACTIVA	STANDARD	STANDARD	N/V	N/V
S8 Compact	No setting required. Consult your clinician before changing to a different mask type.			N/V	N/V	N/V
S8 Elite / S8 Elite II	ULTRA	ACTIVA	STANDARD	STANDARD	N/V	N/V
S8 Escape™ / S8 Escape™ II	No setting required. Consult your clinician before changing to a different mask type.			N/V	N/V	N/V
S8 AutoSet™ II	ULTRA	ACTIVA	STANDARD	STANDARD	N/V	N/V
VPAP™ III	ULTRA	STANDARD	STANDARD	N/V	N/V	N/V
VPAP™ III ST-A	ULTRA	STANDARD	STANDARD	N/V	STANDARD	STANDARD
VPAP Adapt SV™	ULTRA	ACTIVA	VISTA	VISTA	N/V	N/V
VPAP™ Adapt (S9)	Nasal Ultra	Nasal	Nasal	Nasal	N/V	N/V
VPAP™ Adapt (S9 ASV)	Nasal Ultra	Nasal	Nasal	Nasal	N/V	N/V
VPAP™ Auto 25	ULTRA	ACTIVA	STANDARD	STANDARD	N/V	N/V
VPAP™ Auto (S9)	Nasal Ultra	Nasal	Nasal	Nasal	N/V	N/V
VPAP™ Malibu	ULTRA	N/V	VISTA	MERIDIAN	N/V	N/V
VPAP™ S / VPAP™ ST	ULTRA	ACTIVA	STANDARD	STANDARD	N/V	N/V
VPAP™ S (S9) / VPAP™ ST (S9)	Nasal Ultra	Nasal	Nasal	Nasal	N/V	N/V
VPAP™ ST-A (S9 iVAPS)	Nasal Ultra	Nasal	Nasal	Nasal	N/V	N/V
VPAP™ COPD (S9)	Nasal Ultra	Nasal	Nasal	Nasal	N/V	N/V
S9™ VPAP™ Tx	Nasal Ultra	Nasal	Nasal	Nasal	N/V	N/V
VPAP™ Tx	NASAL-ULTRA	NASAL	NASAL	N/V	NASAL	N/V
Lumis™ Tx	Nasal Ultra	Nasal	Nasal	Nasal	N/V	N/V

## Nasal masks, continued

Device	Ultra Mirage™ II	Mirage Activa™	Mirage Vista™	Meridian	Mirage Kidsta™	Mirage Micro for Kids
Stellar™	ULTRA	NASAL	NASAL	N/V	NASAL	N/V
VS Ultra™ / VS Integra	N/V	N/V	N/V	N/V	N/V	N/V
VS™ III	✓	✓	✓	N/V	✓	N/V
Astral™	Nasal Ultra	N/V	Nasal	N/V	Nasal	Nasal

N/V = The mask has not been validated for this device.

## Nasal pillows masks

Device	AirFit™ P10/ AirFit™ P10 for Her	Swift™ FX / Swift™ FX for Her	Swift™ FX Bella / Swift™ FX Bella Gray	Swift™ LT / Swift™ LT for Her	Mirage Swift™ II
AirStart™ 10	Pillows	Pillows	Pillows	Pillows	Pillows
AirSense™ 10	Pillows	Pillows	Pillows	Pillows	Pillows
AirCurve™ 10	Pillows <sup>2</sup>	Pillows	Pillows	Pillows	Pillows
S9™ AutoSet™ / S9™ AutoSet™ for Her / S9™ Elite	Pillows	Pillows	Pillows	Pillows	Pillows
S9™ Escape™ / S9™ Escape™ Auto	Pillows	Pillows	Pillows	Pillows	Pillows
C-Series Tango		No setting required. Consult your clinician before changing to a different mask type.			
S7 Elite	MIRAGE	MIRAGE	MIRAGE	MIRAGE	MIRAGE
S8 AutoSet Vantage	SWIFT	SWIFT	SWIFT	SWIFT	SWIFT
S8 Compact		No setting required. Consult your clinician before changing to a different mask type.			
S8 Elite / S8 Elite II	SWIFT	SWIFT	SWIFT	SWIFT	SWIFT
S8 Escape™ / S8 Escape™ II		No setting required. Consult your clinician before changing to a different mask type.			
S8 AutoSet™ II	SWIFT	SWIFT	SWIFT	SWIFT	SWIFT
VPAP™ III	MIRAGE	MIRAGE	MIRAGE	MIRAGE	MIRAGE
VPAP™ III ST-A	MIRAGE	MIRAGE	MIRAGE	MIRAGE	MIRAGE
VPAP Adapt SV™	N/V	N/V	N/V	N/V	N/V
VPAP™ Adapt (S9)	Pillows	Pillows	Pillows	Pillows	Pillows
VPAP™ Adapt (S9 ASV)	Pillows	Pillows	Pillows	Pillows	Pillows



## Nasal pillows masks

Device	AirFit™ P10 / AirFit™ P10 for Her	Swift™ FX / Swift™ FX for Her	Swift™ FX Bella / Swift™ FX Bella Gray	Swift™ LT / Swift™ LT for Her	Mirage Swift™ II
VPAP™ Auto 25	SWIFT	SWIFT	SWIFT	SWIFT	SWIFT
VPAP™ Auto (S9)	Pillows	Pillows	Pillows	Pillows	Pillows
VPAP™ Malibu	SWIFT	SWIFT	SWIFT	SWIFT	SWIFT
VPAP™ S / VPAP™ ST	SWIFT	SWIFT	SWIFT	SWIFT	SWIFT
VPAP™ S (S9) / VPAP™ ST (S9)	Pillows	Pillows	Pillows	Pillows	Pillows
VPAP™ ST-A (S9 iVAPS)	Pillows	Pillows	Pillows	Pillows	Pillows
VPAP™ CPD (S9)	Pillows	Pillows	Pillows	Pillows	Pillows
S9™ VPAP™ Tx	Pillows	Pillows	Pillows	Pillows	Pillows
VPAP™ Tx	PILLOWS	PILLOWS	PILLOWS	PILLOWS	PILLOWS
Lumis™ Tx	Pillows	Pillows	Pillows	Pillows	Pillows
Stellar™	PILLOWS <sup>1</sup>	PILLOWS <sup>1</sup>	PILLOWS <sup>1</sup>	PILLOWS <sup>1</sup>	PILLOWS <sup>1</sup>
VS Ultra™ / VS Integra	N/V	N/V	N/V	N/V	N/V
VS™ III	N/V	N/V	N/V	N/V	N/V
Astral™	N/V	Pillows	Pillows	Pillows	Pillows

<sup>1</sup> SmartStop may not operate as described when using the mask with Stellar.

<sup>2</sup> Accuracy of tidal volume/minute ventilation may reduce using the AirFit P10 mask in bilevel modes (S, T, ST), particularly at higher pressure supports.

N/V = The mask has not been validated for this device.

# Disinfection and sterilization guide

## Clinical use only

This guide is intended for the multi-patient use of a ResMed full face mask, nasal mask or nasal pillows system (“mask”) in a sleep lab, clinic or hospital. If you use the mask as a single user in the home, refer to the User Guide for cleaning instructions. This guide describes ResMed’s recommended and validated procedures for cleaning, disinfection and sterilization of the mask in accordance with ISO17664.

*Note: Only masks listed in the table below have been validated for reprocessing between patients.*

Mask <sup>1</sup>	Replace these parts with new parts between patients	High-level thermal disinfection		High-level chemical disinfection		Sterilization		Validated number of cycles <sup>2</sup>
		ISO 15883-1 158°F (70°C)-100 min; 167°F (75°C)-30 min 176°F (80°C)-10 min; 194°F (90°C)-1 min	Orthophthal-aldehyde 0.55%	CIDEX™ OPA Glutaraldehyde 3.4%	100S	STERRAD™ NX		
<b>Full face masks</b>								
Mirage Liberty	Swivel, inlet tube	✓	✓		✓			20
Mirage Quattro <sup>3</sup>	None	✓	✓		✓			20
Quattro FX <sup>7</sup> / Quattro FX for Her <sup>7</sup>	None	✓	✓		✓			20
Quattro FX NV <sup>7</sup>	None	✓	✓		✓			20
Ultra Mirage	Valve membrane	✓	✓	✓	✓			15
Ultra Mirage Non-vented	None	✓	✓	✓	✓			15
Quattro Air <sup>7</sup> / Quattro Air for Her <sup>7</sup>	None	✓	✓	✓	✓			20
AirTouch F20 / AirTouch F20 for Her AirFit F20 / AirFit F20 for Her		See ResMed.com/MaskSupport for the Disinfection and Sterilization guidelines.						
AirFit F10 <sup>7</sup> / AirFit F10 for Her <sup>7</sup>	None	✓	✓		✓			20
<b>Nasal masks</b>								
Mirage Activa	Swivel, inlet tube	✓	✓	✓	✓			15
Mirage Activa LT <sup>3</sup>	None	✓	✓		✓			20
Mirage FX <sup>7</sup> / Mirage FX for Her <sup>7</sup>	None	✓	✓		✓			20
Mirage Kidsta	Swivel, inlet tube	✓	✓	✓	✓			15
Mirage Micro <sup>3</sup> / Mirage Micro for Kids <sup>3</sup>	None	✓	✓		✓			20
Mirage SoftGel <sup>3</sup>	None	✓	✓		✓ <sup>6</sup>	✓ <sup>6</sup>		20

# Disinfection and sterilization guide, continued

## Clinical use only

Mask <sup>1</sup>	Replace these parts with new parts between patients	High-level thermal disinfection		High-level chemical disinfection		Sterilization		Validated number of cycles <sup>2</sup>
		ISO 15883-1 158°F (70°C)-100 min; 167°F (75°C)-30 min 176°F (80°C)-10 min; 194°F (90°C)-1 min	ISO 15883-1 Orthophthal-aldehyde 0.55%	CIDEX™ Plus Glutaraldehyde 3.4%	STERRAD™ 100S	NX		
Mirage Vista	Swivel, inlet tube	✓	✓	✓	✓			15
Ultra Mirage II	None	✓	✓	✓				15
Ultra Mirage Non-vented	None	✓	✓	✓	✓			15
Swift FX Nano / Swift FX Nano for Her	None	✓	✓	✓	✓ <sup>5</sup>	✓ <sup>5</sup>		20
AirFit N20 / AirFit N20 for Her		See ResMed.com/MaskSupport for the AirFit N20 Disinfection and Sterilization guidelines.						
AirFit N10 / AirFit N10 for Her	None	✓	✓				✓	20
<b>Nasal pillows systems</b>								
Swift FX / Swift FX for Her / Swift FX Bella / Swift FX Bella Gray	None	✓	✓		✓ <sup>5</sup>	✓ <sup>5</sup>		20
Swift LT	None	✓	✓		✓ <sup>5</sup>	✓ <sup>5</sup>		20
Swift LT for Her/ Swift LT-F	None	✓	✓		✓ <sup>5</sup>	✓ <sup>5</sup>		20
Mirage Swift II	None	✓ <sup>4</sup>	✓	✓	✓	✓		15
AirFit P10 / AirFit P10 for Her	None	✓	✓				✓	20

1 Not all masks are available in all regions. For full details regarding the correct use of these masks, please refer to the specific User Guide. For a list of available replacement parts for each mask system, check the Components Card on ResMed.com.

2 If a healthcare facility requires an additional disinfection or sterilization cycle after reassembly, the number of validated cycles must be halved.

3 Alternative disassembly available. See "Disassembling the masks before cleaning."

4 Some components cannot be treated. Alternative cleaning must be used. See "Cleaning other components."

5 Cushion cannot be treated via STERRAD sterilization.

6 Short tube assembly cannot be treated via STERRAD sterilization.

7 Short tube assembly validated to 158°F (70°C).

# Validated disinfection and sterilization procedures

In the procedures below, only one of the following three disinfection or sterilization procedures needs to be performed. Refer to ResMed.com/MaskSupport for AirFit F20, AirFit N20 and AirTouch F20 disinfection and sterilization procedures.

	High-level thermal disinfection	High-level chemical disinfection	Sterilization
<b>Disassembly</b>	Disassemble the mask according to the instructions in the User Guide.		
<b>Cleaning and drying</b>	<ol style="list-style-type: none"> <li>Thoroughly clean the separated mask components (excluding headgear) with a soft-bristle brush for one minute while soaking them in the detergent Alconox™ (diluted at 1%) according to the manufacturer's instructions. Pay particular attention to all crevices and cavities.</li> <li>Inspect each component and, if required, repeat washing until visually clean.</li> <li>Rinse the components twice by agitating them vigorously in drinking quality water (1.3 gallons [5 liters] per mask).</li> <li>Allow the mask components to air-dry out of direct sunlight.</li> </ol>		
<b>Pre-disinfection and drying</b>	Not validated.		
<b>Disinfection or sterilization and drying</b>	<ol style="list-style-type: none"> <li>Using a certified hot water disinfection system, soak the disinfectable mask components using a temperature-time combination:<sup>1</sup> <b>ISO 15883-1:</b> <ul style="list-style-type: none"> <li>158°F (70°C) for 100 minutes</li> <li>167°F (75°C) for 30 minutes</li> <li>176°F (80°C) for 10 minutes</li> <li>194°F (90°C) for 1 minute</li> </ul> </li> <li>On completion, remove the mask component from the hot water disinfection system.</li> <li>Allow the mask components to air-dry out of direct sunlight.</li> </ol>	<ol style="list-style-type: none"> <li>Fully immerse and soak the disinfectable mask components in a commercially available solution according to the manufacturer's instructions: <ul style="list-style-type: none"> <li>Ortho-phthalaldehyde 0.55% (e.g., CIDEX OPA) for 20 minutes or</li> <li>Glutaraldehyde 3.4% (e.g., CIDEX Plus) for 20 minutes</li> </ul> </li> <li>Rinse the mask components in drinking-quality water (1.3 gallons [5 litres] per mask).</li> <li>Allow the mask components to air-dry out of direct sunlight.</li> </ol>	<ol style="list-style-type: none"> <li>Package the mask components prior to sterilization as described in the manufacturer's instructions for the STERRAD Sterilization System. ResMed masks have been validated using the tray method. Note: The use of pouches is not recommended.</li> <li>Sterilize the mask following the manufacturer's instructions for the STERRAD Sterilization System. Note: Drying is achieved as part of the sterilization process.</li> </ol>
<b>Inspection</b>	Perform a visual inspection of each mask component. If any visible deterioration of a mask component is apparent (i.e., cracking, crazing, tears), the mask component should be discarded and replaced. Slight discoloration of the silicone components may occur and is acceptable.		
<b>Reassembly</b>	Reassemble the mask according to the instructions in the User Guide.		
<b>Packaging and storage</b>	Store in a dry, dust-free environment away from direct sunlight. <b>Storage temperature:</b> -4F–140°F (-20C–60°C).		

<sup>1</sup> Calculated and predicted from known thermal inactivation kinetics of vegetative micro-organisms subjected to thermal disinfection (ISO 15883-1) and they are inclusive of the time-temperature combination recommended by the APIC (Associations for Professionals in Infection Control and Epidemiology) and the RKI (Robert Koch Institute).

## Disassembling the masks before cleaning

These instructions apply only to:

- Mirage Quattro
- Mirage Micro
- Mirage Activa LT
- Mirage SoftGel

As an alternate to the disassembly instructions shown in the relevant user guide for removing the forehead support and dial from the mask frame, you can disassemble these components as follows:

1. Unscrew the dial so that the forehead support protrudes about halfway out from the mask frame.
2. Firmly push the forehead support against the mask frame until the dial clicks and detaches from the mask frame.
3. Fully unscrew and remove the dial; then pull the forehead support out of the mask frame.

## Cleaning the headgear

The headgear does not require disinfection and should not be washed in disinfection chemicals. Thoroughly washing the headgear between patients is acceptable.

1. Handwash the headgear in warm water (86°F/30°C) using mild soap.
2. Rinse well and allow it to air-dry out of direct sunlight.

## Cleaning other components

These instructions apply only to:

- AirFit N10/AirFit N10 for Her – soft sleeves
- AirFit F10/AirFit F10 for Her – Frame, soft sleeves
- Quattro Air/Quattro Air for Her – Frame
- Quattro FX/Quattro FX for Her – Spring frame, soft sleeves
- Quattro FX NV – Spring frame, soft sleeves
- Mirage FX/Mirage FX for Her – Frame

The component does not require disinfection and should not be washed in disinfection chemicals. Thoroughly washing the component between patients is acceptable.

1. Handwash the component in warm water (86°F/30°C) using mild soap.
2. Rinse well and allow it to air-dry out of direct sunlight.

## GENERAL WARNINGS AND CAUTIONS

- ResMed cannot give any assurance that deviations from the procedures listed in this guide (e.g., exceeding the number of reprocessing cycles), and their effect on the performance of the product, will be acceptable.
- Mask components should not be subjected to autoclave or ethylene-oxide gas sterilization.
- When using detergents, disinfectants or sterilization agents, always follow the manufacturer's instructions.
- Do not iron the headgear as the material is heat-sensitive and will be damaged.

Refer to ResMed.com/MaskSupport for AirFit F20, AirFit N20 and AirTouch F20 cleaning and disassembly instructions.