

MJ FURNITURE PRICE LIST 1/21/14





Image	Collection	Catalog Number	Item Description	List Price	Colour / Type	Width (Inches)	Depth (Inches)	Height (Inches)	Weight (Lbs.)
	Linx	LX-200-32-SQ	Open Shelf Unit	\$ 2,420	Square Edge	36	27	32	225
	Linx	LX-200-39-SQ	Open Shelf Unit	\$ 2,420	Square Edge	36	27	39	225
	Linx	LX-200-32-CH	Open Shelf Unit	\$ 2,490	Chamfered Edge	36	27	32	225
	Linx	LX-200-39-CH	Open Shelf Unit	\$ 2,490	Chamfered Edge	36	27	39	225
	Linx	LX-200-32-BN	Open Shelf Unit	\$ 2,490	Bullnose Edge	36	27	32	225
	Linx	LX-200-39-BN	Open Shelf Unit	\$ 2,490	Bullnose Edge	36	27	39	225
	Linx	LX-201-32-SQ	Cupboard Unit	\$ 3,015	Square Edge	36	27	32	225
	Linx	LX-201-39-SQ	Cupboard Unit	\$ 3,015	Square Edge	36	27	39	225
	Linx	LX-201-32-CH	Cupboard Unit	\$ 3,085	Chamfered Edge	36	27	32	225
	Linx	LX-201-39-CH	Cupboard Unit	\$ 3,085	Chamfered Edge	36	27	39	225
	Linx	LX-201-32-BN	Cupboard Unit	\$ 3,085	Bullnose Edge	36	27	32	225
	Linx	LX-201-39-BN	Cupboard Unit	\$ 3,085	Bullnose Edge	36	27	39	225
	Linx	LX-202T-32-SQ	Closed Triangular Corner Unit	\$ 2,955	Square Edge	27	27	32	150
	Linx	LX-202T-39-SQ	Closed Triangular Corner Unit	\$ 2,955	Square Edge	27	27	39	150
	Linx	LX-202T-32-CH	Closed Triangular Corner Unit	\$ 3,025	Chamfered Edge	27	27	32	150
	Linx	LX-202T-39-CH	Closed Triangular Corner Unit	\$ 3,025	Chamfered Edge	27	27	39	150
	Linx	LX-202T-32-BN	Closed Triangular Corner Unit	\$ 3,025	Bullnose Edge	27	27	32	150
	Linx	LX-202T-39-BN	Closed Triangular Corner Unit	\$ 3,025	Bullnose Edge	27	27	39	150
	Linx	LX-202C-32-SQ	Closed Curved Corner Unit	\$ 3,160	Square Edge	27	27	32	150
	Linx	LX-202C-39-SQ	Closed Curved Corner Unit	\$ 3,160	Square Edge	27	27	39	150
	Linx	LX-202C-32-CH	Closed Curved Corner Unit	\$ 3,230	Chamfered Edge	27	27	32	150
	Linx	LX-202C-39-CH	Closed Curved Corner Unit	\$ 3,230	Chamfered Edge	27	27	39	150





Image	Collection	Catalog Number	Item Description	List Price	Colour / Type	Width (Inches)	Depth (Inches)	Height (Inches)	Weight (Lbs.)
	Linx	LX-202C-32-BN	Closed Curved Corner Unit	\$ 3,230	Bullnose Edge	27	27	32	150
	Linx	LX-202C-39-BN	Closed Curved Corner Unit	\$ 3,230	Bullnose Edge	27	27	39	150
	Linx	LX-202S-32-SQ	Closed Square Corner Unit	\$ 2,655	Square Edge	27	27	32	150
	Linx	LX-202S-39-SQ	Closed Square Corner Unit	\$ 2,655	Square Edge	27	27	39	150
	Linx	LX-202S-32-CH	Closed Square Corner Unit	\$ 2,725	Chamfered Edge	27	27	32	150
	Linx	LX-202S-39-CH	Closed Square Corner Unit	\$ 2,725	Chamfered Edge	27	27	39	150
	Linx	LX-202S-32-BN	Closed Square Corner Unit	\$ 2,725	Bullnose Edge	27	27	32	150
	Linx	LX-202S-39-BN	Closed Square Corner Unit	\$ 2,725	Bullnose Edge	27	27	39	150
	Linx	LX-203-32-SQ	Knee Space Unit with Cash and Pencil Drawer	\$ 2,890	Square Edge	36	27	32	210
	Linx	LX-203-39-SQ	Knee Space Unit with Cash and Pencil Drawer	\$ 2,890	Square Edge	36	27	39	210
	Linx	LX-203-32-CH	Knee Space Unit with Cash and Pencil Drawer	\$ 2,960	Chamfered Edge	36	27	32	210
	Linx	LX-203-39-CH	Knee Space Unit with Cash and Pencil Drawer	\$ 2,960	Chamfered Edge	36	27	39	210
	Linx	LX-203-32-BN	Knee Space Unit with Cash and Pencil Drawer	\$ 2,960	Bullnose Edge	36	27	32	210
	Linx	LX-203-39-BN	Knee Space Unit with Cash and Pencil Drawer	\$ 2,960	Bullnose Edge	36	27	39	210
	Linx	LX-204-32-SQ	Open Triangle Corner Unit	\$ 2,645	Square Edge	27	27	32	150
	Linx	LX-204-39-SQ	Open Triangle Corner Unit	\$ 2,645	Square Edge	27	27	39	150
	Linx	LX-204-32-CH	Open Triangle Corner Unit	\$ 2,720	Chamfered Edge	27	27	32	150
	Linx	LX-204-39-CH	Open Triangle Corner Unit	\$ 2,720	Chamfered Edge	27	27	39	150
	Linx	LX-204-32-BN	Open Triangle Corner Unit	\$ 2,720	Bullnose Edge	27	27	32	150
	Linx	LX-204-39-BN	Open Triangle Corner Unit	\$ 2,720	Bullnose Edge	27	27	39	150
	Linx	LX-204B-32-SQ	Open Binder Post Corner Unit	\$ 3,005	Square Edge	27	27	32	150
	Linx	LX-204B-39-SQ	Open Binder Post Corner Unit	\$ 3,005	Square Edge	27	27	39	150





Image	Collection	Catalog Number	Item Description	List Price	Colour / Type	Width (Inches)	Depth (Inches)	Height (Inches)	Weight (Lbs.)
	Linx	LX-204B-32-CH	Open Binder Post Corner Unit	\$ 3,075	Chamfered Edge	27	27	32	150
	Linx	LX-204B-39-CH	Open Binder Post Corner Unit	\$ 3,075	Chamfered Edge	27	27	39	150
	Linx	LX-204B-32-BN	Open Binder Post Corner Unit	\$ 3,075	Bullnose Edge	27	27	32	150
	Linx	LX-204B-39-BN	Open Binder Post Corner Unit	\$ 3,075	Bullnose Edge	27	27	39	150
	Linx	LX-204C-32-SQ	Open Curved Corner Unit	\$ 2,650	Square Edge	27	27	32	150
	Linx	LX-204C-39-SQ	Open Curved Corner Unit	\$ 2,650	Square Edge	27	27	39	150
	Linx	LX-204C-32-CH	Open Curved Corner Unit	\$ 2,725	Chamfered Edge	27	27	32	150
	Linx	LX-204C-39-CH	Open Curved Corner Unit	\$ 2,725	Chamfered Edge	27	27	39	150
	Linx	LX-204C-32-BN	Open Curved Corner Unit	\$ 2,725	Bullnose Edge	27	27	32	150
	Linx	LX-204C-39-BN	Open Curved Corner Unit	\$ 2,725	Bullnose Edge	27	27	39	150
	Linx	LX-206-32-SQ	Single Drawer Charge Unit with Shelf	\$ 2,880	Square Edge	36	27	32	220
	Linx	LX-206-39-SQ	Single Drawer Charge Unit with Shelf	\$ 2,880	Square Edge	36	27	39	220
	Linx	LX-206-32-CH	Single Drawer Charge Unit with Shelf	\$ 2,950	Chamfered Edge	36	27	32	220
	Linx	LX-206-39-CH	Single Drawer Charge Unit with Shelf	\$ 2,950	Chamfered Edge	36	27	39	220
	Linx	LX-206-32-BN	Single Drawer Charge Unit with Shelf	\$ 2,950	Bullnose Edge	36	27	32	220
	Linx	LX-206-39-BN	Single Drawer Charge Unit with Shelf	\$ 2,950	Bullnose Edge	36	27	39	220
	Linx	LX-207-32-SQ	Single Drawer Charge Unit	\$ 2,810	Square Edge	36	27	32	210
	Linx	LX-207-39-SQ	Single Drawer Charge Unit	\$ 2,810	Square Edge	36	27	39	210
	Linx	LX-207-32-CH	Single Drawer Charge Unit	\$ 2,880	Chamfered Edge	36	27	32	210
	Linx	LX-207-39-CH	Single Drawer Charge Unit	\$ 2,880	Chamfered Edge	36	27	39	210
	Linx	LX-207-32-BN	Single Drawer Charge Unit	\$ 2,880	Bullnose Edge	36	27	32	210
	Linx	LX-207-39-BN	Single Drawer Charge Unit	\$ 2,880	Bullnose Edge	36	27	39	210



Image	Collection	Catalog Number	Item Description	List Price	Colour / Type	Width (Inches)	Depth (Inches)	Height (Inches)	Weight (Lbs.)
	Linx	LX-208-32-SQ	Book Return Unit	\$ 2,385	Square Edge	36	27	32	175
	Linx	LX-208-39-SQ	Book Return Unit	\$ 2,385	Square Edge	36	27	39	175
	Linx	LX-208-32-CH	Book Return Unit	\$ 2,455	Chamfered Edge	36	27	32	175
	Linx	LX-208-39-CH	Book Return Unit	\$ 2,455	Chamfered Edge	36	27	39	175
	Linx	LX-208-32-BN	Book Return Unit	\$ 2,455	Bullnose Edge	36	27	32	175
	Linx	LX-208-39-BN	Book Return Unit	\$ 2,455	Bullnose Edge	36	27	39	175
	Linx	LX-209-3632-SQ	Desk Unit with Surround, 36" Width	\$ 2,650	Square Edge	36	27	32	190
	Linx	LX-209-3639-SQ	Desk Unit with Surround, 36" Width	\$ 2,650	Square Edge	36	27	39	190
	Linx	LX-209-3632-CH	Desk Unit with Surround, 36" Width	\$ 2,720	Chamfered Edge	36	27	32	190
	Linx	LX-209-3639-CH	Desk Unit with Surround, 36" Width	\$ 2,720	Chamfered Edge	36	27	39	190
	Linx	LX-209-3632-BN	Desk Unit with Surround, 36" Width	\$ 2,720	Bullnose Edge	36	27	32	190
	Linx	LX-209-3639-BN	Desk Unit with Surround, 36" Width	\$ 2,720	Bullnose Edge	36	27	39	190
	Linx	LX-209-4832-SQ	Desk Unit with Surround, 48" Width	\$ 2,750	Square Edge	48	27	32	250
	Linx	LX-209-4839-SQ	Desk Unit with Surround, 48" Width	\$ 2,750	Square Edge	48	27	39	250
	Linx	LX-209-4832-CH	Desk Unit with Surround, 48" Width	\$ 2,845	Chamfered Edge	48	27	32	250
	Linx	LX-209-4839-CH	Desk Unit with Surround, 48" Width	\$ 2,845	Chamfered Edge	48	27	39	250
	Linx	LX-209-4832-BN	Desk Unit with Surround, 48" Width	\$ 2,845	Bullnose Edge	48	27	32	250
	Linx	LX-209-4839-BN	Desk Unit with Surround, 48" Width	\$ 2,845	Bullnose Edge	48	27	39	250
	Linx	LX-209-6032-SQ	Desk Unit with Surround, 60" Width	\$ 2,935	Square Edge	60	27	32	320
	Linx	LX-209-6039-SQ	Desk Unit with Surround, 60" Width	\$ 2,935	Square Edge	60	27	39	320

Image	Collection	Catalog Number	Item Description	List Price	Colour / Type	Width (Inches)	Depth (Inches)	Height (Inches)	Weight (Lbs.)
	Linx	LX-209-6032-CH	Desk Unit with Surround, 60" Width	\$ 3,055	Chamfered Edge	60	27	32	320
	Linx	LX-209-6039-CH	Desk Unit with Surround, 60" Width	\$ 3,055	Chamfered Edge	60	27	39	320
	Linx	LX-209-6032-BN	Desk Unit with Surround, 60" Width	\$ 3,055	Bullnose Edge	60	27	32	320
	Linx	LX-209-6039-BN	Desk Unit with Surround, 60" Width	\$ 3,055	Bullnose Edge	60	27	39	320
	Linx	LX-209-7232-SQ	Desk Unit with Surround, 72" Width	\$ 3,035	Square Edge	72	27	32	390
	Linx	LX-209-7239-SQ	Desk Unit with Surround, 72" Width	\$ 3,035	Square Edge	72	27	39	390
	Linx	LX-209-7232-CH	Desk Unit with Surround, 72" Width	\$ 3,175	Chamfered Edge	72	27	32	390
	Linx	LX-209-7239-CH	Desk Unit with Surround, 72" Width	\$ 3,175	Chamfered Edge	72	27	39	390
	Linx	LX-209-7232-BN	Desk Unit with Surround, 72" Width	\$ 3,175	Bullnose Edge	72	27	32	390
	Linx	LX-209-7239-BN	Desk Unit with Surround, 72" Width	\$ 3,175	Bullnose Edge	72	27	39	390
	Linx	LX-209CD-32-SQ	Corner Desk Unit with Surround	\$ 3,945	Square Edge	65	29	32	500
	Linx	LX-209CD-39-SQ	Corner Desk Unit with Surround	\$ 3,945	Square Edge	65	29	39	500
	Linx	LX-209CD-32-CH	Corner Desk Unit with Surround	\$ 4,155	Chamfered Edge	65	29	32	500
	Linx	LX-209CD-39-CH	Corner Desk Unit with Surround	\$ 4,155	Chamfered Edge	65	29	39	500
	Linx	LX-209CD-32-BN	Corner Desk Unit with Surround	\$ 4,155	Bullnose Edge	65	29	32	500
	Linx	LX-209CD-39-BN	Corner Desk Unit with Surround	\$ 4,155	Bullnose Edge	65	29	39	500
	Linx	LX-219-3632-SQ	Desk Unit, 36" Width	\$ 2,320	Square Edge	36	27	32	190
	Linx	LX-219-3639-SQ	Desk Unit, 36" Width	\$ 2,320	Square Edge	36	27	39	190
	Linx	LX-219-3632-CH	Desk Unit, 36" Width	\$ 2,390	Chamfered Edge	36	27	32	190
	Linx	LX-219-3639-CH	Desk Unit, 36" Width	\$ 2,390	Chamfered Edge	36	27	39	190
	Linx	LX-219-3632-BN	Desk Unit, 36" Width	\$ 2,390	Bullnose Edge	36	27	32	190



Image	Collection	Catalog Number	Item Description	List Price	Colour / Type	Width (Inches)	Depth (Inches)	Height (Inches)	Weight (Lbs.)
	Linx	LX-219-3639-BN	Desk Unit, 36" Width	\$ 2,390	Bullnose Edge	36	27	39	190
	Linx	LX-219-4832-SQ	Desk Unit, 48" Width	\$ 2,420	Square Edge	48	27	32	250
	Linx	LX-219-4839-SQ	Desk Unit, 48" Width	\$ 2,420	Square Edge	48	27	39	250
	Linx	LX-219-4832-CH	Desk Unit, 48" Width	\$ 2,515	Chamfered Edge	48	27	32	250
	Linx	LX-219-4839-CH	Desk Unit, 48" Width	\$ 2,515	Chamfered Edge	48	27	39	250
	Linx	LX-219-4832-BN	Desk Unit, 48" Width	\$ 2,515	Bullnose Edge	48	27	32	250
	Linx	LX-219-4839-BN	Desk Unit, 48" Width	\$ 2,515	Bullnose Edge	48	27	39	250
	Linx	LX-219-6032-SQ	Desk Unit, 60" Width	\$ 2,605	Square Edge	60	27	32	320
	Linx	LX-219-6039-SQ	Desk Unit, 60" Width	\$ 2,605	Square Edge	60	27	39	320
	Linx	LX-219-6032-CH	Desk Unit, 60" Width	\$ 2,720	Chamfered Edge	60	27	32	320
	Linx	LX-219-6039-CH	Desk Unit, 60" Width	\$ 2,720	Chamfered Edge	60	27	39	320
	Linx	LX-219-6032-BN	Desk Unit, 60" Width	\$ 2,720	Bullnose Edge	60	27	32	320
	Linx	LX-219-6039-BN	Desk Unit, 60" Width	\$ 2,720	Bullnose Edge	60	27	39	320
	Linx	LX-219-7232-SQ	Desk Unit, 72" Width	\$ 2,700	Square Edge	72	27	32	390
Linx	LX-219-7239-SQ	Desk Unit, 72" Width	\$ 2,700	Square Edge	72	27	39	390	
Linx	LX-219-7232-CH	Desk Unit, 72" Width	\$ 2,845	Chamfered Edge	72	27	32	390	
Linx	LX-219-7239-CH	Desk Unit, 72" Width	\$ 2,845	Chamfered Edge	72	27	39	390	
Linx	LX-219-7232-BN	Desk Unit, 72" Width	\$ 2,845	Bullnose Edge	72	27	32	390	
Linx	LX-219-7239-BN	Desk Unit, 72" Width	\$ 2,845	Bullnose Edge	72	27	39	390	
	Linx	LX-219CD-32-SQ	Corner Desk Unit	\$ 3,530	Square Edge	65	29	32	500
	Linx	LX-219CD-39-SQ	Corner Desk Unit	\$ 3,530	Square Edge	65	29	39	500
	Linx	LX-219CD-32-CH	Corner Desk Unit	\$ 3,745	Chamfered Edge	65	29	32	500





Image	Collection	Catalog Number	Item Description	List Price	Colour / Type	Width (Inches)	Depth (Inches)	Height (Inches)	Weight (Lbs.)
	Linx	LX-219CD-39-CH	Corner Desk Unit	\$ 3,745	Chamfered Edge	65	29	39	500
	Linx	LX-219CD-32-BN	Corner Desk Unit	\$ 3,745	Bullnose Edge	65	29	32	500
	Linx	LX-219CD-39-BN	Corner Desk Unit	\$ 3,745	Bullnose Edge	65	29	39	500
	Linx	LX-217-32-SQ	45 Degree Wedge Corner Unit	\$ 2,700	Square Edge	20.625	27	32	135
	Linx	LX-217-39-SQ	45 Degree Wedge Corner Unit	\$ 2,700	Square Edge	20.625	27	39	135
	Linx	LX-217-32-CH	45 Degree Wedge Corner Unit	\$ 2,770	Chamfered Edge	20.625	27	32	135
	Linx	LX-217-39-CH	45 Degree Wedge Corner Unit	\$ 2,770	Chamfered Edge	20.625	27	39	135
	Linx	LX-217-32-BN	45 Degree Wedge Corner Unit	\$ 2,770	Bullnose Edge	20.625	27	32	135
	Linx	LX-217-39-BN	45 Degree Wedge Corner Unit	\$ 2,770	Bullnose Edge	20.625	27	39	135
	Linx	LX-223-32-SQ	ADA Unit	\$ 2,355	Square Edge	36	27	32	190
	Linx	LX-223-32-CH	ADA Unit	\$ 2,425	Chamfered Edge	36	27	32	190
	Linx	LX-223-32-BN	ADA Unit	\$ 2,425	Bullnose Edge	36	27	32	190
	Linx	LX-212-32-SQ	Closed Cupboard with Single Drawer	\$ 3,440	Square Edge	36	27	32	270
	Linx	LX-212-32-CH	Closed Cupboard with Single Drawer	\$ 3,510	Chamfered Edge	36	27	32	270
	Linx	LX-212-32-BN	Closed Cupboard with Single Drawer	\$ 3,510	Bullnose Edge	36	27	32	270
	Linx	LX-213-39-SQ	Hard Drive and Drawer Unit	\$ 4,300	Square Edge	36	27	39	270
	Linx	LX-213-39-CH	Hard Drive and Drawer Unit	\$ 4,375	Chamfered Edge	36	27	39	270
	Linx	LX-213-39-BN	Hard Drive and Drawer Unit	\$ 4,375	Bullnose Edge	36	27	39	270
	Linx	LX-214-32-SQ	Hard Drive and Open Shelf Unit	\$ 3,385	Square Edge	36	27	32	260





Image	Collection	Catalog Number	Item Description	List Price	Colour / Type	Width (Inches)	Depth (Inches)	Height (Inches)	Weight (Lbs.)
	Linx	LX-214-39-SQ	Hard Drive and Open Shelf Unit	\$ 3,385	Square Edge	36	27	39	260
	Linx	LX-214-32-CH	Hard Drive and Open Shelf Unit	\$ 3,460	Chamfered Edge	36	27	32	260
	Linx	LX-214-39-CH	Hard Drive and Open Shelf Unit	\$ 3,460	Chamfered Edge	36	27	39	260
	Linx	LX-214-32-BN	Hard Drive and Open Shelf Unit	\$ 3,460	Bullnose Edge	36	27	32	260
	Linx	LX-214-39-BN	Hard Drive and Open Shelf Unit	\$ 3,460	Bullnose Edge	36	27	39	260
	Linx	LX-215-32-SQ	Drawer and Cupboard Unit	\$ 4,355	Square Edge	36	27	32	270
	Linx	LX-215-39-SQ	Drawer and Cupboard Unit	\$ 4,355	Square Edge	36	27	39	270
	Linx	LX-215-32-CH	Drawer and Cupboard Unit	\$ 4,430	Chamfered Edge	36	27	32	270
	Linx	LX-215-39-CH	Drawer and Cupboard Unit	\$ 4,430	Chamfered Edge	36	27	39	270
	Linx	LX-215-32-BN	Drawer and Cupboard Unit	\$ 4,430	Bullnose Edge	36	27	32	270
	Linx	LX-215-39-BN	Drawer and Cupboard Unit	\$ 4,430	Bullnose Edge	36	27	39	270
	Linx	LX-216-32-SQ	Open Shelf and Drawer Unit	\$ 4,175	Square Edge	36	27	32	270
	Linx	LX-216-39-SQ	Open Shelf and Drawer Unit	\$ 4,175	Square Edge	36	27	39	270
	Linx	LX-216-32-CH	Open Shelf and Drawer Unit	\$ 4,245	Chamfered Edge	36	27	32	270
	Linx	LX-216-39-CH	Open Shelf and Drawer Unit	\$ 4,245	Chamfered Edge	36	27	39	270
	Linx	LX-216-32-BN	Open Shelf and Drawer Unit	\$ 4,245	Bullnose Edge	36	27	32	270
	Linx	LX-216-39-BN	Open Shelf and Drawer Unit	\$ 4,245	Bullnose Edge	36	27	39	270
	Linx	LX-218-32-SQ	Curved Desk Unit	\$ 4,640	Square Edge	65	29	32	320
	Linx	LX-218-39-SQ	Curved Desk Unit	\$ 4,640	Square Edge	65	29	39	320
	Linx	LX-218-32-CH	Curved Desk Unit	\$ 4,870	Chamfered Edge	65	29	32	320
	Linx	LX-218-39-CH	Curved Desk Unit	\$ 4,870	Chamfered Edge	65	29	39	320
	Linx	LX-218-32-BN	Curved Desk Unit	\$ 4,870	Bullnose Edge	65	29	32	320



Image	Collection	Catalog Number	Item Description	List Price	Colour / Type	Width (Inches)	Depth (Inches)	Height (Inches)	Weight (Lbs.)
	Linx	LX-218-39-BN	Curved Desk Unit	\$ 4,870	Bullnose Edge	65	29	39	320
	Linx	LX-218S-32-SQ	Curved Desk Unit with Surround	\$ 5,130	Square Edge	65	29	32	500
	Linx	LX-218S-39-SQ	Curved Desk Unit with Surround	\$ 5,130	Square Edge	65	29	39	500
	Linx	LX-218S-32-CH	Curved Desk Unit with Surround	\$ 5,390	Chamfered Edge	65	29	32	500
	Linx	LX-218S-39-CH	Curved Desk Unit with Surround	\$ 5,390	Chamfered Edge	65	29	39	500
	Linx	LX-218S-32-BN	Curved Desk Unit with Surround	\$ 5,390	Bullnose Edge	65	29	32	500
	Linx	LX-218S-39-BN	Curved Desk Unit with Surround	\$ 5,390	Bullnose Edge	65	29	39	500
		Linx	LX-225-SQ	Curved Desk Patron Ledge	\$ 2,145	Square Edge	65	8.5	7
Linx		LX-225-CH	Curved Desk Patron Ledge	\$ 2,250	Chamfered Edge	65	8.5	7	70
Linx		LX-225-BN	Curved Desk Patron Ledge	\$ 2,250	Bullnose Edge	65	8.5	7	70
	Linx	LX-220-36-SQ	Straight Patron Ledge, 36" Wide	\$ 845	Square Edge	36	8.5	7	30
	Linx	LX-220-36-CH	Straight Patron Ledge, 36" Wide	\$ 915	Chamfered Edge	36	8.5	7	30
	Linx	LX-220-36-BN	Straight Patron Ledge, 36" Wide	\$ 915	Bullnose Edge	36	8.5	7	30
	Linx	LX-220-48-SQ	Straight Patron Ledge, 48" Wide	\$ 900	Square Edge	48	8.5	7	40
	Linx	LX-220-48-CH	Straight Patron Ledge, 48" Wide	\$ 990	Chamfered Edge	48	8.5	7	40
	Linx	LX-220-48-BN	Straight Patron Ledge, 48" Wide	\$ 990	Bullnose Edge	48	8.5	7	40
	Linx	LX-220-60-SQ	Straight Patron Ledge, 60" Wide	\$ 955	Square Edge	60	8.5	7	50
	Linx	LX-220-60-CH	Straight Patron Ledge, 60" Wide	\$ 1,070	Chamfered Edge	60	8.5	7	50
	Linx	LX-220-60-BN	Straight Patron Ledge, 60" Wide	\$ 1,070	Bullnose Edge	60	8.5	7	50
	Linx	LX-220-72-SQ	Straight Patron Ledge, 72" Wide	\$ 1,010	Square Edge	72	8.5	7	60
	Linx	LX-220-72-CH	Straight Patron Ledge, 72" Wide	\$ 1,150	Chamfered Edge	72	8.5	7	60
	Linx	LX-220-72-BN	Straight Patron Ledge, 72" Wide	\$ 1,150	Bullnose Edge	72	8.5	7	60





Image	Collection	Catalog Number	Item Description	List Price	Colour / Type	Width (Inches)	Depth (Inches)	Height (Inches)	Weight (Lbs.)
	Linx	LX-220S-SQ	Square Corner Patron Ledge	\$ 1,255	Square Edge	27	8.5	7	40
	Linx	LX-220S-CH	Square Corner Patron Ledge	\$ 1,325	Chamfered Edge	27	8.5	7	40
	Linx	LX-220S-BN	Square Corner Patron Ledge	\$ 1,325	Bullnose Edge	27	8.5	7	40
	Linx	LX-220C-SQ	Curved Corner Patron Ledge	\$ 1,505	Square Edge	27	8.5	7	40
	Linx	LX-220C-CH	Curved Corner Patron Ledge	\$ 1,585	Chamfered Edge	27	8.5	7	40
	Linx	LX-220C-BN	Curved Corner Patron Ledge	\$ 1,585	Bullnose Edge	27	8.5	7	40
	Linx	LX-220CD-SQ	Corner Desk Patron Ledge	\$ 1,950	Square Edge	65	8.5	7	70
	Linx	LX-220CD-CH	Corner Desk Patron Ledge	\$ 2,095	Chamfered Edge	65	8.5	7	70
	Linx	LX-220CD-BN	Corner Desk Patron Ledge	\$ 2,095	Bullnose Edge	65	8.5	7	70
	Linx	LX-222-32-SQ	End Panel	\$ 615	Square Edge	32	27.25		50
	Linx	LX-222-39-SQ	End Panel	\$ 615	Square Edge	39	27.25		50
	Linx	LX-222-32-CH	End Panel	\$ 615	Chamfered Edge	32	27.25		50
	Linx	LX-222-39-CH	End Panel	\$ 615	Chamfered Edge	39	27.25		50
	Linx	LX-222-32-BN	End Panel	\$ 615	Bullnose Edge	32	27.25		50
	Linx	LX-222-39-BN	End Panel	\$ 615	Bullnose Edge	39	27.25		50
	Gemini	GS-200-32-SQ	Open Shelf Unit	\$ 1,830	Square Edge	34	30	32	235
	Gemini	GS-200-39-SQ	Open Shelf Unit	\$ 1,830	Square Edge	34	30	39	235
	Gemini	GS-200-32-BN	Open Shelf Unit	\$ 1,900	Bullnose Edge	34	30	32	235
	Gemini	GS-200-39-BN	Open Shelf Unit	\$ 1,900	Bullnose Edge	34	30	39	235







Image	Collection	Catalog Number	Item Description	List Price	Colour / Type	Width (Inches)	Depth (Inches)	Height (Inches)	Weight (Lbs.)
	Gemini	GS-201-32-SQ	Cupboard Unit	\$ 2,425	Square Edge	34	30	32	260
	Gemini	GS-201-39-SQ	Cupboard Unit	\$ 2,425	Square Edge	34	30	39	260
	Gemini	GS-201-32-BN	Cupboard Unit	\$ 2,495	Bullnose Edge	34	30	32	260
	Gemini	GS-201-39-BN	Cupboard Unit	\$ 2,495	Bullnose Edge	34	30	39	260
	Gemini	GS-202T-32-SQ	Closed Triangular Corner Unit	\$ 2,320	Square Edge	30	30	32	160
	Gemini	GS-202T-39-SQ	Closed Triangular Corner Unit	\$ 2,320	Square Edge	30	30	39	160
	Gemini	GS-202T-32-BN	Closed Triangular Corner Unit	\$ 2,395	Bullnose Edge	30	30	32	160
	Gemini	GS-202T-39-BN	Closed Triangular Corner Unit	\$ 2,395	Bullnose Edge	30	30	39	160
	Gemini	GS-202C-32-SQ	Closed Curved Corner Unit	\$ 3,145	Square Edge	30	30	32	160
	Gemini	GS-202C-39-SQ	Closed Curved Corner Unit	\$ 3,145	Square Edge	30	30	39	160
	Gemini	GS-202C-32-BN	Closed Curved Corner Unit	\$ 3,220	Bullnose Edge	30	30	32	160
	Gemini	GS-202C-39-BN	Closed Curved Corner Unit	\$ 3,220	Bullnose Edge	30	30	39	160
	Gemini	GS-202S-32-SQ	Closed Square Corner Unit	\$ 2,105	Square Edge	30	30	32	160
	Gemini	GS-202S-39-SQ	Closed Square Corner Unit	\$ 2,105	Square Edge	30	30	39	160
	Gemini	GS-202S-32-BN	Closed Square Corner Unit	\$ 2,180	Bullnose Edge	30	30	32	160
	Gemini	GS-202S-39-BN	Closed Square Corner Unit	\$ 2,180	Bullnose Edge	30	30	39	160
	Gemini	GS-203-32-SQ	Knee Space Unit with Cash and Pencil Drawer	\$ 2,260	Square Edge	34	30	32	210
	Gemini	GS-203-39-SQ	Knee Space Unit with Cash and Pencil Drawer	\$ 2,260	Square Edge	34	30	39	210
	Gemini	GS-203-32-BN	Knee Space Unit with Cash and Pencil Drawer	\$ 2,330	Bullnose Edge	34	30	32	210
	Gemini	GS-203-39-BN	Knee Space Unit with Cash and Pencil Drawer	\$ 2,330	Bullnose Edge	34	30	39	210
	Gemini	GS-204-32-SQ	Open Triangle Corner Unit	\$ 1,965	Square Edge	30	30	32	150
	Gemini	GS-204-39-SQ	Open Triangle Corner Unit	\$ 1,965	Square Edge	30	30	39	150

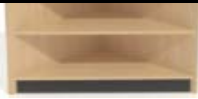



Image	Collection	Catalog Number	Item Description	List Price	Colour / Type	Width (Inches)	Depth (Inches)	Height (Inches)	Weight (Lbs.)
	Gemini	GS-204-32-BN	Open Triangle Corner Unit	\$ 2,045	Bullnose Edge	30	30	32	150
	Gemini	GS-204-39-BN	Open Triangle Corner Unit	\$ 2,045	Bullnose Edge	30	30	39	150
	Gemini	GS-206-32-SQ	Single Drawer Charge Unit	\$ 2,180	Square Edge	34	30	32	220
	Gemini	GS-206-39-SQ	Single Drawer Charge Unit	\$ 2,180	Square Edge	34	30	39	220
	Gemini	GS-206-32-BN	Single Drawer Charge Unit	\$ 2,250	Bullnose Edge	34	30	32	220
	Gemini	GS-206-39-BN	Single Drawer Charge Unit	\$ 2,250	Bullnose Edge	34	30	39	220
	Gemini	GS-207-32-SQ	Single Drawer Open Shelf Unit	\$ 2,320	Square Edge	34	30	32	250
	Gemini	GS-207-39-SQ	Single Drawer Open Shelf Unit	\$ 2,320	Square Edge	34	30	39	250
	Gemini	GS-207-32-BN	Single Drawer Open Shelf Unit	\$ 2,395	Bullnose Edge	34	30	32	250
	Gemini	GS-207-39-BN	Single Drawer Open Shelf Unit	\$ 2,395	Bullnose Edge	34	30	39	250
	Gemini	GS-208-32-SQ	Book Return Unit	\$ 1,755	Square Edge	34	30	32	185
	Gemini	GS-208-39-SQ	Book Return Unit	\$ 1,755	Square Edge	34	30	39	185
	Gemini	GS-208-32-BN	Book Return Unit	\$ 1,825	Bullnose Edge	34	30	32	185
	Gemini	GS-208-39-BN	Book Return Unit	\$ 1,825	Bullnose Edge	34	30	39	185
	Gemini	GS-209-3632-SQ	Desk Unit with Patron, 34" Width	\$ 2,080	Square Edge	34	30	32	200
	Gemini	GS-209-3639-SQ	Desk Unit with Patron, 34" Width	\$ 2,080	Square Edge	34	30	39	200
	Gemini	GS-209-3632-BN	Desk Unit with Patron, 34" Width	\$ 2,145	Bullnose Edge	34	30	32	200
	Gemini	GS-209-3639-BN	Desk Unit with Patron, 34" Width	\$ 2,145	Bullnose Edge	34	30	39	200
	Gemini	GS-209-4832-SQ	Desk Unit with Patron, 46" Width	\$ 2,200	Square Edge	46	30	32	250
	Gemini	GS-209-4839-SQ	Desk Unit with Patron, 46" Width	\$ 2,200	Square Edge	46	30	39	250
	Gemini	GS-209-4832-BN	Desk Unit with Patron, 46" Width	\$ 2,290	Bullnose Edge	46	30	32	250

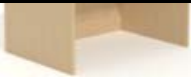

Image	Collection	Catalog Number	Item Description	List Price	Colour / Type	Width (Inches)	Depth (Inches)	Height (Inches)	Weight (Lbs.)
	Gemini	GS-209-4839-BN	Desk Unit with Patron, 46" Width	\$ 2,290	Bullnose Edge	46	30	39	250
	Gemini	GS-209-6032-SQ	Desk Unit with Patron, 58" Width	\$ 2,405	Square Edge	58	30	32	320
	Gemini	GS-209-6039-SQ	Desk Unit with Patron, 58" Width	\$ 2,405	Square Edge	58	30	39	320
	Gemini	GS-209-6032-BN	Desk Unit with Patron, 58" Width	\$ 2,515	Bullnose Edge	58	30	32	320
	Gemini	GS-209-6039-BN	Desk Unit with Patron, 58" Width	\$ 2,515	Bullnose Edge	58	30	39	320
	Gemini	GS-209-7232-SQ	Desk Unit with Patron, 70" Width	\$ 2,525	Square Edge	70	30	32	390
	Gemini	GS-209-7239-SQ	Desk Unit with Patron, 70" Width	\$ 2,525	Square Edge	70	30	39	390
	Gemini	GS-209-7232-BN	Desk Unit with Patron, 70" Width	\$ 2,655	Bullnose Edge	70	30	32	390
	Gemini	GS-209-7239-BN	Desk Unit with Patron, 70" Width	\$ 2,655	Bullnose Edge	70	30	39	390
	Gemini	GS-209CD-32-SQ	Corner Desk Unit with Surround	\$ 3,740	Square Edge	68.75	32	32	500
	Gemini	GS-209CD-39-SQ	Corner Desk Unit with Surround	\$ 3,740	Square Edge	68.75	32	39	500
	Gemini	GS-209CD-32-BN	Corner Desk Unit with Surround	\$ 4,165	Bullnose Edge	68.75	32	32	500
	Gemini	GS-209CD-39-BN	Corner Desk Unit with Surround	\$ 4,165	Bullnose Edge	68.75	32	39	500
	Gemini	GS-219-3632-SQ	Desk Unit, 34" Width	\$ 1,690	Square Edge	34	30	32	200
	Gemini	GS-219-3639-SQ	Desk Unit, 34" Width	\$ 1,690	Square Edge	34	30	39	200
	Gemini	GS-219-3632-BN	Desk Unit, 34" Width	\$ 1,760	Bullnose Edge	34	30	32	200
	Gemini	GS-219-3639-BN	Desk Unit, 34" Width	\$ 1,760	Bullnose Edge	34	30	39	200
	Gemini	GS-219-4832-SQ	Desk Unit, 46" Width	\$ 1,785	Square Edge	46	30	32	250
	Gemini	GS-219-4839-SQ	Desk Unit, 46" Width	\$ 1,785	Square Edge	46	30	39	250
	Gemini	GS-219-4832-BN	Desk Unit, 46" Width	\$ 1,830	Bullnose Edge	46	30	32	250
	Gemini	GS-219-4839-BN	Desk Unit, 46" Width	\$ 1,830	Bullnose Edge	46	30	39	250





Image	Collection	Catalog Number	Item Description	List Price	Colour / Type	Width (Inches)	Depth (Inches)	Height (Inches)	Weight (Lbs.)
	Gemini	GS-219-6032-SQ	Desk Unit, 58" Width	\$ 1,965	Square Edge	58	30	32	320
	Gemini	GS-219-6039-SQ	Desk Unit, 58" Width	\$ 1,965	Square Edge	58	30	39	320
	Gemini	GS-219-6032-BN	Desk Unit, 58" Width	\$ 2,080	Bullnose Edge	58	30	32	320
	Gemini	GS-219-6039-BN	Desk Unit, 58" Width	\$ 2,080	Bullnose Edge	58	30	39	320
	Gemini	GS-219-7232-SQ	Desk Unit, 70" Width	\$ 2,060	Square Edge	70	30	32	390
	Gemini	GS-219-7239-SQ	Desk Unit, 70" Width	\$ 2,060	Square Edge	70	30	39	390
	Gemini	GS-219-7232-BN	Desk Unit, 70" Width	\$ 2,200	Bullnose Edge	70	30	32	390
	Gemini	GS-219-7239-BN	Desk Unit, 70" Width	\$ 2,200	Bullnose Edge	70	30	39	390
	Gemini	GS-219CD-32-SQ	Corner Desk Unit	\$ 2,985	Square Edge	68.75	32	32	500
	Gemini	GS-219CD-39-SQ	Corner Desk Unit	\$ 2,985	Square Edge	68.75	32	39	500
	Gemini	GS-219CD-32-BN	Corner Desk Unit	\$ 3,210	Bullnose Edge	68.75	32	32	500
	Gemini	GS-219CD-39-BN	Corner Desk Unit	\$ 3,210	Bullnose Edge	68.75	32	39	500
	Gemini	GS-212-39-SQ	Closed Cupboard with Single Drawer	\$ 2,795	Square Edge	34	30	39	270
	Gemini	GS-212-39-BN	Closed Cupboard with Single Drawer	\$ 2,865	Bullnose Edge	34	30	39	270
	Gemini	GS-213-39-SQ	Hard Drive and Drawer Unit	\$ 4,330	Square Edge	34	30	39	270
	Gemini	GS-213-39-BN	Hard Drive and Drawer Unit	\$ 4,400	Bullnose Edge	34	30	39	270
	Gemini	GS-214-32-SQ	Hard Drive and Open Shelf Unit	\$ 3,415	Square Edge	34	30	32	260





Image	Collection	Catalog Number	Item Description	List Price	Colour / Type	Width (Inches)	Depth (Inches)	Height (Inches)	Weight (Lbs.)
	Gemini	GS-214-39-SQ	Hard Drive and Open Shelf Unit	\$ 3,415	Square Edge	34	30	39	260
	Gemini	GS-214-32-BN	Hard Drive and Open Shelf Unit	\$ 3,485	Bullnose Edge	34	30	32	260
	Gemini	GS-214-39-BN	Hard Drive and Open Shelf Unit	\$ 3,485	Bullnose Edge	34	30	39	260
	Gemini	GS-215-32-SQ	Drawer and Cupboard Unit	\$ 4,345	Square Edge	34	30	32	270
	Gemini	GS-215-39-SQ	Drawer and Cupboard Unit	\$ 4,345	Square Edge	34	30	39	270
	Gemini	GS-215-32-BN	Drawer and Cupboard Unit	\$ 4,415	Bullnose Edge	34	30	32	270
	Gemini	GS-215-39-BN	Drawer and Cupboard Unit	\$ 4,415	Bullnose Edge	34	30	39	270
	Gemini	GS-216-32-SQ	Open Shelf and Drawer Unit	\$ 4,200	Square Edge	34	30	32	270
	Gemini	GS-216-39-SQ	Open Shelf and Drawer Unit	\$ 4,200	Square Edge	34	30	39	270
	Gemini	GS-216-32-BN	Open Shelf and Drawer Unit	\$ 4,270	Bullnose Edge	34	30	32	270
	Gemini	GS-216-39-BN	Open Shelf and Drawer Unit	\$ 4,270	Bullnose Edge	34	30	39	270
	Gemini	GS-218-32-SQ	Curved Desk Unit	\$ 4,195	Square Edge	68	32	32	320
	Gemini	GS-218-39-SQ	Curved Desk Unit	\$ 4,195	Square Edge	68	32	39	320
	Gemini	GS-218-32-BN	Curved Desk Unit	\$ 4,405	Bullnose Edge	68	32	32	320
	Gemini	GS-218-39-BN	Curved Desk Unit	\$ 4,405	Bullnose Edge	68	32	39	320
	Gemini	GS-218S-32-SQ	Curved Corner Desk with Surround	\$ 4,990	Square Edge	68	32	32	500
	Gemini	GS-218S-39-SQ	Curved Corner Desk with Surround	\$ 4,990	Square Edge	68	32	39	500
	Gemini	GS-218S-32-BN	Curved Corner Desk with Surround	\$ 5,240	Bullnose Edge	68	32	32	500
	Gemini	GS-218S-39-BN	Curved Corner Desk with Surround	\$ 5,240	Bullnose Edge	68	32	39	500





Image	Collection	Catalog Number	Item Description	List Price	Colour / Type	Width (Inches)	Depth (Inches)	Height (Inches)	Weight (Lbs.)
	Gemini	GS-223-32-SQ	ADA Unit	\$ 1,740	Square Edge	68	32	32	200
	Gemini	GS-223-32-BN	ADA Unit	\$ 1,815	Bullnose Edge	68	32	32	500
	Gemini	GS-225-SQ	Curved Corner Desk Patron Ledge	\$ 2,400	Square Edge	68	8.5	7	70
	Gemini	GS-225-BN	Curved Corner Desk Patron Ledge	\$ 2,520	Bullnose Edge	68	8.5	7	70
	Gemini	GS-220-36-SQ	Straight Patron Ledge, 36" Wide	\$ 845	Square Edge	36	8.5	7	30
	Gemini	GS-220-36-BN	Straight Patron Ledge, 36" Wide	\$ 915	Bullnose Edge	36	8.5	7	30
	Gemini	GS-220-48-SQ	Straight Patron Ledge, 48" Wide	\$ 900	Square Edge	48	8.5	7	40
	Gemini	GS-220-48-BN	Straight Patron Ledge, 48" Wide	\$ 990	Bullnose Edge	48	8.5	7	40
	Gemini	GS-220-60-SQ	Straight Patron Ledge, 60" Wide	\$ 950	Square Edge	60	8.5	7	50
	Gemini	GS-220-60-BN	Straight Patron Ledge, 60" Wide	\$ 1,070	Bullnose Edge	60	8.5	7	50
	Gemini	GS-220-72-SQ	Straight Patron Ledge, 72" Wide	\$ 1,005	Square Edge	72	8.5	7	60
	Gemini	GS-220-72-BN	Straight Patron Ledge, 72" Wide	\$ 1,145	Bullnose Edge	72	8.5	7	60
	Gemini	GS-220S-SQ	Square Corner Patron Ledge	\$ 1,275	Square Edge	29	8.5	7	40
	Gemini	GS-220S-BN	Square Corner Patron Ledge	\$ 1,355	Bullnose Edge	29	8.5	7	40

Image	Collection	Catalog Number	Item Description	List Price	Colour / Type	Width (Inches)	Depth (Inches)	Height (Inches)	Weight (Lbs.)
	Gemini	GS-220C-SQ	Curved Corner Patron Ledge	\$ 1,450	Square Edge	29	8.5	7	40
	Gemini	GS-220C-BN	Curved Corner Patron Ledge	\$ 1,525	Bullnose Edge	29	8.5	7	40
	Gemini	GS-220CD-SQ	Corner Desk Patron Ledge	\$ 2,005	Square Edge	68.75	8.5	7	70
	Gemini	GS-220CD-BN	Corner Desk Patron Ledge	\$ 2,220	Bullnose Edge	68.75	8.5	7	70
	Gemini	GS-EP-32	End and Intermediate Panel	\$ 620		32	30.5		50
	Gemini	GS-EP-39	End and Intermediate Panel	\$ 620		39	30.5		50
	Gemini	GS-MP-32	End and Intermediate Panel	\$ 700		32	30.5		50
	Gemini	GS-MP-39	End and Intermediate Panel	\$ 700		39	30.5		50
	Aspen	AP-NP	Newspaper Table	\$ 2,710		39.5	27	30	180
	Aspen	AP-AS	Atlas Stand	\$ 4,040		30.5	29	44.5	260







Image	Collection	Catalog Number	Item Description	List Price	Colour / Type	Width (Inches)	Depth (Inches)	Height (Inches)	Weight (Lbs.)
	Aspen	AP-DC	Dictionary Stand	\$ 3,005		27.5	21	44.5	180
	Aspen	AP-DP	Display Table	\$ 6,670		30.5	62.5	39	245
	Aspen	AP-DP-FB	Display Table	\$ 7,335	Fabric Covered Bottom	30.5	62.5	39	245
	Aspen	AP-AV	AV Browser	\$ 3,100		50.25	23	42.5	260
	Aspen	AP-MC-36-SS	Modular Panel Carrel: S/F	\$ 3,305	Starter - 36" Width	38.5	31	48	340
	Aspen	AP-MC-36-SA	Modular Panel Carrel: S/F	\$ 2,175	Adder - 36" Width	36.25	31	48	160
	Aspen	AP-MC-48-SS	Modular Panel Carrel: S/F	\$ 3,405	Starter - 48" Width	50.5	31	48	360
	Aspen	AP-MC-48-SA	Modular Panel Carrel: S/F	\$ 2,275	Adder - 48" Width	48.25	31	48	190
	Aspen	AP-MC-36-DS	Modular Panel Carrel: D/F	\$ 4,615	Starter - 36" Width	38.5	60.5	48	655

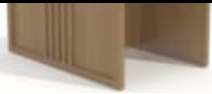











Image	Collection	Catalog Number	Item Description	List Price	Colour / Type	Width (Inches)	Depth (Inches)	Height (Inches)	Weight (Lbs.)
	Aspen	AP-MC-36-DA	Modular Panel Carrel: D/F	\$ 2,930	Adder - 36" Width	36.25	60.5	48	250
	Aspen	AP-MC-48-DS	Modular Panel Carrel: D/F	\$ 4,755	Starter - 48" Width	50.5	60.5	48	710
	Aspen	AP-MC-48-DA	Modular Panel Carrel: D/F	\$ 3,075	Adder - 48" Width	48.25	60.5	48	310
	Aspen	AP-MC-36-PW	Modular Panel Carrel: Pinwheel	\$ 7,630	36" Width	74.5	74.5	48	780
	Aspen	AP-MC-48-PW	Modular Panel Carrel: Pinwheel	\$ 7,900	48" Width	91.5	91.5	48	800
	Aspen	AP-RC-36-SS	Panel Reference Carrel: S/F	\$ 3,380	Starter - 36" Width	38.5	31	48	340
	Aspen	AP-RC-36-SA	Panel Reference Carrel: S/F	\$ 2,170	Adder - 36" Width	36.25	31	48	160
	Aspen	AP-RC-48-SS	Panel Reference Carrel: S/F	\$ 3,480	Starter - 48" Width	50.5	31	48	360
	Aspen	AP-RC-48-SA	Panel Reference Carrel: S/F	\$ 2,265	Adder - 48" Width	48.25	31	48	190
	Aspen	AP-RC-36-DS	Panel Reference Carrels: D/F	\$ 4,605	Starter - 36" Width	38.5	60.5	48	655
	Aspen	AP-RC-36-DA	Panel Reference Carrels: D/F	\$ 2,915	Adder - 36" Width	36.25	60.5	48	250
	Aspen	AP-RC-48-DS	Panel Reference Carrels: D/F	\$ 4,740	Starter - 48" Width	50.5	60.5	48	710
	Aspen	AP-RC-48-DA	Panel Reference Carrels: D/F	\$ 3,060	Adder - 48" Width	48.25	60.5	48	310







Image	Collection	Catalog Number	Item Description	List Price	Colour / Type	Width (Inches)	Depth (Inches)	Height (Inches)	Weight (Lbs.)
	Aspen	AP-RC-36-PW	Aspen: Panel Reference Carrel: Pinwheel	\$ 7,610	36" Width	74.5	74.5	48	780
	Aspen	AP-RC-48-PW	Aspen: Panel Reference Carrel: Pinwheel	\$ 7,710	48" Width	91.5	91.5	48	800
	Aspen	AP-PAC-1-PB-29	PAC Table: 1 Person	\$ 3,035	Sitting Hgt.	37.5	36	37	130
	Aspen	AP-PAC-1-PB-32	PAC Table: 1 Person	\$ 3,120	Wheelchair Hgt.	37.5	36	40	130
	Aspen	AP-PAC-1-PB-39	PAC Table: 1 Person	\$ 3,300	Standing Hgt.	37.5	36	47	135
	Aspen	AP-PAC-2-PB-29	PAC Table: 2 Person	\$ 3,560	Sitting Hgt.	73.5	36	37	200
	Aspen	AP-PAC-2-PB-32	PAC Table: 2 Person	\$ 3,650	Wheelchair Hgt.	73.5	36	40	200
	Aspen	AP-PAC-2-PB-39	PAC Table: 2 Person	\$ 3,810	Standing Hgt.	73.5	36	47	205
	Aspen	AP-PAC-3-PB-29	PAC Table: 3 Person	\$ 3,915	Sitting Hgt.	91.5	36	37	250
	Aspen	AP-PAC-3-PB-32	PAC Table: 3 Person	\$ 3,995	Wheelchair Hgt.	91.5	36	40	250
	Aspen	AP-PAC-3-PB-39	PAC Table: 3 Person	\$ 4,165	Standing Hgt.	91.5	36	47	260
	Aspen	AP-R42	Round Table	\$ 1,810		42	42	29	90
	Aspen	AP-R48	Round Table	\$ 1,900		48	48	29	100
	Aspen	AP-4242	Square Table	\$ 2,295		42	42	29	90
	Aspen	AP-4848	Square Table	\$ 2,450		48	48	29	100
	Aspen	AP-6036	Rectangular Table: 60" Wide	\$ 3,035		60	36	29	
	Aspen	AP-6048	Rectangular Table: 60" Wide	\$ 3,255		60	48	29	



Image	Collection	Catalog Number	Item Description	List Price	Colour / Type	Width (Inches)	Depth (Inches)	Height (Inches)	Weight (Lbs.)
	Aspen	AP-7236	Rectangular Table: 72" Wide	\$ 3,175		72	36	29	
	Aspen	AP-7248	Rectangular Table: 72" Wide	\$ 3,405		72	48	29	
	Aspen	AP-8436	Rectangular Table: 84" Wide	\$ 3,310		84	36	29	
	Aspen	AP-8448	Rectangular Table: 84" Wide	\$ 3,555		84	48	29	
	Aspen	AP-9636	Rectangular Table: 96" Wide	\$ 3,455		96	36	29	
	Aspen	AP-9648	Rectangular Table: 96" Wide	\$ 3,700		96	48	29	
	Bannister	BA-NP	Newspaper Table	\$ 3,095		38.25	27	29.5	180
	Bannister	BA-AS	Atlas Stand	\$ 4,290		31.75	26.5	43.375	260





Image	Collection	Catalog Number	Item Description	List Price	Colour / Type	Width (Inches)	Depth (Inches)	Height (Inches)	Weight (Lbs.)
	Bannister	BA-DC	Dictionary Stand	\$ 3,060		26.5	17.25	42	180
	Bannister	BA-DP	Display Table	\$ 8,250		32.5	64.5	39	245
	Bannister	BA-DP-FB	Display Table	\$ 8,915	With Fabric Bottom	32.5	64.5	39	170
	Bannister	BA-SC-S	Study Carrel Table: Single	\$ 5,195					
	Bannister	BA-SC-D	Study Carrel Table: Double	\$ 7,095					















Image	Collection	Catalog Number	Item Description	List Price	Colour / Type	Width (Inches)	Depth (Inches)	Height (Inches)	Weight (Lbs.)
	Bannister	BA-SC-Q	Study Carrel Table: Four Place	\$ 9,315					
	Bannister	BA-MC-V1A-36-SS	Modular Carrels, Version 1 Acrylic Style, S/F	\$ 4,575	Starter - 36" Width	37.25	31	48.5	200
	Bannister	BA-MC-V1A-36-SA	Modular Carrels, Version 1 Acrylic Style, S/F	\$ 3,240	Adder - 36" Width	36.125	31	48.5	150
	Bannister	BA-MC-V1A-48-SS	Modular Carrels, Version 1 Acrylic Style, S/F	\$ 4,690	Starter - 48" Width	49.25	31	48.5	230
	Bannister	BA-MC-V1A-48-SA	Modular Carrels, Version 1 Acrylic Style, S/F	\$ 3,355	Adder - 48" Width	48.125	31	48.5	180
	Bannister	BA-MC-V1A-36-DS	Modular Carrels, Version 1 Acrylic Style, D/F	\$ 6,955	Starter - 36" Width	37.25	59.5	48.5	350
	Bannister	BA-MC-V1A-36-DA	Modular Carrels, Version 1 Acrylic Style, D/F	\$ 4,555	Adder - 36" Width	36.125	59.5	48.5	240
	Bannister	BA-MC-V1A-48-DS	Modular Carrels, Version 1 Acrylic Style, D/F	\$ 7,135	Starter - 48" Width	49.25	59.5	48.5	410
	Bannister	BA-MC-V1A-48-DA	Modular Carrels, Version 1 Acrylic Style, D/F	\$ 4,735	Adder - 48" Width	48.125	59.5	48.5	310
	Bannister	BA-MC-V1M-36-SS	Modular Carrels, Version 1 Molding Style, S/F	\$ 4,835	Starter - 36" Width	37.25	31	48.5	200
	Bannister	BA-MC-V1M-36-SA	Modular Carrels, Version 1 Molding Style, S/F	\$ 3,240	Adder - 36" Width	36.125	31	48.5	150
	Bannister	BA-MC-V1M-48-SS	Modular Carrels, Version 1 Molding Style, S/F	\$ 4,950	Starter - 48" Width	49.25	31	48.5	230
	Bannister	BA-MC-V1M-48-SA	Modular Carrels, Version 1 Molding Style, S/F	\$ 3,355	Adder - 48" Width	48.125	31	48.5	180
	Bannister	BA-MC-V1M-36-DS	Modular Carrels, Version 1 Molding Style, D/F	\$ 7,545	Starter - 36" Width	37.25	59.5	48.5	350



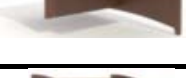











Image	Collection	Catalog Number	Item Description	List Price	Colour / Type	Width (Inches)	Depth (Inches)	Height (Inches)	Weight (Lbs.)
	Bannister	BA-MC-V1M-36-DA	Modular Carrels, Version 1 Molding Style, D/F	\$ 4,555	Adder - 36" Width	36.125	59.5	48.5	240
	Bannister	BA-MC-V1M-48-DS	Modular Carrels, Version 1 Molding Style, D/F	\$ 7,730	Starter - 48" Width	49.25	59.5	48.5	410
	Bannister	BA-MC-V1M-48-DA	Modular Carrels, Version 1 Molding Style, D/F	\$ 4,735	Adder - 48" Width	48.125	59.5	48.5	310
	Bannister	BA-MC-V1S-36-SS	Modular Carrels, Version 1 Shaker Style, S/F	\$ 4,435	Starter - 36" Width	37.25	31	48.5	200
	Bannister	BA-MC-V1S-36-SA	Modular Carrels, Version 1 Shaker Style, S/F	\$ 3,240	Adder - 36" Width	36.125	31	48.5	150
	Bannister	BA-MC-V1S-48-SS	Modular Carrels, Version 1 Shaker Style, S/F	\$ 4,550	Starter - 48" Width	49.25	31	48.5	230
	Bannister	BA-MC-V1S-48-SA	Modular Carrels, Version 1 Shaker Style, S/F	\$ 3,355	Adder - 48" Width	48.125	31	48.5	180
	Bannister	BA-MC-V1S-36-DS	Modular Carrels, Version 1 Shaker Style, D/F	\$ 6,670	Starter - 36" Width	37.25	59.5	48.5	350
	Bannister	BA-MC-V1S-36-DA	Modular Carrels, Version 1 Shaker Style, D/F	\$ 4,555	Adder - 36" Width	36.125	59.5	48.5	240
	Bannister	BA-MC-V1S-48-DS	Modular Carrels, Version 1 Shaker Style, D/F	\$ 6,855	Starter - 48" Width	49.25	59.5	48.5	410
	Bannister	BA-MC-V1S-48-DA	Modular Carrels, Version 1 Shaker Style, D/F	\$ 4,735	Adder - 48" Width	48.125	59.5	48.5	310
	Bannister	BA-MC-V2A-36-SS	Modular Carrels, Version 2 Acrylic Style, S/F	\$ 4,370	Starter - 36" Width	37.25	31	48.5	200
	Bannister	BA-MC-V2A-36-SA	Modular Carrels, Version 2 Acrylic Style, S/F	\$ 3,240	Adder - 36" Width	36.125	31	48.5	150
	Bannister	BA-MC-V2A-48-SS	Modular Carrels, Version 2 Acrylic Style, S/F	\$ 4,485	Starter - 48" Width	49.25	31	48.5	230
	Bannister	BA-MC-V2A-48-SA	Modular Carrels, Version 2 Acrylic Style, S/F	\$ 3,355	Adder - 48" Width	48.125	31	48.5	180





Image	Collection	Catalog Number	Item Description	List Price	Colour / Type	Width (Inches)	Depth (Inches)	Height (Inches)	Weight (Lbs.)
	Bannister	BA-MC-V2A-36-DS	Modular Carrels, Version 2 Acrylic Style, D/F	\$ 6,830	Starter - 36" Width	37.25	59.5	48.5	350
	Bannister	BA-MC-V2A-36-DA	Modular Carrels, Version 2 Acrylic Style, D/F	\$ 4,555	Adder - 36" Width	36.125	59.5	48.5	240
	Bannister	BA-MC-V2A-48-DS	Modular Carrels, Version 2 Acrylic Style, D/F	\$ 7,015	Starter - 48" Width	49.25	59.5	48.5	410
	Bannister	BA-MC-V2A-48-DA	Modular Carrels, Version 2 Acrylic Style, D/F	\$ 4,735	Adder - 48" Width	48.125	59.5	48.5	310
	Bannister	BA-MC-V2M-36-SS	Modular Carrels, Version 2 Molding Style, S/F	\$ 4,645	Starter - 36" Width	37.25	31	48.5	200
	Bannister	BA-MC-V2M-36-SA	Modular Carrels, Version 2 Molding Style, S/F	\$ 3,240	Adder - 36" Width	36.125	31	48.5	150
	Bannister	BA-MC-V2M-48-SS	Modular Carrels, Version 2 Molding Style, S/F	\$ 4,760	Starter - 48" Width	49.25	31	48.5	230
	Bannister	BA-MC-V2M-48-SA	Modular Carrels, Version 2 Molding Style, S/F	\$ 3,355	Adder - 48" Width	48.125	31	48.5	180
	Bannister	BA-MC-V2M-36-DS	Modular Carrels, Version 2 Molding Style, D/F	\$ 7,235	Starter - 36" Width	37.25	59.5	48.5	350
	Bannister	BA-MC-V2M-36-DA	Modular Carrels, Version 2 Molding Style, D/F	\$ 4,555	Adder - 36" Width	36.125	59.5	48.5	240
	Bannister	BA-MC-V2M-48-DS	Modular Carrels, Version 2 Molding Style, D/F	\$ 7,420	Starter - 48" Width	49.25	59.5	48.5	410
	Bannister	BA-MC-V2M-48-DA	Modular Carrels, Version 2 Molding Style, D/F	\$ 4,735	Adder - 48" Width	48.125	59.5	48.5	310
	Bannister	BA-MC-V2S-36-SS	Modular Carrels, Version 2 Shaker Style, S/F	\$ 4,250	Starter - 36" Width	37.25	31	48.5	200
	Bannister	BA-MC-V2S-36-SA	Modular Carrels, Version 2 Shaker Style, S/F	\$ 3,240	Adder - 36" Width	36.125	31	48.5	150
	Bannister	BA-MC-V2S-48-SS	Modular Carrels, Version 2 Shaker Style, S/F	\$ 4,370	Starter - 48" Width	49.25	31	48.5	230

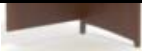



Image	Collection	Catalog Number	Item Description	List Price	Colour / Type	Width (Inches)	Depth (Inches)	Height (Inches)	Weight (Lbs.)
	Bannister	BA-MC-V2S-48-SA	Modular Carrels, Version 2 Shaker Style, S/F	\$ 3,355	Adder - 48" Width	48.125	31	48.5	180
	Bannister	BA-MC-V2S-36-DS	Modular Carrels, Version 2 Shaker Style, D/F	\$ 6,595	Starter - 36" Width	37.25	59.5	48.5	350
	Bannister	BA-MC-V2S-36-DA	Modular Carrels, Version 2 Shaker Style, D/F	\$ 4,555	Adder - 36" Width	36.125	59.5	48.5	240
	Bannister	BA-MC-V2S-48-DS	Modular Carrels, Version 2 Shaker Style, D/F	\$ 6,775	Starter - 48" Width	49.25	59.5	48.5	410
	Bannister	BA-MC-V2S-48-DA	Modular Carrels, Version 2 Shaker Style, D/F	\$ 4,735	Adder - 48" Width	48.125	59.5	48.5	310
	Bannister	BA-MC-V3A-36-SS	Modular Carrels, Version 3 Acrylic Style, S/F	\$ 4,575	Starter - 36" Width	37.25	31	48.5	200
	Bannister	BA-MC-V3A-36-SA	Modular Carrels, Version 3 Acrylic Style, S/F	\$ 3,240	Adder - 36" Width	36.125	31	48.5	150
	Bannister	BA-MC-V3A-48-SS	Modular Carrels, Version 3 Acrylic Style, S/F	\$ 4,690	Starter - 48" Width	49.25	31	48.5	230
	Bannister	BA-MC-V3A-48-SA	Modular Carrels, Version 3 Acrylic Style, S/F	\$ 3,355	Adder - 48" Width	48.125	31	48.5	180
	Bannister	BA-MC-V3A-36-DS	Modular Carrels, Version 3 Acrylic Style, D/F	\$ 6,955	Starter - 36" Width	37.25	59.5	48.5	350
	Bannister	BA-MC-V3A-36-DA	Modular Carrels, Version 3 Acrylic Style, D/F	\$ 4,555	Adder - 36" Width	36.125	59.5	48.5	240
	Bannister	BA-MC-V3A-48-DS	Modular Carrels, Version 3 Acrylic Style, D/F	\$ 7,135	Starter - 48" Width	49.25	59.5	48.5	410
	Bannister	BA-MC-V3A-48-DA	Modular Carrels, Version 3 Acrylic Style, D/F	\$ 4,735	Adder - 48" Width	48.125	59.5	48.5	310
	Bannister	BA-MC-V3M-36-SS	Modular Carrels, Version 3 Molding Style, S/F	\$ 4,835	Starter - 36" Width	37.25	31	48.5	200
	Bannister	BA-MC-V3M-36-SA	Modular Carrels, Version 3 Molding Style, S/F	\$ 3,240	Adder - 36" Width	36.125	31	48.5	150









Image	Collection	Catalog Number	Item Description	List Price	Colour / Type	Width (Inches)	Depth (Inches)	Height (Inches)	Weight (Lbs.)
	Bannister	BA-MC-V3M-48-SS	Modular Carrels, Version 3 Molding Style, S/F	\$ 4,950	Starter - 48" Width	49.25	31	48.5	230
	Bannister	BA-MC-V3M-48-SA	Modular Carrels, Version 3 Molding Style, S/F	\$ 3,355	Adder - 48" Width	48.125	31	48.5	180
	Bannister	BA-MC-V3M-36-DS	Modular Carrels, Version 3 Molding Style, D/F	\$ 7,545	Starter - 36" Width	37.25	59.5	48.5	350
	Bannister	BA-MC-V3M-36-DA	Modular Carrels, Version 3 Molding Style, D/F	\$ 4,555	Adder - 36" Width	36.125	59.5	48.5	240
	Bannister	BA-MC-V3M-48-DS	Modular Carrels, Version 3 Molding Style, D/F	\$ 7,730	Starter - 48" Width	49.25	59.5	48.5	410
	Bannister	BA-MC-V3M-48-DA	Modular Carrels, Version 3 Molding Style, D/F	\$ 4,735	Adder - 48" Width	48.125	59.5	48.5	310
	Bannister	BA-MC-V3S-36-SS	Modular Carrels, Version 3 Shaker Style, S/F	\$ 4,435	Starter - 36" Width	37.25	31	48.5	200
	Bannister	BA-MC-V3S-36-SA	Modular Carrels, Version 3 Shaker Style, S/F	\$ 3,240	Adder - 36" Width	36.125	31	48.5	150
	Bannister	BA-MC-V3S-48-SS	Modular Carrels, Version 3 Shaker Style, S/F	\$ 4,550	Starter - 48" Width	49.25	31	48.5	230
	Bannister	BA-MC-V3S-48-SA	Modular Carrels, Version 3 Shaker Style, S/F	\$ 3,355	Adder - 48" Width	48.125	31	48.5	180
	Bannister	BA-MC-V3S-36-DS	Modular Carrels, Version 3 Shaker Style, D/F	\$ 6,670	Starter - 36" Width	37.25	59.5	48.5	350
	Bannister	BA-MC-V3S-36-DA	Modular Carrels, Version 3 Shaker Style, D/F	\$ 4,555	Adder - 36" Width	36.125	59.5	48.5	240
	Bannister	BA-MC-V3S-48-DS	Modular Carrels, Version 3 Shaker Style, D/F	\$ 6,855	Starter - 48" Width	49.25	59.5	48.5	410
	Bannister	BA-MC-V3S-48-DA	Modular Carrels, Version 3 Shaker Style, D/F	\$ 4,735	Adder - 48" Width	48.125	59.5	48.5	310
	Bannister	BA-MC-V4A-36-SS	Modular Carrels, Version 4 Acrylic Style, S/F	\$ 4,575	Starter - 36" Width	37.25	31	48.5	200















Image	Collection	Catalog Number	Item Description	List Price	Colour / Type	Width (Inches)	Depth (Inches)	Height (Inches)	Weight (Lbs.)
	Bannister	BA-MC-V4A-36-SA	Modular Carrels, Version 4 Acrylic Style, S/F	\$ 3,240	Adder - 36" Width	36.125	31	48.5	150
	Bannister	BA-MC-V4A-48-SS	Modular Carrels, Version 4 Acrylic Style, S/F	\$ 4,690	Starter - 48" Width	49.25	31	48.5	230
	Bannister	BA-MC-V4A-48-SA	Modular Carrels, Version 4 Acrylic Style, S/F	\$ 3,355	Adder - 48" Width	48.125	31	48.5	180
	Bannister	BA-MC-V4A-36-DS	Modular Carrels, Version 4 Acrylic Style, D/F	\$ 6,955	Starter - 36" Width	37.25	59.5	48.5	350
	Bannister	BA-MC-V4A-36-DA	Modular Carrels, Version 4 Acrylic Style, D/F	\$ 4,555	Adder - 36" Width	36.125	59.5	48.5	240
	Bannister	BA-MC-V4A-48-DS	Modular Carrels, Version 4 Acrylic Style, D/F	\$ 7,135	Starter - 48" Width	49.25	59.5	48.5	410
	Bannister	BA-MC-V4A-48-DA	Modular Carrels, Version 4 Acrylic Style, D/F	\$ 4,735	Adder - 48" Width	48.125	59.5	48.5	310
	Bannister	BA-MC-V4M-36-SS	Modular Carrels, Version 4 Molding Style, S/F	\$ 4,835	Starter - 36" Width	37.25	31	48.5	200
	Bannister	BA-MC-V4M-36-SA	Modular Carrels, Version 4 Molding Style, S/F	\$ 3,240	Adder - 36" Width	36.125	31	48.5	150
	Bannister	BA-MC-V4M-48-SS	Modular Carrels, Version 4 Molding Style, S/F	\$ 4,950	Starter - 48" Width	49.25	31	48.5	230
	Bannister	BA-MC-V4M-48-SA	Modular Carrels, Version 4 Molding Style, S/F	\$ 3,355	Adder - 48" Width	48.125	31	48.5	180
	Bannister	BA-MC-V4M-36-DS	Modular Carrels, Version 4 Molding Style, D/F	\$ 7,545	Starter - 36" Width	37.25	59.5	48.5	350
	Bannister	BA-MC-V4M-36-DA	Modular Carrels, Version 4 Molding Style, D/F	\$ 4,555	Adder - 36" Width	36.125	59.5	48.5	240
	Bannister	BA-MC-V4M-48-DS	Modular Carrels, Version 4 Molding Style, D/F	\$ 7,730	Starter - 48" Width	49.25	59.5	48.5	410
	Bannister	BA-MC-V4M-48-DA	Modular Carrels, Version 4 Molding Style, D/F	\$ 4,735	Adder - 48" Width	48.125	59.5	48.5	310





Image	Collection	Catalog Number	Item Description	List Price	Colour / Type	Width (Inches)	Depth (Inches)	Height (Inches)	Weight (Lbs.)
	Bannister	BA-MC-V4S-36-SS	Modular Carrels, Version 4 Shaker Style, S/F	\$ 4,435	Starter - 36" Width	37.25	31	48.5	200
	Bannister	BA-MC-V4S-36-SA	Modular Carrels, Version 4 Shaker Style, S/F	\$ 3,240	Adder - 36" Width	36.125	31	48.5	150
	Bannister	BA-MC-V4S-48-SS	Modular Carrels, Version 4 Shaker Style, S/F	\$ 4,550	Starter - 48" Width	49.25	31	48.5	230
	Bannister	BA-MC-V4S-48-SA	Modular Carrels, Version 4 Shaker Style, S/F	\$ 3,355	Adder - 48" Width	48.125	31	48.5	180
	Bannister	BA-MC-V4S-36-DS	Modular Carrels, Version 4 Shaker Style, D/F	\$ 6,670	Starter - 36" Width	37.25	59.5	48.5	350
	Bannister	BA-MC-V4S-36-DA	Modular Carrels, Version 4 Shaker Style, D/F	\$ 4,555	Adder - 36" Width	36.125	59.5	48.5	240
	Bannister	BA-MC-V4S-48-DS	Modular Carrels, Version 4 Shaker Style, D/F	\$ 6,855	Starter - 48" Width	49.25	59.5	48.5	410
	Bannister	BA-MC-V4S-48-DA	Modular Carrels, Version 4 Shaker Style, D/F	\$ 4,735	Adder - 48" Width	48.125	59.5	48.5	310
	Bannister	BA-MC-V5A-36-SS	Modular Carrels, Version 5 Acrylic Style, S/F	\$ 4,575	Starter - 36" Width	37.25	31	48.5	200
	Bannister	BA-MC-V5A-36-SA	Modular Carrels, Version 5 Acrylic Style, S/F	\$ 3,240	Adder - 36" Width	36.125	31	48.5	150
	Bannister	BA-MC-V5A-48-SS	Modular Carrels, Version 5 Acrylic Style, S/F	\$ 4,690	Starter - 48" Width	49.25	31	48.5	230
	Bannister	BA-MC-V5A-48-SA	Modular Carrels, Version 5 Acrylic Style, S/F	\$ 3,355	Adder - 48" Width	48.125	31	48.5	180
	Bannister	BA-MC-V5A-36-DS	Modular Carrels, Version 5 Acrylic Style, D/F	\$ 6,955	Starter - 36" Width	37.25	59.5	48.5	350
	Bannister	BA-MC-V5A-36-DA	Modular Carrels, Version 5 Acrylic Style, D/F	\$ 4,555	Adder - 36" Width	36.125	59.5	48.5	240
	Bannister	BA-MC-V5A-48-DS	Modular Carrels, Version 5 Acrylic Style, D/F	\$ 7,135	Starter - 48" Width	49.25	59.5	48.5	410





Image	Collection	Catalog Number	Item Description	List Price	Colour / Type	Width (Inches)	Depth (Inches)	Height (Inches)	Weight (Lbs.)
	Bannister	BA-MC-V5A-48-DA	Modular Carrels, Version 5 Acrylic Style, D/F	\$ 4,735	Adder - 48" Width	48.125	59.5	48.5	310
	Bannister	BA-MC-V5M-36-SS	Modular Carrels, Version 5 Molding Style, S/F	\$ 4,835	Starter - 36" Width	37.25	31	48.5	200
	Bannister	BA-MC-V5M-36-SA	Modular Carrels, Version 5 Molding Style, S/F	\$ 3,240	Adder - 36" Width	36.125	31	48.5	150
	Bannister	BA-MC-V5M-48-SS	Modular Carrels, Version 5 Molding Style, S/F	\$ 4,950	Starter - 48" Width	49.25	31	48.5	230
	Bannister	BA-MC-V5M-48-SA	Modular Carrels, Version 5 Molding Style, S/F	\$ 3,355	Adder - 48" Width	48.125	31	48.5	180
	Bannister	BA-MC-V5M-36-DS	Modular Carrels, Version 5 Molding Style, D/F	\$ 7,545	Starter - 36" Width	37.25	59.5	48.5	350
	Bannister	BA-MC-V5M-36-DA	Modular Carrels, Version 5 Molding Style, D/F	\$ 4,555	Adder - 36" Width	36.125	59.5	48.5	240
	Bannister	BA-MC-V5M-48-DS	Modular Carrels, Version 5 Molding Style, D/F	\$ 7,730	Starter - 48" Width	49.25	59.5	48.5	410
	Bannister	BA-MC-V5M-48-DA	Modular Carrels, Version 5 Molding Style, D/F	\$ 4,735	Adder - 48" Width	48.125	59.5	48.5	310
	Bannister	BA-MC-V5S-36-SS	Modular Carrels, Version 5 Shaker Style, S/F	\$ 4,435	Starter - 36" Width	37.25	31	48.5	200
	Bannister	BA-MC-V5S-36-SA	Modular Carrels, Version 5 Shaker Style, S/F	\$ 3,240	Adder - 36" Width	36.125	31	48.5	150
	Bannister	BA-MC-V5S-48-SS	Modular Carrels, Version 5 Shaker Style, S/F	\$ 4,550	Starter - 48" Width	49.25	31	48.5	230
	Bannister	BA-MC-V5S-48-SA	Modular Carrels, Version 5 Shaker Style, S/F	\$ 3,355	Adder - 48" Width	48.125	31	48.5	180
	Bannister	BA-MC-V5S-36-DS	Modular Carrels, Version 5 Shaker Style, D/F	\$ 6,670	Starter - 36" Width	37.25	59.5	48.5	350
	Bannister	BA-MC-V5S-36-DA	Modular Carrels, Version 5 Shaker Style, D/F	\$ 4,555	Adder - 36" Width	36.125	59.5	48.5	240





Image	Collection	Catalog Number	Item Description	List Price	Colour / Type	Width (Inches)	Depth (Inches)	Height (Inches)	Weight (Lbs.)
	Bannister	BA-MC-V5S-48-DS	Modular Carrels, Version 5 Shaker Style, D/F	\$ 6,855	Starter - 48" Width	49.25	59.5	48.5	410
	Bannister	BA-MC-V5S-48-DA	Modular Carrels, Version 5 Shaker Style, D/F	\$ 4,735	Adder - 48" Width	48.125	59.5	48.5	310
	Bannister	BA-MC-V6A-36-SS	Modular Carrels, Version 6 Acrylic Style, S/F	\$ 4,230	Starter - 36" Width	37.25	31	48.5	200
	Bannister	BA-MC-V6A-36-SA	Modular Carrels, Version 6 Acrylic Style, S/F	\$ 3,240	Adder - 36" Width	36.125	31	48.5	150
	Bannister	BA-MC-V6A-48-SS	Modular Carrels, Version 6 Acrylic Style, S/F	\$ 4,345	Starter - 48" Width	49.25	31	48.5	230
	Bannister	BA-MC-V6A-48-SA	Modular Carrels, Version 6 Acrylic Style, S/F	\$ 3,355	Adder - 48" Width	48.125	31	48.5	180
	Bannister	BA-MC-V6A-36-DS	Modular Carrels, Version 6 Acrylic Style, D/F	\$ 6,620	Starter - 36" Width	37.25	59.5	48.5	350
	Bannister	BA-MC-V6A-36-DA	Modular Carrels, Version 6 Acrylic Style, D/F	\$ 4,555	Adder - 36" Width	36.125	59.5	48.5	240
	Bannister	BA-MC-V6A-48-DS	Modular Carrels, Version 6 Acrylic Style, D/F	\$ 6,800	Starter - 48" Width	49.25	59.5	48.5	410
	Bannister	BA-MC-V6A-48-DA	Modular Carrels, Version 6 Acrylic Style, D/F	\$ 4,735	Adder - 48" Width	48.125	59.5	48.5	310
	Bannister	BA-MC-V6M-36-SS	Modular Carrels, Version 6 Molding Style, S/F	\$ 4,520	Starter - 36" Width	37.25	31	48.5	200
	Bannister	BA-MC-V6M-36-SA	Modular Carrels, Version 6 Molding Style, S/F	\$ 3,240	Adder - 36" Width	36.125	31	48.5	150
	Bannister	BA-MC-V6M-48-SS	Modular Carrels, Version 6 Molding Style, S/F	\$ 4,635	Starter - 48" Width	49.25	31	48.5	230
	Bannister	BA-MC-V6M-48-SA	Modular Carrels, Version 6 Molding Style, S/F	\$ 3,355	Adder - 48" Width	48.125	31	48.5	180
	Bannister	BA-MC-V6M-36-DS	Modular Carrels, Version 6 Molding Style, D/F	\$ 6,985	Starter - 36" Width	37.25	59.5	48.5	350

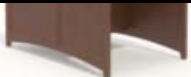









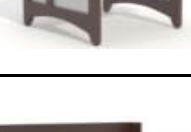



Image	Collection	Catalog Number	Item Description	List Price	Colour / Type	Width (Inches)	Depth (Inches)	Height (Inches)	Weight (Lbs.)
	Bannister	BA-MC-V6M-36-DA	Modular Carrels, Version 6 Molding Style, D/F	\$ 4,555	Adder - 36" Width	36.125	59.5	48.5	240
	Bannister	BA-MC-V6M-48-DS	Modular Carrels, Version 6 Molding Style, D/F	\$ 7,165	Starter - 48" Width	49.25	59.5	48.5	410
	Bannister	BA-MC-V6M-48-DA	Modular Carrels, Version 6 Molding Style, D/F	\$ 4,735	Adder - 48" Width	48.125	59.5	48.5	310
	Bannister	BA-MC-V6S-36-SS	Modular Carrels, Version 6 Shaker Style, S/F	\$ 4,135	Starter - 36" Width	37.25	31	48.5	200
	Bannister	BA-MC-V6S-36-SA	Modular Carrels, Version 6 Shaker Style, S/F	\$ 3,240	Adder - 36" Width	36.125	31	48.5	150
	Bannister	BA-MC-V6S-48-SS	Modular Carrels, Version 6 Shaker Style, S/F	\$ 4,250	Starter - 48" Width	49.25	31	48.5	230
	Bannister	BA-MC-V6S-48-SA	Modular Carrels, Version 6 Shaker Style, S/F	\$ 3,355	Adder - 48" Width	48.125	31	48.5	180
	Bannister	BA-MC-V6S-36-DS	Modular Carrels, Version 6 Shaker Style, D/F	\$ 6,430	Starter - 36" Width	37.25	59.5	48.5	350
	Bannister	BA-MC-V6S-36-DA	Modular Carrels, Version 6 Shaker Style, D/F	\$ 4,555	Adder - 36" Width	36.125	59.5	48.5	240
	Bannister	BA-MC-V6S-48-DS	Modular Carrels, Version 6 Shaker Style, D/F	\$ 6,610	Starter - 48" Width	49.25	59.5	48.5	410
	Bannister	BA-MC-V6S-48-DA	Modular Carrels, Version 6 Shaker Style, D/F	\$ 4,735	Adder - 48" Width	48.125	59.5	48.5	310
	Bannister	BA-PAC-1-V1A-29	PAC Table, Version 1 Acrylic Style, 1 Person	\$ 3,940	Sitting Hgt.	36.25	36	37	130
	Bannister	BA-PAC-1-V1A-32	PAC Table, Version 1 Acrylic Style, 1 Person	\$ 4,010	Wheelchair Hgt.	36.25	36	40	130
	Bannister	BA-PAC-1-V1A-39	PAC Table, Version 1 Acrylic Style, 1 Person	\$ 4,195	Standing Hgt.	36.25	36	47	135
	Bannister	BA-PAC-2-V1A-29	PAC Table, Version 1 Acrylic Style, 2 Person	\$ 4,535	Sitting Hgt.	72.25	36	37	200







Image	Collection	Catalog Number	Item Description	List Price	Colour / Type	Width (Inches)	Depth (Inches)	Height (Inches)	Weight (Lbs.)
	Bannister	BA-PAC-2-V1A-32	PAC Table, Version 1 Acrylic Style, 2 Person	\$ 4,610	Wheelchair Hgt.	72.25	36	40	200
	Bannister	BA-PAC-2-V1A-39	PAC Table, Version 1 Acrylic Style, 2 Person	\$ 4,810	Standing Hgt.	72.25	36	47	205
	Bannister	BA-PAC-3-V1A-29	PAC Table, Version 1 Acrylic Style, 3 Person	\$ 4,990	Sitting Hgt.	90.25	36	37	250
	Bannister	BA-PAC-3-V1A-32	PAC Table, Version 1 Acrylic Style, 3 Person	\$ 5,060	Wheelchair Hgt.	90.25	36	40	250
	Bannister	BA-PAC-3-V1A-39	PAC Table, Version 1 Acrylic Style, 3 Person	\$ 5,270	Standing Hgt.	90.25	36	47	260
	Bannister	BA-PAC-1-V1M-29	PAC Table, Version 1 Molding Style, 1 Person	\$ 4,340	Sitting Hgt.	36.25	36	37	130
	Bannister	BA-PAC-1-V1M-32	PAC Table, Version 1 Molding Style, 1 Person	\$ 4,415	Wheelchair Hgt.	36.25	36	40	130
	Bannister	BA-PAC-1-V1M-39	PAC Table, Version 1 Molding Style, 1 Person	\$ 4,605	Standing Hgt.	36.25	36	47	135
	Bannister	BA-PAC-2-V1M-29	PAC Table, Version 1 Molding Style, 2 Person	\$ 4,935	Sitting Hgt.	72.25	36	37	200
	Bannister	BA-PAC-2-V1M-32	PAC Table, Version 1 Molding Style, 2 Person	\$ 5,010	Wheelchair Hgt.	72.25	36	40	200
	Bannister	BA-PAC-2-V1M-39	PAC Table, Version 1 Molding Style, 2 Person	\$ 5,225	Standing Hgt.	72.25	36	47	205
	Bannister	BA-PAC-3-V1M-29	PAC Table, Version 1 Molding Style, 3 Person	\$ 5,385	Sitting Hgt.	90.25	36	37	250
	Bannister	BA-PAC-3-V1M-32	PAC Table, Version 1 Molding Style, 3 Person	\$ 5,465	Wheelchair Hgt.	90.25	36	40	250
	Bannister	BA-PAC-3-V1M-39	PAC Table, Version 1 Molding Style, 3 Person	\$ 5,685	Standing Hgt.	90.25	36	47	260
	Bannister	BA-PAC-1-V1S-29	PAC Table, Version 1 Shaker Style, 1 Person	\$ 3,765	Sitting Hgt.	36.25	36	37	130
	Bannister	BA-PAC-1-V1S-32	PAC Table, Version 1 Shaker Style, 1 Person	\$ 3,805	Wheelchair Hgt.	36.25	36	40	130
	Bannister	BA-PAC-1-V1S-39	PAC Table, Version 1 Shaker Style, 1 Person	\$ 3,920	Standing Hgt.	36.25	36	47	135







Image	Collection	Catalog Number	Item Description	List Price	Colour / Type	Width (Inches)	Depth (Inches)	Height (Inches)	Weight (Lbs.)
	Bannister	BA-PAC-2-V1S-29	PAC Table, Version 1 Shaker Style, 2 Person	\$ 4,360	Sitting Hgt.	72.25	36	37	200
	Bannister	BA-PAC-2-V1S-32	PAC Table, Version 1 Shaker Style, 2 Person	\$ 4,405	Wheelchair Hgt.	72.25	36	40	200
	Bannister	BA-PAC-2-V1S-39	PAC Table, Version 1 Shaker Style, 2 Person	\$ 4,535	Standing Hgt.	72.25	36	47	205
	Bannister	BA-PAC-3-V1S-29	PAC Table, Version 1 Shaker Style, 3 Person	\$ 4,815	Sitting Hgt.	90.25	36	37	250
	Bannister	BA-PAC-3-V1S-32	PAC Table, Version 1 Shaker Style, 3 Person	\$ 4,855	Wheelchair Hgt.	90.25	36	40	250
	Bannister	BA-PAC-3-V1S-39	PAC Table, Version 1 Shaker Style, 3 Person	\$ 4,995	Standing Hgt.	90.25	36	47	260
	Bannister	BA-PAC-1-V2A-29	PAC Table, Version 2 Acrylic Style, 1 Person	\$ 3,750	Sitting Hgt.	36.25	36	37	130
	Bannister	BA-PAC-1-V2A-32	PAC Table, Version 2 Acrylic Style, 1 Person	\$ 3,815	Wheelchair Hgt.	36.25	36	40	130
	Bannister	BA-PAC-1-V2A-39	PAC Table, Version 2 Acrylic Style, 1 Person	\$ 3,975	Standing Hgt.	36.25	36	47	135
	Bannister	BA-PAC-2-V2A-29	PAC Table, Version 2 Acrylic Style, 2 Person	\$ 4,350	Sitting Hgt.	72.25	36	37	200
	Bannister	BA-PAC-2-V2A-32	PAC Table, Version 2 Acrylic Style, 2 Person	\$ 4,415	Wheelchair Hgt.	72.25	36	40	200
	Bannister	BA-PAC-2-V2A-39	PAC Table, Version 2 Acrylic Style, 2 Person	\$ 4,595	Standing Hgt.	72.25	36	47	205
	Bannister	BA-PAC-3-V2A-29	PAC Table, Version 2 Acrylic Style, 3 Person	\$ 4,800	Sitting Hgt.	90.25	36	37	250
	Bannister	BA-PAC-3-V2A-32	PAC Table, Version 2 Acrylic Style, 3 Person	\$ 4,865	Wheelchair Hgt.	90.25	36	40	250
	Bannister	BA-PAC-3-V2A-39	PAC Table, Version 2 Acrylic Style, 3 Person	\$ 5,055	Standing Hgt.	90.25	36	47	260
	Bannister	BA-PAC-1-V2M-29	PAC Table, Version 2 Molding Style, 1 Person	\$ 4,040	Sitting Hgt.	36.25	36	37	130
	Bannister	BA-PAC-1-V2M-32	PAC Table, Version 2 Molding Style, 1 Person	\$ 4,100	Wheelchair Hgt.	36.25	36	40	130







Image	Collection	Catalog Number	Item Description	List Price	Colour / Type	Width (Inches)	Depth (Inches)	Height (Inches)	Weight (Lbs.)
	Bannister	BA-PAC-1-V2M-39	PAC Table, Version 2 Molding Style, 1 Person	\$ 4,250	Standing Hgt.	36.25	36	47	135
	Bannister	BA-PAC-2-V2M-29	PAC Table, Version 2 Molding Style, 2 Person	\$ 4,635	Sitting Hgt.	72.25	36	37	200
	Bannister	BA-PAC-2-V2M-32	PAC Table, Version 2 Molding Style, 2 Person	\$ 4,695	Wheelchair Hgt.	72.25	36	40	200
	Bannister	BA-PAC-2-V2M-39	PAC Table, Version 2 Molding Style, 2 Person	\$ 4,870	Standing Hgt.	72.25	36	47	205
	Bannister	BA-PAC-3-V2M-29	PAC Table, Version 2 Molding Style, 3 Person	\$ 5,090	Sitting Hgt.	90.25	36	37	250
	Bannister	BA-PAC-3-V2M-32	PAC Table, Version 2 Molding Style, 3 Person	\$ 5,150	Wheelchair Hgt.	90.25	36	40	250
	Bannister	BA-PAC-3-V2M-39	PAC Table, Version 2 Molding Style, 3 Person	\$ 5,330	Standing Hgt.	90.25	36	47	260
	Bannister	BA-PAC-1-V2S-29	PAC Table, Version 2 Shaker Style, 1 Person	\$ 3,595	Sitting Hgt.	36.25	36	37	130
	Bannister	BA-PAC-1-V2S-32	PAC Table, Version 2 Shaker Style, 1 Person	\$ 3,630	Wheelchair Hgt.	36.25	36	40	130
	Bannister	BA-PAC-1-V2S-39	PAC Table, Version 2 Shaker Style, 1 Person	\$ 3,730	Standing Hgt.	36.25	36	47	135
	Bannister	BA-PAC-2-V2S-29	PAC Table, Version 2 Shaker Style, 2 Person	\$ 4,190	Sitting Hgt.	72.25	36	37	200
	Bannister	BA-PAC-2-V2S-32	PAC Table, Version 2 Shaker Style, 2 Person	\$ 4,225	Wheelchair Hgt.	72.25	36	40	200
	Bannister	BA-PAC-2-V2S-39	PAC Table, Version 2 Shaker Style, 2 Person	\$ 4,345	Standing Hgt.	72.25	36	47	205
	Bannister	BA-PAC-3-V2S-29	PAC Table, Version 2 Shaker Style, 3 Person	\$ 4,640	Sitting Hgt.	90.25	36	37	250
	Bannister	BA-PAC-3-V2S-32	PAC Table, Version 2 Shaker Style, 3 Person	\$ 4,680	Wheelchair Hgt.	90.25	36	40	250
	Bannister	BA-PAC-3-V2S-39	PAC Table, Version 2 Shaker Style, 3 Person	\$ 4,805	Standing Hgt.	90.25	36	47	260
	Bannister	BA-PAC-1-V3A-29	PAC Table, Version 3 Acrylic Style, 1 Person	\$ 3,940	Sitting Hgt.	36.25	36	37	130







Image	Collection	Catalog Number	Item Description	List Price	Colour / Type	Width (Inches)	Depth (Inches)	Height (Inches)	Weight (Lbs.)
	Bannister	BA-PAC-1-V3A-32	PAC Table, Version 3 Acrylic Style, 1 Person	\$ 4,010	Wheelchair Hgt.	36.25	36	40	130
	Bannister	BA-PAC-1-V3A-39	PAC Table, Version 3 Acrylic Style, 1 Person	\$ 4,195	Standing Hgt.	36.25	36	47	135
	Bannister	BA-PAC-2-V3A-29	PAC Table, Version 3 Acrylic Style, 2 Person	\$ 4,535	Sitting Hgt.	72.25	36	37	200
	Bannister	BA-PAC-2-V3A-32	PAC Table, Version 3 Acrylic Style, 2 Person	\$ 4,610	Wheelchair Hgt.	72.25	36	40	200
	Bannister	BA-PAC-2-V3A-39	PAC Table, Version 3 Acrylic Style, 2 Person	\$ 4,810	Standing Hgt.	72.25	36	47	205
	Bannister	BA-PAC-3-V3A-29	PAC Table, Version 3 Acrylic Style, 3 Person	\$ 4,990	Sitting Hgt.	90.25	36	37	250
	Bannister	BA-PAC-3-V3A-32	PAC Table, Version 3 Acrylic Style, 3 Person	\$ 5,060	Wheelchair Hgt.	90.25	36	40	250
	Bannister	BA-PAC-3-V3A-39	PAC Table, Version 3 Acrylic Style, 3 Person	\$ 5,270	Standing Hgt.	90.25	36	47	260
	Bannister	BA-PAC-1-V3M-29	PAC Table, Version 3 Molding Style, 1 Person	\$ 4,340	Sitting Hgt.	36.25	36	37	130
	Bannister	BA-PAC-1-V3M-32	PAC Table, Version 3 Molding Style, 1 Person	\$ 4,415	Wheelchair Hgt.	36.25	36	40	130
	Bannister	BA-PAC-1-V3M-39	PAC Table, Version 3 Molding Style, 1 Person	\$ 4,605	Standing Hgt.	36.25	36	47	135
	Bannister	BA-PAC-2-V3M-29	PAC Table, Version 3 Molding Style, 2 Person	\$ 4,935	Sitting Hgt.	72.25	36	37	200
	Bannister	BA-PAC-2-V3M-32	PAC Table, Version 3 Molding Style, 2 Person	\$ 5,010	Wheelchair Hgt.	72.25	36	40	200
	Bannister	BA-PAC-2-V3M-39	PAC Table, Version 3 Molding Style, 2 Person	\$ 5,225	Standing Hgt.	72.25	36	47	205
	Bannister	BA-PAC-3-V3M-29	PAC Table, Version 3 Molding Style, 3 Person	\$ 5,385	Sitting Hgt.	90.25	36	37	250
	Bannister	BA-PAC-3-V3M-32	PAC Table, Version 3 Molding Style, 3 Person	\$ 5,465	Wheelchair Hgt.	90.25	36	40	250
	Bannister	BA-PAC-3-V3M-39	PAC Table, Version 3 Molding Style, 3 Person	\$ 5,685	Standing Hgt.	90.25	36	47	260







Image	Collection	Catalog Number	Item Description	List Price	Colour / Type	Width (Inches)	Depth (Inches)	Height (Inches)	Weight (Lbs.)
	Bannister	BA-PAC-1-V3S-29	PAC Table, Version 3 Shaker Style, 1 Person	\$ 3,765	Sitting Hgt.	36.25	36	37	130
	Bannister	BA-PAC-1-V3S-32	PAC Table, Version 3 Shaker Style, 1 Person	\$ 3,805	Wheelchair Hgt.	36.25	36	40	130
	Bannister	BA-PAC-1-V3S-39	PAC Table, Version 3 Shaker Style, 1 Person	\$ 3,920	Standing Hgt.	36.25	36	47	135
	Bannister	BA-PAC-2-V3S-29	PAC Table, Version 3 Shaker Style, 2 Person	\$ 4,360	Sitting Hgt.	72.25	36	37	200
	Bannister	BA-PAC-2-V3S-32	PAC Table, Version 3 Shaker Style, 2 Person	\$ 4,405	Wheelchair Hgt.	72.25	36	40	200
	Bannister	BA-PAC-2-V3S-39	PAC Table, Version 3 Shaker Style, 2 Person	\$ 4,535	Standing Hgt.	72.25	36	47	205
	Bannister	BA-PAC-3-V3S-29	PAC Table, Version 3 Shaker Style, 3 Person	\$ 4,815	Sitting Hgt.	90.25	36	37	250
	Bannister	BA-PAC-3-V3S-32	PAC Table, Version 3 Shaker Style, 3 Person	\$ 4,855	Wheelchair Hgt.	90.25	36	40	250
	Bannister	BA-PAC-3-V3S-39	PAC Table, Version 3 Shaker Style, 3 Person	\$ 4,995	Standing Hgt.	90.25	36	47	260
	Bannister	BA-PAC-1-V4A-29	PAC Table, Version 4 Acrylic Style, 1 Person	\$ 3,940	Sitting Hgt.	36.25	36	37	130
	Bannister	BA-PAC-1-V4A-32	PAC Table, Version 4 Acrylic Style, 1 Person	\$ 4,010	Wheelchair Hgt.	36.25	36	40	130
	Bannister	BA-PAC-1-V4A-39	PAC Table, Version 4 Acrylic Style, 1 Person	\$ 4,195	Standing Hgt.	36.25	36	47	135
	Bannister	BA-PAC-2-V4A-29	PAC Table, Version 4 Acrylic Style, 2 Person	\$ 4,535	Sitting Hgt.	72.25	36	37	200
	Bannister	BA-PAC-2-V4A-32	PAC Table, Version 4 Acrylic Style, 2 Person	\$ 4,610	Wheelchair Hgt.	72.25	36	40	200
	Bannister	BA-PAC-2-V4A-39	PAC Table, Version 4 Acrylic Style, 2 Person	\$ 4,810	Standing Hgt.	72.25	36	47	205
	Bannister	BA-PAC-3-V4A-29	PAC Table, Version 4 Acrylic Style, 3 Person	\$ 4,990	Sitting Hgt.	90.25	36	37	250
	Bannister	BA-PAC-3-V4A-32	PAC Table, Version 4 Acrylic Style, 3 Person	\$ 5,060	Wheelchair Hgt.	90.25	36	40	250







Image	Collection	Catalog Number	Item Description	List Price	Colour / Type	Width (Inches)	Depth (Inches)	Height (Inches)	Weight (Lbs.)
	Bannister	BA-PAC-3-V4A-39	PAC Table, Version 4 Acrylic Style, 3 Person	\$ 5,270	Standing Hgt.	90.25	36	47	260
	Bannister	BA-PAC-1-V4M-29	PAC Table, Version 4 Molding Style, 1 Person	\$ 4,340	Sitting Hgt.	36.25	36	37	130
	Bannister	BA-PAC-1-V4M-32	PAC Table, Version 4 Molding Style, 1 Person	\$ 4,415	Wheelchair Hgt.	36.25	36	40	130
	Bannister	BA-PAC-1-V4M-39	PAC Table, Version 4 Molding Style, 1 Person	\$ 4,605	Standing Hgt.	36.25	36	47	135
	Bannister	BA-PAC-2-V4M-29	PAC Table, Version 4 Molding Style, 2 Person	\$ 4,935	Sitting Hgt.	72.25	36	37	200
	Bannister	BA-PAC-2-V4M-32	PAC Table, Version 4 Molding Style, 2 Person	\$ 5,010	Wheelchair Hgt.	72.25	36	40	200
	Bannister	BA-PAC-2-V4M-39	PAC Table, Version 4 Molding Style, 2 Person	\$ 5,225	Standing Hgt.	72.25	36	47	205
	Bannister	BA-PAC-3-V4M-29	PAC Table, Version 4 Molding Style, 3 Person	\$ 5,385	Sitting Hgt.	90.25	36	37	250
	Bannister	BA-PAC-3-V4M-32	PAC Table, Version 4 Molding Style, 3 Person	\$ 5,465	Wheelchair Hgt.	90.25	36	40	250
	Bannister	BA-PAC-3-V4M-39	PAC Table, Version 4 Molding Style, 3 Person	\$ 5,685	Standing Hgt.	90.25	36	47	260
	Bannister	BA-PAC-1-V4S-29	PAC Table, Version 4 Shaker Style, 1 Person	\$ 3,765	Sitting Hgt.	36.25	36	37	130
	Bannister	BA-PAC-1-V4S-32	PAC Table, Version 4 Shaker Style, 1 Person	\$ 3,805	Wheelchair Hgt.	36.25	36	40	130
	Bannister	BA-PAC-1-V4S-39	PAC Table, Version 4 Shaker Style, 1 Person	\$ 3,920	Standing Hgt.	36.25	36	47	135
	Bannister	BA-PAC-2-V4S-29	PAC Table, Version 4 Shaker Style, 2 Person	\$ 4,360	Sitting Hgt.	72.25	36	37	200
	Bannister	BA-PAC-2-V4S-32	PAC Table, Version 4 Shaker Style, 2 Person	\$ 4,405	Wheelchair Hgt.	72.25	36	40	200
	Bannister	BA-PAC-2-V4S-39	PAC Table, Version 4 Shaker Style, 2 Person	\$ 4,535	Standing Hgt.	72.25	36	47	205
	Bannister	BA-PAC-3-V4S-29	PAC Table, Version 4 Shaker Style, 3 Person	\$ 4,815	Sitting Hgt.	90.25	36	37	250







Image	Collection	Catalog Number	Item Description	List Price	Colour / Type	Width (Inches)	Depth (Inches)	Height (Inches)	Weight (Lbs.)
	Bannister	BA-PAC-3-V4S-32	PAC Table, Version 4 Shaker Style, 3 Person	\$ 4,855	Wheelchair Hgt.	90.25	36	40	250
	Bannister	BA-PAC-3-V4S-39	PAC Table, Version 4 Shaker Style, 3 Person	\$ 4,995	Standing Hgt.	90.25	36	47	260
	Bannister	BA-PAC-1-V5A-29	PAC Table, Version 5 Acrylic Style, 1 Person	\$ 3,980	Sitting Hgt.	36.25	36	37	130
	Bannister	BA-PAC-1-V5A-32	PAC Table, Version 5 Acrylic Style, 1 Person	\$ 4,065	Wheelchair Hgt.	36.25	36	40	130
	Bannister	BA-PAC-1-V5A-39	PAC Table, Version 5 Acrylic Style, 1 Person	\$ 4,275	Standing Hgt.	36.25	36	47	135
	Bannister	BA-PAC-2-V5A-29	PAC Table, Version 5 Acrylic Style, 2 Person	\$ 4,580	Sitting Hgt.	72.25	36	37	200
	Bannister	BA-PAC-2-V5A-32	PAC Table, Version 5 Acrylic Style, 2 Person	\$ 4,660	Wheelchair Hgt.	72.25	36	40	200
	Bannister	BA-PAC-2-V5A-39	PAC Table, Version 5 Acrylic Style, 2 Person	\$ 4,890	Standing Hgt.	72.25	36	47	205
	Bannister	BA-PAC-3-V5A-29	PAC Table, Version 5 Acrylic Style, 3 Person	\$ 5,030	Sitting Hgt.	90.25	36	37	250
	Bannister	BA-PAC-3-V5A-32	PAC Table, Version 5 Acrylic Style, 3 Person	\$ 5,115	Wheelchair Hgt.	90.25	36	40	250
	Bannister	BA-PAC-3-V5A-39	PAC Table, Version 5 Acrylic Style, 3 Person	\$ 5,350	Standing Hgt.	90.25	36	47	260
	Bannister	BA-PAC-1-V5M-29	PAC Table, Version 5 Molding Style, 1 Person	\$ 4,425	Sitting Hgt.	36.25	36	37	130
	Bannister	BA-PAC-1-V5M-32	PAC Table, Version 5 Molding Style, 1 Person	\$ 4,515	Wheelchair Hgt.	36.25	36	40	130
	Bannister	BA-PAC-1-V5M-39	PAC Table, Version 5 Molding Style, 1 Person	\$ 4,750	Standing Hgt.	36.25	36	47	135
	Bannister	BA-PAC-2-V5M-29	PAC Table, Version 5 Molding Style, 2 Person	\$ 5,020	Sitting Hgt.	72.25	36	37	200
	Bannister	BA-PAC-2-V5M-32	PAC Table, Version 5 Molding Style, 2 Person	\$ 5,115	Wheelchair Hgt.	72.25	36	40	200
	Bannister	BA-PAC-2-V5M-39	PAC Table, Version 5 Molding Style, 2 Person	\$ 5,365	Standing Hgt.	72.25	36	47	205







Image	Collection	Catalog Number	Item Description	List Price	Colour / Type	Width (Inches)	Depth (Inches)	Height (Inches)	Weight (Lbs.)
	Bannister	BA-PAC-3-V5M-29	PAC Table, Version 5 Molding Style, 3 Person	\$ 5,475	Sitting Hgt.	90.25	36	37	250
	Bannister	BA-PAC-3-V5M-32	PAC Table, Version 5 Molding Style, 3 Person	\$ 5,565	Wheelchair Hgt.	90.25	36	40	250
	Bannister	BA-PAC-3-V5M-39	PAC Table, Version 5 Molding Style, 3 Person	\$ 5,830	Standing Hgt.	90.25	36	47	260
	Bannister	BA-PAC-1-V5S-29	PAC Table, Version 5 Shaker Style, 1 Person	\$ 3,790	Sitting Hgt.	36.25	36	37	130
	Bannister	BA-PAC-1-V5S-32	PAC Table, Version 5 Shaker Style, 1 Person	\$ 3,840	Wheelchair Hgt.	36.25	36	40	130
	Bannister	BA-PAC-1-V5S-39	PAC Table, Version 5 Shaker Style, 1 Person	\$ 3,965	Standing Hgt.	36.25	36	47	135
	Bannister	BA-PAC-2-V5S-29	PAC Table, Version 5 Shaker Style, 2 Person	\$ 4,390	Sitting Hgt.	72.25	36	37	200
	Bannister	BA-PAC-2-V5S-32	PAC Table, Version 5 Shaker Style, 2 Person	\$ 4,440	Wheelchair Hgt.	72.25	36	40	200
	Bannister	BA-PAC-2-V5S-39	PAC Table, Version 5 Shaker Style, 2 Person	\$ 4,585	Standing Hgt.	72.25	36	47	205
	Bannister	BA-PAC-3-V5S-29	PAC Table, Version 5 Shaker Style, 3 Person	\$ 4,840	Sitting Hgt.	90.25	36	37	250
	Bannister	BA-PAC-3-V5S-32	PAC Table, Version 5 Shaker Style, 3 Person	\$ 4,890	Wheelchair Hgt.	90.25	36	40	250
	Bannister	BA-PAC-3-V5S-39	PAC Table, Version 5 Shaker Style, 3 Person	\$ 5,045	Standing Hgt.	90.25	36	47	260
	Bannister	BA-PAC-1-V6A-29	PAC Table, Version 6 Acrylic Style, 1 Person	\$ 3,490	Sitting Hgt.	36.25	36	37	130
	Bannister	BA-PAC-1-V6A-32	PAC Table, Version 6 Acrylic Style, 1 Person	\$ 3,545	Wheelchair Hgt.	36.25	36	40	130
	Bannister	BA-PAC-1-V6A-39	PAC Table, Version 6 Acrylic Style, 1 Person	\$ 3,685	Standing Hgt.	36.25	36	47	135
	Bannister	BA-PAC-2-V6A-29	PAC Table, Version 6 Acrylic Style, 2 Person	\$ 4,090	Sitting Hgt.	72.25	36	37	200
	Bannister	BA-PAC-2-V6A-32	PAC Table, Version 6 Acrylic Style, 2 Person	\$ 4,145	Wheelchair Hgt.	72.25	36	40	200







Image	Collection	Catalog Number	Item Description	List Price	Colour / Type	Width (Inches)	Depth (Inches)	Height (Inches)	Weight (Lbs.)
	Bannister	BA-PAC-2-V6A-39	PAC Table, Version 6 Acrylic Style, 2 Person	\$ 4,305	Standing Hgt.	72.25	36	47	205
	Bannister	BA-PAC-3-V6A-29	PAC Table, Version 6 Acrylic Style, 3 Person	\$ 4,540	Sitting Hgt.	90.25	36	37	250
	Bannister	BA-PAC-3-V6A-32	PAC Table, Version 6 Acrylic Style, 3 Person	\$ 4,595	Wheelchair Hgt.	90.25	36	40	250
	Bannister	BA-PAC-3-V6A-39	PAC Table, Version 6 Acrylic Style, 3 Person	\$ 4,765	Standing Hgt.	90.25	36	47	260
	Bannister	BA-PAC-1-V6M-29	PAC Table, Version 6 Molding Style, 1 Person	\$ 3,670	Sitting Hgt.	36.25	36	37	130
	Bannister	BA-PAC-1-V6M-32	PAC Table, Version 6 Molding Style, 1 Person	\$ 3,710	Wheelchair Hgt.	36.25	36	40	130
	Bannister	BA-PAC-1-V6M-39	PAC Table, Version 6 Molding Style, 1 Person	\$ 3,825	Standing Hgt.	36.25	36	47	135
	Bannister	BA-PAC-2-V6M-29	PAC Table, Version 6 Molding Style, 2 Person	\$ 4,265	Sitting Hgt.	72.25	36	37	200
	Bannister	BA-PAC-2-V6M-32	PAC Table, Version 6 Molding Style, 2 Person	\$ 4,310	Wheelchair Hgt.	72.25	36	40	200
	Bannister	BA-PAC-2-V6M-39	PAC Table, Version 6 Molding Style, 2 Person	\$ 4,440	Standing Hgt.	72.25	36	47	205
	Bannister	BA-PAC-3-V6M-29	PAC Table, Version 6 Molding Style, 3 Person	\$ 4,715	Sitting Hgt.	90.25	36	37	250
	Bannister	BA-PAC-3-V6M-32	PAC Table, Version 6 Molding Style, 3 Person	\$ 4,760	Wheelchair Hgt.	90.25	36	40	250
	Bannister	BA-PAC-3-V6M-39	PAC Table, Version 6 Molding Style, 3 Person	\$ 4,900	Standing Hgt.	90.25	36	47	260
	Bannister	BA-PAC-1-V6S-29	PAC Table, Version 6 Shaker Style, 1 Person	\$ 3,375	Sitting Hgt.	36.25	36	37	130
	Bannister	BA-PAC-1-V6S-32	PAC Table, Version 6 Shaker Style, 1 Person	\$ 3,405	Wheelchair Hgt.	36.25	36	40	130
	Bannister	BA-PAC-1-V6S-39	PAC Table, Version 6 Shaker Style, 1 Person	\$ 3,490	Standing Hgt.	36.25	36	47	135
	Bannister	BA-PAC-2-V6S-29	PAC Table, Version 6 Shaker Style, 2 Person	\$ 3,970	Sitting Hgt.	72.25	36	37	200





Image	Collection	Catalog Number	Item Description	List Price	Colour / Type	Width (Inches)	Depth (Inches)	Height (Inches)	Weight (Lbs.)
	Bannister	BA-PAC-2-V6S-32	PAC Table, Version 6 Shaker Style, 2 Person	\$ 4,005	Wheelchair Hgt.	72.25	36	40	200
	Bannister	BA-PAC-2-V6S-39	PAC Table, Version 6 Shaker Style, 2 Person	\$ 4,110	Standing Hgt.	72.25	36	47	205
	Bannister	BA-PAC-3-V6S-29	PAC Table, Version 6 Shaker Style, 3 Person	\$ 4,425	Sitting Hgt.	90.25	36	37	250
	Bannister	BA-PAC-3-V6S-32	PAC Table, Version 6 Shaker Style, 3 Person	\$ 4,455	Wheelchair Hgt.	90.25	36	40	250
	Bannister	BA-PAC-3-V6S-39	PAC Table, Version 6 Shaker Style, 3 Person	\$ 4,570	Standing Hgt.	90.25	36	47	260
	Bannister	BA-R36	Round Table	\$ 2,030		36	36	29	70
	Bannister	BA-R42	Round Table	\$ 2,245		42	42	29	90
	Bannister	BA-R48	Round Table	\$ 2,380		48	48	29	100
	Bannister	BA-3636	Square Table	\$ 2,300		36	36	29	70
	Bannister	BA-4242	Square Table	\$ 2,550		42	42	29	90
	Bannister	BA-4848	Square Table	\$ 2,665		48	48	29	100
	Bannister	BA-V1A-6036	Rectangle Table, Version 1 Acrylic Style, 60" Width	\$ 4,155		60	36	29	175
	Bannister	BA-V1A-6042	Rectangle Table, Version 1 Acrylic Style, 60" Width	\$ 4,325		60	42	29	160
	Bannister	BA-V1A-6048	Rectangle Table, version 1 Acrylic Style, 60" Width	\$ 4,495		60	48	29	230
	Bannister	BA-V1A-7236	Rectangle Table, Version 1 Acrylic Style, 72" Width	\$ 4,330		72	36	29	190
	Bannister	BA-V1A-7242	Rectangle Table, Version 1 Acrylic Style, 72" Width	\$ 4,505		72	42	29	215
	Bannister	BA-V1A-7248	Rectangle Table, version 1 Acrylic Style, 72" Width	\$ 4,685		72	48	29	230
	Bannister	BA-V1A-8436	Rectangle Table, Version 1 Acrylic Style, 84" Width	\$ 4,505		84	36	29	230
	Bannister	BA-V1A-8442	Rectangle Table, Version 1 Acrylic Style, 84" Width	\$ 4,690		84	42	29	245
	Bannister	BA-V1A-8448	Rectangle Table, version 1 Acrylic Style, 84" Width	\$ 4,870		84	48	29	290
	Bannister	BA-V1A-9636	Rectangle Table, Version 1 Acrylic Style, 96" Width	\$ 4,680		96	36	29	290
	Bannister	BA-V1A-9642	Rectangle Table, Version 1 Acrylic Style, 96" Width	\$ 4,870		96	42	29	310
	Bannister	BA-V1A-9648	Rectangle Table, version 1 Acrylic Style, 96" Width	\$ 5,060		96	48	29	320

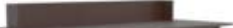

Image	Collection	Catalog Number	Item Description	List Price	Colour / Type	Width (Inches)	Depth (Inches)	Height (Inches)	Weight (Lbs.)
	Bannister	BA-V1M-6036	Rectangle Table, Version 1 Molding Styl. 60" Width	\$ 4,340		60	36	29	175
	Bannister	BA-V1M-6042	Rectangle Table, Version 1 Molding Styl. 60" Width	\$ 4,520		60	42	29	160
	Bannister	BA-V1M-6048	Rectangle Table, version 1 molding Styl. 60" Width	\$ 4,985		60	48	29	230
	Bannister	BA-V1M-7236	Rectangle Table, Version 1 Molding Styl. 72" Width	\$ 4,515		72	36	29	190
	Bannister	BA-V1M-7242	Rectangle Table, Version 1 Molding Styl. 72" Width	\$ 4,705		72	42	29	215
	Bannister	BA-V1M-7248	Rectangle Table, version 1 molding Styl. 72" Width	\$ 5,175		72	48	29	230
	Bannister	BA-V1M-8436	Rectangle Table, Version 1 Molding Styl. 84" Width	\$ 4,690		84	36	29	230
	Bannister	BA-V1M-8442	Rectangle Table, Version 1 Molding Styl. 84" Width	\$ 4,885		84	42	29	245
	Bannister	BA-V1M-8448	Rectangle Table, version 1 molding Styl. 84" Width	\$ 5,360		84	48	29	290
	Bannister	BA-V1M-9636	Rectangle Table, Version 1 Molding Styl. 96" Width	\$ 4,865		96	36	29	290
	Bannister	BA-V1M-9642	Rectangle Table, Version 1 Molding Styl. 96" Width	\$ 5,065		96	42	29	310
	Bannister	BA-V1M-9648	Rectangle Table, version 1 molding Styl. 96" Width	\$ 5,550		96	48	29	320
	Bannister	BA-V1S-6036	Rectangle Table, Version 1 Shaker Styl. 60" Width	\$ 3,985		60	36	29	175
	Bannister	BA-V1S-6042	Rectangle Table, Version 1 Shaker Styl. 60" Width	\$ 4,115		60	42	29	160
	Bannister	BA-V1S-6048	Rectangle Table, version 1 shaker Styl. 60" Width	\$ 4,250		60	48	29	230
	Bannister	BA-V1S-7236	Rectangle Table, Version 1 Shaker Styl. 72" Width	\$ 4,155		72	36	29	190
	Bannister	BA-V1S-7242	Rectangle Table, Version 1 Shaker Styl. 72" Width	\$ 4,300		72	42	29	215
	Bannister	BA-V1S-7248	Rectangle Table, version 1 shaker Styl. 72" Width	\$ 4,440		72	48	29	230
	Bannister	BA-V1S-8436	Rectangle Table, Version 1 Shaker Styl. 84" Width	\$ 4,330		84	36	29	230
	Bannister	BA-V1S-8442	Rectangle Table, Version 1 Shaker Styl. 84" Width	\$ 4,480		84	42	29	245
	Bannister	BA-V1S-8448	Rectangle Table, version 1 shaker Styl. 84" Width	\$ 4,625		84	48	29	290
	Bannister	BA-V1S-9636	Rectangle Table, Version 1 Shaker Styl. 96" Width	\$ 4,505		96	36	29	290
	Bannister	BA-V1S-9642	Rectangle Table, Version 1 Shaker Styl. 96" Width	\$ 4,660		96	42	29	310
	Bannister	BA-V1S-9648	Rectangle Table, version 1 shaker Styl. 96" Width	\$ 4,815		96	48	29	320
	Bannister	BA-V2A-6036	Rectangle Table, Version 2 Acrylic Styl. 60" Width	\$ 3,830		60	36	29	175
	Bannister	BA-V2A-6042	Rectangle Table, Version 2 Acrylic Styl. 60" Width	\$ 3,995		60	42	29	160
	Bannister	BA-V2A-6048	Rectangle Table, version 2 Acrylic Styl. 60" Width	\$ 4,165		60	48	29	230
	Bannister	BA-V2A-7236	Rectangle Table, Version 2 Acrylic Styl. 72" Width	\$ 4,000		72	36	29	190
	Bannister	BA-V2A-7242	Rectangle Table, Version 2 Acrylic Styl. 72" Width	\$ 4,180		72	42	29	215
	Bannister	BA-V2A-7248	Rectangle Table, version 2 Acrylic Styl. 72" Width	\$ 4,355		72	48	29	230
	Bannister	BA-V2A-8436	Rectangle Table, Version 2 Acrylic Styl. 84" Width	\$ 4,175		84	36	29	230



Image	Collection	Catalog Number	Item Description	List Price	Colour / Type	Width (Inches)	Depth (Inches)	Height (Inches)	Weight (Lbs.)	
	Bannister	BA-V2A-8442	Rectangle Table, Version 2 Acrylic Styl. 84" Width	\$ 4,360		84	42	29	245	
	Bannister	BA-V2A-8448	Rectangle Table, Version 2 Acrylic Styl. 84" Width	\$ 4,540		84	48	29	290	
	Bannister	BA-V2A-9636	Rectangle Table, Version 2 Acrylic Styl. 96" Width	\$ 4,350		96	36	29	290	
	Bannister	BA-V2A-9642	Rectangle Table, Version 2 Acrylic Styl. 96" Width	\$ 4,540		96	42	29	310	
	Bannister	BA-V2A-9648	Rectangle Table, Version 2 Acrylic Styl. 96" Width	\$ 4,730		96	48	29	320	
	Bannister	BA-V2M-6036	Rectangle Table, Version 2 Molding Styl. 60" Width	\$ 3,970		60	36	29	175	
	Bannister	BA-V2M-6042	Rectangle Table, Version 2 Molding Styl. 60" Width	\$ 4,150		60	42	29	160	
	Bannister	BA-V2M-6048	Rectangle Table, version 2 molding Styl. 60" Width	\$ 4,330		60	48	29	230	
	Bannister	BA-V2M-7236	Rectangle Table, Version 2 Molding Styl. 72" Width	\$ 4,145		72	36	29	190	
	Bannister	BA-V2M-7242	Rectangle Table, Version 2 Molding Styl. 72" Width	\$ 4,330		72	42	29	215	
	Bannister	BA-V2M-7248	Rectangle Table, version 2 molding Styl. 72" Width	\$ 4,520		72	48	29	230	
	Bannister	BA-V2M-8436	Rectangle Table, Version 2 Molding Styl. 84" Width	\$ 4,320		84	36	29	230	
	Bannister	BA-V2M-8442	Rectangle Table, Version 2 Molding Styl. 84" Width	\$ 4,515		84	42	29	245	
	Bannister	BA-V2M-8448	Rectangle Table, version 2 molding Styl. 84" Width	\$ 4,705		84	48	29	290	
	Bannister	BA-V2M-9636	Rectangle Table, Version 2 Molding Styl. 96" Width	\$ 4,495		96	36	29	290	
	Bannister	BA-V2M-9642	Rectangle Table, Version 2 Molding Styl. 96" Width	\$ 4,695		96	42	29	310	
	Bannister	BA-V2M-9648	Rectangle Table, version 2 molding Styl. 96" Width	\$ 4,895		96	48	29	320	
		Bannister	BA-V2S-6036	Rectangle Table, Version 2 Shaker Styl. 60" Width	\$ 3,670		60	36	29	175
		Bannister	BA-V2S-6042	Rectangle Table, Version 2 Shaker Styl. 60" Width	\$ 3,800		60	42	29	160
Bannister		BA-V2S-6048	Rectangle Table, Version 2 Shaker Styl. 60" Width	\$ 3,940		60	48	29	230	
Bannister		BA-V2S-7236	Rectangle Table, Version 2 Shaker Styl. 72" Width	\$ 3,845		72	36	29	190	
Bannister		BA-V2S-7242	Rectangle Table, Version 2 Shaker Styl. 72" Width	\$ 3,985		72	42	29	215	
Bannister		BA-V2S-7248	Rectangle Table, version 2 shaker Styl. 72" Width	\$ 4,125		72	48	29	230	
Bannister		BA-V2S-8436	Rectangle Table, Version 2 Shaker Styl. 84" Width	\$ 4,020		84	36	29	230	
Bannister		BA-V2S-8442	Rectangle Table, Version 2 Shaker Styl. 84" Width	\$ 4,165		84	42	29	245	
Bannister		BA-V2S-8448	Rectangle Table, Version 2 Shaker Styl. 84" Width	\$ 4,315		84	48	29	290	
Bannister		BA-V2S-9636	Rectangle Table, Version 2 Shaker Styl. 96" Width	\$ 4,190		96	36	29	290	
Bannister		BA-V2S-9642	Rectangle Table, Version 2 Shaker Styl. 96" Width	\$ 4,345		96	42	29	310	



Image	Collection	Catalog Number	Item Description	List Price	Colour / Type	Width (Inches)	Depth (Inches)	Height (Inches)	Weight (Lbs.)	
	Bannister	BA-V2S-9648	Rectangle Table, Version 2 Shaker Style, 96" Width	\$ 4,500		96	48	29	320	
	Bannister	BA-V3A-6036	Rectangle Table, Version 3 Acrylic Style, 60" Width	\$ 4,155		60	36	29	175	
	Bannister	BA-V3A-6042	Rectangle Table, Version 3 Acrylic Style, 60" Width	\$ 4,325		60	42	29	160	
	Bannister	BA-V3A-6048	Rectangle Table, Version 3 Acrylic Style, 60" Width	\$ 4,495		60	48	29	230	
	Bannister	BA-V3A-7236	Rectangle Table, Version 3 Acrylic Style, 72" Width	\$ 4,330		72	36	29	190	
	Bannister	BA-V3A-7242	Rectangle Table, Version 3 Acrylic Style, 72" Width	\$ 4,505		72	42	29	215	
	Bannister	BA-V3A-7248	Rectangle Table, Version 3 Acrylic Style, 72" Width	\$ 4,685		72	48	29	230	
	Bannister	BA-V3A-8436	Rectangle Table, Version 3 Acrylic Style, 84" Width	\$ 4,505		84	36	29	230	
	Bannister	BA-V3A-8442	Rectangle Table, Version 3 Acrylic Style, 84" Width	\$ 4,690		84	42	29	245	
	Bannister	BA-V3A-8448	Rectangle Table, Version 3 Acrylic Style, 84" Width	\$ 4,870		84	48	29	290	
	Bannister	BA-V3A-9636	Rectangle Table, Version 3 Acrylic Style, 96" Width	\$ 4,680		96	36	29	290	
	Bannister	BA-V3A-9642	Rectangle Table, Version 3 Acrylic Style, 96" Width	\$ 4,870		96	42	29	310	
	Bannister	BA-V3A-9648	Rectangle Table, Version 3 Acrylic Style, 96" Width	\$ 5,060		96	48	29	320	
		Bannister	BA-V3M-6036	Rectangle Table, Version 3 Molding Style, 60" Width	\$ 4,340		60	36	29	175
		Bannister	BA-V3M-6042	Rectangle Table, Version 3 Molding Style, 60" Width	\$ 4,520		60	42	29	160
Bannister		BA-V3M-6048	Rectangle Table, Version 3 Molding Style, 60" Width	\$ 4,985		60	48	29	230	
Bannister		BA-V3M-7236	Rectangle Table, Version 3 Molding Style, 72" Width	\$ 4,515		72	36	29	190	
Bannister		BA-V3M-7242	Rectangle Table, Version 3 Molding Style, 72" Width	\$ 4,705		72	42	29	215	
Bannister		BA-V3M-7248	Rectangle Table, Version 3 Molding Style, 72" Width	\$ 5,175		72	48	29	230	
Bannister		BA-V3M-8436	Rectangle Table, Version 3 Molding Style, 84" Width	\$ 4,690		84	36	29	230	
Bannister		BA-V3M-8442	Rectangle Table, Version 3 Molding Style, 84" Width	\$ 4,885		84	42	29	245	
Bannister		BA-V3M-8448	Rectangle Table, Version 3 Molding Style, 84" Width	\$ 5,360		84	48	29	290	
Bannister		BA-V3M-9636	Rectangle Table, Version 3 Molding Style, 96" Width	\$ 4,865		96	36	29	290	
Bannister		BA-V3M-9642	Rectangle Table, Version 3 Molding Style, 96" Width	\$ 5,065		96	42	29	310	
Bannister		BA-V3M-9648	Rectangle Table, Version 3 Molding Style, 96" Width	\$ 5,550		96	48	29	320	
Bannister		BA-V3S-6036	Rectangle Table, Version 3 Shaker Style, 60" Width	\$ 3,985		60	36	29	175	
Bannister		BA-V3S-6042	Rectangle Table, Version 3 Shaker Style, 60" Width	\$ 4,115		60	42	29	160	
Bannister	BA-V3S-6048	Rectangle Table, Version 3 Shaker Style, 60" Width	\$ 4,250		60	48	29	230		



Image	Collection	Catalog Number	Item Description	List Price	Colour / Type	Width (Inches)	Depth (Inches)	Height (Inches)	Weight (Lbs.)
	Bannister	BA-V3S-7236	Rectangle Table, Version 3 Shaker Styl. 72" Width	\$ 4,155		72	36	29	190
	Bannister	BA-V3S-7242	Rectangle Table, Version 3 Shaker Styl. 72" Width	\$ 4,300		72	42	29	215
	Bannister	BA-V3S-7248	Rectangle Table, Version 3 Shaker Styl. 72" Width	\$ 4,440		72	48	29	230
	Bannister	BA-V3S-8436	Rectangle Table, Version 3 Shaker Styl. 84" Width	\$ 4,330		84	36	29	230
	Bannister	BA-V3S-8442	Rectangle Table, Version 3 Shaker Styl. 84" Width	\$ 4,480		84	42	29	245
	Bannister	BA-V3S-8448	Rectangle Table, Version 3 Shaker Styl. 84" Width	\$ 4,625		84	48	29	290
	Bannister	BA-V3S-9636	Rectangle Table, Version 3 Shaker Styl. 96" Width	\$ 4,505		96	36	29	290
	Bannister	BA-V3S-9642	Rectangle Table, Version 3 Shaker Styl. 96" Width	\$ 4,660		96	42	29	310
	Bannister	BA-V3S-9648	Rectangle Table, Version 3 Shaker Styl. 96" Width	\$ 4,815		96	48	29	320
		Bannister	BA-V4A-6036	Rectangle Table, Version 4 Acrylic Styl. 60" Width	\$ 4,155		60	36	29
Bannister		BA-V4A-6042	Rectangle Table, Version 4 Acrylic Styl. 60" Width	\$ 4,325		60	42	29	160
Bannister		BA-V4A-6048	Rectangle Table, Version 4 Acrylic Styl. 60" Width	\$ 4,495		60	48	29	230
Bannister		BA-V4A-7236	Rectangle Table, Version 4 Acrylic Styl. 72" Width	\$ 4,330		72	36	29	190
Bannister		BA-V4A-7242	Rectangle Table, Version 4 Acrylic Styl. 72" Width	\$ 4,505		72	42	29	215
Bannister		BA-V4A-7248	Rectangle Table, Version 4 Acrylic Styl. 72" Width	\$ 4,685		72	48	29	230
Bannister		BA-V4A-8436	Rectangle Table, Version 4 Acrylic Styl. 84" Width	\$ 4,505		84	36	29	230
Bannister		BA-V4A-8442	Rectangle Table, Version 4 Acrylic Styl. 84" Width	\$ 4,690		84	42	29	245
Bannister		BA-V4A-8448	Rectangle Table, Version 4 Acrylic Styl. 84" Width	\$ 4,870		84	48	29	290
Bannister		BA-V4A-9636	Rectangle Table, Version 4 Acrylic Styl. 96" Width	\$ 4,680		96	36	29	290
Bannister		BA-V4A-9642	Rectangle Table, Version 4 Acrylic Styl. 96" Width	\$ 4,870		96	42	29	310
Bannister		BA-V4A-9648	Rectangle Table, Version 4 Acrylic Styl. 96" Width	\$ 5,060		96	48	29	320
		Bannister	BA-V4M-6036	Rectangle Table, Version 4 Molding Styl. 60" Width	\$ 4,340		60	36	29
	Bannister	BA-V4M-6042	Rectangle Table, Version 4 Molding Styl. 60" Width	\$ 4,520		60	42	29	160
	Bannister	BA-V4M-6048	Rectangle Table, version 4 molding Styl. 60" Width	\$ 4,985		60	48	29	230
	Bannister	BA-V4M-7236	Rectangle Table, Version 4 Molding Styl. 72" Width	\$ 4,515		72	36	29	190
	Bannister	BA-V4M-7242	Rectangle Table, Version 4 Molding Styl. 72" Width	\$ 4,705		72	42	29	215
	Bannister	BA-V4M-7248	Rectangle Table, version 4 molding Styl. 72" Width	\$ 5,175		72	48	29	230



Image	Collection	Catalog Number	Item Description	List Price	Colour / Type	Width (Inches)	Depth (Inches)	Height (Inches)	Weight (Lbs.)
	Bannister	BA-V4M-8436	Rectangle Table, Version 4 Molding Styl. 84" Width	\$ 4,690		84	36	29	230
	Bannister	BA-V4M-8442	Rectangle Table, Version 4 Molding Styl. 84" Width	\$ 4,885		84	42	29	245
	Bannister	BA-V4M-8448	Rectangle Table, version 4 molding Styl. 84" Width	\$ 5,360		84	48	29	290
	Bannister	BA-V4M-9636	Rectangle Table, Version 4 Molding Styl. 96" Width	\$ 4,865		96	36	29	290
	Bannister	BA-V4M-9642	Rectangle Table, Version 4 Molding Styl. 96" Width	\$ 5,065		96	42	29	310
	Bannister	BA-V4M-9648	Rectangle Table, version 4 molding Styl. 96" Width	\$ 5,550		96	48	29	320
	Bannister	BA-V4S-6036	Rectangle Table, Version 4 Shaker Styl. 60" Width	\$ 3,985		60	36	29	175
	Bannister	BA-V4S-6042	Rectangle Table, Version 4 Shaker Styl. 60" Width	\$ 4,115		60	42	29	160
	Bannister	BA-V4S-6048	Rectangle Table, Version 4 Shaker Styl. 60" Width	\$ 4,250		60	48	29	230
	Bannister	BA-V4S-7236	Rectangle Table, Version 4 Shaker Styl. 72" Width	\$ 4,155		72	36	29	190
	Bannister	BA-V4S-7242	Rectangle Table, Version 4 Shaker Styl. 72" Width	\$ 4,300		72	42	29	215
	Bannister	BA-V4S-7248	Rectangle Table, Version 4 Shaker Styl. 72" Width	\$ 4,440		72	48	29	230
	Bannister	BA-V4S-8436	Rectangle Table, Version 4 Shaker Styl. 84" Width	\$ 4,330		84	36	29	230
	Bannister	BA-V4S-8442	Rectangle Table, Version 4 Shaker Styl. 84" Width	\$ 4,480		84	42	29	245
	Bannister	BA-V4S-8448	Rectangle Table, Version 4 Shaker Styl. 84" Width	\$ 4,625		84	48	29	290
	Bannister	BA-V4S-9636	Rectangle Table, Version 4 Shaker Styl. 96" Width	\$ 4,505		96	36	29	290
	Bannister	BA-V4S-9642	Rectangle Table, Version 4 Shaker Styl. 96" Width	\$ 4,660		96	42	29	310
	Bannister	BA-V4S-9648	Rectangle Table, Version 4 Shaker Styl. 96" Width	\$ 4,815		96	48	29	320
	Bannister	BA-V5A-6036	Rectangle Table, Version 5 Acrylic Styl. 60" Width	\$ 4,200		60	36	29	175
	Bannister	BA-V5A-6042	Rectangle Table, Version 5 Acrylic Styl. 60" Width	\$ 4,370		60	42	29	160
	Bannister	BA-V5A-6048	Rectangle Table, Version 5 Acrylic Styl. 60" Width	\$ 4,540		60	48	29	230
	Bannister	BA-V5A-7236	Rectangle Table, Version 5 Acrylic Styl. 72" Width	\$ 4,375		72	36	29	190
	Bannister	BA-V5A-7242	Rectangle Table, Version 5 Acrylic Styl. 72" Width	\$ 4,550		72	42	29	215
	Bannister	BA-V5A-7248	Rectangle Table, Version 5 Acrylic Styl. 72" Width	\$ 4,725		72	48	29	230
	Bannister	BA-V5A-8436	Rectangle Table, Version 5 Acrylic Styl. 84" Width	\$ 4,550		84	36	29	230
	Bannister	BA-V5A-8442	Rectangle Table, Version 5 Acrylic Styl. 84" Width	\$ 4,730		84	42	29	245
	Bannister	BA-V5A-8448	Rectangle Table, Version 5 Acrylic Styl. 84" Width	\$ 4,915		84	48	29	290



Image	Collection	Catalog Number	Item Description	List Price	Colour / Type	Width (Inches)	Depth (Inches)	Height (Inches)	Weight (Lbs.)
	Bannister	BA-V5A-9636	Rectangle Table, Version 5 Acrylic Styl. 96" Width	\$ 4,725		96	36	29	290
	Bannister	BA-V5A-9642	Rectangle Table, Version 5 Acrylic Styl. 96" Width	\$ 4,915		96	42	29	310
	Bannister	BA-V5A-9648	Rectangle Table, Version 5 Acrylic Styl. 96" Width	\$ 5,100		96	48	29	320
	Bannister	BA-V5M-6036	Rectangle Table, Version 5 Molding Styl. 60" Width	\$ 4,425		60	36	29	175
	Bannister	BA-V5M-6042	Rectangle Table, Version 5 Molding Styl. 60" Width	\$ 4,605		60	42	29	160
	Bannister	BA-V5M-6048	Rectangle Table, version 5 molding Styl. 60" Width	\$ 5,075		60	48	29	230
	Bannister	BA-V5M-7236	Rectangle Table, Version 5 Molding Styl. 72" Width	\$ 4,600		72	36	29	190
	Bannister	BA-V5M-7242	Rectangle Table, Version 5 Molding Styl. 72" Width	\$ 4,790		72	42	29	215
	Bannister	BA-V5M-7248	Rectangle Table, version 5 molding Styl. 72" Width	\$ 5,260		72	48	29	230
	Bannister	BA-V5M-8436	Rectangle Table, Version 5 Molding Styl. 84" Width	\$ 4,775		84	36	29	230
	Bannister	BA-V5M-8442	Rectangle Table, Version 5 Molding Styl. 84" Width	\$ 4,970		84	42	29	245
	Bannister	BA-V5M-8448	Rectangle Table, version 5 molding Styl. 84" Width	\$ 5,450		84	48	29	290
	Bannister	BA-V5M-9636	Rectangle Table, Version 5 Molding Styl. 96" Width	\$ 4,950		96	36	29	290
	Bannister	BA-V5M-9642	Rectangle Table, Version 5 Molding Styl. 96" Width	\$ 5,150		96	42	29	310
	Bannister	BA-V5M-9648	Rectangle Table, version 5 molding Styl. 96" Width	\$ 5,635		96	48	29	320
	Bannister	BA-V5S-6036	Rectangle Table, Version 5 Shaker Styl. 60" Width	\$ 4,010		60	36	29	175
	Bannister	BA-V5S-6042	Rectangle Table, Version 5 Shaker Styl. 60" Width	\$ 4,280		60	42	29	160
	Bannister	BA-V5S-6048	Rectangle Table, Version 5 Shaker Styl. 60" Width	\$ 4,145		60	48	29	230
	Bannister	BA-V5S-7236	Rectangle Table, Version 5 Shaker Styl. 72" Width	\$ 4,185		72	36	29	190
	Bannister	BA-V5S-7242	Rectangle Table, Version 5 Shaker Styl. 72" Width	\$ 4,470		72	42	29	215
	Bannister	BA-V5S-7248	Rectangle Table, Version 5 Shaker Styl. 72" Width	\$ 4,325		72	48	29	230
	Bannister	BA-V5S-8436	Rectangle Table, Version 5 Shaker Styl. 84" Width	\$ 4,360		84	36	29	230
	Bannister	BA-V5S-8442	Rectangle Table, Version 5 Shaker Styl. 84" Width	\$ 4,655		84	42	29	245
	Bannister	BA-V5S-8448	Rectangle Table, Version 5 Shaker Styl. 84" Width	\$ 4,505		84	48	29	290
	Bannister	BA-V5S-9636	Rectangle Table, Version 5 Shaker Styl. 96" Width	\$ 4,535		96	36	29	290
	Bannister	BA-V5S-9642	Rectangle Table, Version 5 Shaker Styl. 96" Width	\$ 4,845		96	42	29	310
	Bannister	BA-V5S-9648	Rectangle Table, Version 5 Shaker Styl. 96" Width	\$ 4,690		96	48	29	320
	Bannister	BA-V6A-6036	Rectangle Table, Version 6 Acrylic Styl. 60" Width	\$ 3,570		60	36	29	175



Image	Collection	Catalog Number	Item Description	List Price	Colour / Type	Width (Inches)	Depth (Inches)	Height (Inches)	Weight (Lbs.)
	Bannister	BA-V6A-6042	Rectangle Table, Version 6 Acrylic Styl. 60" Width	\$ 3,720		60	42	29	160
	Bannister	BA-V6A-6048	Rectangle Table, Version 6 Acrylic Style, 60" Width	\$ 3,870		60	48	29	230
	Bannister	BA-V6A-7236	Rectangle Table, Version 6 Acrylic Styl. 72" Width	\$ 3,740		72	36	29	190
	Bannister	BA-V6A-7242	Rectangle Table, Version 6 Acrylic Styl. 72" Width	\$ 3,900		72	42	29	215
	Bannister	BA-V6A-7248	Rectangle Table, Version 6 Acrylic Style, 72" Width	\$ 4,060		72	48	29	230
	Bannister	BA-V6A-8436	Rectangle Table, Version 6 Acrylic Styl. 84" Width	\$ 3,915		84	36	29	230
	Bannister	BA-V6A-8442	Rectangle Table, Version 6 Acrylic Style, 84" Width	\$ 4,080		84	42	29	245
	Bannister	BA-V6A-8448	Rectangle Table, Version 6 Acrylic Style, 84" Width	\$ 4,245		84	48	29	290
	Bannister	BA-V6A-9636	Rectangle Table, Version 6 Acrylic Styl. 96" Width	\$ 4,090		96	36	29	290
	Bannister	BA-V6A-9642	Rectangle Table, Version 6 Acrylic Styl. 96" Width	\$ 4,260		96	42	29	310
	Bannister	BA-V6A-9648	Rectangle Table, Version 6 Acrylic Style, 96" Width	\$ 4,435		96	48	29	320
		Bannister	BA-V6M-6036	Rectangle Table, Version 6 Molding Styl. 60" Width	\$ 3,745		60	36	29
Bannister		BA-V6M-6042	Rectangle Table, Version 6 Molding Styl. 60" Width	\$ 3,890		60	42	29	160
Bannister		BA-V6M-6048	Rectangle Table, version 6 molding Styl. 60" Width	\$ 4,035		60	48	29	230
Bannister		BA-V6M-7236	Rectangle Table, Version 6 Molding Styl. 72" Width	\$ 3,920		72	36	29	190
Bannister		BA-V6M-7242	Rectangle Table, Version 6 Molding Styl. 72" Width	\$ 4,070		72	42	29	215
Bannister		BA-V6M-7248	Rectangle Table, version 6 molding Styl. 72" Width	\$ 4,225		72	48	29	230
Bannister		BA-V6M-8436	Rectangle Table, Version 6 Molding Styl. 84" Width	\$ 4,095		84	36	29	230
Bannister		BA-V6M-8442	Rectangle Table, Version 6 Molding Styl. 84" Width	\$ 4,250		84	42	29	245
Bannister		BA-V6M-8448	Rectangle Table, version 6 molding Styl. 84" Width	\$ 4,410		84	48	29	290
Bannister		BA-V6M-9636	Rectangle Table, Version 6 Molding Styl. 96" Width	\$ 4,265		96	36	29	290
Bannister		BA-V6M-9642	Rectangle Table, Version 6 Molding Styl. 96" Width	\$ 4,435		96	42	29	310
Bannister		BA-V6M-9648	Rectangle Table, version 6 molding Styl. 96" Width	\$ 4,600		96	48	29	320
	Bannister	BA-V6S-6036	Rectangle Table, Version 6 Shaker Styl. 60" Width	\$ 3,450		60	36	29	175
	Bannister	BA-V6S-6042	Rectangle Table, Version 6 Shaker Styl. 60" Width	\$ 3,570		60	42	29	160
	Bannister	BA-V6S-6048	Rectangle Table, Version 6 Shaker Style, 60" Width	\$ 3,695		60	48	29	230
	Bannister	BA-V6S-7236	Rectangle Table, Version 6 Shaker Styl. 72" Width	\$ 3,625		72	36	29	190
	Bannister	BA-V6S-7242	Rectangle Table, Version 6 Shaker Style, 72" Width	\$ 3,755		72	42	29	215





Image	Collection	Catalog Number	Item Description	List Price	Colour / Type	Width (Inches)	Depth (Inches)	Height (Inches)	Weight (Lbs.)
	Bannister	BA-V6S-7248	Rectangle Table, Version 6 Shaker Style, 72" Width	\$ 3,885		72	48	29	230
	Bannister	BA-V6S-8436	Rectangle Table, Version 6 Shaker Style, 84" Width	\$ 3,800		84	36	29	230
	Bannister	BA-V6S-8442	Rectangle Table, Version 6 Shaker Style, 84" Width	\$ 3,935		84	42	29	245
	Bannister	BA-V6S-8448	Rectangle Table, Version 6 Shaker Style, 84" Width	\$ 4,070		84	48	29	290
	Bannister	BA-V6S-9636	Rectangle Table, Version 6 Shaker Style, 96" Width	\$ 3,975		96	36	29	290
	Bannister	BA-V6S-9642	Rectangle Table, Version 6 Shaker Style, 96" Width	\$ 4,115		96	42	29	310
	Bannister	BA-V6S-9648	Rectangle Table, Version 6 Shaker Style, 96" Width	\$ 4,260		96	48	29	320
	Element	EL-AS	Atlas Stand	\$ 3,285		30.5	29	44.5	260
	Element	EL-DC	Dictionary Stand	\$ 2,415		27.5	21	44.25	180
	Element	EL-MC-36-SS	Modular Study Carrel: S/F	\$ 2,310	Starter - 36" Width	37.5	31	48	340
	Element	EL-MC-36-SA	Modular Study Carrel: S/F	\$ 1,845	Adder - 36" Width	36.25	31	48	165
	Element	EL-MC-48-SS	Modular Study Carrel: S/F	\$ 2,370	Starter - 48" Width	49.5	31	48	370





Image	Collection	Catalog Number	Item Description	List Price	Colour / Type	Width (Inches)	Depth (Inches)	Height (Inches)	Weight (Lbs.)
	Element	EL-MC-48-SA	Modular Study Carrel: S/F	\$ 1,905	Adder - 48" Width	48.25	31	48	200
	Element	EL-MC-36-DS	Modular Study Carrel: D/F	\$ 3,365	Starter - 36" Width	37.5	60.5	48	715
	Element	EL-MC-36-DA	Modular Study Carrel: D/F	\$ 2,495	Adder - 36" Width	36.25	60.5	48	250
	Element	EL-MC-48-DS	Modular Study Carrel: D/F	\$ 3,460	Starter - 48" Width	49.5	60.5	48	715
	Element	EL-MC-48-DA	Modular Study Carrel: D/F	\$ 2,590	Adder - 48" Width	48.25	60.5	48	310
	Element	EL-RC-36-SS	Modular Reference Carrels: S/F	\$ 2,445	Starter - 36" Width	37.5	31	48	340
	Element	EL-RC-36-SA	Modular Reference Carrels: S/F	\$ 1,980	Adder - 36" Width	36.25	31	48	165
	Element	EL-RC-48-SS	Modular Reference Carrels: S/F	\$ 2,500	Starter - 48" Width	49.5	31	48	370
	Element	EL-RC-48-SA	Modular Reference Carrels: S/F	\$ 2,035	Adder - 48" Width	48.25	31	48	200
	Element	EL-RC-36-DS	Modular Reference Carrels: D/F	\$ 3,630	Starter - 36" Width	37.5	60.5	48	715
	Element	EL-RC-36-DA	Modular Reference Carrels: D/F	\$ 2,760	Adder - 36" Width	36.25	60.5	48	250
	Element	EL-RC-48-DS	Modular Reference Carrels: D/F	\$ 3,725	Starter - 48" Width	49.5	60.5	48	715





Image	Collection	Catalog Number	Item Description	List Price	Colour / Type	Width (Inches)	Depth (Inches)	Height (Inches)	Weight (Lbs.)
	Element	EL-RC-48-DA	Modular Reference Carrels: D/F	\$ 2,855	Adder - 48" Width	48.25	60.5	48	310
	Element	EL-PAC-1-29-W	PAC Table: 1 Person	\$ 2,890	Sitting Hgt.- Wood Div.	36	36	37	65
	Element	EL-PAC-1-29-A	PAC Table: 1 Person	\$ 3,040	Sitting Hgt.- Acrylic Div.	36	36	37	65
	Element	EL-PAC-1-32-W	PAC Table: 1 Person	\$ 2,935	Wheelchair Hgt.- Wood Div.	36	36	40	65
	Element	EL-PAC-1-32-A	PAC Table: 1 Person	\$ 3,085	Wheelchair Hgt.- Acrylic Div.	36	36	40	65
	Element	EL-PAC-1-39-W	PAC Table: 1 Person	\$ 2,965	Standing Hgt.- Wood Div.	36	36	47	67
	Element	EL-PAC-1-39-A	PAC Table: 1 Person	\$ 3,120	Standing Hgt.- Acrylic Div.	36	36	47	67
	Element	EL-PAC-1D-29-W	PAC Table: 2 Person (1 Back to Back)	\$ 3,005	Sitting Hgt.- Wood Div.	36	48	37	65
	Element	EL-PAC-1D-29-A	PAC Table: 2 Person (1 Back to Back)	\$ 3,195	Sitting Hgt.- Acrylic Div.	36	48	37	65
	Element	EL-PAC-1D-32-W	PAC Table: 2 Person (1 Back to Back)	\$ 3,050	Wheelchair Hgt.- Wood Div.	36	48	40	65
	Element	EL-PAC-1D-32-A	PAC Table: 2 Person (1 Back to Back)	\$ 3,240	Wheelchair Hgt.- Acrylic Div.	36	48	40	65
	Element	EL-PAC-1D-39-W	PAC Table: 2 Person (1 Back to Back)	\$ 3,130	Standing Hgt.- Wood Div.	36	48	47	67
	Element	EL-PAC-1D-39-A	PAC Table: 2 Person (1 Back to Back)	\$ 3,320	Standing Hgt.- Acrylic Div.	36	48	47	67
	Element	EL-PAC-2-29-W	PAC Table: 2 Person	\$ 3,225	Sitting Hgt.- Wood Div.	72	36	37	100
	Element	EL-PAC-2-29-A	PAC Table: 2 Person	\$ 3,700	Sitting Hgt.- Acrylic Div.	72	36	37	100
	Element	EL-PAC-2-32-W	PAC Table: 2 Person	\$ 3,270	Wheelchair Hgt.- Wood Div.	72	36	40	100
	Element	EL-PAC-2-32-A	PAC Table: 2 Person	\$ 3,745	Wheelchair Hgt.- Acrylic Div.	72	36	40	100
	Element	EL-PAC-2-39-W	PAC Table: 2 Person	\$ 3,375	Standing Hgt.- Wood Div.	72	36	47	100
	Element	EL-PAC-2-39-A	PAC Table: 2 Person	\$ 3,850	Standing Hgt.- Acrylic Div.	72	36	47	100
	Element	EL-PAC-2D-29-W	PAC Table: 4 Person (2 Back to Back)	\$ 3,630	Sitting Hgt.- Wood Div.	72	48	37	100
	Element	EL-PAC-2D-29-A	PAC Table: 4 Person (2 Back to Back)	\$ 4,010	Sitting Hgt.- Acrylic Div.	72	48	37	100
	Element	EL-PAC-2D-32-W	PAC Table: 4 Person (2 Back to Back)	\$ 3,675	Wheelchair Hgt.- Wood Div.	72	48	40	100
	Element	EL-PAC-2D-32-A	PAC Table: 4 Person (2 Back to Back)	\$ 4,055	Wheelchair Hgt.- Acrylic Div.	72	48	40	100
	Element	EL-PAC-2D-39-W	PAC Table: 4 Person (2 Back to Back)	\$ 3,750	Standing Hgt.- Wood Div.	72	48	47	100
	Element	EL-PAC-2D-39-A	PAC Table: 4 Person (2 Back to Back)	\$ 4,135	Standing Hgt.- Acrylic Div.	72	48	47	100





Image	Collection	Catalog Number	Item Description	List Price	Colour / Type	Width (Inches)	Depth (Inches)	Height (Inches)	Weight (Lbs.)
	Element	EL-PAC-2D-39-A	PAC Table: 4 Person (2 Back to Back)	\$ 4,130	Standing Hgt.- Acrylic Div.	72	48	47	100
	Element	EL-PAC-3-29-W	PAC Table: 3 Person	\$ 3,405	Sitting Hgt.- Wood Div.	90	36	37	110
	Element	EL-PAC-3-29-A	PAC Table: 3 Person	\$ 4,225	Sitting Hgt.- Acrylic Div.	90	36	37	110
	Element	EL-PAC-3-32-W	PAC Table: 3 Person	\$ 3,450	Wheelchair Hgt.- Wood Div.	90	36	40	110
	Element	EL-PAC-3-32-A	PAC Table: 3 Person	\$ 4,270	Wheelchair Hgt.- Acrylic Div.	90	36	40	110
	Element	EL-PAC-3-39-W	PAC Table: 3 Person	\$ 3,625	Standing Hgt.- Wood Div.	90	36	47	114
	Element	EL-PAC-3-39-A	PAC Table: 3 Person	\$ 4,440	Standing Hgt.- Acrylic Div.	90	36	47	114
	Element	EL-PAC-3D-29-W	PAC Table: 6 Person (3 Back to Back)	\$ 3,880	Sitting Hgt.- Wood Div.	90	48	37	110
	Element	EL-PAC-3D-29-A	PAC Table: 6 Person (3 Back to Back)	\$ 4,610	Sitting Hgt.- Acrylic Div.	90	48	37	110
	Element	EL-PAC-3D-32-W	PAC Table: 6 Person (3 Back to Back)	\$ 3,925	Wheelchair Hgt.- Wood Div.	90	48	40	110
	Element	EL-PAC-3D-32-A	PAC Table: 6 Person (3 Back to Back)	\$ 4,655	Wheelchair Hgt.- Acrylic Div.	90	48	40	110
	Element	EL-PAC-3D-39-W	PAC Table: 6 Person (3 Back to Back)	\$ 4,070	Standing Hgt.- Wood Div.	90	48	47	114
	Element	EL-PAC-3D-39-A	PAC Table: 6 Person (3 Back to Back)	\$ 4,800	Standing Hgt.- Acrylic Div.	90	48	47	114
	Element	EL-PAC-1-PB-29-W	PAC Panel Base Table: 1 Person	\$ 2,215	Sitting Hgt.- Wood Div.	36	36	37	65
	Element	EL-PAC-1-PB-29-A	PAC Panel Base Table: 1 Person	\$ 2,510	Sitting Hgt.- Acrylic Div.	36	36	37	65
	Element	EL-PAC-1-PB-32-W	PAC Panel Base Table: 1 Person	\$ 2,225	Wheelchair Hgt.- Wood Div.	36	36	40	65
	Element	EL-PAC-1-PB-32-A	PAC Panel Base Table: 1 Person	\$ 2,520	Wheelchair Hgt.- Acrylic Div.	36	36	40	65
	Element	EL-PAC-1-PB-39-W	PAC Panel Base Table: 1 Person	\$ 2,260	Standing Hgt.- Wood Div.	36	36	47	67
	Element	EL-PAC-1-PB-39-A	PAC Panel Base Table: 1 Person	\$ 2,555	Standing Hgt.- Acrylic Div.	36	36	47	67
	Element	EL-PAC-1D-PB-29-W	PAC Panel Base Table: 2 Person (1 Back to Back)	\$ 2,560	Sitting Hgt.- Wood Div.	36	48	37	65
	Element	EL-PAC-1D-PB-29-A	PAC Panel Base Table: 2 Person (1 Back to Back)	\$ 2,890	Sitting Hgt.- Acrylic Div.	36	48	37	65
	Element	EL-PAC-1D-PB-32-W	PAC Panel Base Table: 2 Person (1 Back to Back)	\$ 2,575	Wheelchair Hgt.- Wood Div.	36	48	40	65
	Element	EL-PAC-1D-PB-32-A	PAC Panel Base Table: 2 Person (1 Back to Back)	\$ 2,905	Wheelchair Hgt.- Acrylic Div.	36	48	40	65
	Element	EL-PAC-1D-PB-39-W	PAC Panel Base Table: 2 Person (1 Back to Back)	\$ 2,600	Standing Hgt.- Wood Div.	36	48	47	67
	Element	EL-PAC-1D-PB-39-A	PAC Panel Base Table: 2 Person (1 Back to Back)	\$ 2,935	Standing Hgt.- Acrylic Div.	36	48	47	67





Image	Collection	Catalog Number	Item Description	List Price	Colour / Type	Width (Inches)	Depth (Inches)	Height (Inches)	Weight (Lbs.)
	Element	EL-PAC-2-PB-29-W	PAC Panel Base Table: 2 Person	\$ 2,425	Sitting Hgt.- Wood Div.	72	36	37	100
	Element	EL-PAC-2-PB-29-A	PAC Panel Base Table: 2 Person	\$ 3,040	Sitting Hgt.- Acrylic Div.	72	36	37	100
	Element	EL-PAC-2-PB-32-W	PAC Panel Base Table: 2 Person	\$ 2,435	Wheelchair Hgt.- Wood Div.	72	36	40	100
	Element	EL-PAC-2-PB-32-A	PAC Panel Base Table: 2 Person	\$ 3,050	Wheelchair Hgt.- Acrylic Div.	72	36	40	100
	Element	EL-PAC-2-PB-39-W	PAC Panel Base Table: 2 Person	\$ 2,465	Standing Hgt.- Wood Div.	72	36	47	100
	Element	EL-PAC-2-PB-39-A	PAC Panel Base Table: 2 Person	\$ 3,085	Standing Hgt.- Acrylic Div.	72	36	47	100
	Element	EL-PAC-2D-PB-29-W	PAC Panel Base Table: 4 Person (2 Back to Back)	\$ 2,840	Sitting Hgt.- Wood Div.	72	48	37	100
	Element	EL-PAC-2D-PB-29-A	PAC Panel Base Table: 4 Person (2 Back to Back)	\$ 3,525	Sitting Hgt.- Acrylic Div.	72	48	37	100
	Element	EL-PAC-2D-PB-32-W	PAC Panel Base Table: 4 Person (2 Back to Back)	\$ 2,855	Wheelchair Hgt.- Wood Div.	72	48	40	100
	Element	EL-PAC-2D-PB-32-A	PAC Panel Base Table: 4 Person (2 Back to Back)	\$ 3,540	Wheelchair Hgt.- Acrylic Div.	72	48	40	100
	Element	EL-PAC-2D-PB-39-W	PAC Panel Base Table: 4 Person (2 Back to Back)	\$ 2,885	Standing Hgt.- Wood Div.	72	48	47	100
	Element	EL-PAC-2D-PB-39-A	PAC Panel Base Table: 4 Person (2 Back to Back)	\$ 3,565	Standing Hgt.- Acrylic Div.	72	48	47	100
	Element	EL-PAC-3-PB-29-W	PAC Panel Base Table: 3 Person	\$ 2,580	Sitting Hgt.- Wood Div.	90	36	37	110
	Element	EL-PAC-3-PB-29-A	PAC Panel Base Table: 3 Person	\$ 3,540	Sitting Hgt.- Acrylic Div.	90	36	37	110
	Element	EL-PAC-3-PB-32-W	PAC Panel Base Table: 3 Person	\$ 2,585	Wheelchair Hgt.- Wood Div.	90	36	40	110
	Element	EL-PAC-3-PB-32-A	PAC Panel Base Table: 3 Person	\$ 3,545	Wheelchair Hgt.- Acrylic Div.	90	36	40	110
	Element	EL-PAC-3-PB-39-W	PAC Panel Base Table: 3 Person	\$ 2,620	Standing Hgt.- Wood Div.	90	36	47	114
	Element	EL-PAC-3-PB-39-A	PAC Panel Base Table: 3 Person	\$ 3,580	Standing Hgt.- Acrylic Div.	90	36	47	114
	Element	EL-PAC-3D-PB-29-W	PAC Panel Base Table: 6 Person (3 Back to Back)	\$ 3,225	Sitting Hgt.- Wood Div.	90	48	37	110
	Element	EL-PAC-3D-PB-29-A	PAC Panel Base Table: 6 Person (3 Back to Back)	\$ 4,240	Sitting Hgt.- Acrylic Div.	90	48	37	110
	Element	EL-PAC-3D-PB-32-W	PAC Panel Base Table: 6 Person (3 Back to Back)	\$ 3,240	Wheelchair Hgt.- Wood Div.	90	48	40	110
	Element	EL-PAC-3D-PB-32-A	PAC Panel Base Table: 6 Person (3 Back to Back)	\$ 4,255	Wheelchair Hgt.- Acrylic Div.	90	48	40	110
	Element	EL-PAC-3D-PB-39-W	PAC Panel Base Table: 6 Person (3 Back to Back)	\$ 3,270	Standing Hgt.- Wood Div.	90	48	47	114
	Element	EL-PAC-3D-PB-39-A	PAC Panel Base Table: 6 Person (3 Back to Back)	\$ 4,280	Standing Hgt.- Acrylic Div.	90	48	47	114
	Element	EL-R36	Round Table	\$ 2,295		36	36	29	90
	Element	EL-R42	Round Table	\$ 2,360		42	42	29	90





Image	Collection	Catalog Number	Item Description	List Price	Colour / Type	Width (Inches)	Depth (Inches)	Height (Inches)	Weight (Lbs.)
	Element	EL-R48	Round Table	\$ 2,425		48	48	29	100
	Element	EL-R60	Round Table	\$ 2,790		60	60	29	155
	Element	EL-4242	Square Table	\$ 2,310		42	42	29	170
	Element	EL-4848	Square Table	\$ 2,370		48	48	29	230
	Element	EL-6036	Rectangle Table 60" Width	\$ 2,455		60	36	29	200
	Element	EL-6048	Rectangle Table 60" Width	\$ 2,600		60	48	29	270
	Element	EL-7236	Rectangle Table 72" Width	\$ 2,520		72	36	29	230
	Element	EL-7248	Rectangle Table 72" Width	\$ 2,675		72	48	29	290
	Element	EL-8436	Rectangle Table 84" Width	\$ 2,585		84	36	29	290
	Element	EL-8448	Rectangle Table 84" Width	\$ 2,755		84	48	29	290
	Element	EL-9636	Rectangle Table 96" Width	\$ 2,645		96	36	29	290
	Element	EL-9648	Rectangle Table 96" Width	\$ 2,830		96	48	29	340
	Fusion	FS-AS	Atlas Stand	\$ 3,360		31	28	43	170









Image	Collection	Catalog Number	Item Description	List Price	Colour / Type	Width (Inches)	Depth (Inches)	Height (Inches)	Weight (Lbs.)
	Fusion	FS-DC	Dictionary Stand	\$ 2,390		26.75	19	42	70
	Fusion	FS-DP	Display Table	\$ 6,205		32	64	39	180
	Fusion	FS-SC-V1-36-SS	Study Carrel, Version 1, All Wood, S/F	\$ 2,255	Starter - 36" Width	37.5	31	36	180
	Fusion	FS-SC-V1-36-SA	Study Carrel, Version 1, All Wood, S/F	\$ 2,000	Adder - 36" Width	36	31	36	130
	Fusion	FS-SC-V1-48-SS	Study Carrel, Version 1, All Wood, S/F	\$ 2,340	Starter - 48" Width	49.5	31	36	200
	Fusion	FS-SC-V1-48-SA	Study Carrel, Version 1, All Wood, S/F	\$ 2,080	Adder - 48" Width	48	31	36	160
	Fusion	FS-SC-V1-36-DS	Study Carrel, Version 1, All Wood, D/F	\$ 3,105	Starter - 36" Width	37.5	62	36	255
	Fusion	FS-SC-V1-36-DA	Study Carrel, Version 1, All Wood, D/F	\$ 2,735	Adder - 36" Width	36	62	36	160





Image	Collection	Catalog Number	Item Description	List Price	Colour / Type	Width (Inches)	Depth (Inches)	Height (Inches)	Weight (Lbs.)
	Fusion	FS-SC-V1-48-DS	Study Carrel, Version 1, All Wood, D/F	\$ 3,250	Starter - 48" Width	49.5	62	36	290
	Fusion	FS-SC-V1-48-DA	Study Carrel, Version 1, All Wood, D/F	\$ 2,885	Adder - 48" Width	48	62	36	210
	Fusion	FS-SC-V2-36-SS	Study Carrel, Version 2, Wood Back Acrylic Dividers, S/F	\$ 2,520	Starter - 36" Width	37.5	31	36	180
	Fusion	FS-SC-V2-36-SA	Study Carrel, Version 2, Wood Back Acrylic Dividers, S/F	\$ 2,165	Adder - 36" Width	36	31	36	130
	Fusion	FS-SC-V2-48-SS	Study Carrel, Version 2, Wood Back Acrylic Dividers, S/F	\$ 2,600	Starter - 48" Width	49.5	31	36	200
	Fusion	FS-SC-V2-48-SA	Study Carrel, Version 2, Wood Back Acrylic Dividers, S/F	\$ 2,250	Adder - 48" Width	48	31	36	160
	Fusion	FS-SC-V2-36-DS	Study Carrel, Version 2, Wood Back Acrylic Dividers, D/F	\$ 3,555	Starter - 36" Width	37.5	62	36	255
	Fusion	FS-SC-V2-36-DA	Study Carrel, Version 2, Wood Back Acrylic Dividers, D/F	\$ 2,995	Adder - 36" Width	36	62	36	160
	Fusion	FS-SC-V2-48-DS	Study Carrel, Version 2, Wood Back Acrylic Dividers, D/F	\$ 3,705	Starter - 48" Width	49.5	62	36	290
	Fusion	FS-SC-V2-48-DA	Study Carrel, Version 2, Wood Back Acrylic Dividers, D/F	\$ 3,145	Adder - 48" Width	48	62	36	210
	Fusion	FS-SC-V3-36-SS	Study Carrel, Version 3, Acrylic Back and Dividers, S/F	\$ 2,615	Starter - 36" Width	37.5	31	36	180
	Fusion	FS-SC-V3-36-SA	Study Carrel, Version 3, Acrylic Back and Dividers, S/F	\$ 2,265	Adder - 36" Width	36	31	36	130
	Fusion	FS-SC-V3-48-SS	Study Carrel, Version 3, Acrylic Back and Dividers, S/F	\$ 2,705	Starter - 48" Width	49.5	31	36	200
	Fusion	FS-V3-SC-48-SA	Study Carrel, Version 3, Acrylic Back and Dividers, S/F	\$ 2,355	Adder - 48" Width	48	31	36	160



Image	Collection	Catalog Number	Item Description	List Price	Colour / Type	Width (Inches)	Depth (Inches)	Height (Inches)	Weight (Lbs.)
	Fusion	FS-SC-V3-36-DS	Study Carrel, Version 3, Acrylic Back and Dividers, D/F	\$ 3,655	Starter - 36" Width	37.5	62	36	255
	Fusion	FS-SC-V3-36-DA	Study Carrel, Version 3, Acrylic Back and Dividers, D/F	\$ 3,095	Adder - 36" Width	36	62	36	160
	Fusion	FS-SC-V3-48-DS	Study Carrel, Version 3, Acrylic Back and Dividers, D/F	\$ 3,810	Starter - 48" Width	49.5	62	36	290
	Fusion	FS-SC-V3-48-DA	Study Carrel, Version 3, Acrylic Back and Dividers, D/F	\$ 3,250	Adder - 48" Width	48	62	36	210
	Fusion	FS-RC-36-SS	Reference Carrel: S/F	\$ 2,455	Starter - 36" Width	37.5	31	48.5	200
	Fusion	FS-RC-36-SA	Reference Carrel: S/F	\$ 2,175	Adder - 36" Width	36.25	31	48.5	150
	Fusion	FS-RC-48-SS	Reference Carrel: S/F	\$ 2,550	Starter - 48" Width	49.25	31	48.5	230
	Fusion	FS-RC-48-SA	Reference Carrel: S/F	\$ 2,270	Adder - 48" Width	48.25	31	48.5	180
	Fusion	FS-RC-36-DS	Reference Carrel: D/F	\$ 3,350	Starter - 36" Width	37.5	60.5	48.5	275
	Fusion	FS-RC-36-DA	Reference Carrel: D/F	\$ 2,940	Adder - 36" Width	36.25	60.5	48.5	180
	Fusion	FS-RC-48-DS	Reference Carrel: D/F	\$ 3,640	Starter - 48" Width	49.25	60.5	48.5	310
	Fusion	FS-RC-48-DA	Reference Carrel: D/F	\$ 3,235	Adder - 48" Width	48.25	60.5	48.5	230
	Fusion	FS-PAC-1-29-W	PAC Table: 1 Person	\$ 2,885	Sitting Hgt.- Wood Div.	36	36	37	100
	Fusion	FS-PAC-1-29-A	PAC Table: 1 Person	\$ 3,040	Sitting Hgt.- Acrylic Div.	36	36	37	100



Image	Collection	Catalog Number	Item Description	List Price	Colour / Type	Width (Inches)	Depth (Inches)	Height (Inches)	Weight (Lbs.)
	Fusion	FS-PAC-1-32-W	PAC Table: 1 Person	\$ 2,935	Wheelchair Hgt.- Wood Div.	36	36	40	100
	Fusion	FS-PAC-1-32-A	PAC Table: 1 Person	\$ 3,085	Wheelchair Hgt.- Acrylic Div.	36	36	40	100
	Fusion	FS-PAC-1-39-W	PAC Table: 1 Person	\$ 2,980	Standing Hgt.- Wood Div.	36	36	47	100
	Fusion	FS-PAC-1-39-A	PAC Table: 1 Person	\$ 3,130	Standing Hgt.- Acrylic Div.	36	36	47	100
	Fusion	FS-PAC-1D-29-W	PAC Table: 2 Person (1 Back to Back)	\$ 3,050	Sitting Hgt.- Wood Div.	72	36	37	150
	Fusion	FS-PAC-1D-29-A	PAC Table: 2 Person (1 Back to Back)	\$ 3,240	Sitting Hgt.- Acrylic Div.	72	36	37	150
	Fusion	FS-PAC-1D-32-W	PAC Table: 2 Person (1 Back to Back)	\$ 3,095	Wheelchair Hgt.- Wood Div.	72	36	40	150
	Fusion	FS-PAC-1D-32-A	PAC Table: 2 Person (1 Back to Back)	\$ 3,285	Wheelchair Hgt.- Acrylic Div.	72	36	40	150
	Fusion	FS-PAC-1D-39-W	PAC Table: 2 Person (1 Back to Back)	\$ 3,140	Standing Hgt.- Wood Div.	72	36	47	150
	Fusion	FS-PAC-1D-39-A	PAC Table: 2 Person (1 Back to Back)	\$ 3,330	Standing Hgt.- Acrylic Div.	72	36	47	150
	Fusion	FS-PAC-2-29-W	PAC Table: 2 Person	\$ 3,390	Sitting Hgt.- Wood Div.	72	36	37	150
	Fusion	FS-PAC-2-29-A	PAC Table: 2 Person	\$ 3,865	Sitting Hgt.- Acrylic Div.	72	36	37	150
	Fusion	FS-PAC-2-32-W	PAC Table: 2 Person	\$ 3,435	Wheelchair Hgt.- Wood Div.	72	36	40	150
	Fusion	FS-PAC-2-32-A	PAC Table: 2 Person	\$ 3,910	Wheelchair Hgt.- Acrylic Div.	72	36	40	150
	Fusion	FS-PAC-2-39-W	PAC Table: 2 Person	\$ 3,480	Standing Hgt.- Wood Div.	72	36	47	150
	Fusion	FS-PAC-2-39-A	PAC Table: 2 Person	\$ 3,955	Standing Hgt.- Acrylic Div.	72	36	47	150



Image	Collection	Catalog Number	Item Description	List Price	Colour / Type	Width (Inches)	Depth (Inches)	Height (Inches)	Weight (Lbs.)
	Fusion	FS-PAC-2D-29-W	PAC Table: 4 Person (2 Back to Back)	\$ 3,700	Sitting Hgt.- Wood Div.	72	36	37	150
	Fusion	FS-PAC-2D-29-A	PAC Table: 4 Person (2 Back to Back)	\$ 4,150	Sitting Hgt.- Acrylic Div.	72	36	37	150
	Fusion	FS-PAC-2D-32-W	PAC Table: 4 Person (2 Back to Back)	\$ 3,745	Wheelchair Hgt.- Wood Div.	72	36	40	150
	Fusion	FS-PAC-2D-32-A	PAC Table: 4 Person (2 Back to Back)	\$ 4,195	Wheelchair Hgt.- Acrylic Div.	72	36	40	150
	Fusion	FS-PAC-2D-39-W	PAC Table: 4 Person (2 Back to Back)	\$ 3,790	Standing Hgt.- Wood Div.	72	36	47	150
	Fusion	FS-PAC-2D-39-A	PAC Table: 4 Person (2 Back to Back)	\$ 4,240	Standing Hgt.- Acrylic Div.	72	36	47	150
	Fusion	FS-PAC-3-29-W	PAC Table: 3 Person	\$ 3,695	Sitting Hgt.- Wood Div.	90	36	37	185
	Fusion	FS-PAC-3-29-A	PAC Table: 3 Person	\$ 4,510	Sitting Hgt.- Acrylic Div.	90	36	37	185
	Fusion	FS-PAC-3-32-W	PAC Table: 3 Person	\$ 3,740	Wheelchair Hgt.- Wood Div.	90	36	40	185
	Fusion	FS-PAC-3-32-A	PAC Table: 3 Person	\$ 4,555	Wheelchair Hgt.- Acrylic Div.	90	36	40	185
	Fusion	FS-PAC-3-39-W	PAC Table: 3 Person	\$ 3,785	Standing Hgt.- Wood Div.	90	36	47	185
	Fusion	FS-PAC-3-39-A	PAC Table: 3 Person	\$ 4,600	Standing Hgt.- Acrylic Div.	90	36	47	185
	Fusion	FS-PAC-3D-29-W	PAC Table: 6 Person (3 Back to Back)	\$ 4,055	Sitting Hgt.- Wood Div.	90	36	37	185
	Fusion	FS-PAC-3D-29-A	PAC Table: 6 Person (3 Back to Back)	\$ 4,855	Sitting Hgt.- Acrylic Div.	90	36	37	185
	Fusion	FS-PAC-3D-32-W	PAC Table: 6 Person (3 Back to Back)	\$ 4,105	Wheelchair Hgt.- Wood Div.	90	36	40	185
	Fusion	FS-PAC-3D-32-A	PAC Table: 6 Person (3 Back to Back)	\$ 4,900	Wheelchair Hgt.- Acrylic Div.	90	36	40	185





Image	Collection	Catalog Number	Item Description	List Price	Colour / Type	Width (Inches)	Depth (Inches)	Height (Inches)	Weight (Lbs.)
	Fusion	FS-PAC-3D-39-W	PAC Table: 6 Person (3 Back to Back)	\$ 4,150	Standing Hgt.- Wood Div.	90	36	47	185
	Fusion	FS-PAC-3D-39-A	PAC Table: 6 Person (3 Back to Back)	\$ 4,950	Standing Hgt.- Acrylic Div.	90	36	47	185
	Fusion	FS-R42	Round Table	\$ 2,650		42	42	29	90
	Fusion	FS-R48	Round Table	\$ 2,755		48	48	29	100
	Fusion	FS-4242	Square Table	\$ 2,295		42	42	29	90
	Fusion	FS-4848	Square Table	\$ 2,380		48	48	29	100
	Fusion	FS-6036	Rectangle Table 60" Width	\$ 2,590		60	36	29	110
	Fusion	FS-6048	Rectangle Table 60" Width	\$ 2,690		60	48	29	135
	Fusion	FS-7236	Rectangle Table 72" Width	\$ 2,680		72	36	29	125
	Fusion	FS-7248	Rectangle Table 72" Width	\$ 2,815		72	48	29	160
	Fusion	FS-8436	Rectangle Table 84" Width	\$ 2,845		84	36	29	142
	Fusion	FS-8448	Rectangle Table 84" Width	\$ 2,980		84	48	29	180
	Fusion	FS-9636	Rectangle Table 96" Width	\$ 2,955		96	36	29	140
	Fusion	FS-9648	Rectangle Table 96" Width	\$ 3,100		96	48	29	200





Image	Collection	Catalog Number	Item Description	List Price	Colour / Type	Width (Inches)	Depth (Inches)	Height (Inches)	Weight (Lbs.)
	Princeton	PT-NP	Newspaper Table	\$ 4,375		36	26	38	190
	Princeton	PT-AS	Atlas Stand	\$ 4,660		32.5	29.5	44.5	270
	Princeton	PT-DC	Dictionary Stand	\$ 3,375		28.25	16.75	44.5	190
	Princeton	PT-DP	Display Table	\$ 8,690		30.5	62.5	39	255



Image	Collection	Catalog Number	Item Description	List Price	Colour / Type	Width (Inches)	Depth (Inches)	Height (Inches)	Weight (Lbs.)
	Princeton	PT-DP-FB	Display Table	\$ 9,355	Fabric Covered Bottom	30.5	62.5	39	255
	Princeton	PT-AV	AV Browser	\$ 4,370		52.25	23.5	42.5	260
	Princeton	PT-IT-DS-4P	Index Table: 4 Person, (2 Back to Back), Double Tier	\$ 7,655		60	48	52.75	440







Image	Collection	Catalog Number	Item Description	List Price	Colour / Type	Width (Inches)	Depth (Inches)	Height (Inches)	Weight (Lbs.)
	Princeton	PT-IT-DS-6P	Index Table: 6 Person, (3 Back to Back), Double Tier	\$ 8,430		90	48	52.75	470
	Princeton	PT-MC-SS	Modular Carrel, S/F	\$ 4,765		35.75	26.5	48	140
	Princeton	PT-MC-DS	Modular Carrel, D/F	\$ 7,495		35.75	48	48	210
	Princeton	PT-MC-Q	Modular Carrel, 4 Person (2 Back to Back)	\$ 8,110		70.5	48	48	310
	Princeton	PT-PAC-1-29	PAC Table: 1 Person	\$ 4,710	Sitting Hgt.	36	36	37	135
	Princeton	PT-PAC-1-32	PAC Table: 1 Person	\$ 4,730	Wheelchair Hgt.	36	36	40	135

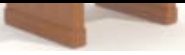





Image	Collection	Catalog Number	Item Description	List Price	Colour / Type	Width (Inches)	Depth (Inches)	Height (Inches)	Weight (Lbs.)
	Princeton	PT-PAC-1-39	PAC Table: 1 Person	\$ 4,790	Standing Hgt.	36	36	47	140
	Princeton	PT-PAC-2-29	PAC Table: 2 Person	\$ 5,070	Sitting Hgt.	72	36	37	205
	Princeton	PT-PAC-2-32	PAC Table: 2 Person	\$ 5,095	Wheelchair Hgt.	72	36	40	205
	Princeton	PT-PAC-2-39	PAC Table: 2 Person	\$ 5,150	Standing Hgt.	72	36	47	210
	Princeton	PT-PAC-3-29	PAC Table: 3 Person	\$ 5,480	Sitting Hgt.	90	36	37	260
	Princeton	PT-PAC-3-32	PAC Table: 3 Person	\$ 5,505	Wheelchair Hgt.	90	36	40	260
	Princeton	PT-PAC-3-39	PAC Table: 3 Person	\$ 5,560	Standing Hgt.	90	36	47	270
	Princeton	PT-PAC-1D-29	PAC Table: 2 Person (1 Back to Back)	\$ 7,410	Sitting Hgt.	36	60	37	260
	Princeton	PT-PAC-1D-32	PAC Table: 2 Person (1 Back to Back)	\$ 7,450	Wheelchair Hgt.	36	60	40	260
	Princeton	PT-PAC-1D-39	PAC Table: 2 Person (1 Back to Back)	\$ 7,555	Standing Hgt.	36	60	47	270
	Princeton	PT-PAC-2D-29	PAC Table: 4 Person (2 Back to Back)	\$ 8,045	Sitting Hgt.	72	60	37	400
	Princeton	PT-PAC-2D-32	PAC Table: 4 Person (2 Back to Back)	\$ 8,085	Wheelchair Hgt.	72	60	40	400
	Princeton	PT-PAC-2D-39	PAC Table: 4 Person (2 Back to Back)	\$ 8,185	Standing Hgt.	72	60	47	410
	Princeton	PT-PAC-3D-29	PAC Table: 6 Person (3 Back to Back)	\$ 8,590	Sitting Hgt.	90	60	37	500





Image	Collection	Catalog Number	Item Description	List Price	Colour / Type	Width (Inches)	Depth (Inches)	Height (Inches)	Weight (Lbs.)
	Princeton	PT-PAC-3D-32	PAC Table: 6 Person (3 Back to Back)	\$ 8,630	Wheelchair Hgt.	90	60	40	500
	Princeton	PT-PAC-3D-39	PAC Table: 6 Person (3 Back to Back)	\$ 8,730	Standing Hgt.	90	60	47	520
	Princeton	PT-R42	Round Table, 42" Width	\$ 2,610		42	42	29	90
	Princeton	PT-R48	Round Table, 48" Width	\$ 2,735		48	48	29	100
	Princeton	PT-4242	Square Table, 42" Width	\$ 2,195		42	42	29	90
	Princeton	PT-4848	Square Table, 48" Width	\$ 2,330		48	48	29	100
	Princeton	PT-6036	Rectangle Table, 60" Width	\$ 2,680		60	36	29	170
	Princeton	PT-6048	Rectangle Table, 60" Width	\$ 2,840		60	48	29	230
	Princeton	PT-7236	Rectangle Table, 72" Width	\$ 2,810		72	36	29	200
	Princeton	PT-7248	Rectangle Table, 72" Width	\$ 2,985		72	48	29	270
	Princeton	PT-8436	Rectangle Table, 84" Width	\$ 2,945		84	36	29	250
	Princeton	PT-8448	Rectangle Table, 84" Width	\$ 3,125		84	48	29	280
	Princeton	PT-9636	Rectangle Table, 96" Width	\$ 3,075		96	36	29	310
	Princeton	PT-9648	Rectangle Table, 96" Width	\$ 3,270		96	48	29	320



Image	Collection	Catalog Number	Item Description	List Price	Colour / Type	Width (Inches)	Depth (Inches)	Height (Inches)	Weight (Lbs.)
	Princeton	PT-6048-PB	Rectangle Table, Panel Base, 60" Width	\$ 6,045		60	48	29	250
	Princeton	PT-7248-PB	Rectangle Table, Panel Base, 72" Width	\$ 6,130		72	48	29	310
	Princeton	PT-8448-PB	Rectangle Table, Panel Base, 84" Width	\$ 6,430		84	48	29	250
	Princeton	PT-9648-PB	Rectangle Table, Panel Base, 96" Width	\$ 6,515		96	48	29	330
	Vista	VT-AS	Atlas Stand	\$ 4,120		30.5	29	44.5	260





Image	Collection	Catalog Number	Item Description	List Price	Colour / Type	Width (Inches)	Depth (Inches)	Height (Inches)	Weight (Lbs.)
	Vista	VT-DC	Dictionary Stand	\$ 3,210		27.5	21	44.5	180
	Vista	VT-DP	Display Table	\$ 6,720		30.5	62.5	39	245
	Vista	VT-DP-FB	Display Table	\$ 7,385	Fabric Covered Bottom	30.5	62.5	39	245
	Vista	VT-SC-V1-36-SS	Study Carrel, Version 1, S/F, 36" Height	\$ 3,195	Starter - 36" Width	38.5	31	36	340
	Vista	VT-SC-V1-36-SA	Study Carrel, Version 1, S/F, 36" Height	\$ 2,615	Adder - 36" Width	36.75	31	36	
	Vista	VT-SC-V1-48-SS	Study Carrel, Version 1, S/F, 36" Height	\$ 3,255	Starter - 48" Width	50.5	31	36	340
	Vista	VT-SC-V1-48-SA	Study Carrel, Version 1, S/F, 36" Height	\$ 2,675	Adder - 48" Width	48.75	31	36	
	Vista	VT-SC-V1-36-DS	Study Carrel, Version 1, D/F, 36" Height	\$ 4,685	Starter - 36" Width	38.5	60.5	36	655
	Vista	VT-SC-V1-36-DA	Study Carrel, Version 1, D/F, 36" Height	\$ 3,775	Adder - 36" Width	36.75	60.5	36	





Image	Collection	Catalog Number	Item Description	List Price	Colour / Type	Width (Inches)	Depth (Inches)	Height (Inches)	Weight (Lbs.)
	Vista	VT-SC-V1-48-DS	Study Carrel, Version 1, D/F, 36\"	\$ 4,770	Starter - 48\"	50.5	60.5	36	710
	Vista	VT-SC-V1-48-DA	Study Carrel, Version 1, D/F, 36\"	\$ 3,860	Adder - 48\"	48.75	60.5	36	
	Vista	VT-MC-V1-36-SS	Modular Carrel, Version 1, S/F, 48\"	\$ 3,550	Starter - 36\"	38.5	31	48	340
	Vista	VT-MC-V1-36-SA	Modular Carrel, Version 1, S/F, 48\"	\$ 2,865	Adder - 36\"	36.75	31	48	
	Vista	VT-MC-V1-48-SS	Modular Carrel, Version 1, S/F, 48\"	\$ 3,610	Starter - 48\"	50.5	31	48	340
	Vista	VT-MC-V1-48-SA	Modular Carrel, Version 1, S/F, 48\"	\$ 2,920	Adder - 48\"	48.75	31	48	
	Vista	VT-MC-V1-36-DS	Modular Carrel, Version 1, D/F, 48\"	\$ 5,180	Starter - 36\"	38.5	60.5	48	655
	Vista	VT-MC-V1-36-DA	Modular Carrel, Version 1, D/F, 48\"	\$ 4,085	Adder - 36\"	36.75	60.5	48	
	Vista	VT-MC-V1-48-DS	Modular Carrel, Version 1, D/F, 48\"	\$ 5,270	Starter - 48\"	50.5	60.5	48	710
	Vista	VT-MC-V1-48-DA	Modular Carrel, Version 1, D/F, 48\"	\$ 4,180	Adder - 48\"	48.75	60.5	48	
	Vista	VT-SC-V2-36-SS	Study Carrel, Version 2, S/F, 36\"	\$ 3,160	Starter - 36\"	38.5	31	36	340







Image	Collection	Catalog Number	Item Description	List Price	Colour / Type	Width (Inches)	Depth (Inches)	Height (Inches)	Weight (Lbs.)
	Vista	VT-SC-V2-36-SA	Study Carrel, Version 2, S/F, 36\"	\$ 2,590	Adder - 36\"	36.75	31	36	
	Vista	VT-SC-V2-48-SS	Study Carrel, Version 2, S/F, 36\"	\$ 3,225	Starter - 48\"	50.5	31	36	340
	Vista	VT-SC-V2-48-SA	Study Carrel, Version 2, S/F, 36\"	\$ 2,650	Adder - 48\"	48.75	31	36	
	Vista	VT-SC-V2-36-DS	Study Carrel, Version 2, D/F, 36\"	\$ 4,620	Starter - 36\"	38.5	60.5	36	655
	Vista	VT-SC-V2-36-DA	Study Carrel, Version 2, D/F, 36\"	\$ 3,665	Adder - 36\"	36.75	60.5	36	
	Vista	VT-SC-V2-48-DS	Study Carrel, Version 2, D/F, 36\"	\$ 4,705	Starter - 48\"	50.5	60.5	36	710
	Vista	VT-SC-V2-48-DA	Study Carrel, Version 2, D/F, 36\"	\$ 3,750	Adder - 48\"	48.75	60.5	36	
	Vista	VT-MC-V2-36-SS	Modular Carrel, Version 2, S/F, 48\"	\$ 3,515	Starter - 36\"	38.5	31	48	340
	Vista	VT-MC-V2-36-SA	Modular Carrel, Version 2, S/F, 48\"	\$ 2,840	Adder - 36\"	36.75	31	48	
	Vista	VT-MC-V2-48-SS	Modular Carrel, Version 2, S/F, 48\"	\$ 3,575	Starter - 48\"	50.5	31	48	340
	Vista	VT-MC-V2-48-SA	Modular Carrel, Version 2, S/F, 48\"	\$ 2,900	Adder - 48\"	48.75	31	48	



Image	Collection	Catalog Number	Item Description	List Price	Colour / Type	Width (Inches)	Depth (Inches)	Height (Inches)	Weight (Lbs.)
	Vista	VT-MC-V2-36-DS	Modular Carrel, Version 2, D/F, 48" Height	\$ 5,115	Starter - 36" Width	38.5	60.5	48	655
	Vista	VT-MC-V2-36-DA	Modular Carrel, Version 2, D/F, 48" Height	\$ 3,975	Adder - 36" Width	36.75	60.5	48	
	Vista	VT-MC-V2-48-DS	Modular Carrel, Version 2, D/F, 48" Height	\$ 5,205	Starter - 48" Width	50.5	60.5	48	710
	Vista	VT-MC-V2-48-DA	Modular Carrel, Version 2, D/F, 48" Height	\$ 4,065	Adder - 48" Width	48.75	60.5	48	
	Vista	VT-SC-V3-36-SS	Study Carrel, Version 3, S/F, 36" Height	\$ 3,035	Starter - 36" Width	38.5	31	36	340
	Vista	VT-SC-V3-36-SA	Study Carrel, Version 3, S/F, 36" Height	\$ 2,495	Adder - 36" Width	36.75	31	36	
	Vista	VT-SC-V3-48-SS	Study Carrel, Version 3, S/F, 36" Height	\$ 3,095	Starter - 48" Width	50.5	31	36	340
	Vista	VT-SC-V3-48-SA	Study Carrel, Version 3, S/F, 36" Height	\$ 2,555	Adder - 48" Width	48.75	31	36	
	Vista	VT-SC-V3-36-DS	Study Carrel, Version 3, D/F, 36" Height	\$ 4,365	Starter - 36" Width	38.5	60.5	36	655
	Vista	VT-SC-V3-36-DA	Study Carrel, Version 3, D/F, 36" Height	\$ 3,535	Adder - 36" Width	36.75	60.5	36	
	Vista	VT-SC-V3-48-DS	Study Carrel, Version 3, D/F, 36" Height	\$ 4,450	Starter - 48" Width	50.5	60.5	36	710

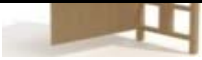





Image	Collection	Catalog Number	Item Description	List Price	Colour / Type	Width (Inches)	Depth (Inches)	Height (Inches)	Weight (Lbs.)
	Vista	VT-SC-V3-48-DA	Study Carrel, Version 3, D/F, 36\"	\$ 3,620	Adder - 48\"	48.75	60.5	36	
	Vista	VT-MC-V3-36-SS	Modular Carrel, Version 3, S/F, 48\"	\$ 3,400	Starter - 36\"	38.5	31	48	340
	Vista	VT-MC-V3-36-SA	Modular Carrel, Version 3, S/F, 48\"	\$ 2,755	Adder - 36\"	36.75	31	48	
	Vista	VT-MC-V3-48-SS	Modular Carrel, Version 3, S/F, 48\"	\$ 3,460	Starter - 48\"	50.5	31	48	340
	Vista	VT-MC-V3-48-SA	Modular Carrel, Version 3, S/F, 48\"	\$ 2,815	Adder - 48\"	48.75	31	48	
	Vista	VT-MC-V3-36-DS	Modular Carrel, Version 3, D/F, 48\"	\$ 4,880	Starter - 36\"	38.5	60.5	48	655
	Vista	VT-MC-V3-36-DA	Modular Carrel, Version 3, D/F, 48\"	\$ 3,855	Adder - 36\"	36.75	60.5	48	
	Vista	VT-MC-V3-48-DS	Modular Carrel, Version 3, D/F, 48\"	\$ 4,975	Starter - 48\"	50.5	60.5	48	710
	Vista	VT-MC-V3-48-DA	Modular Carrel, Version 3, D/F, 48\"	\$ 3,950	Adder - 48\"	48.75	60.5	48	
	Vista	VT-SC-V4-36-SS	Study Carrel, Version 4, S/F, 36\"	\$ 3,115	Starter - 36\"	38.5	31	36	340
	Vista	VT-SC-V4-36-SA	Study Carrel, Version 4, S/F, 36\"	\$ 2,535	Adder - 36\"	36.75	31	36	







Image	Collection	Catalog Number	Item Description	List Price	Colour / Type	Width (Inches)	Depth (Inches)	Height (Inches)	Weight (Lbs.)
	Vista	VT-SC-V4-48-SS	Study Carrel, Version 4, S/F, 36" Height	\$ 3,180	Starter - 48" Width	50.5	31	36	340
	Vista	VT-SC-V4-48-SA	Study Carrel, Version 4, S/F, 36" Height	\$ 2,595	Adder - 48" Width	48.75	31	36	
	Vista	VT-SC-V4-36-DS	Study Carrel, Version 4, D/F, 36" Height	\$ 4,530	Starter - 36" Width	38.5	60.5	36	655
	Vista	VT-SC-V4-36-DA	Study Carrel, Version 4, D/F, 36" Height	\$ 3,615	Adder - 36" Width	36.75	60.5	36	
	Vista	VT-SC-V4-48-DS	Study Carrel, Version 4, D/F, 36" Height	\$ 4,615	Starter - 48" Width	50.5	60.5	36	710
	Vista	VT-SC-V4-48-DA	Study Carrel, Version 4, D/F, 36" Height	\$ 3,700	Adder - 48" Width	48.75	60.5	36	
	Vista	VT-MC-V4-36-SS	Modular Carrel, Version 4, S/F, 48" Height	\$ 3,480	Starter - 36" Width	38.5	31	48	340
	Vista	VT-MC-V4-36-SA	Modular Carrel, Version 4, S/F, 48" Height	\$ 2,795	Adder - 36" Width	36.75	31	48	
	Vista	VT-MC-V4-48-SS	Modular Carrel, Version 4, S/F, 48" Height	\$ 3,540	Starter - 48" Width	50.5	31	48	340
	Vista	VT-MC-V4-48-SA	Modular Carrel, Version 4, S/F, 48" Height	\$ 2,855	Adder - 48" Width	48.75	31	48	
	Vista	VT-MC-V4-36-DS	Modular Carrel, Version 4, D/F, 48" Height	\$ 5,045	Starter - 36" Width	38.5	60.5	48	655











Image	Collection	Catalog Number	Item Description	List Price	Colour / Type	Width (Inches)	Depth (Inches)	Height (Inches)	Weight (Lbs.)
	Vista	VT-MC-V4-36-DA	Modular Carrel, Version 4, D/F, 48\"	\$ 3,950	Adder - 36\"	36.75	60.5	48	
	Vista	VT-MC-V4-48-DS	Modular Carrel, Version 4, D/F, 48\"	\$ 5,135	Starter - 48\"	50.5	60.5	48	710
	Vista	VT-MC-V4-48-DA	Modular Carrel, Version 4, D/F, 48\"	\$ 4,040	Adder - 48\"	48.75	60.5	48	
	Vista	VT-SC-V5-36-SS	Study Carrel, Version 5, S/F, 36\"	\$ 3,110	Starter - 36\"	38.5	31	36	340
	Vista	VT-SC-V5-36-SA	Study Carrel, Version 5, S/F, 36\"	\$ 2,530	Adder - 36\"	36.75	31	36	
	Vista	VT-SC-V5-48-SS	Study Carrel, Version 5, S/F, 36\"	\$ 3,175	Starter - 48\"	50.5	31	36	340
	Vista	VT-SC-V5-48-SA	Study Carrel, Version 5, S/F, 36\"	\$ 2,595	Adder - 48\"	48.75	31	36	
	Vista	VT-SC-V5-36-DS	Study Carrel, Version 5, D/F, 36\"	\$ 4,525	Starter - 36\"	38.5	60.5	36	655
	Vista	VT-SC-V5-36-DA	Study Carrel, Version 5, D/F, 36\"	\$ 3,615	Adder - 36\"	36.75	60.5	36	
	Vista	VT-SC-V5-48-DS	Study Carrel, Version 5, D/F, 36\"	\$ 4,610	Starter - 48\"	50.5	60.5	36	710
	Vista	VT-SC-V5-48-DA	Study Carrel, Version 5, D/F, 36\"	\$ 3,700	Adder - 48\"	48.75	60.5	36	







Image	Collection	Catalog Number	Item Description	List Price	Colour / Type	Width (Inches)	Depth (Inches)	Height (Inches)	Weight (Lbs.)	
	Vista	VT-MC-V5-36-SS	Modular Carrel, Version 5, S/F, 48" Height	\$ 3,465	Starter - 36" Width	38.5	31	48	340	
	Vista	VT-MC-V5-36-SA	Modular Carrel, Version 5, S/F, 48" Height	\$ 2,780	Adder - 36" Width	36.75	31	48		
	Vista	VT-MC-V5-48-SS	Modular Carrel, Version 5, S/F, 48" Height	\$ 3,525	Starter - 48" Width	50.5	31	48	340	
	Vista	VT-MC-V5-48-SA	Modular Carrel, Version 5, S/F, 48" Height	\$ 2,840	Adder - 48" Width	48.75	31	48		
	Vista	VT-MC-V5-36-DS	Modular Carrel, Version 5, D/F, 48" Height	\$ 5,020	Starter - 36" Width	38.5	60.5	48	655	
	Vista	VT-MC-V5-36-DA	Modular Carrel, Version 5, D/F, 48" Height	\$ 3,925	Adder - 36" Width	36.75	60.5	48		
		Vista	VT-MC-V5-48-DS	Modular Carrel, Version 5, D/F, 48" Height	\$ 5,110	Starter - 48" Width	50.5	60.5	48	710
		Vista	VT-MC-V5-48-DA	Modular Carrel, Version 5, D/F, 48" Height	\$ 4,015	Adder - 48" Width	48.75	60.5	48	
	Vista	VT-PAC-1-V1-29	PAC Table, Version 1, 1 Person	\$ 4,045	Sitting Hgt.	37.5	36	37	130	
	Vista	VT-PAC-1-V1-32	PAC Table, Version 1, 1 Person	\$ 4,090	Wheelchair Hgt.	37.5	36	40	130	
	Vista	VT-PAC-1-V1-39	PAC Table, Version 1, 1 Person	\$ 4,200	Standing Hgt.	37.5	36	47	135	
	Vista	VT-PAC-2-V1-29	PAC Table, Version 1, 2 Person	\$ 4,780	Sitting Hgt.	73.5	36	37	200	
	Vista	VT-PAC-2-V1-32	PAC Table, Version 1, 2 Person	\$ 4,830	Wheelchair Hgt.	73.5	36	40	200	







Image	Collection	Catalog Number	Item Description	List Price	Colour / Type	Width (Inches)	Depth (Inches)	Height (Inches)	Weight (Lbs.)
	Vista	VT-PAC-2-V1-39	PAC Table, Version 1, 2 Person	\$ 4,935	Standing Hgt.	73.5	36	47	205
	Vista	VT-PAC-3-V1-29	PAC Table, Version 1, 3 Person	\$ 5,270	Sitting Hgt.	91.5	36	37	250
	Vista	VT-PAC-3-V1-32	PAC Table, Version 1, 3 Person	\$ 5,315	Wheelchair Hgt.	91.5	36	40	250
	Vista	VT-PAC-3-V1-39	PAC Table, Version 1, 3 Person	\$ 5,425	Standing Hgt.	91.5	36	47	260
	Vista	VT-PAC-1-V2-29	PAC Table, Version 2, 1 Person	\$ 3,960	Sitting Hgt.	37.5	36	37	130
	Vista	VT-PAC-1-V2-32	PAC Table, Version 2, 1 Person	\$ 3,970	Wheelchair Hgt.	37.5	36	40	130
	Vista	VT-PAC-1-V2-39	PAC Table, Version 2, 1 Person	\$ 4,000	Standing Hgt.	37.5	36	47	135
	Vista	VT-PAC-2-V2-29	PAC Table, Version 2, 2 Person	\$ 4,695	Sitting Hgt.	73.5	36	37	200
	Vista	VT-PAC-2-V2-32	PAC Table, Version 2, 2 Person	\$ 4,705	Wheelchair Hgt.	73.5	36	40	200
	Vista	VT-PAC-2-V2-39	PAC Table, Version 2, 2 Person	\$ 4,735	Standing Hgt.	73.5	36	47	205
	Vista	VT-PAC-3-V2-29	PAC Table, Version 2, 3 Person	\$ 5,185	Sitting Hgt.	91.5	36	37	250
	Vista	VT-PAC-3-V2-32	PAC Table, Version 2, 3 Person	\$ 5,195	Wheelchair Hgt.	91.5	36	40	250
	Vista	VT-PAC-3-V2-39	PAC Table, Version 2, 3 Person	\$ 5,225	Standing Hgt.	91.5	36	47	260
	Vista	VT-PAC-1-V3-29	PAC Table, Version 3, 1 Person	\$ 3,835	Sitting Hgt.	37.5	36	37	130
	Vista	VT-PAC-1-V3-32	PAC Table, Version 3, 1 Person	\$ 3,845	Wheelchair Hgt.	37.5	36	40	130
	Vista	VT-PAC-1-V3-39	PAC Table, Version 3, 1 Person	\$ 3,855	Standing Hgt.	37.5	36	47	135
	Vista	VT-PAC-2-V3-29	PAC Table, Version 3, 2 Person	\$ 4,570	Sitting Hgt.	73.5	36	37	200







Image	Collection	Catalog Number	Item Description	List Price	Colour / Type	Width (Inches)	Depth (Inches)	Height (Inches)	Weight (Lbs.)
	Vista	VT-PAC-2-V3-32	PAC Table, Version 3, 2 Person	\$ 4,580	Wheelchair Hgt.	73.5	36	40	200
	Vista	VT-PAC-2-V3-39	PAC Table, Version 3, 2 Person	\$ 4,590	Standing Hgt.	73.5	36	47	205
	Vista	VT-PAC-3-V3-29	PAC Table, Version 3, 3 Person	\$ 5,060	Sitting Hgt.	91.5	36	37	250
	Vista	VT-PAC-3-V3-32	PAC Table, Version 3, 3 Person	\$ 5,070	Wheelchair Hgt.	91.5	36	40	250
	Vista	VT-PAC-3-V3-39	PAC Table, Version 3, 3 Person	\$ 5,080	Standing Hgt.	91.5	36	47	260
	Vista	VT-PAC-1-V4-29	PAC Table, Version 4, 1 Person	\$ 3,915	Sitting Hgt.	37.5	36	37	130
	Vista	VT-PAC-1-V4-32	PAC Table, Version 4, 1 Person	\$ 3,925	Wheelchair Hgt.	37.5	36	40	130
	Vista	VT-PAC-1-V4-39	PAC Table, Version 4, 1 Person	\$ 3,935	Standing Hgt.	37.5	36	47	135
	Vista	VT-PAC-2-V4-29	PAC Table, Version 4, 2 Person	\$ 4,650	Sitting Hgt.	73.5	36	37	200
	Vista	VT-PAC-2-V4-32	PAC Table, Version 4, 2 Person	\$ 4,660	Wheelchair Hgt.	73.5	36	40	200
	Vista	VT-PAC-2-V4-39	PAC Table, Version 4, 2 Person	\$ 4,670	Standing Hgt.	73.5	36	47	205
	Vista	VT-PAC-3-V4-29	PAC Table, Version 4, 3 Person	\$ 5,140	Sitting Hgt.	91.5	36	37	250
	Vista	VT-PAC-3-V4-32	PAC Table, Version 4, 3 Person	\$ 5,150	Wheelchair Hgt.	91.5	36	40	250
	Vista	VT-PAC-3-V4-39	PAC Table, Version 4, 3 Person	\$ 5,160	Standing Hgt.	91.5	36	47	260
	Vista	VT-PAC-1-V5-29	PAC Table, Version 5, 1 Person	\$ 3,975	Sitting Hgt.	37.5	36	37	130
	Vista	VT-PAC-1-V5-32	PAC Table, Version 5, 1 Person	\$ 3,990	Wheelchair Hgt.	37.5	36	40	130
	Vista	VT-PAC-1-V5-39	PAC Table, Version 5, 1 Person	\$ 4,030	Standing Hgt.	37.5	36	47	135





Image	Collection	Catalog Number	Item Description	List Price	Colour / Type	Width (Inches)	Depth (Inches)	Height (Inches)	Weight (Lbs.)
	Vista	VT-PAC-2-V5-29	PAC Table, Version 5, 2 Person	\$ 4,710	Sitting Hgt.	73.5	36	37	200
	Vista	VT-PAC-2-V5-32	PAC Table, Version 5, 2 Person	\$ 4,725	Wheelchair Hgt.	73.5	36	40	200
	Vista	VT-PAC-2-V5-39	PAC Table, Version 5, 2 Person	\$ 4,765	Standing Hgt.	73.5	36	47	205
	Vista	VT-PAC-3-V5-29	PAC Table, Version 5, 3 Person	\$ 5,200	Sitting Hgt.	91.5	36	37	250
	Vista	VT-PAC-3-V5-32	PAC Table, Version 5, 3 Person	\$ 5,215	Wheelchair Hgt.	91.5	36	40	250
	Vista	VT-PAC-3-V5-39	PAC Table, Version 5, 3 Person	\$ 5,255	Standing Hgt.	91.5	36	47	260
	Vista	VT-R42	Round Table	\$ 2,135		42	42	29	90
	Vista	VT-R48	Round Table	\$ 2,250		48	48	29	100
	Vista	VT-4242	Square Table	\$ 2,525		42	42	29	170
	Vista	VT-4848	Square Table	\$ 2,710		48	48	29	230
	Vista	VT-V1-6036	Rectangle Table, Version 1	\$ 3,385		60	36	29	200
	Vista	VT-V1-6048	Rectangle Table, Version 1	\$ 3,655		60	48	29	270
	Vista	VT-V1-7236	Rectangle Table, Version 1	\$ 3,555		72	36	29	230
	Vista	VT-V1-7248	Rectangle Table, Version 1	\$ 3,840		72	48	29	290
	Vista	VT-V1-8436	Rectangle Table, Version 1	\$ 3,750		84	36	29	290
	Vista	VT-V1-8448	Rectangle Table, Version 1	\$ 4,055		84	48	29	290



Image	Collection	Catalog Number	Item Description	List Price	Colour / Type	Width (Inches)	Depth (Inches)	Height (Inches)	Weight (Lbs.)
	Vista	VT-V1-9636	Rectangle Table, Version 1	\$ 3,920		96	36	29	290
	Vista	VT-V1-9648	Rectangle Table, Version 1	\$ 4,240		96	48	29	340
	Vista	VT-V1R-6036	Rectangle Table, Version 1 with Rail	\$ 3,535		60	36	29	200
	Vista	VT-V1R-6048	Rectangle Table, Version 1 with Rail	\$ 3,805		60	48	29	270
	Vista	VT-V1R-7236	Rectangle Table, Version 1 with Rail	\$ 3,745		72	36	29	230
	Vista	VT-V1R-7248	Rectangle Table, Version 1 with Rail	\$ 4,025		72	48	29	290
	Vista	VT-V1R-8436	Rectangle Table, Version 1 with Rail	\$ 3,970		84	36	29	290
	Vista	VT-V1R-8448	Rectangle Table, Version 1 with Rail	\$ 4,275		84	48	29	290
	Vista	VT-V1R-9636	Rectangle Table, Version 1 with Rail	\$ 4,180		96	36	29	290
	Vista	VT-V1R-9648	Rectangle Table, Version 1 with Rail	\$ 4,495		96	48	29	340
		Vista	VT-V2-6036	Rectangle Table, Version 2	\$ 3,295		60	36	29
Vista		VT-V2-6048	Rectangle Table, Version 2	\$ 3,600		60	48	29	270
Vista		VT-V2-7236	Rectangle Table, Version 2	\$ 3,470		72	36	29	230
Vista		VT-V2-7248	Rectangle Table, Version 2	\$ 3,790		72	48	29	290
Vista		VT-V2-8436	Rectangle Table, Version 2	\$ 3,660		84	36	29	290
Vista		VT-V2-8448	Rectangle Table, Version 2	\$ 4,000		84	48	29	290
Vista		VT-V2-9636	Rectangle Table, Version 2	\$ 3,835		96	36	29	290
Vista		VT-V2-9648	Rectangle Table, Version 2	\$ 4,190		96	48	29	340
Vista		VT-V2R-6036	Rectangle Table, Version 2 with Rail	\$ 3,445		60	36	29	200
Vista	VT-V2R-6048	Rectangle Table, Version 2 with Rail	\$ 3,755		60	48	29	270	



Image	Collection	Catalog Number	Item Description	List Price	Colour / Type	Width (Inches)	Depth (Inches)	Height (Inches)	Weight (Lbs.)
	Vista	VT-V2R-7236	Rectangle Table, Version 2 with Rail	\$ 3,655		72	36	29	230
	Vista	VT-V2R-7248	Rectangle Table, Version 2 with Rail	\$ 3,975		72	48	29	290
	Vista	VT-V2R-8436	Rectangle Table, Version 2 with Rail	\$ 3,745		84	36	29	290
	Vista	VT-V2R-8448	Rectangle Table, Version 2 with Rail	\$ 4,220		84	48	29	290
	Vista	VT-V2R-9636	Rectangle Table, Version 2 with Rail	\$ 4,090		96	36	29	290
	Vista	VT-V2R-9648	Rectangle Table, Version 2 with Rail	\$ 4,445		96	48	29	340
	Vista	VT-V3-6036	Rectangle Table, Version 3	\$ 3,170		60	36	29	200
	Vista	VT-V3-6048	Rectangle Table, Version 3	\$ 3,445		60	48	29	270
	Vista	VT-V3-7236	Rectangle Table, Version 3	\$ 3,345		72	36	29	230
	Vista	VT-V3-7248	Rectangle Table, Version 3	\$ 3,630		72	48	29	290
	Vista	VT-V3-8436	Rectangle Table, Version 3	\$ 3,535		84	36	29	290
	Vista	VT-V3-8448	Rectangle Table, Version 3	\$ 3,840		84	48	29	290
	Vista	VT-V3-9636	Rectangle Table, Version 3	\$ 3,710		96	36	29	290
	Vista	VT-V3-9648	Rectangle Table, Version 3	\$ 4,030		96	48	29	340
	Vista	VT-V3R-6036	Rectangle Table, Version 3 with Rail	\$ 3,320		60	36	29	200
	Vista	VT-V3R-6048	Rectangle Table, Version 3 with Rail	\$ 3,595		60	48	29	270
	Vista	VT-V3R-7236	Rectangle Table, Version 3 with Rail	\$ 3,530		72	36	29	230
	Vista	VT-V3R-7248	Rectangle Table, Version 3 with Rail	\$ 3,815		72	48	29	290
	Vista	VT-V3R-8436	Rectangle Table, Version 3 with Rail	\$ 3,760		84	36	29	290
	Vista	VT-V3R-8448	Rectangle Table, Version 3 with Rail	\$ 4,060		84	48	29	290
	Vista	VT-V3R-9636	Rectangle Table, Version 3 with Rail	\$ 3,965		96	36	29	290
	Vista	VT-V3R-9648	Rectangle Table, Version 3 with Rail	\$ 4,285		96	48	29	340



Image	Collection	Catalog Number	Item Description	List Price	Colour / Type	Width (Inches)	Depth (Inches)	Height (Inches)	Weight (Lbs.)
	Vista	VT-V4-6036	Rectangle Table, Version 4	\$ 3,250		60	36	29	200
	Vista	VT-V4-6048	Rectangle Table, Version 4	\$ 3,560		60	48	29	270
	Vista	VT-V4-7236	Rectangle Table, Version 4	\$ 3,425		72	36	29	230
	Vista	VT-V4-7248	Rectangle Table, Version 4	\$ 3,745		72	48	29	290
	Vista	VT-V4-8436	Rectangle Table, Version 4	\$ 3,615		84	36	29	290
	Vista	VT-V4-8448	Rectangle Table, Version 4	\$ 3,955		84	48	29	290
	Vista	VT-V4-9636	Rectangle Table, Version 4	\$ 3,790		96	36	29	290
	Vista	VT-V4-9648	Rectangle Table, Version 4	\$ 4,145		96	48	29	340
	Vista	VT-V4R-6036	Rectangle Table, Version 4 with Rail	\$ 3,400		60	36	29	200
	Vista	VT-V4R-6048	Rectangle Table, Version 4 with Rail	\$ 3,710		60	48	29	270
	Vista	VT-V4R-7236	Rectangle Table, Version 4 with Rail	\$ 3,610		72	36	29	230
	Vista	VT-V4R-7248	Rectangle Table, Version 4 with Rail	\$ 3,930		72	48	29	290
	Vista	VT-V4R-8436	Rectangle Table, Version 4 with Rail	\$ 3,840		84	36	29	290
	Vista	VT-V4R-8448	Rectangle Table, Version 4 with Rail	\$ 4,180		84	48	29	290
	Vista	VT-V4R-9636	Rectangle Table, Version 4 with Rail	\$ 4,045		96	36	29	290
	Vista	VT-V4R-9648	Rectangle Table, Version 4 with Rail	\$ 4,400		96	48	29	340
	Vista	VT-V5-6036	Rectangle Table, Version 5	\$ 3,310		60	36	29	200
	Vista	VT-V5-6048	Rectangle Table, Version 5	\$ 3,615		60	48	29	270
	Vista	VT-V5-7236	Rectangle Table, Version 5	\$ 3,485		72	36	29	230
	Vista	VT-V5-7248	Rectangle Table, Version 5	\$ 3,805		72	48	29	290
	Vista	VT-V5-8436	Rectangle Table, Version 5	\$ 3,675		84	36	29	290

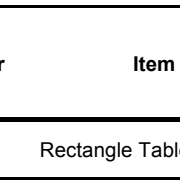











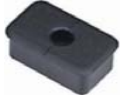

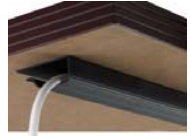















Image	Collection	Catalog Number	Item Description	List Price	Colour / Type	Width (Inches)	Depth (Inches)	Height (Inches)	Weight (Lbs.)
	Vista	VT-V5-8448	Rectangle Table, Version 5	\$ 4,015		84	48	29	290
	Vista	VT-V5-9636	Rectangle Table, Version 5	\$ 3,850		96	36	29	290
	Vista	VT-V5-9648	Rectangle Table, Version 5	\$ 4,205		96	48	29	340
	Vista	VT-V5R-6036	Rectangle Table, Version 5 with Rail	\$ 3,460		60	36	29	200
	Vista	VT-V5R-6048	Rectangle Table, Version 5 with Rail	\$ 3,770		60	48	29	270
	Vista	VT-V5R-7236	Rectangle Table, Version 5 with Rail	\$ 3,670		72	36	29	230
	Vista	VT-V5R-7248	Rectangle Table, Version 5 with Rail	\$ 3,990		72	48	29	290
	Vista	VT-V5R-8436	Rectangle Table, Version 5 with Rail	\$ 3,895		84	36	29	290
	Vista	VT-V5R-8448	Rectangle Table, Version 5 with Rail	\$ 4,235		84	48	29	290
	Vista	VT-V5R-9636	Rectangle Table, Version 5 with Rail	\$ 4,105		96	36	29	290
	Vista	VT-V5R-9648	Rectangle Table, Version 5 with Rail	\$ 4,460		96	48	29	340



Image	Collection	Catalog Number	Item Description	List Price	Width (Inches)	Depth (Inches)	Height (Inches)	Weight (Lbs.)
	Desk Accessories	CD-M20	Mobile Pedestal: Open Shelf	\$ 1,475	20.5	20.5	26.5	65
	Desk Accessories	CD-M30	Mobile Pedestal: Cupboard Unit	\$ 1,825	20.5	20.5	26.5	70
	Desk Accessories	CD-M40	Mobile Pedestal: Drawer Unit	\$ 1,995	20.5	20.5	26.5	75
	Desk Accessories	CD-M50	Mobile File Unit	\$ 2,035	20.5	20.5	26.5	75



	Desk Accessories	CD-250-BF	Hanging Pedestal: 1 Box, 1 File	\$ 1,260	18	21.625	20.5	50
	Desk Accessories	CD-250-B3	Hanging Pedestal: 3 Box	\$ 1,410	18	21.625	20.5	50
	Desk Accessories	CD-250-F2	Hanging Pedestal: 2 File	\$ 1,485	18	21.625	25.5	50
	Desk Accessories	CD-250-2BF	Hanging Pedestal: 2 Box, 1 File	\$ 1,520	18	21.625	25.5	50
	Desk Accessories	CD-250-CPU	Hanging Pedestal: CPU Storage	\$ 1,100	11.75	23.5	25	70





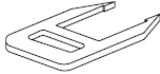

	Desk Accessories	CD-250-P	Pencil Drawer	\$	505	18	18.75	3.375	10
	Desk Accessories	CD-250-PK	Pull-out Keyboard	\$	510	23.5	17	3.75	15
	Desk Accessories	CD-250-AK	Articulating Keyboard	\$	510	23.75	11	0.75	15
	Desk Accessories	CD-200-32	Swing Gate 32"	\$	1,275	34	1	22	10
	Desk Accessories	CD-200-39	Swing Gate 39"	\$	1,275	34	1	29	10
	Electrical	PW-G2D	Grommet: 2" Diameter	\$	85	2	2	0.75	0.1
	Electrical	PW-G3D	Grommet: 3" Diameter	\$	85	3	3	0.75	0.1
	Electrical	PW-G2X3	Grommet: Square 2" x 3"	\$	85	3	2	0.75	0.1
	Electrical	PW-AGS-3D	Grommet: 3" Diameter Access Sleeve	\$	85	3	3	0.75	0.1
	Electrical	PW-OWMT-30	Wire Management: Open Channel	\$	85	30	1.25	2.5	1
	Electrical	PW-BMJC-29	Back Mount J-Channel 29" Long	\$	105	29	4.5	3	4
	Electrical	PW-BMJC-32	Back Mount J-Channel 32" Long	\$	110	32	4.5	3	4

	Electrical	PW-BMJC-35	Back Mount J-Channel 35" Long	\$	115	35	4.5	3	4
	Electrical	PW-BMJC-41	Back Mount J-Channel 41" Long	\$	120	41	4.5	3	4
	Electrical	PW-BMJC-47	Back Mount J-Channel 47" Long	\$	125	47	4.5	3	4
	Electrical	PW-TMJC-29	Top Mount J-Channel 29" Long	\$	105	29	4.5	3	4
	Electrical	PW-TMJC-32	Top Mount J-Channel 32" Long	\$	110	32	4.5	3	4
	Electrical	PW-TMJC-35	Top Mount J-Channel 35" Long	\$	115	35	4.5	3	4
	Electrical	PW-TMJC-41	Top Mount J-Channel 41" Long	\$	120	41	4.5	3	4
	Electrical	PW-TMJC-47	Top Mount J-Channel 47" Long	\$	125	47	4.5	3	4
	Electrical	PW-VWM	Wire Management: Vertical	\$	125	2	2		2
	Electrical	PW-WLWM	Wire Management: Wood Leg	\$	320	2.375	2.375		5
	Electrical	PW-SLWM	Wire Management: Steel Leg	\$	310	2.5	2.5		5
	Electrical	PW-SPC-4	Power Bar: 4 Outlet	\$	125	2	1	12	1
	Electrical	PW-SPC-6	Power Bar: 6 Outlet	\$	125	2	1	15	1

	Electrical	PW-PCD3-13	Corner Power Column: 3 Outlet, 13" tall	\$	380	4.25	1.875	13	3
	Electrical	PW-PCD3-16	Corner Power Column: 3 Outlet, 16" tall	\$	380	4.25	1.875	16	3
	Electrical	PW-PCD4-20	Corner Power Column: 4 Outlet, 20"	\$	430	4.25	1.875	20	4
	Electrical	P-PDS-B	Power Sphere - 2 outlets, 2 data - Black	\$	215	3.375	3.375	1.75	5
	Electrical - WRONG PICTURE	PW-100F	Flip Up Power Station: Cordset	\$	535	9	5.375		5
	Electrical - WRONG PICTURE	PW-100H	Flip Up Power Station: Hard Wired	\$	535	9	5.375		5
	Electrical	PW-100J	Junior Flip Up Power Station: Cordset	\$	440	5.75	5.375		
	Electrical - WRONG PIC	P20-WM-29	PA-20 System: Wire Manager 29" Long	\$	230	29	4	5.5	5
	Electrical	P20-WM-32	PA-20 System: Wire Manager 32" Long	\$	240	32	4	5.5	5

	Electrical	P20-WM-35	PA-20 System: Wire Manager 35" Long	\$	250	35	4	5.5	5
	Electrical	P20-WM-41	PA-20 System: Wire Manager 41" Long	\$	265	41	4	5.5	5
	Electrical	P20-WM-47	PA-20 System: Wire Manager 47" Long	\$	275	47	4	5.5	5
	Electrical	P20-1TWM-19-83	PA-20 System: 1 Triplex Wire Manager 19" Long, 8 Wire - 3 Circuit	\$	480	19	4	5.5	8
	Electrical	P20-1TWM-29-83	PA-20 System: 1 Triplex Wire Manager 29" Long, 8 Wire - 3 Circuit	\$	505	29	4	5.5	8
	Electrical	P20-1TWM-32-83	PA-20 System: 1 Triplex Wire Manager 32" Long, 8 Wire - 3 Circuit	\$	515	32	4	5.5	8
	Electrical	P20-1TWM-35-83	PA-20 System: 1 Triplex Wire Manager 35" Long, 8 Wire - 3 Circuit	\$	605	35	4	5.5	8
	Electrical	P20-1TWM-41-83	PA-20 System: 1 Triplex Wire Manager 41" Long, 8 Wire - 3 Circuit	\$	615	41	4	5.5	8
	Electrical	P20-1TWM-47-83	PA-20 System: 1 Triplex Wire Manager 47" Long, 8 Wire - 3 Circuit	\$	620	47	4	5.5	8
	Electrical	P20-1TWM-19-84	PA-20 System: 1 Triplex Wire Manager 19" Long, 8 Wire - 4 Circuit	\$	480	19	4	5.5	8
	Electrical	P20-1TWM-29-84	PA-20 System: 1 Triplex Wire Manager 29" Long, 8 Wire - 4 Circuit	\$	505	29	4	5.5	8
	Electrical	P20-1TWM-32-84	PA-20 System: 1 Triplex Wire Manager 32" Long, 8 Wire - 4 Circuit	\$	515	32	4	5.5	8
	Electrical	P20-1TWM-35-84	PA-20 System: 1 Triplex Wire Manager 35" Long, 8 Wire - 4 Circuit	\$	605	35	4	5.5	8
	Electrical	P20-1TWM-41-84	PA-20 System: 1 Triplex Wire Manager 41" Long, 8 Wire - 4 Circuit	\$	615	41	4	5.5	8
	Electrical	P20-1TWM-47-84	PA-20 System: 1 Triplex Wire Manager 47" Long, 8 Wire - 4 Circuit	\$	620	47	4	5.5	8
	Electrical	P20-2TWM-29-83	PA-20 System: 2 Triplex Wire Manager 29" Long, 8 Wire - 3 Circuit	\$	605	29	4	5.5	8
	Electrical	P20-2TWM-32-83	PA-20 System: 2 Triplex Wire Manager 32" Long, 8 Wire - 3 Circuit	\$	615	32	4	5.5	8
	Electrical	P20-2TWM-35-83	PA-20 System: 2 Triplex Wire Manager 35" Long, 8 Wire - 3 Circuit	\$	705	35	4	5.5	8
	Electrical	P20-2TWM-41-83	PA-20 System: 2 Triplex Wire Manager 41" Long, 8 Wire - 3 Circuit	\$	715	41	4	5.5	8
	Electrical	P20-2TWM-47-83	PA-20 System: 2 Triplex Wire Manager 47" Long, 8 Wire - 3 Circuit	\$	720	47	4	5.5	8
	Electrical	P20-2TWM-29-84	PA-20 System: 2 Triplex Wire Manager 29" Long, 8 Wire - 4 Circuit	\$	605	29	4	5.5	8
	Electrical	P20-2TWM-32-84	PA-20 System: 2 Triplex Wire Manager 32" Long, 8 Wire - 4 Circuit	\$	615	32	4	5.5	8
	Electrical	P20-2TWM-35-84	PA-20 System: 2 Triplex Wire Manager 35" Long, 8 Wire - 4 Circuit	\$	705	35	4	5.5	8

	Electrical	P20-2TWM-41-84	PA-20 System: 2 Triplex Wire Manager 41" Long, 8 Wire - 4 Circuit	\$	715	41	4	5.5	8
	Electrical	P20-2TWM-47-84	PA-20 System: 2 Triplex Wire Manager 47" Long, 8 Wire - 4 Circuit	\$	720	47	4	5.5	8
	Electrical	P20-PCD3-13-83	PA-20 System: Power Data Column, 3 Outlet, 13" tall, 8 Wire - 3 Circuit	\$	520	4.25	1.875	13	2.5
	Electrical	P20-PCD3-16-83	PA-20 System: Power Data Column, 3 Outlet, 16" tall, 8 Wire - 3 Circuit	\$	520	4.25	1.875	16	2.5
	Electrical	P20-PCD3-13-84	PA-20 System: Power Data Column, 3 Outlet, 13" tall, 8 Wire - 4 Circuit	\$	520	4.25	1.875	13	2.5
	Electrical	P20-PCD3-16-84	PA-20 System: Power Data Column, 3 Outlet, 16" tall, 8 Wire - 4 Circuit	\$	520	4.25	1.875	16	2.5
	Electrical	P20-SCPF-18-83	PA-20 System: Single Circuit Power Feed, 18" tall, 8 Wire - 3 Circuit	\$	405	2	1	18	8
	Electrical	P20-SCPF-26-83	PA-20 System: Single Circuit Power Feed, 26" tall, 8 Wire - 3 Circuit	\$	435	2	1	26	8
	Electrical	P20-SCPF-36-83	PA-20 System: Single Circuit Power Feed, 36" tall, 8 Wire - 3 Circuit	\$	490	2	1	36	8
	Electrical	P20-SCPF-18-84	PA-20 System: Single Circuit Power Feed, 18" tall, 8 Wire - 4 Circuit	\$	405	2	1	18	8
	Electrical	P20-SCPF-26-84	PA-20 System: Single Circuit Power Feed, 26" tall, 8 Wire - 4 Circuit	\$	435	2	1	26	8
	Electrical	P20-SCPF-36-84	PA-20 System: Single Circuit Power Feed, 36" tall, 8 Wire - 4 Circuit	\$	490	2	1	36	8
	Electrical	P20-MCPF-18-83	PA-20 System: Multi Circuit Power Feed, 18" tall, 8 Wire - 3 Circuit	\$	470	2	1	18	8
	Electrical	P20-MCPF-26-83	PA-20 System: Multi Circuit Power Feed, 26" tall, 8 Wire - 3 Circuit	\$	490	2	1	26	8
	Electrical	P20-MCPF-36-83	PA-20 System: Multi Circuit Power Feed, 36" tall, 8 Wire - 3 Circuit	\$	505	2	1	36	8
	Electrical	P20-MCPF-18-84	PA-20 System: Multi Circuit Power Feed, 18" tall, 8 Wire - 4 Circuit	\$	470	2	1	18	8
	Electrical	P20-MCPF-26-84	PA-20 System: Multi Circuit Power Feed, 26" tall, 8 Wire - 4 Circuit	\$	490	2	1	26	8
	Electrical	P20-MCPF-36-84	PA-20 System: Multi Circuit Power Feed, 36" tall, 8 Wire - 4 Circuit	\$	505	2	1	36	8
	Electrical	PW-2000	Authorized Simplex Remover	\$	15				

	Electrical	PW-IC-24-83	PA-20 System: Interconnecting Cable, 24" Long, 8 Wire - 3 Circuit	\$	75	24			1
	Electrical	PW-IC-36-83	PA-20 System: Interconnecting Cable, 36" Long, 8 Wire - 3 Circuit	\$	80	36			1
	Electrical	PW-IC-48-83	PA-20 System: Interconnecting Cable, 48" Long, 8 Wire - 3 Circuit	\$	85	48			1
	Electrical	PW-IC-60-83	PA-20 System: Interconnecting Cable, 60" Long, 8 Wire - 3 Circuit	\$	90	60			1
	Electrical	PW-IC-24-84	PA-20 System: Interconnecting Cable, 24" Long, 8 Wire - 4 Circuit	\$	75	24			1
	Electrical	PW-IC-36-84	PA-20 System: Interconnecting Cable, 36" Long, 8 Wire - 4 Circuit	\$	80	36			1
	Electrical	PW-IC-48-84	PA-20 System: Interconnecting Cable, 48" Long, 8 Wire - 4 Circuit	\$	85	48			1
	Electrical	PW-IC-60-84	PA-20 System: Interconnecting Cable, 60" Long, 8 Wire - 4 Circuit	\$	90	60			1
	Electrical	PW-RJ11	Telecom Plate: RJ11 Phone	\$	40				
	Electrical	PW-CAT6	Telecom Plate: RJ45 Data	\$	55				
	Electrical	PW-CAT6-2	Telecom Plate: Two RJ45 Data	\$	75				
	General / Misc. Furniture	GN-120-S	Revolving Dictionary Stand, Single Faced	\$	565	21	12	9	14
	General / Misc. Furniture	GN-120-D	Revolving Dictionary Stand, Double Faced	\$	820	21	17	9	16



General / Misc.
Furniture

GN-122

Lectern For Table Top

\$ 570 20.25 12 13 15



General / Misc.
Furniture

GN-122-A

Lectern: Open Base, Adjustable Up To 48" Height

\$ 1,480 23.5 15 38 75



General / Misc.
Furniture

GN-162

Lectern: Closed Base, Height Adjustable Shelf

\$ 2,035 23 16.5 45 75



General / Misc.
Furniture

GN-904

Teaching Board, Mobile

\$ 4,525 49.25 24 72.5 125



General / Misc.
Furniture

GN-905-5

Map Case: 5 Drawer Large

\$ 3,285 51 41 22.25 310



General / Misc.
Furniture

GN-905-10

Map Case: 10 Drawer Large

\$ 5,935 51 41 39.375 560



General / Misc.
Furniture

GN-154

Map Case

\$ 4,890 39.5 27 36.375 215



General / Misc.
Furniture

GN-155

Display Case, Glass Shelves and Panels

\$ 5,725 36 24 80 280

General / Misc.
Furniture

GN-155-XL

Fluorescent light

\$ 720



General / Misc.
Furniture

GN-506

Information Kiosk, Cork Panels

\$ 3,445 24 24 73 150



General / Misc.
Furniture

GN-506-V

Information Kiosk, Velcro Option cost per panel

\$ 175



General / Misc.
Furniture

GN-506-WB

Information Kiosk, White Board Option cost per panel

\$ 265



General / Misc.
Furniture

GN-395-A

AV Browser: Adult

\$ 3,240 39.75 18.5 54 250



General / Misc.
Furniture

GN-395-C

AV Browser: Children's

\$ 2,945 39.75 18.5 33.75 150



General / Misc.
Furniture

GN-502-4

Display Tower: 4 Tier (2 Towers Required for Self Supporting)

\$ 1,010 24.75 10.5 48.625 40









General / Misc.
Furniture

GN-502-5

Display Tower: 5 Tier (2 Towers Required for Self Supporting)

\$ 1,025 24.75 10.5 62.625 43

	General / Misc. Furniture	GN-502-6	Display Tower: 6 Tier (2 Towers Required for Self Supporting)	\$ 1,045	24.75	10.5	62.625	43
	General / Misc. Furniture	GN-502-SW	Display Tower: Slot Wall (2 Towers Required for Self Supporting)	\$ 1,415	24.75	1.75	62.625	90
	General / Misc. Furniture	GN-502-SW-PL	Display Tower: Slot Wall, Plastic Laminate (2 Towers Required for Self Supporting)	\$ 1,055	24.75	1.75	62.625	90
	General / Misc. Furniture	GN-502-SWS-8	Slat Wall Display: 8" Shelf	\$ 65	8	3.5	5.5	1
	General / Misc. Furniture	GN-502-SWS-16	Slat Wall Display: 16" Shelf	\$ 95	16	3.5	5.5	1.5
	General / Misc. Furniture	GN-502-SWS-32	Slat Wall Display: 32" Shelf	\$ 150	32	3.5	5.5	2.5
	General / Misc. Furniture	GN-502-HB	Display Tower: Hanging Bag	\$ 675	24.75	1.75	62.625	30
	General / Misc. Furniture	GN-502-TF	Display Tower: Tackable Fabric	\$ 1,055	24.75	1.75	62.625	40
	General / Misc. Furniture	GN-502-SH	Sign Holder	\$ 155	20	0.75	4.5	1



General / Misc.
Furniture

GN-505-5

Pedestal Display Tower: 5-Tier

\$ 4,555 26 26 66.75 220



General / Misc.
Furniture

GN-505-6

Pedestal Display Tower: 6-Tier

\$ 4,660 26 26 66.75 220



Book Trucks

BT-100-39

Book Return Truck

\$ 2,695 25.25 23.5 31.75 90

Book Trucks

BT-100-32

Book Return Truck Small

\$ 2,695 25.25 23.5 26.75 80



Book Trucks

BT-101

Depressible Book Truck with Lid

\$ 3,095 25.25 23.5 36.75 120



Book Trucks

BT-102

Wood Truck with 3 Flat Shelves

\$ 955 32.25 15.5 37 65



Book Trucks

BT-103

Wood Display Truck, Double Sided

\$ 1,070 32.25 15.5 37 65



Book Trucks

BT-104

Wood Display Truck, Single Sided

\$ 1,125 32.25 15.5 37 65



Book Trucks

BT-102X

Oversize Truck with 3 Flat Shelves

\$ 985 38 17 39 70









Book Trucks







BT-103X





Oversize Display Truck, Double Faced





\$ 1,115 38 17 39 70

	Book Trucks	BT-104X	Oversize Display Truck, Single Faced	\$ 1,145	38	17	39	70
	Book Trucks	BT-312	Steel Truck with 3 Flat Shelves	\$ 665	32	16.5	43	65
	Book Trucks	BT-312-A	Steel Display Truck, Double Sided	\$ 720	32	16.5	43	65
	Book Trucks	BT-316-A	Steel Display Book Buddy Truck, Double Sided	\$ 965	32	16.5	43	65
	Book Trucks	BT-313	Steel Display Book Buddy Truck, Double Sided	\$ 790	32	16.5	43	65
	Book Trucks	BT-277	Steel Display Truck, Single Sided	\$ 665	32	16.5	43	65

	Book Trucks	BT-316	Steel Book Buddy Truck with 3 Flat Shelves	\$	965	32	16.5	43	65
	Book Trucks	BT-RB	Rubber Bumpers (4)	\$	225			24	4
	Book Trucks	BT-ST1	Steer 1 Book Truck	\$	1,115	32	16.5	43	
	Book Trucks	BT-ST2	Steer 2 Book Truck	\$	1,520	43	16.5	43	

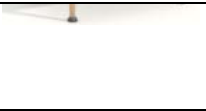
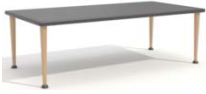
	Book Trucks	BT-ST3-O	Steer 3 Book Truck	\$ 1,685	43	16.5	43
	Book Trucks	BT-ST4-O	Steer 4 Book Truck	\$ 1,125	42	16.5	42
	Book Trucks	BT-ST5-O	Steer 5 Book Truck	\$ 1,985	19	21	44
	Book Trucks	BT-LC	Locking Casters (2)	\$ 45			1.5
	Book Trucks	BT-5C	5" Diameter Casters (4)	\$ 45	5		1.6
	Balloon	BO-R36	Round Table	\$ 1,030	36	36	27
	Balloon	BO-R42	Round Table	\$ 1,075	42	42	27
	Balloon	BO-R48	Round Table	\$ 1,130	48	48	27
	Balloon	BO-R60	Round Table	\$ -	60	60	27

	Balloon	BO-3636	Square Tables	\$ 1,035	36	36	27
	Balloon	BO-4242	Square Tables	\$ 1,085	42	42	27
	Balloon	BO-4848	Square Tables	\$ 1,135	48	48	27
	Balloon	BO-3036	Rectangle Tables, 30" Width	\$ 1,015	30	36	27
	Balloon	BO-3060	Rectangle Tables, 30" Width	\$ 1,165	30	60	27
	Balloon	BO-3072	Rectangle Tables, 30" Width	\$ 1,200	30	72	27
	Balloon	BO-3090	Rectangle Tables, 30" Width	\$ 1,255	30	90	27
	Balloon	BO-3660	Rectangle Tables, 36" Width	\$ 1,200	36	60	27
	Balloon	BO-3672	Rectangle Tables, 36" Width	\$ 1,245	36	72	27
	Balloon	BO-3690	Rectangle Tables, 36" Width	\$ 1,310	36	90	27
	Balloon	BO-4860	Rectangle Tables, 48" Width	\$ 1,270	48	60	27
	Balloon	BO-4872	Rectangle Tables, 48" Width	\$ 1,325	48	72	27
	Balloon	BO-4890	Rectangle Tables, 48" Width	\$ 1,415	48	90	27
	Safari	SR-R36	Round Tables	\$ 1,425	36	36	27
	Safari	SR-R42	Round Tables	\$ 1,495	42	42	27
	Safari	SR-R48	Round Tables	\$ 1,570	48	48	27
	Safari	SR-3636	Square Tables	\$ 1,325	36	36	27
	Safari	SR-4242	Square Tables	\$ 1,405	42	42	27

	Safari	SR-4848	Square Tables	\$ 1,485	48	48	27	
	Safari	SR-6030	Rectangle Tables, 60" Width	\$ 1,500	60	30	27	
	Safari	SR-6036	Rectangle Tables, 60" Width	\$ 1,550	60	36	27	
	Safari	SR-6042	Rectangle Tables, 60" Width	\$ 1,600	60	42	27	
	Safari	SR-6048	Rectangle Tables, 60" Width	\$ 1,650	60	48	27	
	Safari	SR-7230	Rectangle Tables, 72" Width	\$ 1,565	72	30	27	
	Safari	SR-7236	Rectangle Tables, 72" Width	\$ 1,625	72	36	27	
	Safari	SR-7242	Rectangle Tables, 72" Width	\$ 1,680	72	42	27	
	Safari	SR-7248	Rectangle Tables, 72" Width	\$ 1,810	72	48	27	
	Safari	SR-8430	Rectangle Tables, 84" Width	\$ 1,635	84	30	27	
	Safari	SR-8436	Rectangle Tables, 84" Width	\$ 1,700	84	36	27	
	Safari	SR-8442	Rectangle Tables, 84" Width	\$ 1,760	84	42	27	
	Safari	SR-8448	Rectangle Tables, 84" Width	\$ 1,895	84	48	27	
	Safari	SR-9630	Rectangle Tables, 96" Width	\$ 1,700	96	30	27	
	Safari	SR-9636	Rectangle Tables, 96" Width	\$ 1,775	96	36	27	
	Safari	SR-9642	Rectangle Tables, 96" Width	\$ 1,985	96	42	27	
Safari	SR-9648	Rectangle Tables, 96" Width	\$ 2,055	96	48	27		
	Displays and Media	DP-S-109	Single Picture Book Box	\$ 590	35.25	10	15.5	30
	Displays and Media	DP-S-110	Double Picture Book Box	\$ 870	35.25	10	30.25	60
	Displays and Media	DP-S-909	Mobile Picture Book Box, Trapazoidal	\$ 2,235	58	21	35	125



Displays and Media

DP-S-111

Base for Picture Book Box

\$ 395 35 10 6 10



Displays and Media

DP-S-105

Mobile Picture Book Browser with Storage

\$ 2,115 27 29 29 125



Displays and Media

DP-S-106

Single Sided Picture Book Browser with Storage

\$ 2,025 35.25 13.75 32.5 60



Displays and Media

DP-S-108

Single Sided Picture Book Browser

\$ 1,690 43.5 16 33 130



Displays and Media

DP-S-108D

Double Sided Picture Book Browser

\$ 2,040 43.5 22 33 220



Displays and
Media

DP-S-132

Kinder Box

\$ 1,275

28

28

27

75









Image	Collection	Catalog Number	Item Description	List Price	Colour / Type	Width (Inches)	Length (Inches)	Depth (Inches)	Height (Inches)
	Econoline	EO-R36-AC-S	Round Table, Boxy Frame, 36"	\$ 1,030	Acrylic Edge, Square Leg	36		36	29
	Econoline	EO-R36-BN-S	Round Table, Boxy Frame, 36"	\$ 1,130	Bullnose Edge, Square Leg	36		36	29
	Econoline	EO-R42-AC-S	Round Table, Boxy Frame, 42"	\$ 1,090	Acrylic Edge, Square Leg	42		42	29
	Econoline	EO-R42-BN-S	Round Table, Boxy Frame, 42"	\$ 1,275	Bullnose Edge, Square Leg	42		42	29
	Econoline	EO-R48-AC-S	Round Table, Boxy Frame, 48"	\$ 1,160	Acrylic Edge, Square Leg	48		48	29
	Econoline	EO-R48-BN-S	Round Table, Boxy Frame, 48"	\$ 1,370	Bullnose Edge, Square Leg	48		48	29
	Econoline	EO-3636-AC-S	Square Table, Boxy Frame, 36"	\$ 1,050	Acrylic Edge, Square Leg	36		36	29
	Econoline	EO-3636-BN-S	Square Table, Boxy Frame, 36"	\$ 1,245	Bullnose Edge, Square Leg	36		36	29
	Econoline	EO-4242-AC-S	Square Table, Boxy Frame, 42"	\$ 1,115	Acrylic Edge, Square Leg	42		42	29
	Econoline	EO-4242-BN-S	Square Table, Boxy Frame, 42"	\$ 1,345	Bullnose Edge, Square Leg	42		42	29
	Econoline	EO-3624-AC-S	Rectangle Table, Boxy Frame, 24" Depth	\$ 960	Acrylic Edge, Square Leg	36		24	29
	Econoline	EO-3624-BN-S	Rectangle Table, Boxy Frame, 24" Depth	\$ 1,120	Bullnose Edge, Square Leg	36		24	29
	Econoline	EO-4824-AC-S	Rectangle Table, Boxy Frame, 24" Depth	\$ 1,010	Acrylic Edge, Square Leg	48		24	29
	Econoline	EO-4824-BN-S	Rectangle Table, Boxy Frame, 24" Depth	\$ 1,200	Bullnose Edge, Square Leg	48		24	29
	Econoline	EO-6024-AC-S	Rectangle Table, Boxy Frame, 24" Depth	\$ 1,060	Acrylic Edge, Square Leg	60		24	29
	Econoline	EO-6024-BN-S	Rectangle Table, Boxy Frame, 24" Depth	\$ 1,285	Bullnose Edge, Square Leg	60		24	29
	Econoline	EO-7224-AC-S	Rectangle Table, Boxy Frame, 24" Depth	\$ 1,105	Acrylic Edge, Square Leg	72		24	29
	Econoline	EO-7224-BN-S	Rectangle Table, Boxy Frame, 24" Depth	\$ 1,365	Bullnose Edge, Square Leg	72		24	29
	Econoline	EO-4830-AC-S	Rectangle Table, Boxy Frame, 30" Depth	\$ 1,050	Acrylic Edge, Square Leg	48		30	29
	Econoline	EO-4830-BN-S	Rectangle Table, Boxy Frame, 30" Depth	\$ 1,260	Bullnose Edge, Square Leg	48		30	29
	Econoline	EO-6030-AC-S	Rectangle Table, Boxy Frame, 30" Depth	\$ 1,105	Acrylic Edge, Square Leg	60		30	29
	Econoline	EO-6030-BN-S	Rectangle Table, Boxy Frame, 30" Depth	\$ 1,350	Bullnose Edge, Square Leg	60		30	29
	Econoline	EO-7230-AC-S	Rectangle Table, Boxy Frame, 30" Depth	\$ 1,160	Acrylic Edge, Square Leg	72		30	29
	Econoline	EO-7230-BN-S	Rectangle Table, Boxy Frame, 30" Depth	\$ 1,440	Bullnose Edge, Square Leg	72		30	29
	Econoline	EO-6036-AC-S	Rectangle Table, Boxy Frame, 36" Depth	\$ 1,145	Acrylic Edge, Square Leg	60		36	29
	Econoline	EO-6036-BN-S	Rectangle Table, Boxy Frame, 36" Depth	\$ 1,405	Bullnose Edge, Square Leg	60		36	29
	Econoline	EO-7236-AC-S	Rectangle Table, Boxy Frame, 36" Depth	\$ 1,205	Acrylic Edge, Square Leg	72		36	29
	Econoline	EO-7236-BN-S	Rectangle Table, Boxy Frame, 36" Depth	\$ 1,500	Bullnose Edge, Square Leg	72		36	29
	Econoline	EO-7242-AC-S	Rectangle Table, Boxy Frame, 42" Depth	\$ 1,260	Acrylic Edge, Square Leg	72		42	29
	Econoline	EO-7242-BN-S	Rectangle Table, Boxy Frame, 42" Depth	\$ 1,575	Bullnose Edge, Square Leg	72		42	29
	Econoline	EO-8442-AC-S	Rectangle Table, Boxy Frame, 42" Depth	\$ 1,325	Acrylic Edge, Square Leg	84		42	29
	Econoline	EO-8442-BN-S	Rectangle Table, Boxy Frame, 42" Depth	\$ 1,675	Bullnose Edge, Square Leg	84		42	29
	Econoline	EO-9642-AC-S	Rectangle Table, Boxy Frame, 42" Depth	\$ 1,395	Acrylic Edge, Square Leg	96		42	29
	Econoline	EO-9642-BN-S	Rectangle Table, Boxy Frame, 42" Depth	\$ 1,780	Bullnose Edge, Square Leg	96		42	29
	Econoline	EO-TZ-4824-AC-S	Trapezoidal Table, Boxy Frame, 24" Depth	\$ 1,030	Acrylic Edge, Square Leg	48		24	29
	Econoline	EO-TZ-4824-BN-S	Trapezoidal Table, Boxy Frame, 24" Depth	\$ 1,190	Bullnose Edge, Square Leg	48		24	29
	Econoline	EO-TZ-6030-AC-S	Trapezoidal Table, Boxy Frame, 30" Depth	\$ 1,125	Acrylic Edge, Square Leg	60		30	29
	Econoline	EO-TZ-6030-BN-S	Trapezoidal Table, Boxy Frame, 30" Depth	\$ 1,330	Bullnose Edge, Square Leg	60		30	29
	Econoline	EO-R36-AC-R	Round Table, 36"	\$ 925	Acrylic Edge, Round Leg	36		36	29
	Econoline	EO-R36-BN-R	Round Table, 36"	\$ 1,080	Bullnose Edge, Round Leg	36		36	29
	Econoline	EO-R42-AC-R	Round Table, 42"	\$ 965	Acrylic Edge, Round Leg	42		42	29
	Econoline	EO-R42-BN-R	Round Table, 42"	\$ 1,150	Bullnose Edge, Round Leg	42		42	29
	Econoline	EO-R48-AC-R	Round Table, 48"	\$ 1,015	Acrylic Edge, Round Leg	48		48	29





Image	Collection	Catalog Number	Item Description	List Price	Colour / Type	Width (Inches)	Length (Inches)	Depth (Inches)	Height (Inches)
	Econoline	EO-R48-BN-R	Round Table, 48"	\$ 1,230	Bullnose Edge, Round Leg	48		48	29
	Econoline	EO-3636-AC-R	Square Table, 36"	\$ 930	Acrylic Edge, Round Leg	36		36	29
	Econoline	EO-3636-BN-R	Square Table, 36"	\$ 1,125	Bullnose Edge, Round Leg	36		36	29
	Econoline	EO-4242-AC-R	Square Table, 42"	\$ 975	Acrylic Edge, Round Leg	42		42	29
	Econoline	EO-4242-BN-R	Square Table, 42"	\$ 1,200	Bullnose Edge, Round Leg	42		42	29
	Econoline	EO-3624-AC-R	Rectangle Table, 24" Depth	\$ 905	Acrylic Edge, Round Leg	36		24	29
	Econoline	EO-3624-BN-R	Rectangle Table, 24" Depth	\$ 1,065	Bullnose Edge, Round Leg	36		24	29
	Econoline	EO-4824-AC-R	Rectangle Table, 24" Depth	\$ 930	Acrylic Edge, Round Leg	48		24	29
	Econoline	EO-4824-BN-R	Rectangle Table, 24" Depth	\$ 1,125	Bullnose Edge, Round Leg	48		24	29
	Econoline	EO-6024-AC-R	Rectangle Table, 24" Depth	\$ 960	Acrylic Edge, Round Leg	60		24	29
	Econoline	EO-6024-BN-R	Rectangle Table, 24" Depth	\$ 1,185	Bullnose Edge, Round Leg	60		24	29
	Econoline	EO-7224-AC-R	Rectangle Table, 24" Depth	\$ 990	Acrylic Edge, Round Leg	72		24	29
	Econoline	EO-7224-BN-R	Rectangle Table, 24" Depth	\$ 1,250	Bullnose Edge, Round Leg	72		24	29
	Econoline	EO-4830-AC-R	Rectangle Table, 30" Depth	\$ 960	Acrylic Edge, Round Leg	48		30	29
	Econoline	EO-4830-BN-R	Rectangle Table, 30" Depth	\$ 1,170	Bullnose Edge, Round Leg	48		30	29
	Econoline	EO-6030-AC-R	Rectangle Table, 30" Depth	\$ 1,070	Acrylic Edge, Round Leg	60		30	29
	Econoline	EO-6030-BN-R	Rectangle Table, 30" Depth	\$ 1,315	Bullnose Edge, Round Leg	60		30	29
	Econoline	EO-7230-AC-R	Rectangle Table, 30" Depth	\$ 1,105	Acrylic Edge, Round Leg	72		30	29
	Econoline	EO-7230-BN-R	Rectangle Table, 30" Depth	\$ 1,380	Bullnose Edge, Round Leg	72		30	29
	Econoline	EO-6036-AC-R	Rectangle Table, 36" Depth	\$ 1,100	Acrylic Edge, Round Leg	60		36	29
	Econoline	EO-6036-BN-R	Rectangle Table, 36" Depth	\$ 1,365	Bullnose Edge, Round Leg	60		36	29
	Econoline	EO-7236-AC-R	Rectangle Table, 36" Depth	\$ 1,145	Acrylic Edge, Round Leg	72		36	29
	Econoline	EO-7236-BN-R	Rectangle Table, 36" Depth	\$ 1,440	Bullnose Edge, Round Leg	72		36	29
	Econoline	EO-7242-AC-R	Rectangle Table, 42" Depth	\$ 1,180	Acrylic Edge, Round Leg	72		42	29
	Econoline	EO-7242-BN-R	Rectangle Table, 42" Depth	\$ 1,495	Bullnose Edge, Round Leg	72		42	29
	Econoline	EO-8442-AC-R	Rectangle Table, 42" Depth	\$ 1,230	Acrylic Edge, Round Leg	84		42	29
	Econoline	EO-8442-BN-R	Rectangle Table, 42" Depth	\$ 1,580	Bullnose Edge, Round Leg	84		42	29
	Econoline	EO-9642-AC-R	Rectangle Table, 42" Depth	\$ 1,275	Acrylic Edge, Round Leg	96		42	29
	Econoline	EO-9642-BN-R	Rectangle Table, 42" Depth	\$ 1,660	Bullnose Edge, Round Leg	96		42	29
	Econoline	EO-TZ-4824-AC-R	Trapezoidal Table, 24" Depth	\$ 910	Acrylic Edge, Round Leg	48		24	29
	Econoline	EO-TZ-4824-BN-R	Trapezoidal Table, 24" Depth	\$ 1,070	Bullnose Edge, Round Leg	48		24	29
	Econoline	EO-TZ-6030-AC-R	Trapezoidal Table, 30" Depth	\$ 1,045	Acrylic Edge, Round Leg	60		30	29
	Econoline	EO-TZ-6030-BN-R	Trapezoidal Table, 30" Depth	\$ 1,250	Bullnose Edge, Round Leg	60		30	29
	Econoline	EO-RT-7242-AC-R	Race Track Table	\$ 1,320	Acrylic Edge, Round Leg	72		42	29
	Econoline	EO-RT-7242-BN-R	Race Track Table	\$ 1,590	Bullnose Edge, Round Leg	72		42	29
	Econoline	EO-RT-8442-AC-R	Race Track Table	\$ 1,365	Acrylic Edge, Round Leg	84		42	29
	Econoline	EO-RT-8442-BN-R	Race Track Table	\$ 1,670	Bullnose Edge, Round Leg	84		42	29
	Econoline	EO-RT-9642-AC-R	Race Track Table	\$ 1,415	Acrylic Edge, Round Leg	96		42	29
	Econoline	EO-RT-9642-BN-R	Race Track Table	\$ 1,750	Bullnose Edge, Round Leg	96		42	29





Image	Collection	Catalog Number	Item Description	List Price	Colour / Type	Width (Inches)	Length (Inches)	Depth (Inches)	Height (Inches)
	Econoline	EO-6024-AC-T	Rectangle Table, 24" Depth	\$ 965	Acrylic Edge, Tubular T-Leg	60		24	29
	Econoline	EO-6024-BN-T	Rectangle Table, 24" Depth	\$ 1,190	Bullnose Edge, Tubular T-Leg	60		24	29
	Econoline	EO-7224-AC-T	Rectangle Table, 24" Depth	\$ 995	Acrylic Edge, Tubular T-Leg	72		24	29
	Econoline	EO-7224-BN-T	Rectangle Table, 24" Depth	\$ 1,250	Bullnose Edge, Tubular T-Leg	72		24	29
	Econoline	EO-6030-AC-T	Rectangle Table, 30" Depth	\$ 1,010	Acrylic Edge, Tubular T-Leg	60		30	29
	Econoline	EO-6030-BN-T	Rectangle Table, 30" Depth	\$ 1,245	Bullnose Edge, Tubular T-Leg	60		30	29
	Econoline	EO-7230-AC-T	Rectangle Table, 30" Depth	\$ 1,045	Acrylic Edge, Tubular T-Leg	72		30	29
	Econoline	EO-7230-BN-T	Rectangle Table, 30" Depth	\$ 1,315	Bullnose Edge, Tubular T-Leg	72		30	29
	Econoline	EO-6036-AC-T	Rectangle Table, 36" Depth	\$ 1,050	Acrylic Edge, Tubular T-Leg	60		36	29
	Econoline	EO-6036-BN-T	Rectangle Table, 36" Depth	\$ 1,305	Bullnose Edge, Tubular T-Leg	60		36	29
	Econoline	EO-7236-AC-T	Rectangle Table, 36" Depth	\$ 1,095	Acrylic Edge, Tubular T-Leg	72		36	29
	Econoline	EO-7236-BN-T	Rectangle Table, 36" Depth	\$ 1,380	Bullnose Edge, Tubular T-Leg	72		36	29
	Econoline	EO-7242-AC-T	Rectangle Table, 42" Depth	\$ 1,475	Acrylic Edge, Tubular T-Leg	72		42	29
	Econoline	EO-7242-BN-T	Rectangle Table, 42" Depth	\$ 1,835	Bullnose Edge, Tubular T-Leg	72		42	29
	Econoline	EO-8442-AC-T	Rectangle Table, 42" Depth	\$ 1,585	Acrylic Edge, Tubular T-Leg	84		42	29
	Econoline	EO-8442-BN-T	Rectangle Table, 42" Depth	\$ 1,920	Bullnose Edge, Tubular T-Leg	84		42	29
Econoline	EO-9642-AC-T	Rectangle Table, 42" Depth	\$ 1,630	Acrylic Edge, Tubular T-Leg	96		42	29	
Econoline	EO-9642-BN-T	Rectangle Table, 42" Depth	\$ 2,000	Bullnose Edge, Tubular T-Leg	96		42	29	
	Econoline	EO-RT-7242-AC-T	Race Track Table	\$ 1,745	Acrylic Edge, Tubular T-Leg	72		42	29
	Econoline	EO-RT-7242-BN-T	Race Track Table	\$ 2,000	Bullnose Edge, Tubular T-Leg	72		42	29
	Econoline	EO-RT-8442-AC-T	Race Track Table	\$ 1,795	Acrylic Edge, Tubular T-Leg	84		42	29
	Econoline	EO-RT-8442-BN-T	Race Track Table	\$ 2,080	Bullnose Edge, Tubular T-Leg	84		42	29
	Econoline	EO-RT-9642-AC-T	Race Track Table	\$ 1,840	Acrylic Edge, Tubular T-Leg	96		42	29
	Econoline	EO-RT-9642-BN-T	Race Track Table	\$ 2,160	Bullnose Edge, Tubular T-Leg	96		42	29
	Econoline	EO-R36-AC-P	Round Table, 36"	\$ 1,035	Acrylic Edge, Pedestal Leg	36		36	29
	Econoline	EO-R36-BN-P	Round Table, 36"	\$ 1,190	Bullnose Edge, Pedestal Leg	36		36	29
	Econoline	EO-R42-AC-P	Round Table, 42"	\$ 1,345	Acrylic Edge, Pedestal Leg	42		42	29
	Econoline	EO-R42-BN-P	Round Table, 42"	\$ 1,520	Bullnose Edge, Pedestal Leg	42		42	29
	Econoline	EO-R48-AC-P	Round Table, 48"	\$ 1,540	Acrylic Edge, Pedestal Leg	48		48	29
	Econoline	EO-R48-BN-P	Round Table, 48"	\$ 1,740	Bullnose Edge, Pedestal Leg	48		48	29
	Econoline	EO-3636-AC-P	Square Table, 36"	\$ 1,035	Acrylic Edge, Pedestal Leg	36		36	29
	Econoline	EO-3636-BN-P	Square Table, 36"	\$ 1,225	Bullnose Edge, Pedestal Leg	36		36	29
	Econoline	EO-4242-AC-P	Square Table, 42"	\$ 1,340	Acrylic Edge, Pedestal Leg	42		42	29
	Econoline	EO-4242-BN-P	Square Table, 42"	\$ 1,565	Bullnose Edge, Pedestal Leg	42		42	29
	Econoline	EO-3024-AC-WS	Rectangle Workstation, 24" Depth	\$ 960	Acrylic Edge	30		24	29







Image	Collection	Catalog Number	Item Description	List Price	Colour / Type	Width (Inches)	Length (Inches)	Depth (Inches)	Height (Inches)
	Econoline	EO-4824-AC-WS	Rectangle Workstation, 24" Depth	\$ 1,055	Acrylic Edge	48		24	29
	Econoline	EO-6024-AC-WS	Rectangle Workstation, 24" Depth	\$ 1,095	Acrylic Edge	60		24	29
	Econoline	EO-7224-AC-WS	Rectangle Workstation, 24" Depth	\$ 1,265	Acrylic Edge	72		24	29
	Econoline	EO-4830-AC-WS	Rectangle Workstation, 30" Depth	\$ 1,080	Acrylic Edge	48		30	29
	Econoline	EO-6030-AC-WS	Rectangle Workstation, 30" Depth	\$ 1,130	Acrylic Edge	60		30	29
	Econoline	EO-7230-AC-WS	Rectangle Workstation, 30" Depth	\$ 1,305	Acrylic Edge	72		30	29
	Econoline	EO-C4224-AC-WS	Corner Workstation	\$ 1,075	Acrylic Edge	42		24	29
	Econoline	EO-C4830-AC-WS	Corner Workstation	\$ 1,130	Acrylic Edge	48		30	29
	Econoline	EO-2424-AC-WS	Square Workstation	\$ 940	Acrylic Edge	24		24	29
	Econoline	EO-3030-AC-WS	Square Workstation	\$ 980	Acrylic Edge	30		30	29
	Fluid	FL-R36-KN-2SQ	Round Table	\$ 1,765	Knife Edge, 2" Square Leg	36		36	29
	Fluid	FL-R42-KN-2SQ	Round Table	\$ 1,960	Knife Edge, 2" Square Leg	42		42	29
	Fluid	FL-R48-KN-2SQ	Round Table	\$ 2,080	Knife Edge, 2" Square Leg	48		48	29
	Fluid	FL-R54-KN-2SQ	Round Table	\$ 2,475	Knife Edge, 2" Square Leg	54		54	29
	Fluid	FL-R60-KN-2SQ	Round Table	\$ 2,775	Knife Edge, 2" Square Leg	60		60	29
	Fluid	FL-3636-KN-2SQ	Square Table	\$ 1,765	Knife Edge, 2" Square Leg	36		36	29
	Fluid	FL-4242-KN-2SQ	Square Table	\$ 1,875	Knife Edge, 2" Square Leg	42		42	29
	Fluid	FL-4848-KN-2SQ	Square Table	\$ 1,995	Knife Edge, 2" Square Leg	48		48	29
	Fluid	FL-3036-KN-2SQ	Rectangle Table, 30" Depth	\$ 1,690	Knife Edge, 2" Square Leg	36		30	29
	Fluid	FL-3042-KN-2SQ	Rectangle Table, 30" Depth	\$ 1,760	Knife Edge, 2" Square Leg	42		30	29
	Fluid	FL-3048-KN-2SQ	Rectangle Table, 30" Depth	\$ 1,815	Knife Edge, 2" Square Leg	48		30	29
	Fluid	FL-3054-KN-2SQ	Rectangle Table, 30" Depth	\$ 1,865	Knife Edge, 2" Square Leg	54		30	29
	Fluid	FL-3060-KN-2SQ	Rectangle Table, 30" Depth	\$ 1,915	Knife Edge, 2" Square Leg	60		30	29
	Fluid	FL-3072-KN-2SQ	Rectangle Table, 30" Depth	\$ 2,015	Knife Edge, 2" Square Leg	72		30	29
	Fluid	FL-3642-KN-2SQ	Rectangle Table, 36" Depth	\$ 1,820	Knife Edge, 2" Square Leg	42		36	29
	Fluid	FL-3648-KN-2SQ	Rectangle Table, 36" Depth	\$ 1,885	Knife Edge, 2" Square Leg	48		36	29
	Fluid	FL-3654-KN-2SQ	Rectangle Table, 36" Depth	\$ 1,925	Knife Edge, 2" Square Leg	54		36	29





Image	Collection	Catalog Number	Item Description	List Price	Colour / Type	Width (Inches)	Length (Inches)	Depth (Inches)	Height (Inches)
	Fluid	FL-3660-KN-2SQ	Rectangle Table, 36" Depth	\$ 1,980	Knife Edge, 2" Square Leg	60		36	29
	Fluid	FL-3672-KN-2SQ	Rectangle Table, 36" Depth	\$ 2,085	Knife Edge, 2" Square Leg	72		36	29
	Fluid	FL-CS-3630-KN-2SQ	Workstation, 1 Person	\$ 2,405	Knife Edge, 2" Square Leg	36		30	29
	Fluid	FL-CS-D-7230-KN-2SQ	Workstation, 2 Person (1 Person Side by Side)	\$ 3,095	Knife Edge, 2" Square Leg	72		30	29
	Fluid	FL-CS-2D-3660-KN-2SQ	Workstation, 2 Person (1 Person Back to Back)	\$ 2,895	Knife Edge, 2" Square Leg	36		60	29
	Fluid	FL-CS-4D-7260-KN-2SQ	Workstation, 4 Person (2 Person Back to Back)	\$ 3,835	Knife Edge, 2" Square Leg	72		60	29
	Lagoon	LG-T-AC-STC	Table Pod	\$ 800	Acrylic Edge, Str. Caster Leg	47.5		24	29
	Lagoon	LG-T-SQ-STC	Table Pod	\$ 830	Square Edge, Str. Caster Leg	47.5		24	29
	Lagoon	LG-L-AC-STC	Large Table Pod	\$ 970	Acrylic Edge, Str. Caster Leg	34.25		34.25	29
	Lagoon	LG-L-SQ-STC	Large Table Pod	\$ 1,010	Square Edge, Str. Caster Leg	34.25		34.25	29
	Lagoon	LG-CP4-AC	Center Pod: Quad	\$ 1,355	Acrylic Edge	28.5		28.5	27.50
	Lagoon	LG-CP4-SQ	Center Pod: Quad	\$ 1,385	Square Edge	28.5		28.5	27.50
	Lagoon	LG-CP3-AC	Center Pod: Triple	\$ 1,320	Acrylic Edge	28.5		28.5	27.50
	Lagoon	LG-CP3-SQ	Center Pod: Triple	\$ 1,345	Square Edge	28.5		28.5	27.50
	Lagoon	LG-CA-AC-STC	Configuration A: Triple	\$ 3,720	Acrylic Edge, Str. Caster Leg	116.5		116.5	29"
	Lagoon	LG-CA-SQ-STC	Configuration A: Triple	\$ 3,835	Square Edge, Str. Caster Leg	116.5		116.5	29"





Image	Collection	Catalog Number	Item Description	List Price	Colour / Type	Width (Inches)	Length (Inches)	Depth (Inches)	Height (Inches)	
	Lagoon	LG-CB-AC-STC	Configuration B: Quad	\$ 4,555	Acrylic Edge, Str. Caster Leg	89"		89"	29"	
	Lagoon	LG-CB-SQ-STC	Configuration B: Quad	\$ 4,705	Square Edge, Str. Caster Leg	89"		89"	29"	
	Lagoon	LG-CC-AC-STC	Configuration C: Triple, One Large, 2 Small Pods	\$ 3,890	Acrylic Edge, Str. Caster Leg	116.5		96.5	29"	
	Lagoon	LG-CC-SQ-STC	Configuration C: Triple, One Large, 2 Small Pods	\$ 4,015	Square Edge, Str. Caster Leg	116.5		96.5	29"	
	Lagoon	LG-CD-AC-STC	Configuration D: Quad, 2 Large, 2 Small Pods	\$ 4,895	Acrylic Edge, Str. Caster Leg	116.5		100"	29"	
	Lagoon	LG-CD-SQ-STC	Configuration D: Quad, 2 Large, 2 Small Pods	\$ 5,065	Square Edge, Str. Caster Leg	116.5		100"	29"	
	Leaf	LF-4832-PN-DS	Table, 48" Width	\$ 1,740	Pencil Edge, Dia./Stem Leg	48		32.5	29	
	Leaf	LF-4832-PN-SS	Table, 48" Width	\$ 1,740	Pencil Edge, Sq./Stem Leg	48		32.5	29	
	Leaf	LF-4832-BN-DS	Table, 48" Width	\$ 1,670	Bullnose Edge, Dia./Stem Leg	48		32.5	29	
	Leaf	LF-4832-BN-SS	Table, 48" Width	\$ 1,670	Bullnose Edge, Sq./Stem Leg	48		32.5	29	
	Leaf	LF-4832-SQ-DS	Table, 48" Width	\$ 1,525	Square Edge, Dia./Stem Leg	48		32.5	29	
	Leaf	LF-4832-SQ-SS	Table, 48" Width	\$ 1,525	Square Edge, Sq./Stem Leg	48		32.5	29	
	Leaf	LF-6044-PN-DS	Table, 60" Width	\$ 1,890	Pencil Edge, Dia./Stem Leg	60		44.5	29	
	Leaf	LF-6044-PN-SS	Table, 60" Width	\$ 1,890	Pencil Edge, Sq./Stem Leg	60		44.5	29	
	Leaf	LF-6044-BN-DS	Table, 60" Width	\$ 1,815	Bullnose Edge, Dia./Stem Leg	60		44.5	29	
	Leaf	LF-6044-BN-SS	Table, 60" Width	\$ 1,815	Bullnose Edge, Sq./Stem Leg	60		44.5	29	
	Leaf	LF-6044-SQ-DS	Table, 60" Width	\$ 1,670	Square Edge, Dia./Stem Leg	60		44.5	29	
	Leaf	LF-6044-SQ-SS	Table, 60" Width	\$ 1,670	Square Edge, Sq./Stem Leg	60		44.5	29	
		Leaf	LF-CA48-PN-DS	Configuration A, 48": Semi-Circle, 3 Person	\$ 5,220	Pencil Edge, Dia./Stem Leg	96		48	29
		Leaf	LF-CA48-PN-SS	Configuration A, 48": Semi-Circle, 3 Person	\$ 5,220	Pencil Edge, Sq./Stem Leg	96		48	29
Leaf		LF-CA48-BN-DS	Configuration A, 48": Semi-Circle, 3 Person	\$ 5,010	Bullnose Edge, Dia./Stem Leg	96		48	29	
Leaf		LF-CA48-BN-SS	Configuration A, 48": Semi-Circle, 3 Person	\$ 5,010	Bullnose Edge, Sq./Stem Leg	96		48	29	
Leaf		LF-CA48-SQ-DS	Configuration A, 48": Semi-Circle, 3 Person	\$ 4,575	Square Edge, Dia./Stem Leg	96		48	29	
Leaf		LF-CA48-SQ-SS	Configuration A, 48": Semi-Circle, 3 Person	\$ 4,575	Square Edge, Sq./Stem Leg	96		48	29	
Leaf		LF-CA60-PN-DS	Configuration A, 60": Semi-Circle, 3 Person	\$ 5,670	Pencil Edge, Dia./Stem Leg	120		60	29	
Leaf		LF-CA60-PN-SS	Configuration A, 60": Semi-Circle, 3 Person	\$ 5,670	Pencil Edge, Sq./Stem Leg	120		60	29	
Leaf		LF-CA60-BN-DS	Configuration A, 60": Semi-Circle, 3 Person	\$ 5,445	Bullnose Edge, Dia./Stem Leg	120		60	29	
Leaf		LF-CA60-BN-SS	Configuration A, 60": Semi-Circle, 3 Person	\$ 5,445	Bullnose Edge, Sq./Stem Leg	120		60	29	
Leaf		LF-CA60-SQ-DS	Configuration A, 60": Semi-Circle, 3 Person	\$ 5,010	Square Edge, Dia./Stem Leg	120		60	29	
Leaf		LF-CA60-SQ-SS	Configuration A, 60": Semi-Circle, 3 Person	\$ 5,010	Square Edge, Sq./Stem Leg	120		60	29	
Leaf		LF-CB48-PN-DS	Configuration B, 48": Circle, 6 Person	\$ 10,440	Pencil Edge, Dia./Stem Leg	96		96	29	



Image	Collection	Catalog Number	Item Description	List Price	Colour / Type	Width (Inches)	Length (Inches)	Depth (Inches)	Height (Inches)
	Leaf	LF-CB48-PN-SS	Configuration B, 48": Circle, 6 Person	\$ 10,440	Pencil Edge, Sq./Stem Leg	96		96	29
	Leaf	LF-CB48-BN-DS	Configuration B, 48": Circle, 6 Person	\$ 10,020	Bullnose Edge, Dia./Stem Leg	96		96	29
	Leaf	LF-CB48-BN-SS	Configuration B, 48": Circle, 6 Person	\$ 10,020	Bullnose Edge, Sq./Stem Leg	96		96	29
	Leaf	LF-CB48-SQ-DS	Configuration B, 48": Circle, 6 Person	\$ 9,150	Square Edge, Dia./Stem Leg	96		96	29
	Leaf	LF-CB48-SQ-SS	Configuration B, 48": Circle, 6 Person	\$ 9,150	Square Edge, Sq./Stem Leg	96		96	29
	Leaf	LF-CB60-PN-DS	Configuration B, 60": Circle, 6 Person	\$ 11,340	Pencil Edge, Dia./Stem Leg	120		120	29
	Leaf	LF-CB60-PN-SS	Configuration B, 60": Circle, 6 Person	\$ 11,340	Pencil Edge, Sq./Stem Leg	120		120	29
	Leaf	LF-CB60-BN-DS	Configuration B, 60": Circle, 6 Person	\$ 10,890	Bullnose Edge, Dia./Stem Leg	120		120	29
	Leaf	LF-CB60-BN-SS	Configuration B, 60": Circle, 6 Person	\$ 10,890	Bullnose Edge, Sq./Stem Leg	120		120	29
	Leaf	LF-CB60-SQ-DS	Configuration B, 60": Circle, 6 Person	\$ 10,020	Square Edge, Dia./Stem Leg	120		120	29
	Leaf	LF-CB60-SQ-SS	Configuration B, 60": Circle, 6 Person	\$ 10,020	Square Edge, Sq./Stem Leg	120		120	29
		Leaf	LF-CC48-PN-DS	Configuration C, 48": 5 Person	\$ 8,700	Pencil Edge, Dia./Stem Leg	180		39
Leaf		LF-CC48-PN-SS	Configuration C, 48": 5 Person	\$ 8,700	Pencil Edge, Sq./Stem Leg	180		39	29
Leaf		LF-CC48-BN-DS	Configuration C, 48": 5 Person	\$ 8,350	Bullnose Edge, Dia./Stem Leg	180		39	29
Leaf		LF-CC48-BN-SS	Configuration C, 48": 5 Person	\$ 8,350	Bullnose Edge, Sq./Stem Leg	180		39	29
Leaf		LF-CC48-SQ-DS	Configuration C, 48": 5 Person	\$ 7,625	Square Edge, Dia./Stem Leg	180		39	29
Leaf		LF-CC48-SQ-SS	Configuration C, 48": 5 Person	\$ 7,625	Square Edge, Sq./Stem Leg	180		39	29
Leaf		LF-CC60-PN-DS	Configuration C, 60": 5 Person	\$ 9,450	Pencil Edge, Dia./Stem Leg	216		52.5	29
Leaf		LF-CC60-PN-SS	Configuration C, 60": 5 Person	\$ 9,450	Pencil Edge, Sq./Stem Leg	216		52.5	29
Leaf		LF-CC60-BN-DS	Configuration C, 60": 5 Person	\$ 9,075	Bullnose Edge, Dia./Stem Leg	216		52.5	29
Leaf		LF-CC60-BN-SS	Configuration C, 60": 5 Person	\$ 9,075	Bullnose Edge, Sq./Stem Leg	216		52.5	29
Leaf		LF-CC60-SQ-DS	Configuration C, 60": 5 Person	\$ 8,350	Square Edge, Dia./Stem Leg	216		52.5	29
Leaf		LF-CC60-SQ-SS	Configuration C, 60": 5 Person	\$ 8,350	Square Edge, Sq./Stem Leg	216		52.5	29
	Leaf	LF-CD48-PN-DS	Configuration D, 48": 6 Person	\$ 10,440	Pencil Edge, Dia./Stem Leg	197.5		63	29
	Leaf	LF-CD48-PN-SS	Configuration D, 48": 6 Person	\$ 10,440	Pencil Edge, Sq./Stem Leg	197.5		63	29
	Leaf	LF-CD48-BN-DS	Configuration D, 48": 6 Person	\$ 10,020	Bullnose Edge, Dia./Stem Leg	197.5		63	29
	Leaf	LF-CD48-BN-SS	Configuration D, 48": 6 Person	\$ 10,020	Bullnose Edge, Sq./Stem Leg	197.5		63	29
	Leaf	LF-CD48-SQ-DS	Configuration D, 48": 6 Person	\$ 9,150	Square Edge, Dia./Stem Leg	197.5		63	29
	Leaf	LF-CD48-SQ-SS	Configuration D, 48": 6 Person	\$ 9,150	Square Edge, Sq./Stem Leg	197.5		63	29
	Leaf	LF-CD60-PN-DS	Configuration D, 60": 6 Person	\$ 11,340	Pencil Edge, Dia./Stem Leg	239		81	29
	Leaf	LF-CD60-PN-SS	Configuration D, 60": 6 Person	\$ 11,340	Pencil Edge, Sq./Stem Leg	239		81	29
	Leaf	LF-CD60-BN-DS	Configuration D, 60": 6 Person	\$ 10,890	Bullnose Edge, Dia./Stem Leg	239		81	29
	Leaf	LF-CD60-BN-SS	Configuration D, 60": 6 Person	\$ 10,890	Bullnose Edge, Sq./Stem Leg	239		81	29
	Leaf	LF-CD60-SQ-DS	Configuration D, 60": 6 Person	\$ 10,020	Square Edge, Dia./Stem Leg	239		81	29
	Leaf	LF-CD60-SQ-SS	Configuration D, 60": 6 Person	\$ 10,020	Square Edge, Sq./Stem Leg	239		81	29
	Pond	PD-T4848-PN-R	Table, 48" Width	\$ 1,600	Pencil Edge, Dia./Stem Leg	48		48	29
	Pond	PD-T4848-PN-S	Table, 48" Width	\$ 1,600	Pencil Edge, Sq./Stem Leg	48		48	29
	Pond	PD-T4848-BN-R	Table, 48" Width	\$ 1,675	Bullnose Edge, Dia./Stem Leg	48		48	29



Image	Collection	Catalog Number	Item Description	List Price	Colour / Type	Width (Inches)	Length (Inches)	Depth (Inches)	Height (Inches)
	Pond	PD-T4848-BN-S	Table, 48" Width	\$ 1,675	Bullnose Edge, Sq./Stem Leg	48		48	29
	Pond	PD-T4848-SQ-R	Table, 48" Width	\$ 1,640	Square Edge, Dia./Stem Leg	48		48	29
	Pond	PD-T4848-SQ-S	Table, 48" Width	\$ 1,640	Square Edge, Sq./Stem Leg	48		48	29
	Pond	PD-T6060-PN-R	Table, 60" Width	\$ 1,740	Pencil Edge, Dia./Stem Leg	60		60	29
	Pond	PD-T6060-PN-S	Table, 60" Width	\$ 1,740	Pencil Edge, Sq./Stem Leg	60		60	29
	Pond	PD-T6060-BN-R	Table, 60" Width	\$ 1,815	Bullnose Edge, Dia./Stem Leg	60		60	29
	Pond	PD-T6060-BN-S	Table, 60" Width	\$ 1,815	Bullnose Edge, Sq./Stem Leg	60		60	29
	Pond	PD-T6060-SQ-R	Table, 60" Width	\$ 1,780	Square Edge, Dia./Stem Leg	60		60	29
	Pond	PD-T6060-SQ-S	Table, 60" Width	\$ 1,780	Square Edge, Sq./Stem Leg	60		60	29
	Pond	PD-3636-PN-R	Square Table, 36"	\$ 1,730	Pencil Edge, Dia./Stem Leg	36		36	29
	Pond	PD-3636-PN-S	Square Table, 36"	\$ 1,730	Pencil Edge, Sq./Stem Leg	36		36	29
	Pond	PD-3636-BN-R	Square Table, 36"	\$ 1,625	Bullnose Edge, Dia./Stem Leg	36		36	29
	Pond	PD-3636-BN-S	Square Table, 36"	\$ 1,625	Bullnose Edge, Sq./Stem Leg	36		36	29
	Pond	PD-3636-SQ-R	Square Table, 36"	\$ 1,555	Square Edge, Dia./Stem Leg	36		36	29
	Pond	PD-3636-SQ-S	Square Table, 36"	\$ 1,555	Square Edge, Sq./Stem Leg	36		36	29
	Pond	PD-4242-PN-R	Square Table, 42"	\$ 1,825	Pencil Edge, Dia./Stem Leg	42		42	29
	Pond	PD-4242-PN-S	Square Table, 42"	\$ 1,825	Pencil Edge, Sq./Stem Leg	42		42	29
	Pond	PD-4242-BN-R	Square Table, 42"	\$ 1,705	Bullnose Edge, Dia./Stem Leg	42		42	29
	Pond	PD-4242-BN-S	Square Table, 42"	\$ 1,705	Bullnose Edge, Sq./Stem Leg	42		42	29
	Pond	PD-4242-SQ-R	Square Table, 42"	\$ 1,630	Square Edge, Dia./Stem Leg	42		42	29
	Pond	PD-4242-SQ-S	Square Table, 42"	\$ 1,630	Square Edge, Sq./Stem Leg	42		42	29
	Pond	PD-4848-PN-R	Square Table, 48"	\$ 1,925	Pencil Edge, Dia./Stem Leg	48		48	29
	Pond	PD-4848-PN-S	Square Table, 48"	\$ 1,925	Pencil Edge, Sq./Stem Leg	48		48	29
	Pond	PD-4848-BN-R	Square Table, 48"	\$ 1,785	Bullnose Edge, Dia./Stem Leg	48		48	29
Pond	PD-4848-BN-S	Square Table, 48"	\$ 1,785	Bullnose Edge, Sq./Stem Leg	48		48	29	
Pond	PD-4848-SQ-R	Square Table, 48"	\$ 1,715	Square Edge, Dia./Stem Leg	48		48	29	
Pond	PD-4848-SQ-S	Square Table, 48"	\$ 1,715	Square Edge, Sq./Stem Leg	48		48	29	
	Pond	PD-R36-PN-R	Round Table 36"	\$ 1,625	Pencil Edge, Dia./Stem Leg	36		36	29
	Pond	PD-R36-PN-S	Round Table 36"	\$ 1,625	Pencil Edge, Sq./Stem Leg	36		36	29
	Pond	PD-R36-BN-R	Round Table 36"	\$ 1,715	Bullnose Edge, Dia./Stem Leg	36		36	29
	Pond	PD-R36-BN-S	Round Table 36"	\$ 1,715	Bullnose Edge, Sq./Stem Leg	36		36	29
	Pond	PD-R36-SQ-R	Round Table 36"	\$ 1,670	Square Edge, Dia./Stem Leg	36		36	29
	Pond	PD-R36-SQ-S	Round Table 36"	\$ 1,670	Square Edge, Sq./Stem Leg	36		36	29
	Pond	PD-R42-PN-R	Round Table 42"	\$ 1,705	Pencil Edge, Dia./Stem Leg	42		42	29
	Pond	PD-R42-PN-S	Round Table 42"	\$ 1,705	Pencil Edge, Sq./Stem Leg	42		42	29
	Pond	PD-R42-BN-R	Round Table 42"	\$ 1,810	Bullnose Edge, Dia./Stem Leg	42		42	29
	Pond	PD-R42-BN-S	Round Table 42"	\$ 1,810	Bullnose Edge, Sq./Stem Leg	42		42	29
	Pond	PD-R42-SQ-R	Round Table 42"	\$ 1,755	Square Edge, Dia./Stem Leg	42		42	29
	Pond	PD-R42-SQ-S	Round Table 42"	\$ 1,755	Square Edge, Sq./Stem Leg	42		42	29
	Pond	PD-R48-PN-R	Round Table 48"	\$ 1,785	Pencil Edge, Dia./Stem Leg	48		48	29
	Pond	PD-R48-PN-S	Round Table 48"	\$ 1,785	Pencil Edge, Sq./Stem Leg	48		48	29
	Pond	PD-R48-BN-R	Round Table 48"	\$ 1,910	Bullnose Edge, Dia./Stem Leg	48		48	29
	Pond	PD-R48-BN-S	Round Table 48"	\$ 1,910	Bullnose Edge, Sq./Stem Leg	48		48	29
	Pond	PD-R48-SQ-R	Round Table 48"	\$ 1,850	Square Edge, Dia./Stem Leg	48		48	29
	Pond	PD-R48-SQ-S	Round Table 48"	\$ 1,850	Square Edge, Sq./Stem Leg	48		48	29
	Pond	PD-R54-PN-R	Round Table 54"	\$ 2,035	Pencil Edge, Dia./Stem Leg	54		54	29
	Pond	PD-R54-PN-S	Round Table 54"	\$ 2,035	Pencil Edge, Sq./Stem Leg	54		54	29

Image	Collection	Catalog Number	Item Description	List Price	Colour / Type	Width (Inches)	Length (Inches)	Depth (Inches)	Height (Inches)
	Pond	PD-R54-BN-R	Round Table 54"	\$ 2,170	Bullnose Edge, Dia./Stem Leg	54		54	29
	Pond	PD-R54-BN-S	Round Table 54"	\$ 2,170	Bullnose Edge, Sq./Stem Leg	54		54	29
	Pond	PD-R54-SQ-R	Round Table 54"	\$ 2,100	Square Edge, Dia./Stem Leg	54		54	29
	Pond	PD-R54-SQ-S	Round Table 54"	\$ 2,100	Square Edge, Sq./Stem Leg	54		54	29
	Pond	PD-R60-PN-R	Round Table 60"	\$ 2,165	Pencil Edge, Dia./Stem Leg	60		60	29
	Pond	PD-R60-PN-S	Round Table 60"	\$ 2,165	Pencil Edge, Sq./Stem Leg	60		60	29
	Pond	PD-R60-BN-R	Round Table 60"	\$ 2,320	Bullnose Edge, Dia./Stem Leg	60		60	29
	Pond	PD-R60-BN-S	Round Table 60"	\$ 2,320	Bullnose Edge, Sq./Stem Leg	60		60	29
	Pond	PD-R60-SQ-R	Round Table 60"	\$ 2,245	Square Edge, Dia./Stem Leg	60		60	29
	Pond	PD-R60-SQ-S	Round Table 60"	\$ 2,245	Square Edge, Sq./Stem Leg	60		60	29
	Pond	PD-3624-PN-R	Rectangle Table, 24" Depth	\$ 1,635	Pencil Edge, Dia./Stem Leg	36		24	29
	Pond	PD-3624-PN-S	Rectangle Table, 24" Depth	\$ 1,635	Pencil Edge, Sq./Stem Leg	36		24	29
	Pond	PD-3624-BN-R	Rectangle Table, 24" Depth	\$ 1,550	Bullnose Edge, Dia./Stem Leg	36		24	29
	Pond	PD-3624-BN-S	Rectangle Table, 24" Depth	\$ 1,550	Bullnose Edge, Sq./Stem Leg	36		24	29
	Pond	PD-3624-SQ-R	Rectangle Table, 24" Depth	\$ 1,480	Square Edge, Dia./Stem Leg	36		24	29
	Pond	PD-3624-SQ-S	Rectangle Table, 24" Depth	\$ 1,480	Square Edge, Sq./Stem Leg	36		24	29
	Pond	PD-4824-PN-R	Rectangle Table, 24" Depth	\$ 1,715	Pencil Edge, Dia./Stem Leg	48		24	29
	Pond	PD-4824-PN-S	Rectangle Table, 24" Depth	\$ 1,715	Pencil Edge, Sq./Stem Leg	48		24	29
	Pond	PD-4824-BN-R	Rectangle Table, 24" Depth	\$ 1,610	Bullnose Edge, Dia./Stem Leg	48		24	29
	Pond	PD-4824-BN-S	Rectangle Table, 24" Depth	\$ 1,610	Bullnose Edge, Sq./Stem Leg	48		24	29
	Pond	PD-4824-SQ-R	Rectangle Table, 24" Depth	\$ 1,540	Square Edge, Dia./Stem Leg	48		24	29
	Pond	PD-4824-SQ-S	Rectangle Table, 24" Depth	\$ 1,540	Square Edge, Sq./Stem Leg	48		24	29
	Pond	PD-6024-PN-R	Rectangle Table, 24" Depth	\$ 1,795	Pencil Edge, Dia./Stem Leg	60		24	29
	Pond	PD-6024-PN-S	Rectangle Table, 24" Depth	\$ 1,795	Pencil Edge, Sq./Stem Leg	60		24	29
	Pond	PD-6024-BN-R	Rectangle Table, 24" Depth	\$ 1,675	Bullnose Edge, Dia./Stem Leg	60		24	29
	Pond	PD-6024-BN-S	Rectangle Table, 24" Depth	\$ 1,675	Bullnose Edge, Sq./Stem Leg	60		24	29
	Pond	PD-6024-SQ-R	Rectangle Table, 24" Depth	\$ 1,600	Square Edge, Dia./Stem Leg	60		24	29
	Pond	PD-6024-SQ-S	Rectangle Table, 24" Depth	\$ 1,600	Square Edge, Sq./Stem Leg	60		24	29
	Pond	PD-7224-PN-R	Rectangle Table, 24" Depth	\$ 1,870	Pencil Edge, Dia./Stem Leg	72		24	29
	Pond	PD-7224-PN-S	Rectangle Table, 24" Depth	\$ 1,870	Pencil Edge, Sq./Stem Leg	72		24	29
	Pond	PD-7224-BN-R	Rectangle Table, 24" Depth	\$ 1,735	Bullnose Edge, Dia./Stem Leg	72		24	29
	Pond	PD-7224-BN-S	Rectangle Table, 24" Depth	\$ 1,735	Bullnose Edge, Sq./Stem Leg	72		24	29
	Pond	PD-7224-SQ-R	Rectangle Table, 24" Depth	\$ 1,665	Square Edge, Dia./Stem Leg	72		24	29
	Pond	PD-7224-SQ-S	Rectangle Table, 24" Depth	\$ 1,665	Square Edge, Sq./Stem Leg	72		24	29
	Pond	PD-4830-PN-R	Rectangle Table, 30" Depth	\$ 1,765	Pencil Edge, Dia./Stem Leg	48		30	29
	Pond	PD-4830-PN-S	Rectangle Table, 30" Depth	\$ 1,765	Pencil Edge, Sq./Stem Leg	48		30	29
	Pond	PD-4830-BN-R	Rectangle Table, 30" Depth	\$ 1,655	Bullnose Edge, Dia./Stem Leg	48		30	29
	Pond	PD-4830-BN-S	Rectangle Table, 30" Depth	\$ 1,655	Bullnose Edge, Sq./Stem Leg	48		30	29
	Pond	PD-4830-SQ-R	Rectangle Table, 30" Depth	\$ 1,585	Square Edge, Dia./Stem Leg	48		30	29
	Pond	PD-4830-SQ-S	Rectangle Table, 30" Depth	\$ 1,585	Square Edge, Sq./Stem Leg	48		30	29





Image	Collection	Catalog Number	Item Description	List Price	Colour / Type	Width (Inches)	Length (Inches)	Depth (Inches)	Height (Inches)
	Pond	PD-6030-PN-R	Rectangle Table, 30" Depth	\$ 1,880	Pencil Edge, Dia./Stem Leg	60		30	29
	Pond	PD-6030-PN-S	Rectangle Table, 30" Depth	\$ 1,880	Pencil Edge, Sq./Stem Leg	60		30	29
	Pond	PD-6030-BN-R	Rectangle Table, 30" Depth	\$ 1,740	Bullnose Edge, Dia./Stem Leg	60		30	29
	Pond	PD-6030-BN-S	Rectangle Table, 30" Depth	\$ 1,740	Bullnose Edge, Sq./Stem Leg	60		30	29
	Pond	PD-6030-SQ-R	Rectangle Table, 30" Depth	\$ 1,665	Square Edge, Dia./Stem Leg	60		30	29
	Pond	PD-6030-SQ-S	Rectangle Table, 30" Depth	\$ 1,665	Square Edge, Sq./Stem Leg	60		30	29
	Pond	PD-7230-PN-R	Rectangle Table, 30" Depth	\$ 1,975	Pencil Edge, Dia./Stem Leg	72		30	29
	Pond	PD-7230-PN-S	Rectangle Table, 30" Depth	\$ 1,975	Pencil Edge, Sq./Stem Leg	72		30	29
	Pond	PD-7230-BN-R	Rectangle Table, 30" Depth	\$ 1,830	Bullnose Edge, Dia./Stem Leg	72		30	29
	Pond	PD-7230-BN-S	Rectangle Table, 30" Depth	\$ 1,830	Bullnose Edge, Sq./Stem Leg	72		30	29
	Pond	PD-7230-SQ-R	Rectangle Table, 30" Depth	\$ 1,760	Square Edge, Dia./Stem Leg	72		30	29
	Pond	PD-7230-SQ-S	Rectangle Table, 30" Depth	\$ 1,760	Square Edge, Sq./Stem Leg	72		30	29
	Pond	PD-6036-PN-R	Rectangle Table, 36" Depth	\$ 1,940	Pencil Edge, Dia./Stem Leg	60		36	29
	Pond	PD-6036-PN-S	Rectangle Table, 36" Depth	\$ 1,940	Pencil Edge, Sq./Stem Leg	60		36	29
	Pond	PD-6036-BN-R	Rectangle Table, 36" Depth	\$ 1,805	Bullnose Edge, Dia./Stem Leg	60		36	29
	Pond	PD-6036-BN-S	Rectangle Table, 36" Depth	\$ 1,805	Bullnose Edge, Sq./Stem Leg	60		36	29
	Pond	PD-6036-SQ-R	Rectangle Table, 36" Depth	\$ 1,730	Square Edge, Dia./Stem Leg	60		36	29
	Pond	PD-6036-SQ-S	Rectangle Table, 36" Depth	\$ 1,730	Square Edge, Sq./Stem Leg	60		36	29
	Pond	PD-7236-PN-R	Rectangle Table, 36" Depth	\$ 2,040	Pencil Edge, Dia./Stem Leg	72		36	29
	Pond	PD-7236-PN-S	Rectangle Table, 36" Depth	\$ 2,040	Pencil Edge, Sq./Stem Leg	72		36	29
	Pond	PD-7236-BN-R	Rectangle Table, 36" Depth	\$ 1,875	Bullnose Edge, Dia./Stem Leg	72		36	29
	Pond	PD-7236-BN-S	Rectangle Table, 36" Depth	\$ 1,875	Bullnose Edge, Sq./Stem Leg	72		36	29
	Pond	PD-7242-PN-R	Rectangle Table, 42" Depth	\$ 2,105	Pencil Edge, Dia./Stem Leg	72		42	29
	Pond	PD-7242-PN-S	Rectangle Table, 42" Depth	\$ 2,105	Pencil Edge, Sq./Stem Leg	72		42	29
	Pond	PD-7242-BN-R	Rectangle Table, 42" Depth	\$ 1,945	Bullnose Edge, Dia./Stem Leg	72		42	29
	Pond	PD-7242-BN-S	Rectangle Table, 42" Depth	\$ 1,945	Bullnose Edge, Sq./Stem Leg	72		42	29
	Pond	PD-7242-SQ-R	Rectangle Table, 42" Depth	\$ 1,870	Square Edge, Dia./Stem Leg	72		42	29
	Pond	PD-7242-SQ-S	Rectangle Table, 42" Depth	\$ 1,870	Square Edge, Sq./Stem Leg	72		42	29
	Pond	PD-8442-PN-R	Rectangle Table, 42" Depth	\$ 2,205	Pencil Edge, Dia./Stem Leg	84		42	29
	Pond	PD-8442-PN-S	Rectangle Table, 42" Depth	\$ 2,205	Pencil Edge, Sq./Stem Leg	84		42	29
	Pond	PD-8442-BN-R	Rectangle Table, 42" Depth	\$ 2,025	Bullnose Edge, Dia./Stem Leg	84		42	29
	Pond	PD-8442-BN-S	Rectangle Table, 42" Depth	\$ 2,025	Bullnose Edge, Sq./Stem Leg	84		42	29
	Pond	PD-8442-SQ-R	Rectangle Table, 42" Depth	\$ 1,955	Square Edge, Dia./Stem Leg	84		42	29
	Pond	PD-8442-SQ-S	Rectangle Table, 42" Depth	\$ 1,955	Square Edge, Sq./Stem Leg	84		42	29
	Pond	PD-9642-PN-R	Rectangle Table, 42" Depth	\$ 2,340	Pencil Edge, Dia./Stem Leg	96		42	29
	Pond	PD-9642-PN-S	Rectangle Table, 42" Depth	\$ 2,340	Pencil Edge, Sq./Stem Leg	96		42	29
Pond	PD-9642-BN-R	Rectangle Table, 42" Depth	\$ 2,105	Bullnose Edge, Dia./Stem Leg	96		42	29	
Pond	PD-9642-BN-S	Rectangle Table, 42" Depth	\$ 2,105	Bullnose Edge, Sq./Stem Leg	96		42	29	

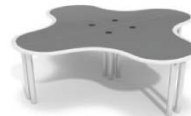

Image	Collection	Catalog Number	Item Description	List Price	Colour / Type	Width (Inches)	Length (Inches)	Depth (Inches)	Height (Inches)
	Pond	PD-9642-SQ-R	Rectangle Table, 42" Depth	\$ 2,035	Square Edge, Dia./Stem Leg	96		42	29
	Pond	PD-9642-SQ-S	Rectangle Table, 42" Depth	\$ 2,035	Square Edge, Sq./Stem Leg	96		42	29
	Pond	PD-E7242 -PN-R	Ellipse Table	\$ 2,595	Pencil Edge, Dia./Stem Leg	72		42	29
	Pond	PD-E7242-PN-S	Ellipse Table	\$ 2,595	Pencil Edge, Sq./Stem Leg	72		42	29
	Pond	PD-E7242-BN-R	Ellipse Table	\$ 2,740	Bullnose Edge, Dia./Stem Leg	72		42	29
	Pond	PD-E7242-BN-S	Ellipse Table	\$ 2,740	Bullnose Edge, Sq./Stem Leg	72		42	29
	Pond	PD-E7242-SQ-R	Ellipse Table	\$ 2,665	Square Edge, Dia./Stem Leg	72		42	29
	Pond	PD-E7242-SQ-S	Ellipse Table	\$ 2,665	Square Edge, Sq./Stem Leg	72		42	29
	Pond	PD-E8442 -PN-R	Ellipse Table	\$ 2,690	Pencil Edge, Dia./Stem Leg	84		42	29
	Pond	PD-E8442-PN-S	Ellipse Table	\$ 2,690	Pencil Edge, Sq./Stem Leg	84		42	29
	Pond	PD-E8442-BN-R	Ellipse Table	\$ 2,855	Bullnose Edge, Dia./Stem Leg	84		42	29
	Pond	PD-E8442-BN-S	Ellipse Table	\$ 2,855	Bullnose Edge, Sq./Stem Leg	84		42	29
	Pond	PD-E8442-SQ-R	Ellipse Table	\$ 2,770	Square Edge, Dia./Stem Leg	84		42	29
	Pond	PD-E8442-SQ-S	Ellipse Table	\$ 2,770	Square Edge, Sq./Stem Leg	84		42	29
	Pond	PD-E9642 -PN-R	Ellipse Table	\$ 2,785	Pencil Edge, Dia./Stem Leg	96		42	29
	Pond	PD-E9642-PN-S	Ellipse Table	\$ 2,785	Pencil Edge, Sq./Stem Leg	96		42	29
	Pond	PD-E9642-BN-R	Ellipse Table	\$ 2,970	Bullnose Edge, Dia./Stem Leg	96		42	29
	Pond	PD-E9642-BN-S	Ellipse Table	\$ 2,970	Bullnose Edge, Sq./Stem Leg	96		42	29
Pond	PD-E9642-SQ-R	Ellipse Table	\$ 2,880	Square Edge, Dia./Stem Leg	96		42	29	
Pond	PD-E9642-SQ-S	Ellipse Table	\$ 2,880	Square Edge, Sq./Stem Leg	96		42	29	
	Pond	PD-CA48-PN-R	Configuration A: 4 Individual Tables, 48" Width Each	\$ 6,400	Pencil Edge, Dia./Stem Leg	96		96	29
	Pond	PD-CA48-PN-S	Configuration A: 4 Individual Tables, 48" Width Each	\$ 6,400	Pencil Edge, Sq./Stem Leg	96		96	29
	Pond	PD-CA48-BN-R	Configuration A: 4 Individual Tables, 48" Width Each	\$ 6,700	Bullnose Edge, Dia./Stem Leg	96		96	29
	Pond	PD-CA48-BN-S	Configuration A: 4 Individual Tables, 48" Width Each	\$ 6,700	Bullnose Edge, Sq./Stem Leg	96		96	29
	Pond	PD-CA48-SQ-R	Configuration A: 4 Individual Tables, 48" Width Each	\$ 6,560	Square Edge, Dia./Stem Leg	96		96	29
	Pond	PD-CA48-SQ-S	Configuration A: 4 Individual Tables, 48" Width Each	\$ 6,560	Square Edge, Sq./Stem Leg	96		96	29
	Pond	PD-CA60-PN-R	Configuration A: 4 Individual Tables, 60" Width Each	\$ 6,960	Pencil Edge, Dia./Stem Leg	120		120	29
	Pond	PD-CA60-PN-S	Configuration A: 4 Individual Tables, 60" Width Each	\$ 6,960	Pencil Edge, Sq./Stem Leg	120		120	29
	Pond	PD-CA60-BN-R	Configuration A: 4 Individual Tables, 60" Width Each	\$ 7,260	Bullnose Edge, Dia./Stem Leg	120		120	29
	Pond	PD-CA60-BN-S	Configuration A: 4 Individual Tables, 60" Width Each	\$ 7,260	Bullnose Edge, Sq./Stem Leg	120		120	29
	Pond	PD-CA60-SQ-R	Configuration A: 4 Individual Tables, 60" Width Each	\$ 7,120	Square Edge, Dia./Stem Leg	120		120	29
	Pond	PD-CA60-SQ-S	Configuration A: 4 Individual Tables, 60" Width Each	\$ 7,120	Square Edge, Sq./Stem Leg	120		120	29
	Pond	PD-CB48-PN-R	Configuration B: 2 Person Workstation, 48" Depth	\$ 2,740	Pencil Edge, Dia./Stem Leg	96		48	29
	Pond	PD-CB48-PN-S	Configuration B: 2 Person Workstation, 48" Depth	\$ 2,740	Pencil Edge, Sq./Stem Leg	96		48	29
	Pond	PD-CB48-BN-R	Configuration B: 2 Person Workstation, 48" Depth	\$ 2,890	Bullnose Edge, Dia./Stem Leg	96		48	29
	Pond	PD-CB48-BN-S	Configuration B: 2 Person Workstation, 48" Depth	\$ 2,890	Bullnose Edge, Sq./Stem Leg	96		48	29
	Pond	PD-CB48-SQ-R	Configuration B: 2 Person Workstation, 48" Depth	\$ 2,815	Square Edge, Dia./Stem Leg	96		48	29
	Pond	PD-CB48-SQ-S	Configuration B: 2 Person Workstation, 48" Depth	\$ 2,815	Square Edge, Sq./Stem Leg	96		48	29
	Pond	PD-CB60-PN-R	Configuration B: 2 Person Workstation, 60" Depth	\$ 3,015	Pencil Edge, Dia./Stem Leg	120		60	29
	Pond	PD-CB60-PN-S	Configuration B: 2 Person Workstation, 60" Depth	\$ 3,015	Pencil Edge, Sq./Stem Leg	120		60	29



Image	Collection	Catalog Number	Item Description	List Price	Colour / Type	Width (Inches)	Length (Inches)	Depth (Inches)	Height (Inches)	
	Pond	PD-CB60-BN-R	Configuration B: 2 Person Workstation, 60" Depth	\$ 3,165	Bullnose Edge, Dia./Stem Leg	120		60	29	
	Pond	PD-CB60-BN-S	Configuration B: 2 Person Workstation, 60" Depth	\$ 3,165	Bullnose Edge, Sq./Stem Leg	120		60	29	
	Pond	PD-CB60-SQ-R	Configuration B: 2 Person Workstation, 60" Depth	\$ 3,090	Square Edge, Dia./Stem Leg	120		60	29	
	Pond	PD-CB60-SQ-S	Configuration B: 2 Person Workstation, 60" Depth	\$ 3,090	Square Edge, Sq./Stem Leg	120		60	29	
	Pond	PD-CC48-PN-R	Configuration C: 2 Person Workstation, 48" Depth	\$ 2,740	Pencil Edge, Dia./Stem Leg	96		48	29	
	Pond	PD-CC48-PN-S	Configuration C: 2 Person Workstation, 48" Depth	\$ 2,740	Pencil Edge, Sq./Stem Leg	96		48	29	
	Pond	PD-CC48-BN-R	Configuration C: 2 Person Workstation, 48" Depth	\$ 2,890	Bullnose Edge, Dia./Stem Leg	96		48	29	
	Pond	PD-CC48-BN-S	Configuration C: 2 Person Workstation, 48" Depth	\$ 2,890	Bullnose Edge, Sq./Stem Leg	96		48	29	
	Pond	PD-CC48-SQ-R	Configuration C: 2 Person Workstation, 48" Depth	\$ 2,815	Square Edge, Dia./Stem Leg	96		48	29	
	Pond	PD-CC48-SQ-S	Configuration C: 2 Person Workstation, 48" Depth	\$ 2,815	Square Edge, Sq./Stem Leg	96		48	29	
	Pond	PD-CC60-PN-R	Configuration C: 2 Person Workstation, 60" Depth	\$ 3,015	Pencil Edge, Dia./Stem Leg	120		60	29	
	Pond	PD-CC60-PN-S	Configuration C: 2 Person Workstation, 60" Depth	\$ 3,015	Pencil Edge, Sq./Stem Leg	120		60	29	
	Pond	PD-CC60-BN-R	Configuration C: 2 Person Workstation, 60" Depth	\$ 3,165	Bullnose Edge, Dia./Stem Leg	120		60	29	
	Pond	PD-CC60-BN-S	Configuration C: 2 Person Workstation, 60" Depth	\$ 3,165	Bullnose Edge, Sq./Stem Leg	120		60	29	
	Pond	PD-CC60-SQ-R	Configuration C: 2 Person Workstation, 60" Depth	\$ 3,090	Square Edge, Dia./Stem Leg	120		60	29	
	Pond	PD-CC60-SQ-S	Configuration C: 2 Person Workstation, 60" Depth	\$ 3,090	Square Edge, Sq./Stem Leg	120		60	29	
		Pond	PD-CD48-PN-R	Configuration D: 3 Person Workstation, 48" Depth	\$ 3,345	Pencil Edge, Dia./Stem Leg	96		96	29
		Pond	PD-CD48-PN-S	Configuration D: 3 Person Workstation, 48" Depth	\$ 3,345	Pencil Edge, Sq./Stem Leg	96		96	29
Pond		PD-CD48-BN-R	Configuration D: 3 Person Workstation, 48" Depth	\$ 3,510	Bullnose Edge, Dia./Stem Leg	96		96	29	
Pond		PD-CD48-BN-S	Configuration D: 3 Person Workstation, 48" Depth	\$ 3,510	Bullnose Edge, Sq./Stem Leg	96		96	29	
Pond		PD-CD48-SQ-R	Configuration D: 3 Person Workstation, 48" Depth	\$ 3,425	Square Edge, Dia./Stem Leg	96		96	29	
Pond		PD-CD48-SQ-S	Configuration D: 3 Person Workstation, 48" Depth	\$ 3,425	Square Edge, Sq./Stem Leg	96		96	29	
Pond		PD-CD60-PN-R	Configuration D: 3 Person Workstation, 60" Depth	\$ 4,495	Pencil Edge, Dia./Stem Leg	120		120	29	
Pond		PD-CD60-PN-S	Configuration D: 3 Person Workstation, 60" Depth	\$ 4,495	Pencil Edge, Sq./Stem Leg	120		120	29	
Pond		PD-CD60-BN-R	Configuration D: 3 Person Workstation, 60" Depth	\$ 4,715	Bullnose Edge, Dia./Stem Leg	120		120	29	
Pond		PD-CD60-BN-S	Configuration D: 3 Person Workstation, 60" Depth	\$ 4,715	Bullnose Edge, Sq./Stem Leg	120		120	29	
Pond		PD-CD60-SQ-R	Configuration D: 3 Person Workstation, 60" Depth	\$ 4,605	Square Edge, Dia./Stem Leg	120		120	29	
Pond		PD-CD60-SQ-S	Configuration D: 3 Person Workstation, 60" Depth	\$ 4,605	Square Edge, Sq./Stem Leg	120		120	29	
		Pond	PD-CE48-PN-R	Configuration E: 4 Person Workstation, 48" Depth	\$ 4,400	Pencil Edge, Dia./Stem Leg	96		96	29
		Pond	PD-CE48-PN-S	Configuration E: 4 Person Workstation, 48" Depth	\$ 4,400	Pencil Edge, Sq./Stem Leg	96		96	29
	Pond	PD-CE48-BN-R	Configuration E: 4 Person Workstation, 48" Depth	\$ 4,705	Bullnose Edge, Dia./Stem Leg	96		96	29	
	Pond	PD-CE48-BN-S	Configuration E: 4 Person Workstation, 48" Depth	\$ 4,705	Bullnose Edge, Sq./Stem Leg	96		96	29	
	Pond	PD-CE48-SQ-R	Configuration E: 4 Person Workstation, 48" Depth	\$ 4,550	Square Edge, Dia./Stem Leg	96		96	29	
	Pond	PD-CE48-SQ-S	Configuration E: 4 Person Workstation, 48" Depth	\$ 4,550	Square Edge, Sq./Stem Leg	96		96	29	
	Pond	PD-CE60-PN-R	Configuration E: 4 Person Workstation, 60" Depth	\$ 4,950	Pencil Edge, Dia./Stem Leg	120		120	29	
	Pond	PD-CE60-PN-S	Configuration E: 4 Person Workstation, 60" Depth	\$ 4,950	Pencil Edge, Sq./Stem Leg	120		120	29	
	Pond	PD-CE60-BN-R	Configuration E: 4 Person Workstation, 60" Depth	\$ 5,255	Bullnose Edge, Dia./Stem Leg	120		120	29	
	Pond	PD-CE60-BN-S	Configuration E: 4 Person Workstation, 60" Depth	\$ 5,255	Bullnose Edge, Sq./Stem Leg	120		120	29	
	Pond	PD-CE60-SQ-R	Configuration E: 4 Person Workstation, 60" Depth	\$ 5,105	Square Edge, Dia./Stem Leg	120		120	29	
	Pond	PD-CE60-SQ-S	Configuration E: 4 Person Workstation, 60" Depth	\$ 5,105	Square Edge, Sq./Stem Leg	120		120	29	



Image	Collection	Catalog Number	Item Description	List Price	Colour / Type	Width (Inches)	Length (Inches)	Depth (Inches)	Height (Inches)
	Pond	PD-CF48-PN-R	Configuration F: 4 Person Workstation II, 48" Depth	\$ 4,445	Pencil Edge, Dia./Stem Leg	96		96	29
	Pond	PD-CF48-PN-S	Configuration F: 4 Person Workstation II, 48" Depth	\$ 4,445	Pencil Edge, Sq./Stem Leg	96		96	29
	Pond	PD-CF48-BN-R	Configuration F: 4 Person Workstation II, 48" Depth	\$ 4,670	Bullnose Edge, Dia./Stem Leg	96		96	29
	Pond	PD-CF48-BN-S	Configuration F: 4 Person Workstation II, 48" Depth	\$ 4,670	Bullnose Edge, Sq./Stem Leg	96		96	29
	Pond	PD-CF48-SQ-R	Configuration F: 4 Person Workstation II, 48" Depth	\$ 4,560	Square Edge, Dia./Stem Leg	96		96	29
	Pond	PD-CF48-SQ-S	Configuration F: 4 Person Workstation II, 48" Depth	\$ 4,560	Square Edge, Sq./Stem Leg	96		96	29
	Pond	PD-CF60-PN-R	Configuration F: 4 Person Workstation II, 60" Depth	\$ 4,995	Pencil Edge, Dia./Stem Leg	120		120	29
	Pond	PD-CF60-PN-S	Configuration F: 4 Person Workstation II, 60" Depth	\$ 4,995	Pencil Edge, Sq./Stem Leg	120		120	29
	Pond	PD-CF60-BN-R	Configuration F: 4 Person Workstation II, 60" Depth	\$ 5,225	Bullnose Edge, Dia./Stem Leg	120		120	29
	Pond	PD-CF60-BN-S	Configuration F: 4 Person Workstation II, 60" Depth	\$ 5,225	Bullnose Edge, Sq./Stem Leg	120		120	29
	Pond	PD-CF60-SQ-R	Configuration F: 4 Person Workstation II, 60" Depth	\$ 5,110	Square Edge, Dia./Stem Leg	120		120	29
	Pond	PD-CF60-SQ-S	Configuration F: 4 Person Workstation II, 60" Depth	\$ 5,110	Square Edge, Sq./Stem Leg	120		120	29
	Pond	PD-CG48-PN-R	Configuration G: 6 Person Workstation, 48" Depth	\$ 4,365	Pencil Edge, Dia./Stem Leg	96		48	29
	Pond	PD-CG48-PN-S	Configuration G: 6 Person Workstation, 48" Depth	\$ 4,365	Pencil Edge, Sq./Stem Leg	96		48	29
	Pond	PD-CG48-BN-R	Configuration G: 6 Person Workstation, 48" Depth	\$ 4,620	Bullnose Edge, Dia./Stem Leg	96		48	29
	Pond	PD-CG48-BN-S	Configuration G: 6 Person Workstation, 48" Depth	\$ 4,620	Bullnose Edge, Sq./Stem Leg	96		48	29
	Pond	PD-CG48-SQ-R	Configuration G: 6 Person Workstation, 48" Depth	\$ 4,490	Square Edge, Dia./Stem Leg	96		48	29
	Pond	PD-CG48-SQ-S	Configuration G: 6 Person Workstation, 48" Depth	\$ 4,490	Square Edge, Sq./Stem Leg	96		48	29
	Pond	PD-CG60-PN-R	Configuration G: 6 Person Workstation, 60" Depth	\$ 5,340	Pencil Edge, Dia./Stem Leg	120		60	29
	Pond	PD-CG60-PN-S	Configuration G: 6 Person Workstation, 60" Depth	\$ 5,340	Pencil Edge, Sq./Stem Leg	120		60	29
	Pond	PD-CG60-BN-R	Configuration G: 6 Person Workstation, 60" Depth	\$ 5,630	Bullnose Edge, Dia./Stem Leg	120		60	29
	Pond	PD-CG60-BN-S	Configuration G: 6 Person Workstation, 60" Depth	\$ 5,630	Bullnose Edge, Sq./Stem Leg	120		60	29
	Pond	PD-CG60-SQ-R	Configuration G: 6 Person Workstation, 60" Depth	\$ 5,485	Square Edge, Dia./Stem Leg	120		60	29
	Pond	PD-CG60-SQ-S	Configuration G: 6 Person Workstation, 60" Depth	\$ 5,485	Square Edge, Sq./Stem Leg	120		60	29
	Solo	SO-R36-AC-ST	Round Table, 36"	\$ 695	Acrylic Edge, Straight Leg	36		36	29
	Solo	SO-R36-AC-WC	Round Table, 36"	\$ 995	Acrylic Edge, Wave Caster Leg	36		36	29
	Solo	SO-R36-AC-WF	Round Table, 36"	\$ 745	Acrylic Edge, Wave Fixed Leg	36		36	29
	Solo	SO-R36-BN-ST	Round Table, 36"	\$ 850	Bullnose Edge, Straight Leg	36		36	29
	Solo	SO-R36-BN-WC	Round Table, 36"	\$ 1,145	Bullnose Edge, Wave Caster Leg	36		36	29
	Solo	SO-R36-BN-WF	Round Table, 36"	\$ 895	Bullnose Edge, Wave Fixed Leg	36		36	29
	Solo	SO-R36-SQ-ST	Round Table, 36"	\$ 795	Square Edge, Straight Leg	36		36	29
	Solo	SO-R36-SQ-WC	Round Table, 36"	\$ 1,090	Square Edge, Wave Caster Leg	36		36	29
	Solo	SO-R36-SQ-WF	Round Table, 36"	\$ 840	Square Edge, Wave Fixed Leg	36		36	29
	Solo	SO-R42-AC-ST	Round Table, 42"	\$ 740	Acrylic Edge, Straight Leg	42		42	29
	Solo	SO-R42-AC-WC	Round Table, 42"	\$ 1,040	Acrylic Edge, Wave Caster Leg	42		42	29
	Solo	SO-R42-AC-WF	Round Table, 42"	\$ 790	Acrylic Edge, Wave Fixed Leg	42		42	29
	Solo	SO-R42-BN-ST	Round Table, 42"	\$ 920	Bullnose Edge, Straight Leg	42		42	29
	Solo	SO-R42-BN-WC	Round Table, 42"	\$ 1,215	Bullnose Edge, Wave Caster Leg	42		42	29
	Solo	SO-R42-BN-WF	Round Table, 42"	\$ 965	Bullnose Edge, Wave Fixed Leg	42		42	29
	Solo	SO-R42-SQ-ST	Round Table, 42"	\$ 855	Square Edge, Straight Leg	42		42	29
	Solo	SO-R42-SQ-WC	Round Table, 42"	\$ 1,155	Square Edge, Wave Caster Leg	42		42	29
	Solo	SO-R42-SQ-WF	Round Table, 42"	\$ 900	Square Edge, Wave Fixed Leg	42		42	29
	Solo	SO-R48-AC-ST	Round Table, 48"	\$ 795	Acrylic Edge, Straight Leg	48		48	29

Image	Collection	Catalog Number	Item Description	List Price	Colour / Type	Width (Inches)	Length (Inches)	Depth (Inches)	Height (Inches)
	Solo	SO-R48-AC-WC	Round Table, 48"	\$ 1,095	Acrylic Edge, Wave Caster Leg	48		48	29
	Solo	SO-R48-AC-WF	Round Table, 48"	\$ 840	Acrylic Edge, Wave Fixed Leg	48		48	29
	Solo	SO-R48-BN-ST	Round Table, 48"	\$ 995	Bullnose Edge, Straight Leg	48		48	29
	Solo	SO-R48-BN-WC	Round Table, 48"	\$ 1,295	Bullnose Edge, Wave Caster Leg	48		48	29
	Solo	SO-R48-BN-WF	Round Table, 48"	\$ 1,045	Bullnose Edge, Wave Fixed Leg	48		48	29
	Solo	SO-R48-SQ-ST	Round Table, 48"	\$ 925	Square Edge, Straight Leg	48		48	29
	Solo	SO-R48-SQ-WC	Round Table, 48"	\$ 1,220	Square Edge, Wave Caster Leg	48		48	29
	Solo	SO-R48-SQ-WF	Round Table, 48"	\$ 970	Square Edge, Wave Fixed Leg	48		48	29
	Solo	SO-R54-AC-ST	Round Table, 54"	\$ 845	Acrylic Edge, Straight Leg	54		54	29
	Solo	SO-R54-AC-WC	Round Table, 54"	\$ 1,140	Acrylic Edge, Wave Caster Leg	54		54	29
Solo	SO-R54-AC-WF	Round Table, 54"	\$ 890	Acrylic Edge, Wave Fixed Leg	54		54	29	
Solo	SO-R54-BN-ST	Round Table, 54"	\$ 1,100	Bullnose Edge, Straight Leg	54		54	29	
Solo	SO-R54-BN-WC	Round Table, 54"	\$ 1,370	Bullnose Edge, Wave Caster Leg	54		54	29	
Solo	SO-R54-BN-WF	Round Table, 54"	\$ 1,120	Bullnose Edge, Wave Fixed Leg	54		54	29	
Solo	SO-R54-SQ-ST	Round Table, 54"	\$ 990	Square Edge, Straight Leg	54		54	29	
Solo	SO-R54-SQ-WC	Round Table, 54"	\$ 1,290	Square Edge, Wave Caster Leg	54		54	29	
Solo	SO-R54-SQ-WF	Round Table, 54"	\$ 1,035	Square Edge, Wave Fixed Leg	54		54	29	
Solo	SO-R60-AC-ST	Round Table, 60"	\$ 910	Acrylic Edge, Straight Leg	60		60	29	
Solo	SO-R60-AC-WC	Round Table, 60"	\$ 1,205	Acrylic Edge, Wave Caster Leg	60		60	29	
Solo	SO-R60-AC-WF	Round Table, 60"	\$ 955	Acrylic Edge, Wave Fixed Leg	60		60	29	
Solo	SO-R60-BN-ST	Round Table, 60"	\$ 1,160	Bullnose Edge, Straight Leg	60		60	29	
Solo	SO-R60-BN-WC	Round Table, 60"	\$ 1,455	Bullnose Edge, Wave Caster Leg	60		60	29	
Solo	SO-R60-BN-WF	Round Table, 60"	\$ 1,475	Bullnose Edge, Wave Fixed Leg	60		60	29	
Solo	SO-R60-SQ-ST	Round Table, 60"	\$ 1,070	Square Edge, Straight Leg	60		60	29	
Solo	SO-R60-SQ-WC	Round Table, 60"	\$ 1,370	Square Edge, Wave Caster Leg	60		60	29	
Solo	SO-R60-SQ-WF	Round Table, 60"	\$ 1,115	Square Edge, Wave Fixed Leg	60		60	29	
Solo	SO-HR-4824-AC-ST	Half Round Table, 48" Width	\$ 670	Acrylic Edge, Straight Leg	48		24	29	
Solo	SO-HR-4824-AC-WC	Half Round Table, 48" Width	\$ 970	Acrylic Edge, Wave Caster Leg	48		24	29	
Solo	SO-HR-4824-AC-WF	Half Round Table, 48" Width	\$ 720	Acrylic Edge, Wave Fixed Leg	48		24	29	
Solo	SO-HR-4824-BN-ST	Half Round Table, 48" Width	\$ 780	Bullnose Edge, Straight Leg	48		24	29	
Solo	SO-HR-4824-BN-WC	Half Round Table, 48" Width	\$ 1,075	Bullnose Edge, Wave Caster Leg	48		24	29	
Solo	SO-HR-4824-BN-WF	Half Round Table, 48" Width	\$ 825	Bullnose Edge, Wave Fixed Leg	48		24	29	
Solo	SO-HR-4824-SQ-ST	Half Round Table, 48" Width	\$ 740	Square Edge, Straight Leg	48		24	29	
Solo	SO-HR-4824-SQ-WC	Half Round Table, 48" Width	\$ 1,040	Square Edge, Wave Caster Leg	48		24	29	
Solo	SO-HR-4824-SQ-WF	Half Round Table, 48" Width	\$ 785	Square Edge, Wave Fixed Leg	48		24	29	
Solo	SO-HR-5427-AC-ST	Half Round Table, 54" Width	\$ 700	Acrylic Edge, Straight Leg	54		27	29	
Solo	SO-HR-5427-AC-WC	Half Round Table, 54" Width	\$ 1,000	Acrylic Edge, Wave Caster Leg	54		27	29	
Solo	SO-HR-5427-AC-WF	Half Round Table, 54" Width	\$ 750	Acrylic Edge, Wave Fixed Leg	54		27	29	
Solo	SO-HR-5427-BN-ST	Half Round Table, 54" Width	\$ 820	Bullnose Edge, Straight Leg	54		27	29	
Solo	SO-HR-5427-BN-WC	Half Round Table, 54" Width	\$ 1,115	Bullnose Edge, Wave Caster Leg	54		27	29	
Solo	SO-HR-5427-BN-WF	Half Round Table, 54" Width	\$ 865	Bullnose Edge, Wave Fixed Leg	54		27	29	
Solo	SO-HR-5427-SQ-ST	Half Round Table, 54" Width	\$ 780	Square Edge, Straight Leg	54		27	29	
Solo	SO-HR-5427-SQ-WC	Half Round Table, 54" Width	\$ 1,075	Square Edge, Wave Caster Leg	54		27	29	
Solo	SO-HR-5427-SQ-WF	Half Round Table, 54" Width	\$ 825	Square Edge, Wave Fixed Leg	54		27	29	
Solo	SO-HR-6030-AC-ST	Half Round Table, 60" Width	\$ 730	Acrylic Edge, Straight Leg	60		30	29	
Solo	SO-HR-6030-AC-WC	Half Round Table, 60" Width	\$ 1,030	Acrylic Edge, Wave Caster Leg	60		30	29	
Solo	SO-HR-6030-AC-WF	Half Round Table, 60" Width	\$ 780	Acrylic Edge, Wave Fixed Leg	60		30	29	





Image	Collection	Catalog Number	Item Description	List Price	Colour / Type	Width (Inches)	Length (Inches)	Depth (Inches)	Height (Inches)
	Solo	SO-HR-6030-BN-ST	Half Round Table, 60" Width	\$ 865	Bullnose Edge, Straight Leg	60		30	29
	Solo	SO-HR-6030-BN-WC	Half Round Table, 60" Width	\$ 1,165	Bullnose Edge, Wave Caster Leg	60		30	29
	Solo	SO-HR-6030-BN-WF	Half Round Table, 60" Width	\$ 910	Bullnose Edge, Wave Fixed Leg	60		30	29
	Solo	SO-HR-6030-SQ-ST	Half Round Table, 60" Width	\$ 820	Square Edge, Straight Leg	60		30	29
	Solo	SO-HR-6030-SQ-WC	Half Round Table, 60" Width	\$ 1,115	Square Edge, Wave Caster Leg	60		30	29
	Solo	SO-HR-6030-SQ-WF	Half Round Table, 60" Width	\$ 865	Square Edge, Wave Fixed Leg	60		30	29
	Solo	SO-QR-24-AC-ST	Quarter Round Table, 24"	\$ 575	Acrylic Edge, Straight Leg	24		24	29
	Solo	SO-QR-24-AC-WC	Quarter Round Table, 24"	\$ 795	Acrylic Edge, Wave Caster Leg	24		24	29
	Solo	SO-QR-24-AC-WF	Quarter Round Table, 24"	\$ 610	Acrylic Edge, Wave Fixed Leg	24		24	29
	Solo	SO-QR-24-BN-ST	Quarter Round Table, 24"	\$ 690	Bullnose Edge, Straight Leg	24		24	29
	Solo	SO-QR-24-BN-WC	Quarter Round Table, 24"	\$ 910	Bullnose Edge, Wave Caster Leg	24		24	29
	Solo	SO-QR-24-BN-WF	Quarter Round Table, 24"	\$ 720	Bullnose Edge, Wave Fixed Leg	24		24	29
	Solo	SO-QR-24-SQ-ST	Quarter Round Table, 24"	\$ 650	Square Edge, Straight Leg	24		24	29
	Solo	SO-QR-24-SQ-WC	Quarter Round Table, 24"	\$ 870	Square Edge, Wave Caster Leg	24		24	29
	Solo	SO-QR-24-SQ-WF	Quarter Round Table, 24"	\$ 680	Square Edge, Wave Fixed Leg	24		24	29
	Solo	SO-QR-30-AC-ST	Quarter Round Table, 30"	\$ 605	Acrylic Edge, Straight Leg	30		30	29
	Solo	SO-QR-30-AC-WC	Quarter Round Table, 30"	\$ 830	Acrylic Edge, Wave Caster Leg	30		30	29
	Solo	SO-QR-30-AC-WF	Quarter Round Table, 30"	\$ 640	Acrylic Edge, Wave Fixed Leg	30		30	29
	Solo	SO-QR-30-BN-ST	Quarter Round Table, 30"	\$ 750	Bullnose Edge, Straight Leg	30		30	29
	Solo	SO-QR-30-BN-WC	Quarter Round Table, 30"	\$ 970	Bullnose Edge, Wave Caster Leg	30		30	29
Solo	SO-QR-30-BN-WF	Quarter Round Table, 30"	\$ 785	Bullnose Edge, Wave Fixed Leg	30		30	29	
Solo	SO-QR-30-SQ-ST	Quarter Round Table, 30"	\$ 700	Square Edge, Straight Leg	30		30	29	
Solo	SO-QR-30-SQ-WC	Quarter Round Table, 30"	\$ 920	Square Edge, Wave Caster Leg	30		30	29	
Solo	SO-QR-30-SQ-WF	Quarter Round Table, 30"	\$ 735	Square Edge, Wave Fixed Leg	30		30	29	
	Solo	SO-2424-AC-ST	Square Table, 24"	\$ 620	Acrylic Edge, Straight Leg	24		24	29
	Solo	SO-2424-AC-WC	Square Table, 24"	\$ 920	Acrylic Edge, Wave Caster Leg	24		24	29
	Solo	SO-2424-AC-WF	Square Table, 24"	\$ 665	Acrylic Edge, Wave Fixed Leg	24		24	29
	Solo	SO-2424-BN-ST	Square Table, 24"	\$ 750	Bullnose Edge, Straight Leg	24		24	29
	Solo	SO-2424-BN-WC	Square Table, 24"	\$ 1,045	Bullnose Edge, Wave Caster Leg	24		24	29
	Solo	SO-2424-BN-WF	Square Table, 24"	\$ 795	Bullnose Edge, Wave Fixed Leg	24		24	29
	Solo	SO-2424-SQ-ST	Square Table, 24"	\$ 705	Square Edge, Straight Leg	24		24	29
	Solo	SO-2424-SQ-WC	Square Table, 24"	\$ 1,000	Square Edge, Wave Caster Leg	24		24	29
	Solo	SO-2424-SQ-WF	Square Table, 24"	\$ 750	Square Edge, Wave Fixed Leg	24		24	29
	Solo	SO-3030-AC-ST	Square Table, 30"	\$ 655	Acrylic Edge, Straight Leg	30		30	29
	Solo	SO-3030-AC-WC	Square Table, 30"	\$ 950	Acrylic Edge, Wave Caster Leg	30		30	29
	Solo	SO-3030-AC-WF	Square Table, 30"	\$ 700	Acrylic Edge, Wave Fixed Leg	30		30	29
	Solo	SO-3030-BN-ST	Square Table, 30"	\$ 815	Bullnose Edge, Straight Leg	30		30	29
	Solo	SO-3030-BN-WC	Square Table, 30"	\$ 1,110	Bullnose Edge, Wave Caster Leg	30		30	29
	Solo	SO-3030-BN-WF	Square Table, 30"	\$ 860	Bullnose Edge, Wave Fixed Leg	30		30	29
	Solo	SO-3030-SQ-ST	Square Table, 30"	\$ 755	Square Edge, Straight Leg	30		30	29
	Solo	SO-3030-SQ-WC	Square Table, 30"	\$ 1,055	Square Edge, Wave Caster Leg	30		30	29
Solo	SO-3030-SQ-WF	Square Table, 30"	\$ 800	Square Edge, Wave Fixed Leg	30		30	29	
Solo	SO-3024-AC-ST	Rectangle Table, 24" Depth	\$ 635	Acrylic Edge, Straight Leg	30		24	29	
Solo	SO-3024-AC-WC	Rectangle Table, 24" Depth	\$ 930	Acrylic Edge, Wave Caster Leg	30		24	29	
Solo	SO-3024-AC-WF	Rectangle Table, 24" Depth	\$ 680	Acrylic Edge, Wave Fixed Leg	30		24	29	
Solo	SO-3024-BN-ST	Rectangle Table, 24" Depth	\$ 780	Bullnose Edge, Straight Leg	30		24	29	
Solo	SO-3024-BN-WC	Rectangle Table, 24" Depth	\$ 1,075	Bullnose Edge, Wave Caster Leg	30		24	29	
Solo	SO-3024-BN-WF	Rectangle Table, 24" Depth	\$ 825	Bullnose Edge, Wave Fixed Leg	30		24	29	
Solo	SO-3024-SQ-ST	Rectangle Table, 24" Depth	\$ 730	Square Edge, Straight Leg	30		24	29	
Solo	SO-3024-SQ-WC	Rectangle Table, 24" Depth	\$ 1,025	Square Edge, Wave Caster Leg	30		24	29	
Solo	SO-3024-SQ-WF	Rectangle Table, 24" Depth	\$ 775	Square Edge, Wave Fixed Leg	30		24	29	
Solo	SO-3624-AC-ST	Rectangle Table, 24" Depth	\$ 650	Acrylic Edge, Straight Leg	36		24	29	
Solo	SO-3624-AC-WC	Rectangle Table, 24" Depth	\$ 945	Acrylic Edge, Wave Caster Leg	36		24	29	

Image	Collection	Catalog Number	Item Description	List Price	Colour / Type	Width (Inches)	Length (Inches)	Depth (Inches)	Height (Inches)
	Solo	SO-3624-AC-WF	Rectangle Table, 24" Depth	\$ 695	Acrylic Edge, Wave Fixed Leg	36		24	29
	Solo	SO-3624-BN-ST	Rectangle Table, 24" Depth	\$ 810	Bullnose Edge, Straight Leg	36		24	29
	Solo	SO-3624-BN-WC	Rectangle Table, 24" Depth	\$ 1,105	Bullnose Edge, Wave Caster Leg	36		24	29
	Solo	SO-3624-BN-WF	Rectangle Table, 24" Depth	\$ 855	Bullnose Edge, Wave Fixed Leg	36		24	29
	Solo	SO-3624-SQ-ST	Rectangle Table, 24" Depth	\$ 755	Square Edge, Straight Leg	36		24	29
	Solo	SO-3624-SQ-WC	Rectangle Table, 24" Depth	\$ 1,050	Square Edge, Wave Caster Leg	36		24	29
	Solo	SO-3624-SQ-WF	Rectangle Table, 24" Depth	\$ 800	Square Edge, Wave Fixed Leg	36		24	29
	Solo	SO-4224-AC-ST	Rectangle Table, 24" Depth	\$ 665	Acrylic Edge, Straight Leg	42		24	29
	Solo	SO-4224-AC-WC	Rectangle Table, 24" Depth	\$ 960	Acrylic Edge, Wave Caster Leg	42		24	29
	Solo	SO-4224-AC-WF	Rectangle Table, 24" Depth	\$ 710	Acrylic Edge, Wave Fixed Leg	42		24	29
	Solo	SO-4224-BN-ST	Rectangle Table, 24" Depth	\$ 840	Bullnose Edge, Straight Leg	42		24	29
	Solo	SO-4224-BN-WC	Rectangle Table, 24" Depth	\$ 1,135	Bullnose Edge, Wave Caster Leg	42		24	29
	Solo	SO-4224-BN-WF	Rectangle Table, 24" Depth	\$ 885	Bullnose Edge, Wave Fixed Leg	42		24	29
	Solo	SO-4224-SQ-ST	Rectangle Table, 24" Depth	\$ 780	Square Edge, Straight Leg	42		24	29
	Solo	SO-4224-SQ-WC	Rectangle Table, 24" Depth	\$ 1,075	Square Edge, Wave Caster Leg	42		24	29
	Solo	SO-4224-SQ-WF	Rectangle Table, 24" Depth	\$ 825	Square Edge, Wave Fixed Leg	42		24	29
	Solo	SO-4824-AC-ST	Rectangle Table, 24" Depth	\$ 680	Acrylic Edge, Straight Leg	48		24	29
	Solo	SO-4824-AC-WC	Rectangle Table, 24" Depth	\$ 975	Acrylic Edge, Wave Caster Leg	48		24	29
	Solo	SO-4824-AC-WF	Rectangle Table, 24" Depth	\$ 725	Acrylic Edge, Wave Fixed Leg	48		24	29
	Solo	SO-4824-BN-ST	Rectangle Table, 24" Depth	\$ 870	Bullnose Edge, Straight Leg	48		24	29
	Solo	SO-4824-BN-WC	Rectangle Table, 24" Depth	\$ 1,165	Bullnose Edge, Wave Caster Leg	48		24	29
	Solo	SO-4824-BN-WF	Rectangle Table, 24" Depth	\$ 915	Bullnose Edge, Wave Fixed Leg	48		24	29
	Solo	SO-4824-SQ-ST	Rectangle Table, 24" Depth	\$ 805	Square Edge, Straight Leg	48		24	29
	Solo	SO-4824-SQ-WC	Rectangle Table, 24" Depth	\$ 1,100	Square Edge, Wave Caster Leg	48		24	29
	Solo	SO-4824-SQ-WF	Rectangle Table, 24" Depth	\$ 850	Square Edge, Wave Fixed Leg	48		24	29
	Solo	SO-5424-AC-ST	Rectangle Table, 24" Depth	\$ 695	Acrylic Edge, Straight Leg	54		24	29
	Solo	SO-5424-AC-WC	Rectangle Table, 24" Depth	\$ 990	Acrylic Edge, Wave Caster Leg	54		24	29
	Solo	SO-5424-AC-WF	Rectangle Table, 24" Depth	\$ 740	Acrylic Edge, Wave Fixed Leg	54		24	29
	Solo	SO-5424-BN-ST	Rectangle Table, 24" Depth	\$ 900	Bullnose Edge, Straight Leg	54		24	29
	Solo	SO-5424-BN-WC	Rectangle Table, 24" Depth	\$ 1,200	Bullnose Edge, Wave Caster Leg	54		24	29
	Solo	SO-5424-BN-WF	Rectangle Table, 24" Depth	\$ 945	Bullnose Edge, Wave Fixed Leg	54		24	29
	Solo	SO-5424-SQ-ST	Rectangle Table, 24" Depth	\$ 825	Square Edge, Straight Leg	54		24	29
	Solo	SO-5424-SQ-WC	Rectangle Table, 24" Depth	\$ 1,125	Square Edge, Wave Caster Leg	54		24	29
	Solo	SO-5424-SQ-WF	Rectangle Table, 24" Depth	\$ 875	Square Edge, Wave Fixed Leg	54		24	29
	Solo	SO-6024-AC-ST	Rectangle Table, 24" Depth	\$ 710	Acrylic Edge, Straight Leg	60		24	29
	Solo	SO-6024-AC-WC	Rectangle Table, 24" Depth	\$ 1,005	Acrylic Edge, Wave Caster Leg	60		24	29
	Solo	SO-6024-AC-WF	Rectangle Table, 24" Depth	\$ 755	Acrylic Edge, Wave Fixed Leg	60		24	29
	Solo	SO-6024-BN-ST	Rectangle Table, 24" Depth	\$ 930	Bullnose Edge, Straight Leg	60		24	29
	Solo	SO-6024-BN-WC	Rectangle Table, 24" Depth	\$ 1,230	Bullnose Edge, Wave Caster Leg	60		24	29
	Solo	SO-6024-BN-WF	Rectangle Table, 24" Depth	\$ 975	Bullnose Edge, Wave Fixed Leg	60		24	29
	Solo	SO-6024-SQ-ST	Rectangle Table, 24" Depth	\$ 850	Square Edge, Straight Leg	60		24	29
	Solo	SO-6024-SQ-WC	Rectangle Table, 24" Depth	\$ 1,150	Square Edge, Wave Caster Leg	60		24	29
Solo	SO-6024-SQ-WF	Rectangle Table, 24" Depth	\$ 900	Square Edge, Wave Fixed Leg	60		24	29	
Solo	SO-7224-AC-ST	Rectangle Table, 24" Depth	\$ 735	Acrylic Edge, Straight Leg	72		24	29	
Solo	SO-7224-AC-WC	Rectangle Table, 24" Depth	\$ 1,035	Acrylic Edge, Wave Caster Leg	72		24	29	
Solo	SO-7224-AC-WF	Rectangle Table, 24" Depth	\$ 785	Acrylic Edge, Wave Fixed Leg	72		24	29	
Solo	SO-7224-BN-ST	Rectangle Table, 24" Depth	\$ 995	Bullnose Edge, Straight Leg	72		24	29	
Solo	SO-7224-BN-WC	Rectangle Table, 24" Depth	\$ 1,290	Bullnose Edge, Wave Caster Leg	72		24	29	
Solo	SO-7224-BN-WF	Rectangle Table, 24" Depth	\$ 1,040	Bullnose Edge, Wave Fixed Leg	72		24	29	
Solo	SO-7224-SQ-ST	Rectangle Table, 24" Depth	\$ 900	Square Edge, Straight Leg	72		24	29	
Solo	SO-7224-SQ-WC	Rectangle Table, 24" Depth	\$ 1,200	Square Edge, Wave Caster Leg	72		24	29	
Solo	SO-7224-SQ-WF	Rectangle Table, 24" Depth	\$ 945	Square Edge, Wave Fixed Leg	72		24	29	
Solo	SO-3630-AC-ST	Rectangle Table, 30" Depth	\$ 670	Acrylic Edge, Straight Leg	36		30	29	
Solo	SO-3630-AC-WC	Rectangle Table, 30" Depth	\$ 970	Acrylic Edge, Wave Caster Leg	36		30	29	
Solo	SO-3630-AC-WF	Rectangle Table, 30" Depth	\$ 715	Acrylic Edge, Wave Fixed Leg	36		30	29	
Solo	SO-3630-BN-ST	Rectangle Table, 30" Depth	\$ 845	Bullnose Edge, Straight Leg	36		30	29	
Solo	SO-3630-BN-WC	Rectangle Table, 30" Depth	\$ 1,145	Bullnose Edge, Wave Caster Leg	36		30	29	
Solo	SO-3630-BN-WF	Rectangle Table, 30" Depth	\$ 895	Bullnose Edge, Wave Fixed Leg	36		30	29	

Image	Collection	Catalog Number	Item Description	List Price	Colour / Type	Width (Inches)	Length (Inches)	Depth (Inches)	Height (Inches)
	Solo	SO-3630-SQ-ST	Rectangle Table, 30" Depth	\$ 785	Square Edge, Straight Leg	36		30	29
	Solo	SO-3630-SQ-WC	Rectangle Table, 30" Depth	\$ 1,080	Square Edge, Wave Caster Leg	36		30	29
	Solo	SO-3630-SQ-WF	Rectangle Table, 30" Depth	\$ 830	Square Edge, Wave Fixed Leg	36		30	29
	Solo	SO-4230-AC-ST	Rectangle Table, 30" Depth	\$ 690	Acrylic Edge, Straight Leg	42		30	29
	Solo	SO-4230-AC-WC	Rectangle Table, 30" Depth	\$ 985	Acrylic Edge, Wave Caster Leg	42		30	29
	Solo	SO-4230-AC-WF	Rectangle Table, 30" Depth	\$ 735	Acrylic Edge, Wave Fixed Leg	42		30	29
	Solo	SO-4230-BN-ST	Rectangle Table, 30" Depth	\$ 880	Bullnose Edge, Straight Leg	42		30	29
	Solo	SO-4230-BN-WC	Rectangle Table, 30" Depth	\$ 1,175	Bullnose Edge, Wave Caster Leg	42		30	29
	Solo	SO-4230-BN-WF	Rectangle Table, 30" Depth	\$ 925	Bullnose Edge, Wave Fixed Leg	42		30	29
	Solo	SO-4230-SQ-ST	Rectangle Table, 30" Depth	\$ 815	Square Edge, Straight Leg	42		30	29
	Solo	SO-4230-SQ-WC	Rectangle Table, 30" Depth	\$ 1,110	Square Edge, Wave Caster Leg	42		30	29
	Solo	SO-4230-SQ-WF	Rectangle Table, 30" Depth	\$ 860	Square Edge, Wave Fixed Leg	42		30	29
	Solo	SO-4830-AC-ST	Rectangle Table, 30" Depth	\$ 705	Acrylic Edge, Straight Leg	48		30	29
	Solo	SO-4830-AC-WC	Rectangle Table, 30" Depth	\$ 1,005	Acrylic Edge, Wave Caster Leg	48		30	29
	Solo	SO-4830-AC-WF	Rectangle Table, 30" Depth	\$ 755	Acrylic Edge, Wave Fixed Leg	48		30	29
	Solo	SO-4830-BN-ST	Rectangle Table, 30" Depth	\$ 915	Bullnose Edge, Straight Leg	48		30	29
	Solo	SO-4830-BN-WC	Rectangle Table, 30" Depth	\$ 1,210	Bullnose Edge, Wave Caster Leg	48		30	29
	Solo	SO-4830-BN-WF	Rectangle Table, 30" Depth	\$ 960	Bullnose Edge, Wave Fixed Leg	48		30	29
	Solo	SO-4830-SQ-ST	Rectangle Table, 30" Depth	\$ 840	Square Edge, Straight Leg	48		30	29
	Solo	SO-4830-SQ-WC	Rectangle Table, 30" Depth	\$ 1,135	Square Edge, Wave Caster Leg	48		30	29
	Solo	SO-4830-SQ-WF	Rectangle Table, 30" Depth	\$ 885	Square Edge, Wave Fixed Leg	48		30	29
	Solo	SO-5430-AC-ST	Rectangle Table, 30" Depth	\$ 725	Acrylic Edge, Straight Leg	54		30	29
	Solo	SO-5430-AC-WC	Rectangle Table, 30" Depth	\$ 1,020	Acrylic Edge, Wave Caster Leg	54		30	29
	Solo	SO-5430-AC-WF	Rectangle Table, 30" Depth	\$ 770	Acrylic Edge, Wave Fixed Leg	54		30	29
	Solo	SO-5430-BN-ST	Rectangle Table, 30" Depth	\$ 950	Bullnose Edge, Straight Leg	54		30	29
	Solo	SO-5430-BN-WC	Rectangle Table, 30" Depth	\$ 1,245	Bullnose Edge, Wave Caster Leg	54		30	29
	Solo	SO-5430-BN-WF	Rectangle Table, 30" Depth	\$ 995	Bullnose Edge, Wave Fixed Leg	54		30	29
	Solo	SO-5430-SQ-ST	Rectangle Table, 30" Depth	\$ 870	Square Edge, Straight Leg	54		30	29
	Solo	SO-5430-SQ-WC	Rectangle Table, 30" Depth	\$ 1,165	Square Edge, Wave Caster Leg	54		30	29
	Solo	SO-5430-SQ-WF	Rectangle Table, 30" Depth	\$ 915	Square Edge, Wave Fixed Leg	54		30	29
	Solo	SO-6030-AC-ST	Rectangle Table, 30" Depth	\$ 745	Acrylic Edge, Straight Leg	60		30	29
	Solo	SO-6030-AC-WC	Rectangle Table, 30" Depth	\$ 1,040	Acrylic Edge, Wave Caster Leg	60		30	29
	Solo	SO-6030-AC-WF	Rectangle Table, 30" Depth	\$ 790	Acrylic Edge, Wave Fixed Leg	60		30	29
	Solo	SO-6030-BN-ST	Rectangle Table, 30" Depth	\$ 980	Bullnose Edge, Straight Leg	60		30	29
	Solo	SO-6030-BN-WC	Rectangle Table, 30" Depth	\$ 1,280	Bullnose Edge, Wave Caster Leg	60		30	29
	Solo	SO-6030-BN-WF	Rectangle Table, 30" Depth	\$ 1,030	Bullnose Edge, Wave Fixed Leg	60		30	29
	Solo	SO-6030-SQ-ST	Rectangle Table, 30" Depth	\$ 895	Square Edge, Straight Leg	60		30	29
	Solo	SO-6030-SQ-WC	Rectangle Table, 30" Depth	\$ 1,195	Square Edge, Wave Caster Leg	60		30	29
	Solo	SO-6030-SQ-WF	Rectangle Table, 30" Depth	\$ 940	Square Edge, Wave Fixed Leg	60		30	29
	Solo	SO-7230-AC-ST	Rectangle Table, 30" Depth	\$ 780	Acrylic Edge, Straight Leg	72		30	29
	Solo	SO-7230-AC-WC	Rectangle Table, 30" Depth	\$ 1,075	Acrylic Edge, Wave Caster Leg	72		30	29
	Solo	SO-7230-AC-WF	Rectangle Table, 30" Depth	\$ 825	Acrylic Edge, Wave Fixed Leg	72		30	29
Solo	SO-7230-BN-ST	Rectangle Table, 30" Depth	\$ 1,050	Bullnose Edge, Straight Leg	72		30	29	
Solo	SO-7230-BN-WC	Rectangle Table, 30" Depth	\$ 1,345	Bullnose Edge, Wave Caster Leg	72		30	29	
Solo	SO-7230-BN-WF	Rectangle Table, 30" Depth	\$ 1,095	Bullnose Edge, Wave Fixed Leg	72		30	29	
Solo	SO-7230-SQ-ST	Rectangle Table, 30" Depth	\$ 955	Square Edge, Straight Leg	72		30	29	
Solo	SO-7230-SQ-WC	Rectangle Table, 30" Depth	\$ 1,250	Square Edge, Wave Caster Leg	72		30	29	
Solo	SO-7230-SQ-WF	Rectangle Table, 30" Depth	\$ 1,000	Square Edge, Wave Fixed Leg	72		30	29	
Solo	SO-TZ-4821-AC-ST	Trapezoid Table, 48" Width	\$ 665	Acrylic Edge, Straight Leg	48		21	29	
Solo	SO-TZ-4821-AC-WC	Trapezoid Table, 48" Width	\$ 960	Acrylic Edge, Wave Caster Leg	48		21	29	
Solo	SO-TZ-4821-AC-WF	Trapezoid Table, 48" Width	\$ 710	Acrylic Edge, Wave Fixed Leg	48		21	29	
Solo	SO-TZ-4821-BN-ST	Trapezoid Table, 48" Width	\$ 825	Bullnose Edge, Straight Leg	48		21	29	
Solo	SO-TZ-4821-BN-WC	Trapezoid Table, 48" Width	\$ 1,120	Bullnose Edge, Wave Caster Leg	48		21	29	
Solo	SO-TZ-4821-BN-WF	Trapezoid Table, 48" Width	\$ 870	Bullnose Edge, Wave Fixed Leg	48		21	29	



Image	Collection	Catalog Number	Item Description	List Price	Colour / Type	Width (Inches)	Length (Inches)	Depth (Inches)	Height (Inches)
	Solo	SO-TZ-4821-SQ-ST	Trapezoid Table, 48" Width	\$ 765	Square Edge, Straight Leg	48		21	29
	Solo	SO-TZ-4821-SQ-WC	Trapezoid Table, 48" Width	\$ 1,065	Square Edge, Wave Caster Leg	48		21	29
	Solo	SO-TZ-4821-SQ-WF	Trapezoid Table, 48" Width	\$ 810	Square Edge, Wave Fixed Leg	48		21	29
	Solo	SO-TZ-5423-AC-ST	Trapezoid Table, 54" Width	\$ 685	Acrylic Edge, Straight Leg	54		23	29
	Solo	SO-TZ-5423-AC-WC	Trapezoid Table, 54" Width	\$ 985	Acrylic Edge, Wave Caster Leg	54		23	29
	Solo	SO-TZ-5423-AC-WF	Trapezoid Table, 54" Width	\$ 735	Acrylic Edge, Wave Fixed Leg	54		23	29
	Solo	SO-TZ-5423-BN-ST	Trapezoid Table, 54" Width	\$ 865	Bullnose Edge, Straight Leg	54		23	29
	Solo	SO-TZ-5423-BN-WC	Trapezoid Table, 54" Width	\$ 1,165	Bullnose Edge, Wave Caster Leg	54		23	29
	Solo	SO-TZ-5423-BN-WF	Trapezoid Table, 54" Width	\$ 910	Bullnose Edge, Wave Fixed Leg	54		23	29
	Solo	SO-TZ-5423-SQ-ST	Trapezoid Table, 54" Width	\$ 805	Square Edge, Straight Leg	54		23	29
	Solo	SO-TZ-5423-SQ-WC	Trapezoid Table, 54" Width	\$ 1,100	Square Edge, Wave Caster Leg	54		23	29
	Solo	SO-TZ-5423-SQ-WF	Trapezoid Table, 54" Width	\$ 850	Square Edge, Wave Fixed Leg	54		23	29
	Solo	SO-TZ-6026-AC-ST	Trapezoid Table, 60" Width	\$ 720	Acrylic Edge, Straight Leg	60		26	29
	Solo	SO-TZ-6026-AC-WC	Trapezoid Table, 60" Width	\$ 1,015	Acrylic Edge, Wave Caster Leg	60		26	29
	Solo	SO-TZ-6026-AC-WF	Trapezoid Table, 60" Width	\$ 765	Acrylic Edge, Wave Fixed Leg	60		26	29
	Solo	SO-TZ-6026-BN-ST	Trapezoid Table, 60" Width	\$ 920	Bullnose Edge, Straight Leg	60		26	29
	Solo	SO-TZ-6026-BN-WC	Trapezoid Table, 60" Width	\$ 1,215	Bullnose Edge, Wave Caster Leg	60		26	29
	Solo	SO-TZ-6026-BN-WF	Trapezoid Table, 60" Width	\$ 965	Bullnose Edge, Wave Fixed Leg	60		26	29
Solo	SO-TZ-6026-SQ-ST	Trapezoid Table, 60" Width	\$ 915	Square Edge, Straight Leg	60		26	29	
Solo	SO-TZ-6026-SQ-WC	Trapezoid Table, 60" Width	\$ 1,145	Square Edge, Wave Caster Leg	60		26	29	
Solo	SO-TZ-6026-SQ-WF	Trapezoid Table, 60" Width	\$ 890	Square Edge, Wave Fixed Leg	60		26	29	
	Solo	SO-BR-7236-AC-ST	Barrel Table	\$ 820	Acrylic Edge, Straight Leg	72		36	29
	Solo	SO-BR-7236-AC-WC	Barrel Table	\$ 1,115	Acrylic Edge, Wave Caster Leg	72		36	29
	Solo	SO-BR-7236-AC-WF	Barrel Table	\$ 865	Acrylic Edge, Wave Fixed Leg	72		36	29
	Solo	SO-BR-7236-BN-ST	Barrel Table	\$ 1,065	Bullnose Edge, Straight Leg	72		36	29
	Solo	SO-BR-7236-BN-WC	Barrel Table	\$ 1,360	Bullnose Edge, Wave Caster Leg	72		36	29
	Solo	SO-BR-7236-BN-WF	Barrel Table	\$ 1,110	Bullnose Edge, Wave Fixed Leg	72		36	29
	Solo	SO-BR-7236-SQ-ST	Barrel Table	\$ 975	Square Edge, Straight Leg	72		36	29
	Solo	SO-BR-7236-SQ-WC	Barrel Table	\$ 1,270	Square Edge, Wave Caster Leg	72		36	29
	Solo	SO-BR-7236-SQ-WF	Barrel Table	\$ 1,020	Square Edge, Wave Fixed Leg	72		36	29
		Solo	SO-PR-6036-AC-ST	Puzzle Right Table, 60" Width	\$ 780	Acrylic Edge, Straight Leg	60		36
Solo		SO-PR-6036-AC-WC	Puzzle Right Table, 60" Width	\$ 1,075	Acrylic Edge, Wave Caster Leg	60		36	29
Solo		SO-PR-6036-AC-WF	Puzzle Right Table, 60" Width	\$ 960	Acrylic Edge, Wave Fixed Leg	60		36	29
Solo		SO-PR-6036-BN-ST	Puzzle Right Table, 60" Width	\$ 1,025	Bullnose Edge, Straight Leg	60		36	29
Solo		SO-PR-6036-BN-WC	Puzzle Right Table, 60" Width	\$ 1,320	Bullnose Edge, Wave Caster Leg	60		36	29
Solo		SO-PR-6036-BN-WF	Puzzle Right Table, 60" Width	\$ 1,070	Bullnose Edge, Wave Fixed Leg	60		36	29
Solo		SO-PR-6036-SQ-ST	Puzzle Right Table, 60" Width	\$ 935	Square Edge, Straight Leg	60		36	29
Solo		SO-PR-6036-SQ-WC	Puzzle Right Table, 60" Width	\$ 1,230	Square Edge, Wave Caster Leg	60		36	29
Solo		SO-PR-6036-SQ-WF	Puzzle Right Table, 60" Width	\$ 980	Square Edge, Wave Fixed Leg	60		36	29
Solo		SO-PR-7236-AC-ST	Puzzle Right Table, 72" Width	\$ 820	Acrylic Edge, Straight Leg	72		36	29
Solo		SO-PR-7236-AC-WC	Puzzle Right Table, 72" Width	\$ 1,115	Acrylic Edge, Wave Caster Leg	72		36	29
Solo		SO-PR-7236-AC-WF	Puzzle Right Table, 72" Width	\$ 865	Acrylic Edge, Wave Fixed Leg	72		36	29
Solo		SO-PR-7236-BN-ST	Puzzle Right Table, 72" Width	\$ 1,095	Bullnose Edge, Straight Leg	72		36	29
Solo		SO-PR-7236-BN-WC	Puzzle Right Table, 72" Width	\$ 1,395	Bullnose Edge, Wave Caster Leg	72		36	29
Solo		SO-PR-7236-BN-WF	Puzzle Right Table, 72" Width	\$ 1,145	Bullnose Edge, Wave Fixed Leg	72		36	29
Solo		SO-PR-7236-SQ-ST	Puzzle Right Table, 72" Width	\$ 1,000	Square Edge, Straight Leg	72		36	29
Solo		SO-PR-7236-SQ-WC	Puzzle Right Table, 72" Width	\$ 1,295	Square Edge, Wave Caster Leg	72		36	29
Solo		SO-PR-7236-SQ-WF	Puzzle Right Table, 72" Width	\$ 1,045	Square Edge, Wave Fixed Leg	72		36	29
	Solo	SO-PL-6036-AC-ST	Puzzle Left Table, 60" Width	\$ 825	Acrylic Edge, Straight Leg	60		36	29
	Solo	SO-PL-6036-AC-WC	Puzzle Left Table, 60" Width	\$ 1,075	Acrylic Edge, Wave Caster Leg	60		36	29
	Solo	SO-PL-6036-AC-WF	Puzzle Left Table, 60" Width	\$ 825	Acrylic Edge, Wave Fixed Leg	60		36	29
	Solo	SO-PL-6036-BN-ST	Puzzle Left Table, 60" Width	\$ 1,025	Bullnose Edge, Straight Leg	60		36	29



Image	Collection	Catalog Number	Item Description	List Price	Colour / Type	Width (Inches)	Length (Inches)	Depth (Inches)	Height (Inches)
	Solo	SO-PL-6036-BN-WC	Puzzle Left Table, 60" Width	\$ 1,320	Bullnose Edge, Wave Caster Leg	60		36	29
	Solo	SO-PL-6036-BN-WF	Puzzle Left Table, 60" Width	\$ 1,070	Bullnose Edge, Wave Fixed Leg	60		36	29
	Solo	SO-PL-6036-SQ-ST	Puzzle Left Table, 60" Width	\$ 935	Square Edge, Straight Leg	60		36	29
	Solo	SO-PL-6036-SQ-WC	Puzzle Left Table, 60" Width	\$ 1,230	Square Edge, Wave Caster Leg	60		36	29
	Solo	SO-PL-6036-SQ-WF	Puzzle Left Table, 60" Width	\$ 980	Square Edge, Wave Fixed Leg	60		36	29
	Solo	SO-PL-7236-AC-ST	Puzzle Left Table, 72" Width	\$ 865	Acrylic Edge, Straight Leg	72		36	29
	Solo	SO-PL-7236-AC-WC	Puzzle Left Table, 72" Width	\$ 1,115	Acrylic Edge, Wave Caster Leg	72		36	29
	Solo	SO-PL-7236-AC-WF	Puzzle Left Table, 72" Width	\$ 865	Acrylic Edge, Wave Fixed Leg	72		36	29
	Solo	SO-PL-7236-BN-ST	Puzzle Left Table, 72" Width	\$ 1,100	Bullnose Edge, Straight Leg	72		36	29
	Solo	SO-PL-7236-BN-WC	Puzzle Left Table, 72" Width	\$ 1,395	Bullnose Edge, Wave Caster Leg	72		36	29
	Solo	SO-PL-7236-BN-WF	Puzzle Left Table, 72" Width	\$ 1,145	Bullnose Edge, Wave Fixed Leg	72		36	29
	Solo	SO-PL-7236-SQ-ST	Puzzle Left Table, 72" Width	\$ 1,000	Square Edge, Straight Leg	72		36	29
	Solo	SO-PL-7236-SQ-WC	Puzzle Left Table, 72" Width	\$ 1,295	Square Edge, Wave Caster Leg	72		36	29
	Solo	SO-PL-7236-SQ-WF	Puzzle Left Table, 72" Width	\$ 1,045	Square Edge, Wave Fixed Leg	72		36	29
	Solo	SO-TR-24-AC-ST	Triangle Table, 24"	\$ 575	Acrylic Edge, Straight Leg	24		24	29
	Solo	SO-TR-24-AC-WC	Triangle Table, 24"	\$ 795	Acrylic Edge, Wave Caster Leg	24		24	29
	Solo	SO-TR-24-AC-WF	Triangle Table, 24"	\$ 610	Acrylic Edge, Wave Fixed Leg	24		24	29
	Solo	SO-TR-24-BN-ST	Triangle Table, 24"	\$ 670	Bullnose Edge, Straight Leg	24		24	29
	Solo	SO-TR-24-BN-WC	Triangle Table, 24"	\$ 890	Bullnose Edge, Wave Caster Leg	24		24	29
	Solo	SO-TR-24-BN-WF	Triangle Table, 24"	\$ 705	Bullnose Edge, Wave Fixed Leg	24		24	29
	Solo	SO-TR-24-SQ-ST	Triangle Table, 24"	\$ 635	Square Edge, Straight Leg	24		24	29
	Solo	SO-TR-24-SQ-WC	Triangle Table, 24"	\$ 960	Square Edge, Wave Caster Leg	24		24	29
	Solo	SO-TR-24-SQ-WF	Triangle Table, 24"	\$ 670	Square Edge, Wave Fixed Leg	24		24	29
	Solo	SO-TR-30-AC-ST	Triangle Table, 30"	\$ 605	Acrylic Edge, Straight Leg	30		30	29
	Solo	SO-TR-30-AC-WC	Triangle Table, 30"	\$ 830	Acrylic Edge, Wave Caster Leg	30		30	29
	Solo	SO-TR-30-AC-WF	Triangle Table, 30"	\$ 640	Acrylic Edge, Wave Fixed Leg	30		30	29
	Solo	SO-TR-30-BN-ST	Triangle Table, 30"	\$ 725	Bullnose Edge, Straight Leg	30		30	29
	Solo	SO-TR-30-BN-WC	Triangle Table, 30"	\$ 950	Bullnose Edge, Wave Caster Leg	30		30	29
Solo	SO-TR-30-BN-WF	Triangle Table, 30"	\$ 760	Bullnose Edge, Wave Fixed Leg	30		30	29	
Solo	SO-TR-30-SQ-ST	Triangle Table, 30"	\$ 685	Square Edge, Straight Leg	30		30	29	
Solo	SO-TR-30-SQ-WC	Triangle Table, 30"	\$ 905	Square Edge, Wave Caster Leg	30		30	29	
Solo	SO-TR-30-SQ-WF	Triangle Table, 30"	\$ 715	Square Edge, Wave Fixed Leg	30		30	29	
	Solo	SO-CWS-4224-AC-ST	Corner Workstation, 24" Depth	\$ 785	Acrylic Edge, Straight Leg	42	42	24	29
	Solo	SO-CWS-4224-AC-WC	Corner Workstation, 24" Depth	\$ 1,155	Acrylic Edge, Wave Caster Leg	42	42	24	29
	Solo	SO-CWS-4224-AC-WF	Corner Workstation, 24" Depth	\$ 840	Acrylic Edge, Wave Fixed Leg	42	42	24	29
	Solo	SO-CWS-4224-BN-ST	Corner Workstation, 24" Depth	\$ 995	Bullnose Edge, Straight Leg	42	42	24	29
	Solo	SO-CWS-4224-BN-WC	Corner Workstation, 24" Depth	\$ 1,365	Bullnose Edge, Wave Caster Leg	42	42	24	29
	Solo	SO-CWS-4224-BN-WF	Corner Workstation, 24" Depth	\$ 1,055	Bullnose Edge, Wave Fixed Leg	42	42	24	29
	Solo	SO-CWS-4224-SQ-ST	Corner Workstation, 24" Depth	\$ 920	Square Edge, Straight Leg	42	42	24	29
	Solo	SO-CWS-4224-SQ-WC	Corner Workstation, 24" Depth	\$ 1,290	Square Edge, Wave Caster Leg	42	42	24	29
	Solo	SO-CWS-4224-SQ-WF	Corner Workstation, 24" Depth	\$ 980	Square Edge, Wave Fixed Leg	42	42	24	29
	Solo	SO-CWS-4824-AC-ST	Corner Workstation, 24" Depth	\$ 835	Acrylic Edge, Straight Leg	48	48	24	29
	Solo	SO-CWS-4824-AC-WC	Corner Workstation, 24" Depth	\$ 1,205	Acrylic Edge, Wave Caster Leg	48	48	24	29
	Solo	SO-CWS-4824-AC-WF	Corner Workstation, 24" Depth	\$ 895	Acrylic Edge, Wave Fixed Leg	48	48	24	29
	Solo	SO-CWS-4824-BN-ST	Corner Workstation, 24" Depth	\$ 1,075	Bullnose Edge, Straight Leg	48	48	24	29
	Solo	SO-CWS-4824-BN-WC	Corner Workstation, 24" Depth	\$ 1,445	Bullnose Edge, Wave Caster Leg	48	48	24	29
	Solo	SO-CWS-4824-BN-WF	Corner Workstation, 24" Depth	\$ 1,135	Bullnose Edge, Wave Fixed Leg	48	48	24	29
	Solo	SO-CWS-4824-SQ-ST	Corner Workstation, 24" Depth	\$ 990	Square Edge, Straight Leg	48	48	24	29
	Solo	SO-CWS-4824-SQ-WC	Corner Workstation, 24" Depth	\$ 1,360	Square Edge, Wave Caster Leg	48	48	24	29
	Solo	SO-CWS-4824-SQ-WF	Corner Workstation, 24" Depth	\$ 1,050	Square Edge, Wave Fixed Leg	48	48	24	29
	Solo	SO-CWS-4230-AC-ST	Corner Workstation, 30" Depth	\$ 790	Acrylic Edge, Straight Leg	42	42	30	29
Solo	SO-CWS-4230-AC-WC	Corner Workstation, 30" Depth	\$ 1,160	Acrylic Edge, Wave Caster Leg	42	42	30	29	



Image	Collection	Catalog Number	Item Description	List Price	Colour / Type	Width (Inches)	Length (Inches)	Depth (Inches)	Height (Inches)
	Solo	SO-CWS-4230-AC-WF	Corner Workstation, 30" Depth	\$ 845	Acrylic Edge, Wave Fixed Leg	42	42	30	29
	Solo	SO-CWS-4230-BN-ST	Corner Workstation, 30" Depth	\$ 1,000	Bullnose Edge, Straight Leg	42	42	30	29
	Solo	SO-CWS-4230-BN-WC	Corner Workstation, 30" Depth	\$ 1,370	Bullnose Edge, Wave Caster Leg	42	42	30	29
	Solo	SO-CWS-4230-BN-WF	Corner Workstation, 30" Depth	\$ 1,055	Bullnose Edge, Wave Fixed Leg	42	42	30	29
	Solo	SO-CWS-4230-SQ-ST	Corner Workstation, 30" Depth	\$ 925	Square Edge, Straight Leg	42	42	30	29
	Solo	SO-CWS-4230-SQ-WC	Corner Workstation, 30" Depth	\$ 1,295	Square Edge, Wave Caster Leg	42	42	30	29
	Solo	SO-CWS-4230-SQ-WF	Corner Workstation, 30" Depth	\$ 980	Square Edge, Wave Fixed Leg	42	42	30	29
	Solo	SO-CWS-4830-AC-ST	Corner Workstation, 30" Depth	\$ 840	Acrylic Edge, Straight Leg	48	48	30	29
	Solo	SO-CWS-4830-AC-WC	Corner Workstation, 30" Depth	\$ 1,210	Acrylic Edge, Wave Caster Leg	48	48	30	29
	Solo	SO-CWS-4830-AC-WF	Corner Workstation, 30" Depth	\$ 895	Acrylic Edge, Wave Fixed Leg	48	48	30	29
	Solo	SO-CWS-4830-BN-ST	Corner Workstation, 30" Depth	\$ 1,080	Bullnose Edge, Straight Leg	48	48	30	29
	Solo	SO-CWS-4830-BN-WC	Corner Workstation, 30" Depth	\$ 1,450	Bullnose Edge, Wave Caster Leg	48	48	30	29
	Solo	SO-CWS-4830-BN-WF	Corner Workstation, 30" Depth	\$ 1,135	Bullnose Edge, Wave Fixed Leg	48	48	30	29
	Solo	SO-CWS-4830-SQ-ST	Corner Workstation, 30" Depth	\$ 995	Square Edge, Straight Leg	48	48	30	29
	Solo	SO-CWS-4830-SQ-WC	Corner Workstation, 30" Depth	\$ 1,365	Square Edge, Wave Caster Leg	48	48	30	29
	Solo	SO-CWS-4830-SQ-WF	Corner Workstation, 30" Depth	\$ 1,050	Square Edge, Wave Fixed Leg	48	48	30	29
		Team	TE-HER-6024-AC-ST	Half End Right Table, 24" Depth	\$ 710	Acrylic Edge, Straight Leg	60		24
Team		TE-HER-6024-AC-WC	Half End Right Table, 24" Depth	\$ 1,005	Acrylic Edge, Wave Caster Leg	60		24	29
Team		TE-HER-6024-AC-WF	Half End Right Table, 24" Depth	\$ 755	Acrylic Edge, Wave Fixed Leg	60		24	29
Team		TE-HER-6024-BN-ST	Half End Right Table, 24" Depth	\$ 920	Bullnose Edge, Straight Leg	60		24	29
Team		TE-HER-6024-BN-WC	Half End Right Table, 24" Depth	\$ 1,215	Bullnose Edge, Wave Caster Leg	60		24	29
Team		TE-HER-6024-BN-WF	Half End Right Table, 24" Depth	\$ 965	Bullnose Edge, Wave Fixed Leg	60		24	29
Team		TE-HER-6024-SQ-ST	Half End Right Table, 24" Depth	\$ 845	Square Edge, Straight Leg	60		24	29
Team		TE-HER-6024-SQ-WC	Half End Right Table, 24" Depth	\$ 1,140	Square Edge, Wave Caster Leg	60		24	29
Team		TE-HER-6024-SQ-WF	Half End Right Table, 24" Depth	\$ 890	Square Edge, Wave Fixed Leg	60		24	29
Team		TE-HER-6030-AC-ST	Half End Right Table, 30" Depth	\$ 740	Acrylic Edge, Straight Leg	60		30	29
Team		TE-HER-6030-AC-WC	Half End Right Table, 30" Depth	\$ 1,040	Acrylic Edge, Wave Caster Leg	60		30	29
Team		TE-HER-6030-AC-WF	Half End Right Table, 30" Depth	\$ 790	Acrylic Edge, Wave Fixed Leg	60		30	29
Team		TE-HER-6030-BN-ST	Half End Right Table, 30" Depth	\$ 965	Bullnose Edge, Straight Leg	60		30	29
Team		TE-HER-6030-BN-WC	Half End Right Table, 30" Depth	\$ 1,260	Bullnose Edge, Wave Caster Leg	60		30	29
Team		TE-HER-6030-BN-WF	Half End Right Table, 30" Depth	\$ 1,010	Bullnose Edge, Wave Fixed Leg	60		30	29
Team		TE-HER-6030-SQ-ST	Half End Right Table, 30" Depth	\$ 885	Square Edge, Straight Leg	60		30	29
Team		TE-HER-6030-SQ-WC	Half End Right Table, 30" Depth	\$ 1,180	Square Edge, Wave Caster Leg	60		30	29
Team	TE-HER-6030-SQ-WF	Half End Right Table, 30" Depth	\$ 930	Square Edge, Wave Fixed Leg	60		30	29	
	Team	TE-HEL-6024-AC-ST	Half End Left Table, 24" Depth	\$ 710	Acrylic Edge, Straight Leg	60		24	29
	Team	TE-HEL-6024-AC-WC	Half End Left Table, 24" Depth	\$ 1,005	Acrylic Edge, Wave Caster Leg	60		24	29
	Team	TE-HEL-6024-AC-WF	Half End Left Table, 24" Depth	\$ 755	Acrylic Edge, Wave Fixed Leg	60		24	29
	Team	TE-HEL-6024-BN-ST	Half End Left Table, 24" Depth	\$ 920	Bullnose Edge, Straight Leg	60		24	29
	Team	TE-HEL-6024-BN-WC	Half End Left Table, 24" Depth	\$ 1,215	Bullnose Edge, Wave Caster Leg	60		24	29
	Team	TE-HEL-6024-BN-WF	Half End Left Table, 24" Depth	\$ 965	Bullnose Edge, Wave Fixed Leg	60		24	29
	Team	TE-HEL-6024-SQ-ST	Half End Left Table, 24" Depth	\$ 845	Square Edge, Straight Leg	60		24	29
	Team	TE-HEL-6024-SQ-WC	Half End Left Table, 24" Depth	\$ 1,140	Square Edge, Wave Caster Leg	60		24	29
	Team	TE-HEL-6024-SQ-WF	Half End Left Table, 24" Depth	\$ 890	Square Edge, Wave Fixed Leg	60		24	29
	Team	TE-HEL-6030-AC-ST	Half End Left Table, 30" Depth	\$ 740	Acrylic Edge, Straight Leg	60		30	29
	Team	TE-HEL-6030-AC-WC	Half End Left Table, 30" Depth	\$ 1,040	Acrylic Edge, Wave Caster Leg	60		30	29
	Team	TE-HEL-6030-AC-WF	Half End Left Table, 30" Depth	\$ 790	Acrylic Edge, Wave Fixed Leg	60		30	29
	Team	TE-HEL-6030-BN-ST	Half End Left Table, 30" Depth	\$ 965	Bullnose Edge, Straight Leg	60		30	29
	Team	TE-HEL-6030-BN-WC	Half End Left Table, 30" Depth	\$ 1,260	Bullnose Edge, Wave Caster Leg	60		30	29
	Team	TE-HEL-6030-BN-WF	Half End Left Table, 30" Depth	\$ 1,010	Bullnose Edge, Wave Fixed Leg	60		30	29
	Team	TE-HEL-6030-SQ-ST	Half End Left Table, 30" Depth	\$ 885	Square Edge, Straight Leg	60		30	29
	Team	TE-HEL-6030-SQ-WC	Half End Left Table, 30" Depth	\$ 1,180	Square Edge, Wave Caster Leg	60		30	29



Image	Collection	Catalog Number	Item Description	List Price	Colour / Type	Width (Inches)	Length (Inches)	Depth (Inches)	Height (Inches)
	Team	TE-HEL-6030-SQ-WF	Half End Left Table, 30" Depth	\$ 930	Square Edge, Wave Fixed Leg	60		30	29
	Team	TE-EC-6024-AC-ST	End Cap Table, 24" Depth	\$ 710	Acrylic Edge, Straight Leg	60		24	29
	Team	TE-EC-6024-AC-WC	End Cap Table, 24" Depth	\$ 1,010	Acrylic Edge, Wave Caster Leg	60		24	29
	Team	TE-EC-6024-AC-WF	End Cap Table, 24" Depth	\$ 760	Acrylic Edge, Wave Fixed Leg	60		24	29
	Team	TE-EC-6024-BN-ST	End Cap Table, 24" Depth	\$ 920	Bullnose Edge, Straight Leg	60		24	29
	Team	TE-EC-6024-BN-WC	End Cap Table, 24" Depth	\$ 1,220	Bullnose Edge, Wave Caster Leg	60		24	29
	Team	TE-EC-6024-BN-WF	End Cap Table, 24" Depth	\$ 970	Bullnose Edge, Wave Fixed Leg	60		24	29
	Team	TE-EC-6024-SQ-ST	End Cap Table, 24" Depth	\$ 845	Square Edge, Straight Leg	60		24	29
	Team	TE-EC-6024-SQ-WC	End Cap Table, 24" Depth	\$ 1,145	Square Edge, Wave Caster Leg	60		24	29
	Team	TE-EC-6024-SQ-WF	End Cap Table, 24" Depth	\$ 895	Square Edge, Wave Fixed Leg	60		24	29
	Team	TE-EC-6030-AC-ST	End Cap Table, 30" Depth	\$ 745	Acrylic Edge, Straight Leg	60		30	29
	Team	TE-EC-6030-AC-WC	End Cap Table, 30" Depth	\$ 1,045	Acrylic Edge, Wave Caster Leg	60		30	29
	Team	TE-EC-6030-AC-WF	End Cap Table, 30" Depth	\$ 790	Acrylic Edge, Wave Fixed Leg	60		30	29
	Team	TE-EC-6030-BN-ST	End Cap Table, 30" Depth	\$ 970	Bullnose Edge, Straight Leg	60		30	29
	Team	TE-EC-6030-BN-WC	End Cap Table, 30" Depth	\$ 1,265	Bullnose Edge, Wave Caster Leg	60		30	29
	Team	TE-EC-6030-BN-WF	End Cap Table, 30" Depth	\$ 1,015	Bullnose Edge, Wave Fixed Leg	60		30	29
	Team	TE-EC-6030-SQ-ST	End Cap Table, 30" Depth	\$ 890	Square Edge, Straight Leg	60		30	29
	Team	TE-EC-6030-SQ-WC	End Cap Table, 30" Depth	\$ 1,185	Square Edge, Wave Caster Leg	60		30	29
	Team	TE-EC-6030-SQ-WF	End Cap Table, 30" Depth	\$ 935	Square Edge, Wave Fixed Leg	60		30	29
		Team	TE-CU-3024-AC-ST	Curve Table, 24" Depth	\$ 635	Acrylic Edge, Straight Leg	30		24
Team		TE-CU-3024-AC-WC	Curve Table, 24" Depth	\$ 930	Acrylic Edge, Wave Caster Leg	30		24	29
Team		TE-CU-3024-AC-WF	Curve Table, 24" Depth	\$ 680	Acrylic Edge, Wave Fixed Leg	30		24	29
Team		TE-CU-3024-BN-ST	Curve Table, 24" Depth	\$ 780	Bullnose Edge, Straight Leg	30		24	29
Team		TE-CU-3024-BN-WC	Curve Table, 24" Depth	\$ 1,075	Bullnose Edge, Wave Caster Leg	30		24	29
Team		TE-CU-3024-BN-WF	Curve Table, 24" Depth	\$ 825	Bullnose Edge, Wave Fixed Leg	30		24	29
Team		TE-CU-3024-SQ-ST	Curve Table, 24" Depth	\$ 730	Square Edge, Straight Leg	30		24	29
Team		TE-CU-3024-SQ-WC	Curve Table, 24" Depth	\$ 1,025	Square Edge, Wave Caster Leg	30		24	29
Team		TE-CU-3024-SQ-WF	Curve Table, 24" Depth	\$ 775	Square Edge, Wave Fixed Leg	30		24	29
Team		TE-CU-3624-AC-ST	Curve Table, 24" Depth	\$ 650	Acrylic Edge, Straight Leg	36		24	29
Team		TE-CU-3624-AC-WC	Curve Table, 24" Depth	\$ 945	Acrylic Edge, Wave Caster Leg	36		24	29
Team		TE-CU-3624-AC-WF	Curve Table, 24" Depth	\$ 695	Acrylic Edge, Wave Fixed Leg	36		24	29
Team		TE-CU-3624-BN-ST	Curve Table, 24" Depth	\$ 810	Bullnose Edge, Straight Leg	36		24	29
Team		TE-CU-3624-BN-WC	Curve Table, 24" Depth	\$ 1,105	Bullnose Edge, Wave Caster Leg	36		24	29
Team		TE-CU-3624-BN-WF	Curve Table, 24" Depth	\$ 855	Bullnose Edge, Wave Fixed Leg	36		24	29
Team		TE-CU-3624-SQ-ST	Curve Table, 24" Depth	\$ 755	Square Edge, Straight Leg	36		24	29
Team		TE-CU-3624-SQ-WC	Curve Table, 24" Depth	\$ 1,050	Square Edge, Wave Caster Leg	36		24	29
Team		TE-CU-3624-SQ-WF	Curve Table, 24" Depth	\$ 800	Square Edge, Wave Fixed Leg	36		24	29
Team		TE-CU-4224-AC-ST	Curve Table, 24" Depth	\$ 665	Acrylic Edge, Straight Leg	42		24	29
Team		TE-CU-4224-AC-WC	Curve Table, 24" Depth	\$ 960	Acrylic Edge, Wave Caster Leg	42		24	29
Team		TE-CU-4224-AC-WF	Curve Table, 24" Depth	\$ 710	Acrylic Edge, Wave Fixed Leg	42		24	29
Team		TE-CU-4224-BN-ST	Curve Table, 24" Depth	\$ 840	Bullnose Edge, Straight Leg	42		24	29
Team		TE-CU-4224-BN-WC	Curve Table, 24" Depth	\$ 1,135	Bullnose Edge, Wave Caster Leg	42		24	29
Team		TE-CU-4224-BN-WF	Curve Table, 24" Depth	\$ 885	Bullnose Edge, Wave Fixed Leg	42		24	29
Team		TE-CU-4224-SQ-ST	Curve Table, 24" Depth	\$ 780	Square Edge, Straight Leg	42		24	29
Team		TE-CU-4224-SQ-WC	Curve Table, 24" Depth	\$ 1,075	Square Edge, Wave Caster Leg	42		24	29
Team		TE-CU-4224-SQ-WF	Curve Table, 24" Depth	\$ 825	Square Edge, Wave Fixed Leg	42		24	29
Team		TE-CU-4824-AC-ST	Curve Table, 24" Depth	\$ 680	Acrylic Edge, Straight Leg	48		24	29
Team		TE-CU-4824-AC-WC	Curve Table, 24" Depth	\$ 975	Acrylic Edge, Wave Caster Leg	48		24	29
Team		TE-CU-4824-AC-WF	Curve Table, 24" Depth	\$ 725	Acrylic Edge, Wave Fixed Leg	48		24	29
Team		TE-CU-4824-BN-ST	Curve Table, 24" Depth	\$ 870	Bullnose Edge, Straight Leg	48		24	29
Team		TE-CU-4824-BN-WC	Curve Table, 24" Depth	\$ 1,165	Bullnose Edge, Wave Caster Leg	48		24	29
Team		TE-CU-4824-BN-WF	Curve Table, 24" Depth	\$ 915	Bullnose Edge, Wave Fixed Leg	48		24	29
Team		TE-CU-4824-SQ-ST	Curve Table, 24" Depth	\$ 805	Square Edge, Straight Leg	48		24	29
Team		TE-CU-4824-SQ-WC	Curve Table, 24" Depth	\$ 1,100	Square Edge, Wave Caster Leg	48		24	29

Image	Collection	Catalog Number	Item Description	List Price	Colour / Type	Width (Inches)	Length (Inches)	Depth (Inches)	Height (Inches)
	Team	TE-CU-4824-SQ-WF	Curve Table, 24" Depth	\$ 850	Square Edge, Wave Fixed Leg	48		24	29
	Team	TE-CU-5424-AC-ST	Curve Table, 24" Depth	\$ 695	Acrylic Edge, Straight Leg	54		24	29
	Team	TE-CU-5424-AC-WC	Curve Table, 24" Depth	\$ 990	Acrylic Edge, Wave Caster Leg	54		24	29
	Team	TE-CU-5424-AC-WF	Curve Table, 24" Depth	\$ 740	Acrylic Edge, Wave Fixed Leg	54		24	29
	Team	TE-CU-5424-BN-ST	Curve Table, 24" Depth	\$ 900	Bullnose Edge, Straight Leg	54		24	29
	Team	TE-CU-5424-BN-WC	Curve Table, 24" Depth	\$ 1,200	Bullnose Edge, Wave Caster Leg	54		24	29
	Team	TE-CU-5424-BN-WF	Curve Table, 24" Depth	\$ 945	Bullnose Edge, Wave Fixed Leg	54		24	29
	Team	TE-CU-5424-SQ-ST	Curve Table, 24" Depth	\$ 825	Square Edge, Straight Leg	54		24	29
	Team	TE-CU-5424-SQ-WC	Curve Table, 24" Depth	\$ 1,125	Square Edge, Wave Caster Leg	54		24	29
	Team	TE-CU-5424-SQ-WF	Curve Table, 24" Depth	\$ 875	Square Edge, Wave Fixed Leg	54		24	29
	Team	TE-CU-6024-AC-ST	Curve Table, 24" Depth	\$ 710	Acrylic Edge, Straight Leg	60		24	29
	Team	TE-CU-6024-AC-WC	Curve Table, 24" Depth	\$ 1,005	Acrylic Edge, Wave Caster Leg	60		24	29
	Team	TE-CU-6024-AC-WF	Curve Table, 24" Depth	\$ 755	Acrylic Edge, Wave Fixed Leg	60		24	29
	Team	TE-CU-6024-BN-ST	Curve Table, 24" Depth	\$ 930	Bullnose Edge, Straight Leg	60		24	29
	Team	TE-CU-6024-BN-WC	Curve Table, 24" Depth	\$ 1,230	Bullnose Edge, Wave Caster Leg	60		24	29
	Team	TE-CU-6024-BN-WF	Curve Table, 24" Depth	\$ 975	Bullnose Edge, Wave Fixed Leg	60		24	29
	Team	TE-CU-6024-SQ-ST	Curve Table, 24" Depth	\$ 850	Square Edge, Straight Leg	60		24	29
	Team	TE-CU-6024-SQ-WC	Curve Table, 24" Depth	\$ 1,150	Square Edge, Wave Caster Leg	60		24	29
	Team	TE-CU-6024-SQ-WF	Curve Table, 24" Depth	\$ 900	Square Edge, Wave Fixed Leg	60		24	29
	Team	TE-CU-3030-AC-ST	Curve Table, 30" Depth	\$ 655	Acrylic Edge, Straight Leg	30		30	29
	Team	TE-CU-3030-AC-WC	Curve Table, 30" Depth	\$ 950	Acrylic Edge, Wave Caster Leg	30		30	29
	Team	TE-CU-3030-AC-WF	Curve Table, 30" Depth	\$ 700	Acrylic Edge, Wave Fixed Leg	30		30	29
	Team	TE-CU-3030-BN-ST	Curve Table, 30" Depth	\$ 815	Bullnose Edge, Straight Leg	30		30	29
	Team	TE-CU-3030-BN-WC	Curve Table, 30" Depth	\$ 1,110	Bullnose Edge, Wave Caster Leg	30		30	29
	Team	TE-CU-3030-BN-WF	Curve Table, 30" Depth	\$ 860	Bullnose Edge, Wave Fixed Leg	30		30	29
	Team	TE-CU-3030-SQ-ST	Curve Table, 30" Depth	\$ 755	Square Edge, Straight Leg	30		30	29
	Team	TE-CU-3030-SQ-WC	Curve Table, 30" Depth	\$ 1,055	Square Edge, Wave Caster Leg	30		30	29
	Team	TE-CU-3030-SQ-WF	Curve Table, 30" Depth	\$ 800	Square Edge, Wave Fixed Leg	30		30	29
	Team	TE-CU-3630-AC-ST	Curve Table, 30" Depth	\$ 670	Acrylic Edge, Straight Leg	36		30	29
	Team	TE-CU-3630-AC-WC	Curve Table, 30" Depth	\$ 970	Acrylic Edge, Wave Caster Leg	36		30	29
	Team	TE-CU-3630-AC-WF	Curve Table, 30" Depth	\$ 715	Acrylic Edge, Wave Fixed Leg	36		30	29
	Team	TE-CU-3630-BN-ST	Curve Table, 30" Depth	\$ 845	Bullnose Edge, Straight Leg	36		30	29
	Team	TE-CU-3630-BN-WC	Curve Table, 30" Depth	\$ 1,145	Bullnose Edge, Wave Caster Leg	36		30	29
	Team	TE-CU-3630-BN-WF	Curve Table, 30" Depth	\$ 895	Bullnose Edge, Wave Fixed Leg	36		30	29
	Team	TE-CU-3630-SQ-ST	Curve Table, 30" Depth	\$ 785	Square Edge, Straight Leg	36		30	29
	Team	TE-CU-3630-SQ-WC	Curve Table, 30" Depth	\$ 1,080	Square Edge, Wave Caster Leg	36		30	29
	Team	TE-CU-3630-SQ-WF	Curve Table, 30" Depth	\$ 830	Square Edge, Wave Fixed Leg	36		30	29
	Team	TE-CU-4230-AC-ST	Curve Table, 30" Depth	\$ 690	Acrylic Edge, Straight Leg	42		30	29
	Team	TE-CU-4230-AC-WC	Curve Table, 30" Depth	\$ 985	Acrylic Edge, Wave Caster Leg	42		30	29
	Team	TE-CU-4230-AC-WF	Curve Table, 30" Depth	\$ 735	Acrylic Edge, Wave Fixed Leg	42		30	29
	Team	TE-CU-4230-BN-ST	Curve Table, 30" Depth	\$ 880	Bullnose Edge, Straight Leg	42		30	29
	Team	TE-CU-4230-BN-WC	Curve Table, 30" Depth	\$ 1,175	Bullnose Edge, Wave Caster Leg	42		30	29
	Team	TE-CU-4230-BN-WF	Curve Table, 30" Depth	\$ 925	Bullnose Edge, Wave Fixed Leg	42		30	29
	Team	TE-CU-4230-SQ-ST	Curve Table, 30" Depth	\$ 815	Square Edge, Straight Leg	42		30	29
	Team	TE-CU-4230-SQ-WC	Curve Table, 30" Depth	\$ 1,110	Square Edge, Wave Caster Leg	42		30	29
	Team	TE-CU-4230-SQ-WF	Curve Table, 30" Depth	\$ 860	Square Edge, Wave Fixed Leg	42		30	29
	Team	TE-CU-4830-AC-ST	Curve Table, 30" Depth	\$ 705	Acrylic Edge, Straight Leg	48		30	29
	Team	TE-CU-4830-AC-WC	Curve Table, 30" Depth	\$ 1,005	Acrylic Edge, Wave Caster Leg	48		30	29
	Team	TE-CU-4830-AC-WF	Curve Table, 30" Depth	\$ 755	Acrylic Edge, Wave Fixed Leg	48		30	29
	Team	TE-CU-4830-BN-ST	Curve Table, 30" Depth	\$ 915	Bullnose Edge, Straight Leg	48		30	29
	Team	TE-CU-4830-BN-WC	Curve Table, 30" Depth	\$ 1,210	Bullnose Edge, Wave Caster Leg	48		30	29
	Team	TE-CU-4830-BN-WF	Curve Table, 30" Depth	\$ 960	Bullnose Edge, Wave Fixed Leg	48		30	29
	Team	TE-CU-4830-SQ-ST	Curve Table, 30" Depth	\$ 840	Square Edge, Straight Leg	48		30	29





Image	Collection	Catalog Number	Item Description	List Price	Colour / Type	Width (Inches)	Length (Inches)	Depth (Inches)	Height (Inches)
	Team	TE-CU-4830-SQ-WC	Curve Table, 30" Depth	\$ 1,135	Square Edge, Wave Caster Leg	48		30	29
	Team	TE-CU-4830-SQ-WF	Curve Table, 30" Depth	\$ 885	Square Edge, Wave Fixed Leg	48		30	29
	Team	TE-CU-5430-AC-ST	Curve Table, 30" Depth	\$ 725	Acrylic Edge, Straight Leg	54		30	29
	Team	TE-CU-5430-AC-WC	Curve Table, 30" Depth	\$ 1,020	Acrylic Edge, Wave Caster Leg	54		30	29
	Team	TE-CU-5430-AC-WF	Curve Table, 30" Depth	\$ 770	Acrylic Edge, Wave Fixed Leg	54		30	29
	Team	TE-CU-5430-BN-ST	Curve Table, 30" Depth	\$ 950	Bullnose Edge, Straight Leg	54		30	29
	Team	TE-CU-5430-BN-WC	Curve Table, 30" Depth	\$ 1,245	Bullnose Edge, Wave Caster Leg	54		30	29
	Team	TE-CU-5430-BN-WF	Curve Table, 30" Depth	\$ 995	Bullnose Edge, Wave Fixed Leg	54		30	29
	Team	TE-CU-5430-SQ-ST	Curve Table, 30" Depth	\$ 870	Square Edge, Straight Leg	54		30	29
	Team	TE-CU-5430-SQ-WC	Curve Table, 30" Depth	\$ 1,165	Square Edge, Wave Caster Leg	54		30	29
	Team	TE-CU-5430-SQ-WF	Curve Table, 30" Depth	\$ 915	Square Edge, Wave Fixed Leg	54		30	29
	Team	TE-CU-6030-AC-ST	Curve Table, 30" Depth	\$ 745	Acrylic Edge, Straight Leg	60		30	29
	Team	TE-CU-6030-AC-WC	Curve Table, 30" Depth	\$ 1,040	Acrylic Edge, Wave Caster Leg	60		30	29
	Team	TE-CU-6030-AC-WF	Curve Table, 30" Depth	\$ 790	Acrylic Edge, Wave Fixed Leg	60		30	29
	Team	TE-CU-6030-BN-ST	Curve Table, 30" Depth	\$ 980	Bullnose Edge, Straight Leg	60		30	29
	Team	TE-CU-6030-BN-WC	Curve Table, 30" Depth	\$ 1,280	Bullnose Edge, Wave Caster Leg	60		30	29
	Team	TE-CU-6030-BN-WF	Curve Table, 30" Depth	\$ 1,030	Bullnose Edge, Wave Fixed Leg	60		30	29
	Team	TE-CU-6030-SQ-ST	Curve Table, 30" Depth	\$ 895	Square Edge, Straight Leg	60		30	29
	Team	TE-CU-6030-SQ-WC	Curve Table, 30" Depth	\$ 1,195	Square Edge, Wave Caster Leg	60		30	29
	Team	TE-CU-6030-SQ-WF	Curve Table, 30" Depth	\$ 940	Square Edge, Wave Fixed Leg	60		30	29
	Team	TE-RE-7248-AC-ST	Round End Conference Table	\$ 1,365	Acrylic Edge, Straight Leg	72		48	29
	Team	TE-RE-7248-AC-WC	Round End Conference Table	\$ 1,810	Acrylic Edge, Wave Caster Leg	72		48	29
	Team	TE-RE-7248-AC-WF	Round End Conference Table	\$ 1,435	Acrylic Edge, Wave Fixed Leg	72		48	29
	Team	TE-RE-7248-BN-ST	Round End Conference Table	\$ 1,655	Bullnose Edge, Straight Leg	72		48	29
	Team	TE-RE-7248-BN-WC	Round End Conference Table	\$ 2,100	Bullnose Edge, Wave Caster Leg	72		48	29
	Team	TE-RE-7248-BN-WF	Round End Conference Table	\$ 1,725	Bullnose Edge, Wave Fixed Leg	72		48	29
	Team	TE-RE-7248-SQ-ST	Round End Conference Table	\$ 1,555	Square Edge, Straight Leg	72		48	29
	Team	TE-RE-7248-SQ-WC	Round End Conference Table	\$ 2,000	Square Edge, Wave Caster Leg	72		48	29
	Team	TE-RE-7248-SQ-WF	Round End Conference Table	\$ 1,620	Square Edge, Wave Fixed Leg	72		48	29
	Team	TE-3030-AC-TF	Square Workstation, 30"	\$ 1,005	Acrylic Edge, T-Base Fixed	30		30	29
	Team	TE-3030-AC-TC	Square Workstation, 30"	\$ 1,210	Acrylic Edge, T-Base Caster	30		30	29
	Team	TE-3030-BN-TF	Square Workstation, 30"	\$ 1,165	Bullnose Edge, T-Base Fixed	30		30	29
	Team	TE-3030-BN-TC	Square Workstation, 30"	\$ 1,370	Bullnose Edge, T-Base Caster	30		30	29
	Team	TE-3030-SQ-TF	Square Workstation, 30"	\$ 1,105	Square Edge, T-Base Fixed	30		30	29
	Team	TE-3030-SQ-TC	Square Workstation, 30"	\$ 1,310	Square Edge, T-Base Caster	30		30	29
	Team	TE-3636-AC-TF	Square Workstation, 36"	\$ 1,045	Acrylic Edge, T-Base Fixed	36		36	29
	Team	TE-3636-AC-TC	Square Workstation, 36"	\$ 1,250	Acrylic Edge, T-Base Caster	36		36	29
	Team	TE-3636-BN-TF	Square Workstation, 36"	\$ 1,235	Bullnose Edge, T-Base Fixed	36		36	29
	Team	TE-3636-BN-TC	Square Workstation, 36"	\$ 1,440	Bullnose Edge, T-Base Caster	36		36	29
	Team	TE-3636-SQ-TF	Square Workstation, 36"	\$ 1,165	Square Edge, T-Base Fixed	36		36	29
	Team	TE-3636-SQ-TC	Square Workstation, 36"	\$ 1,370	Square Edge, T-Base Caster	36		36	29
	Team	TE-3630-AC-TF	Rectangle Workstation, 30" Depth	\$ 1,020	Acrylic Edge, T-Base Fixed	36		30	29
	Team	TE-3630-AC-TC	Rectangle Workstation, 30" Depth	\$ 1,225	Acrylic Edge, T-Base Caster	36		30	29
Team	TE-3630-BN-TF	Rectangle Workstation, 30" Depth	\$ 1,200	Bullnose Edge, T-Base Fixed	36		30	29	
Team	TE-3630-BN-TC	Rectangle Workstation, 30" Depth	\$ 1,405	Bullnose Edge, T-Base Caster	36		30	29	
Team	TE-3630-SQ-TF	Rectangle Workstation, 30" Depth	\$ 1,135	Square Edge, T-Base Fixed	36		30	29	
Team	TE-3630-SQ-TC	Rectangle Workstation, 30" Depth	\$ 1,340	Square Edge, T-Base Caster	36		30	29	
Team	TE-4230-AC-TF	Rectangle Workstation, 30" Depth	\$ 1,070	Acrylic Edge, T-Base Fixed	42		30	29	
Team	TE-4230-AC-TC	Rectangle Workstation, 30" Depth	\$ 1,275	Acrylic Edge, T-Base Caster	42		30	29	
Team	TE-4230-BN-TF	Rectangle Workstation, 30" Depth	\$ 1,260	Bullnose Edge, T-Base Fixed	42		30	29	
Team	TE-4230-BN-TC	Rectangle Workstation, 30" Depth	\$ 1,465	Bullnose Edge, T-Base Caster	42		30	29	
Team	TE-4230-SQ-TF	Rectangle Workstation, 30" Depth	\$ 1,195	Square Edge, T-Base Fixed	42		30	29	
Team	TE-4230-SQ-TC	Rectangle Workstation, 30" Depth	\$ 1,400	Square Edge, T-Base Caster	42		30	29	
Team	TE-4830-AC-TF	Rectangle Workstation, 30" Depth	\$ 1,110	Acrylic Edge, T-Base Fixed	48		30	29	
Team	TE-4830-AC-TC	Rectangle Workstation, 30" Depth	\$ 1,315	Acrylic Edge, T-Base Caster	48		30	29	



Image	Collection	Catalog Number	Item Description	List Price	Colour / Type	Width (Inches)	Length (Inches)	Depth (Inches)	Height (Inches)
	Team	TE-4830-BN-TF	Rectangle Workstation, 30" Depth	\$ 1,320	Bullnose Edge, T-Base Fixed	48		30	29
	Team	TE-4830-BN-TC	Rectangle Workstation, 30" Depth	\$ 1,525	Bullnose Edge, T-Base Caster	48		30	29
	Team	TE-4830-SQ-TF	Rectangle Workstation, 30" Depth	\$ 1,245	Square Edge, T-Base Fixed	48		30	29
	Team	TE-4830-SQ-TC	Rectangle Workstation, 30" Depth	\$ 1,450	Square Edge, T-Base Caster	48		30	29
	Team	TE-5430-AC-TF	Rectangle Workstation, 30" Depth	\$ 1,130	Acrylic Edge, T-Base Fixed	54		30	29
	Team	TE-5430-AC-TC	Rectangle Workstation, 30" Depth	\$ 1,335	Acrylic Edge, T-Base Caster	54		30	29
	Team	TE-5430-BN-TF	Rectangle Workstation, 30" Depth	\$ 1,350	Bullnose Edge, T-Base Fixed	54		30	29
	Team	TE-5430-BN-TC	Rectangle Workstation, 30" Depth	\$ 1,555	Bullnose Edge, T-Base Caster	54		30	29
	Team	TE-5430-SQ-TF	Rectangle Workstation, 30" Depth	\$ 1,270	Square Edge, T-Base Fixed	54		30	29
	Team	TE-5430-SQ-TC	Rectangle Workstation, 30" Depth	\$ 1,475	Square Edge, T-Base Caster	54		30	29
	Team	TE-6030-AC-TF	Rectangle Workstation, 30" Depth	\$ 1,145	Acrylic Edge, T-Base Fixed	60		30	29
	Team	TE-6030-AC-TC	Rectangle Workstation, 30" Depth	\$ 1,350	Acrylic Edge, T-Base Caster	60		30	29
	Team	TE-6030-BN-TF	Rectangle Workstation, 30" Depth	\$ 1,385	Bullnose Edge, T-Base Fixed	60		30	29
	Team	TE-6030-BN-TC	Rectangle Workstation, 30" Depth	\$ 1,590	Bullnose Edge, T-Base Caster	60		30	29
	Team	TE-6030-SQ-TF	Rectangle Workstation, 30" Depth	\$ 1,300	Square Edge, T-Base Fixed	60		30	29
	Team	TE-6030-SQ-TC	Rectangle Workstation, 30" Depth	\$ 1,505	Square Edge, T-Base Caster	60		30	29
	Team	TE-7230-AC-TF	Rectangle Workstation, 30" Depth	\$ 1,320	Acrylic Edge, T-Base Fixed	72		30	29
	Team	TE-7230-AC-TC	Rectangle Workstation, 30" Depth	\$ 1,525	Acrylic Edge, T-Base Caster	72		30	29
	Team	TE-7230-BN-TF	Rectangle Workstation, 30" Depth	\$ 1,590	Bullnose Edge, T-Base Fixed	72		30	29
	Team	TE-7230-BN-TC	Rectangle Workstation, 30" Depth	\$ 1,800	Bullnose Edge, T-Base Caster	72		30	29
Team	TE-7230-SQ-TF	Rectangle Workstation, 30" Depth	\$ 1,495	Square Edge, T-Base Fixed	72		30	29	
Team	TE-7230-SQ-TC	Rectangle Workstation, 30" Depth	\$ 1,700	Square Edge, T-Base Caster	72		30	29	
	Team	TE-4236-AC-TF	Rectangle Workstation, 36" Depth	\$ 1,060	Acrylic Edge, T-Base Fixed	42		36	29
	Team	TE-4236-AC-TC	Rectangle Workstation, 36" Depth	\$ 1,300	Acrylic Edge, T-Base Caster	42		36	29
	Team	TE-4236-BN-TF	Rectangle Workstation, 36" Depth	\$ 1,300	Bullnose Edge, T-Base Fixed	42		36	29
	Team	TE-4236-BN-TC	Rectangle Workstation, 36" Depth	\$ 1,510	Bullnose Edge, T-Base Caster	42		36	29
	Team	TE-4236-SQ-TF	Rectangle Workstation, 36" Depth	\$ 1,230	Square Edge, T-Base Fixed	42		36	29
	Team	TE-4236-SQ-TC	Rectangle Workstation, 36" Depth	\$ 1,435	Square Edge, T-Base Caster	42		36	29
	Team	TE-4836-AC-TF	Rectangle Workstation, 36" Depth	\$ 1,140	Acrylic Edge, T-Base Fixed	48		36	29
	Team	TE-4836-AC-TC	Rectangle Workstation, 36" Depth	\$ 1,345	Acrylic Edge, T-Base Caster	48		36	29
	Team	TE-4836-BN-TF	Rectangle Workstation, 36" Depth	\$ 1,360	Bullnose Edge, T-Base Fixed	48		36	29
	Team	TE-4836-BN-TC	Rectangle Workstation, 36" Depth	\$ 1,565	Bullnose Edge, T-Base Caster	48		36	29
	Team	TE-4836-SQ-TF	Rectangle Workstation, 36" Depth	\$ 1,280	Square Edge, T-Base Fixed	48		36	29
	Team	TE-4836-SQ-TC	Rectangle Workstation, 36" Depth	\$ 1,485	Square Edge, T-Base Caster	48		36	29
	Team	TE-5436-AC-TF	Rectangle Workstation, 36" Depth	\$ 1,160	Acrylic Edge, T-Base Fixed	54		36	29
	Team	TE-5436-AC-TC	Rectangle Workstation, 36" Depth	\$ 1,365	Acrylic Edge, T-Base Caster	54		36	29
	Team	TE-5436-BN-TF	Rectangle Workstation, 36" Depth	\$ 1,400	Bullnose Edge, T-Base Fixed	54		36	29
	Team	TE-5436-BN-TC	Rectangle Workstation, 36" Depth	\$ 1,605	Bullnose Edge, T-Base Caster	54		36	29
	Team	TE-5436-SQ-TF	Rectangle Workstation, 36" Depth	\$ 1,315	Square Edge, T-Base Fixed	54		36	29
	Team	TE-5436-SQ-TC	Rectangle Workstation, 36" Depth	\$ 1,520	Square Edge, T-Base Caster	54		36	29
	Team	TE-6036-AC-TF	Rectangle Workstation, 36" Depth	\$ 1,190	Acrylic Edge, T-Base Fixed	60		36	29
	Team	TE-6036-AC-TC	Rectangle Workstation, 36" Depth	\$ 1,395	Acrylic Edge, T-Base Caster	60		36	29
Team	TE-6036-BN-TF	Rectangle Workstation, 36" Depth	\$ 1,445	Bullnose Edge, T-Base Fixed	60		36	29	
Team	TE-6036-BN-TC	Rectangle Workstation, 36" Depth	\$ 1,650	Bullnose Edge, T-Base Caster	60		36	29	
Team	TE-6036-SQ-TF	Rectangle Workstation, 36" Depth	\$ 1,355	Square Edge, T-Base Fixed	60		36	29	
Team	TE-6036-SQ-TC	Rectangle Workstation, 36" Depth	\$ 1,560	Square Edge, T-Base Caster	60		36	29	
Team	TE-7236-AC-TF	Rectangle Workstation, 36" Depth	\$ 1,360	Acrylic Edge, T-Base Fixed	72		36	29	
Team	TE-7236-AC-TC	Rectangle Workstation, 36" Depth	\$ 1,565	Acrylic Edge, T-Base Caster	72		36	29	
Team	TE-7236-BN-TF	Rectangle Workstation, 36" Depth	\$ 1,650	Bullnose Edge, T-Base Fixed	72		36	29	
Team	TE-7236-BN-TC	Rectangle Workstation, 36" Depth	\$ 1,855	Bullnose Edge, T-Base Caster	72		36	29	
Team	TE-7236-SQ-TF	Rectangle Workstation, 36" Depth	\$ 1,545	Square Edge, T-Base Fixed	72		36	29	
Team	TE-7236-SQ-TC	Rectangle Workstation, 36" Depth	\$ 1,750	Square Edge, T-Base Caster	72		36	29	
	Team	TE-PR-6036-AC-TF	Puzzle Right Workstation	\$ 1,190	Acrylic Edge, T-Base Fixed	60		36	29
	Team	TE-PR-6036-AC-TC	Puzzle Right Workstation	\$ 1,395	Acrylic Edge, T-Base Caster	60		36	29
	Team	TE-PR-6036-BN-TF	Puzzle Right Workstation	\$ 1,445	Bullnose Edge, T-Base Fixed	60		36	29
	Team	TE-PR-6036-BN-TC	Puzzle Right Workstation	\$ 1,650	Bullnose Edge, T-Base Caster	60		36	29
	Team	TE-PR-6036-SQ-TF	Puzzle Right Workstation	\$ 1,355	Square Edge, T-Base Fixed	60		36	29
	Team	TE-PR-6036-SQ-TC	Puzzle Right Workstation	\$ 1,560	Square Edge, T-Base Caster	60		36	29
	Team	TE-PR-7236-AC-TF	Puzzle Right Workstation	\$ 1,360	Acrylic Edge, T-Base Fixed	72		36	29

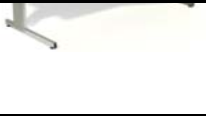

Image	Collection	Catalog Number	Item Description	List Price	Colour / Type	Width (Inches)	Length (Inches)	Depth (Inches)	Height (Inches)	
	Team	TE-PR-7236-AC-TC	Puzzle Right Workstation	\$ 1,565	Acrylic Edge, T-Base Caster	72		36	29	
	Team	TE-PR-7236-BN-TF	Puzzle Right Workstation	\$ 1,650	Bullnose Edge, T-Base Fixed	72		36	29	
	Team	TE-PR-7236-BN-TC	Puzzle Right Workstation	\$ 1,855	Bullnose Edge, T-Base Caster	72		36	29	
	Team	TE-PR-7236-SQ-TF	Puzzle Right Workstation	\$ 1,545	Square Edge, T-Base Fixed	72		36	29	
	Team	TE-PR-7236-SQ-TC	Puzzle Right Workstation	\$ 1,750	Square Edge, T-Base Caster	72		36	29	
	Team	TE-PL-6036-AC-TF	Puzzle Left Workstation	\$ 1,190	Acrylic Edge, T-Base Fixed	60		36	29	
	Team	TE-PL-6036-AC-TC	Puzzle Left Workstation	\$ 1,395	Acrylic Edge, T-Base Caster	60		36	29	
	Team	TE-PL-6036-BN-TF	Puzzle Left Workstation	\$ 1,445	Bullnose Edge, T-Base Fixed	60		36	29	
	Team	TE-PL-6036-BN-TC	Puzzle Left Workstation	\$ 1,650	Bullnose Edge, T-Base Caster	60		36	29	
	Team	TE-PL-6036-SQ-TF	Puzzle Left Workstation	\$ 1,355	Square Edge, T-Base Fixed	60		36	29	
	Team	TE-PL-6036-SQ-TC	Puzzle Left Workstation	\$ 1,560	Square Edge, T-Base Caster	60		36	29	
	Team	TE-PL-7236-AC-TF	Puzzle Left Workstation	\$ 1,360	Acrylic Edge, T-Base Fixed	72		36	29	
	Team	TE-PL-7236-AC-TC	Puzzle Left Workstation	\$ 1,565	Acrylic Edge, T-Base Caster	72		36	29	
	Team	TE-PL-7236-BN-TF	Puzzle Left Workstation	\$ 1,650	Bullnose Edge, T-Base Fixed	72		36	29	
	Team	TE-PL-7236-BN-TC	Puzzle Left Workstation	\$ 1,855	Bullnose Edge, T-Base Caster	72		36	29	
	Team	TE-PL-7236-SQ-TF	Puzzle Left Workstation	\$ 1,545	Square Edge, T-Base Fixed	72		36	29	
	Team	TE-PL-7236-SQ-TC	Puzzle Left Workstation	\$ 1,750	Square Edge, T-Base Caster	72		36	29	
		Team	TE-3030-AC-ST	Square Workstation Leg Base, 30"	\$ 685	Acrylic Edge, Straight Leg	30		30	29
		Team	TE-3030-AC-WC	Square Workstation Leg Base, 30"	\$ 980	Acrylic Edge, Wave Caster Leg	30		30	29
		Team	TE-3030-AC-WF	Square Workstation Leg Base, 30"	\$ 730	Acrylic Edge, Wave Fixed Leg	30		30	29
Team		TE-3030-BN-ST	Square Workstation Leg Base, 30"	\$ 845	Bullnose Edge, Straight Leg	30		30	29	
Team		TE-3030-BN-WC	Square Workstation Leg Base, 30"	\$ 1,140	Bullnose Edge, Wave Caster Leg	30		30	29	
Team		TE-3030-BN-WF	Square Workstation Leg Base, 30"	\$ 890	Bullnose Edge, Wave Fixed Leg	30		30	29	
Team		TE-3030-SQ-ST	Square Workstation Leg Base, 30"	\$ 785	Square Edge, Straight Leg	30		30	29	
Team		TE-3030-SQ-WC	Square Workstation Leg Base, 30"	\$ 1,085	Square Edge, Wave Caster Leg	30		30	29	
Team		TE-3030-SQ-WF	Square Workstation Leg Base, 30"	\$ 835	Square Edge, Wave Fixed Leg	30		30	29	
Team		TE-3636-AC-ST	Square Workstation Leg Base, 36"	\$ 710	Acrylic Edge, Straight Leg	36		36	29	
Team		TE-3636-AC-WC	Square Workstation Leg Base, 36"	\$ 1,005	Acrylic Edge, Wave Caster Leg	36		36	29	
Team		TE-3636-AC-WF	Square Workstation Leg Base, 36"	\$ 755	Acrylic Edge, Wave Fixed Leg	36		36	29	
Team		TE-3636-BN-ST	Square Workstation Leg Base, 36"	\$ 900	Bullnose Edge, Straight Leg	36		36	29	
Team		TE-3636-BN-WC	Square Workstation Leg Base, 36"	\$ 1,200	Bullnose Edge, Wave Caster Leg	36		36	29	
Team		TE-3636-BN-WF	Square Workstation Leg Base, 36"	\$ 950	Bullnose Edge, Wave Fixed Leg	36		36	29	
Team		TE-3636-SQ-ST	Square Workstation Leg Base, 36"	\$ 835	Square Edge, Straight Leg	36		36	29	
Team		TE-3636-SQ-WC	Square Workstation Leg Base, 36"	\$ 1,130	Square Edge, Wave Caster Leg	36		36	29	
Team		TE-3636-SQ-WF	Square Workstation Leg Base, 36"	\$ 880	Square Edge, Wave Fixed Leg	36		36	29	
Team		TE-3630-AC-ST	Rectangle Workstation Leg Base, 30"	\$ 735	Acrylic Edge, Straight Leg	36		30	29	
Team		TE-3630-AC-WC	Rectangle Workstation Leg Base, 30"	\$ 1,030	Acrylic Edge, Wave Caster Leg	36		30	29	
Team		TE-3630-AC-WF	Rectangle Workstation Leg Base, 30"	\$ 780	Acrylic Edge, Wave Fixed Leg	36		30	29	
Team		TE-3630-BN-ST	Rectangle Workstation Leg Base, 30"	\$ 910	Bullnose Edge, Straight Leg	36		30	29	
Team	TE-3630-BN-WC	Rectangle Workstation Leg Base, 30"	\$ 1,205	Bullnose Edge, Wave Caster Leg	36		30	29		
Team	TE-3630-BN-WF	Rectangle Workstation Leg Base, 30"	\$ 955	Bullnose Edge, Wave Fixed Leg	36		30	29		
Team	TE-3630-SQ-ST	Rectangle Workstation Leg Base, 30"	\$ 845	Square Edge, Straight Leg	36		30	29		
Team	TE-3630-SQ-WC	Rectangle Workstation Leg Base, 30"	\$ 1,140	Square Edge, Wave Caster Leg	36		30	29		
Team	TE-3630-SQ-WF	Rectangle Workstation Leg Base, 30"	\$ 890	Square Edge, Wave Fixed Leg	36		30	29		
Team	TE-4230-AC-ST	Rectangle Workstation Leg Base, 30"	\$ 750	Acrylic Edge, Straight Leg	42		30	29		
Team	TE-4230-AC-WC	Rectangle Workstation Leg Base, 30"	\$ 1,045	Acrylic Edge, Wave Caster Leg	42		30	29		
Team	TE-4230-AC-WF	Rectangle Workstation Leg Base, 30"	\$ 795	Acrylic Edge, Wave Fixed Leg	42		30	29		
Team	TE-4230-BN-ST	Rectangle Workstation Leg Base, 30"	\$ 940	Bullnose Edge, Straight Leg	42		30	29		
Team	TE-4230-BN-WC	Rectangle Workstation Leg Base, 30"	\$ 1,240	Bullnose Edge, Wave Caster Leg	42		30	29		
Team	TE-4230-BN-WF	Rectangle Workstation Leg Base, 30"	\$ 985	Bullnose Edge, Wave Fixed Leg	42		30	29		
Team	TE-4230-SQ-ST	Rectangle Workstation Leg Base, 30"	\$ 875	Square Edge, Straight Leg	42		30	29		
Team	TE-4230-SQ-WC	Rectangle Workstation Leg Base, 30"	\$ 1,170	Square Edge, Wave Caster Leg	42		30	29		
Team	TE-4230-SQ-WF	Rectangle Workstation Leg Base, 30"	\$ 920	Square Edge, Wave Fixed Leg	42		30	29		
Team	TE-4830-AC-ST	Rectangle Workstation Leg Base, 30"	\$ 770	Acrylic Edge, Straight Leg	48		30	29		

Image	Collection	Catalog Number	Item Description	List Price	Colour / Type	Width (Inches)	Length (Inches)	Depth (Inches)	Height (Inches)
	Team	TE-4830-AC-WC	Rectangle Workstation Leg Base, 30"	\$ 1,065	Acrylic Edge, Wave Caster Leg	48	30	29	
	Team	TE-4830-AC-WF	Rectangle Workstation Leg Base, 30"	\$ 815	Acrylic Edge, Wave Fixed Leg	48	30	29	
	Team	TE-4830-BN-ST	Rectangle Workstation Leg Base, 30"	\$ 975	Bullnose Edge, Straight Leg	48	30	29	
	Team	TE-4830-BN-WC	Rectangle Workstation Leg Base, 30"	\$ 1,270	Bullnose Edge, Wave Caster Leg	48	30	29	
	Team	TE-4830-BN-WF	Rectangle Workstation Leg Base, 30"	\$ 1,020	Bullnose Edge, Wave Fixed Leg	48	30	29	
	Team	TE-4830-SQ-ST	Rectangle Workstation Leg Base, 30"	\$ 900	Square Edge, Straight Leg	48	30	29	
	Team	TE-4830-SQ-WC	Rectangle Workstation Leg Base, 30"	\$ 1,200	Square Edge, Wave Caster Leg	48	30	29	
	Team	TE-4830-SQ-WF	Rectangle Workstation Leg Base, 30"	\$ 945	Square Edge, Wave Fixed Leg	48	30	29	
	Team	TE-5430-AC-ST	Rectangle Workstation Leg Base, 30"	\$ 785	Acrylic Edge, Straight Leg	54	30	29	
	Team	TE-5430-AC-WC	Rectangle Workstation Leg Base, 30"	\$ 1,080	Acrylic Edge, Wave Caster Leg	54	30	29	
	Team	TE-5430-AC-WF	Rectangle Workstation Leg Base, 30"	\$ 830	Acrylic Edge, Wave Fixed Leg	54	30	29	
	Team	TE-5430-BN-ST	Rectangle Workstation Leg Base, 30"	\$ 1,010	Bullnose Edge, Straight Leg	54	30	29	
	Team	TE-5430-BN-WC	Rectangle Workstation Leg Base, 30"	\$ 1,305	Bullnose Edge, Wave Caster Leg	54	30	29	
	Team	TE-5430-BN-WF	Rectangle Workstation Leg Base, 30"	\$ 1,055	Bullnose Edge, Wave Fixed Leg	54	30	29	
	Team	TE-5430-SQ-ST	Rectangle Workstation Leg Base, 30"	\$ 930	Square Edge, Straight Leg	54	30	29	
	Team	TE-5430-SQ-WC	Rectangle Workstation Leg Base, 30"	\$ 1,225	Square Edge, Wave Caster Leg	54	30	29	
	Team	TE-5430-SQ-WF	Rectangle Workstation Leg Base, 30"	\$ 975	Square Edge, Wave Fixed Leg	54	30	29	
	Team	TE-6030-AC-ST	Rectangle Workstation Leg Base, 30"	\$ 805	Acrylic Edge, Straight Leg	60	30	29	
	Team	TE-6030-AC-WC	Rectangle Workstation Leg Base, 30"	\$ 1,100	Acrylic Edge, Wave Caster Leg	60	30	29	
	Team	TE-6030-AC-WF	Rectangle Workstation Leg Base, 30"	\$ 850	Acrylic Edge, Wave Fixed Leg	60	30	29	
	Team	TE-6030-BN-ST	Rectangle Workstation Leg Base, 30"	\$ 1,045	Bullnose Edge, Straight Leg	60	30	29	
	Team	TE-6030-BN-WC	Rectangle Workstation Leg Base, 30"	\$ 1,340	Bullnose Edge, Wave Caster Leg	60	30	29	
	Team	TE-6030-BN-WF	Rectangle Workstation Leg Base, 30"	\$ 1,090	Bullnose Edge, Wave Fixed Leg	60	30	29	
	Team	TE-6030-SQ-ST	Rectangle Workstation Leg Base, 30"	\$ 960	Square Edge, Straight Leg	60	30	29	
	Team	TE-6030-SQ-WC	Rectangle Workstation Leg Base, 30"	\$ 1,255	Square Edge, Wave Caster Leg	60	30	29	
	Team	TE-6030-SQ-WF	Rectangle Workstation Leg Base, 30"	\$ 1,005	Square Edge, Wave Fixed Leg	60	30	29	
	Team	TE-7230-AC-ST	Rectangle Workstation Leg Base, 30"	\$ 840	Acrylic Edge, Straight Leg	72	30	29	
	Team	TE-7230-AC-WC	Rectangle Workstation Leg Base, 30"	\$ 1,135	Acrylic Edge, Wave Caster Leg	72	30	29	
	Team	TE-7230-AC-WF	Rectangle Workstation Leg Base, 30"	\$ 885	Acrylic Edge, Wave Fixed Leg	72	30	29	
	Team	TE-7230-BN-ST	Rectangle Workstation Leg Base, 30"	\$ 1,110	Bullnose Edge, Straight Leg	72	30	29	
	Team	TE-7230-BN-WC	Rectangle Workstation Leg Base, 30"	\$ 1,405	Bullnose Edge, Wave Caster Leg	72	30	29	
	Team	TE-7230-BN-WF	Rectangle Workstation Leg Base, 30"	\$ 1,155	Bullnose Edge, Wave Fixed Leg	72	30	29	
	Team	TE-7230-SQ-ST	Rectangle Workstation Leg Base, 30"	\$ 1,015	Square Edge, Straight Leg	72	30	29	
	Team	TE-7230-SQ-WC	Rectangle Workstation Leg Base, 30"	\$ 1,310	Square Edge, Wave Caster Leg	72	30	29	
	Team	TE-7230-SQ-WF	Rectangle Workstation Leg Base, 30"	\$ 1,060	Square Edge, Wave Fixed Leg	72	30	29	
	Team	TE-4236-AC-ST	Rectangle Workstation Leg Base, 36"	\$ 775	Acrylic Edge, Straight Leg	42	36	29	
	Team	TE-4236-AC-WC	Rectangle Workstation Leg Base, 36"	\$ 1,070	Acrylic Edge, Wave Caster Leg	42	36	29	
	Team	TE-4236-AC-WF	Rectangle Workstation Leg Base, 36"	\$ 820	Acrylic Edge, Wave Fixed Leg	42	36	29	
	Team	TE-4236-BN-ST	Rectangle Workstation Leg Base, 36"	\$ 985	Bullnose Edge, Straight Leg	42	36	29	
	Team	TE-4236-BN-WC	Rectangle Workstation Leg Base, 36"	\$ 1,280	Bullnose Edge, Wave Caster Leg	42	36	29	
	Team	TE-4236-BN-WF	Rectangle Workstation Leg Base, 36"	\$ 1,030	Bullnose Edge, Wave Fixed Leg	42	36	29	
	Team	TE-4236-SQ-ST	Rectangle Workstation Leg Base, 36"	\$ 910	Square Edge, Straight Leg	42	36	29	
Team	TE-4236-SQ-WC	Rectangle Workstation Leg Base, 36"	\$ 1,205	Square Edge, Wave Caster Leg	42	36	29		
Team	TE-4236-SQ-WF	Rectangle Workstation Leg Base, 36"	\$ 955	Square Edge, Wave Fixed Leg	42	36	29		
Team	TE-4836-AC-ST	Rectangle Workstation Leg Base, 36"	\$ 795	Acrylic Edge, Straight Leg	48	36	29		
Team	TE-4836-AC-WC	Rectangle Workstation Leg Base, 36"	\$ 1,095	Acrylic Edge, Wave Caster Leg	48	36	29		
Team	TE-4836-AC-WF	Rectangle Workstation Leg Base, 36"	\$ 845	Acrylic Edge, Wave Fixed Leg	48	36	29		
Team	TE-4836-BN-ST	Rectangle Workstation Leg Base, 36"	\$ 1,020	Bullnose Edge, Straight Leg	48	36	29		
Team	TE-4836-BN-WC	Rectangle Workstation Leg Base, 36"	\$ 1,315	Bullnose Edge, Wave Caster Leg	48	36	29		
Team	TE-4836-BN-WF	Rectangle Workstation Leg Base, 36"	\$ 1,065	Bullnose Edge, Wave Fixed Leg	48	36	29		
Team	TE-4836-SQ-ST	Rectangle Workstation Leg Base, 36"	\$ 940	Square Edge, Straight Leg	48	36	29		
Team	TE-4836-SQ-WC	Rectangle Workstation Leg Base, 36"	\$ 1,235	Square Edge, Wave Caster Leg	48	36	29		
Team	TE-4836-SQ-WF	Rectangle Workstation Leg Base, 36"	\$ 985	Square Edge, Wave Fixed Leg	48	36	29		
Team	TE-5436-AC-ST	Rectangle Workstation Leg Base, 36"	\$ 820	Acrylic Edge, Straight Leg	54	36	29		



Image	Collection	Catalog Number	Item Description	List Price	Colour / Type	Width (Inches)	Length (Inches)	Depth (Inches)	Height (Inches)
	Team	TE-5436-AC-WC	Rectangle Workstation Leg Base, 36"	\$ 1,115	Acrylic Edge, Wave Caster Leg	54		36	29
	Team	TE-5436-AC-WF	Rectangle Workstation Leg Base, 36"	\$ 865	Acrylic Edge, Wave Fixed Leg	54		36	29
	Team	TE-5436-BN-ST	Rectangle Workstation Leg Base, 36"	\$ 1,055	Bullnose Edge, Straight Leg	54		36	29
	Team	TE-5436-BN-WC	Rectangle Workstation Leg Base, 36"	\$ 1,355	Bullnose Edge, Wave Caster Leg	54		36	29
	Team	TE-5436-BN-WF	Rectangle Workstation Leg Base, 36"	\$ 1,105	Bullnose Edge, Wave Fixed Leg	54		36	29
	Team	TE-5436-SQ-ST	Rectangle Workstation Leg Base, 36"	\$ 970	Square Edge, Straight Leg	54		36	29
	Team	TE-5436-SQ-WC	Rectangle Workstation Leg Base, 36"	\$ 1,270	Square Edge, Wave Caster Leg	54		36	29
	Team	TE-5436-SQ-WF	Rectangle Workstation Leg Base, 36"	\$ 1,015	Square Edge, Wave Fixed Leg	54		36	29
	Team	TE-6036-AC-ST	Rectangle Workstation Leg Base, 36"	\$ 840	Acrylic Edge, Straight Leg	60		36	29
	Team	TE-6036-AC-WC	Rectangle Workstation Leg Base, 36"	\$ 1,135	Acrylic Edge, Wave Caster Leg	60		36	29
Team	TE-6036-AC-WF	Rectangle Workstation Leg Base, 36"	\$ 885	Acrylic Edge, Wave Fixed Leg	60		36	29	
Team	TE-6036-BN-ST	Rectangle Workstation Leg Base, 36"	\$ 1,095	Bullnose Edge, Straight Leg	60		36	29	
Team	TE-6036-BN-WC	Rectangle Workstation Leg Base, 36"	\$ 1,390	Bullnose Edge, Wave Caster Leg	60		36	29	
Team	TE-6036-BN-WF	Rectangle Workstation Leg Base, 36"	\$ 1,140	Bullnose Edge, Wave Fixed Leg	60		36	29	
Team	TE-6036-SQ-ST	Rectangle Workstation Leg Base, 36"	\$ 1,005	Square Edge, Straight Leg	60		36	29	
Team	TE-6036-SQ-WC	Rectangle Workstation Leg Base, 36"	\$ 1,300	Square Edge, Wave Caster Leg	60		36	29	
Team	TE-6036-SQ-WF	Rectangle Workstation Leg Base, 36"	\$ 1,050	Square Edge, Wave Fixed Leg	60		36	29	
Team	TE-7236-AC-ST	Rectangle Workstation Leg Base, 36"	\$ 880	Acrylic Edge, Straight Leg	72		36	29	
Team	TE-7236-AC-WC	Rectangle Workstation Leg Base, 36"	\$ 1,175	Acrylic Edge, Wave Caster Leg	72		36	29	
Team	TE-7236-AC-WF	Rectangle Workstation Leg Base, 36"	\$ 925	Acrylic Edge, Wave Fixed Leg	72		36	29	
Team	TE-7236-BN-ST	Rectangle Workstation Leg Base, 36"	\$ 1,170	Bullnose Edge, Straight Leg	72		36	29	
Team	TE-7236-BN-WC	Rectangle Workstation Leg Base, 36"	\$ 1,465	Bullnose Edge, Wave Caster Leg	72		36	29	
Team	TE-7236-BN-WF	Rectangle Workstation Leg Base, 36"	\$ 1,215	Bullnose Edge, Wave Fixed Leg	72		36	29	
Team	TE-7236-SQ-ST	Rectangle Workstation Leg Base, 36"	\$ 1,065	Square Edge, Straight Leg	72		36	29	
Team	TE-7236-SQ-WC	Rectangle Workstation Leg Base, 36"	\$ 1,360	Square Edge, Wave Caster Leg	72		36	29	
Team	TE-7236-SQ-WF	Rectangle Workstation Leg Base, 36"	\$ 1,110	Square Edge, Wave Fixed Leg	72		36	29	
	Team	TE-PR-6036-AC-ST	Puzzle Right Workstation Leg Base	\$ 840	Acrylic Edge, Straight Leg	60		36	29
	Team	TE-PR-6036-AC-WC	Puzzle Right Workstation Leg Base	\$ 1,135	Acrylic Edge, Wave Caster Leg	60		36	29
	Team	TE-PR-6036-AC-WF	Puzzle Right Workstation Leg Base	\$ 1,020	Acrylic Edge, Wave Fixed Leg	60		36	29
	Team	TE-PR-6036-BN-ST	Puzzle Right Workstation Leg Base	\$ 1,085	Bullnose Edge, Straight Leg	60		36	29
	Team	TE-PR-6036-BN-WC	Puzzle Right Workstation Leg Base	\$ 1,380	Bullnose Edge, Wave Caster Leg	60		36	29
	Team	TE-PR-6036-BN-WF	Puzzle Right Workstation Leg Base	\$ 1,130	Bullnose Edge, Wave Fixed Leg	60		36	29
	Team	TE-PR-6036-SQ-ST	Puzzle Right Workstation Leg Base	\$ 995	Square Edge, Straight Leg	60		36	29
	Team	TE-PR-6036-SQ-WC	Puzzle Right Workstation Leg Base	\$ 1,295	Square Edge, Wave Caster Leg	60		36	29
	Team	TE-PR-6036-SQ-WF	Puzzle Right Workstation Leg Base	\$ 980	Square Edge, Wave Fixed Leg	60		36	29
	Team	TE-PR-7236-AC-ST	Puzzle Right Workstation Leg Base	\$ 880	Acrylic Edge, Straight Leg	72		36	29
	Team	TE-PR-7236-AC-WC	Puzzle Right Workstation Leg Base	\$ 1,175	Acrylic Edge, Wave Caster Leg	72		36	29
	Team	TE-PR-7236-AC-WF	Puzzle Right Workstation Leg Base	\$ 925	Acrylic Edge, Wave Fixed Leg	72		36	29
	Team	TE-PR-7236-BN-ST	Puzzle Right Workstation Leg Base	\$ 1,160	Bullnose Edge, Straight Leg	72		36	29
	Team	TE-PR-7236-BN-WC	Puzzle Right Workstation Leg Base	\$ 1,455	Bullnose Edge, Wave Caster Leg	72		36	29
	Team	TE-PR-7236-BN-WF	Puzzle Right Workstation Leg Base	\$ 1,205	Bullnose Edge, Wave Fixed Leg	72		36	29
	Team	TE-PR-7236-SQ-ST	Puzzle Right Workstation Leg Base	\$ 1,060	Square Edge, Straight Leg	72		36	29
	Team	TE-PR-7236-SQ-WC	Puzzle Right Workstation Leg Base	\$ 1,355	Square Edge, Wave Caster Leg	72		36	29
	Team	TE-PR-7236-SQ-WF	Puzzle Right Workstation Leg Base	\$ 1,105	Square Edge, Wave Fixed Leg	72		36	29
	Team	TE-PL-6036-AC-ST	Puzzle Left Workstation Leg Base	\$ 840	Acrylic Edge, Straight Leg	60		36	29
	Team	TE-PL-6036-AC-WC	Puzzle Left Workstation Leg Base	\$ 1,135	Acrylic Edge, Wave Caster Leg	60		36	29
Team	TE-PL-6036-AC-WF	Puzzle Left Workstation Leg Base	\$ 1,020	Acrylic Edge, Wave Fixed Leg	60		36	29	







Image	Collection	Catalog Number	Item Description	List Price	Colour / Type	Width (Inches)	Length (Inches)	Depth (Inches)	Height (Inches)
	Team	TE-PL-6036-BN-ST	Puzzle Left Workstation Leg Base	\$ 1,085	Bullnose Edge, Straight Leg	60		36	29
	Team	TE-PL-6036-BN-WC	Puzzle Left Workstation Leg Base	\$ 1,380	Bullnose Edge, Wave Caster Leg	60		36	29
	Team	TE-PL-6036-BN-WF	Puzzle Left Workstation Leg Base	\$ 1,130	Bullnose Edge, Wave Fixed Leg	60		36	29
	Team	TE-PL-6036-SQ-ST	Puzzle Left Workstation Leg Base	\$ 995	Square Edge, Straight Leg	60		36	29
	Team	TE-PL-6036-SQ-WC	Puzzle Left Workstation Leg Base	\$ 1,295	Square Edge, Wave Caster Leg	60		36	29
	Team	TE-PL-6036-SQ-WF	Puzzle Left Workstation Leg Base	\$ 980	Square Edge, Wave Fixed Leg	60		36	29
	Team	TE-PL-7236-AC-ST	Puzzle Left Workstation Leg Base	\$ 880	Acrylic Edge, Straight Leg	72		36	29
	Team	TE-PL-7236-AC-WC	Puzzle Left Workstation Leg Base	\$ 1,175	Acrylic Edge, Wave Caster Leg	72		36	29
	Team	TE-PL-7236-AC-WF	Puzzle Left Workstation Leg Base	\$ 925	Acrylic Edge, Wave Fixed Leg	72		36	29
	Team	TE-PL-7236-BN-ST	Puzzle Left Workstation Leg Base	\$ 1,160	Bullnose Edge, Straight Leg	72		36	29
	Team	TE-PL-7236-BN-WC	Puzzle Left Workstation Leg Base	\$ 1,455	Bullnose Edge, Wave Caster Leg	72		36	29
	Team	TE-PL-7236-BN-WF	Puzzle Left Workstation Leg Base	\$ 1,205	Bullnose Edge, Wave Fixed Leg	72		36	29
	Team	TE-PL-7236-SQ-ST	Puzzle Left Workstation Leg Base	\$ 1,060	Square Edge, Straight Leg	72		36	29
	Team	TE-PL-7236-SQ-WC	Puzzle Left Workstation Leg Base	\$ 1,355	Square Edge, Wave Caster Leg	72		36	29
	Team	TE-PL-7236-SQ-WF	Puzzle Left Workstation Leg Base	\$ 1,105	Square Edge, Wave Fixed Leg	72		36	29
	Team	TE-PDL-BBF-6030-AC-WC	Pedestal Left Desk w Box/Box/File	\$ 2,825	Acrylic Edge, Wave Caster Leg	60		30	29
	Team	TE-PDL-BBF-6030-BN-WC	Pedestal Left Desk w Box/Box/File	\$ 3,065	Bullnose Edge, Wave Caster Leg	60		30	29
	Team	TE-PDL-BBF-6030-SQ-WC	Pedestal Left Desk w Box/Box/File	\$ 2,980	Square Edge, Wave Caster Leg	60		30	29
	Team	TE-PDL-BBF-7230-AC-WC	Pedestal Left Desk w Box/Box/File	\$ 2,865	Acrylic Edge, Wave Caster Leg	72		30	29
	Team	TE-PDL-BBF-7230-BN-WC	Pedestal Left Desk w Box/Box/File	\$ 3,135	Bullnose Edge, Wave Caster Leg	72		30	29
	Team	TE-PDL-BBF-7230-SQ-WC	Pedestal Left Desk w Box/Box/File	\$ 3,035	Square Edge, Wave Caster Leg	72		30	29
	Team	TE-PDR-BBF-6030-AC-WC	Pedestal Right Desk w Box/Box/File	\$ 2,825	Acrylic Edge, Wave Caster Leg	60		30	29
	Team	TE-PDR-BBF-6030-BN-WC	Pedestal Right Desk w Box/Box/File	\$ 3,065	Bullnose Edge, Wave Caster Leg	60		30	29
	Team	TE-PDR-BBF-6030-SQ-WC	Pedestal Right Desk w Box/Box/File	\$ 2,980	Square Edge, Wave Caster Leg	60		30	29
	Team	TE-PDR-BBF-7230-AC-WC	Pedestal Right Desk w Box/Box/File	\$ 2,865	Acrylic Edge, Wave Caster Leg	72		30	29
	Team	TE-PDR-BBF-7230-BN-WC	Pedestal Right Desk w Box/Box/File	\$ 3,135	Bullnose Edge, Wave Caster Leg	72		30	29
	Team	TE-PDR-BBF-7230-SQ-WC	Pedestal Right Desk w Box/Box/File	\$ 3,035	Square Edge, Wave Caster Leg	72		30	29
	Team	TE-PDL-FF-6030-AC-WC	Pedestal Left Desk w File/File	\$ 2,820	Acrylic Edge, Wave Caster Leg	60		30	29
	Team	TE-PDL-FF-6030-BN-WC	Pedestal Left Desk w File/File	\$ 3,060	Bullnose Edge, Wave Caster Leg	60		30	29
	Team	TE-PDL-FF-6030-SQ-WC	Pedestal Left Desk w File/File	\$ 2,975	Square Edge, Wave Caster Leg	60		30	29
	Team	TE-PDL-FF-7230-AC-WC	Pedestal Left Desk w File/File	\$ 2,855	Acrylic Edge, Wave Caster Leg	72		30	29
	Team	TE-PDL-FF-7230-BN-WC	Pedestal Left Desk w File/File	\$ 3,130	Bullnose Edge, Wave Caster Leg	72		30	29
	Team	TE-PDL-FF-7230-SQ-WC	Pedestal Left Desk w File/File	\$ 3,030	Square Edge, Wave Caster Leg	72		30	29
	Team	TE-PDR-FF-6030-AC-WC	Pedestal Right Desk w File/File	\$ 2,820	Acrylic Edge, Wave Caster Leg	60		30	29
	Team	TE-PDR-FF-6030-BN-WC	Pedestal Right Desk w File/File	\$ 3,060	Bullnose Edge, Wave Caster Leg	60		30	29
	Team	TE-PDR-FF-6030-SQ-WC	Pedestal Right Desk w File/File	\$ 2,975	Square Edge, Wave Caster Leg	60		30	29
	Team	TE-PDR-FF-7230-AC-WC	Pedestal Right Desk w File/File	\$ 2,855	Acrylic Edge, Wave Caster Leg	72		30	29
	Team	TE-PDR-FF-7230-BN-WC	Pedestal Right Desk w File/File	\$ 3,130	Bullnose Edge, Wave Caster Leg	72		30	29
	Team	TE-PDR-FF-7230-SQ-WC	Pedestal Right Desk w File/File	\$ 3,030	Square Edge, Wave Caster Leg	72		30	29
	Team	TE-FXB-7230-AC-WC	Pedestal Desk w File/File & Box/Box/File	\$ 4,695	Acrylic Edge	72		30	29
	Team	TE-FXB-7230-BN-WC	Pedestal Desk w File/File & Box/Box/File	\$ 4,965	Bullnose Edge	72		30	29
	Team	TE-FXB-7230-SQ-WC	Pedestal Desk w File/File & Box/Box/File	\$ 4,870	Square Edge	72		30	29
	Team	TE-D-BBF-7230-AC-WC	Pedestal Desk w Double Box/Box/File	\$ 4,700	Acrylic Edge	72		30	29
	Team	TE-D-BBF-7230-BN-WC	Pedestal Desk w Double Box/Box/File	\$ 4,975	Bullnose Edge	72		30	29



Image	Collection	Catalog Number	Item Description	List Price	Colour / Type	Width (Inches)	Length (Inches)	Depth (Inches)	Height (Inches)
	Team	TE-D-BBF-7230-SQ-WC	Pedestal Desk w Double Box/Box/File	\$ 4,875	Square Edge	72		30	29
	Team Mobile Storage	TE-MS-AV-30	Audio Visual Cart w 2 Adjustable Shelves	\$ 1,890		36		18	30
	Team Mobile Storage	TE-MS-AV-30-LD	Audio Visual Cart w 2 Adjustable Shelves, Locking Doors	\$ 2,020		36		18	30
	Team Mobile Storage	TE-MS-WR-60	Wardrobe w Locking Cupboard & File, 4 Adjustable Shelves	\$ 2,255		36		24	60
	Team Mobile Storage	TE-MS-WR-72	Wardrobe w Locking Cupboard & 2 File, 3 Adjustable Shelves	\$ 2,460		36		24	72
	Team Mobile Storage	TE-MS-SU-30-A	Support Unit w Locking Box/File, 2 Adjustable Shelves, Acrylic Screen	\$ 2,340		36		24	30
	Team Mobile Storage	TE-MS-SU-30-B	Support Unit w Locking Box/File, 2 Pencil, Open Cubbie, Acrylic Screen	\$ 2,440		36		24	30
	Team Mobile Storage	TE-MS-S-28	Unit w 2 Adjustable Shelves	\$ 1,265		18		24	28
	Team Mobile Storage	TE-MS-CB-28	Unit w 2 Adjustable Shelves, Locking Door	\$ 1,590		18		24	28







Image	Collection	Catalog Number	Item Description	List Price	Colour / Type	Width (Inches)	Length (Inches)	Depth (Inches)	Height (Inches)
	Team Mobile Storage	TE-MS-BBF-28	Unit w Locking Pencil/Box/File	\$ 2,100		18		24	28
	Team Mobile Storage	TE-MS-FF-28	Unit w Locking 2 File	\$ 2,095		18		24	28
	Wave	WC-SS-36MC-AC	Starter Carrel, 36"	\$ 2,460	Acrylic Edge	38		32	29
	Wave	WC-SS-36MC-BN	Starter Carrel, 36"	\$ 2,780	Bullnose Edge	38		32	29
	Wave	WC-SS-36MC-MP	Starter Carrel, 36"	\$ 2,405	Multi-Ply Edge	38		32	29
	Wave	WC-SS-48MC-AC	Starter Carrel, 48"	\$ 2,620	Acrylic Edge	50		32	29
	Wave	WC-SS-48MC-BN	Starter Carrel, 48"	\$ 2,945	Bullnose Edge	50		32	29
	Wave	WC-SS-48MC-MP	Starter Carrel, 48"	\$ 2,570	Multi-Ply Edge	50		32	29
	Wave	WC-SA-36MC-AC	Add-On Carrel, 36"	\$ 2,150	Acrylic Edge	36.5		32	29
	Wave	WC-SA-36MC-BN	Add-On Carrel, 36"	\$ 2,470	Bullnose Edge	36.5		32	29
	Wave	WC-SA-36MC-MP	Add-On Carrel, 36"	\$ 2,095	Multi-Ply Edge	36.5		32	29
	Wave	WC-SA-48MC-AC	Add-On Carrel, 48"	\$ 2,310	Acrylic Edge	48.5		32	29
	Wave	WC-SA-48MC-BN	Add-On Carrel, 48"	\$ 2,635	Bullnose Edge	48.5		32	29
	Wave	WC-SA-48MC-MP	Add-On Carrel, 48"	\$ 2,260	Multi-Ply Edge	48.5		32	29
	Wave	WC-36W2-AC	Workstations, 2 Side by Side, 36" Width Carrels	\$ 4,610	Acrylic Edge	74		32	29
	Wave	WC-36W2-BN	Workstations, 2 Side by Side, 36" Width Carrels	\$ 5,250	Bullnose Edge	74		32	29
	Wave	WC-36W2-MP	Workstations, 2 Side by Side, 36" Width Carrels	\$ 4,500	Multi-Ply Edge	74		32	29
	Wave	WC-48W2-AC	Workstations, 2 Side by Side, 48" Width Carrels	\$ 4,930	Acrylic Edge	98		32	29
	Wave	WC-48W2-BN	Workstations, 2 Side by Side, 48" Width Carrels	\$ 5,580	Bullnose Edge	98		32	29
	Wave	WC-48W2-MP	Workstations, 2 Side by Side, 48" Width Carrels	\$ 4,830	Multi-Ply Edge	98		32	29
	Wave	WC-36W3-AC	Workstations, 3 Side by Side, 36" Width Carrels	\$ 6,760	Acrylic Edge	110.5		32	29
	Wave	WC-36W3-BN	Workstations, 3 Side by Side, 36" Width Carrels	\$ 7,720	Bullnose Edge	110.5		32	29
	Wave	WC-36W3-MP	Workstations, 3 Side by Side, 36" Width Carrels	\$ 6,595	Multi-Ply Edge	110.5		32	29
	Wave	WC-48W3-AC	Workstations, 3 Side by Side, 48" Width Carrels	\$ 7,240	Acrylic Edge	146.5		32	29
	Wave	WC-48W3-BN	Workstations, 3 Side by Side, 48" Width Carrels	\$ 8,215	Bullnose Edge	146.5		32	29
	Wave	WC-48W3-MP	Workstations, 3 Side by Side, 48" Width Carrels	\$ 7,090	Multi-Ply Edge	146.5		32	29
	Wave	WC-36W4-AC	Workstations, 4 Side by Side, 36" Width Carrels	\$ 8,910	Acrylic Edge	147		32	29
	Wave	WC-36W4-BN	Workstations, 4 Side by Side, 36" Width Carrels	\$ 10,190	Bullnose Edge	147		32	29
	Wave	WC-36W4-MP	Workstations, 4 Side by Side, 36" Width Carrels	\$ 8,690	Multi-Ply Edge	147		32	29
	Wave	WC-48W4-AC	Workstations, 4 Side by Side, 48" Width Carrels	\$ 9,550	Acrylic Edge	195		32	29
	Wave	WC-48W4-BN	Workstations, 4 Side by Side, 48" Width Carrels	\$ 10,850	Bullnose Edge	195		32	29
	Wave	WC-48W4-MP	Workstations, 4 Side by Side, 48" Width Carrels	\$ 9,350	Multi-Ply Edge	195		32	29
	Wave	WC-36W5-AC	Workstations, 5 Side by Side, 36" Width Carrels	\$ 11,060	Acrylic Edge	183.5		32	29
	Wave	WC-36W5-BN	Workstations, 5 Side by Side, 36" Width Carrels	\$ 12,660	Bullnose Edge	183.5		32	29
	Wave	WC-36W5-MP	Workstations, 5 Side by Side, 36" Width Carrels	\$ 10,785	Multi-Ply Edge	183.5		32	29
	Wave	WC-48W5-AC	Workstations, 5 Side by Side, 48" Width Carrels	\$ 11,860	Acrylic Edge	243.5		32	29
	Wave	WC-48W5-BN	Workstations, 5 Side by Side, 48" Width Carrels	\$ 13,485	Bullnose Edge	243.5		32	29
	Wave	WC-48W5-MP	Workstations, 5 Side by Side, 48" Width Carrels	\$ 11,610	Multi-Ply Edge	243.5		32	29
	Wave II	WC2-SS-36MC-AC	Starter Carrel, 36"	\$ 2,230	Acrylic Edge	38		32	29









Image	Collection	Catalog Number	Item Description	List Price	Colour / Type	Width (Inches)	Length (Inches)	Depth (Inches)	Height (Inches)
	Wave II	WC2-SS-36MC-BN	Starter Carrel, 36"	\$ 2,555	Bullnose Edge	38		32	29
	Wave II	WC2-SS-36MC-MP	Starter Carrel, 36"	\$ 2,180	Multi-Ply Edge	38		32	29
	Wave II	WC2-SS-48MC-AC	Starter Carrel, 48"	\$ 2,395	Acrylic Edge	50		32	29
	Wave II	WC2-SS-48MC-BN	Starter Carrel, 48"	\$ 2,715	Bullnose Edge	50		32	29
	Wave II	WC2-SS-48MC-MP	Starter Carrel, 48"	\$ 2,340	Multi-Ply Edge	50		32	29
	Wave II	WC2-SA-36MC-AC	Add-On Carrel, 36"	\$ 1,940	Acrylic Edge	36.5		32	29
	Wave II	WC2-SA-36MC-BN	Add-On Carrel, 36"	\$ 2,405	Bullnose Edge	36.5		32	29
	Wave II	WC2-SA-36MC-MP	Add-On Carrel, 36"	\$ 1,785	Multi-Ply Edge	36.5		32	29
	Wave II	WC2-SA-48MC-AC	Add-On Carrel, 48"	\$ 2,100	Acrylic Edge	48.5		32	29
	Wave II	WC2-SA-48MC-BN	Add-On Carrel, 48"	\$ 2,565	Bullnose Edge	48.5		32	29
Wave II	WC2-SA-48MC-MP	Add-On Carrel, 48"	\$ 2,050	Multi-Ply Edge	48.5		32	29	
	Wave II	WC2-36W2-AC	Workstations, 2 Side by Side, 36" Width Carrels	\$ 4,170	Acrylic Edge	74		32	29
	Wave II	WC2-36W2-BN	Workstations, 2 Side by Side, 36" Width Carrels	\$ 4,960	Bullnose Edge	74		32	29
	Wave II	WC2-36W2-MP	Workstations, 2 Side by Side, 36" Width Carrels	\$ 3,965	Multi-Ply Edge	74		32	29
	Wave II	WC2-48W2-AC	Workstations, 2 Side by Side, 48" Width Carrels	\$ 4,495	Acrylic Edge	98		32	29
	Wave II	WC2-48W2-BN	Workstations, 2 Side by Side, 48" Width Carrels	\$ 5,280	Bullnose Edge	98		32	29
Wave II	WC2-48W2-MP	Workstations, 2 Side by Side, 48" Width Carrels	\$ 4,390	Multi-Ply Edge	98		32	29	
	Wave II	WC2-36W3-AC	Workstations, 3 Side by Side, 36" Width Carrels	\$ 6,110	Acrylic Edge	110.5		32	29
	Wave II	WC2-36W3-BN	Workstations, 3 Side by Side, 36" Width Carrels	\$ 7,365	Bullnose Edge	110.5		32	29
	Wave II	WC2-36W3-MP	Workstations, 3 Side by Side, 36" Width Carrels	\$ 5,750	Multi-Ply Edge	110.5		32	29
	Wave II	WC2-48W3-AC	Workstations, 3 Side by Side, 48" Width Carrels	\$ 6,595	Acrylic Edge	146.5		32	29
	Wave II	WC2-48W3-BN	Workstations, 3 Side by Side, 48" Width Carrels	\$ 7,845	Bullnose Edge	146.5		32	29
Wave II	WC2-48W3-MP	Workstations, 3 Side by Side, 48" Width Carrels	\$ 6,440	Multi-Ply Edge	146.5		32	29	
	Wave II	WC2-36W4-AC	Workstations, 4 Side by Side, 36" Width Carrels	\$ 8,050	Acrylic Edge	147		32	29
	Wave II	WC2-36W4-BN	Workstations, 4 Side by Side, 36" Width Carrels	\$ 9,770	Bullnose Edge	147		32	29
	Wave II	WC2-36W4-MP	Workstations, 4 Side by Side, 36" Width Carrels	\$ 7,535	Multi-Ply Edge	147		32	29
	Wave II	WC2-48W4-AC	Workstations, 4 Side by Side, 48" Width Carrels	\$ 8,695	Acrylic Edge	195		32	29
	Wave II	WC2-48W4-BN	Workstations, 4 Side by Side, 48" Width Carrels	\$ 10,410	Bullnose Edge	195		32	29
Wave II	WC2-48W4-MP	Workstations, 4 Side by Side, 48" Width Carrels	\$ 8,490	Multi-Ply Edge	195		32	29	
	Wave II	WC2-36W5-AC	Workstations, 5 Side by Side, 36" Width Carrels	\$ 9,990	Acrylic Edge	183.5		32	29
	Wave II	WC2-36W5-BN	Workstations, 5 Side by Side, 36" Width Carrels	\$ 12,175	Bullnose Edge	183.5		32	29
	Wave II	WC2-36W5-MP	Workstations, 5 Side by Side, 36" Width Carrels	\$ 9,320	Multi-Ply Edge	183.5		32	29
	Wave II	WC2-48W5-AC	Workstations, 5 Side by Side, 48" Width Carrels	\$ 10,795	Acrylic Edge	243.5		32	29
	Wave II	WC2-48W5-BN	Workstations, 5 Side by Side, 48" Width Carrels	\$ 12,975	Bullnose Edge	243.5		32	29
Wave II	WC2-48W5-MP	Workstations, 5 Side by Side, 48" Width Carrels	\$ 10,540	Multi-Ply Edge	243.5		32	29	
	Wave III	WC3-SS-36MC-AC	Starter Carrel, 36"	\$ 1,525	Acrylic Edge	38		27.75	29
	Wave III	WC3-SS-36MC-BN	Starter Carrel, 36"	\$ 1,845	Bullnose Edge	38		27.75	29
	Wave III	WC3-SS-36MC-MP	Starter Carrel, 36"	\$ 1,470	Multi-Ply Edge	38		27.75	29
	Wave III	WC3-SS-48MC-AC	Starter Carrel, 48"	\$ 1,685	Acrylic Edge	50		27.75	29
	Wave III	WC3-SS-48MC-BN	Starter Carrel, 48"	\$ 2,010	Bullnose Edge	50		27.75	29
Wave III	WC3-SS-48MC-MP	Starter Carrel, 48"	\$ 1,635	Multi-Ply Edge	50		27.75	29	
	Wave III	WC3-SA-36MC-AC	Add-On Carrel, 36"	\$ 1,230	Acrylic Edge	36.5		27.75	29
	Wave III	WC3-SA-36MC-BN	Add-On Carrel, 36"	\$ 1,695	Bullnose Edge	36.5		27.75	29
	Wave III	WC3-SA-36MC-MP	Add-On Carrel, 36"	\$ 1,180	Multi-Ply Edge	36.5		27.75	29
	Wave III	WC3-SA-48MC-AC	Add-On Carrel, 48"	\$ 1,395	Acrylic Edge	48.5		27.75	29
	Wave III	WC3-SA-48MC-BN	Add-On Carrel, 48"	\$ 1,860	Bullnose Edge	48.5		27.75	29
Wave III	WC3-SA-48MC-MP	Add-On Carrel, 48"	\$ 1,340	Multi-Ply Edge	48.5		27.75	29	
Wave III	WC3-36W2-AC	Workstations, 2 Side by Side, 36" Width Carrels	\$ 2,755	Acrylic Edge	74		27.75	29	









Image	Collection	Catalog Number	Item Description	List Price	Colour / Type	Width (Inches)	Length (Inches)	Depth (Inches)	Height (Inches)	
	Wave III	WC3-36W2-BN	Workstations, 2 Side by Side, 36" Width Carrels	\$ 3,540	Bullnose Edge	74		27.75	29	
	Wave III	WC3-36W2-MP	Workstations, 2 Side by Side, 36" Width Carrels	\$ 2,650	Multi-Ply Edge	74		27.75	29	
	Wave III	WC3-48W2-AC	Workstations, 2 Side by Side, 48" Width Carrels	\$ 3,080	Acrylic Edge	98		27.75	29	
	Wave III	WC3-48W2-BN	Workstations, 2 Side by Side, 48" Width Carrels	\$ 3,870	Bullnose Edge	98		27.75	29	
	Wave III	WC3-48W2-MP	Workstations, 2 Side by Side, 48" Width Carrels	\$ 2,975	Multi-Ply Edge	98		27.75	29	
	Wave III	WC3-36W3-AC	Workstations, 3 Side by Side, 36" Width Carrels	\$ 3,985	Acrylic Edge	110.5		27.75	29	
	Wave III	WC3-36W3-BN	Workstations, 3 Side by Side, 36" Width Carrels	\$ 5,235	Bullnose Edge	110.5		27.75	29	
	Wave III	WC3-36W3-MP	Workstations, 3 Side by Side, 36" Width Carrels	\$ 3,830	Multi-Ply Edge	110.5		27.75	29	
	Wave III	WC3-48W3-AC	Workstations, 3 Side by Side, 48" Width Carrels	\$ 4,475	Acrylic Edge	146.5		27.75	29	
	Wave III	WC3-48W3-BN	Workstations, 3 Side by Side, 48" Width Carrels	\$ 5,730	Bullnose Edge	146.5		27.75	29	
	Wave III	WC3-48W3-MP	Workstations, 3 Side by Side, 48" Width Carrels	\$ 4,315	Multi-Ply Edge	146.5		27.75	29	
	Wave III	WC3-36W4-AC	Workstations, 4 Side by Side, 36" Width Carrels	\$ 5,215	Acrylic Edge	147		27.75	29	
	Wave III	WC3-36W4-BN	Workstations, 4 Side by Side, 36" Width Carrels	\$ 6,930	Bullnose Edge	147		27.75	29	
	Wave III	WC3-36W4-MP	Workstations, 4 Side by Side, 36" Width Carrels	\$ 5,010	Multi-Ply Edge	147		27.75	29	
	Wave III	WC3-48W4-AC	Workstations, 4 Side by Side, 48" Width Carrels	\$ 5,870	Acrylic Edge	195		27.75	29	
	Wave III	WC3-48W4-BN	Workstations, 4 Side by Side, 48" Width Carrels	\$ 7,590	Bullnose Edge	195		27.75	29	
	Wave III	WC3-48W4-MP	Workstations, 4 Side by Side, 48" Width Carrels	\$ 5,655	Multi-Ply Edge	195		27.75	29	
	Wave III	WC3-36W5-AC	Workstations, 5 Side by Side, 36" Width Carrels	\$ 6,445	Acrylic Edge	183.5		27.75	29	
	Wave III	WC3-36W5-BN	Workstations, 5 Side by Side, 36" Width Carrels	\$ 8,625	Bullnose Edge	183.5		27.75	29	
	Wave III	WC3-36W5-MP	Workstations, 5 Side by Side, 36" Width Carrels	\$ 6,190	Multi-Ply Edge	183.5		27.75	29	
	Wave III	WC3-48W5-AC	Workstations, 5 Side by Side, 48" Width Carrels	\$ 7,265	Acrylic Edge	243.5		27.75	29	
	Wave III	WC3-48W5-BN	Workstations, 5 Side by Side, 48" Width Carrels	\$ 9,450	Bullnose Edge	243.5		27.75	29	
	Wave III	WC3-48W5-MP	Workstations, 5 Side by Side, 48" Width Carrels	\$ 6,995	Multi-Ply Edge	243.5		27.75	29	
		Wave Accessories	WC-CS-FS	Frosted Acrylic Courtesy Shelf	\$ 270		16		9	0.5
		Wave Accessories	WC-CS-FS-1	Frosted Glass Courtesy Shelf	\$ 310		16		9	0.5
Wave Accessories		WC-CS-OAK	Wood Courtesy Shelf, Oak	\$ 255		16		9	0.5	
Wave Accessories		WC-CS-MAPLE	Wood Courtesy Shelf, Maple	\$ 255		16		9	0.5	
	Wave Accessories	WC-PE	Pole Extension **Needed for Wave II & III Only**	\$ 190		16		9	0.5	
	Wave Option	WC-WB038-OAK	Wood Back 1/2", 34.5 Width, Oak	\$ 345		34.5		0.5	36	
	Wave Option	WC-WB038-MAPLE	Wood Back 1/2", 34.5 Width, Maple	\$ 345		34.5		0.5	36	
	Wave Option	WC-WB050-OAK	Wood Back 1/2", 46.5 Width, Oak	\$ 360		46.5		0.5	36	

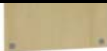







Image	Collection	Catalog Number	Item Description	List Price	Colour / Type	Width (Inches)	Length (Inches)	Depth (Inches)	Height (Inches)
	Wave Option	WC-WB050-MAPLE	Wood Back 1/2", 46.5 Width, Maple	\$ 360		46.5		0.5	36
	Wave II	WC2-CA36-AC	Configuration A: 2 Workstations, Back to Back, 36" Carrels	\$ 3,475	Acrylic Edge	38		62	29
	Wave II	WC2-CA36-BN	Configuration A: 2 Workstations, Back to Back, 36" Carrels	\$ 4,050	Bullnose Edge	38		62	29
	Wave II	WC2-CA36-MP	Configuration A: 2 Workstations, Back to Back, 36" Carrels	\$ 3,370	Multi-Ply Edge	38		62	29
	Wave II	WC2-CA48-AC	Configuration A: 2 Workstations, Back to Back, 48" Carrels	\$ 3,635	Acrylic Edge	50		62	29
	Wave II	WC2-CA48-BN	Configuration A: 2 Workstations, Back to Back, 48" Carrels	\$ 4,210	Bullnose Edge	50		62	29
	Wave II	WC2-CA48-MP	Configuration A: 2 Workstations, Back to Back, 48" Carrels	\$ 3,530	Multi-Ply Edge	50		62	29
	Wave II	WC2-DA36-AC	Configuration Add-On: 2 Workstations, Back to Back, 36" Carrels	\$ 3,090	Acrylic Edge	36.5		62	29
	Wave II	WC2-DA36-BN	Configuration Add-On: 2 Workstations, Back to Back, 36" Carrels	\$ 3,660	Bullnose Edge	36.5		62	29
	Wave II	WC2-DA36-MP	Configuration Add-On: 2 Workstations, Back to Back, 36" Carrels	\$ 2,980	Multi-Ply Edge	36.5		62	29
	Wave II	WC2-DA48-AC	Configuration Add-On: 2 Workstations, Back to Back, 48" Carrels	\$ 3,250	Acrylic Edge	48.5		62	29
	Wave II	WC2-DA48-BN	Configuration Add-On: 2 Workstations, Back to Back, 48" Carrels	\$ 3,825	Bullnose Edge	48.5		62	29
	Wave II	WC2-DA48-MP	Configuration Add-On: 2 Workstations, Back to Back, 48" Carrels	\$ 3,145	Multi-Ply Edge	48.5		62	29
	Wave II	WC2-CB36-AC	Configuration B: 4 Workstations (2 Back to Back) 36" Carrels	\$ 6,565	Acrylic Edge	74		62	29
	Wave II	WC2-CB36-BN	Configuration B: 4 Workstations (2 Back to Back) 36" Carrels	\$ 7,710	Bullnose Edge	74		62	29
	Wave II	WC2-CB36-MP	Configuration B: 4 Workstations (2 Back to Back) 36" Carrels	\$ 6,350	Multi-Ply Edge	74		62	29
	Wave II	WC2-CB48-AC	Configuration B: 4 Workstations (2 Back to Back) 48" Carrels	\$ 6,885	Acrylic Edge	98		62	29
	Wave II	WC2-CB48-BN	Configuration B: 4 Workstations (2 Back to Back) 48" Carrels	\$ 8,035	Bullnose Edge	98		62	29
	Wave II	WC2-CB48-MP	Configuration B: 4 Workstations (2 Back to Back) 48" Carrels	\$ 6,675	Multi-Ply Edge	98		62	29
	Wave II	WC2-CC36-AC	Configuration C: 6 Workstations (3 Back to Back) 36" Carrels	\$ 9,655	Acrylic Edge	110.5		62	29
	Wave II	WC2-CC36-BN	Configuration C: 6 Workstations (3 Back to Back) 36" Carrels	\$ 11,370	Bullnose Edge	110.5		62	29
	Wave II	WC2-CC36-MP	Configuration C: 6 Workstations (3 Back to Back) 36" Carrels	\$ 9,330	Multi-Ply Edge	110.5		62	29
	Wave II	WC2-CC48-AC	Configuration C: 6 Workstations (3 Back to Back) 48" Carrels	\$ 10,135	Acrylic Edge	146.5		62	29
	Wave II	WC2-CC48-BN	Configuration C: 6 Workstations (3 Back to Back) 48" Carrels	\$ 11,860	Bullnose Edge	146.5		62	29
	Wave II	WC2-CC48-MP	Configuration C: 6 Workstations (3 Back to Back) 48" Carrels	\$ 9,820	Multi-Ply Edge	146.5		62	29
	Wave II	WC2-CD36-AC	Configuration D: 8 Workstations (4 Back to Back) 36" Carrels	\$ 12,745	Acrylic Edge	147		62	29
	Wave II	WC2-CD36-BN	Configuration D: 8 Workstations (4 Back to Back) 36" Carrels	\$ 15,030	Bullnose Edge	147		62	29
	Wave II	WC2-CD36-MP	Configuration D: 8 Workstations (4 Back to Back) 36" Carrels	\$ 12,310	Multi-Ply Edge	147		62	29
	Wave II	WC2-CD48-AC	Configuration D: 8 Workstations (4 Back to Back) 48" Carrels	\$ 13,385	Acrylic Edge	195		62	29
	Wave II	WC2-CD48-BN	Configuration D: 8 Workstations (4 Back to Back) 48" Carrels	\$ 15,685	Bullnose Edge	195		62	29
	Wave II	WC2-CD48-MP	Configuration D: 8 Workstations (4 Back to Back) 48" Carrels	\$ 12,965	Multi-Ply Edge	195		62	29
	Wave II	WC2-CE36-AC	Configuration E: 10 Workstations (5 Back to Back) 36" Carrels	\$ 15,835	Acrylic Edge	183.5		62	29
	Wave II	WC2-CE36-BN	Configuration E: 10 Workstations (5 Back to Back) 36" Carrels	\$ 18,690	Bullnose Edge	183.5		62	29
	Wave II	WC2-CE36-MP	Configuration E: 10 Workstations (5 Back to Back) 36" Carrels	\$ 15,290	Multi-Ply Edge	183.5		62	29
	Wave II	WC2-CE48-AC	Configuration E: 10 Workstations (5 Back to Back) 48" Carrels	\$ 16,635	Acrylic Edge	243.5		62	29
	Wave II	WC2-CE48-BN	Configuration E: 10 Workstations (5 Back to Back) 48" Carrels	\$ 19,510	Bullnose Edge	243.5		62	29
	Wave II	WC2-CE48-MP	Configuration E: 10 Workstations (5 Back to Back) 48" Carrels	\$ 16,110	Multi-Ply Edge	243.5		62	29
	Wave III	WC3-CA36-AC	Configuration A: 2 Workstations, Back to Back, 36" Carrels	\$ 2,790	Acrylic Edge	38		53.75	29
	Wave III	WC3-CA36-BN	Configuration A: 2 Workstations, Back to Back, 36" Carrels	\$ 3,365	Bullnose Edge	38		53.75	29





Image	Collection	Catalog Number	Item Description	List Price	Colour / Type	Width (Inches)	Length (Inches)	Depth (Inches)	Height (Inches)	
	Wave III	WC3-CA36-MP	Configuration A: 2 Workstations, Back to Back, 36" Carrels	\$ 2,685	Multi-Ply Edge	38		53.75	29	
	Wave III	WC3-CA48-AC	Configuration A: 2 Workstations, Back to Back, 48" Carrels	\$ 2,955	Acrylic Edge	50		53.75	29	
	Wave III	WC3-CA48-BN	Configuration A: 2 Workstations, Back to Back, 48" Carrels	\$ 3,525	Bullnose Edge	50		53.75	29	
	Wave III	WC3-CA48-MP	Configuration A: 2 Workstations, Back to Back, 48" Carrels	\$ 2,850	Multi-Ply Edge	50		53.75	29	
	Wave III	WC3-DA36-AC	Configuration Add-On: 2 Workstations, Back to Back, 36" Carrels	\$ 2,400	Acrylic Edge	36.5		53.75	29	
	Wave III	WC3-DA36-BN	Configuration Add-On: 2 Workstations, Back to Back, 36" Carrels	\$ 2,975	Bullnose Edge	36.5		53.75	29	
	Wave III	WC3-DA36-MP	Configuration Add-On: 2 Workstations, Back to Back, 36" Carrels	\$ 2,295	Multi-Ply Edge	36.5		53.75	29	
	Wave III	WC3-DA48-AC	Configuration Add-On: 2 Workstations, Back to Back, 48" Carrels	\$ 2,560	Acrylic Edge	48.5		53.75	29	
	Wave III	WC3-DA48-BN	Configuration Add-On: 2 Workstations, Back to Back, 48" Carrels	\$ 3,135	Bullnose Edge	48.5		53.75	29	
	Wave III	WC3-DA48-MP	Configuration Add-On: 2 Workstations, Back to Back, 48" Carrels	\$ 2,455	Multi-Ply Edge	48.5		53.75	29	
	Wave III	WC3-CB36-AC	Configuration B: 4 Workstations (2 Back to Back) 36" Carrels	\$ 5,190	Acrylic Edge	74		53.75	29	
	Wave III	WC3-CB36-BN	Configuration B: 4 Workstations (2 Back to Back) 36" Carrels	\$ 6,340	Bullnose Edge	74		53.75	29	
	Wave III	WC3-CB36-MP	Configuration B: 4 Workstations (2 Back to Back) 36" Carrels	\$ 4,980	Multi-Ply Edge	74		53.75	29	
	Wave III	WC3-CB48-AC	Configuration B: 4 Workstations (2 Back to Back) 48" Carrels	\$ 5,515	Acrylic Edge	98		53.75	29	
	Wave III	WC3-CB48-BN	Configuration B: 4 Workstations (2 Back to Back) 48" Carrels	\$ 6,660	Bullnose Edge	98		53.75	29	
	Wave III	WC3-CB48-MP	Configuration B: 4 Workstations (2 Back to Back) 48" Carrels	\$ 5,305	Multi-Ply Edge	98		53.75	29	
	Wave III	WC3-CC36-AC	Configuration C: 6 Workstations (3 Back to Back) 36" Carrels	\$ 7,590	Acrylic Edge	110.5		53.75	29	
	Wave III	WC3-CC36-BN	Configuration C: 6 Workstations (3 Back to Back) 36" Carrels	\$ 9,315	Bullnose Edge	110.5		53.75	29	
	Wave III	WC3-CC36-MP	Configuration C: 6 Workstations (3 Back to Back) 36" Carrels	\$ 7,275	Multi-Ply Edge	110.5		53.75	29	
	Wave III	WC3-CC48-AC	Configuration C: 6 Workstations (3 Back to Back) 48" Carrels	\$ 8,075	Acrylic Edge	146.5		53.75	29	
	Wave III	WC3-CC48-BN	Configuration C: 6 Workstations (3 Back to Back) 48" Carrels	\$ 9,795	Bullnose Edge	146.5		53.75	29	
	Wave III	WC3-CC48-MP	Configuration C: 6 Workstations (3 Back to Back) 48" Carrels	\$ 7,760	Multi-Ply Edge	146.5		53.75	29	
	Wave III	WC3-CD36-AC	Configuration D: 8 Workstations (4 Back to Back) 36" Carrels	\$ 9,990	Acrylic Edge	147		53.75	29	
	Wave III	WC3-CD36-BN	Configuration D: 8 Workstations (4 Back to Back) 36" Carrels	\$ 12,290	Bullnose Edge	147		53.75	29	
	Wave III	WC3-CD36-MP	Configuration D: 8 Workstations (4 Back to Back) 36" Carrels	\$ 9,570	Multi-Ply Edge	147		53.75	29	
	Wave III	WC3-CD48-AC	Configuration D: 8 Workstations (4 Back to Back) 48" Carrels	\$ 10,635	Acrylic Edge	195		53.75	29	
	Wave III	WC3-CD48-BN	Configuration D: 8 Workstations (4 Back to Back) 48" Carrels	\$ 12,930	Bullnose Edge	195		53.75	29	
	Wave III	WC3-CD48-MP	Configuration D: 8 Workstations (4 Back to Back) 48" Carrels	\$ 10,215	Multi-Ply Edge	195		53.75	29	
	Wave III	WC3-CE36-AC	Configuration E: 10 Workstations (5 Back to Back) 36" Carrels	\$ 12,390	Acrylic Edge	183.5		53.75	29	
	Wave III	WC3-CE36-BN	Configuration E: 10 Workstations (5 Back to Back) 36" Carrels	\$ 15,265	Bullnose Edge	183.5		53.75	29	
	Wave III	WC3-CE36-MP	Configuration E: 10 Workstations (5 Back to Back) 36" Carrels	\$ 11,865	Multi-Ply Edge	183.5		53.75	29	
	Wave III	WC3-CE48-AC	Configuration E: 10 Workstations (5 Back to Back) 48" Carrels	\$ 13,195	Acrylic Edge	243.5		53.75	29	
	Wave III	WC3-CE48-BN	Configuration E: 10 Workstations (5 Back to Back) 48" Carrels	\$ 16,065	Bullnose Edge	243.5		53.75	29	
	Wave III	WC3-CE48-MP	Configuration E: 10 Workstations (5 Back to Back) 48" Carrels	\$ 12,670	Multi-Ply Edge	243.5		53.75	29	
		Accessories	S-FA	Table Divider Screen, Frosted Acrylic	\$ 280		32			8
		Accessories	S-FAS	Table Divider Screen Surround, Frosted Acrylic	\$ 545		32		12.75	8









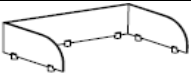

Image	Collection	Catalog Number	Item Description	List Price	Colour / Type	Width (Inches)	Length (Inches)	Depth (Inches)	Height (Inches)
	Accessories	S-WS-O	Table Divider Screen Surround, Wood, Oak	\$ 270		32		7	8
	Accessories	S-WS-M	Table Divider Screen Surround, Wood, Maple	\$ 270		32		7	8
	Accessories	S-SWM	Table Divider Screen, Steel Post, Wood Frame, Perforated Metal	\$ 745		24		16	
	Accessories	S-SWW-O	Table Divider Screen, Steel Post, Wood Screen, Oak	\$ 495		24		16	
	Accessories	S-SWW-M	Table Divider Screen, Steel Post, Wood Screen, Maple	\$ 495		24		16	
	Accessories	S-SWA	Table Divider Screen, Steel Post, Wood Frame, Frosted Acrylic	\$ 745		24		16	
	Electrical	P-100-F	Flip-Up Power: 2 Outlet, 2 Data	\$ 625		9		5.5	
	Electrical	P-100-J	Jr. Flip-Up Power: 2 Outlet, 2 Data	\$ 505		5.75		5.5	
	Electrical	DTP-BL	Desktop Power and Data	\$ 230		7		3	
	Electrical	P-PS-B	Power Sphere: 4 Outlets, Black	\$ 275		3		3	
	Electrical	P-PS-T	Power Sphere: 4 Outlets, Translucent	\$ 275		3		3	
	Electrical	P-PDS-B	Power Sphere: 2 Outlets & 2 Data, Black	\$ 215		3		3	
	Electrical	P-PDS-T	Power Sphere: 2 Outlets & 2 Data, Translucent	\$ 215		3		3	
	Electrical	P-SPC-6	Power Bar, 6 Outlet	\$ 125		11		2	
	Accessories	PD-BL	Pencil Drawer	\$ 140		20.86		18.5	1.89
	Accessories	PK-BL	Pullout Keyboard	\$ 510		24		11	
	Accessories	APK-BL	Articulating Keyboard & Mouse	\$ 635		21		10	



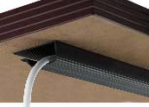

Image	Collection	Catalog Number	Item Description	List Price	Colour / Type	Width (Inches)	Length (Inches)	Depth (Inches)	Height (Inches)
	Accessories	PL-3	Plastic Grommet	\$ 85		3		3	
	Accessories	P-TC-V	Vertical Flex Wire Leg	\$ 165		3		2	32.50
	Accessories	P-TC	Table Connector	\$ 40		3		2	
	Accessories	P-OWMT	Wire Manager	\$ 75		30		2	

Table of Contents	2-3
-------------------	-----

Product Materials & Finishes	4-7
------------------------------	-----

Round Tables	8-43
--------------	------

 36" Diameter	8-19
42" Diameter	20-31
48" Diameter	32-43

Square Tables	44-91
---------------	-------

 30" Width	44-55
36" Width	56-67
42" Width	68-79
48" Width	80-91

Rectangle Tables	92-187
------------------	--------

 36" Width	92-103
48" Width	104-115
60" Width	116-139
72" Width	140-163
84" Width	164-175
96" Width	176-187

Trapezoidal Tables	189-191
--------------------	---------

 48" Width	
60" Width	

Triangle Tables	192-193
-----------------	---------

 30" Width	
36" Width	

Trio-Squared Tables	194-197
---------------------	---------

 48" Width	194-195
60" Width	196-197

Trio-Round Tables	198-201
-------------------	---------

 48" Width	198-199
60" Width	200-201

Trio-Link Tables	202-205
------------------	---------

 48" Width	202-203
60" Width	204-205

Quad-Link Tables	206-213
------------------	---------

 36" Width	206-207
42" Width	208-209
48" Width	210-211
60" Width	212-213

Warranty	214-215
----------	---------

Terms & Conditions	IBC
--------------------	-----

WOODS & FINISHES:

Natural Maple
Standard



Natural Clear – M-NA

Maple Finishes

The following stains are available, add 10% to list



Honey Oak – M-HO

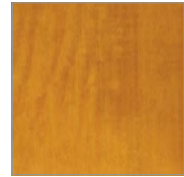

Castle Oak – M-CO



Richmond Cherry – M-RC



Mahogany – M-MA

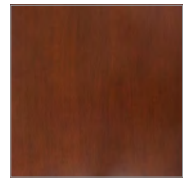

Victorian Cherry – M-VI

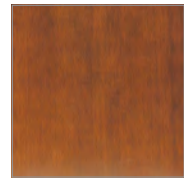

Java – M-JA

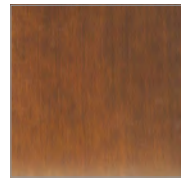

Wenge – M-WE

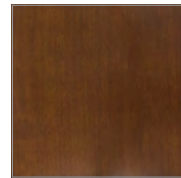

English Oak – M-EN

Natural Red Oak
Standard



Natural Clear – O-NA

Red Oak Finishes

The following stains are available, add 10% to list

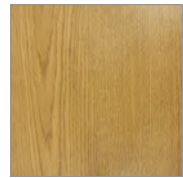

Castle Oak – O-CO



Honey Oak – O-HO

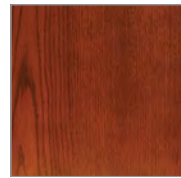

English Oak – O-EN



Victorian Cherry – O-VI

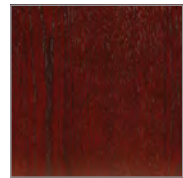

Mahogany – O-MA

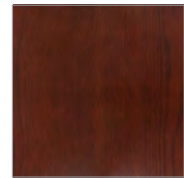

Richmond Cherry – O-RC

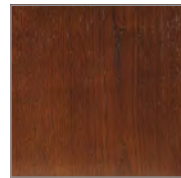

Java – O-JA

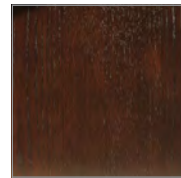

Wenge – O-WE

Natural Cherry
Add 20% to list

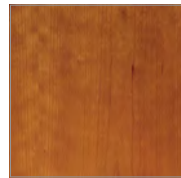

Natural Clear – C-NA

Cherry Finishes

The following stains are available, add 30% to list

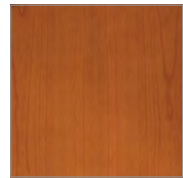

Honey Oak – C-HO



Richmond Cherry – C-RC

Natural Walnut
Add 20% to list



Natural Clear – W-NA

Walnut Finishes

The following stain is available, add 30% to list

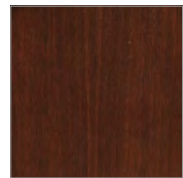

Java – W-JA

WOOD GRAIN LAMINATES:
Melamine Laminate Options



Hardrock Maple – L303



Fidlar's Maple – L363



Cognac Cherry – L448



Cherry Blossom – L449

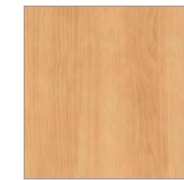

Almond Cherry – L457

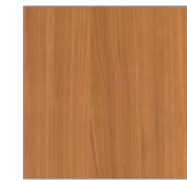

Samba Cherry – L460



Lambada Cherry – L461

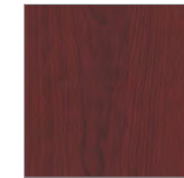

Shiraz Cherry – L472



Tuxedo – 477



Hot Cinnamon – L480



Caramel Maple – L490



Antigua – L498



Borneo – L500

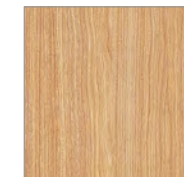

Ginger Snap Fruitwood – L518

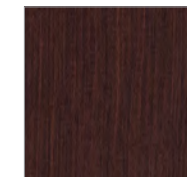

Very Chic – L666

KREATIONS

METAL PAINT COLORS:
(FOR METAL LEG OPTIONS)



Sparkle Silver – S11

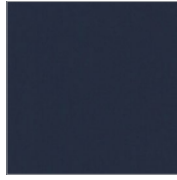

Navy – B17



Charcoal – A230

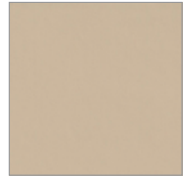

Beige – H23



Blue – B11



Grey – A16



Antique White – W11



Teal – HG266



Black – N49

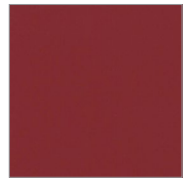

Ruby – R7



Green – G58



Black Sandtex – N31
Textured Finish



White – PS-111-W374

ACRYLIC EDGE COLORS:

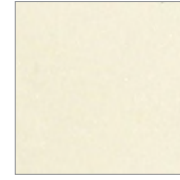

Antique White – AC-W11



White – AC-SW811

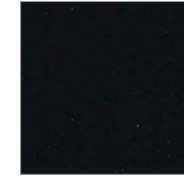

Black – AC-N49



Charcoal – AC-A230



Grey – AC-A16



Ruby – AC-R7



Blue – AC-B11



Navy – AC-B17



HIGH PRESSURE LAMINATE: Work surface laminate shall be .050" thick and used with balancing backer sheet of no less than .028" thick. Laminate shall conform to standards set by the National Electrical Manufacturers' Association (NEMA).

FINISHING PROCEDURES: All materials shall be inspected and treated with a final sanding and polishing operation before any staining and final finishing can be performed. All machine and mill marks are removed. Once the polishing and sanding has been performed, the furniture will then undergo the following stain and finishing procedures:

- Step 1 A base stain will be uniformly applied, wiped and then allowed to dry under factory controlled conditions.
- Step 2 A uniform coat of sealer will be applied and allowed to dry.
- Step 3 Sealer will be lightly sanded using 240 grit silicon paper.
- Step 4 A catalytic lacquer of 34-45 degree sheen is evenly applied and allowed to dry under factory controlled conditions.

METAL FINISHING PROCEDURES: All metal components are thoroughly cleaned and coated electrostatically with an epoxy powder coat paint finish. The metal components are then oven baked and cured for a lasting finish.

KREATIONS

MODEL NUMBER	PRODUCT	WIDTH	DEPTH	HEIGHT	PRICE	DESCRIPTION
 *Shown Above: TB-R36-AC-M-D	Round Table, 36" Diameter,	36"	36"	29"		Each Table Top is constructed using a 1" thick top with a Plastic Laminate top surface.
	ACRYLIC Edge;					All Metal legs are coated electrostatically with an epoxy powder coat paint.
 *Round Table Shape	with WOOD Leg Option:	36"	36"	29"		NOTES: * Table heights of 25" (children), 27" (youth), and 32" (wheelchair) are available by request. * Color of Metal Paint must be specified at the time of order. * Caster Leg options are recommended for Reading/Multipurpose Tables options and not meant to be used for stationary computer workstations. * For all tables with casters legs, only 2 legs will have casters, and the other legs will have levelers. This will create a "wheelbarrow" style of table which will ensure ease of mobility. * Color of the Caster Option must be specified at the time of order.
	TB-R36-AC-W-SO Square				\$ 985	
	TB-R36-AC-W-SOR Square Radius				\$ 985	
	TB-R36-AC-W-SOT Square Tapered				\$ 1,140	
	TB-R36-AC-W-DT Diameter Tapered				\$ 1,270	
TB-R36-AC-W-SR Safari				\$ 1,275		
	with METAL Leg Option:	36"	36"	29"		
TB-R36-AC-M-SO Square					\$ 920	
TB-R36-AC-M-SS Square & Stem					\$ 1,350	
TB-R36-AC-M-D Diameter					\$ 920	
TB-R36-AC-M-DS Diameter & Stem					\$ 1,350	
TB-R36-AC-M-BO Balloon					\$ 1,025	
TB-R36-AC-MC-SO Square with Casters					\$ 1,145	
TB-R36-AC-MC-SS Square & Stem with Casters					\$ 1,570	
TB-R36-AC-MC-D Diameter with Casters					\$ 1,145	
TB-R36-AC-MC-DS Diameter & Stem with Casters					\$ 1,570	
TB-R36-AC-FP1 Flat Pedestal 19" H		36"	36"	19"	\$ 1,285	
TB-R36-AC-FP2 Flat Pedestal 29" H		36"	36"	29"	\$ 1,285	
TB-R36-AC-FP3 Flat Pedestal 42" H		36"	36"	42"	\$ 1,475	
TB-R36-AC-TP1 Trumpet 19" H		36"	36"	19"	\$ 1,005	
TB-R36-AC-TP2 Trumpet 29" H		36"	36"	29"	\$ 1,005	
TB-R36-AC-TP3 Trumpet 42" H		36"	36"	42"	\$ 1,375	

Edge Option:

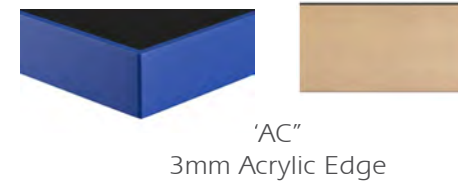

Metal Leg Options:



Wood Leg Options:

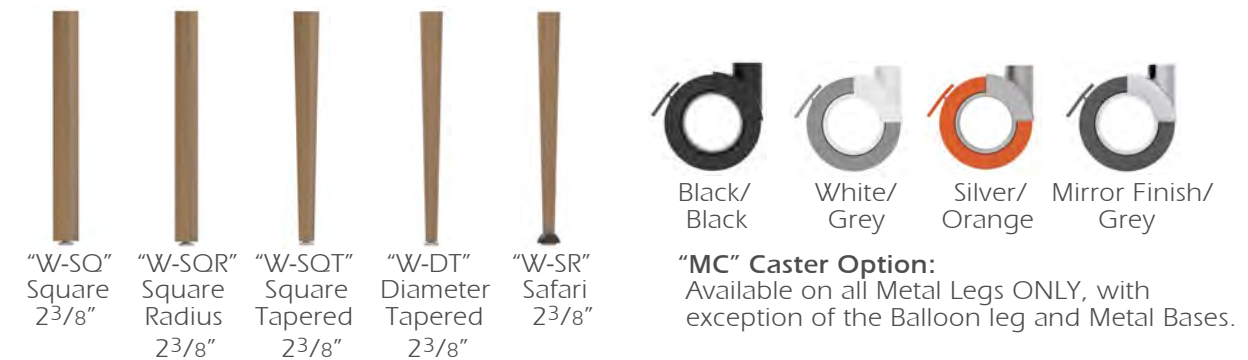

KREATIONS

MODEL NUMBER	PRODUCT	WIDTH	DEPTH	HEIGHT	PRICE	DESCRIPTION	
 *Shown Above: TB-R36-SQ-M-D  *Round Table Shape	Round Table, 36" Diameter,	36"	36"	29"		Each Table Top is constructed using a 1 1/8" thick top with a Plastic Laminate top surface. All Metal legs are coated electrostatically with an epoxy powder coat paint. NOTES: * Table heights of 25" (children), 27" (youth), and 32" (wheelchair) are available by request. * Color of Metal Paint must be specified at the time of order. * Caster Leg options are recommended for Reading/Multipurpose Tables options and not meant to be used for stationary computer workstations. * For all tables with casters legs, only 2 legs will have casters, and the other legs will have levelers. This will create a "wheelbarrow" style of table which will ensure ease of mobility. * Color of the Caster Option must be specified at the time of order.	
	SQUARE Edge;						
	with WOOD Leg Option:	36"	36"	29"			
	TB-R36-SQ-W-SQ TB-R36-SQ-W-SQR TB-R36-SQ-W-SQT TB-R36-SQ-W-DT TB-R36-SQ-W-SR	Square Square Radius Square Tapered Diameter Tapered Safari					\$ 1,080 \$ 1,080 \$ 1,235 \$ 1,365 \$ 1,370
	with METAL Leg Option:	36"	36"	29"			
TB-R36-SQ-M-SQ TB-R36-SQ-M-SS TB-R36-SQ-M-D TB-R36-SQ-M-DS TB-R36-SQ-M-BO TB-R36-SQ-MC-SQ TB-R36-SQ-MC-SS TB-R36-SQ-MC-D TB-R36-SQ-MC-DS	Square Square & Stem Diameter Diameter & Stem Balloon Square with Casters Square & Stem with Casters Diameter with Casters Diameter & Stem with Casters				\$ 1,015 \$ 1,445 \$ 1,015 \$ 1,445 \$ 1,120 \$ 1,240 \$ 1,665 \$ 1,240 \$ 1,665		

Edge Option:



Metal Leg Options:

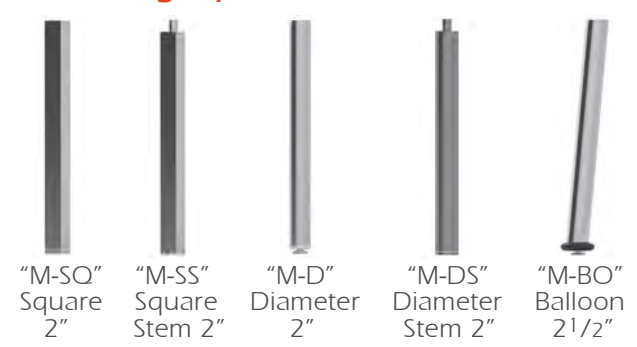

Wood Leg Options:

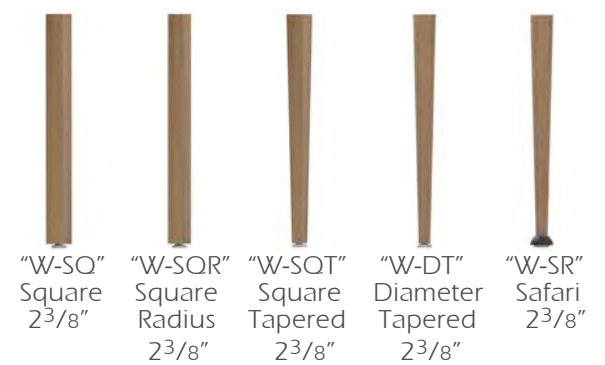

"MC" Caster Option:
 Available on all Metal Legs ONLY, with exception of the Balloon leg and Metal Bases.

KREATIONS

MODEL NUMBER	PRODUCT	WIDTH	DEPTH	HEIGHT	PRICE	DESCRIPTION	
 <p>*Shown Above: TB-R36-DSQ-M-D</p>  <p>*Round Table Shape</p>	Round Table, 36" Diameter,	36"	36"	29"		<p>Each Table Top is constructed using a 1 1/8" thick top with a Plastic Laminate top surface.</p> <p>All Metal legs are coated electrostatically with an epoxy powder coat paint.</p> <p>NOTES: * Table heights of 25" (children), 27" (youth), and 32" (wheelchair) are available by request. * Color of Metal Paint must be specified at the time of order. * Caster Leg options are recommended for Reading/Multipurpose Tables options and not meant to be used for stationary computer workstations. * For all tables with casters legs, only 2 legs will have casters, and the other legs will have levelers. This will create a "wheelbarrow" style of table which will ensure ease of mobility. * Color of the Caster Option must be specified at the time of order.</p>	
		DROPPED SQUARE Edge;					
		with WOOD Leg Option:	36"	36"	29"		
	TB-R36-DSQ-W-SQ	Square					\$ 1,125
	TB-R36-DSQ-W-SQR	Square Radius					\$ 1,125
	TB-R36-DSQ-W-SQT	Square Tapered					\$ 1,275
	TB-R36-DSQ-W-DT	Diameter Tapered					\$ 1,405
	TB-R36-DSQ-W-SR	Safari					\$ 1,410
		with METAL Leg Option:	36"	36"	29"		
	TB-R36-DSQ-M-SQ	Square					\$ 1,060
TB-R36-DSQ-M-SS	Square & Stem				\$ 1,485		
TB-R36-DSQ-M-D	Diameter				\$ 1,060		
TB-R36-DSQ-M-DS	Diameter & Stem				\$ 1,485		
TB-R36-DSQ-M-BO	Balloon				\$ 1,160		
TB-R36-DSQ-MC-SQ	Square with Casters				\$ 1,285		
TB-R36-DSQ-MC-SS	Square & Stem with Casters				\$ 1,710		
TB-R36-DSQ-MC-D	Diameter with Casters				\$ 1,285		
TB-R36-DSQ-MC-DS	Diameter & Stem with Casters				\$ 1,710		

Edge Option:



Metal Leg Options:

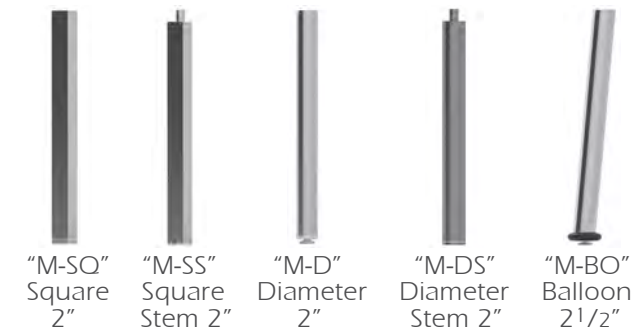

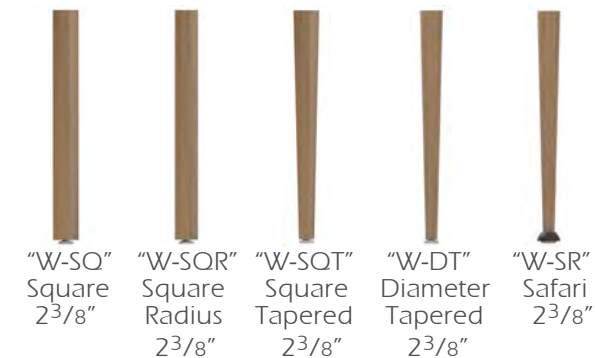

Wood Leg Options:



"MC" Caster Option:
 Available on all Metal Legs ONLY, with exception of the Balloon leg and Metal Bases.

KREATIONS

MODEL NUMBER	PRODUCT	WIDTH	DEPTH	HEIGHT	PRICE	DESCRIPTION	
 *Shown Above: TB-R36-DBN-M-D  *Round Table Shape	Round Table, 36" Diameter,	36"	36"	29"		Each Table Top is constructed using a 1 1/8" thick top with a Plastic Laminate top surface. All Metal legs are coated electrostatically with an epoxy powder coat paint. NOTES: * Table heights of 25" (children), 27" (youth), and 32" (wheelchair) are available by request. * Color of Metal Paint must be specified at the time of order. * Caster Leg options are recommended for Reading/Multipurpose Tables options and not meant to be used for stationary computer workstations. * For all tables with casters legs, only 2 legs will have casters, and the other legs will have levelers. This will create a "wheelbarrow" style of table which will ensure ease of mobility. * Color of the Caster Option must be specified at the time of order.	
	DROPPED BULLNOSE Edge;						
	with WOOD Leg Option:	36"	36"	29"			
	TB-R36-DBN-W-SQ TB-R36-DBN-W-SQR TB-R36-DBN-W-SQT TB-R36-DBN-W-DT TB-R36-DBN-W-SR	Square Square Radius Square Tapered Diameter Tapered Safari					\$ 1,135 \$ 1,135 \$ 1,285 \$ 1,415 \$ 1,425
	with METAL Leg Option:	36"	36"	29"			
TB-R36-DBN-M-SQ TB-R36-DBN-M-SS TB-R36-DBN-M-D TB-R36-DBN-M-DS TB-R36-DBN-M-BO TB-R36-DBN-MC-SQ TB-R36-DBN-MC-SS TB-R36-DBN-MC-D TB-R36-DBN-MC-DS	Square Square & Stem Diameter Diameter & Stem Balloon Square with Casters Square & Stem with Casters Diameter with Casters Diameter & Stem with Casters				\$ 1,070 \$ 1,495 \$ 1,070 \$ 1,495 \$ 1,175 \$ 1,300 \$ 1,720 \$ 1,300 \$ 1,720		

Edge Option:



Metal Leg Options:

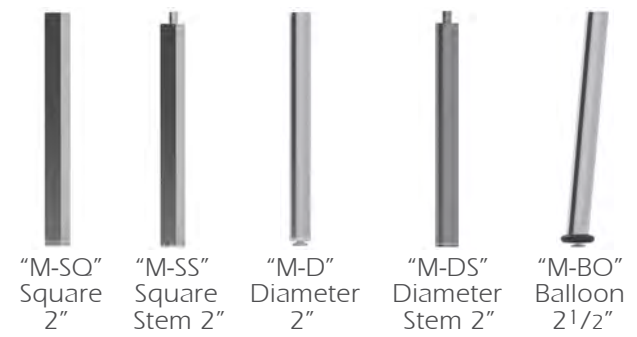

Wood Leg Options:

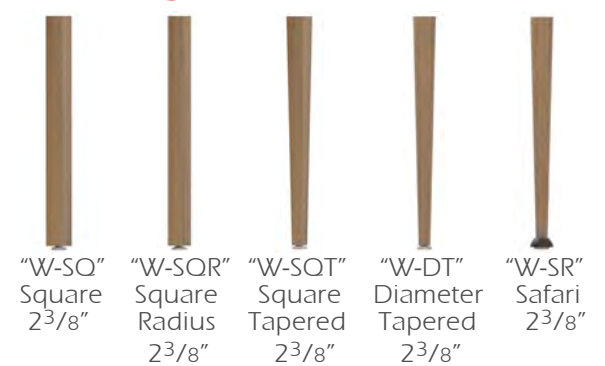

"MC" Caster Option:
Available on all Metal Legs ONLY, with exception of the Balloon leg and Metal Bases.

KREATIONS

MODEL NUMBER	PRODUCT	WIDTH	DEPTH	HEIGHT	PRICE	DESCRIPTION	
 <p>*Shown Above: TB-R36-DCH-M-D</p>  <p>*Round Table Shape</p>	Round Table, 36" Diameter,	36"	36"	29"		<p>Each Table Top is constructed using a 1 1/8" thick top with a Plastic Laminate top surface.</p> <p>All Metal legs are coated electrostatically with an epoxy powder coat paint.</p> <p>NOTES: * Table heights of 25" (children), 27" (youth), and 32" (wheelchair) are available by request. * Color of Metal Paint must be specified at the time of order. * Caster Leg options are recommended for Reading/Multipurpose Tables options and not meant to be used for stationary computer workstations. * For all tables with casters legs, only 2 legs will have casters, and the other legs will have levelers. This will create a "wheelbarrow" style of table which will ensure ease of mobility. * Color of the Caster Option must be specified at the time of order.</p>	
	DROPPED CHAMFERED Edge;						
	with WOOD Leg Option:	36"	36"	29"			
	TB-R36-DCH-W-SQ	Square			\$ 1,135		
	TB-R36-DCH-W-SQR	Square Radius			\$ 1,135		
	TB-R36-DCH-W-SQT	Square Tapered			\$ 1,285		
	TB-R36-DCH-W-DT	Diameter Tapered			\$ 1,415		
	TB-R36-DCH-W-SR	Safari			\$ 1,425		
	with METAL Leg Option:	36"	36"	29"			
	TB-R36-DCH-M-SQ	Square			\$ 1,070		
TB-R36-DCH-M-SS	Square & Stem			\$ 1,495			
TB-R36-DCH-M-D	Diameter			\$ 1,070			
TB-R36-DCH-M-DS	Diameter & Stem			\$ 1,495			
TB-R36-DCH-M-BO	Balloon			\$ 1,175			
TB-R36-DCH-MC-SQ	Square with Casters			\$ 1,300			
TB-R36-DCH-MC-SS	Square & Stem with Casters			\$ 1,720			
TB-R36-DCH-MC-D	Diameter with Casters			\$ 1,300			
TB-R36-DCH-MC-DS	Diameter & Stem with Casters			\$ 1,720			

Edge Option:



Metal Leg Options:

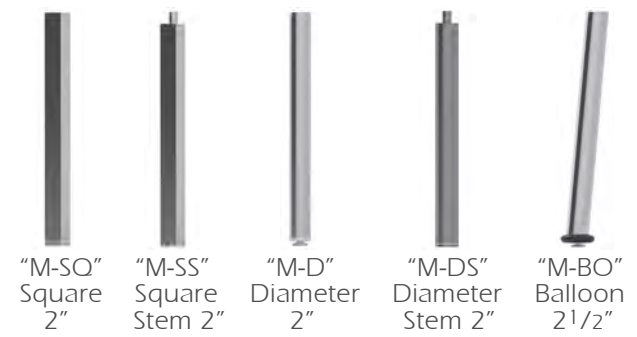



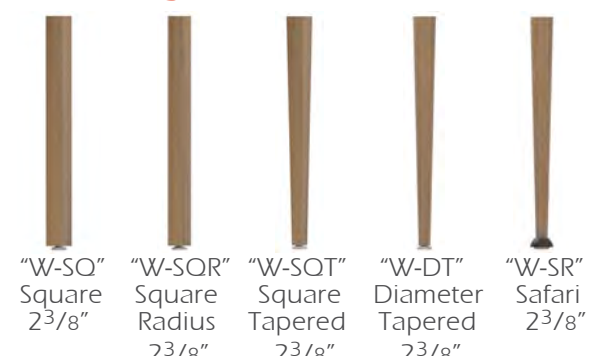

Wood Leg Options:



"MC" Caster Option:
Available on all Metal Legs ONLY, with exception of the Balloon leg and Metal Bases.

KREATIONS

MODEL NUMBER	PRODUCT	WIDTH	DEPTH	HEIGHT	PRICE	DESCRIPTION
 <p>*Shown Above: TB-R36-AL-M-D</p>	Round Table, 36" Diameter,	36"	36"	29"		<p>Each Table Top is constructed using a 1 1/8" thick top with a Plastic Laminate top surface.</p> <p>All Metal legs are coated electrostatically with an epoxy powder coat paint.</p> <p>NOTES: * Table heights of 25" (children), 27" (youth), and 32" (wheelchair) are available by request. * Color of Metal Paint must be specified at the time of order. * Caster Leg options are recommended for Reading/Multipurpose Tables options and not meant to be used for stationary computer workstations. * For all tables with casters legs, only 2 legs will have casters, and the other legs will have levelers. This will create a "wheelbarrow" style of table which will ensure ease of mobility. * Color of the Caster Option must be specified at the time of order.</p>
	ALUMINUM Edge;					
 <p>*Round Table Shape</p>	with WOOD Leg Option:	36"	36"	29"		<p>Edge Option:</p>  <p>"AL" 3mm Aluminum Edge</p> <p>Metal Leg Options:</p>  <p>"M-SQ" Square 2" "M-SS" Square Stem 2" "M-D" Diameter 2" "M-DS" Diameter Stem 2" "M-BO" Balloon 2 1/2" "FP" Flat Pedestal Base "TP" Trumpet Base</p> <p>Wood Leg Options:</p>  <p>"W-SQ" Square 2 3/8" "W-SOR" Square Radius 2 3/8" "W-SOT" Square Tapered 2 3/8" "W-DT" Diameter Tapered 2 3/8" "W-SR" Safari 2 3/8"</p> <p>Black/Black White/Grey Silver/Orange Mirror Finish/Grey</p> <p>"MC" Caster Option: Available on all Metal Legs ONLY, with exception of the Balloon leg and Metal Bases.</p>
	TB-R36-AL-W-SQ	Square				
TB-R36-AL-W-SQR	Square Radius				\$ 1,045	
TB-R36-AL-W-SQT	Square Tapered				\$ 1,200	
TB-R36-AL-W-DT	Diameter Tapered				\$ 1,330	
TB-R36-AL-W-SR	Safari				\$ 1,335	
	with METAL Leg Option:	36"	36"	29"		
TB-R36-AL-M-SQ	Square				\$ 985	
TB-R36-AL-M-SS	Square & Stem				\$ 1,405	
TB-R36-AL-M-D	Diameter				\$ 985	
TB-R36-AL-M-DS	Diameter & Stem				\$ 1,405	
TB-R36-AL-M-BO	Balloon				\$ 1,085	
TB-R36-AL-MC-SQ	Square with Casters				\$ 1,205	
TB-R36-AL-MC-SS	Square & Stem with Casters				\$ 1,635	
TB-R36-AL-MC-D	Diameter with Casters				\$ 1,205	
TB-R36-AL-MC-DS	Diameter & Stem with Casters				\$ 1,635	
TB-R36-AL-FP1	Flat Pedestal 19" H	36"	36"	19"	\$ 1,345	
TB-R36-AL-FP2	Flat Pedestal 29" H	36"	36"	29"	\$ 1,345	
TB-R36-AL-FP3	Flat Pedestal 42" H	36"	36"	42"	\$ 1,535	
TB-R36-AL-TP1	Trumpet 19" H	36"	36"	19"	\$ 1,065	
TB-R36-AL-TP2	Trumpet 29" H	36"	36"	29"	\$ 1,065	
TB-R36-AL-TP3	Trumpet 42" H	36"	36"	42"	\$ 1,435	

KREATIONS

MODEL NUMBER	PRODUCT	WIDTH	DEPTH	HEIGHT	PRICE	DESCRIPTION	
 <p>*Shown Above: TB-R42-AC-M-D</p>	Round Table, 42" Diameter,	42"	42"	29"		<p>Each Table Top is constructed using a 1" thick top with a Plastic Laminate top surface.</p> <p>All Metal legs are coated electrostatically with an epoxy powder coat paint.</p> <p>NOTES: * Table heights of 25" (children), 27" (youth), and 32" (wheelchair) are available by request. * Color of Metal Paint must be specified at the time of order. * Caster Leg options are recommended for Reading/Multipurpose Tables options and not meant to be used for stationary computer workstations. * For all tables with casters legs, only 2 legs will have casters, and the other legs will have levelers. This will create a "wheelbarrow" style of table which will ensure ease of mobility. * Color of the Caster Option must be specified at the time of order.</p>	
	ACRYLIC Edge;						
	with WOOD Leg Option:	42"	42"	29"			
	TB-R42-AC-W-SO TB-R42-AC-W-SOR TB-R42-AC-W-SOT TB-R42-AC-W-DT TB-R42-AC-W-SR	Square Square Radius Square Tapered Diameter Tapered Safari					\$ 1,035 \$ 1,035 \$ 1,190 \$ 1,315 \$ 945
	with METAL Leg Option:	42"	42"	29"			
TB-R42-AC-M-SO TB-R42-AC-M-SS TB-R42-AC-M-D TB-R42-AC-M-DS TB-R42-AC-M-BO TB-R42-AC-MC-SO TB-R42-AC-MC-SS TB-R42-AC-MC-D TB-R42-AC-MC-DS	Square Square & Stem Diameter Diameter & Stem Balloon Square with Casters Square & Stem with Casters Diameter with Casters Diameter & Stem with Casters				\$ 970 \$ 1,395 \$ 970 \$ 1,395 \$ 1,075 \$ 1,200 \$ 1,620 \$ 1,200 \$ 1,620		
TB-R42-AC-FP1 TB-R42-AC-FP2 TB-R42-AC-FP3 TB-R42-AC-TP1 TB-R42-AC-TP2 TB-R42-AC-TP3	Flat Pedestal 19" H Flat Pedestal 29" H Flat Pedestal 42" H Trumpet 19" H Trumpet 29" H Trumpet 42" H	42" 42" 42" 42" 42" 42"	42" 42" 42" 42" 42" 42"	19" 29" 42" 19" 29" 42"	\$ 1,520 \$ 1,520 \$ 1,600 \$ 1,245 \$ 1,245 \$ 1,425		



*Round Table Shape

Edge Option:



"AC"
3mm Acrylic Edge

Metal Leg Options:



"M-SO" Square 2"
"M-SS" Square Stem 2"
"M-D" Diameter 2"
"M-DS" Diameter Stem 2"
"M-BO" Balloon 2 1/2"
"FP" Flat Pedestal Base
"TP" Trumpet Base

Wood Leg Options:





"W-SO" Square 2 3/8"
"W-SOR" Square Radius 2 3/8"
"W-SOT" Square Tapered 2 3/8"
"W-DT" Diameter Tapered 2 3/8"
"W-SR" Safari 2 3/8"



"MC" Caster Option:
Available on all Metal Legs ONLY, with exception of the Balloon leg and Metal Bases.

KREATIONS

MODEL NUMBER	PRODUCT	WIDTH	DEPTH	HEIGHT	PRICE	DESCRIPTION	
 *Shown Above: TB-R42-SQ-M-D  *Round Table Shape	Round Table, 42" Diameter,	42"	42"	29"		Each Table Top is constructed using a 1 1/8" thick top with a Plastic Laminate top surface. All Metal legs are coated electrostatically with an epoxy powder coat paint. NOTES: * Table heights of 25" (children), 27" (youth), and 32" (wheelchair) are available by request. * Color of Metal Paint must be specified at the time of order. * Caster Leg options are recommended for Reading/Multipurpose Tables options and not meant to be used for stationary computer workstations. * For all tables with casters legs, only 2 legs will have casters, and the other legs will have levelers. This will create a "wheelbarrow" style of table which will ensure ease of mobility. * Color of the Caster Option must be specified at the time of order.	
	SQUARE Edge;						
	with WOOD Leg Option:	42"	42"	29"			
	TB-R42-SQ-W-SQ TB-R42-SQ-W-SQR TB-R42-SQ-W-SQT TB-R42-SQ-W-DT TB-R42-SQ-W-SR	Square Square Radius Square Tapered Diameter Tapered Safari					\$ 1,140 \$ 1,140 \$ 1,295 \$ 1,425 \$ 1,430
	with METAL Leg Option:	42"	42"	29"			
TB-R42-SQ-M-SQ TB-R42-SQ-M-SS TB-R42-SQ-M-D TB-R42-SQ-M-DS TB-R42-SQ-M-BO TB-R42-SQ-MC-SQ TB-R42-SQ-MC-SS TB-R42-SQ-MC-D TB-R42-SQ-MC-DS	Square Square & Stem Diameter Diameter & Stem Balloon Square with Casters Square & Stem with Casters Diameter with Casters Diameter & Stem with Casters				\$ 1,080 \$ 1,505 \$ 1,080 \$ 1,505 \$ 1,180 \$ 1,300 \$ 1,730 \$ 1,300 \$ 1,730		

Edge Option:



"SQ"
1/4" Square Edge

Metal Leg Options:



"M-SQ" Square 2"
"M-SS" Square Stem 2"
"M-D" Diameter 2"
"M-DS" Diameter Stem 2"
"M-BO" Balloon 2 1/2"

Wood Leg Options:



"W-SQ" Square 2 3/8"
"W-SQR" Square Radius 2 3/8"
"W-SQT" Square Tapered 2 3/8"
"W-DT" Diameter Tapered 2 3/8"
"W-SR" Safari 2 3/8"



Black/Black
White/Grey
Silver/Orange
Mirror Finish/Grey
"MC" Caster Option:
Available on all Metal Legs ONLY, with exception of the Balloon leg and Metal Bases.

KREATIONS

MODEL NUMBER	PRODUCT	WIDTH	DEPTH	HEIGHT	PRICE	DESCRIPTION	
 <p>*Shown Above: TB-R42-DSQ-M-D</p>  <p>*Round Table Shape</p>	Round Table, 42" Diameter,	42"	42"	29"		<p>Each Table Top is constructed using a 1 1/8" thick top with a Plastic Laminate top surface.</p> <p>All Metal legs are coated electrostatically with an epoxy powder coat paint.</p> <p>NOTES: * Table heights of 25" (children), 27" (youth), and 32" (wheelchair) are available by request. * Color of Metal Paint must be specified at the time of order. * Caster Leg options are recommended for Reading/Multipurpose Tables options and not meant to be used for stationary computer workstations. * For all tables with casters legs, only 2 legs will have casters, and the other legs will have levelers. This will create a "wheelbarrow" style of table which will ensure ease of mobility. * Color of the Caster Option must be specified at the time of order.</p>	
		DROPPED SQUARE Edge;					
		with WOOD Leg Option:	42"	42"	29"		
	TB-R42-DSQ-W-SQ	Square					\$ 1,190
	TB-R42-DSQ-W-SQR	Square Radius					\$ 1,190
	TB-R42-DSQ-W-SQT	Square Tapered					\$ 1,345
	TB-R42-DSQ-W-DT	Diameter Tapered					\$ 1,475
	TB-R42-DSQ-W-SR	Safari					\$ 1,480
		with METAL Leg Option:	42"	42"	29"		
	TB-R42-DSQ-M-SQ	Square					\$ 1,125
TB-R42-DSQ-M-SS	Square & Stem				\$ 1,555		
TB-R42-DSQ-M-D	Diameter				\$ 1,125		
TB-R42-DSQ-M-DS	Diameter & Stem				\$ 1,555		
TB-R42-DSQ-M-BO	Balloon				\$ 1,230		
TB-R42-DSQ-MC-SQ	Square with Casters				\$ 1,355		
TB-R42-DSQ-MC-SS	Square & Stem with Casters				\$ 1,775		
TB-R42-DSQ-MC-D	Diameter with Casters				\$ 1,355		
TB-R42-DSQ-MC-DS	Diameter & Stem with Casters				\$ 1,775		

Edge Option:



Metal Leg Options:

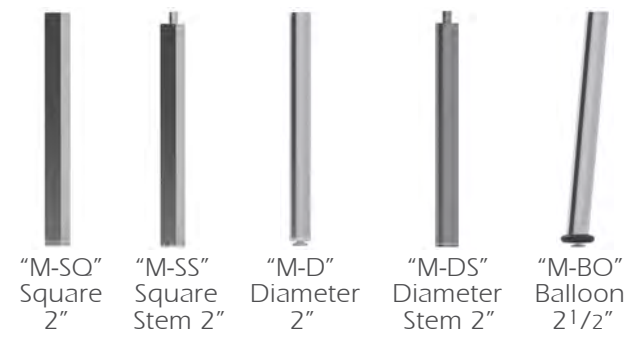

Wood Leg Options:

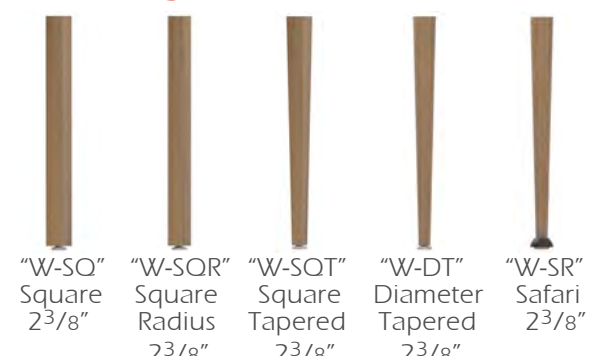

"MC" Caster Option:
Available on all Metal Legs ONLY, with exception of the Balloon leg and Metal Bases.

KREATIONS

MODEL NUMBER	PRODUCT	WIDTH	DEPTH	HEIGHT	PRICE	DESCRIPTION	
 <p>*Shown Above: TB-R42-DBN-M-D</p>  <p>*Round Table Shape</p>	Round Table, 42" Diameter,	42"	42"	29"		<p>Each Table Top is constructed using a 1 1/8" thick top with a Plastic Laminate top surface.</p> <p>All Metal legs are coated electrostatically with an epoxy powder coat paint.</p> <p>NOTES: * Table heights of 25" (children), 27" (youth), and 32" (wheelchair) are available by request. * Color of Metal Paint must be specified at the time of order. * Caster Leg options are recommended for Reading/Multipurpose Tables options and not meant to be used for stationary computer workstations. * For all tables with casters legs, only 2 legs will have casters, and the other legs will have levelers. This will create a "wheelbarrow" style of table which will ensure ease of mobility. * Color of the Caster Option must be specified at the time of order.</p>	
		DROPPED BULLNOSE Edge;					
		with WOOD Leg Option:	42"	42"	29"		
	TB-R42-DBN-W-SQ	Square					\$ 1,205
	TB-R42-DBN-W-SQR	Square Radius					\$ 1,205
	TB-R42-DBN-W-SQT	Square Tapered					\$ 1,355
	TB-R42-DBN-W-DT	Diameter Tapered					\$ 1,485
	TB-R42-DBN-W-SR	Safari					\$ 1,490
		with METAL Leg Option:	42"	42"	29"		
	TB-R42-DBN-M-SQ	Square					\$ 1,140
TB-R42-DBN-M-SS	Square & Stem				\$ 1,565		
TB-R42-DBN-M-D	Diameter				\$ 1,140		
TB-R42-DBN-M-DS	Diameter & Stem				\$ 1,565		
TB-R42-DBN-M-BO	Balloon				\$ 1,240		
TB-R42-DBN-MC-SQ	Square with Casters				\$ 1,365		
TB-R42-DBN-MC-SS	Square & Stem with Casters				\$ 1,790		
TB-R42-DBN-MC-D	Diameter with Casters				\$ 1,365		
TB-R42-DBN-MC-DS	Diameter & Stem with Casters				\$ 1,790		

Edge Option:



Metal Leg Options:

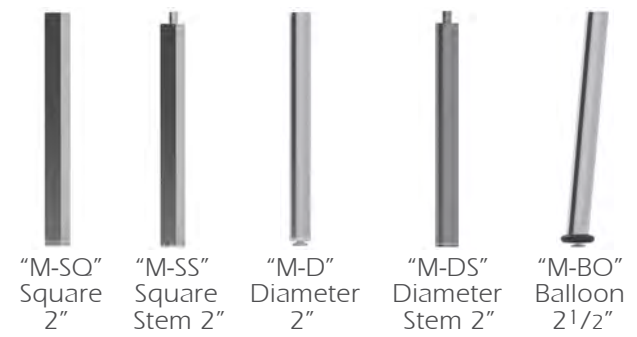

Wood Leg Options:

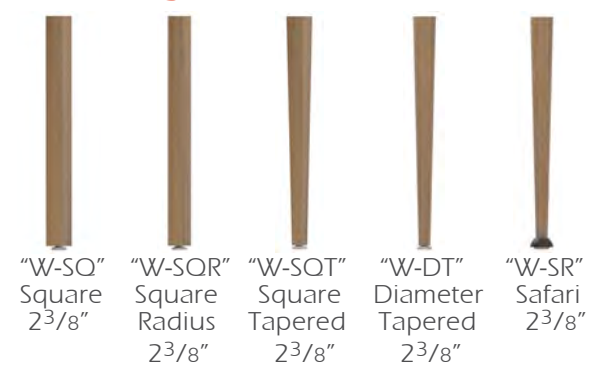

"MC" Caster Option:
 Available on all Metal Legs ONLY, with exception of the Balloon leg and Metal Bases.

KREATIONS

MODEL NUMBER	PRODUCT	WIDTH	DEPTH	HEIGHT	PRICE	DESCRIPTION
	Round Table, 42" Diameter,	42"	42"	29"		Each Table Top is constructed using a 1 1/8" thick top with a Plastic Laminate top surface.
	DROPPED CHAMFERED Edge;					All Metal legs are coated electrostatically with an epoxy powder coat paint.
*Shown Above: TB-R42-DCH-M-D	with WOOD Leg Option:	42"	42"	29"		NOTES: * Table heights of 25" (children), 27" (youth), and 32" (wheelchair) are available by request. * Color of Metal Paint must be specified at the time of order. * Caster Leg options are recommended for Reading/Multipurpose Tables options and not meant to be used for stationary computer workstations. * For all tables with casters legs, only 2 legs will have casters, and the other legs will have levelers. This will create a "wheelbarrow" style of table which will ensure ease of mobility. * Color of the Caster Option must be specified at the time of order.
	Square				\$ 1,205	
TB-R42-DCH-W-SQ	Square Radius				\$ 1,205	
TB-R42-DCH-W-SQR	Square Tapered				\$ 1,355	
TB-R42-DCH-W-SQT	Diameter Tapered				\$ 1,485	
TB-R42-DCH-W-DT	Safari				\$ 1,490	
TB-R42-DCH-W-SR	with METAL Leg Option:	42"	42"	29"		
	Square				\$ 1,140	
TB-R42-DCH-M-SQ	Square & Stem				\$ 1,565	
TB-R42-DCH-M-SS	Diameter				\$ 1,140	
TB-R42-DCH-M-D	Diameter & Stem				\$ 1,565	
TB-R42-DCH-M-DS	Balloon				\$ 1,240	
TB-R42-DCH-M-BO	Square with Casters				\$ 1,365	
TB-R42-DCH-MC-SQ	Square & Stem with Casters				\$ 1,790	
TB-R42-DCH-MC-SS	Diameter with Casters				\$ 1,365	
TB-R42-DCH-MC-D	Diameter & Stem with Casters				\$ 1,790	
TB-R42-DCH-MC-DS						



*Round Table Shape

Edge Option:



"DCH"
5/8" Dropped Chamfered Edge

Metal Leg Options:



"M-SQ" Square 2"
"M-SS" Square Stem 2"
"M-D" Diameter 2"
"M-DS" Diameter Stem 2"
"M-BO" Balloon 2 1/2"

Wood Leg Options:





"W-SQ" Square 2 3/8"
"W-SQR" Square Radius 2 3/8"
"W-SQT" Square Tapered 2 3/8"
"W-DT" Diameter Tapered 2 3/8"
"W-SR" Safari 2 3/8"



"MC" Caster Option:
Available on all Metal Legs ONLY, with exception of the Balloon leg and Metal Bases.

KREATIONS

MODEL NUMBER	PRODUCT	WIDTH	DEPTH	HEIGHT	PRICE	DESCRIPTION
 <p>*Shown Above: TB-R42-AL-M-D</p>	Round Table, 42" Diameter,	42"	42"	29"		<p>Each Table Top is constructed using a 1 1/8" thick top with a Plastic Laminate top surface.</p> <p>All Metal legs are coated electrostatically with an epoxy powder coat paint.</p> <p>NOTES: * Table heights of 25" (children), 27" (youth), and 32" (wheelchair) are available by request. * Color of Metal Paint must be specified at the time of order. * Caster Leg options are recommended for Reading/Multipurpose Tables options and not meant to be used for stationary computer workstations. * For all tables with casters legs, only 2 legs will have casters, and the other legs will have levelers. This will create a "wheelbarrow" style of table which will ensure ease of mobility. * Color of the Caster Option must be specified at the time of order.</p>
	ALUMINUM Edge;					
	with WOOD Leg Option:	42"	42"	29"		
	TB-R42-AL-W-SQ Square	\$ 1,100				
	TB-R42-AL-W-SQR Square Radius	\$ 1,100				
TB-R42-AL-W-SQT Square Tapered	\$ 1,255					
TB-R42-AL-W-DT Diameter Tapered	\$ 1,380					
TB-R42-AL-W-SR Safari	\$ 1,390					
 <p>*Round Table Shape</p>	with METAL Leg Option:	42"	42"	29"		
	TB-R42-AL-M-SQ Square	\$ 1,035				
	TB-R42-AL-M-SS Square & Stem	\$ 1,460				
	TB-R42-AL-M-D Diameter	\$ 1,035				
	TB-R42-AL-M-DS Diameter & Stem	\$ 1,460				
	TB-R42-AL-M-BO Balloon	\$ 1,140				
	TB-R42-AL-MC-SQ Square with Casters	\$ 1,260				
	TB-R42-AL-MC-SS Square & Stem with Casters	\$ 1,685				
	TB-R42-AL-MC-D Diameter with Casters	\$ 1,260				
	TB-R42-AL-MC-DS Diameter & Stem with Casters	\$ 1,685				
TB-R42-AL-FP1 Flat Pedestal 19" H	42"	42"	19"	\$ 1,585		
TB-R42-AL-FP2 Flat Pedestal 29" H	42"	42"	29"	\$ 1,585		
TB-R42-AL-FP3 Flat Pedestal 42" H	42"	42"	42"	\$ 1,665		
TB-R42-AL-TP1 Trumpet 19" H	42"	42"	19"	\$ 1,310		
TB-R42-AL-TP2 Trumpet 29" H	42"	42"	29"	\$ 1,310		
TB-R42-AL-TP3 Trumpet 42" H	42"	42"	42"	\$ 1,490		

Edge Option:

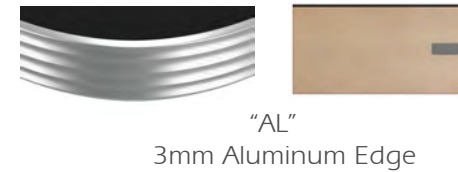

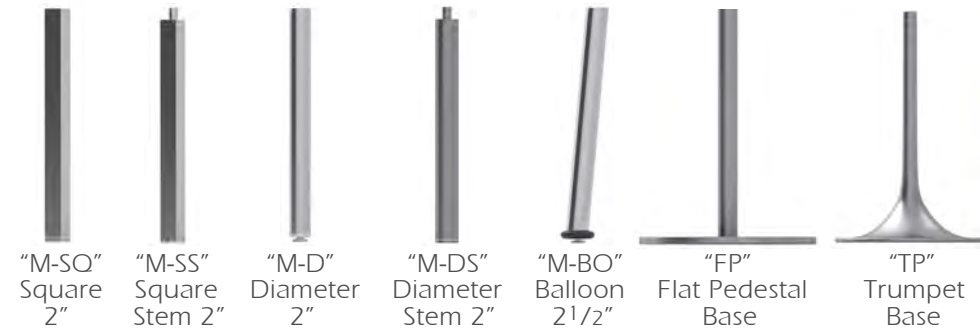

Metal Leg Options:

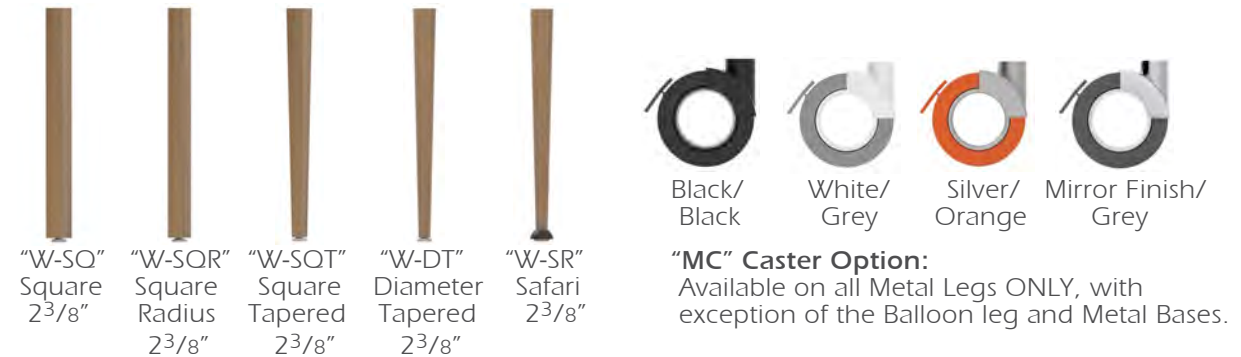

Wood Leg Options:



KREATIONS

MODEL NUMBER	PRODUCT	WIDTH	DEPTH	HEIGHT	PRICE	DESCRIPTION
 <p>*Shown Above: TB-R48-AC-M-D</p>	Round Table, 48" Diameter,	48"	48"	29"		Each Table Top is constructed using a 1" thick top with a Plastic Laminate top surface.
	ACRYLIC Edge;					All Metal legs are coated electrostatically with an epoxy powder coat paint.
	with WOOD Leg Option:	48"	48"	29"		NOTES:
	TB-R48-AC-W-SO Square	\$ 1,090	* Table heights of 25" (children), 27" (youth), and 32" (wheelchair) are available by request.			
	TB-R48-AC-W-SOR Square Radius	\$ 1,090	* Color of Metal Paint must be specified at the time of order.			
TB-R48-AC-W-SOT Square Tapered	\$ 1,240	* Caster Leg options are recommended for Reading/Multipurpose Tables options and not meant to be used for stationary computer workstations.				
TB-R48-AC-W-DT Diameter Tapered	\$ 1,370	* For all tables with casters legs, only 2 legs will have casters, and the other legs will have levelers. This will create a "wheelbarrow" style of table which will ensure ease of mobility.				
TB-R48-AC-W-SR Safari	\$ 1,380	* Color of the Caster Option must be specified at the time of order.				
 <p>*Round Table Shape</p>	with METAL Leg Option:	48"	48"	29"		
	TB-R48-AC-M-SO Square	\$ 1,025				
	TB-R48-AC-M-SS Square & Stem	\$ 1,475				
	TB-R48-AC-M-D Diameter	\$ 1,025				
	TB-R48-AC-M-DS Diameter & Stem	\$ 1,450				
	TB-R48-AC-M-BO Balloon	\$ 1,125				
	TB-R48-AC-MC-SO Square with Casters	\$ 1,255				
	TB-R48-AC-MC-SS Square & Stem with Casters	\$ 1,675				
	TB-R48-AC-MC-D Diameter with Casters	\$ 1,255				
	TB-R48-AC-MC-DS Diameter & Stem with Casters	\$ 1,675				
TB-R48-AC-FP1 Flat Pedestal 19" H	48"	48"	19"	\$ 1,900		
TB-R48-AC-FP2 Flat Pedestal 29" H	48"	48"	29"	\$ 1,900		
TB-R48-AC-FP3 Flat Pedestal 42" H	48"	48"	42"	\$ 1,975		
TB-R48-AC-TP1 Trumpet 19" H	48"	48"	19"	\$ 1,300		
TB-R48-AC-TP2 Trumpet 29" H	48"	48"	29"	\$ 1,300		
TB-R48-AC-TP3 Trumpet 42" H	48"	48"	42"	\$ 1,475		

Edge Option:

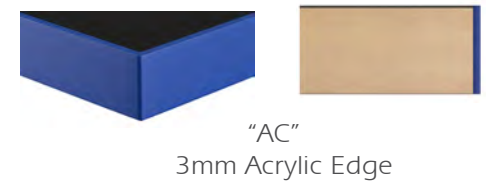

Metal Leg Options:

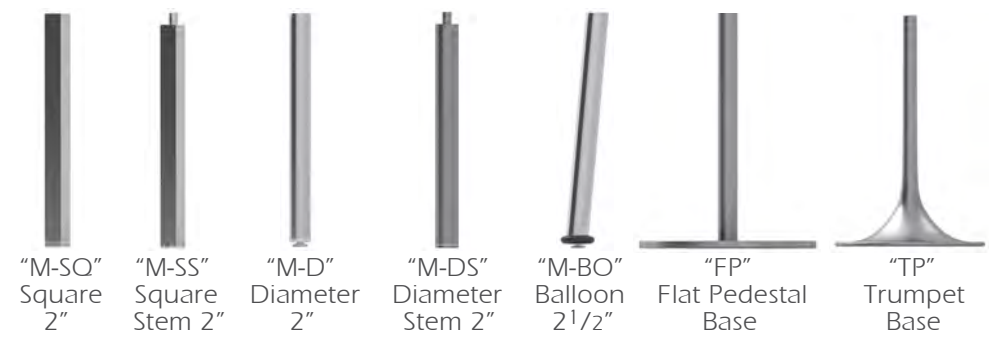

Wood Leg Options:



KREATIONS

MODEL NUMBER	PRODUCT	WIDTH	DEPTH	HEIGHT	PRICE	DESCRIPTION	
 <p>*Shown Above: TB-R48-SQ-M-D</p>	Round Table, 48" Diameter,	48"	48"	29"		<p>Each Table Top is constructed using a 1 1/8" thick top with a Plastic Laminate top surface.</p> <p>All Metal legs are coated electrostatically with an epoxy powder coat paint.</p> <p>NOTES: * Table heights of 25" (children), 27" (youth), and 32" (wheelchair) are available by request. * Color of Metal Paint must be specified at the time of order. * Caster Leg options are recommended for Reading/Multipurpose Tables options and not meant to be used for stationary computer workstations. * For all tables with casters legs, only 2 legs will have casters, and the other legs will have levelers. This will create a "wheelbarrow" style of table which will ensure ease of mobility. * Color of the Caster Option must be specified at the time of order.</p>	
	SQUARE Edge;						
	with WOOD Leg Option:	48"	48"	29"			
	TB-R48-SQ-W-SQ TB-R48-SQ-W-SQR TB-R48-SQ-W-SQT TB-R48-SQ-W-DT TB-R48-SQ-W-SR	Square Square Radius Square Tapered Diameter Tapered Safari					\$ 1,210 \$ 1,210 \$ 1,365 \$ 1,490 \$ 1,500
	with METAL Leg Option:	48"	48"	29"			
TB-R48-SQ-M-SQ TB-R48-SQ-M-SS TB-R48-SQ-M-D TB-R48-SQ-M-DS TB-R48-SQ-M-BO TB-R48-SQ-MC-SQ TB-R48-SQ-MC-SS TB-R48-SQ-MC-D TB-R48-SQ-MC-DS	Square Square & Stem Diameter Diameter & Stem Balloon Square with Casters Square & Stem with Casters Diameter with Casters Diameter & Stem with Casters				\$ 1,145 \$ 1,570 \$ 1,145 \$ 1,570 \$ 1,250 \$ 1,370 \$ 1,795 \$ 1,370 \$ 1,795		



*Round Table Shape

Edge Option:



"SQ"
1/4" Square Edge

Metal Leg Options:



"M-SQ" Square 2"
 "M-SS" Square Stem 2"
 "M-D" Diameter 2"
 "M-DS" Diameter Stem 2"
 "M-BO" Balloon 2 1/2"

Wood Leg Options:



"W-SQ" Square 2 3/8"
 "W-SQR" Square Radius 2 3/8"
 "W-SOT" Square Tapered 2 3/8"
 "W-DT" Diameter Tapered 2 3/8"
 "W-SR" Safari 2 3/8"



"MC" Caster Option:
 Available on all Metal Legs ONLY, with exception of the Balloon leg and Metal Bases.

KREATIONS

MODEL NUMBER	PRODUCT	WIDTH	DEPTH	HEIGHT	PRICE	DESCRIPTION	
 <p>*Shown Above: TB-R48-DSQ-M-D</p>  <p>*Round Table Shape</p>	Round Table, 48" Diameter,	48"	48"	29"		<p>Each Table Top is constructed using a 1 1/8" thick top with a Plastic Laminate top surface.</p> <p>All Metal legs are coated electrostatically with an epoxy powder coat paint.</p> <p>NOTES: * Table heights of 25" (children), 27" (youth), and 32" (wheelchair) are available by request. * Color of Metal Paint must be specified at the time of order. * Caster Leg options are recommended for Reading/Multipurpose Tables options and not meant to be used for stationary computer workstations. * For all tables with casters legs, only 2 legs will have casters, and the other legs will have levelers. This will create a "wheelbarrow" style of table which will ensure ease of mobility. * Color of the Caster Option must be specified at the time of order.</p>	
		DROPPED SQUARE Edge;					
		with WOOD Leg Option:	48"	48"	29"		
	TB-R48-DSQ-W-SQ	Square					\$ 1,270
	TB-R48-DSQ-W-SQR	Square Radius					\$ 1,270
	TB-R48-DSQ-W-SQT	Square Tapered					\$ 1,425
	TB-R48-DSQ-W-DT	Diameter Tapered					\$ 1,555
	TB-R48-DSQ-W-SR	Safari					\$ 1,560
		with METAL Leg Option:	48"	48"	29"		
	TB-R48-DSQ-M-SQ	Square					\$ 1,205
TB-R48-DSQ-M-SS	Square & Stem				\$ 1,630		
TB-R48-DSQ-M-D	Diameter				\$ 1,205		
TB-R48-DSQ-M-DS	Diameter & Stem				\$ 1,630		
TB-R48-DSQ-M-BO	Balloon				\$ 1,310		
TB-R48-DSQ-MC-SQ	Square with Casters				\$ 1,430		
TB-R48-DSQ-MC-SS	Square & Stem with Casters				\$ 1,855		
TB-R48-DSQ-MC-D	Diameter with Casters				\$ 1,430		
TB-R48-DSQ-MC-DS	Diameter & Stem with Casters				\$ 1,855		

Edge Option:



Metal Leg Options:

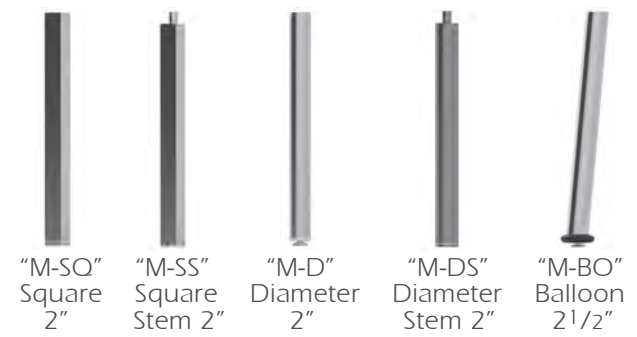

Wood Leg Options:

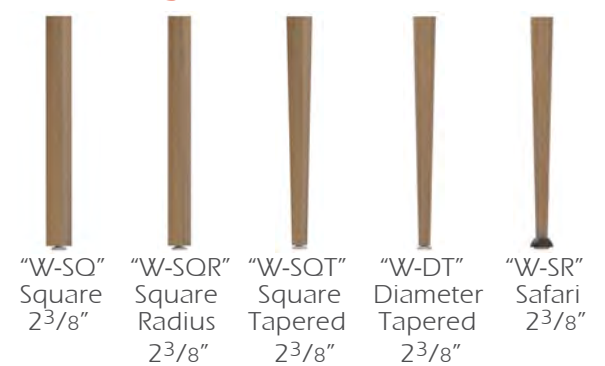

"MC" Caster Option:
 Available on all Metal Legs ONLY, with exception of the Balloon leg and Metal Bases.

KREATIONS

MODEL NUMBER	PRODUCT	WIDTH	DEPTH	HEIGHT	PRICE	DESCRIPTION
 <p>*Shown Above: TB-R48-DBN-M-D</p>	Round Table, 48" Diameter,	48"	48"	29"		Each Table Top is constructed using a 1 1/8" thick top with a Plastic Laminate top surface. All Metal legs are coated electrostatically with an epoxy powder coat paint. NOTES: * Table heights of 25" (children), 27" (youth), and 32" (wheelchair) are available by request. * Color of Metal Paint must be specified at the time of order. * Caster Leg options are recommended for Reading/Multipurpose Tables options and not meant to be used for stationary computer workstations. * For all tables with casters legs, only 2 legs will have casters, and the other legs will have levelers. This will create a "wheelbarrow" style of table which will ensure ease of mobility. * Color of the Caster Option must be specified at the time of order.
	DROPPED BULLNOSE Edge;					
	with WOOD Leg Option:	48"	48"	29"		
	TB-R48-DBN-W-SQ Square	\$ 1,285				
	TB-R48-DBN-W-SQR Square Radius	\$ 1,285				
TB-R48-DBN-W-SQT Square Tapered	\$ 1,435					
TB-R48-DBN-W-DT Diameter Tapered	\$ 1,565					
TB-R48-DBN-W-SR Safari	\$ 1,570					
 <p>*Round Table Shape</p>	with METAL Leg Option:	48"	48"	29"		
	TB-R48-DBN-M-SQ Square	\$ 1,220				
	TB-R48-DBN-M-SS Square & Stem	\$ 1,640				
	TB-R48-DBN-M-D Diameter	\$ 1,220				
	TB-R48-DBN-M-DS Diameter & Stem	\$ 1,640				
	TB-R48-DBN-M-BO Balloon	\$ 1,320				
	TB-R48-DBN-MC-SQ Square with Casters	\$ 1,445				
	TB-R48-DBN-MC-SS Square & Stem with Casters	\$ 1,870				
	TB-R48-DBN-MC-D Diameter with Casters	\$ 1,445				
TB-R48-DBN-MC-DS Diameter & Stem with Casters	\$ 1,870					

Edge Option:



Metal Leg Options:

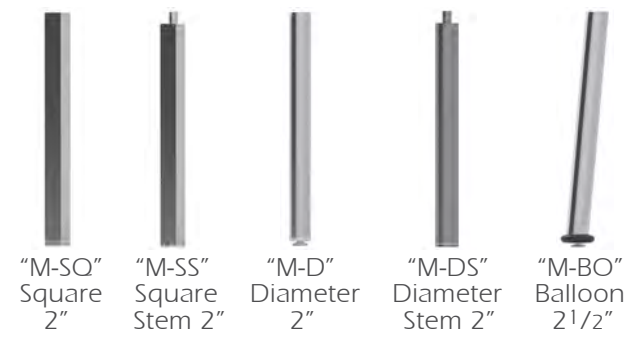

Wood Leg Options:

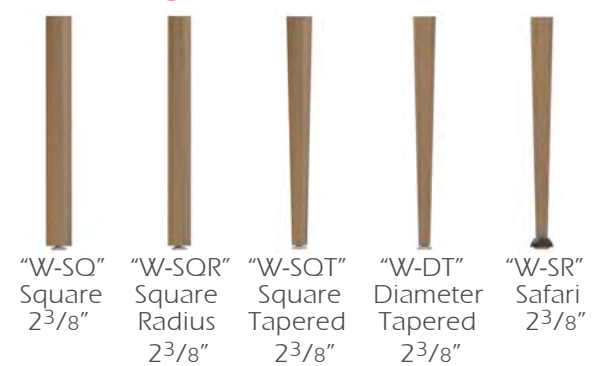

"MC" Caster Option:
 Available on all Metal Legs ONLY, with exception of the Balloon leg and Metal Bases.

KREATIONS

MODEL NUMBER	PRODUCT	WIDTH	DEPTH	HEIGHT	PRICE	DESCRIPTION
 <p>*Shown Above: TB-R48-DCH-M-D</p>  <p>*Round Table Shape</p>	Round Table, 48" Diameter,	48"	48"	29"		Each Table Top is constructed using a 1 1/8" thick top with a Plastic Laminate top surface.
	DROPPED CHAMFERED Edge;					All Metal legs are coated electrostatically with an epoxy powder coat paint.
	with WOOD Leg Option:	48"	48"	29"		NOTES:
	TB-R48-DCH-W-SQ Square				\$ 1,285	* Table heights of 25" (children), 27" (youth), and 32" (wheelchair) are available by request.
	TB-R48-DCH-W-SQR Square Radius				\$ 1,285	* Color of Metal Paint must be specified at the time of order.
	TB-R48-DCH-W-SQT Square Tapered				\$ 1,435	* Caster Leg options are recommended for Reading/Multipurpose Tables options and not meant to be used for stationary computer workstations.
	TB-R48-DCH-W-DT Diameter Tapered				\$ 1,565	* For all tables with casters legs, only 2 legs will have casters, and the other legs will have levelers. This will create a "wheelbarrow" style of table which will ensure ease of mobility.
	TB-R48-DCH-W-SR Safari				\$ 1,570	* Color of the Caster Option must be specified at the time of order.
	with METAL Leg Option:	48"	48"	29"		
	TB-R48-DCH-M-SQ Square				\$ 1,220	
TB-R48-DCH-M-SS Square & Stem				\$ 1,640		
TB-R48-DCH-M-D Diameter				\$ 1,220		
TB-R48-DCH-M-DS Diameter & Stem				\$ 1,640		
TB-R48-DCH-M-BO Balloon				\$ 1,320		
TB-R48-DCH-MC-SQ Square with Casters				\$ 1,445		
TB-R48-DCH-MC-SS Square & Stem with Casters				\$ 1,870		
TB-R48-DCH-MC-D Diameter with Casters				\$ 1,445		
TB-R48-DCH-MC-DS Diameter & Stem with Casters				\$ 1,870		

Edge Option:



Metal Leg Options:

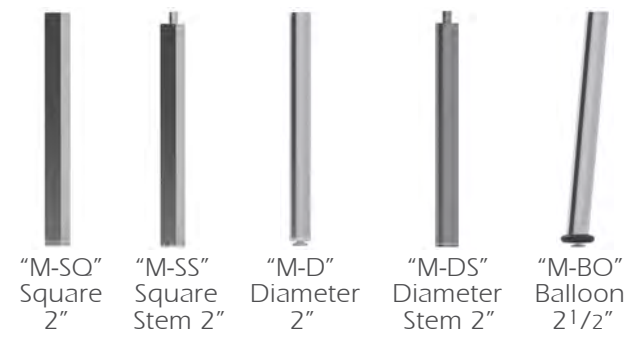

Wood Leg Options:

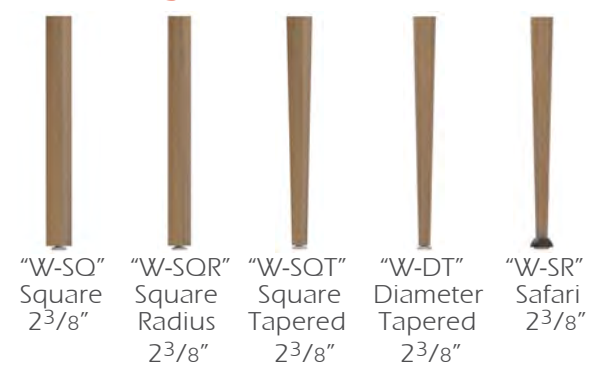

"MC" Caster Option:
Available on all Metal Legs ONLY, with exception of the Balloon leg and Metal Bases.

KREATIONS

MODEL NUMBER	PRODUCT	WIDTH	DEPTH	HEIGHT	PRICE	DESCRIPTION	
 <p>*Shown Above: TB-R48-AL-M-D</p>	Round Table, 48" Diameter,	48"	48"	29"		<p>Each Table Top is constructed using a 1 1/8" thick top with a Plastic Laminate top surface.</p> <p>All Metal legs are coated electrostatically with an epoxy powder coat paint.</p> <p>NOTES: * Table heights of 25" (children), 27" (youth), and 32" (wheelchair) are available by request. * Color of Metal Paint must be specified at the time of order. * Caster Leg options are recommended for Reading/Multipurpose Tables options and not meant to be used for stationary computer workstations. * For all tables with casters legs, only 2 legs will have casters, and the other legs will have levelers. This will create a "wheelbarrow" style of table which will ensure ease of mobility. * Color of the Caster Option must be specified at the time of order.</p>	
	ALUMINUM Edge;						
	with WOOD Leg Option:	48"	48"	29"			
	TB-R48-AL-W-SQ TB-R48-AL-W-SQR TB-R48-AL-W-SQT TB-R48-AL-W-DT TB-R48-AL-W-SR	Square Square Radius Square Tapered Diameter Tapered Safari					\$ 1,160 \$ 1,160 \$ 1,315 \$ 1,445 \$ 1,450
	with METAL Leg Option:	48"	48"	29"			
TB-R48-AL-M-SQ TB-R48-AL-M-SS TB-R48-AL-M-D TB-R48-AL-M-DS TB-R48-AL-M-BO TB-R48-AL-MC-SQ TB-R48-AL-MC-SS TB-R48-AL-MC-D TB-R48-AL-MC-DS	Square Square & Stem Diameter Diameter & Stem Balloon Square with Casters Square & Stem with Casters Diameter with Casters Diameter & Stem with Casters				\$ 1,095 \$ 1,520 \$ 1,095 \$ 1,520 \$ 1,200 \$ 1,325 \$ 1,745 \$ 1,325 \$ 1,745		
TB-R48-AL-FP1 TB-R48-AL-FP2 TB-R48-AL-FP3 TB-R48-AL-TP1 TB-R48-AL-TP2 TB-R48-AL-TP3	Flat Pedestal 19" H Flat Pedestal 29" H Flat Pedestal 42" H Trumpet 19" H Trumpet 29" H Trumpet 42" H	48" 48" 48" 48" 48" 48"	48" 48" 48" 48" 48" 48"	19" 29" 42" 19" 29" 42"	\$ 1,970 \$ 1,970 \$ 2,045 \$ 1,370 \$ 1,370 \$ 1,550		



*Round Table Shape

Edge Option:



"AL"
3mm Aluminum Edge

Metal Leg Options:



"M-SQ" Square 2"
 "M-SS" Square Stem 2"
 "M-D" Diameter 2"
 "M-DS" Diameter Stem 2"
 "M-BO" Balloon 2 1/2"
 "FP" Flat Pedestal Base
 "TP" Trumpet Base

Wood Leg Options:



"W-SQ" Square 2 3/8"
 "W-SQR" Square Radius 2 3/8"
 "W-SQT" Square Tapered 2 3/8"
 "W-DT" Diameter Tapered 2 3/8"
 "W-SR" Safari 2 3/8"



Black/Black
 White/Grey
 Silver/Orange
 Mirror Finish/Grey

"MC" Caster Option:
 Available on all Metal Legs ONLY, with exception of the Balloon leg and Metal Bases.

KREATIONS

MODEL NUMBER	PRODUCT	WIDTH	DEPTH	HEIGHT	PRICE	DESCRIPTION
 <p>*Shown Above: TB-3030-AC-M-D</p>  <p>*Square Table Shape</p>	Square Table, 30" Width,	30"	30"	29"		<p>Each Table Top is constructed using a 1" thick top with a Plastic Laminate top surface.</p> <p>All Metal legs are coated electrostatically with an epoxy powder coat paint.</p> <p>NOTES: * Table heights of 25" (children), 27" (youth), and 32" (wheelchair) are available by request. * Color of Metal Paint must be specified at the time of order. * Caster Leg options are recommended for Reading/Multipurpose Tables options and not meant to be used for stationary computer workstations. * For all tables with casters legs, only 2 legs will have casters, and the other legs will have levelers. This will create a "wheelbarrow" style of table which will ensure ease of mobility. * Color of the Caster Option must be specified at the time of order.</p>
	ACRYLIC Edge;					
	with WOOD Leg Option:	30"	30"	29"		
	TB-3030-AC-W-SQ Square				\$ 815	
	TB-3030-AC-W-SQR Square Radius				\$ 815	
	TB-3030-AC-W-SQT Square Tapered				\$ 970	
	TB-3030-AC-W-DT Diameter Tapered				\$ 1,095	
	TB-3030-AC-W-SR Safari				\$ 1,105	
	with METAL Leg Option:	30"	30"	29"		
	TB-3030-AC-M-SQ Square				\$ 750	
TB-3030-AC-M-SS Square & Stem				\$ 1,175		
TB-3030-AC-M-D Diameter				\$ 750		
TB-3030-AC-M-DS Diameter & Stem				\$ 1,175		
TB-3030-AC-M-BO Balloon				\$ 855		
TB-3030-AC-MC-SQ Square with Casters				\$ 980		
TB-3030-AC-MC-SS Square & Stem with Casters				\$ 1,400		
TB-3030-AC-MC-D Diameter with Casters				\$ 980		
TB-3030-AC-MC-DS Diameter & Stem with Casters				\$ 1,400		

Edge Option:

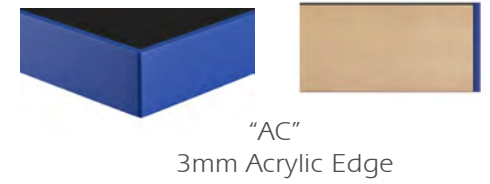

Metal Leg Options:

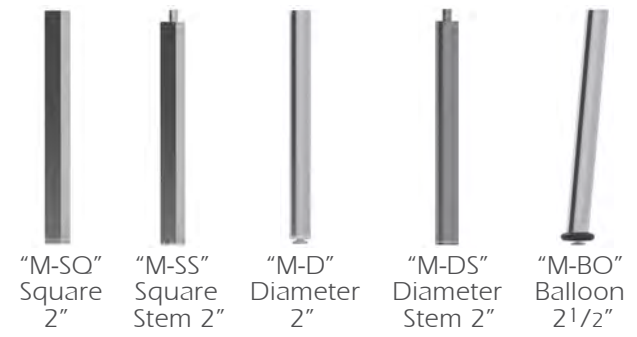

Wood Leg Options:

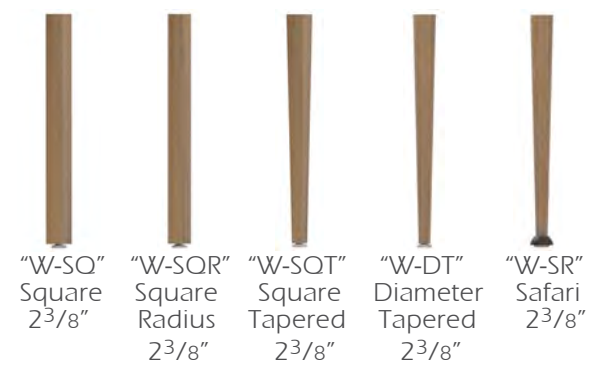

"MC" Caster Option:
 Available on all Metal Legs ONLY, with exception of the Balloon leg and Metal Bases.

KREATIONS

MODEL NUMBER	PRODUCT	WIDTH	DEPTH	HEIGHT	PRICE	DESCRIPTION	
 <p>*Shown Above: TB-3030-SQ-M-D</p>	Square Table, 30" Width,	30"	30"	29"		<p>Each Table Top is constructed using a 1 1/8" thick top with a Plastic Laminate top surface.</p> <p>All Metal legs are coated electrostatically with an epoxy powder coat paint.</p> <p>NOTES: * Table heights of 25" (children), 27" (youth), and 32" (wheelchair) are available by request. * Color of Metal Paint must be specified at the time of order. * Caster Leg options are recommended for Reading/Multipurpose Tables options and not meant to be used for stationary computer workstations. * For all tables with casters legs, only 2 legs will have casters, and the other legs will have levelers. This will create a "wheelbarrow" style of table which will ensure ease of mobility. * Color of the Caster Option must be specified at the time of order.</p>	
	SQUARE Edge;						
	with WOOD Leg Option:	30"	30"	29"			
	TB-3030-SQ-W-SQ TB-3030-SQ-W-SQR TB-3030-SQ-W-SQT TB-3030-SQ-W-DT TB-3030-SQ-W-SR	Square Square Radius Square Tapered Diameter Tapered Safari					\$ 905 \$ 905 \$ 1,060 \$ 1,190 \$ 1,195
	with METAL Leg Option:	30"	30"	29"			
TB-3030-SQ-M-SQ TB-3030-SQ-M-SS TB-3030-SQ-M-D TB-3030-SQ-M-DS TB-3030-SQ-M-BO TB-3030-SQ-MC-SQ TB-3030-SQ-MC-SS TB-3030-SQ-MC-D TB-3030-SQ-MC-DS	Square Square & Stem Diameter Diameter & Stem Balloon Square with Casters Square & Stem with Casters Diameter with Casters Diameter & Stem with Casters				\$ 840 \$ 1,270 \$ 840 \$ 1,270 \$ 945 \$ 1,070 \$ 1,490 \$ 1,070 \$ 1,490		



*Square Table Shape

Edge Option:



"SQ"
1/4" Square Edge

Metal Leg Options:



"M-SQ" Square 2"
 "M-SS" Square Stem 2"
 "M-D" Diameter 2"
 "M-DS" Diameter Stem 2"
 "M-BO" Balloon 2 1/2"

Wood Leg Options:



"W-SQ" Square 2 3/8"
 "W-SQR" Square Radius 2 3/8"
 "W-SQT" Square Tapered 2 3/8"
 "W-DT" Diameter Tapered 2 3/8"
 "W-SR" Safari 2 3/8"



Black/Black White/Grey Silver/Orange Mirror Finish/Grey
"MC" Caster Option:
 Available on all Metal Legs ONLY, with exception of the Balloon leg and Metal Bases.

KREATIONS

MODEL NUMBER	PRODUCT	WIDTH	DEPTH	HEIGHT	PRICE	DESCRIPTION
 <p>*Shown Above: TB-3030-DSQ-M-D</p>  <p>*Square Table Shape</p>	Square Table, 30" Width, DROPPED SQUARE Edge;	30"	30"	29"		Each Table Top is constructed using a 1 1/8" thick top with a Plastic Laminate top surface. All Metal legs are coated electrostatically with an epoxy powder coat paint.
	with WOOD Leg Option:	30"	30"	29"		NOTES: * Table heights of 25" (children), 27" (youth), and 32" (wheelchair) are available by request. * Color of Metal Paint must be specified at the time of order. * Caster Leg options are recommended for Reading/Multipurpose Tables options and not meant to be used for stationary computer workstations. * For all tables with casters legs, only 2 legs will have casters, and the other legs will have levelers. This will create a "wheelbarrow" style of table which will ensure ease of mobility. * Color of the Caster Option must be specified at the time of order.
	TB-3030-DSQ-W-SQ	Square			\$ 970	
	TB-3030-DSQ-W-SQR	Square Radius			\$ 970	
	TB-3030-DSQ-W-SQT	Square Tapered			\$ 1,125	
	TB-3030-DSQ-W-DT	Diameter Tapered			\$ 1,255	
	TB-3030-DSQ-W-SR	Safari			\$ 1,260	
	with METAL Leg Option:	30"	30"	29"		
	TB-3030-DSQ-M-SQ	Square			\$ 905	
	TB-3030-DSQ-M-SS	Square & Stem			\$ 1,330	
TB-3030-DSQ-M-D	Diameter			\$ 905		
TB-3030-DSQ-M-DS	Diameter & Stem			\$ 1,330		
TB-3030-DSQ-M-BO	Balloon			\$ 1,010		
TB-3030-DSQ-MC-SQ	Square with Casters			\$ 1,135		
TB-3030-DSQ-MC-SS	Square & Stem with Casters			\$ 1,555		
TB-3030-DSQ-MC-D	Diameter with Casters			\$ 1,135		
TB-3030-DSQ-MC-DS	Diameter & Stem with Casters			\$ 1,555		

Edge Option:



Metal Leg Options:

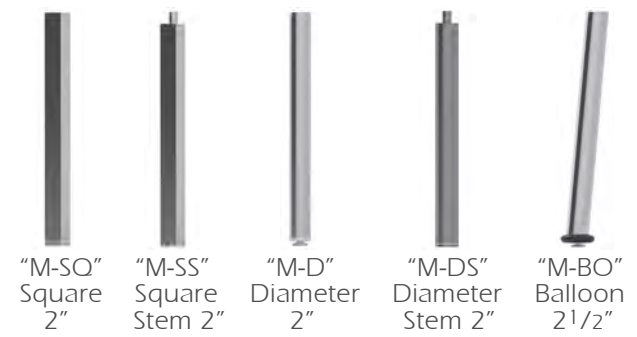

Wood Leg Options:

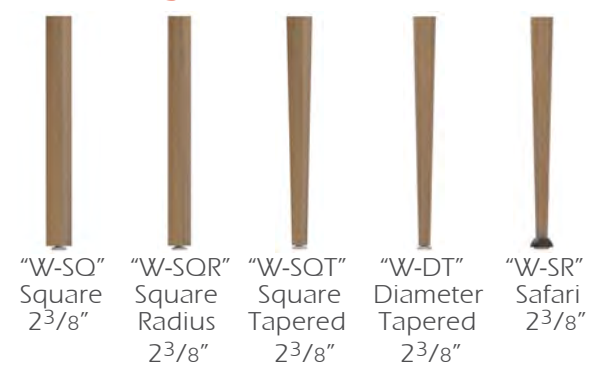

"MC" Caster Option:
Available on all Metal Legs ONLY, with exception of the Balloon leg and Metal Bases.

KREATIONS

MODEL NUMBER	PRODUCT	WIDTH	DEPTH	HEIGHT	PRICE	DESCRIPTION
 <p>*Shown Above: TB-3030-DBN-M-D</p>  <p>*Square Table Shape</p>	Square Table, 30" Width, DROPPED BULLNOSE Edge;	30"	30"	29"		Each Table Top is constructed using a 1 1/8" thick top with a Plastic Laminate top surface. All Metal legs are coated electrostatically with an epoxy powder coat paint.
	with WOOD Leg Option:	30"	30"	29"		NOTES: * Table heights of 25" (children), 27" (youth), and 32" (wheelchair) are available by request. * Color of Metal Paint must be specified at the time of order. * Caster Leg options are recommended for Reading/Multipurpose Tables options and not meant to be used for stationary computer workstations. * For all tables with casters legs, only 2 legs will have casters, and the other legs will have levelers. This will create a "wheelbarrow" style of table which will ensure ease of mobility. * Color of the Caster Option must be specified at the time of order.
	TB-3030-DBN-W-SQ Square				\$ 985	
	TB-3030-DBN-W-SQR Square Radius				\$ 985	
	TB-3030-DBN-W-SQT Square Tapered				\$ 1,135	
	TB-3030-DBN-W-DT Diameter Tapered				\$ 1,265	
	TB-3030-DBN-W-SR Safari				\$ 1,270	
	with METAL Leg Option:	30"	30"	29"		
	TB-3030-DBN-M-SQ Square				\$ 920	
	TB-3030-DBN-M-SS Square & Stem				\$ 1,345	
TB-3030-DBN-M-D Diameter				\$ 920		
TB-3030-DBN-M-DS Diameter & Stem				\$ 1,345		
TB-3030-DBN-M-BO Balloon				\$ 1,020		
TB-3030-DBN-MC-SQ Square with Casters				\$ 1,145		
TB-3030-DBN-MC-SS Square & Stem with Casters				\$ 1,570		
TB-3030-DBN-MC-D Diameter with Casters				\$ 1,145		
TB-3030-DBN-MC-DS Diameter & Stem with Casters				\$ 1,570		

Edge Option:



Metal Leg Options:

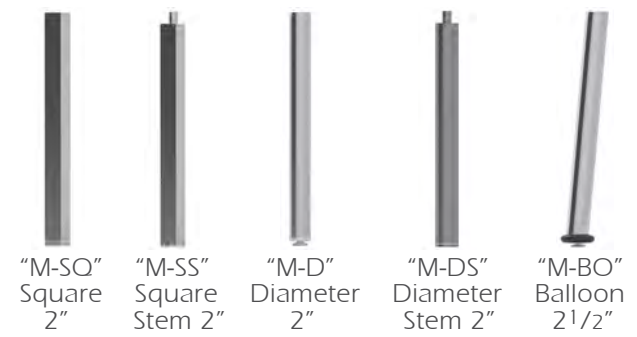

Wood Leg Options:

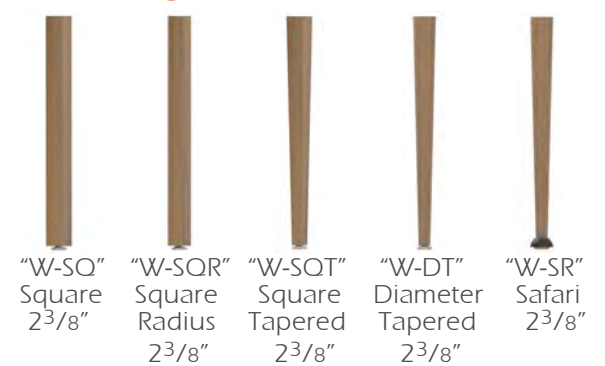

"MC" Caster Option:
Available on all Metal Legs ONLY, with exception of the Balloon leg and Metal Bases.

KREATIONS

MODEL NUMBER	PRODUCT	WIDTH	DEPTH	HEIGHT	PRICE	DESCRIPTION	
 <p>*Shown Above: TB-3030-DCH-M-D</p>  <p>*Square Table Shape</p>	Square Table, 30" Width,	30"	30"	29"		<p>Each Table Top is constructed using a 1 1/8" thick top with a Plastic Laminate top surface.</p> <p>All Metal legs are coated electrostatically with an epoxy powder coat paint.</p> <p>NOTES: * Table heights of 25" (children), 27" (youth), and 32" (wheelchair) are available by request. * Color of Metal Paint must be specified at the time of order. * Caster Leg options are recommended for Reading/Multipurpose Tables options and not meant to be used for stationary computer workstations. * For all tables with casters legs, only 2 legs will have casters, and the other legs will have levelers. This will create a "wheelbarrow" style of table which will ensure ease of mobility. * Color of the Caster Option must be specified at the time of order.</p>	
	DROPPED CHAMFERED Edge;						
	TB-3030-DCH-W-SQ	with WOOD Leg Option: Square	30"	30"	29"		\$ 985
	TB-3030-DCH-W-SQR	Square Radius					\$ 985
	TB-3030-DCH-W-SQT	Square Tapered					\$ 1,135
	TB-3030-DCH-W-DT	Diameter Tapered					\$ 1,265
	TB-3030-DCH-W-SR	Safari					\$ 1,270
	with METAL Leg Option:						
	TB-3030-DCH-M-SQ	Square	30"	30"	29"		\$ 920
	TB-3030-DCH-M-SS	Square & Stem					\$ 1,345
TB-3030-DCH-M-D	Diameter				\$ 920		
TB-3030-DCH-M-DS	Diameter & Stem				\$ 1,345		
TB-3030-DCH-M-BO	Balloon				\$ 1,020		
TB-3030-DCH-MC-SQ	Square with Casters				\$ 1,145		
TB-3030-DCH-MC-SS	Square & Stem with Casters				\$ 1,570		
TB-3030-DCH-MC-D	Diameter with Casters				\$ 1,145		
TB-3030-DCH-MC-DS	Diameter & Stem with Casters				\$ 1,570		

Edge Option:



Metal Leg Options:

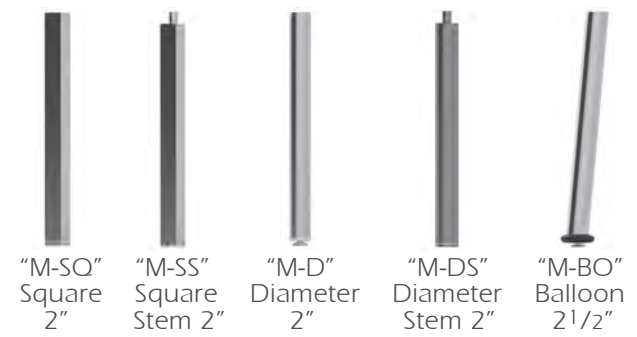

Wood Leg Options:

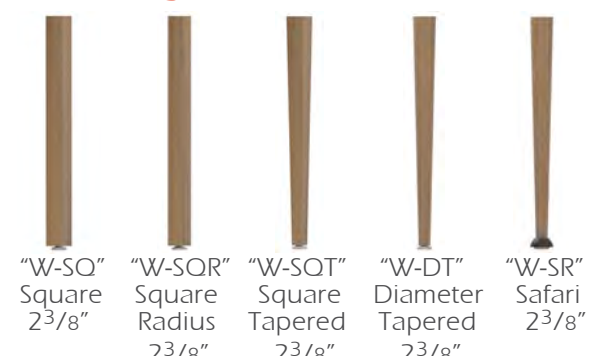

"MC" Caster Option:
 Available on all Metal Legs ONLY, with exception of the Balloon leg and Metal Bases.

KREATIONS

MODEL NUMBER	PRODUCT	WIDTH	DEPTH	HEIGHT	PRICE	DESCRIPTION	
 *Shown Above: TB-3030-AL-M-D	Square Table, 30" Width,	30"	30"	29"		Each Table Top is constructed using a 1 1/8" thick top with a Plastic Laminate top surface. All Metal legs are coated electrostatically with an epoxy powder coat paint. NOTES: * Table heights of 25" (children), 27" (youth), and 32" (wheelchair) are available by request. * Color of Metal Paint must be specified at the time of order. * Caster Leg options are recommended for Reading/Multipurpose Tables options and not meant to be used for stationary computer workstations. * For all tables with casters legs, only 2 legs will have casters, and the other legs will have levelers. This will create a "wheelbarrow" style of table which will ensure ease of mobility. * Color of the Caster Option must be specified at the time of order.	
	ALUMINUM Edge;						
	with WOOD Leg Option:	30"	30"	29"			
	TB-3030-AL-W-SQ TB-3030-AL-W-SQR TB-3030-AL-W-SQT TB-3030-AL-W-DT TB-3030-AL-W-SR	Square Square Radius Square Tapered Diameter Tapered Safari					\$ 870 \$ 870 \$ 1,020 \$ 1,150 \$ 1,160
	with METAL Leg Option:	30"	30"	29"			
TB-3030-AL-M-SQ TB-3030-AL-M-SS TB-3030-AL-M-D TB-3030-AL-M-DS TB-3030-AL-M-BO TB-3030-AL-MC-SQ TB-3030-AL-MC-SS TB-3030-AL-MC-D TB-3030-AL-MC-DS	Square Square & Stem Diameter Diameter & Stem Balloon Square with Casters Square & Stem with Casters Diameter with Casters Diameter & Stem with Casters				\$ 805 \$ 1,230 \$ 805 \$ 1,230 \$ 905 \$ 1,030 \$ 1,455 \$ 1,030 \$ 1,455		



*Square Table Shape

Edge Option:



"AL"

3mm Aluminum Edge *All table corners will be given a 6-inch radius for this edge option.

Metal Leg Options:



"M-SQ" Square 2"
 "M-SS" Square Stem 2"
 "M-D" Diameter 2"
 "M-DS" Diameter Stem 2"
 "M-BO" Balloon 2 1/2"

Wood Leg Options:





"W-SQ" Square 2 3/8"
 "W-SQR" Square Radius 2 3/8"
 "W-SQT" Square Tapered 2 3/8"
 "W-DT" Diameter Tapered 2 3/8"
 "W-SR" Safari 2 3/8"



"MC" Caster Option:
 Available on all Metal Legs ONLY, with exception of the Balloon leg and Metal Bases.

KREATIONS

MODEL NUMBER	PRODUCT	WIDTH	DEPTH	HEIGHT	PRICE	DESCRIPTION	
 <p>*Shown Above: TB-3636-AC-M-D</p>  <p>*Square Table Shape</p>	Square Table, 36" Width,	36"	36"	29"		Each Table Top is constructed using a 1" thick top with a Plastic Laminate top surface.	
	ACRYLIC Edge;					All Metal legs are coated electrostatically with an epoxy powder coat paint.	
	with WOOD Leg Option:	36"	36"	29"		NOTES:	
	TB-3636-AC-W-SQ TB-3636-AC-W-SQR TB-3636-AC-W-SQT TB-3636-AC-W-DT TB-3636-AC-W-SR	Square Square Radius Square Tapered Diameter Tapered Safari				\$ 855 \$ 855 \$ 1,005 \$ 1,135 \$ 1,140	* Table heights of 25" (children), 27" (youth), and 32" (wheelchair) are available by request. * Color of Metal Paint must be specified at the time of order. * Caster Leg options are recommended for Reading/Multipurpose Tables options and not meant to be used for stationary computer workstations. * For all tables with casters legs, only 2 legs will have casters, and the other legs will have levelers. This will create a "wheelbarrow" style of table which will ensure ease of mobility. * Color of the Caster Option must be specified at the time of order.
	with METAL Leg Option:	36"	36"	29"			
TB-3636-AC-M-SQ TB-3636-AC-M-SS TB-3636-AC-M-D TB-3636-AC-M-DS TB-3636-AC-M-BO TB-3636-AC-MC-SQ TB-3636-AC-MC-SS TB-3636-AC-MC-D TB-3636-AC-MC-DS	Square Square & Stem Diameter Diameter & Stem Balloon Square with Casters Square & Stem with Casters Diameter with Casters Diameter & Stem with Casters				\$ 790 \$ 1,210 \$ 790 \$ 1,215 \$ 890 \$ 1,015 \$ 1,440 \$ 1,015 \$ 1,440		
TB-3636-AC-FP1 TB-3636-AC-FP2 TB-3636-AC-FP3 TB-3636-AC-TP1 TB-3636-AC-TP2 TB-3636-AC-TP3	Flat Pedestal 19" H Flat Pedestal 29" H Flat Pedestal 42" H Trumpet 19" H Trumpet 29" H Trumpet 42" H	36" 36" 36" 36" 36" 36"	36" 36" 36" 36" 36" 36"	19" 29" 42" 19" 29" 42"	\$ 1,150 \$ 1,150 \$ 1,340 \$ 875 \$ 875 \$ 1,240		

Edge Option:

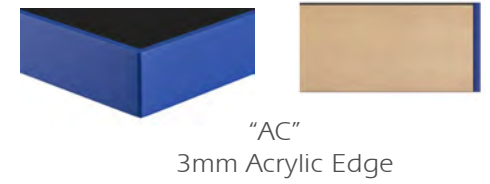

Metal Leg Options:

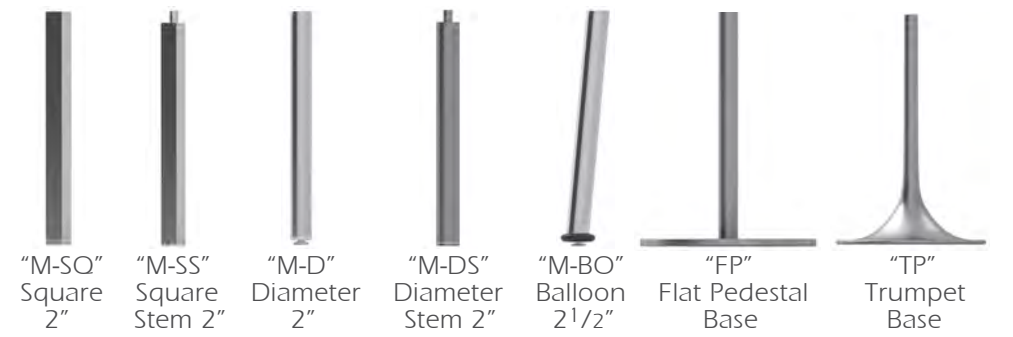

Wood Leg Options:

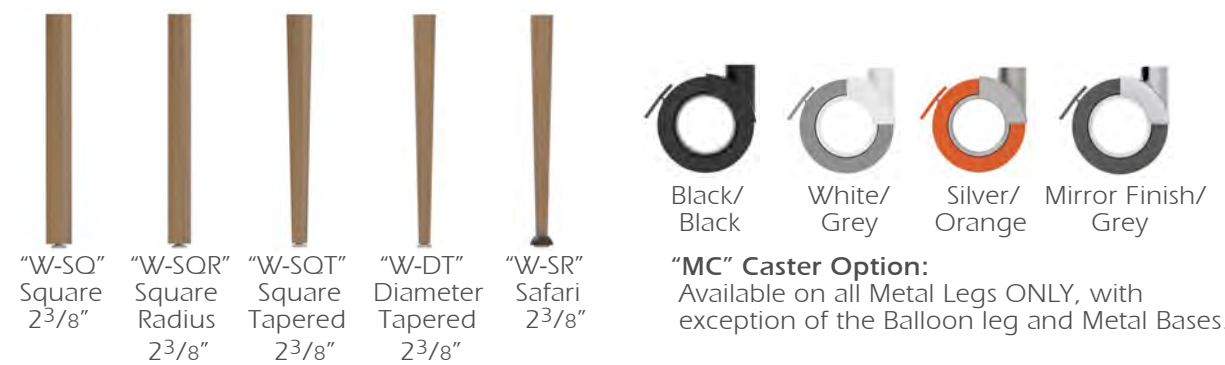

KREATIONS

MODEL NUMBER	PRODUCT	WIDTH	DEPTH	HEIGHT	PRICE	DESCRIPTION	
 <p>*Shown Above: TB-3636-SQ-M-D</p>	Square Table, 36" Width,	36"	36"	29"		<p>Each Table Top is constructed using a 1 1/8" thick top with a Plastic Laminate top surface.</p> <p>All Metal legs are coated electrostatically with an epoxy powder coat paint.</p> <p>NOTES: * Table heights of 25" (children), 27" (youth), and 32" (wheelchair) are available by request. * Color of Metal Paint must be specified at the time of order. * Caster Leg options are recommended for Reading/Multipurpose Tables options and not meant to be used for stationary computer workstations. * For all tables with casters legs, only 2 legs will have casters, and the other legs will have levelers. This will create a "wheelbarrow" style of table which will ensure ease of mobility. * Color of the Caster Option must be specified at the time of order.</p>	
	SQUARE Edge;						
	with WOOD Leg Option:	36"	36"	29"			
	TB-3636-SQ-W-SQ TB-3636-SQ-W-SQR TB-3636-SQ-W-SQT TB-3636-SQ-W-DT TB-3636-SQ-W-SR	Square Square Radius Square Tapered Diameter Tapered Safari					\$ 970 \$ 970 \$ 1,120 \$ 1,250 \$ 1,255
	with METAL Leg Option:	36"	36"	29"			
TB-3636-SQ-M-SQ TB-3636-SQ-M-SS TB-3636-SQ-M-D TB-3636-SQ-M-DS TB-3636-SQ-M-BO TB-3636-SQ-MC-SQ TB-3636-SQ-MC-SS TB-3636-SQ-MC-D TB-3636-SQ-MC-DS	Square Square & Stem Diameter Diameter & Stem Balloon Square with Casters Square & Stem with Casters Diameter with Casters Diameter & Stem with Casters				\$ 905 \$ 1,330 \$ 905 \$ 1,330 \$ 1,005 \$ 1,125 \$ 1,555 \$ 1,125 \$ 1,555		



*Square Table Shape

Edge Option:



"SQ"
1/4" Square Edge

Metal Leg Options:



"M-SQ" Square 2"
 "M-SS" Square Stem 2"
 "M-D" Diameter 2"
 "M-DS" Diameter Stem 2"
 "M-BO" Balloon 2 1/2"

Wood Leg Options:



"W-SQ" Square 2 3/8"
 "W-SQR" Square Radius 2 3/8"
 "W-SQT" Square Tapered 2 3/8"
 "W-DT" Diameter Tapered 2 3/8"
 "W-SR" Safari 2 3/8"



Black/Black White/Grey Silver/Orange Mirror Finish/Grey

"MC" Caster Option:
 Available on all Metal Legs ONLY, with exception of the Balloon leg and Metal Bases.

KREATIONS

MODEL NUMBER	PRODUCT	WIDTH	DEPTH	HEIGHT	PRICE	DESCRIPTION
 <p>*Shown Above: TB-3636-DSQ-M-D</p>  <p>*Square Table Shape</p>	Square Table, 36" Width, DROPPED SQUARE Edge;	36"	36"	29"		Each Table Top is constructed using a 1 1/8" thick top with a Plastic Laminate top surface. All Metal legs are coated electrostatically with an epoxy powder coat paint.
	with WOOD Leg Option:	36"	36"	29"		NOTES: * Table heights of 25" (children), 27" (youth), and 32" (wheelchair) are available by request. * Color of Metal Paint must be specified at the time of order. * Caster Leg options are recommended for Reading/Multipurpose Tables options and not meant to be used for stationary computer workstations. * For all tables with casters legs, only 2 legs will have casters, and the other legs will have levelers. This will create a "wheelbarrow" style of table which will ensure ease of mobility. * Color of the Caster Option must be specified at the time of order.
	TB-3636-DSQ-W-SQ	Square			\$ 1,025	
	TB-3636-DSQ-W-SQR	Square Radius			\$ 1,025	
	TB-3636-DSQ-W-SQT	Square Tapered			\$ 1,170	
	TB-3636-DSQ-W-DT	Diameter Tapered			\$ 1,305	
	TB-3636-DSQ-W-SR	Safari			\$ 1,315	
	with METAL Leg Option:	36"	36"	29"		
	TB-3636-DSQ-M-SQ	Square			\$ 960	
	TB-3636-DSQ-M-SS	Square & Stem			\$ 1,385	
TB-3636-DSQ-M-D	Diameter			\$ 960		
TB-3636-DSQ-M-DS	Diameter & Stem			\$ 1,385		
TB-3636-DSQ-M-BO	Balloon			\$ 1,065		
TB-3636-DSQ-MC-SQ	Square with Casters			\$ 1,185		
TB-3636-DSQ-MC-SS	Square & Stem with Casters			\$ 1,610		
TB-3636-DSQ-MC-D	Diameter with Casters			\$ 1,185		
TB-3636-DSQ-MC-DS	Diameter & Stem with Casters			\$ 1,610		

Edge Option:



Metal Leg Options:

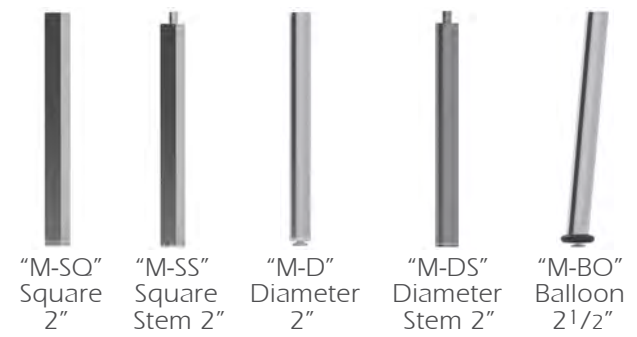

Wood Leg Options:

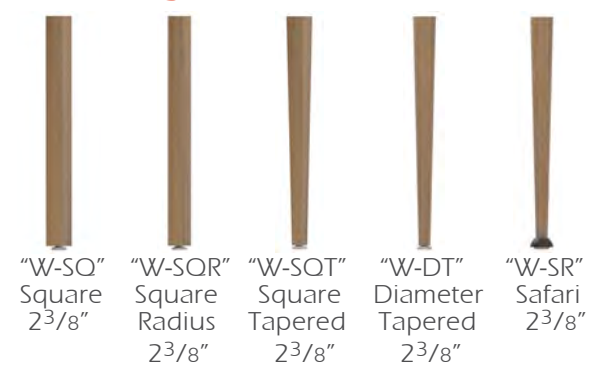

"MC" Caster Option:
Available on all Metal Legs ONLY, with exception of the Balloon leg and Metal Bases.

KREATIONS

MODEL NUMBER	PRODUCT	WIDTH	DEPTH	HEIGHT	PRICE	DESCRIPTION	
 *Shown Above: TB-3636-DBN-M-D	Square Table, 36" Width,	36"	36"	29"		Each Table Top is constructed using a 1 1/8" thick top with a Plastic Laminate top surface. All Metal legs are coated electrostatically with an epoxy powder coat paint. NOTES: * Table heights of 25" (children), 27" (youth), and 32" (wheelchair) are available by request. * Color of Metal Paint must be specified at the time of order. * Caster Leg options are recommended for Reading/Multipurpose Tables options and not meant to be used for stationary computer workstations. * For all tables with casters legs, only 2 legs will have casters, and the other legs will have levelers. This will create a "wheelbarrow" style of table which will ensure ease of mobility. * Color of the Caster Option must be specified at the time of order.	
	DROPPED BULLNOSE Edge;						
	with WOOD Leg Option:	36"	36"	29"			
	TB-3636-DBN-W-SQ TB-3636-DBN-W-SQR TB-3636-DBN-W-SQT TB-3636-DBN-W-DT TB-3636-DBN-W-SR	Square Square Radius Square Tapered Diameter Tapered Safari					\$ 1,035 \$ 1,035 \$ 1,190 \$ 1,315 \$ 1,325
	with METAL Leg Option:	36"	36"	29"			
TB-3636-DBN-M-SQ TB-3636-DBN-M-SS TB-3636-DBN-M-D TB-3636-DBN-M-DS TB-3636-DBN-M-BO TB-3636-DBN-MC-SQ TB-3636-DBN-MC-SS TB-3636-DBN-MC-D TB-3636-DBN-MC-DS	Square Square & Stem Diameter Diameter & Stem Balloon Square with Casters Square & Stem with Casters Diameter with Casters Diameter & Stem with Casters				\$ 970 \$ 1,395 \$ 970 \$ 1,395 \$ 1,075 \$ 1,195 \$ 1,620 \$ 1,195 \$ 1,620		



*Square Table Shape

Edge Option:



"DBN"
3/4" Dropped Bullnoses Edge

Metal Leg Options:



"M-SQ" Square 2"
"M-SS" Square Stem 2"
"M-D" Diameter 2"
"M-DS" Diameter Stem 2"
"M-BO" Balloon 2 1/2"

Wood Leg Options:



"W-SQ" Square 2 3/8"
"W-SQR" Square Radius 2 3/8"
"W-SQT" Square Tapered 2 3/8"
"W-DT" Diameter Tapered 2 3/8"
"W-SR" Safari 2 3/8"



Black/Black White/Grey Silver/Orange Mirror Finish/Grey
"MC" Caster Option:
 Available on all Metal Legs ONLY, with exception of the Balloon leg and Metal Bases.

KREATIONS

MODEL NUMBER	PRODUCT	WIDTH	DEPTH	HEIGHT	PRICE	DESCRIPTION
 <p>*Shown Above: TB-3636-DCH-M-D</p>  <p>*Square Table Shape</p>	Square Table, 36" Width,	36"	36"	29"		Each Table Top is constructed using a 1 1/8" thick top with a Plastic Laminate top surface.
	DROPPED CHAMFERED Edge;					All Metal legs are coated electrostatically with an epoxy powder coat paint.
	with WOOD Leg Option:	36"	36"	29"		NOTES:
	TB-3636-DCH-W-SQ Square				\$ 1,035	* Table heights of 25" (children), 27" (youth), and 32" (wheelchair) are available by request.
	TB-3636-DCH-W-SQR Square Radius				\$ 1,035	* Color of Metal Paint must be specified at the time of order.
	TB-3636-DCH-W-SQT Square Tapered				\$ 1,190	* Caster Leg options are recommended for Reading/Multipurpose Tables options and not meant to be used for stationary computer workstations.
	TB-3636-DCH-W-DT Diameter Tapered				\$ 1,315	* For all tables with casters legs, only 2 legs will have casters, and the other legs will have levelers. This will create a "wheelbarrow" style of table which will ensure ease of mobility.
	TB-3636-DCH-W-SR Safari				\$ 1,325	* Color of the Caster Option must be specified at the time of order.
	with METAL Leg Option:	36"	36"	29"		
	TB-3636-DCH-M-SQ Square				\$ 970	
TB-3636-DCH-M-SS Square & Stem				\$ 1,395		
TB-3636-DCH-M-D Diameter				\$ 970		
TB-3636-DCH-M-DS Diameter & Stem				\$ 1,395		
TB-3636-DCH-M-BO Balloon				\$ 1,075		
TB-3636-DCH-MC-SQ Square with Casters				\$ 1,195		
TB-3636-DCH-MC-SS Square & Stem with Casters				\$ 1,620		
TB-3636-DCH-MC-D Diameter with Casters				\$ 1,195		
TB-3636-DCH-MC-DS Diameter & Stem with Casters				\$ 1,620		

Edge Option:



Metal Leg Options:

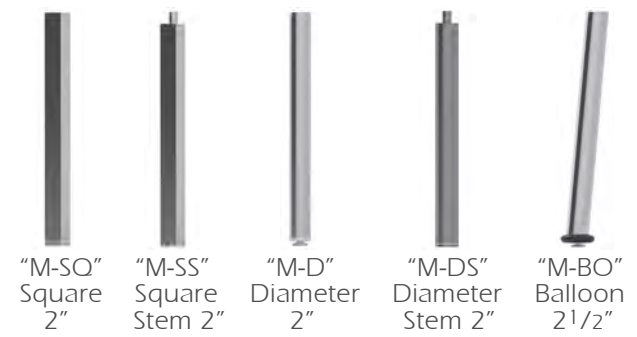

Wood Leg Options:

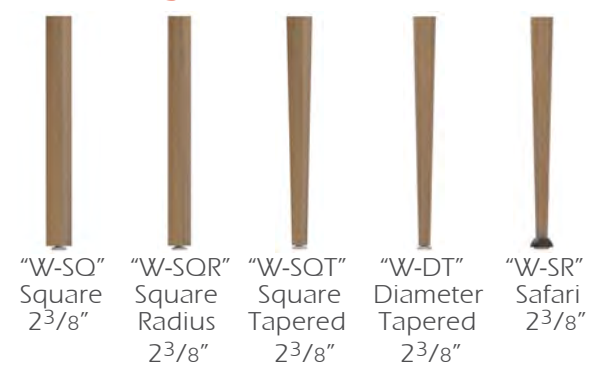

"MC" Caster Option:
Available on all Metal Legs ONLY, with exception of the Balloon leg and Metal Bases.

KREATIONS

MODEL NUMBER	PRODUCT	WIDTH	DEPTH	HEIGHT	PRICE	
 *Shown Above: TB-3636-AL-M-D	Square Table, 36" Width,	36"	36"	29"		
	ALUMINUM Edge;					
	with WOOD Leg Option:	36"	36"	29"		
	TB-3636-AL-W-SQ TB-3636-AL-W-SQR TB-3636-AL-W-SQT TB-3636-AL-W-DT TB-3636-AL-W-SR	Square Square Radius Square Tapered Diameter Tapered Safari				\$ 920 \$ 920 \$ 1,075 \$ 1,205 \$ 1,210
	with METAL Leg Option:	36"	36"	29"		
TB-3636-AL-M-SQ TB-3636-AL-M-SS TB-3636-AL-M-D TB-3636-AL-M-DS TB-3636-AL-M-BO TB-3636-AL-MC-SQ TB-3636-AL-MC-SS TB-3636-AL-MC-D TB-3636-AL-MC-DS	Square Square & Stem Diameter Diameter & Stem Balloon Square with Casters Square & Stem with Casters Diameter with Casters Diameter & Stem with Casters				\$ 855 \$ 1,285 \$ 855 \$ 1,285 \$ 960 \$ 1,080 \$ 1,505 \$ 1,080 \$ 1,505	
TB-3636-AL-FP1 TB-3636-AL-FP2 TB-3636-AL-FP3 TB-3636-AL-TP1 TB-3636-AL-TP2 TB-3636-AL-TP3	Flat Pedestal 19" H Flat Pedestal 29" H Flat Pedestal 42" H Trumpet 19" H Trumpet 29" H Trumpet 42" H	36" 36" 36" 36" 36" 36"	36" 36" 36" 36" 36" 36"	19" 29" 42" 19" 29" 42"	\$ 1,220 \$ 1,330 \$ 1,410 \$ 940 \$ 940 \$ 1,310	



*Square Table Shape

DESCRIPTION

Each Table Top is constructed using a 1 1/8" thick top with a Plastic Laminate top surface.

All Metal legs are coated electrostatically with an epoxy powder coat paint.

NOTES:

- * Table heights of 25" (children), 27" (youth), and 32" (wheelchair) are available by request.
- * Color of Metal Paint must be specified at the time of order.
- * Caster Leg options are recommended for Reading/Multipurpose Tables options and not meant to be used for stationary computer workstations.
- * For all tables with casters legs, only 2 legs will have casters, and the other legs will have levelers. This will create a "wheelbarrow" style of table which will ensure ease of mobility.
- * Color of the Caster Option must be specified at the time of order.

Edge Option:



"AL"
3mm Aluminum Edge *All table corners will be given a 6-inch radius for this edge option.

Metal Leg Options:

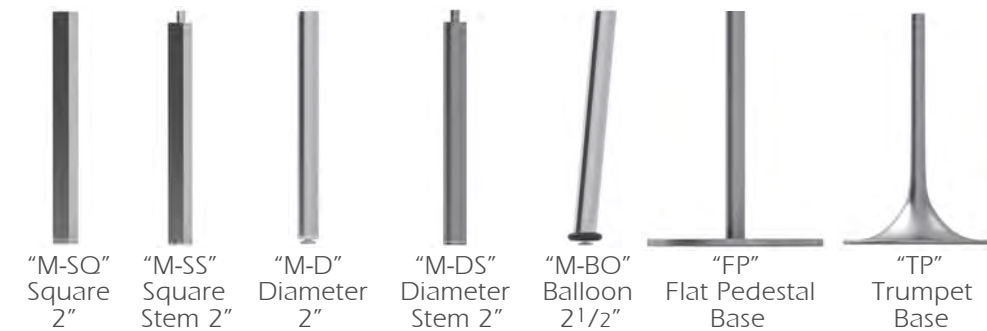

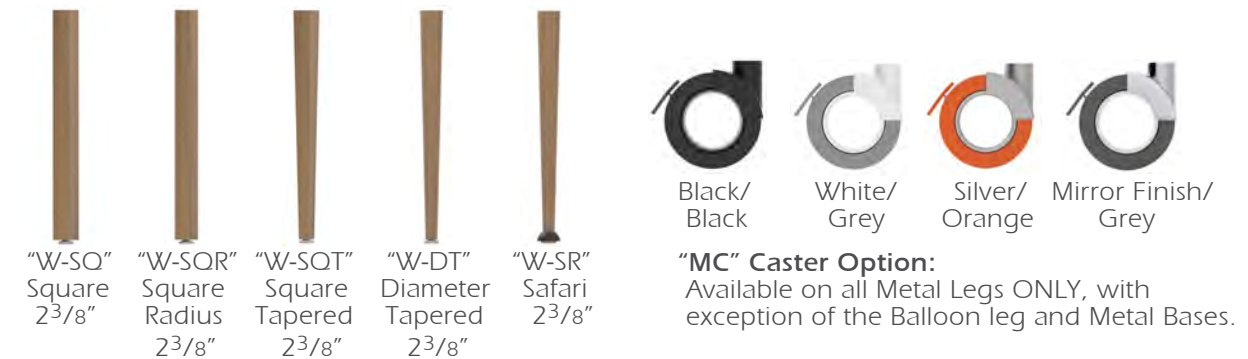

Wood Leg Options:



"MC" Caster Option:
Available on all Metal Legs ONLY, with exception of the Balloon leg and Metal Bases.

KREATIONS

MODEL NUMBER	PRODUCT	WIDTH	DEPTH	HEIGHT	PRICE	DESCRIPTION	
 <p>*Shown Above: TB-4242-AC-M-D</p>  <p>*Square Table Shape</p>	Square Table, 42" Width,	42"	42"	29"		Each Table Top is constructed using a 1" thick top with a Plastic Laminate top surface.	
	ACRYLIC Edge;					All Metal legs are coated electrostatically with an epoxy powder coat paint.	
	with WOOD Leg Option:	42"	42"	29"		NOTES:	
	TB-4242-AC-W-SQ TB-4242-AC-W-SQR TB-4242-AC-W-SQT TB-4242-AC-W-DT TB-4242-AC-W-SR	Square Square Radius Square Tapered Diameter Tapered Safari				\$ 905 \$ 905 \$ 1,055 \$ 1,190 \$ 1,195	* Table heights of 25" (children), 27" (youth), and 32" (wheelchair) are available by request. * Color of Metal Paint must be specified at the time of order. * Caster Leg options are recommended for Reading/Multipurpose Tables options and not meant to be used for stationary computer workstations. * For all tables with casters legs, only 2 legs will have casters, and the other legs will have levelers. This will create a "wheelbarrow" style of table which will ensure ease of mobility. * Color of the Caster Option must be specified at the time of order.
	with METAL Leg Option:	42"	42"	29"			
TB-4242-AC-M-SQ TB-4242-AC-M-SS TB-4242-AC-M-D TB-4242-AC-M-DS TB-4242-AC-M-BO TB-4242-AC-MC-SQ TB-4242-AC-MC-SS TB-4242-AC-MC-D TB-4242-AC-MC-DS	Square Square & Stem Diameter Diameter & Stem Balloon Square with Casters Square & Stem with Casters Diameter with Casters Diameter & Stem with Casters				\$ 840 \$ 1,265 \$ 840 \$ 1,265 \$ 945 \$ 1,065 \$ 1,490 \$ 1,065 \$ 1,490		
TB-4242-AC-FP1 TB-4242-AC-FP2 TB-4242-AC-FP3 TB-4242-AC-TP1 TB-4242-AC-TP2 TB-4242-AC-TP3	Flat Pedestal 19" H Flat Pedestal 29" H Flat Pedestal 42" H Trumpet 19" H Trumpet 29" H Trumpet 42" H	42" 42" 42" 42" 42" 42"	42" 42" 42" 42" 42" 42"	19" 29" 42" 19" 29" 42"	\$ 1,395 \$ 1,395 \$ 1,470 \$ 1,115 \$ 1,115 \$ 1,295		

Edge Option:

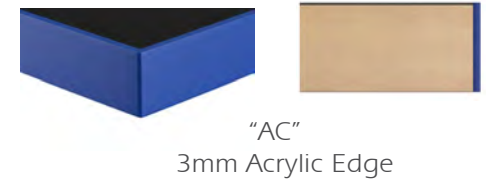

Metal Leg Options:

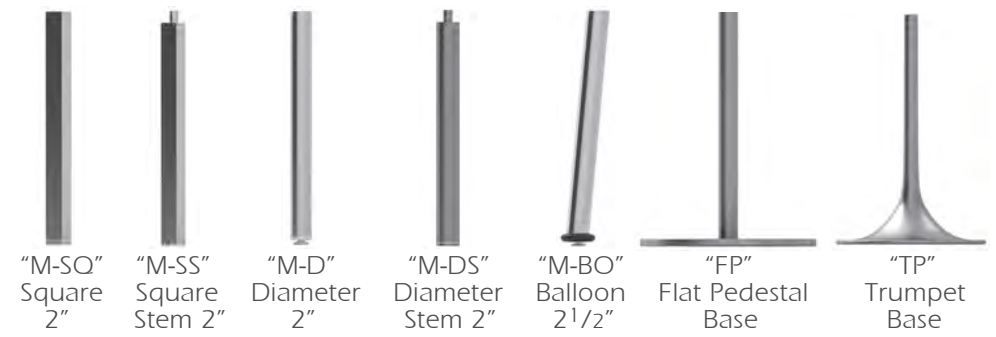

Wood Leg Options:

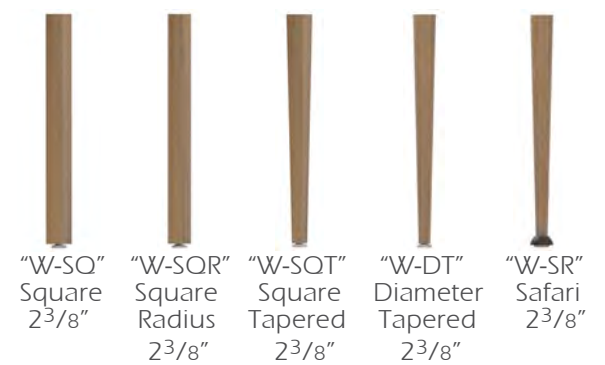

"MC" Caster Option:
Available on all Metal Legs ONLY, with exception of the Balloon leg and Metal Bases.

KREATIONS

MODEL NUMBER	PRODUCT	WIDTH	DEPTH	HEIGHT	PRICE	DESCRIPTION
 <p>*Shown Above: TB-4242-SQ-M-D</p>  <p>*Square Table Shape</p>	Square Table, 42" Width,	42"	42"	29"		<p>Each Table Top is constructed using a 1 1/8" thick top with a Plastic Laminate top surface.</p> <p>All Metal legs are coated electrostatically with an epoxy powder coat paint.</p> <p>NOTES: * Table heights of 25" (children), 27" (youth), and 32" (wheelchair) are available by request. * Color of Metal Paint must be specified at the time of order. * Caster Leg options are recommended for Reading/Multipurpose Tables options and not meant to be used for stationary computer workstations. * For all tables with casters legs, only 2 legs will have casters, and the other legs will have levelers. This will create a "wheelbarrow" style of table which will ensure ease of mobility. * Color of the Caster Option must be specified at the time of order.</p>
	SQUARE Edge;					
	with WOOD Leg Option:	42"	42"	29"		
	TB-4242-SQ-W-SQ	Square			\$ 1,035	
	TB-4242-SQ-W-SQR	Square Radius			\$ 1,035	
	TB-4242-SQ-W-SQT	Square Tapered			\$ 1,185	
	TB-4242-SQ-W-DT	Diameter Tapered			\$ 1,315	
	TB-4242-SQ-W-SR	Safari			\$ 1,325	
	with METAL Leg Option:	42"	42"	29"		
	TB-4242-SQ-M-SQ	Square			\$ 970	
TB-4242-SQ-M-SS	Square & Stem			\$ 1,395		
TB-4242-SQ-M-D	Diameter			\$ 970		
TB-4242-SQ-M-DS	Diameter & Stem			\$ 1,395		
TB-4242-SQ-M-BO	Balloon			\$ 1,075		
TB-4242-SQ-MC-SQ	Square with Casters			\$ 1,195		
TB-4242-SQ-MC-SS	Square & Stem with Casters			\$ 1,620		
TB-4242-SQ-MC-D	Diameter with Casters			\$ 1,195		
TB-4242-SQ-MC-DS	Diameter & Stem with Casters			\$ 1,620		

Edge Option:



"SQ"
1/4" Square Edge

Metal Leg Options:



"M-SQ" Square 2"
 "M-SS" Square Stem 2"
 "M-D" Diameter 2"
 "M-DS" Diameter Stem 2"
 "M-BO" Balloon 2 1/2"

Wood Leg Options:



"W-SQ" Square 2 3/8"
 "W-SQR" Square Radius 2 3/8"
 "W-SQT" Square Tapered 2 3/8"
 "W-DT" Diameter Tapered 2 3/8"
 "W-SR" Safari 2 3/8"



Black/Black White/Grey Silver/Orange Mirror Finish/Grey

"MC" Caster Option:
 Available on all Metal Legs ONLY, with exception of the Balloon leg and Metal Bases.

KREATIONS

MODEL NUMBER	PRODUCT	WIDTH	DEPTH	HEIGHT	PRICE	DESCRIPTION
	Square Table, 42" Width, DROPPED SQUARE Edge;	42"	42"	29"		Each Table Top is constructed using a 1 1/8" thick top with a Plastic Laminate top surface. All Metal legs are coated electrostatically with an epoxy powder coat paint.
*Shown Above: TB-4242-DSQ-M-D	with WOOD Leg Option:	42"	42"	29"		NOTES: * Table heights of 25" (children), 27" (youth), and 32" (wheelchair) are available by request. * Color of Metal Paint must be specified at the time of order. * Caster Leg options are recommended for Reading/Multipurpose Tables options and not meant to be used for stationary computer workstations. * For all tables with casters legs, only 2 legs will have casters, and the other legs will have levelers. This will create a "wheelbarrow" style of table which will ensure ease of mobility. * Color of the Caster Option must be specified at the time of order.
	TB-4242-DSQ-W-SQ Square				\$ 1,100	
	TB-4242-DSQ-W-SQR Square Radius				\$ 1,100	
	TB-4242-DSQ-W-SQT Square Tapered				\$ 1,255	
	TB-4242-DSQ-W-DT Diameter Tapered				\$ 1,380	
	TB-4242-DSQ-W-SR Safari				\$ 1,390	
	with METAL Leg Option:	42"	42"	29"		
*Square Table Shape	TB-4242-DSQ-M-SQ Square				\$ 1,035	
	TB-4242-DSQ-M-SS Square & Stem				\$ 1,460	
	TB-4242-DSQ-M-D Diameter				\$ 1,035	
	TB-4242-DSQ-M-DS Diameter & Stem				\$ 1,460	
	TB-4242-DSQ-M-BO Balloon				\$ 1,140	
	TB-4242-DSQ-MC-SQ Square with Casters				\$ 1,265	
	TB-4242-DSQ-MC-SS Square & Stem with Casters				\$ 1,685	
	TB-4242-DSQ-MC-D Diameter with Casters				\$ 1,265	
	TB-4242-DSQ-MC-DS Diameter & Stem with Casters				\$ 1,685	

Edge Option:



Metal Leg Options:

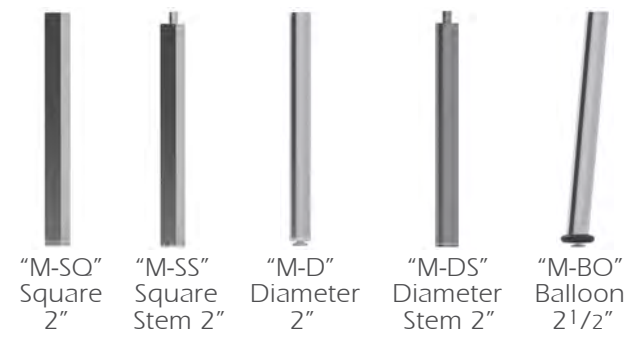

Wood Leg Options:

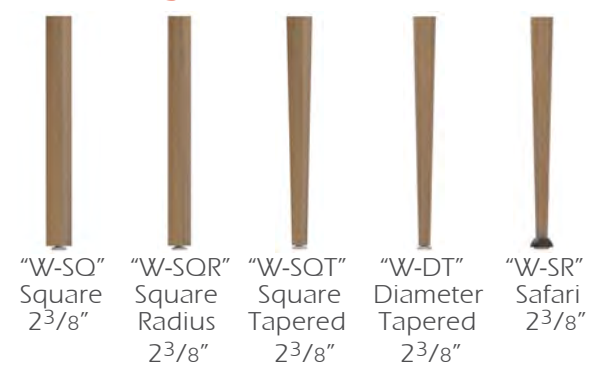

"MC" Caster Option:
Available on all Metal Legs ONLY, with exception of the Balloon leg and Metal Bases.

KREATIONS

MODEL NUMBER	PRODUCT	WIDTH	DEPTH	HEIGHT	PRICE	DESCRIPTION
 <p>*Shown Above: TB-4242-DBN-M-D</p>  <p>*Square Table Shape</p>	Square Table, 42" Width, DROPPED BULLNOSE Edge;	42"	42"	29"		Each Table Top is constructed using a 1 1/8" thick top with a Plastic Laminate top surface. All Metal legs are coated electrostatically with an epoxy powder coat paint.
	with WOOD Leg Option:	42"	42"	29"		NOTES: * Table heights of 25" (children), 27" (youth), and 32" (wheelchair) are available by request. * Color of Metal Paint must be specified at the time of order. * Caster Leg options are recommended for Reading/Multipurpose Tables options and not meant to be used for stationary computer workstations. * For all tables with casters legs, only 2 legs will have casters, and the other legs will have levelers. This will create a "wheelbarrow" style of table which will ensure ease of mobility. * Color of the Caster Option must be specified at the time of order.
	TB-4242-DBN-W-SQ	Square			\$ 1,110	
	TB-4242-DBN-W-SQR	Square Radius			\$ 1,110	
	TB-4242-DBN-W-SQT	Square Tapered			\$ 1,265	
	TB-4242-DBN-W-DT	Diameter Tapered			\$ 1,395	
	TB-4242-DBN-W-SR	Safari			\$ 1,400	
	with METAL Leg Option:	42"	42"	29"		
	TB-4242-DBN-M-SQ	Square			\$ 1,045	
	TB-4242-DBN-M-SS	Square & Stem			\$ 1,475	
TB-4242-DBN-M-D	Diameter			\$ 1,045		
TB-4242-DBN-M-DS	Diameter & Stem			\$ 1,475		
TB-4242-DBN-M-BO	Balloon			\$ 1,150		
TB-4242-DBN-MC-SQ	Square with Casters			\$ 1,275		
TB-4242-DBN-MC-SS	Square & Stem with Casters			\$ 1,695		
TB-4242-DBN-MC-D	Diameter with Casters			\$ 1,275		
TB-4242-DBN-MC-DS	Diameter & Stem with Casters			\$ 1,695		

Edge Option:



Metal Leg Options:

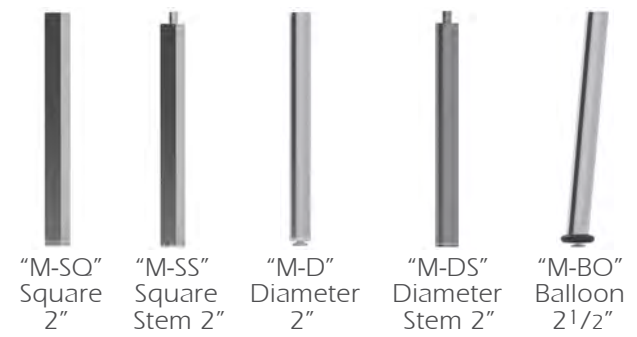

Wood Leg Options:

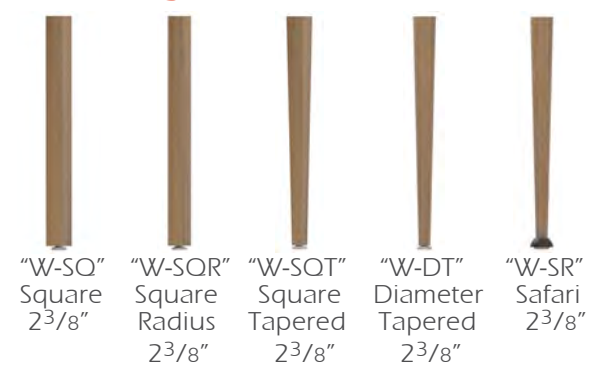

"MC" Caster Option:
Available on all Metal Legs ONLY, with exception of the Balloon leg and Metal Bases.

KREATIONS

MODEL NUMBER	PRODUCT	WIDTH	DEPTH	HEIGHT	PRICE	DESCRIPTION	
 <p>*Shown Above: TB-4242-DCH-M-D</p>  <p>*Square Table Shape</p>	Square Table, 42" Width,	42"	42"	29"		Each Table Top is constructed using a 1 1/8" thick top with a Plastic Laminate top surface.	
		DROPPED CHAMFERED Edge;					All Metal legs are coated electrostatically with an epoxy powder coat paint.
		with WOOD Leg Option:	42"	42"	29"		NOTES:
	TB-4242-DCH-W-SQ	Square				\$ 1,110	* Table heights of 25" (children), 27" (youth), and 32" (wheelchair) are available by request.
	TB-4242-DCH-W-SQR	Square Radius				\$ 1,110	* Color of Metal Paint must be specified at the time of order.
	TB-4242-DCH-W-SQT	Square Tapered				\$ 1,265	* Caster Leg options are recommended for Reading/Multipurpose Tables options and not meant to be used for stationary computer workstations.
	TB-4242-DCH-W-DT	Diameter Tapered				\$ 1,395	* For all tables with casters legs, only 2 legs will have casters, and the other legs will have levelers. This will create a "wheelbarrow" style of table which will ensure ease of mobility.
	TB-4242-DCH-W-SR	Safari				\$ 1,400	* Color of the Caster Option must be specified at the time of order.
		with METAL Leg Option:	42"	42"	29"		
	TB-4242-DCH-M-SQ	Square				\$ 1,045	
TB-4242-DCH-M-SS	Square & Stem				\$ 1,475		
TB-4242-DCH-M-D	Diameter				\$ 1,045		
TB-4242-DCH-M-DS	Diameter & Stem				\$ 1,475		
TB-4242-DCH-M-BO	Balloon				\$ 1,150		
TB-4242-DCH-MC-SQ	Square with Casters				\$ 1,275		
TB-4242-DCH-MC-SS	Square & Stem with Casters				\$ 1,695		
TB-4242-DCH-MC-D	Diameter with Casters				\$ 1,275		
TB-4242-DCH-MC-DS	Diameter & Stem with Casters				\$ 1,695		

Edge Option:



Metal Leg Options:

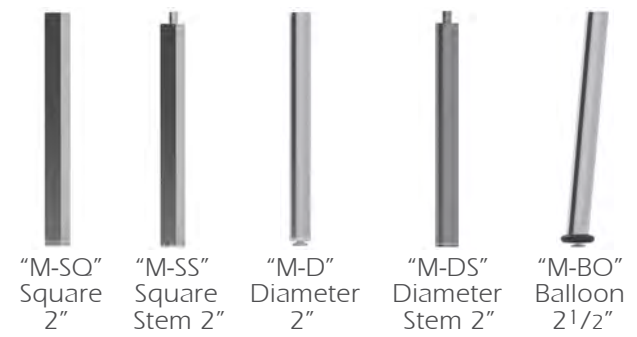

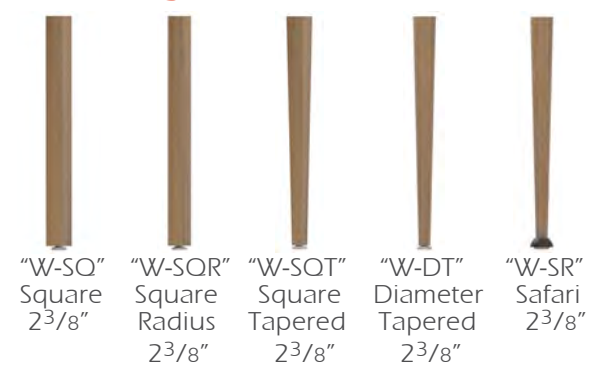

Wood Leg Options:



"MC" Caster Option:
Available on all Metal Legs ONLY, with exception of the Balloon leg and Metal Bases.

KREATIONS

MODEL NUMBER	PRODUCT	WIDTH	DEPTH	HEIGHT	PRICE	DESCRIPTION
 *Shown Above: TB-4242-AL-M-D	Square Table, 42" Width,	42"	42"	29"		Each Table Top is constructed using a 1 1/8" thick top with a Plastic Laminate top surface.
	ALUMINUM Edge;					All Metal legs are coated electrostatically with an epoxy powder coat paint.
	with WOOD Leg Option:	42"	42"	29"		NOTES:
	TB-4242-AL-W-SQ Square	\$ 980	* Table heights of 25" (children), 27" (youth), and 32" (wheelchair) are available by request.			
	TB-4242-AL-W-SQR Square Radius	\$ 980	* Color of Metal Paint must be specified at the time of order.			
TB-4242-AL-W-SQT Square Tapered	\$ 1,130	* Caster Leg options are recommended for Reading/Multipurpose Tables options and not meant to be used for stationary computer workstations.				
TB-4242-AL-W-DT Diameter Tapered	\$ 1,260	* For all tables with casters legs, only 2 legs will have casters, and the other legs will have levelers. This will create a "wheelbarrow" style of table which will ensure ease of mobility.				
TB-4242-AL-W-SR Safari	\$ 1,270	* Color of the Caster Option must be specified at the time of order.				
 *Square Table Shape	with METAL Leg Option:	42"	42"	29"		
	TB-4242-AL-M-SQ Square	\$ 915				
	TB-4242-AL-M-SS Square & Stem	\$ 1,340				
	TB-4242-AL-M-D Diameter	\$ 915				
	TB-4242-AL-M-DS Diameter & Stem	\$ 1,340				
	TB-4242-AL-M-BO Balloon	\$ 1,015				
	TB-4242-AL-MC-SQ Square with Casters	\$ 1,140				
	TB-4242-AL-MC-SS Square & Stem with Casters	\$ 1,565				
	TB-4242-AL-MC-D Diameter with Casters	\$ 1,140				
	TB-4242-AL-MC-DS Diameter & Stem with Casters	\$ 1,565				
TB-4242-AL-FP1 Flat Pedestal 19" H	\$ 1,465					
TB-4242-AL-FP2 Flat Pedestal 29" H	\$ 1,465					
TB-4242-AL-FP3 Flat Pedestal 42" H	\$ 1,540					
TB-4242-AL-TP1 Trumpet 19" H	\$ 1,190					
TB-4242-AL-TP2 Trumpet 29" H	\$ 1,190					
TB-4242-AL-TP3 Trumpet 42" H	\$ 1,365					

Edge Option:



3mm Aluminum Edge *All table corners will be given a 6-inch radius for this edge option.

Metal Leg Options:

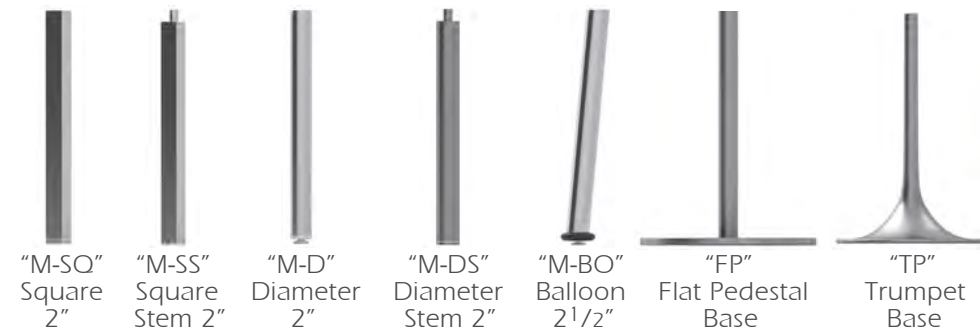

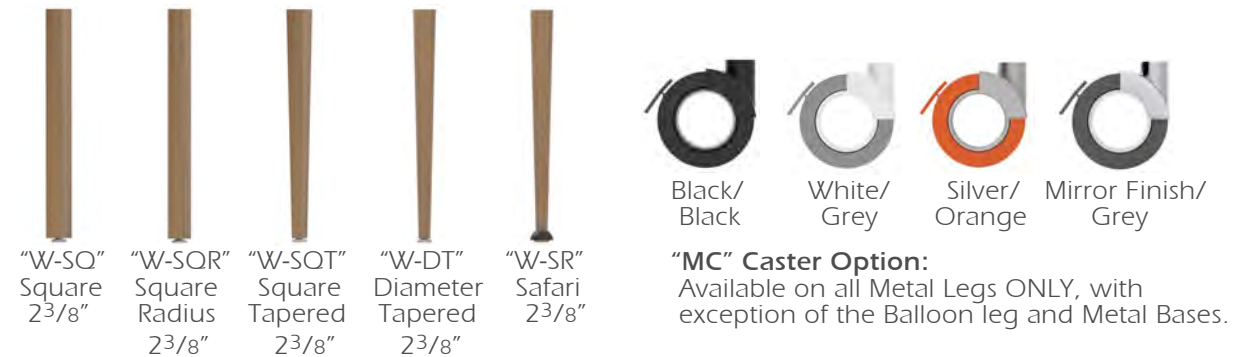

Wood Leg Options:



"MC" Caster Option:
Available on all Metal Legs ONLY, with exception of the Balloon leg and Metal Bases.

KREATIONS

MODEL NUMBER	PRODUCT	WIDTH	DEPTH	HEIGHT	
 *Shown Above: TB-4848-AC-M-D  *Square Table Shape	Square Table, 48" Width,	48"	48"	29"	
	ACRYLIC Edge;				
	with WOOD Leg Option:	48"	48"	29"	
	TB-4848-AC-W-SQ TB-4848-AC-W-SQR TB-4848-AC-W-SQT TB-4848-AC-W-DT TB-4848-AC-W-SR	Square Square Radius Square Tapered Diameter Tapered Safari			
	with METAL Leg Option:	48"	48"	29"	
TB-4848-AC-M-SQ TB-4848-AC-M-SS TB-4848-AC-M-D TB-4848-AC-M-DS TB-4848-AC-M-BO TB-4848-AC-MC-SQ TB-4848-AC-MC-SS TB-4848-AC-MC-D TB-4848-AC-MC-DS	Square Square & Stem Diameter Diameter & Stem Balloon Square with Casters Square & Stem with Casters Diameter with Casters Diameter & Stem with Casters				
TB-4848-AC-FP1 TB-4848-AC-FP2 TB-4848-AC-FP3 TB-4848-AC-TP1 TB-4848-AC-TP2 TB-4848-AC-TP3	Flat Pedestal 19" H Flat Pedestal 29" H Flat Pedestal 42" H Trumpet 19" H Trumpet 29" H Trumpet 42" H	48" 48" 48" 48" 48" 48"	48" 48" 48" 48" 48" 48"	19" 29" 42" 19" 29" 42"	

PRICE

DESCRIPTION

Each Table Top is constructed using a 1" thick top with a Plastic Laminate top surface.

All Metal legs are coated electrostatically with an epoxy powder coat paint.

NOTES:

- * Table heights of 25" (children), 27" (youth), and 32" (wheelchair) are available by request.
- * Color of Metal Paint must be specified at the time of order.
- * Caster Leg options are recommended for Reading/Multipurpose Tables options and not meant to be used for stationary computer workstations.
- * For all tables with casters legs, only 2 legs will have casters, and the other legs will have levelers. This will create a "wheelbarrow" style of table which will ensure ease of mobility.
- * Color of the Caster Option must be specified at the time of order.

\$ 955
\$ 955
\$ 1,110
\$ 1,235
\$ 1,240

\$ 890
\$ 1,315
\$ 890
\$ 1,315
\$ 995
\$ 1,115
\$ 1,540
\$ 1,115
\$ 1,540

Edge Option:

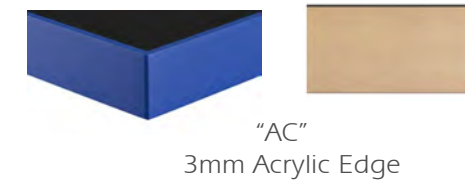

Metal Leg Options:

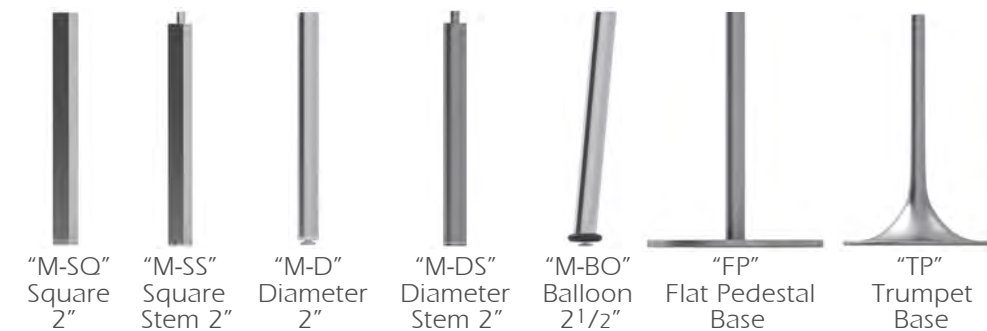

Wood Leg Options:

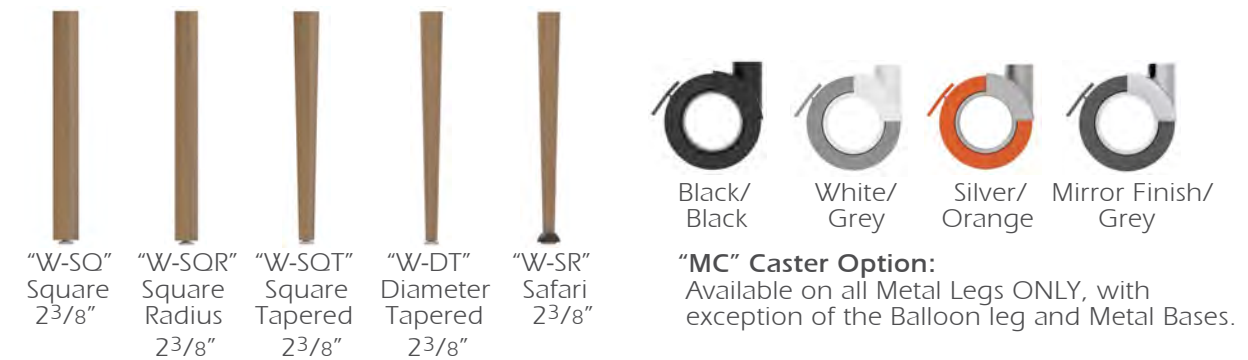

KREATIONS

MODEL NUMBER	PRODUCT	WIDTH	DEPTH	HEIGHT	PRICE	DESCRIPTION	
 <p>*Shown Above: TB-4848-SQ-M-D</p>	Square Table, 48" Width,	48"	48"	29"		<p>Each Table Top is constructed using a 1 1/8" thick top with a Plastic Laminate top surface.</p> <p>All Metal legs are coated electrostatically with an epoxy powder coat paint.</p> <p>NOTES: * Table heights of 25" (children), 27" (youth), and 32" (wheelchair) are available by request. * Color of Metal Paint must be specified at the time of order. * Caster Leg options are recommended for Reading/Multipurpose Tables options and not meant to be used for stationary computer workstations. * For all tables with casters legs, only 2 legs will have casters, and the other legs will have levelers. This will create a "wheelbarrow" style of table which will ensure ease of mobility. * Color of the Caster Option must be specified at the time of order.</p>	
	SQUARE Edge;						
	with WOOD Leg Option:	48"	48"	29"			
	TB-4848-SQ-W-SQ TB-4848-SQ-W-SQR TB-4848-SQ-W-SQT TB-4848-SQ-W-DT TB-4848-SQ-W-SR	Square Square Radius Square Tapered Diameter Tapered Safari					\$ 1,110 \$ 1,110 \$ 1,260 \$ 1,390 \$ 1,395
	with METAL Leg Option:	48"	48"	29"			
TB-4848-SQ-M-SQ TB-4848-SQ-M-SS TB-4848-SQ-M-D TB-4848-SQ-M-DS TB-4848-SQ-M-BO TB-4848-SQ-MC-SQ TB-4848-SQ-MC-SS TB-4848-SQ-MC-D TB-4848-SQ-MC-DS	Square Square & Stem Diameter Diameter & Stem Balloon Square with Casters Square & Stem with Casters Diameter with Casters Diameter & Stem with Casters				\$ 1,045 \$ 1,465 \$ 1,045 \$ 1,465 \$ 1,145 \$ 1,270 \$ 1,695 \$ 1,270 \$ 1,695		



*Square Table Shape

Edge Option:



"SQ"
1/4" Square Edge

Metal Leg Options:



"M-SQ" Square 2"
 "M-SS" Square Stem 2"
 "M-D" Diameter 2"
 "M-DS" Diameter Stem 2"
 "M-BO" Balloon 2 1/2"

Wood Leg Options:



"W-SQ" Square 2 3/8"
 "W-SQR" Square Radius 2 3/8"
 "W-SQT" Square Tapered 2 3/8"
 "W-DT" Diameter Tapered 2 3/8"
 "W-SR" Safari 2 3/8"



"MC" Caster Option:
 Available on all Metal Legs ONLY, with exception of the Balloon leg and Metal Bases.

KREATIONS

MODEL NUMBER	PRODUCT	WIDTH	DEPTH	HEIGHT	PRICE	DESCRIPTION
 <p>*Shown Above: TB-4848-DSQ-M-D</p>  <p>*Square Table Shape</p>	Square Table, 48" Width, DROPPED SQUARE Edge;	48"	48"	29"		Each Table Top is constructed using a 1 1/8" thick top with a Plastic Laminate top surface. All Metal legs are coated electrostatically with an epoxy powder coat paint.
	with WOOD Leg Option:	48"	48"	29"		NOTES: * Table heights of 25" (children), 27" (youth), and 32" (wheelchair) are available by request. * Color of Metal Paint must be specified at the time of order. * Caster Leg options are recommended for Reading/Multipurpose Tables options and not meant to be used for stationary computer workstations. * For all tables with casters legs, only 2 legs will have casters, and the other legs will have levelers. This will create a "wheelbarrow" style of table which will ensure ease of mobility. * Color of the Caster Option must be specified at the time of order.
	TB-4848-DSQ-W-SQ	Square			\$ 1,190	
	TB-4848-DSQ-W-SQR	Square Radius			\$ 1,190	
	TB-4848-DSQ-W-SQT	Square Tapered			\$ 1,345	
	TB-4848-DSQ-W-DT	Diameter Tapered			\$ 1,470	
	TB-4848-DSQ-W-SR	Safari			\$ 1,475	
	with METAL Leg Option:	48"	48"	29"		
	TB-4848-DSQ-M-SQ	Square			\$ 1,125	
	TB-4848-DSQ-M-SS	Square & Stem			\$ 1,545	
TB-4848-DSQ-M-D	Diameter			\$ 1,125		
TB-4848-DSQ-M-DS	Diameter & Stem			\$ 1,545		
TB-4848-DSQ-M-BO	Balloon			\$ 1,225		
TB-4848-DSQ-MC-SQ	Square with Casters			\$ 1,350		
TB-4848-DSQ-MC-SS	Square & Stem with Casters			\$ 1,775		
TB-4848-DSQ-MC-D	Diameter with Casters			\$ 1,350		
TB-4848-DSQ-MC-DS	Diameter & Stem with Casters			\$ 1,775		

Edge Option:



Metal Leg Options:

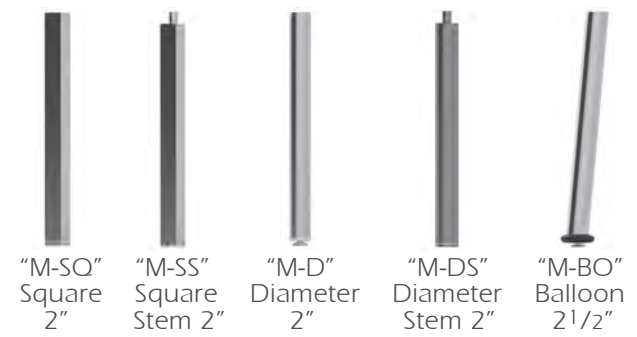

Wood Leg Options:

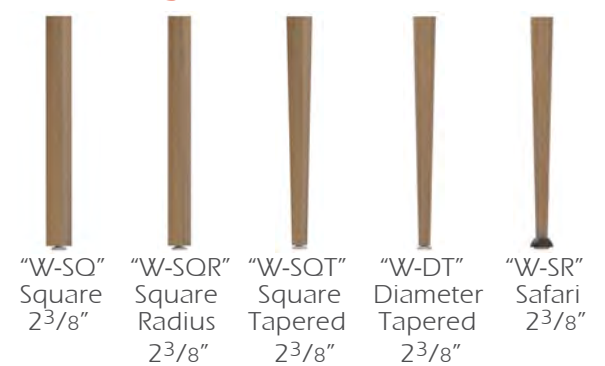

"MC" Caster Option:
Available on all Metal Legs ONLY, with exception of the Balloon leg and Metal Bases.

KREATIONS

MODEL NUMBER	PRODUCT	WIDTH	DEPTH	HEIGHT	PRICE	DESCRIPTION	
 <p>*Shown Above: TB-4848-DBN-M-D</p>  <p>*Square Table Shape</p>	Square Table, 48" Width,	48"	48"	29"		Each Table Top is constructed using a 1 1/8" thick top with a Plastic Laminate top surface.	
		DROPPED BULLNOSE Edge;					All Metal legs are coated electrostatically with an epoxy powder coat paint.
		with WOOD Leg Option:	48"	48"	29"		NOTES:
	TB-4848-DBN-W-SQ	Square				\$ 1,200	* Table heights of 25" (children), 27" (youth), and 32" (wheelchair) are available by request.
	TB-4848-DBN-W-SQR	Square Radius				\$ 1,200	* Color of Metal Paint must be specified at the time of order.
	TB-4848-DBN-W-SQT	Square Tapered				\$ 1,350	* Caster Leg options are recommended for Reading/Multipurpose Tables options and not meant to be used for stationary computer workstations.
	TB-4848-DBN-W-DT	Diameter Tapered				\$ 1,480	* For all tables with casters legs, only 2 legs will have casters, and the other legs will have levelers. This will create a "wheelbarrow" style of table which will ensure ease of mobility.
	TB-4848-DBN-W-SR	Safari				\$ 1,485	* Color of the Caster Option must be specified at the time of order.
		with METAL Leg Option:	48"	48"	29"		
	TB-4848-DBN-M-SQ	Square				\$ 1,135	
TB-4848-DBN-M-SS	Square & Stem				\$ 1,555		
TB-4848-DBN-M-D	Diameter				\$ 1,135		
TB-4848-DBN-M-DS	Diameter & Stem				\$ 1,555		
TB-4848-DBN-M-BO	Balloon				\$ 1,235		
TB-4848-DBN-MC-SQ	Square with Casters				\$ 1,360		
TB-4848-DBN-MC-SS	Square & Stem with Casters				\$ 1,785		
TB-4848-DBN-MC-D	Diameter with Casters				\$ 1,360		
TB-4848-DBN-MC-DS	Diameter & Stem with Casters				\$ 1,785		

Edge Option:



Metal Leg Options:

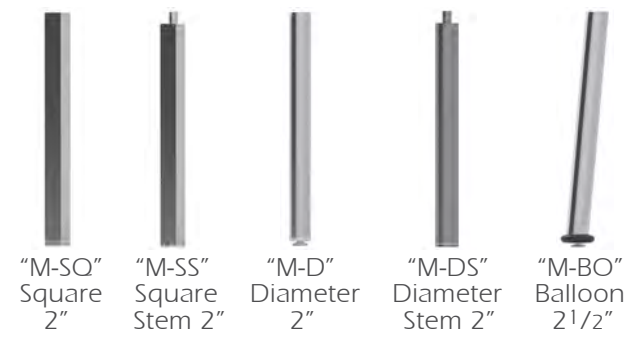

Wood Leg Options:

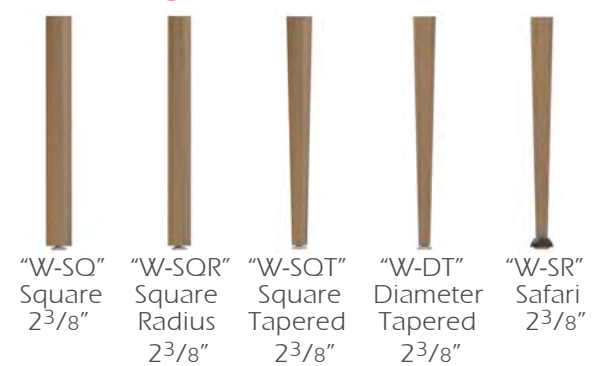

"MC" Caster Option:
Available on all Metal Legs ONLY, with exception of the Balloon leg and Metal Bases.

KREATIONS

MODEL NUMBER	PRODUCT	WIDTH	DEPTH	HEIGHT	PRICE	DESCRIPTION
 <p>*Shown Above: TB-4848-DCH-M-D</p>  <p>*Square Table Shape</p>	Square Table, 48" Width,	48"	48"	29"		Each Table Top is constructed using a 1 1/8" thick top with a Plastic Laminate top surface.
	DROPPED CHAMFERED Edge;					All Metal legs are coated electrostatically with an epoxy powder coat paint.
	with WOOD Leg Option:	48"	48"	29"		NOTES:
	TB-4848-DCH-W-SQ Square				\$ 1,200	* Table heights of 25" (children), 27" (youth), and 32" (wheelchair) are available by request.
	TB-4848-DCH-W-SQR Square Radius				\$ 1,200	* Color of Metal Paint must be specified at the time of order.
	TB-4848-DCH-W-SQT Square Tapered				\$ 1,350	* Caster Leg options are recommended for Reading/Multipurpose Tables options and not meant to be used for stationary computer workstations.
	TB-4848-DCH-W-DT Diameter Tapered				\$ 1,480	* For all tables with casters legs, only 2 legs will have casters, and the other legs will have levelers. This will create a "wheelbarrow" style of table which will ensure ease of mobility.
	TB-4848-DCH-W-SR Safari				\$ 1,485	* Color of the Caster Option must be specified at the time of order.
	with METAL Leg Option:	48"	48"	29"		
	TB-4848-DCH-M-SQ Square				\$ 1,135	
TB-4848-DCH-M-SS Square & Stem				\$ 1,555		
TB-4848-DCH-M-D Diameter				\$ 1,135		
TB-4848-DCH-M-DS Diameter & Stem				\$ 1,555		
TB-4848-DCH-M-BO Balloon				\$ 1,235		
TB-4848-DCH-MC-SQ Square with Casters				\$ 1,360		
TB-4848-DCH-MC-SS Square & Stem with Casters				\$ 1,785		
TB-4848-DCH-MC-D Diameter with Casters				\$ 1,360		
TB-4848-DCH-MC-DS Diameter & Stem with Casters				\$ 1,785		

Edge Option:



Metal Leg Options:

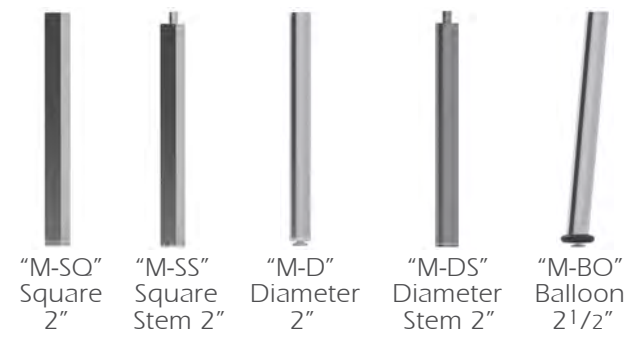

Wood Leg Options:

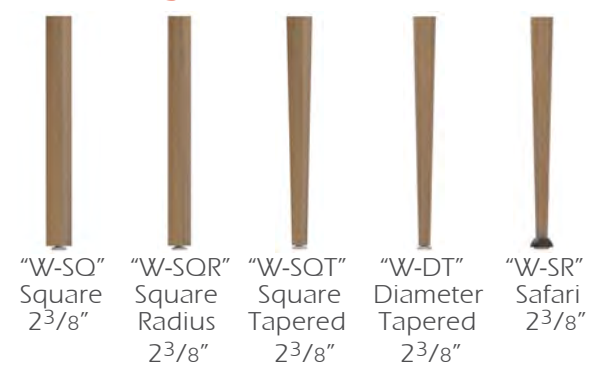

"MC" Caster Option:
Available on all Metal Legs ONLY, with exception of the Balloon leg and Metal Bases.

KREATIONS

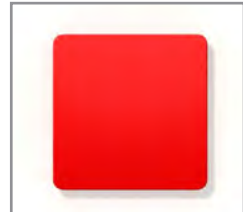
MODEL NUMBER	PRODUCT	WIDTH	DEPTH	HEIGHT	
 *Shown Above: TB-4848-AL-M-D	Square Table, 48" Width,	48"	48"	29"	
	ALUMINUM Edge;				
	with WOOD Leg Option:	48"	48"	29"	
	Square				
	Square Radius				
 *Square Table Shape	TB-4848-AL-W-SQ				
	TB-4848-AL-W-SQR	Square Radius			
	TB-4848-AL-W-SQT	Square Tapered			
	TB-4848-AL-W-DT	Diameter Tapered			
	TB-4848-AL-W-SR	Safari			
	with METAL Leg Option:	48"	48"	29"	
	Square				
	TB-4848-AL-M-SQ	Square & Stem			
	TB-4848-AL-M-SS	Diameter			
	TB-4848-AL-M-D	Diameter & Stem			
	TB-4848-AL-M-DS	Balloon			
	TB-4848-AL-M-BO	Square with Casters			
	TB-4848-AL-MC-SQ	Square & Stem with Casters			
	TB-4848-AL-MC-SS	Diameter with Casters			
	TB-4848-AL-MC-D	Diameter & Stem with Casters			
TB-4848-AL-MC-DS					
	TB-4848-AL-FP1	Flat Pedestal 19" H	48"	48"	19"
	TB-4848-AL-FP2	Flat Pedestal 29" H	48"	48"	29"
	TB-4848-AL-FP3	Flat Pedestal 42" H	48"	48"	42"
	TB-4848-AL-TP1	Trumpet 19" H	48"	48"	19"
	TB-4848-AL-TP2	Trumpet 29" H	48"	48"	29"
	TB-4848-AL-TP3	Trumpet 42" H	48"	48"	42"

PRICE	DESCRIPTION
	Each Table Top is constructed using a 1 1/8" thick top with a Plastic Laminate top surface.
	All Metal legs are coated electrostatically with an epoxy powder coat paint.
	NOTES:
\$ 1,045	* Table heights of 25" (children), 27" (youth), and 32" (wheelchair) are available by request.
\$ 1,045	* Color of Metal Paint must be specified at the time of order.
\$ 1,200	* Caster Leg options are recommended for Reading/Multipurpose Tables options and not meant to be used for stationary computer workstations.
\$ 1,330	* For all tables with casters legs, only 2 legs will have casters, and the other legs will have levelers. This will create a "wheelbarrow" style of table which will ensure ease of mobility.
\$ 1,335	* Color of the Caster Option must be specified at the time of order.
\$ 985	
\$ 1,405	
\$ 985	
\$ 1,405	
\$ 1,085	
\$ 1,205	
\$ 1,635	
\$ 1,205	
\$ 1,635	
\$ 1,855	
\$ 1,855	
\$ 1,935	
\$ 1,255	
\$ 1,255	
\$ 1,435	

Edge Option:



3mm Aluminum Edge *All table corners will be given a 6-inch radius for this edge option.

Metal Leg Options:

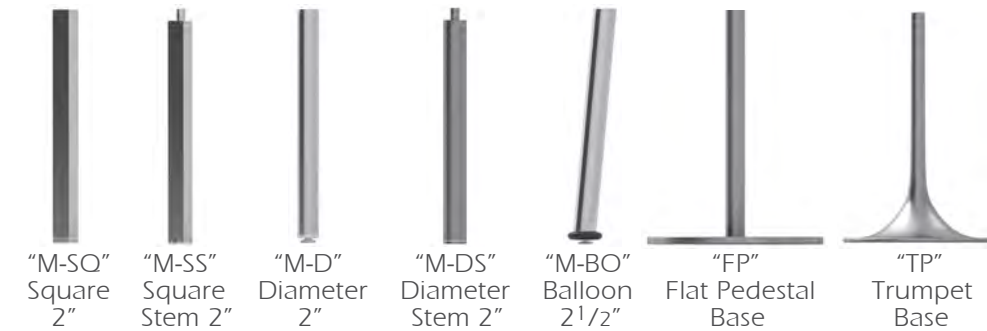

Wood Leg Options:

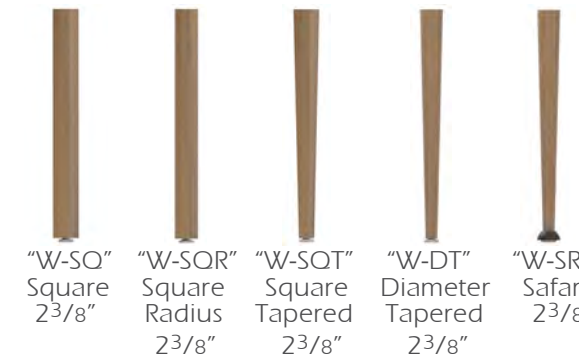

"MC" Caster Option:
Available on all Metal Legs ONLY, with exception of the Balloon leg and Metal Bases.

KREATIONS

MODEL NUMBER	PRODUCT	WIDTH	DEPTH	HEIGHT	PRICE	DESCRIPTION	
 *Shown Above: TB-3624-AC-M-D  *Rectangle Table Shape	Rectangle Table, 36" Width,	36"	24"	29"		Each Table Top is constructed using a 1" thick top with a Plastic Laminate top surface. All Metal legs are coated electrostatically with an epoxy powder coat paint. NOTES: * Table heights of 25" (children), 27" (youth), and 32" (wheelchair) are available by request. * Color of Metal Paint must be specified at the time of order. * Caster Leg options are recommended for Reading/Multipurpose Tables options and not meant to be used for stationary computer workstations. * For all tables with casters legs, only 2 legs will have casters, and the other legs will have levelers. This will create a "wheelbarrow" style of table which will ensure ease of mobility. * Color of the Caster Option must be specified at the time of order.	
	ACRYLIC Edge;						
	with WOOD Leg Option:	36"	24"	29"			
	TB-3624-AC-W-SQ TB-3624-AC-W-SQR TB-3624-AC-W-SQT TB-3624-AC-W-DT TB-3624-AC-W-SR	Square Square Radius Square Tapered Diameter Tapered Safari					\$ 810 \$ 810 \$ 965 \$ 1,095 \$ 1,100
	with METAL Leg Option:	36"	24"	29"			
TB-3624-AC-M-SQ TB-3624-AC-M-SS TB-3624-AC-M-D TB-3624-AC-M-DS TB-3624-AC-M-BO TB-3624-AC-MC-SQ TB-3624-AC-MC-SS TB-3624-AC-MC-D TB-3624-AC-MC-DS	Square Square & Stem Diameter Diameter & Stem Balloon Square with Casters Square & Stem with Casters Diameter with Casters Diameter & Stem with Casters				\$ 745 \$ 1,170 \$ 745 \$ 1,170 \$ 850 \$ 970 \$ 1,395 \$ 970 \$ 1,395		

Edge Option:

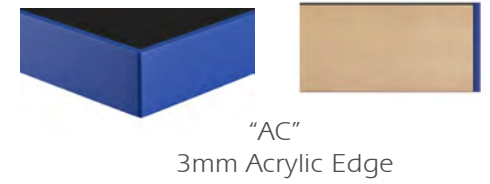

Metal Leg Options:

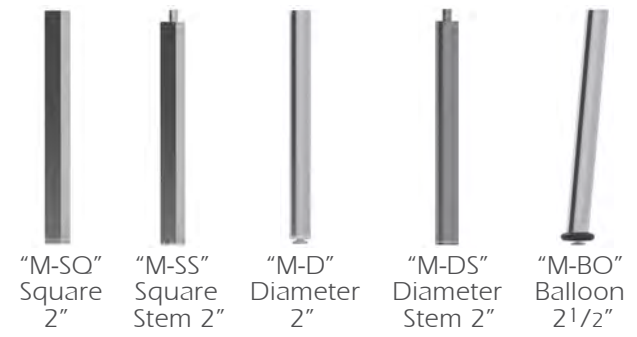

Wood Leg Options:

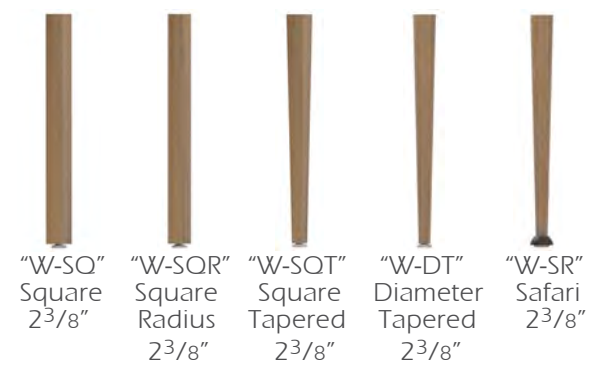

"MC" Caster Option:
Available on all Metal Legs ONLY, with exception of the Balloon leg and Metal Bases.

KREATIONS

MODEL NUMBER	PRODUCT	WIDTH	DEPTH	HEIGHT	PRICE	DESCRIPTION
 <p>*Shown Above: TB-3624-SQ-M-D</p>  <p>*Rectangle Table Shape</p>	Rectangle Table, 36" Width,	36"	24"	29"		<p>Each Table Top is constructed using a 1 1/8" thick top with a Plastic Laminate top surface.</p> <p>All Metal legs are coated electrostatically with an epoxy powder coat paint.</p> <p>NOTES: * Table heights of 25" (children), 27" (youth), and 32" (wheelchair) are available by request. * Color of Metal Paint must be specified at the time of order. * Caster Leg options are recommended for Reading/Multipurpose Tables options and not meant to be used for stationary computer workstations. * For all tables with casters legs, only 2 legs will have casters, and the other legs will have levelers. This will create a "wheelbarrow" style of table which will ensure ease of mobility. * Color of the Caster Option must be specified at the time of order.</p>
	SQUARE Edge;					
	with WOOD Leg Option:	36"	24"	29"		
	TB-3624-SQ-W-SQ	Square			\$ 905	
	TB-3624-SQ-W-SQR	Square Radius			\$ 905	
	TB-3624-SQ-W-SQT	Square Tapered			\$ 1,060	
	TB-3624-SQ-W-DT	Diameter Tapered			\$ 1,190	
	TB-3624-SQ-W-SR	Safari			\$ 1,195	
	with METAL Leg Option:	36"	24"	29"		
	TB-3624-SQ-M-SQ	Square			\$ 840	
TB-3624-SQ-M-SS	Square & Stem			\$ 1,265		
TB-3624-SQ-M-D	Diameter			\$ 840		
TB-3624-SQ-M-DS	Diameter & Stem			\$ 1,265		
TB-3624-SQ-M-BO	Balloon			\$ 945		
TB-3624-SQ-MC-SQ	Square with Casters			\$ 1,065		
TB-3624-SQ-MC-SS	Square & Stem with Casters			\$ 1,490		
TB-3624-SQ-MC-D	Diameter with Casters			\$ 1,065		
TB-3624-SQ-MC-DS	Diameter & Stem with Casters			\$ 1,490		

Edge Option:



Metal Leg Options:

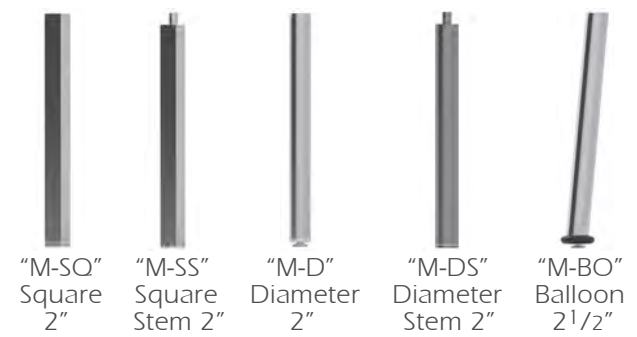

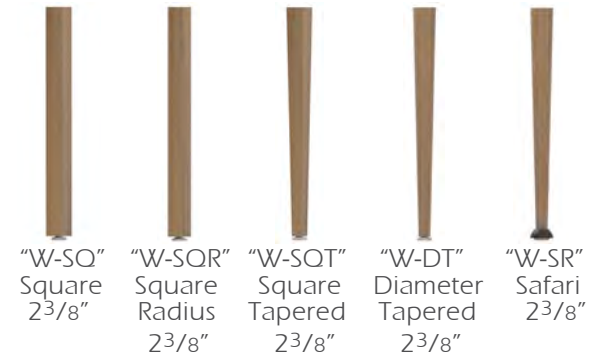

Wood Leg Options:



"MC" Caster Option:
Available on all Metal Legs ONLY, with exception of the Balloon leg and Metal Bases.

KREATIONS

MODEL NUMBER	PRODUCT	WIDTH	DEPTH	HEIGHT	PRICE	DESCRIPTION
 <p>*Shown Above: TB-3624-DSQ-M-D</p>  <p>*Rectangle Table Shape</p>	Rectangle Table, 36" Width, DROPPED SQUARE Edge;	36"	24"	29"		Each Table Top is constructed using a 1 1/8" thick top with a Plastic Laminate top surface. All Metal legs are coated electrostatically with an epoxy powder coat paint.
	with WOOD Leg Option:	36"	24"	29"		NOTES: * Table heights of 25" (children), 27" (youth), and 32" (wheelchair) are available by request. * Color of Metal Paint must be specified at the time of order. * Caster Leg options are recommended for Reading/Multipurpose Tables options and not meant to be used for stationary computer workstations. * For all tables with casters legs, only 2 legs will have casters, and the other legs will have levelers. This will create a "wheelbarrow" style of table which will ensure ease of mobility. * Color of the Caster Option must be specified at the time of order.
	TB-3624-DSQ-W-SQ	Square			\$ 935	
	TB-3624-DSQ-W-SQR	Square Radius			\$ 935	
	TB-3624-DSQ-W-SQT	Square Tapered			\$ 1,085	
	TB-3624-DSQ-W-DT	Diameter Tapered			\$ 1,215	
	TB-3624-DSQ-W-SR	Safari			\$ 1,220	
	with METAL Leg Option:	36"	24"	29"		
	TB-3624-DSQ-M-SQ	Square			\$ 870	
	TB-3624-DSQ-M-SS	Square & Stem			\$ 1,295	
TB-3624-DSQ-M-D	Diameter			\$ 870		
TB-3624-DSQ-M-DS	Diameter & Stem			\$ 1,295		
TB-3624-DSQ-M-BO	Balloon			\$ 970		
TB-3624-DSQ-MC-SQ	Square with Casters			\$ 1,095		
TB-3624-DSQ-MC-SS	Square & Stem with Casters			\$ 1,520		
TB-3624-DSQ-MC-D	Diameter with Casters			\$ 1,095		
TB-3624-DSQ-MC-DS	Diameter & Stem with Casters			\$ 1,520		

Edge Option:



Metal Leg Options:

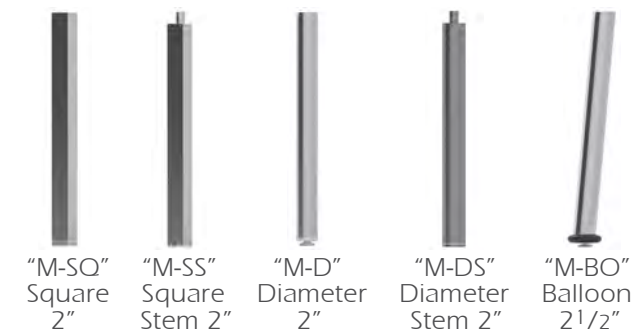

Wood Leg Options:

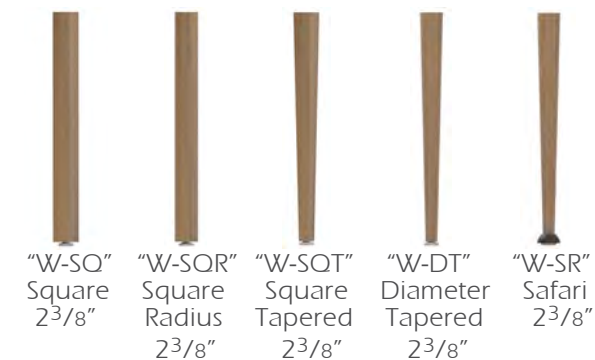

"MC" Caster Option:
Available on all Metal Legs ONLY, with exception of the Balloon leg and Metal Bases.

KREATIONS

MODEL NUMBER	PRODUCT	WIDTH	DEPTH	HEIGHT	PRICE	DESCRIPTION
	Rectangle Table, 36" Width, DROPPED BULLNOSE Edge;	36"	24"	29"		Each Table Top is constructed using a 1 1/8" thick top with a Plastic Laminate top surface. All Metal legs are coated electrostatically with an epoxy powder coat paint.
*Shown Above: TB-3624-DBN-M-D	with WOOD Leg Option:	36"	24"	29"		NOTES: * Table heights of 25" (children), 27" (youth), and 32" (wheelchair) are available by request. * Color of Metal Paint must be specified at the time of order. * Caster Leg options are recommended for Reading/Multipurpose Tables options and not meant to be used for stationary computer workstations. * For all tables with casters legs, only 2 legs will have casters, and the other legs will have levelers. This will create a "wheelbarrow" style of table which will ensure ease of mobility. * Color of the Caster Option must be specified at the time of order.
	Square				\$ 945	
	Square Radius				\$ 945	
	Square Tapered				\$ 1,095	
	Diameter Tapered				\$ 1,225	
	Safari				\$ 1,235	
	with METAL Leg Option:	36"	24"	29"		
*Rectangle Table Shape	Square				\$ 880	
	Square & Stem				\$ 1,305	
	Diameter				\$ 880	
	Diameter & Stem				\$ 1,305	
	Balloon				\$ 985	
	Square with Casters				\$ 1,105	
	Square & Stem with Casters				\$ 1,530	
	Diameter with Casters				\$ 1,105	
	Diameter & Stem with Casters				\$ 1,530	

Edge Option:



Metal Leg Options:

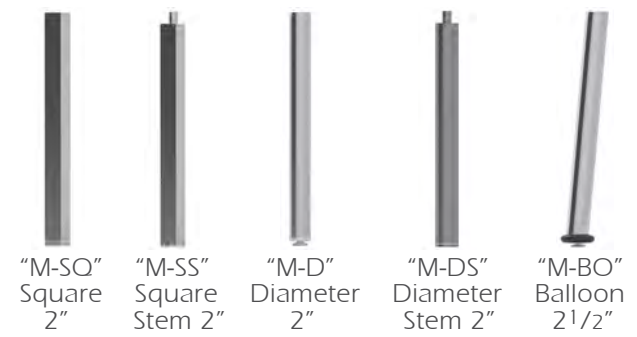

Wood Leg Options:

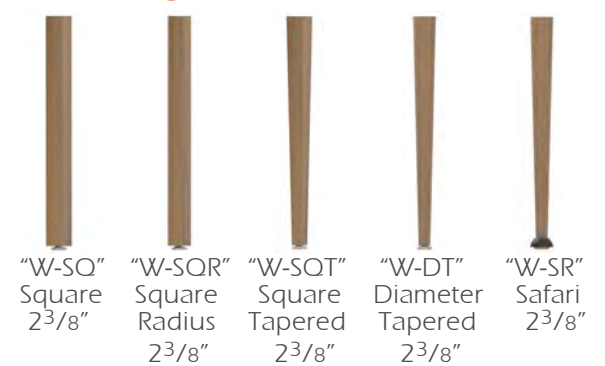

"MC" Caster Option:
Available on all Metal Legs ONLY, with exception of the Balloon leg and Metal Bases.

KREATIONS

MODEL NUMBER	PRODUCT	WIDTH	DEPTH	HEIGHT	PRICE	DESCRIPTION
	Rectangle Table, 36" Width, DROPPED CHAMFERED Edge;	36"	24"	29"		Each Table Top is constructed using a 1 1/8" thick top with a Plastic Laminate top surface. All Metal legs are coated electrostatically with an epoxy powder coat paint.
*Shown Above: TB-3624-DCH-M-D	with WOOD Leg Option:	36"	24"	29"		NOTES: * Table heights of 25" (children), 27" (youth), and 32" (wheelchair) are available by request. * Color of Metal Paint must be specified at the time of order. * Caster Leg options are recommended for Reading/Multipurpose Tables options and not meant to be used for stationary computer workstations. * For all tables with casters legs, only 2 legs will have casters, and the other legs will have levelers. This will create a "wheelbarrow" style of table which will ensure ease of mobility. * Color of the Caster Option must be specified at the time of order.
	TB-3624-DCH-W-SQ TB-3624-DCH-W-SQR TB-3624-DCH-W-SQT TB-3624-DCH-W-DT TB-3624-DCH-W-SR	Square Square Radius Square Tapered Diameter Tapered Safari			\$ 945 \$ 945 \$ 1,095 \$ 1,225 \$ 1,235	
*Rectangle Table Shape	with METAL Leg Option:	36"	24"	29"		
	TB-3624-DCH-M-SQ TB-3624-DCH-M-SS TB-3624-DCH-M-D TB-3624-DCH-M-DS TB-3624-DCH-M-BO TB-3624-DCH-MC-SQ TB-3624-DCH-MC-SS TB-3624-DCH-MC-D TB-3624-DCH-MC-DS	Square Square & Stem Diameter Diameter & Stem Balloon Square with Casters Square & Stem with Casters Diameter with Casters Diameter & Stem with Casters			\$ 880 \$ 1,305 \$ 880 \$ 1,305 \$ 985 \$ 1,105 \$ 1,530 \$ 1,105 \$ 1,530	

Edge Option:



Metal Leg Options:

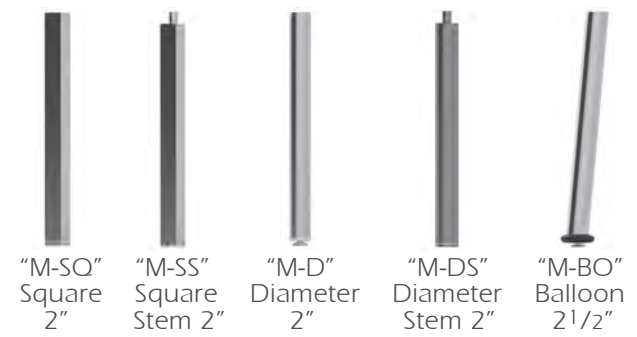

Wood Leg Options:

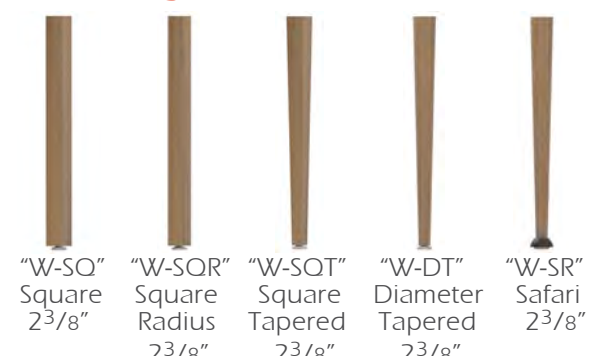

"MC" Caster Option:
Available on all Metal Legs ONLY, with exception of the Balloon leg and Metal Bases.

KREATIONS

MODEL NUMBER	PRODUCT	WIDTH	DEPTH	HEIGHT	PRICE	DESCRIPTION
 <p>*Shown Above: TB-3624-AL-M-D</p>  <p>*Rectangle Table Shape</p>	Rectangle Table, 36" Width,	36"	24"	29"		<p>Each Table Top is constructed using a 1 1/8" thick top with a Plastic Laminate top surface.</p> <p>All Metal legs are coated electrostatically with an epoxy powder coat paint.</p> <p>NOTES: * Table heights of 25" (children), 27" (youth), and 32" (wheelchair) are available by request. * Color of Metal Paint must be specified at the time of order. * Caster Leg options are recommended for Reading/Multipurpose Tables options and not meant to be used for stationary computer workstations. * For all tables with casters legs, only 2 legs will have casters, and the other legs will have levelers. This will create a "wheelbarrow" style of table which will ensure ease of mobility. * Color of the Caster Option must be specified at the time of order.</p>
	ALUMINUM Edge;					
	with WOOD Leg Option:	36"	24"	29"		
	TB-3624-AL-W-SQ	Square			\$ 885	
	TB-3624-AL-W-SQR	Square Radius			\$ 885	
	TB-3624-AL-W-SQT	Square Tapered			\$ 1,035	
	TB-3624-AL-W-DT	Diameter Tapered			\$ 1,165	
	TB-3624-AL-W-SR	Safari			\$ 1,170	
	with METAL Leg Option:	36"	24"	29"		
	TB-3624-AL-M-SQ	Square			\$ 820	
TB-3624-AL-M-SS	Square & Stem			\$ 1,240		
TB-3624-AL-M-D	Diameter			\$ 820		
TB-3624-AL-M-DS	Diameter & Stem			\$ 1,240		
TB-3624-AL-M-BO	Balloon			\$ 920		
TB-3624-AL-MC-SQ	Square with Casters			\$ 1,045		
TB-3624-AL-MC-SS	Square & Stem with Casters			\$ 1,470		
TB-3624-AL-MC-D	Diameter with Casters			\$ 1,045		
TB-3624-AL-MC-DS	Diameter & Stem with Casters			\$ 1,470		

Edge Option:

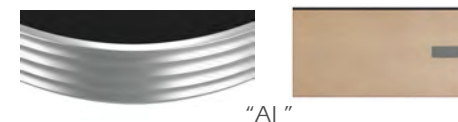

3mm Aluminum Edge *All table corners will be given a 6-inch radius for this edge option.

Metal Leg Options:



"M-SQ" Square 2"
 "M-SS" Square Stem 2"
 "M-D" Diameter 2"
 "M-DS" Diameter Stem 2"
 "M-BO" Balloon 2 1/2"

Wood Leg Options:





"W-SQ" Square 2 3/8"
 "W-SQR" Square Radius 2 3/8"
 "W-SQT" Square Tapered 2 3/8"
 "W-DT" Diameter Tapered 2 3/8"
 "W-SR" Safari 2 3/8"



"MC" Caster Option:
 Available on all Metal Legs ONLY, with exception of the Balloon leg and Metal Bases.

KREATIONS

MODEL NUMBER	PRODUCT	WIDTH	DEPTH	HEIGHT	PRICE	DESCRIPTION	
 <p>*Shown Above: TB-4824-AC-M-D</p>  <p>*Rectangle Table Shape</p>	Rectangle Table, 48" Width, 24" Depth	48"	24"	29"		Each Table Top is constructed using a 1" thick top with a Plastic Laminate top surface.	
	ACRYLIC Edge;					All Metal legs are coated electrostatically with an epoxy powder coat paint.	
	TB-4824-AC-W-SQ	with WOOD Leg Option: Square	48"	24"	29"	\$ 840	<p>NOTES: * Table heights of 25" (children), 27" (youth), and 32" (wheelchair) are available by request. * Color of Metal Paint must be specified at the time of order. * Caster Leg options are recommended for Reading/Multipurpose Tables options and not meant to be used for stationary computer workstations. * For all tables with casters legs, only 2 legs will have casters, and the other legs will have levelers. This will create a "wheelbarrow" style of table which will ensure ease of mobility. * Color of the Caster Option must be specified at the time of order.</p>
	TB-4824-AC-W-SQR	Square Radius				\$ 840	
	TB-4824-AC-W-SQT	Square Tapered				\$ 995	
	TB-4824-AC-W-DT	Diameter Tapered				\$ 1,125	
	TB-4824-AC-W-SR	Safari				\$ 1,130	
	TB-4824-AC-M-SQ	with METAL Leg Option: Square	48"	24"	29"	\$ 780	
	TB-4824-AC-M-SS	Square & Stem				\$ 1,200	
	TB-4824-AC-M-D	Diameter				\$ 780	
	TB-4824-AC-M-DS	Diameter & Stem				\$ 1,200	
	TB-4824-AC-M-BO	Balloon				\$ 880	
	TB-4824-AC-MC-SQ	Square with Casters				\$ 1,000	
	TB-4824-AC-MC-SS	Square & Stem with Casters				\$ 1,425	
TB-4824-AC-MC-D	Diameter with Casters				\$ 1,000		
TB-4824-AC-MC-DS	Diameter & Stem with Casters				\$ 1,425		
	Rectangle Table, 48" Width, 30" Depth	48"	30"	29"			
	ACRYLIC Edge;						
	TB-4830-AC-W-SQ	with WOOD Leg Option: Square	48"	30"	29"	\$ 870	
	TB-4830-AC-W-SQR	Square Radius				\$ 870	
	TB-4830-AC-W-SQT	Square Tapered				\$ 1,020	
	TB-4830-AC-W-DT	Diameter Tapered				\$ 1,150	
	TB-4830-AC-W-SR	Safari				\$ 1,160	
	TB-4830-AC-M-SQ	with METAL Leg Option: Square	48"	30"	29"	\$ 805	
	TB-4830-AC-M-SS	Square & Stem				\$ 1,225	
	TB-4830-AC-M-D	Diameter				\$ 805	
	TB-4830-AC-M-DS	Diameter & Stem				\$ 1,225	
	TB-4830-AC-M-BO	Balloon				\$ 905	
	TB-4830-AC-MC-SQ	Square with Casters				\$ 1,030	
	TB-4830-AC-MC-SS	Square & Stem with Casters				\$ 1,455	
TB-4830-AC-MC-D	Diameter with Casters				\$ 1,030		
TB-4830-AC-MC-DS	Diameter & Stem with Casters				\$ 1,455		

Edge Option:

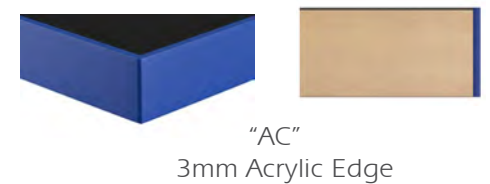

Metal Leg Options:

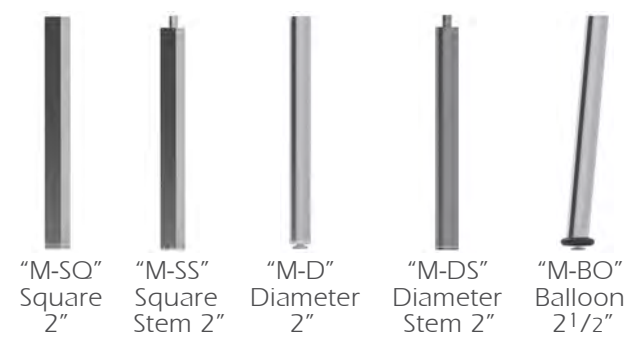

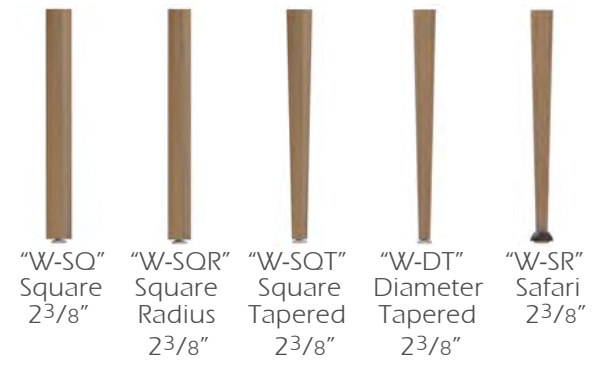

Wood Leg Options:



"MC" Caster Option:
Available on all Metal Legs ONLY, with exception of the Balloon leg and Metal Bases.

KREATIONS

MODEL NUMBER	PRODUCT	WIDTH	DEPTH	HEIGHT	PRICE	DESCRIPTION
 <p>*Shown Above: TB-4824-SQ-M-D</p>  <p>*Rectangle Table Shape</p>	Rectangle Table, 48" Width, 24" Depth SQUARE Edge; with WOOD Leg Option: Square Square Radius Square Tapered Diameter Tapered Safari	48"	24"	29"	\$ 955 \$ 955 \$ 1,110 \$ 1,235 \$ 1,240	Each Table Top is constructed using a 1 1/8" thick top with a Plastic Laminate top surface. All Metal legs are coated electrostatically with an epoxy powder coat paint. NOTES: * Table heights of 25" (children), 27" (youth), and 32" (wheelchair) are available by request. * Color of Metal Paint must be specified at the time of order. * Caster Leg options are recommended for Reading/Multipurpose Tables options and not meant to be used for stationary computer workstations. * For all tables with casters legs, only 2 legs will have casters, and the other legs will have levelers. This will create a "wheelbarrow" style of table which will ensure ease of mobility. * Color of the Caster Option must be specified at the time of order.
	with METAL Leg Option: Square Square & Stem Diameter Diameter & Stem Balloon Square with Casters Square & Stem with Casters Diameter with Casters Diameter & Stem with Casters	48"	24"	29"	\$ 890 \$ 1,315 \$ 890 \$ 1,315 \$ 995 \$ 1,115 \$ 1,540 \$ 1,115 \$ 1,540	
	Rectangle Table, 48" Width, 30" Depth SQUARE Edge; with WOOD Leg Option: Square Square Radius Square Tapered Diameter Tapered Safari	48"	30"	29"	\$ 995 \$ 995 \$ 1,145 \$ 1,275 \$ 1,280	
	with METAL Leg Option: Square Square & Stem Diameter Diameter & Stem Balloon Square with Casters Square & Stem with Casters Diameter with Casters Diameter & Stem with Casters	48"	30"	29"	\$ 930 \$ 1,350 \$ 930 \$ 1,350 \$ 1,030 \$ 1,155 \$ 1,580 \$ 1,155 \$ 1,580	

Edge Option:



Metal Leg Options:

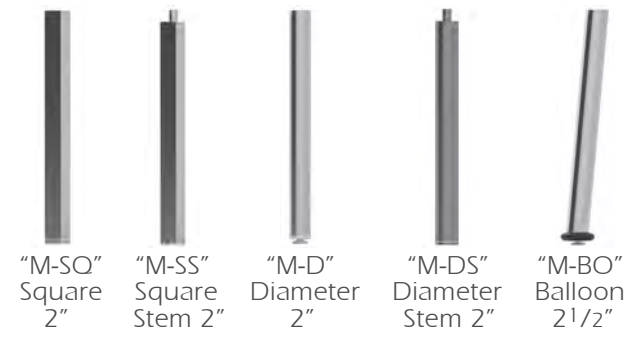



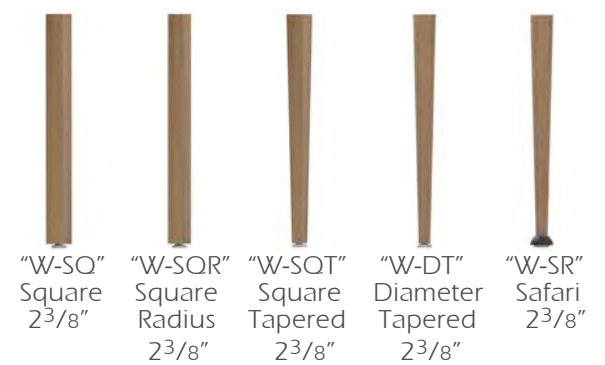



Wood Leg Options:









"MC" Caster Option:
Available on all Metal Legs ONLY, with exception of the Balloon leg and Metal Bases.



KREATIONS

MODEL NUMBER	PRODUCT	WIDTH	DEPTH	HEIGHT	PRICE	DESCRIPTION	
 <p>*Shown Above: TB-4824-DSQ-M-D</p>  <p>*Rectangle Table Shape</p>	Rectangle Table, 48" Width, 24" Depth	48"	24"	29"		<p>Each Table Top is constructed using a 1 1/8" thick top with a Plastic Laminate top surface.</p> <p>All Metal legs are coated electrostatically with an epoxy powder coat paint.</p> <p>NOTES: * Table heights of 25" (children), 27" (youth), and 32" (wheelchair) are available by request. * Color of Metal Paint must be specified at the time of order. * Caster Leg options are recommended for Reading/Multipurpose Tables options and not meant to be used for stationary computer workstations. * For all tables with casters legs, only 2 legs will have casters, and the other legs will have levelers. This will create a "wheelbarrow" style of table which will ensure ease of mobility. * Color of the Caster Option must be specified at the time of order.</p>	
	DROPPED SQUARE Edge;						
	with WOOD Leg Option:						
	TB-4824-DSQ-W-SQ	Square	48"	24"	29"		\$ 1,015
	TB-4824-DSQ-W-SQR	Square Radius					\$ 1,015
	TB-4824-DSQ-W-SQT	Square Tapered					\$ 1,165
	TB-4824-DSQ-W-DT	Diameter Tapered					\$ 1,295
	TB-4824-DSQ-W-SR	Safari					\$ 1,300
	with METAL Leg Option:						
	TB-4824-DSQ-M-SQ	Square	48"	24"	29"		\$ 950
	TB-4824-DSQ-M-SS	Square & Stem					\$ 1,370
	TB-4824-DSQ-M-D	Diameter					\$ 950
	TB-4824-DSQ-M-DS	Diameter & Stem					\$ 1,370
	TB-4824-DSQ-M-BO	Balloon					\$ 1,050
TB-4824-DSQ-MC-SQ	Square with Casters				\$ 1,175		
TB-4824-DSQ-MC-SS	Square & Stem with Casters				\$ 1,600		
TB-4824-DSQ-MC-D	Diameter with Casters				\$ 1,175		
TB-4824-DSQ-MC-DS	Diameter & Stem with Casters				\$ 1,600		
 <p>"DSQ" 3/4" Dropped Square Edge</p>							
<p>Edge Option:</p>							
<p>Metal Leg Options:</p>  <p>"M-SQ" Square 2" "M-SS" Square Stem 2" "M-D" Diameter 2" "M-DS" Diameter Stem 2" "M-BO" Balloon 2 1/2"</p>							
<p>Wood Leg Options:</p>  <p>"W-SQ" Square 2 3/8" "W-SQR" Square Radius 2 3/8" "W-SQT" Square Tapered 2 3/8" "W-DT" Diameter Tapered 2 3/8" "W-SR" Safari 2 3/8"</p>							
 <p>Black/Black White/Grey Silver/Orange Mirror Finish/Grey</p> <p>"MC" Caster Option: Available on all Metal Legs ONLY, with exception of the Balloon leg and Metal Bases.</p>							
	Rectangle Table, 48" Width, 30" Depth	48"	30"	29"			
DROPPED SQUARE Edge;							
with WOOD Leg Option:							
TB-4830-DSQ-W-SQ	Square	48"	30"	29"	\$ 1,055		
TB-4830-DSQ-W-SQR	Square Radius				\$ 1,055		
TB-4830-DSQ-W-SQT	Square Tapered				\$ 1,205		
TB-4830-DSQ-W-DT	Diameter Tapered				\$ 1,335		
TB-4830-DSQ-W-SR	Safari				\$ 1,345		
with METAL Leg Option:							
TB-4830-DSQ-M-SQ	Square	48"	30"	29"	\$ 990		
TB-4830-DSQ-M-SS	Square & Stem				\$ 1,415		
TB-4830-DSQ-M-D	Diameter				\$ 990		
TB-4830-DSQ-M-DS	Diameter & Stem				\$ 1,415		
TB-4830-DSQ-M-BO	Balloon				\$ 1,095		
TB-4830-DSQ-MC-SQ	Square with Casters				\$ 1,220		
TB-4830-DSQ-MC-SS	Square & Stem with Casters				\$ 1,640		
TB-4830-DSQ-MC-D	Diameter with Casters				\$ 1,220		
TB-4830-DSQ-MC-DS	Diameter & Stem with Casters				\$ 1,640		

KREATIONS

MODEL NUMBER	PRODUCT	WIDTH	DEPTH	HEIGHT	PRICE	DESCRIPTION
 <p>*Shown Above: TB-4824-DBN-M-D</p>  <p>*Rectangle Table Shape</p>	Rectangle Table, 48" Width, 24" Depth DROPPED BULLNOSE Edge; with WOOD Leg Option: Square Square Radius Square Tapered Diameter Tapered Safari with METAL Leg Option: Square Square & Stem Diameter Diameter & Stem Balloon Square with Casters Square & Stem with Casters Diameter with Casters Diameter & Stem with Casters	48"	24"	29"	\$ 1,025 \$ 1,025 \$ 1,175 \$ 1,305 \$ 1,315 \$ 960 \$ 1,380 \$ 960 \$ 1,380 \$ 1,065 \$ 1,185 \$ 1,610 \$ 1,185 \$ 1,610	Each Table Top is constructed using a 1 1/8" thick top with a Plastic Laminate top surface. All Metal legs are coated electrostatically with an epoxy powder coat paint. NOTES: * Table heights of 25" (children), 27" (youth), and 32" (wheelchair) are available by request. * Color of Metal Paint must be specified at the time of order. * Caster Leg options are recommended for Reading/Multipurpose Tables options and not meant to be used for stationary computer workstations. * For all tables with casters legs, only 2 legs will have casters, and the other legs will have levelers. This will create a "wheelbarrow" style of table which will ensure ease of mobility. * Color of the Caster Option must be specified at the time of order.
	Rectangle Table, 48" Width, 30" Depth DROPPED BULLNOSE Edge; with WOOD Leg Option: Square Square Radius Square Tapered Diameter Tapered Safari with METAL Leg Option: Square Square & Stem Diameter Diameter & Stem Balloon Square with Casters Square & Stem with Casters Diameter with Casters Diameter & Stem with Casters	48"	30"	29"	\$ 1,065 \$ 1,065 \$ 1,220 \$ 1,350 \$ 1,355 \$ 1,000 \$ 1,425 \$ 1,000 \$ 1,425 \$ 1,105 \$ 1,230 \$ 1,650 \$ 1,230 \$ 1,650	Edge Option:  <p>"DBN" 3/4" Dropped Bullnoses Edge</p> Metal Leg Options:  <p>"M-SQ" Square 2" "M-SS" Square Stem 2" "M-D" Diameter 2" "M-DS" Diameter Stem 2" "M-BO" Balloon 2 1/2"</p> Wood Leg Options:  <p>"W-SQ" Square 2 3/8" "W-SQR" Square Radius 2 3/8" "W-SQT" Square Tapered 2 3/8" "W-DT" Diameter Tapered 2 3/8" "W-SR" Safari 2 3/8"</p>  <p>Black/Black White/Grey Silver/Orange Mirror Finish/Grey</p> <p>"MC" Caster Option: Available on all Metal Legs ONLY, with exception of the Balloon leg and Metal Bases.</p>

KREATIONS

MODEL NUMBER	PRODUCT	WIDTH	DEPTH	HEIGHT	PRICE	DESCRIPTION	
 <p>*Shown Above: TB-4824-DCH-M-D</p>  <p>*Rectangle Table Shape</p>	Rectangle Table, 48" Width, 24" Depth	48"	24"	29"		Each Table Top is constructed using a 1 1/8" thick top with a Plastic Laminate top surface.	
		DROPPED CHAMFERED Edge;					All Metal legs are coated electrostatically with an epoxy powder coat paint.
		with WOOD Leg Option:	48"	24"	29"		NOTES:
	TB-4824-DCH-W-SQ	Square				\$ 1,025	* Table heights of 25" (children), 27" (youth), and 32" (wheelchair) are available by request.
	TB-4824-DCH-W-SQR	Square Radius				\$ 1,025	* Color of Metal Paint must be specified at the time of order.
	TB-4824-DCH-W-SQT	Square Tapered				\$ 1,175	* Caster Leg options are recommended for Reading/Multipurpose Tables options and not meant to be used for stationary computer workstations.
	TB-4824-DCH-W-DT	Diameter Tapered				\$ 1,305	* For all tables with casters legs, only 2 legs will have casters, and the other legs will have levelers. This will create a "wheelbarrow" style of table which will ensure ease of mobility.
	TB-4824-DCH-W-SR	Safari				\$ 1,315	* Color of the Caster Option must be specified at the time of order.
		with METAL Leg Option:	48"	24"	29"		
	TB-4824-DCH-M-SQ	Square				\$ 960	
	TB-4824-DCH-M-SS	Square & Stem				\$ 1,380	
	TB-4824-DCH-M-D	Diameter				\$ 960	
	TB-4824-DCH-M-DS	Diameter & Stem				\$ 1,380	
	TB-4824-DCH-M-BO	Balloon				\$ 1,065	
TB-4824-DCH-MC-SQ	Square with Casters				\$ 1,185		
TB-4824-DCH-MC-SS	Square & Stem with Casters				\$ 1,610		
TB-4824-DCH-MC-D	Diameter with Casters				\$ 1,185		
TB-4824-DCH-MC-DS	Diameter & Stem with Casters				\$ 1,610		
	Rectangle Table, 48" Width, 30" Depth	48"	30"	29"			
	DROPPED CHAMFERED Edge;						
	with WOOD Leg Option:	48"	30"	29"			
TB-4830-DCH-W-SQ	Square				\$ 1,065		
TB-4830-DCH-W-SQR	Square Radius				\$ 1,065		
TB-4830-DCH-W-SQT	Square Tapered				\$ 1,220		
TB-4830-DCH-W-DT	Diameter Tapered				\$ 1,350		
TB-4830-DCH-W-SR	Safari				\$ 1,355		
	with METAL Leg Option:	48"	30"	29"			
TB-4830-DCH-M-SQ	Square				\$ 1,000		
TB-4830-DCH-M-SS	Square & Stem				\$ 1,425		
TB-4830-DCH-M-D	Diameter				\$ 1,000		
TB-4830-DCH-M-DS	Diameter & Stem				\$ 1,425		
TB-4830-DCH-M-BO	Balloon				\$ 1,105		
TB-4830-DCH-MC-SQ	Square with Casters				\$ 1,230		
TB-4830-DCH-MC-SS	Square & Stem with Casters				\$ 1,650		
TB-4830-DCH-MC-D	Diameter with Casters				\$ 1,230		
TB-4830-DCH-MC-DS	Diameter & Stem with Casters				\$ 1,650		

Edge Option:



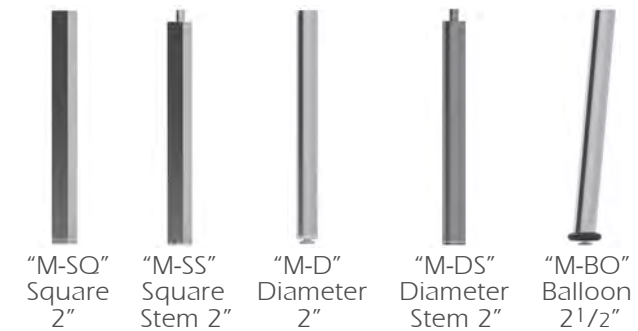

Metal Leg Options:

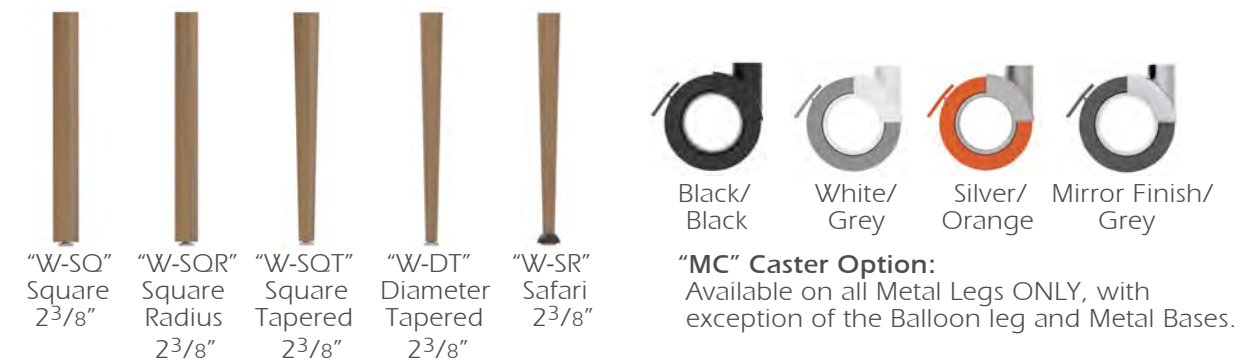

Wood Leg Options:



KREATIONS

MODEL NUMBER	PRODUCT	WIDTH	DEPTH	HEIGHT	PRICE	DESCRIPTION
 <p>*Shown Above: TB-4824-AL-M-D</p>  <p>*Rectangle Table Shape</p>	Rectangle Table, 48" Width, 24" Depth ALUMINUM Edge; with WOOD Leg Option:	48"	24"	29"		Each Table Top is constructed using a 1 1/8" thick top with a Plastic Laminate top surface. All Metal legs are coated electrostatically with an epoxy powder coat paint. NOTES: * Table heights of 25" (children), 27" (youth), and 32" (wheelchair) are available by request. * Color of Metal Paint must be specified at the time of order. * Caster Leg options are recommended for Reading/Multipurpose Tables options and not meant to be used for stationary computer workstations. * For all tables with casters legs, only 2 legs will have casters, and the other legs will have levelers. This will create a "wheelbarrow" style of table which will ensure ease of mobility. * Color of the Caster Option must be specified at the time of order.
	TB-4824-AL-W-SQ	Square	\$ 910			
	TB-4824-AL-W-SQR	Square Radius	\$ 910			
	TB-4824-AL-W-SQT	Square Tapered	\$ 1,065			
	TB-4824-AL-W-DT	Diameter Tapered	\$ 1,185			
	TB-4824-AL-W-SR	Safari	\$ 1,195			
	with METAL Leg Option:					
	TB-4824-AL-M-SQ	Square	\$ 845			
	TB-4824-AL-M-SS	Square & Stem	\$ 1,270			
	TB-4824-AL-M-D	Diameter	\$ 845			
	TB-4824-AL-M-DS	Diameter & Stem	\$ 1,270			
	TB-4824-AL-M-BO	Balloon	\$ 950			
	TB-4824-AL-MC-SQ	Square with Casters	\$ 1,070			
	TB-4824-AL-MC-SS	Square & Stem with Casters	\$ 1,495			
TB-4824-AL-MC-D	Diameter with Casters	\$ 1,070				
TB-4824-AL-MC-DS	Diameter & Stem with Casters	\$ 1,495				
	Rectangle Table, 48" Width, 30" Depth ALUMINUM Edge; with WOOD Leg Option:	48"	30"	29"		
	TB-4830-AL-W-SQ	Square	\$ 945			
	TB-4830-AL-W-SQR	Square Radius	\$ 945			
	TB-4830-AL-W-SQT	Square Tapered	\$ 1,095			
	TB-4830-AL-W-DT	Diameter Tapered	\$ 1,225			
	TB-4830-AL-W-SR	Safari	\$ 1,235			
	with METAL Leg Option:					
	TB-4830-AL-M-SQ	Square	\$ 880			
	TB-4830-AL-M-SS	Square & Stem	\$ 1,300			
	TB-4830-AL-M-D	Diameter	\$ 880			
	TB-4830-AL-M-DS	Diameter & Stem	\$ 1,300			
	TB-4830-AL-M-BO	Balloon	\$ 985			
	TB-4830-AL-MC-SQ	Square with Casters	\$ 1,105			
	TB-4830-AL-MC-SS	Square & Stem with Casters	\$ 1,530			
TB-4830-AL-MC-D	Diameter with Casters	\$ 1,105				
TB-4830-AL-MC-DS	Diameter & Stem with Casters	\$ 1,530				

Edge Option:



3mm Aluminum Edge *All table corners will be given a 6-inch radius for this edge option.

Metal Leg Options:



"M-SQ" Square 2"
 "M-SS" Square Stem 2"
 "M-D" Diameter 2"
 "M-DS" Diameter Stem 2"
 "M-BO" Balloon 2 1/2"

Wood Leg Options:





"W-SQ" Square 2 3/8"
 "W-SQR" Square Radius 2 3/8"
 "W-SQT" Square Tapered 2 3/8"
 "W-DT" Diameter Tapered 2 3/8"
 "W-SR" Safari 2 3/8"



"MC" Caster Option:
 Available on all Metal Legs ONLY, with exception of the Balloon leg and Metal Bases.

KREATIONS

MODEL NUMBER	PRODUCT	WIDTH	DEPTH	HEIGHT	PRICE	DESCRIPTION	
 <p>*Shown Above: TB-6024-AC-M-D</p>  <p>*Rectangle Table Shape</p>	Rectangle Table, 60" Width, 24" Depth	60"	24"	29"		Each Table Top is constructed using a 1" thick top with a Plastic Laminate top surface.	
	ACRYLIC Edge;					All Metal legs are coated electrostatically with an epoxy powder coat paint.	
	with WOOD Leg Option:					NOTES:	
	TB-6024-AC-W-SQ	Square	60"	24"	29"	\$ 870	* Table heights of 25" (children), 27" (youth), and 32" (wheelchair) are available by request.
	TB-6024-AC-W-SQR	Square Radius				\$ 870	* Color of Metal Paint must be specified at the time of order.
	TB-6024-AC-W-SQT	Square Tapered				\$ 1,020	* Caster Leg options are recommended for Reading/Multipurpose Tables options and not meant to be used for stationary computer workstations.
	TB-6024-AC-W-DT	Diameter Tapered				\$ 1,150	* For all tables with casters legs, only 2 legs will have casters, and the other legs will have levelers. This will create a "wheelbarrow" style of table which will ensure ease of mobility.
	TB-6024-AC-W-SR	Safari				\$ 1,160	* Color of the Caster Option must be specified at the time of order.
	with METAL Leg Option:						* For the Flip OR Fold Leg option, one T base leg comes with 2 hidden casters as shown in the image below.
	TB-6024-AC-M-SQ	Square	60"	24"	29"	\$ 805	
TB-6024-AC-M-SS	Square & Stem				\$ 1,225		
TB-6024-AC-M-D	Diameter				\$ 805		
TB-6024-AC-M-DS	Diameter & Stem				\$ 1,225		
TB-6024-AC-M-BO	Balloon				\$ 905		
TB-6024-AC-MC-SQ	Square with Casters				\$ 1,030		
TB-6024-AC-MC-SS	Square & Stem with Casters				\$ 1,455		
TB-6024-AC-MC-D	Diameter with Casters				\$ 1,030		
TB-6024-AC-MC-DS	Diameter & Stem with Casters				\$ 1,455		
TB-6024-AC-FL	Flip Leg (for Nesting Tables)				\$ 1,720		
TB-6024-AC-FD	Folding Leg				\$ 1,720		
	Rectangle Table, 60" Width, 30" Depth	60"	30"	29"			
	ACRYLIC Edge;						
	with WOOD Leg Option:						
TB-6030-AC-W-SQ	Square	60"	30"	29"	\$ 985		
TB-6030-AC-W-SQR	Square Radius				\$ 985		
TB-6030-AC-W-SQT	Square Tapered				\$ 1,135		
TB-6030-AC-W-DT	Diameter Tapered				\$ 1,265		
TB-6030-AC-W-SR	Safari				\$ 1,270		
	with METAL Leg Option:						
TB-6030-AC-M-SQ	Square	60"	30"	29"	\$ 920		
TB-6030-AC-M-SS	Square & Stem				\$ 1,340		
TB-6030-AC-M-D	Diameter				\$ 920		
TB-6030-AC-M-DS	Diameter & Stem				\$ 1,340		
TB-6030-AC-M-BO	Balloon				\$ 1,020		
TB-6030-AC-MC-SQ	Square with Casters				\$ 1,140		
TB-6030-AC-MC-SS	Square & Stem with Casters				\$ 1,570		
TB-6030-AC-MC-D	Diameter with Casters				\$ 1,140		
TB-6030-AC-MC-DS	Diameter & Stem with Casters				\$ 1,570		
TB-6030-AC-FL	Flip Leg (for Nesting Tables)				\$ 1,770		
TB-6030-AC-FD	Folding Leg				\$ 1,770		

Edge Option:

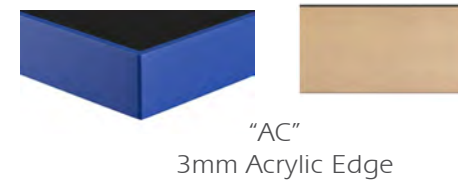

Metal Leg Options:

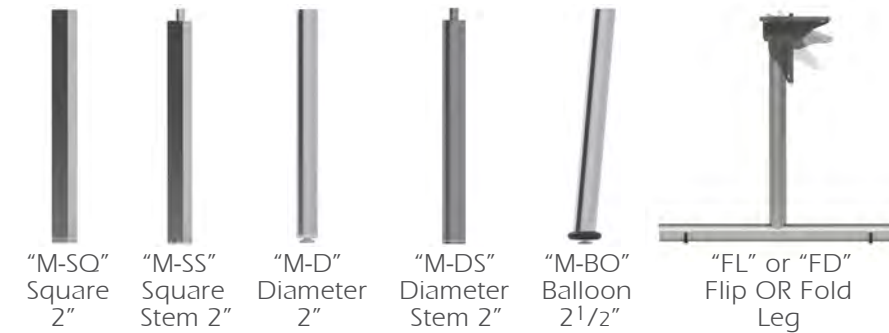

Wood Leg Options:

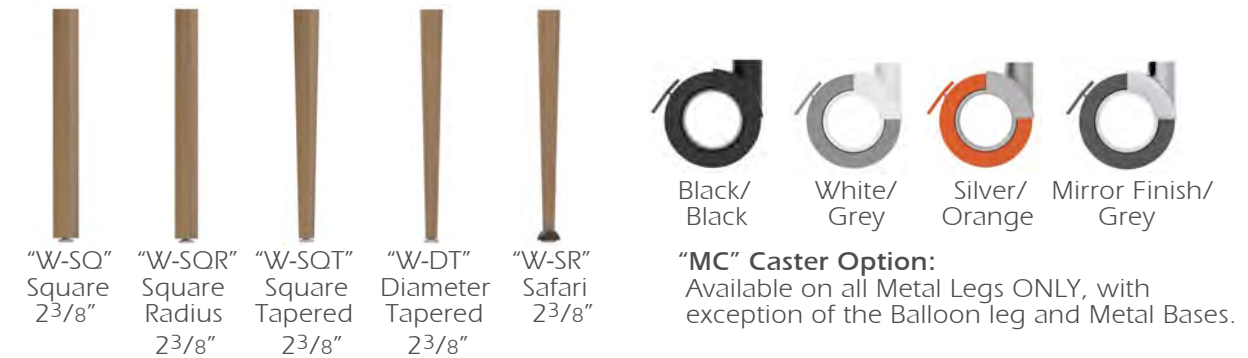

KREATIONS

MODEL NUMBER	PRODUCT	WIDTH	DEPTH	HEIGHT	PRICE	DESCRIPTION	
 <p>*Shown Above: TB-6024-AC-M-D</p>  <p>*Rectangle Table Shape</p>	Rectangle Table, 60" Width, 36" Depth	60"	36"	29"		Each Table Top is constructed using a 1" thick top with a Plastic Laminate top surface.	
	ACRYLIC Edge;					All Metal legs are coated electrostatically with an epoxy powder coat paint.	
	with WOOD Leg Option:					NOTES:	
	TB-6036-AC-W-SQ	Square	60"	36"	29"	\$ 1,015	* Table heights of 25" (children), 27" (youth), and 32" (wheelchair) are available by request.
	TB-6036-AC-W-SQR	Square Radius				\$ 1,015	* Color of Metal Paint must be specified at the time of order.
	TB-6036-AC-W-SQT	Square Tapered				\$ 1,170	* Caster Leg options are recommended for Reading/Multipurpose Tables options and not meant to be used for stationary computer workstations.
	TB-6036-AC-W-DT	Diameter Tapered				\$ 1,295	* For all tables with casters legs, only 2 legs will have casters, and the other legs will have levelers. This will create a "wheelbarrow" style of table which will ensure ease of mobility.
	TB-6036-AC-W-SR	Safari				\$ 1,650	* Color of the Caster Option must be specified at the time of order.
	with METAL Leg Option:						* For the Flip OR Fold Leg option, one T base leg comes with 2 hidden casters as shown in the image below.
	TB-6036-AC-M-SQ	Square	60"	36"	29"	\$ 950	
TB-6036-AC-M-SS	Square & Stem				\$ 1,380		
TB-6036-AC-M-D	Diameter				\$ 950		
TB-6036-AC-M-DS	Diameter & Stem				\$ 1,380		
TB-6036-AC-M-BO	Balloon				\$ 1,055		
TB-6036-AC-MC-SQ	Square with Casters				\$ 1,180		
TB-6036-AC-MC-SS	Square & Stem with Casters				\$ 1,600		
TB-6036-AC-MC-D	Diameter with Casters				\$ 1,180		
TB-6036-AC-MC-DS	Diameter & Stem with Casters				\$ 1,600		
TB-6036-AC-FL	Flip Leg (for Nesting Tables)				\$ 1,805		
TB-6036-AC-FD	Folding Leg				\$ 1,805		

Edge Option:

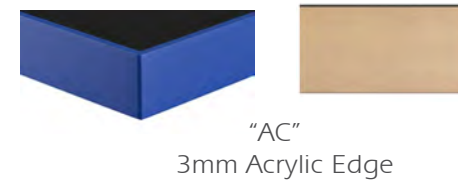

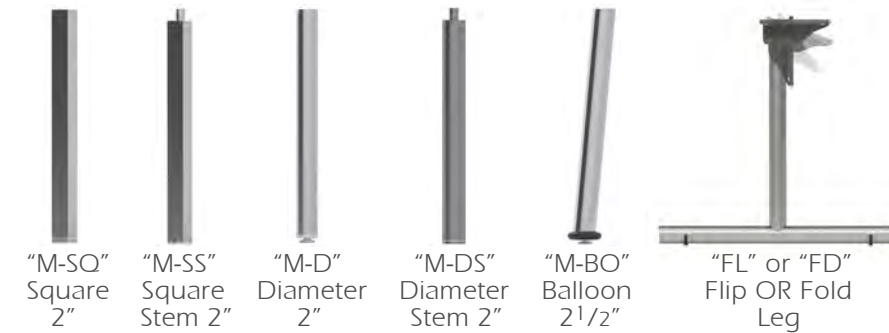

Metal Leg Options:



Wood Leg Options:



KREATIONS

MODEL NUMBER	PRODUCT	WIDTH	DEPTH	HEIGHT	PRICE	DESCRIPTION	
 <p>*Shown Above: TB-6024-SQ-M-D</p>  <p>*Rectangle Table Shape</p>	Rectangle Table, 60" Width, 24" Depth	60"	24"	29"		Each Table Top is constructed using a 1 1/8" thick top with a Plastic Laminate top surface.	
	SQUARE Edge;					All Metal legs are coated electrostatically with an epoxy powder coat paint.	
	with WOOD Leg Option:					NOTES:	
	TB-6024-SQ-W-SQ	Square	60"	24"	29"	\$ 1,005	* Table heights of 25" (children), 27" (youth), and 32" (wheelchair) are available by request.
	TB-6024-SQ-W-SQR	Square Radius				\$ 1,005	* Color of Metal Paint must be specified at the time of order.
	TB-6024-SQ-W-SQT	Square Tapered				\$ 1,160	* Caster Leg options are recommended for Reading/Multipurpose Tables options and not meant to be used for stationary computer workstations.
	TB-6024-SQ-W-DT	Diameter Tapered				\$ 1,285	* For all tables with casters legs, only 2 legs will have casters, and the other legs will have levelers. This will create a "wheelbarrow" style of table which will ensure ease of mobility.
	TB-6024-SQ-W-SR	Safari				\$ 1,290	* Color of the Caster Option must be specified at the time of order.
	with METAL Leg Option:						* For the Flip OR Fold Leg option, one T base leg comes with 2 hidden casters as shown in the image below.
	TB-6024-SQ-M-SQ	Square	60"	24"	29"	\$ 940	
TB-6024-SQ-M-SS	Square & Stem				\$ 1,365		
TB-6024-SQ-M-D	Diameter				\$ 940		
TB-6024-SQ-M-DS	Diameter & Stem				\$ 1,365		
TB-6024-SQ-M-BO	Balloon				\$ 1,045		
TB-6024-SQ-MC-SQ	Square with Casters				\$ 1,165		
TB-6024-SQ-MC-SS	Square & Stem with Casters				\$ 1,590		
TB-6024-SQ-MC-D	Diameter with Casters				\$ 1,165		
TB-6024-SQ-MC-DS	Diameter & Stem with Casters				\$ 1,590		
TB-6024-SQ-FL	Flip Leg (for Nesting Tables)				\$ 1,845		
TB-6024-SQ-FD	Folding Leg				\$ 1,845		
	Rectangle Table, 60" Width, 30" Depth	60"	30"	29"			
	SQUARE Edge;						
	with WOOD Leg Option:						
TB-6030-SQ-W-SQ	Square	60"	30"	29"	\$ 1,125		
TB-6030-SQ-W-SQR	Square Radius				\$ 1,125		
TB-6030-SQ-W-SQT	Square Tapered				\$ 1,275		
TB-6030-SQ-W-DT	Diameter Tapered				\$ 1,405		
TB-6030-SQ-W-SR	Safari				\$ 1,410		
	with METAL Leg Option:						
TB-6030-SQ-M-SQ	Square	60"	30"	29"	\$ 1,060		
TB-6030-SQ-M-SS	Square & Stem				\$ 1,485		
TB-6030-SQ-M-D	Diameter				\$ 1,060		
TB-6030-SQ-M-DS	Diameter & Stem				\$ 1,485		
TB-6030-SQ-M-BO	Balloon				\$ 1,160		
TB-6030-SQ-MC-SQ	Square with Casters				\$ 1,285		
TB-6030-SQ-MC-SS	Square & Stem with Casters				\$ 1,710		
TB-6030-SQ-MC-D	Diameter with Casters				\$ 1,285		
TB-6030-SQ-MC-DS	Diameter & Stem with Casters				\$ 1,710		
TB-6030-SQ-FL	Flip Leg (for Nesting Tables)				\$ 1,915		
TB-6030-SQ-FD	Folding Leg				\$ 1,915		

Edge Option:



Metal Leg Options:

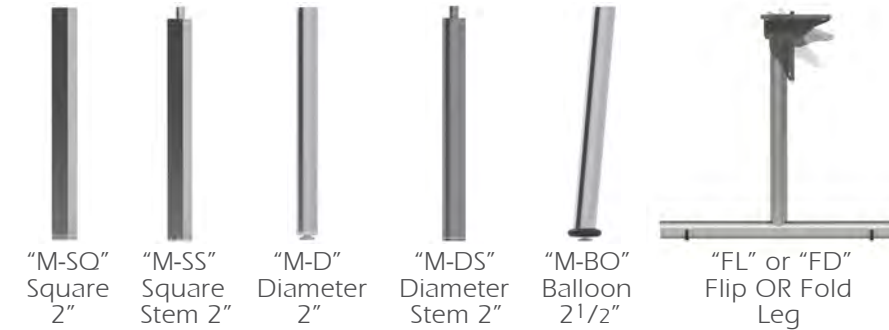

Wood Leg Options:



KREATIONS

MODEL NUMBER	PRODUCT	WIDTH	DEPTH	HEIGHT	PRICE	DESCRIPTION
 *Shown Above: TB-6024-SQ-M-D	Rectangle Table, 60" Width, 36" Depth	60"	36"	29"		Each Table Top is constructed using a 1 1/8" thick top with a Plastic Laminate top surface. All Metal legs are coated electrostatically with an epoxy powder coat paint. NOTES: * Table heights of 25" (children), 27" (youth), and 32" (wheelchair) are available by request. * Color of Metal Paint must be specified at the time of order. * Caster Leg options are recommended for Reading/Multipurpose Tables options and not meant to be used for stationary computer workstations. * For all tables with casters legs, only 2 legs will have casters, and the other legs will have levelers. This will create a "wheelbarrow" style of table which will ensure ease of mobility. * Color of the Caster Option must be specified at the time of order. * For the Flip OR Fold Leg option, one T base leg comes with 2 hidden casters as shown in the image below.
	SQUARE Edge;					
 *Rectangle Table Shape	with WOOD Leg Option:	60"	36"	29"		
	TB-6036-SQ-W-SQ	Square			\$ 1,170	
	TB-6036-SQ-W-SQR	Square Radius			\$ 1,170	
	TB-6036-SQ-W-SQT	Square Tapered			\$ 1,320	
	TB-6036-SQ-W-DT	Diameter Tapered			\$ 1,450	
	TB-6036-SQ-W-SR	Safari			\$ 1,460	
	with METAL Leg Option:	60"	36"	29"		
	TB-6036-SQ-M-SQ	Square			\$ 1,105	
	TB-6036-SQ-M-SS	Square & Stem			\$ 1,530	
	TB-6036-SQ-M-D	Diameter			\$ 1,105	
	TB-6036-SQ-M-DS	Diameter & Stem			\$ 1,530	
	TB-6036-SQ-M-BO	Balloon			\$ 1,205	
	TB-6036-SQ-MC-SQ	Square with Casters			\$ 1,330	
	TB-6036-SQ-MC-SS	Square & Stem with Casters			\$ 1,755	
	TB-6036-SQ-MC-D	Diameter with Casters			\$ 1,330	
	TB-6036-SQ-MC-DS	Diameter & Stem with Casters			\$ 1,755	
TB-6036-SQ-FL	Flip Leg (for Nesting Tables)			\$ 1,960		
TB-6036-SQ-FD	Folding Leg			\$ 1,960		

Edge Option:



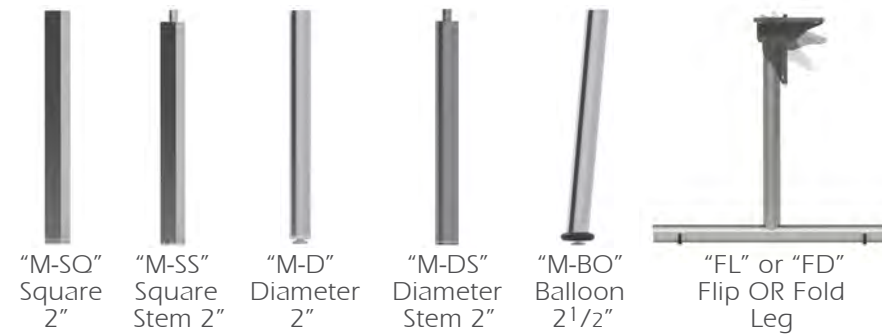

Metal Leg Options:

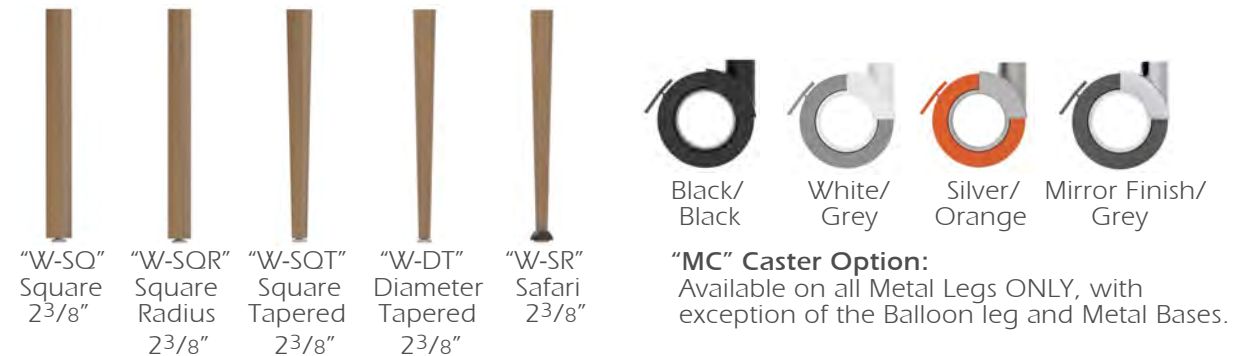

Wood Leg Options:



KREATIONS

MODEL NUMBER	PRODUCT	WIDTH	DEPTH	HEIGHT	PRICE	DESCRIPTION
 *Shown Above: TB-6024-DSQ-M-D	Rectangle Table, 60" Width, 24" Depth	60"	24"	29"		Each Table Top is constructed using a 1 1/8" thick top with a Plastic Laminate top surface.
	DROPPED SQUARE Edge;					All Metal legs are coated electrostatically with an epoxy powder coat paint.
 *Rectangle Table Shape	with WOOD Leg Option:	60"	24"	29"		NOTES: * Table heights of 25" (children), 27" (youth), and 32" (wheelchair) are available by request. * Color of Metal Paint must be specified at the time of order. * Caster Leg options are recommended for Reading/Multipurpose Tables options and not meant to be used for stationary computer workstations. * For all tables with casters legs, only 2 legs will have casters, and the other legs will have levelers. This will create a "wheelbarrow" style of table which will ensure ease of mobility. * Color of the Caster Option must be specified at the time of order. * For the Flip OR Fold Leg option, one T base leg comes with 2 hidden casters as shown in the image below
	TB-6024-DSQ-W-SQ Square				\$ 1,070	
	TB-6024-DSQ-W-SQR Square Radius				\$ 1,070	
	TB-6024-DSQ-W-SQT Square Tapered				\$ 1,220	
	TB-6024-DSQ-W-DT Diameter Tapered				\$ 1,350	
	TB-6024-DSQ-W-SR Safari				\$ 1,360	
	with METAL Leg Option:	60"	24"	29"		
	TB-6024-DSQ-M-SQ Square				\$ 1,005	
	TB-6024-DSQ-M-SS Square & Stem				\$ 1,430	
	TB-6024-DSQ-M-D Diameter				\$ 1,005	
	TB-6024-DSQ-M-DS Diameter & Stem				\$ 1,430	
	TB-6024-DSQ-M-BO Balloon				\$ 1,110	
	TB-6024-DSQ-MC-SQ Square with Casters				\$ 1,235	
	TB-6024-DSQ-MC-SS Square & Stem with Casters				\$ 1,655	
	TB-6024-DSQ-MC-D Diameter with Casters				\$ 1,235	
	TB-6024-DSQ-MC-DS Diameter & Stem with Casters				\$ 1,655	
	TB-6024-DSQ-FL Flip Leg (for Nesting Tables)				\$ 1,910	
	TB-6024-DSQ-FD Folding Leg				\$ 1,910	
	Rectangle Table, 60" Width, 30" Depth	60"	30"	29"		
	DROPPED SQUARE Edge;					
	with WOOD Leg Option:	60"	30"	29"		
TB-6030-DSQ-W-SQ Square					\$ 1,200	
TB-6030-DSQ-W-SQR Square Radius					\$ 1,200	
TB-6030-DSQ-W-SQT Square Tapered					\$ 1,350	
TB-6030-DSQ-W-DT Diameter Tapered					\$ 1,480	
TB-6030-DSQ-W-SR Safari					\$ 1,490	
	with METAL Leg Option:	60"	30"	29"		
TB-6030-DSQ-M-SQ Square					\$ 1,135	
TB-6030-DSQ-M-SS Square & Stem					\$ 1,555	
TB-6030-DSQ-M-D Diameter					\$ 1,135	
TB-6030-DSQ-M-DS Diameter & Stem					\$ 1,555	
TB-6030-DSQ-M-BO Balloon					\$ 1,235	
TB-6030-DSQ-MC-SQ Square with Casters					\$ 1,360	
TB-6030-DSQ-MC-SS Square & Stem with Casters					\$ 1,785	
TB-6030-DSQ-MC-D Diameter with Casters					\$ 1,360	
TB-6030-DSQ-MC-DS Diameter & Stem with Casters					\$ 1,785	
TB-6030-DSQ-FL Flip Leg (for Nesting Tables)					\$ 2,140	
TB-6030-DSQ-FD Folding Leg					\$ 2,140	

Edge Option:



Metal Leg Options:

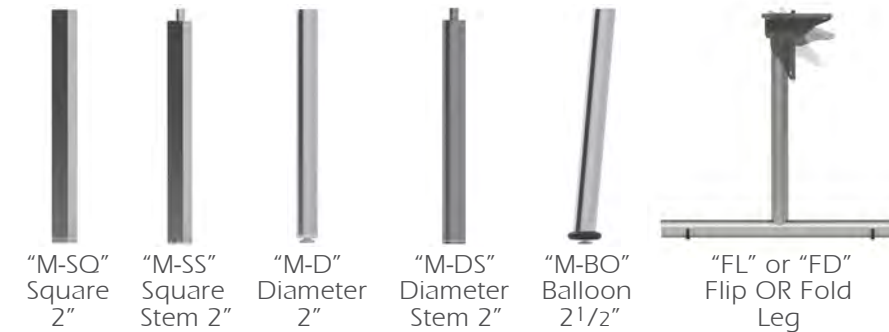

Wood Leg Options:

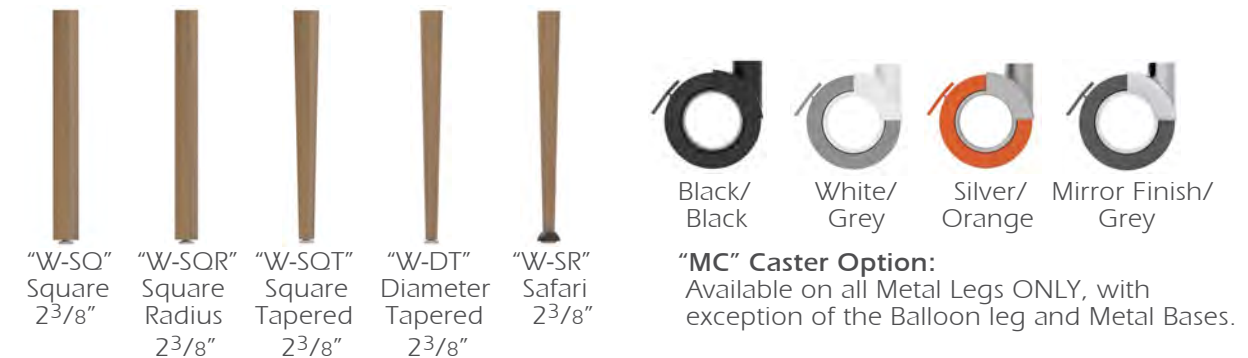

KREATIONS

MODEL NUMBER	PRODUCT	WIDTH	DEPTH	HEIGHT	PRICE	DESCRIPTION
	Rectangle Table, 60" Width, 36" Depth	60"	36"	29"		Each Table Top is constructed using a 1 1/8" thick top with a Plastic Laminate top surface.
	DROPPED SQUARE Edge;					All Metal legs are coated electrostatically with an epoxy powder coat paint.
	with WOOD Leg Option:	60"	36"	29"		NOTES: * Table heights of 25" (children), 27" (youth), and 32" (wheelchair) are available by request. * Color of Metal Paint must be specified at the time of order. * Caster Leg options are recommended for Reading/Multipurpose Tables options and not meant to be used for stationary computer workstations. * For all tables with casters legs, only 2 legs will have casters, and the other legs will have levelers. This will create a "wheelbarrow" style of table which will ensure ease of mobility. * Color of the Caster Option must be specified at the time of order. * For the Flip OR Fold Leg option, one T base leg comes with 2 hidden casters as shown in the image below
	TB-6036-DSQ-W-SQ Square				\$ 1,250	
	TB-6036-DSQ-W-SQR Square Radius				\$ 1,250	
	TB-6036-DSQ-W-SQT Square Tapered				\$ 1,400	
	TB-6036-DSQ-W-DT Diameter Tapered				\$ 1,530	
	TB-6036-DSQ-W-SR Safari				\$ 1,540	
	with METAL Leg Option:	60"	36"	29"		
	TB-6036-DSQ-M-SQ Square				\$ 1,185	
	TB-6036-DSQ-M-SS Square & Stem				\$ 1,610	
	TB-6036-DSQ-M-D Diameter				\$ 1,185	
	TB-6036-DSQ-M-DS Diameter & Stem				\$ 1,610	
	TB-6036-DSQ-M-BO Balloon				\$ 1,285	
	TB-6036-DSQ-MC-SQ Square with Casters				\$ 1,410	
	TB-6036-DSQ-MC-SS Square & Stem with Casters				\$ 1,835	
	TB-6036-DSQ-MC-D Diameter with Casters				\$ 1,410	
	TB-6036-DSQ-MC-DS Diameter & Stem with Casters				\$ 1,835	
	TB-6036-DSQ-FL Flip Leg (for Nesting Tables)				\$ 2,040	
	TB-6036-DSQ-FD Folding Leg				\$ 2,040	

*Shown Above:
TB-6024-DSQ-M-D



*Rectangle Table Shape

Edge Option:



Metal Leg Options:



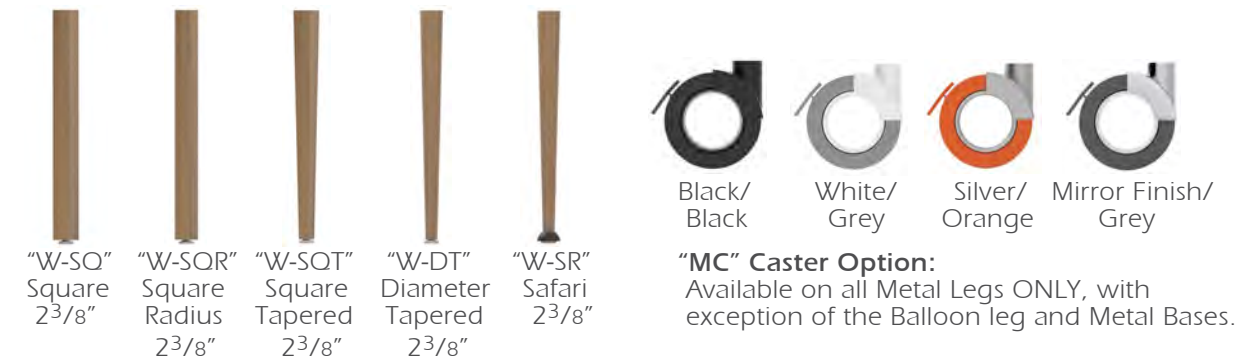

Wood Leg Options:



"MC" Caster Option:
Available on all Metal Legs ONLY, with exception of the Balloon leg and Metal Bases.

KREATIONS

MODEL NUMBER	PRODUCT	WIDTH	DEPTH	HEIGHT	PRICE	DESCRIPTION	
 <p>*Shown Above: TB-6024-DBN-M-D</p>  <p>*Rectangle Table Shape</p>	Rectangle Table, 60" Width, 24" Depth DROPPED BULLNOSE Edge; with WOOD Leg Option:	60"	24"	29"		Each Table Top is constructed using a 1 1/8" thick top with a Plastic Laminate top surface. All Metal legs are coated electrostatically with an epoxy powder coat paint.	
	TB-6024-DBN-W-SQ	Square	60"	24"	29"	\$ 1,080	NOTES: * Table heights of 25" (children), 27" (youth), and 32" (wheelchair) are available by request. * Color of Metal Paint must be specified at the time of order. * Caster Leg options are recommended for Reading/Multipurpose Tables options and not meant to be used for stationary computer workstations. * For all tables with casters legs, only 2 legs will have casters, and the other legs will have levelers. This will create a "wheelbarrow" style of table which will ensure ease of mobility. * Color of the Caster Option must be specified at the time of order. * For the Flip OR Fold Leg option, one T base leg comes with 2 hidden casters as shown in the image below
	TB-6024-DBN-W-SQR	Square Radius				\$ 1,080	
	TB-6024-DBN-W-SQT	Square Tapered				\$ 1,235	
	TB-6024-DBN-W-DT	Diameter Tapered				\$ 1,365	
	TB-6024-DBN-W-SR	Safari				\$ 1,370	
	with METAL Leg Option:		60"	24"	29"		
	TB-6024-DBN-M-SQ	Square				\$ 1,015	
	TB-6024-DBN-M-SS	Square & Stem				\$ 1,445	
	TB-6024-DBN-M-D	Diameter				\$ 1,015	
	TB-6024-DBN-M-DS	Diameter & Stem				\$ 1,445	
	TB-6024-DBN-M-BO	Balloon				\$ 1,120	
	TB-6024-DBN-MC-SQ	Square with Casters				\$ 1,245	
	TB-6024-DBN-MC-SS	Square & Stem with Casters				\$ 1,665	
	TB-6024-DBN-MC-D	Diameter with Casters				\$ 1,245	
	TB-6024-DBN-MC-DS	Diameter & Stem with Casters				\$ 1,665	
	TB-6024-DBN-FL	Flip Leg (for Nesting Tables)				\$ 1,920	
TB-6024-DBN-FD	Folding Leg				\$ 1,920		
	Rectangle Table, 60" Width, 30" Depth DROPPED BULLNOSE Edge; with WOOD Leg Option:	60"	30"	29"			
	TB-6030-DBN-W-SQ	Square	60"	30"	29"	\$ 1,210	
	TB-6030-DBN-W-SQR	Square Radius				\$ 1,210	
	TB-6030-DBN-W-SQT	Square Tapered				\$ 1,365	
	TB-6030-DBN-W-DT	Diameter Tapered				\$ 1,490	
	TB-6030-DBN-W-SR	Safari				\$ 1,500	
	with METAL Leg Option:		60"	30"	29"		
	TB-6030-DBN-M-SQ	Square				\$ 1,145	
	TB-6030-DBN-M-SS	Square & Stem				\$ 1,570	
	TB-6030-DBN-M-D	Diameter				\$ 1,145	
	TB-6030-DBN-M-DS	Diameter & Stem				\$ 1,570	
	TB-6030-DBN-M-BO	Balloon				\$ 1,250	
	TB-6030-DBN-MC-SQ	Square with Casters				\$ 1,370	
	TB-6030-DBN-MC-SS	Square & Stem with Casters				\$ 1,795	
	TB-6030-DBN-MC-D	Diameter with Casters				\$ 1,370	
	TB-6030-DBN-MC-DS	Diameter & Stem with Casters				\$ 1,795	
	TB-6030-DBN-FL	Flip Leg (for Nesting Tables)				\$ 2,150	
TB-6030-DBN-FD	Folding Leg				\$ 2,150		

Edge Option:



Metal Leg Options:



Wood Leg Options:



KREATIONS

MODEL NUMBER	PRODUCT	WIDTH	DEPTH	HEIGHT	PRICE	DESCRIPTION
	Rectangle Table, 60" Width, 36" Depth	60"	36"	29"		Each Table Top is constructed using a 1 1/8" thick top with a Plastic Laminate top surface.
	DROPPED BULLNOSE Edge;					All Metal legs are coated electrostatically with an epoxy powder coat paint.
*Shown Above: TB-6024-DBN-M-D	with WOOD Leg Option:	60"	36"	29"		NOTES: * Table heights of 25" (children), 27" (youth), and 32" (wheelchair) are available by request. * Color of Metal Paint must be specified at the time of order. * Caster Leg options are recommended for Reading/Multipurpose Tables options and not meant to be used for stationary computer workstations. * For all tables with casters legs, only 2 legs will have casters, and the other legs will have levelers. This will create a "wheelbarrow" style of table which will ensure ease of mobility. * Color of the Caster Option must be specified at the time of order. * For the Flip OR Fold Leg option, one T base leg comes with 2 hidden casters as shown in the image below
	TB-6036-DBN-W-SQ Square				\$ 1,260	
	TB-6036-DBN-W-SQR Square Radius				\$ 1,260	
	TB-6036-DBN-W-SQT Square Tapered				\$ 1,410	
	TB-6036-DBN-W-DT Diameter Tapered				\$ 1,540	
	TB-6036-DBN-W-SR Safari				\$ 1,550	
	with METAL Leg Option:	60"	36"	29"		
	TB-6036-DBN-M-SQ Square				\$ 1,195	
	TB-6036-DBN-M-SS Square & Stem				\$ 1,620	
	TB-6036-DBN-M-D Diameter				\$ 1,195	
	TB-6036-DBN-M-DS Diameter & Stem				\$ 1,620	
	TB-6036-DBN-M-BO Balloon				\$ 1,300	
	TB-6036-DBN-MC-SQ Square with Casters				\$ 1,425	
	TB-6036-DBN-MC-SS Square & Stem with Casters				\$ 1,845	
	TB-6036-DBN-MC-D Diameter with Casters				\$ 1,425	
	TB-6036-DBN-MC-DS Diameter & Stem with Casters				\$ 1,845	
	TB-6036-DBN-FL Flip Leg (for Nesting Tables)				\$ 2,050	
	TB-6036-DBN-FD Folding Leg				\$ 2,050	



*Rectangle Table Shape

Edge Option:



"DBN"
3/4" Dropped Bullnoses Edge

Metal Leg Options:

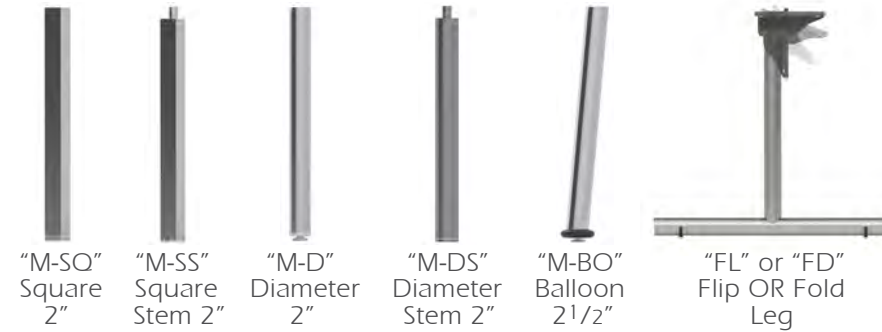

"M-SQ" Square 2"
"M-SS" Square Stem 2"
"M-D" Diameter 2"
"M-DS" Diameter Stem 2"
"M-BO" Balloon 2 1/2"
"FL" or "FD" Flip OR Fold Leg

Wood Leg Options:

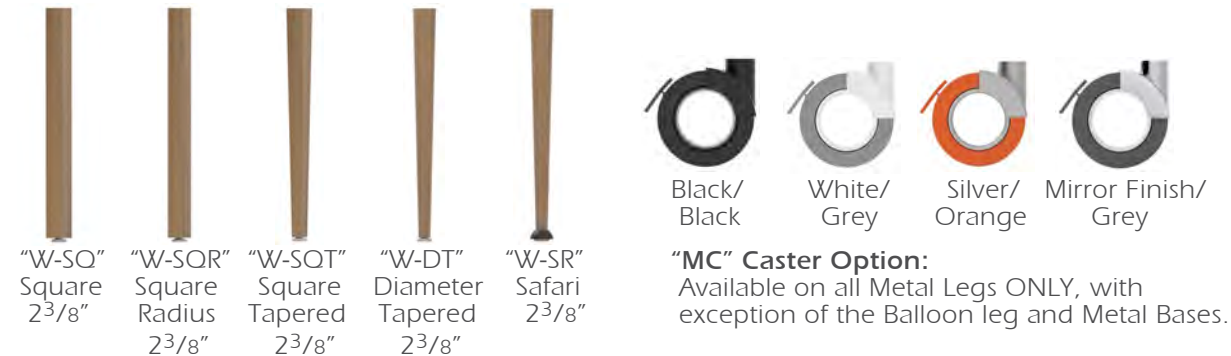



"W-SQ" Square 2 3/8"
"W-SQR" Square Radius 2 3/8"
"W-SQT" Square Tapered 2 3/8"
"W-DT" Diameter Tapered 2 3/8"
"W-SR" Safari 2 3/8"

Black/Black White/Grey Silver/Orange Mirror Finish/Grey

"MC" Caster Option:
Available on all Metal Legs ONLY, with exception of the Balloon leg and Metal Bases.

KREATIONS

MODEL NUMBER	PRODUCT	WIDTH	DEPTH	HEIGHT	PRICE	DESCRIPTION	
 <p>*Shown Above: TB-6024-DCH-M-D</p>  <p>*Rectangle Table Shape</p>	Rectangle Table, 60" Width, 24" Depth	60"	24"	29"		Each Table Top is constructed using a 1 1/8" thick top with a Plastic Laminate top surface.	
	DROPPED CHAMFERED Edge;					All Metal legs are coated electrostatically with an epoxy powder coat paint.	
	with WOOD Leg Option:	60"	24"	29"		NOTES:	
	TB-6024-DCH-W-SQ	Square				\$ 1,080	* Table heights of 25" (children), 27" (youth), and 32" (wheelchair) are available by request.
	TB-6024-DCH-W-SQR	Square Radius				\$ 1,080	* Color of Metal Paint must be specified at the time of order.
	TB-6024-DCH-W-SQT	Square Tapered				\$ 1,235	* Caster Leg options are recommended for Reading/Multipurpose Tables options and not meant to be used for stationary computer workstations.
	TB-6024-DCH-W-DT	Diameter Tapered				\$ 1,365	* For all tables with casters legs, only 2 legs will have casters, and the other legs will have levelers. This will create a "wheelbarrow" style of table which will ensure ease of mobility.
	TB-6024-DCH-W-SR	Safari				\$ 1,370	* Color of the Caster Option must be specified at the time of order.
	with METAL Leg Option:	60"	24"	29"			* For the Flip OR Fold Leg option, one T base leg comes with 2 hidden casters as shown in the image below
	TB-6024-DCH-M-SQ	Square				\$ 1,015	
	TB-6024-DCH-M-SS	Square & Stem				\$ 1,445	
	TB-6024-DCH-M-D	Diameter				\$ 1,015	
	TB-6024-DCH-M-DS	Diameter & Stem				\$ 1,445	
	TB-6024-DCH-M-BO	Balloon				\$ 1,120	
	TB-6024-DCH-MC-SQ	Square with Casters				\$ 1,245	
	TB-6024-DCH-MC-SS	Square & Stem with Casters				\$ 1,665	
	TB-6024-DCH-MC-D	Diameter with Casters				\$ 1,245	
	TB-6024-DCH-MC-DS	Diameter & Stem with Casters				\$ 1,665	
	TB-6024-DCH-FL	Flip Leg (for Nesting Tables)				\$ 1,920	
	TB-6024-DCH-FD	Folding Leg				\$ 1,920	
	Rectangle Table, 60" Width, 30" Depth	60"	30"	29"			
	DROPPED CHAMFERED Edge;						
	with WOOD Leg Option:	60"	30"	29"			
	TB-6030-DCH-W-SQ	Square				\$ 1,210	
	TB-6030-DCH-W-SQR	Square Radius				\$ 1,210	
	TB-6030-DCH-W-SQT	Square Tapered				\$ 1,365	
	TB-6030-DCH-W-DT	Diameter Tapered				\$ 1,490	
	TB-6030-DCH-W-SR	Safari				\$ 1,500	
	with METAL Leg Option:	60"	30"	29"			
	TB-6030-DCH-M-SQ	Square				\$ 1,145	
	TB-6030-DCH-M-SS	Square & Stem				\$ 1,570	
	TB-6030-DCH-M-D	Diameter				\$ 1,145	
	TB-6030-DCH-M-DS	Diameter & Stem				\$ 1,570	
	TB-6030-DCH-M-BO	Balloon				\$ 1,250	
	TB-6030-DCH-MC-SQ	Square with Casters				\$ 1,370	
	TB-6030-DCH-MC-SS	Square & Stem with Casters				\$ 1,795	
	TB-6030-DCH-MC-D	Diameter with Casters				\$ 1,370	
	TB-6030-DCH-MC-DS	Diameter & Stem with Casters				\$ 1,795	
	TB-6030-DCH-FL	Flip Leg (for Nesting Tables)				\$ 2,150	
	TB-6030-DCH-FD	Folding Leg				\$ 2,150	

Edge Option:



Metal Leg Options:

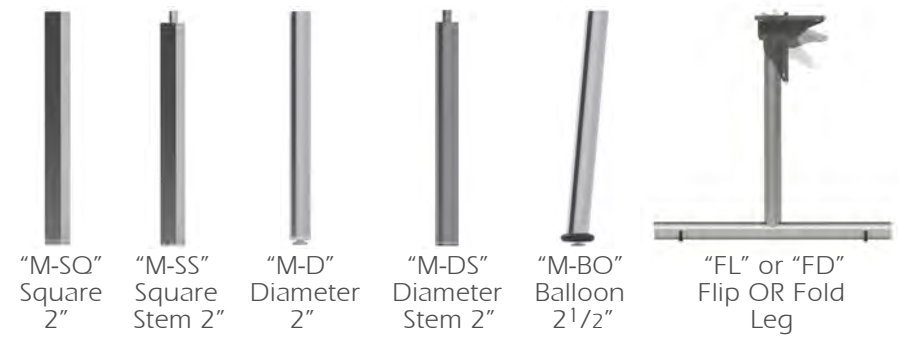

Wood Leg Options:



KREATIONS

MODEL NUMBER	PRODUCT	WIDTH	DEPTH	HEIGHT	PRICE	DESCRIPTION
	Rectangle Table, 60" Width, 36" Depth	60"	36"	29"		Each Table Top is constructed using a 1 1/8" thick top with a Plastic Laminate top surface.
	DROPPED CHAMFERED Edge;					All Metal legs are coated electrostatically with an epoxy powder coat paint.
*Shown Above: TB-6024-DCH-M-D	with WOOD Leg Option:	60"	36"	29"		NOTES: * Table heights of 25" (children), 27" (youth), and 32" (wheelchair) are available by request. * Color of Metal Paint must be specified at the time of order. * Caster Leg options are recommended for Reading/Multipurpose Tables options and not meant to be used for stationary computer workstations. * For all tables with casters legs, only 2 legs will have casters, and the other legs will have levelers. This will create a "wheelbarrow" style of table which will ensure ease of mobility. * Color of the Caster Option must be specified at the time of order. * For the Flip OR Fold Leg option, one T base leg comes with 2 hidden casters as shown in the image below
	TB-6036-DCH-W-SQ Square				\$ 1,260	
	TB-6036-DCH-W-SQR Square Radius				\$ 1,260	
	TB-6036-DCH-W-SQT Square Tapered				\$ 1,410	
	TB-6036-DCH-W-DT Diameter Tapered				\$ 1,540	
	TB-6036-DCH-W-SR Safari				\$ 1,550	
	with METAL Leg Option:	60"	36"	29"		
	TB-6036-DCH-M-SQ Square				\$ 1,195	
	TB-6036-DCH-M-SS Square & Stem				\$ 1,620	
	TB-6036-DCH-M-D Diameter				\$ 1,195	
	TB-6036-DCH-M-DS Diameter & Stem				\$ 1,620	
	TB-6036-DCH-M-BO Balloon				\$ 1,300	
	TB-6036-DCH-MC-SQ Square with Casters				\$ 1,425	
	TB-6036-DCH-MC-SS Square & Stem with Casters				\$ 1,845	
	TB-6036-DCH-MC-D Diameter with Casters				\$ 1,425	
	TB-6036-DCH-MC-DS Diameter & Stem with Casters				\$ 1,845	
	TB-6036-DCH-FL Flip Leg (for Nesting Tables)				\$ 2,050	
	TB-6036-DCH-FD Folding Leg				\$ 2,050	



*Rectangle Table Shape

Edge Option:



"DCH"
3/4" Dropped Chamfered Edge

Metal Leg Options:

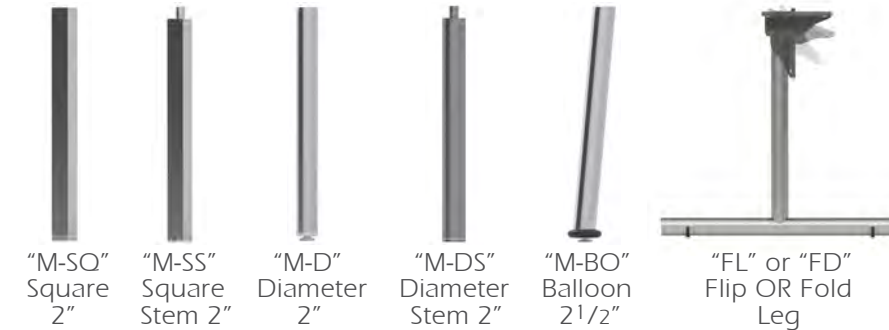

"M-SQ" Square 2"
"M-SS" Square Stem 2"
"M-D" Diameter 2"
"M-DS" Diameter Stem 2"
"M-BO" Balloon 2 1/2"
"FL" or "FD" Flip OR Fold Leg

Wood Leg Options:

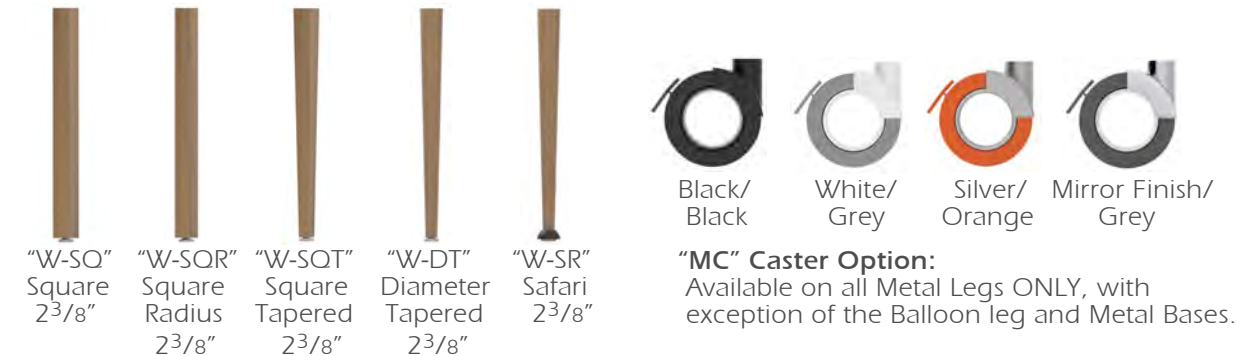



"W-SQ" Square 2 3/8"
"W-SQR" Square Radius 2 3/8"
"W-SQT" Square Tapered 2 3/8"
"W-DT" Diameter Tapered 2 3/8"
"W-SR" Safari 2 3/8"

Black/Black White/Grey Silver/Orange Mirror Finish/Grey

"MC" Caster Option:
Available on all Metal Legs ONLY, with exception of the Balloon leg and Metal Bases.

KREATIONS

MODEL NUMBER	PRODUCT	WIDTH	DEPTH	HEIGHT	PRICE	DESCRIPTION	
 <p>*Shown Above: TB-6024-AL-M-D</p>  <p>*Rectangle Table Shape</p>	Rectangle Table, 60" Width, 24" Depth	60"	24"	29"		Each Table Top is constructed using a 1 1/8" thick top with a Plastic Laminate top surface.	
		ALUMINUM Edge;					All Metal legs are coated electrostatically with an epoxy powder coat paint.
		with WOOD Leg Option:	60"	24"	29"		NOTES:
	TB-6024-DBN-W-SQ	Square				\$ 950	* Table heights of 25" (children), 27" (youth), and 32" (wheelchair) are available by request.
	TB-6024-DBN-W-SQR	Square Radius				\$ 950	* Color of Metal Paint must be specified at the time of order.
	TB-6024-DBN-W-SQT	Square Tapered				\$ 1,105	* Caster Leg options are recommended for Reading/Multipurpose Tables options and not meant to be used for stationary computer workstations.
	TB-6024-DBN-W-DT	Diameter Tapered				\$ 1,235	* For all tables with casters legs, only 2 legs will have casters, and the other legs will have levelers. This will create a "wheelbarrow" style of table which will ensure ease of mobility.
	TB-6024-DBN-W-SR	Safari				\$ 1,240	* Color of the Caster Option must be specified at the time of order.
		with METAL Leg Option:	60"	24"	29"		* For the Flip OR Fold Leg option, one T base leg comes with 2 hidden casters as shown in the image below
	TB-6024-DBN-M-SQ	Square				\$ 890	
	TB-6024-DBN-M-SS	Square & Stem				\$ 1,310	
	TB-6024-DBN-M-D	Diameter				\$ 890	
	TB-6024-DBN-M-DS	Diameter & Stem				\$ 1,310	
	TB-6024-DBN-M-BO	Balloon				\$ 990	
TB-6024-DBN-MC-SQ	Square with Casters				\$ 1,110		
TB-6024-DBN-MC-SS	Square & Stem with Casters				\$ 1,540		
TB-6024-DBN-MC-D	Diameter with Casters				\$ 1,110		
TB-6024-DBN-MC-DS	Diameter & Stem with Casters				\$ 1,540		
TB-6024-DBN-FL	Flip Leg (for Nesting Tables)				\$ 1,795		
TB-6024-DBN-FD	Folding Leg				\$ 1,795		
	Rectangle Table, 60" Width, 30" Depth	60"	30"	29"			
	ALUMINUM Edge;						
	with WOOD Leg Option:	60"	30"	29"			
TB-6030-DBN-W-SQ	Square				\$ 1,065		
TB-6030-DBN-W-SQR	Square Radius				\$ 1,065		
TB-6030-DBN-W-SQT	Square Tapered				\$ 1,220		
TB-6030-DBN-W-DT	Diameter Tapered				\$ 1,350		
TB-6030-DBN-W-SR	Safari				\$ 1,355		
	with METAL Leg Option:	60"	30"	29"			
TB-6030-DBN-M-SQ	Square				\$ 1,000		
TB-6030-DBN-M-SS	Square & Stem				\$ 1,425		
TB-6030-DBN-M-D	Diameter				\$ 1,000		
TB-6030-DBN-M-DS	Diameter & Stem				\$ 1,425		
TB-6030-DBN-M-BO	Balloon				\$ 1,425		
TB-6030-DBN-MC-SQ	Square with Casters				\$ 1,105		
TB-6030-DBN-MC-SS	Square & Stem with Casters				\$ 1,230		
TB-6030-DBN-MC-D	Diameter with Casters				\$ 1,650		
TB-6030-DBN-MC-DS	Diameter & Stem with Casters				\$ 1,230		
TB-6030-DBN-FL	Flip Leg (for Nesting Tables)				\$ 1,650		
TB-6030-DBN-FD	Folding Leg				\$ 1,855		

Edge Option:



3mm Aluminum Edge *All table corners will be given a 6-inch radius for this edge option.

Metal Leg Options:

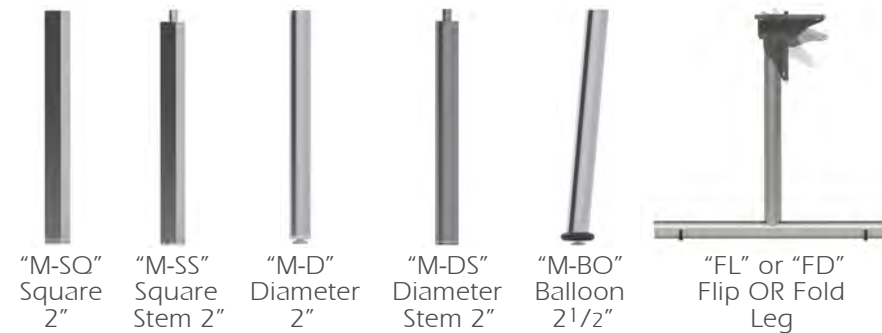

Wood Leg Options:

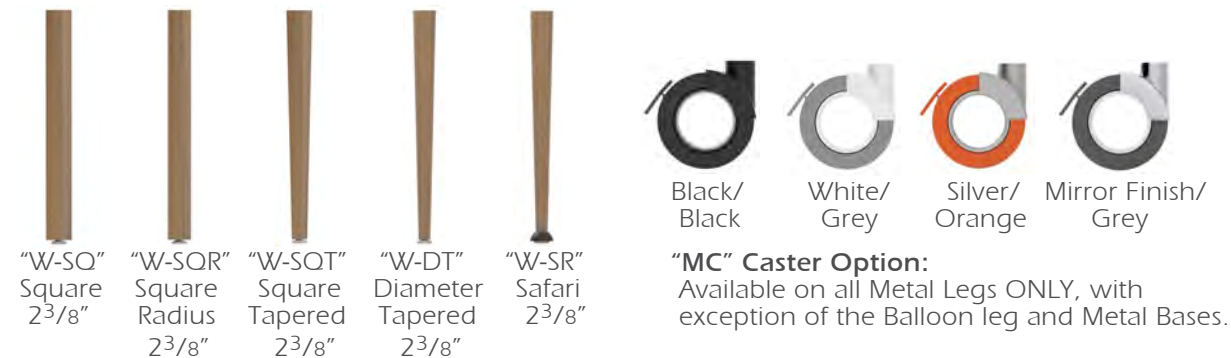

"MC" Caster Option:
Available on all Metal Legs ONLY, with exception of the Balloon leg and Metal Bases.

KREATIONS

MODEL NUMBER	PRODUCT	WIDTH	DEPTH	HEIGHT	PRICE	DESCRIPTION
	Rectangle Table, 60" Width, 36" Depth	60"	36"	29"		Each Table Top is constructed using a 1 1/8" thick top with a Plastic Laminate top surface.
	ALUMINUM Edge:					All Metal legs are coated electrostatically with an epoxy powder coat paint.
	with WOOD Leg Option:	60"	36"	29"		NOTES: * Table heights of 25" (children), 27" (youth), and 32" (wheelchair) are available by request. * Color of Metal Paint must be specified at the time of order. * Caster Leg options are recommended for Reading/Multipurpose Tables options and not meant to be used for stationary computer workstations. * For all tables with casters legs, only 2 legs will have casters, and the other legs will have levelers. This will create a "wheelbarrow" style of table which will ensure ease of mobility. * Color of the Caster Option must be specified at the time of order. * For the Flip OR Fold Leg option, one T base leg comes with 2 hidden casters as shown in the image below
*Shown Above: TB-6024-AL-M-D	TB-6036-DBN-W-SQ TB-6036-DBN-W-SQR TB-6036-DBN-W-SQT TB-6036-DBN-W-DT TB-6036-DBN-W-SR				\$ 1,110 \$ 1,110 \$ 1,260 \$ 1,390 \$ 1,395	
	with METAL Leg Option:	60"	36"	29"		
*Rectangle Table Shape	TB-6036-DBN-M-SQ TB-6036-DBN-M-SS TB-6036-DBN-M-D TB-6036-DBN-M-DS TB-6036-DBN-M-BO TB-6036-DBN-MC-SQ TB-6036-DBN-MC-SS TB-6036-DBN-MC-D TB-6036-DBN-MC-DS TB-6036-DBN-FL TB-6036-DBN-FD				\$ 1,045 \$ 1,470 \$ 1,045 \$ 1,470 \$ 1,145 \$ 1,270 \$ 1,695 \$ 1,270 \$ 1,695 \$ 1,900 \$ 1,900	

Edge Option:



3mm Aluminum Edge *All table corners will be given a 6-inch radius for this edge option.

Metal Leg Options:

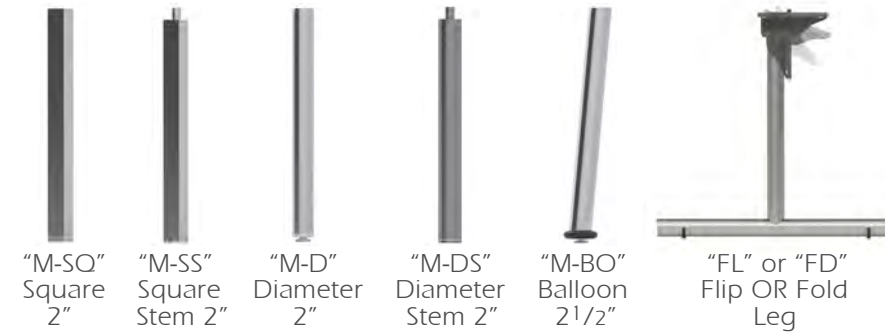

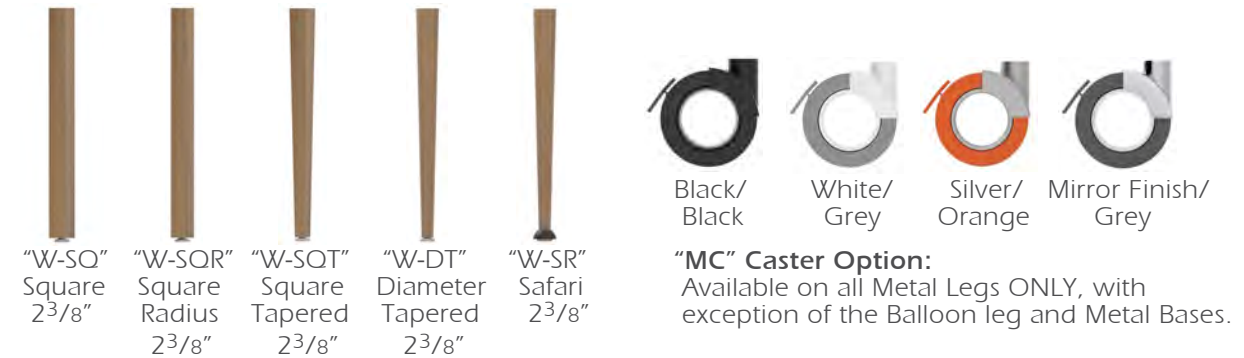

Wood Leg Options:



"MC" Caster Option:
Available on all Metal Legs ONLY, with exception of the Balloon leg and Metal Bases.

KREATIONS

MODEL NUMBER	PRODUCT	WIDTH	DEPTH	HEIGHT	PRICE	DESCRIPTION	
 <p>*Shown Above: TB-7224-AC-M-D</p>  <p>*Rectangle Table Shape</p>	Rectangle Table, 72" Width, 24" Depth	72"	24"	29"		Each Table Top is constructed using a 1" thick top with a Plastic Laminate top surface.	
		ACRYLIC Edge;					All Metal legs are coated electrostatically with an epoxy powder coat paint.
		with WOOD Leg Option:	72"	24"	29"		NOTES: * Table heights of 25" (children), 27" (youth), and 32" (wheelchair) are available by request. * Color of Metal Paint must be specified at the time of order. * Caster Leg options are recommended for Reading/Multipurpose Tables options and not meant to be used for stationary computer workstations. * For all tables with casters legs, only 2 legs will have casters, and the other legs will have levelers. This will create a "wheelbarrow" style of table which will ensure ease of mobility. * Color of the Caster Option must be specified at the time of order. * For the Flip OR Fold Leg option, one T base leg comes with 2 hidden casters as shown in the image below.
	TB-7224-AC-W-SQ	Square				\$ 980	
	TB-7224-AC-W-SQR	Square Radius				\$ 980	
	TB-7224-AC-W-SQT	Square Tapered				\$ 1,130	
	TB-7224-AC-W-DT	Diameter Tapered				\$ 1,260	
	TB-7224-AC-W-SR	Safari				\$ 1,265	
		with METAL Leg Option:	72"	24"	29"		
	TB-7224-AC-M-SQ	Square				\$ 915	
	TB-7224-AC-M-SS	Square & Stem				\$ 1,335	
	TB-7224-AC-M-D	Diameter				\$ 915	
	TB-7224-AC-M-DS	Diameter & Stem				\$ 1,335	
	TB-7224-AC-M-BO	Balloon				\$ 1,015	
	TB-7224-AC-MC-SQ	Square with Casters				\$ 1,140	
	TB-7224-AC-MC-SS	Square & Stem with Casters				\$ 1,565	
	TB-7224-AC-MC-D	Diameter with Casters				\$ 1,140	
TB-7224-AC-MC-DS	Diameter & Stem with Casters				\$ 1,565		
TB-7224-AC-FL	Flip Leg (for Nesting Tables)				\$ 1,755		
TB-7224-AC-FD	Folding Leg				\$ 1,755		
	Rectangle Table, 72" Width, 30" Depth	72"	30"	29"			
	ACRYLIC Edge;						
	with WOOD Leg Option:	72"	30"	29"			
TB-7230-AC-W-SQ	Square				\$ 1,020		
TB-7230-AC-W-SQR	Square Radius				\$ 1,020		
TB-7230-AC-W-SQT	Square Tapered				\$ 1,180		
TB-7230-AC-W-DT	Diameter Tapered				\$ 1,300		
TB-7230-AC-W-SR	Safari				\$ 1,305		
	with METAL Leg Option:	72"	30"	29"			
TB-7230-AC-M-SQ	Square				\$ 955		
TB-7230-AC-M-SS	Square & Stem				\$ 1,380		
TB-7230-AC-M-D	Diameter				\$ 955		
TB-7230-AC-M-DS	Diameter & Stem				\$ 1,380		
TB-7230-AC-M-BO	Balloon				\$ 1,060		
TB-7230-AC-MC-SQ	Square with Casters				\$ 1,180		
TB-7230-AC-MC-SS	Square & Stem with Casters				\$ 1,605		
TB-7230-AC-MC-D	Diameter with Casters				\$ 1,180		
TB-7230-AC-MC-DS	Diameter & Stem with Casters				\$ 1,605		
TB-7230-AC-FL	Flip Leg (for Nesting Tables)				\$ 1,805		
TB-7230-AC-FD	Folding Leg				\$ 1,805		

Edge Option:

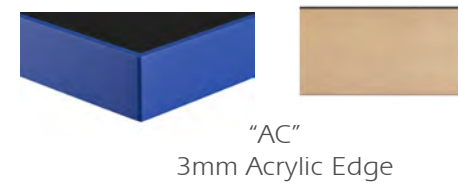

Metal Leg Options:

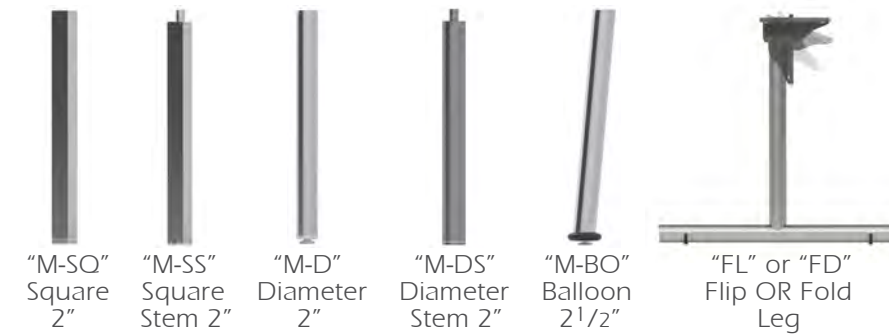

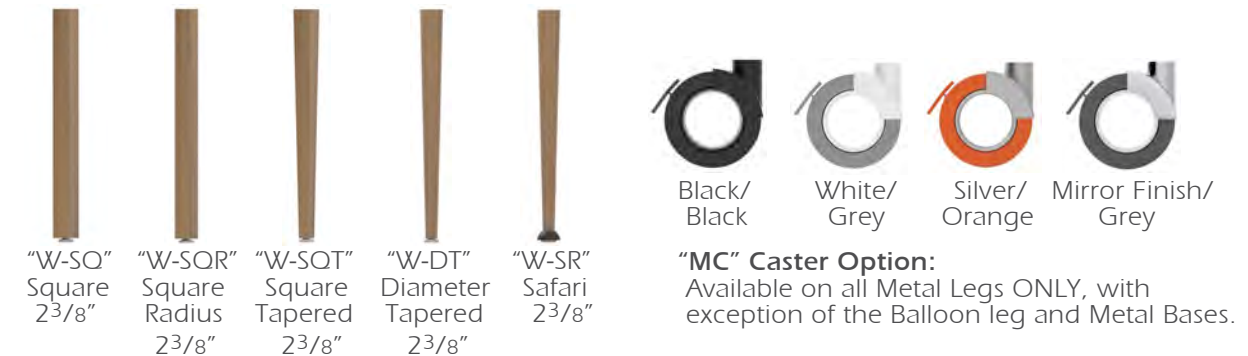

Wood Leg Options:



"MC" Caster Option:
Available on all Metal Legs ONLY, with exception of the Balloon leg and Metal Bases.

KREATIONS

MODEL NUMBER	PRODUCT	WIDTH	DEPTH	HEIGHT	PRICE	DESCRIPTION	
 <p>*Shown Above: TB-7224-AC-M-D</p>  <p>*Rectangle Table Shape</p>	Rectangle Table, 72" Width, 36" Depth	72"	36"	29"		Each Table Top is constructed using a 1" thick top with a Plastic Laminate top surface.	
		ACRYLIC Edge;					All Metal legs are coated electrostatically with an epoxy powder coat paint.
		with WOOD Leg Option:	72"	36"	29"		NOTES:
	TB-7236-AC-W-SQ	Square				\$ 1,065	* Table heights of 25" (children), 27" (youth), and 32" (wheelchair) are available by request.
	TB-7236-AC-W-SQR	Square Radius				\$ 1,065	* Color of Metal Paint must be specified at the time of order.
	TB-7236-AC-W-SQT	Square Tapered				\$ 1,215	* Caster Leg options are recommended for Reading/Multipurpose Tables options and not meant to be used for stationary computer workstations.
	TB-7236-AC-W-DT	Diameter Tapered				\$ 1,345	* For all tables with casters legs, only 2 legs will have casters, and the other legs will have levelers. This will create a "wheelbarrow" style of table which will ensure ease of mobility.
	TB-7236-AC-W-SR	Safari				\$ 1,350	* Color of the Caster Option must be specified at the time of order.
		with METAL Leg Option:	72"	36"	29"		* For the Flip OR Fold Leg option, one T base leg comes with 2 hidden casters as shown in the image below.
	TB-7236-AC-M-SQ	Square				\$ 1,000	
	TB-7236-AC-M-SS	Square & Stem				\$ 1,420	
	TB-7236-AC-M-D	Diameter				\$ 1,000	
	TB-7236-AC-M-DS	Diameter & Stem				\$ 1,420	
	TB-7236-AC-M-BO	Balloon				\$ 1,100	
	TB-7236-AC-MC-SQ	Square with Casters				\$ 1,220	
	TB-7236-AC-MC-SS	Square & Stem with Casters				\$ 1,650	
	TB-7236-AC-MC-D	Diameter with Casters				\$ 1,220	
TB-7236-AC-MC-DS	Diameter & Stem with Casters				\$ 1,650		
TB-7236-AC-FL	Flip Leg (for Nesting Tables)				\$ 1,855		
TB-7236-AC-FD	Folding Leg				\$ 1,855		
	Rectangle Table, 72" Width, 42" Depth	72"	42"	29"			
	ACRYLIC Edge;						
	with WOOD Leg Option:	72"	42"	29"			
TB-7242-AC-W-SQ	Square				\$ 1,105		
TB-7242-AC-W-SQR	Square Radius				\$ 1,105		
TB-7242-AC-W-SQT	Square Tapered				\$ 1,140		
TB-7242-AC-W-DT	Diameter Tapered				\$ 1,385		
TB-7242-AC-W-SR	Safari				\$ 1,390		
	with METAL Leg Option:	72"	42"	29"			
TB-7242-AC-M-SQ	Square				\$ 1,040		
TB-7242-AC-M-SS	Square & Stem				\$ 1,460		
TB-7242-AC-M-D	Diameter				\$ 1,040		
TB-7242-AC-M-DS	Diameter & Stem				\$ 1,460		
TB-7242-AC-M-BO	Balloon				\$ 1,140		
TB-7242-AC-MC-SQ	Square with Casters				\$ 1,265		
TB-7242-AC-MC-SS	Square & Stem with Casters				\$ 1,690		
TB-7242-AC-MC-D	Diameter with Casters				\$ 1,265		
TB-7242-AC-MC-DS	Diameter & Stem with Casters				\$ 1,690		
TB-7242-AC-FL	Flip Leg (for Nesting Tables)				\$ 1,925		
TB-7242-AC-FD	Folding Leg				\$ 1,925		

Edge Option:

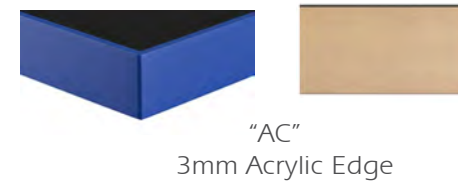



Metal Leg Options:

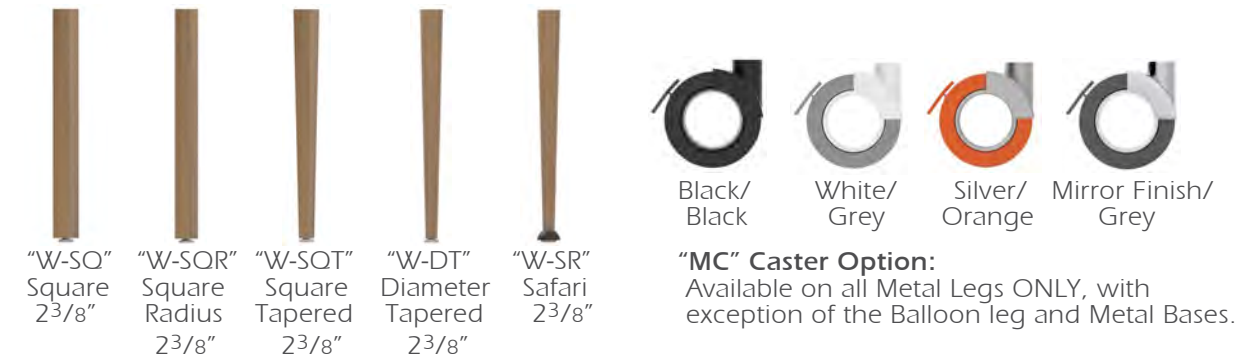

Wood Leg Options:



KREATIONS

MODEL NUMBER	PRODUCT	WIDTH	DEPTH	HEIGHT	PRICE	DESCRIPTION
 <p>*Shown Above: TB-7224-SQ-M-D</p>  <p>*Rectangle Table Shape</p>	Rectangle Table, 72" Width, 24" Depth	72"	24"	29"		Each Table Top is constructed using a 1 1/8" thick top with a Plastic Laminate top surface.
	SQUARE Edge;					All Metal legs are coated electrostatically with an epoxy powder coat paint.
	with WOOD Leg Option:	72"	24"	29"		NOTES:
	TB-7224-SQ-W-SQ Square				\$ 1,130	* Table heights of 25" (children), 27" (youth), and 32" (wheelchair) are available by request.
	TB-7224-SQ-W-SQR Square Radius				\$ 1,130	* Color of Metal Paint must be specified at the time of order.
	TB-7224-SQ-W-SQT Square Tapered				\$ 1,285	* Caster Leg options are recommended for Reading/Multipurpose Tables options and not meant to be used for stationary computer workstations.
	TB-7224-SQ-W-DT Diameter Tapered				\$ 1,410	* For all tables with casters legs, only 2 legs will have casters, and the other legs will have levelers. This will create a "wheelbarrow" style of table which will ensure ease of mobility.
	TB-7224-SQ-W-SR Safari				\$ 1,415	* Color of the Caster Option must be specified at the time of order.
	with METAL Leg Option:	72"	24"	29"		* For the Flip OR Fold Leg option, one T base leg comes with 2 hidden casters as shown in the image below.
	TB-7224-SQ-M-SQ Square				\$ 1,065	
TB-7224-SQ-M-SS Square & Stem				\$ 1,490		
TB-7224-SQ-M-D Diameter				\$ 1,065		
TB-7224-SQ-M-DS Diameter & Stem				\$ 1,490		
TB-7224-SQ-M-BO Balloon				\$ 1,170		
TB-7224-SQ-MC-SQ Square with Casters				\$ 1,290		
TB-7224-SQ-MC-SS Square & Stem with Casters				\$ 1,715		
TB-7224-SQ-MC-D Diameter with Casters				\$ 1,290		
TB-7224-SQ-MC-DS Diameter & Stem with Casters				\$ 1,715		
TB-7224-SQ-FL Flip Leg (for Nesting Tables)				\$ 1,905		
TB-7224-SQ-FD Folding Leg				\$ 1,905		
	Rectangle Table, 72" Width, 30" Depth	72"	30"	29"		
	SQUARE Edge;					
	with WOOD Leg Option:	72"	30"	29"		
TB-7230-SQ-W-SQ Square					\$ 1,180	
TB-7230-SQ-W-SQR Square Radius					\$ 1,180	
TB-7230-SQ-W-SQT Square Tapered					\$ 1,330	
TB-7230-SQ-W-DT Diameter Tapered					\$ 1,460	
TB-7230-SQ-W-SR Safari					\$ 1,470	
	with METAL Leg Option:	72"	30"	29"		
TB-7230-SQ-M-SQ Square					\$ 1,115	
TB-7230-SQ-M-SS Square & Stem					\$ 1,540	
TB-7230-SQ-M-D Diameter					\$ 1,115	
TB-7230-SQ-M-DS Diameter & Stem					\$ 1,540	
TB-7230-SQ-M-BO Balloon					\$ 1,220	
TB-7230-SQ-MC-SQ Square with Casters					\$ 1,345	
TB-7230-SQ-MC-SS Square & Stem with Casters					\$ 1,765	
TB-7230-SQ-MC-D Diameter with Casters					\$ 1,345	
TB-7230-SQ-MC-DS Diameter & Stem with Casters					\$ 1,765	
TB-7230-SQ-FL Flip Leg (for Nesting Tables)					\$ 1,970	
TB-7230-SQ-FD Folding Leg					\$ 1,970	

Edge Option:



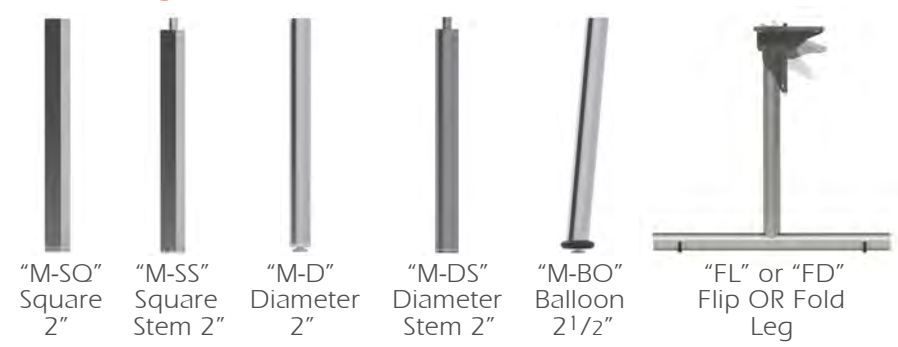

Metal Leg Options:



Wood Leg Options:



KREATIONS

MODEL NUMBER	PRODUCT	WIDTH	DEPTH	HEIGHT	PRICE	DESCRIPTION	
 <p>*Shown Above: TB-7224-SQ-M-D</p>  <p>*Rectangle Table Shape</p>	Rectangle Table, 72" Width, 36" Depth	72"	36"	29"		Each Table Top is constructed using a 1 1/8" thick top with a Plastic Laminate top surface.	
		SQUARE Edge;					All Metal legs are coated electrostatically with an epoxy powder coat paint.
		with WOOD Leg Option:	72"	36"	29"		NOTES:
	TB-7236-SQ-W-SQ	Square				\$ 1,235	* Table heights of 25" (children), 27" (youth), and 32" (wheelchair) are available by request.
	TB-7236-SQ-W-SQR	Square Radius				\$ 1,235	* Color of Metal Paint must be specified at the time of order.
	TB-7236-SQ-W-SQT	Square Tapered				\$ 1,385	* Caster Leg options are recommended for Reading/Multipurpose Tables options and not meant to be used for stationary computer workstations.
	TB-7236-SQ-W-DT	Diameter Tapered				\$ 1,515	* For all tables with casters legs, only 2 legs will have casters, and the other legs will have levelers. This will create a "wheelbarrow" style of table which will ensure ease of mobility.
	TB-7236-SQ-W-SR	Safari				\$ 1,520	* Color of the Caster Option must be specified at the time of order.
		with METAL Leg Option:	72"	36"	29"		* For the Flip OR Fold Leg option, one T base leg comes with 2 hidden casters as shown in the image below.
	TB-7236-SQ-M-SQ	Square				\$ 1,170	
	TB-7236-SQ-M-SS	Square & Stem				\$ 1,590	
	TB-7236-SQ-M-D	Diameter				\$ 1,170	
	TB-7236-SQ-M-DS	Diameter & Stem				\$ 1,590	
	TB-7236-SQ-M-BO	Balloon				\$ 1,270	
	TB-7236-SQ-MC-SQ	Square with Casters				\$ 1,395	
	TB-7236-SQ-MC-SS	Square & Stem with Casters				\$ 1,820	
	TB-7236-SQ-MC-D	Diameter with Casters				\$ 1,395	
TB-7236-SQ-MC-DS	Diameter & Stem with Casters				\$ 1,820		
TB-7236-SQ-FL	Flip Leg (for Nesting Tables)				\$ 2,030		
TB-7236-SQ-FD	Folding Leg				\$ 2,030		
	Rectangle Table, 72" Width, 42" Depth	72"	42"	29"			
	SQUARE Edge;						
	with WOOD Leg Option:	72"	42"	29"			
TB-7242-SQ-W-SQ	Square				\$ 1,285		
TB-7242-SQ-W-SQR	Square Radius				\$ 1,285		
TB-7242-SQ-W-SQT	Square Tapered				\$ 1,435		
TB-7242-SQ-W-DT	Diameter Tapered				\$ 1,565		
TB-7242-SQ-W-SR	Safari				\$ 1,570		
	with METAL Leg Option:	72"	42"	29"			
TB-7242-SQ-M-SQ	Square				\$ 1,220		
TB-7242-SQ-M-SS	Square & Stem				\$ 1,645		
TB-7242-SQ-M-D	Diameter				\$ 1,220		
TB-7242-SQ-M-DS	Diameter & Stem				\$ 1,645		
TB-7242-SQ-M-BO	Balloon				\$ 1,320		
TB-7242-SQ-MC-SQ	Square with Casters				\$ 1,445		
TB-7242-SQ-MC-SS	Square & Stem with Casters				\$ 1,870		
TB-7242-SQ-MC-D	Diameter with Casters				\$ 1,445		
TB-7242-SQ-MC-DS	Diameter & Stem with Casters				\$ 1,870		
TB-7242-SQ-FL	Flip Leg (for Nesting Tables)				\$ 2,105		
TB-7242-SQ-FD	Folding Leg				\$ 2,105		

Edge Option:



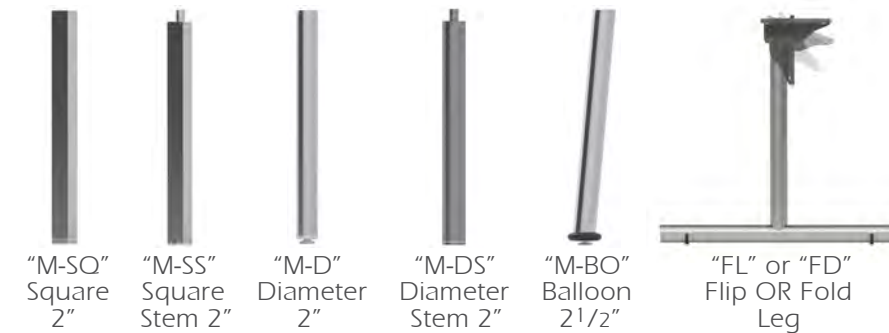

Metal Leg Options:

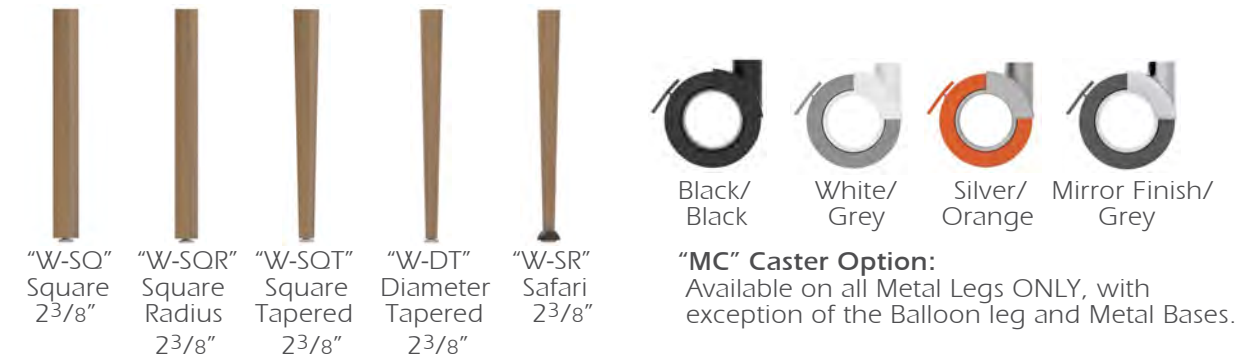

Wood Leg Options:



KREATIONS

MODEL NUMBER	PRODUCT	WIDTH	DEPTH	HEIGHT	PRICE	DESCRIPTION
 *Shown Above: TB-7224-DSQ-M-D	Rectangle Table, 72" Width, 24" Depth	72"	24"	29"		Each Table Top is constructed using a 1 1/8" thick top with a Plastic Laminate top surface.
	DROPPED SQUARE Edge;					All Metal legs are coated electrostatically with an epoxy powder coat paint.
 *Rectangle Table Shape	with WOOD Leg Option:	72"	24"	29"		NOTES: * Table heights of 25" (children), 27" (youth), and 32" (wheelchair) are available by request. * Color of Metal Paint must be specified at the time of order. * Caster Leg options are recommended for Reading/Multipurpose Tables options and not meant to be used for stationary computer workstations. * For all tables with casters legs, only 2 legs will have casters, and the other legs will have levelers. This will create a "wheelbarrow" style of table which will ensure ease of mobility. * Color of the Caster Option must be specified at the time of order. * For the Flip OR Fold Leg option, one T base leg comes with 2 hidden casters as shown in the image below
	TB-7224-DSQ-W-SQ	Square			\$ 1,210	
	TB-7224-DSQ-W-SQR	Square Radius			\$ 1,210	
	TB-7224-DSQ-W-SQT	Square Tapered			\$ 1,365	
	TB-7224-DSQ-W-DT	Diameter Tapered			\$ 1,490	
	TB-7224-DSQ-W-SR	Safari			\$ 1,495	
	with METAL Leg Option:	72"	24"	29"		
	TB-7224-DSQ-M-SQ	Square			\$ 1,145	
	TB-7224-DSQ-M-SS	Square & Stem			\$ 1,570	
	TB-7224-DSQ-M-D	Diameter			\$ 1,145	
	TB-7224-DSQ-M-DS	Diameter & Stem			\$ 1,570	
	TB-7224-DSQ-M-BO	Balloon			\$ 1,455	
	TB-7224-DSQ-MC-SQ	Square with Casters			\$ 1,370	
	TB-7224-DSQ-MC-SS	Square & Stem with Casters			\$ 1,795	
	TB-7224-DSQ-MC-D	Diameter with Casters			\$ 1,370	
	TB-7224-DSQ-MC-DS	Diameter & Stem with Casters			\$ 1,795	
	TB-7224-DSQ-FL	Flip Leg (for Nesting Tables)			\$ 1,985	
TB-7224-DSQ-FD	Folding Leg			\$ 1,985		
	Rectangle Table, 72" Width, 30" Depth	72"	30"	29"		
	DROPPED SQUARE Edge;					
	with WOOD Leg Option:	72"	30"	29"		
TB-7230-DSQ-W-SQ	Square			\$ 1,270		
TB-7230-DSQ-W-SQR	Square Radius			\$ 1,270		
TB-7230-DSQ-W-SQT	Square Tapered			\$ 1,420		
TB-7230-DSQ-W-DT	Diameter Tapered			\$ 1,550		
TB-7230-DSQ-W-SR	Safari			\$ 1,555		
	with METAL Leg Option:	72"	30"	29"		
TB-7230-DSQ-M-SQ	Square			\$ 1,205		
TB-7230-DSQ-M-SS	Square & Stem			\$ 1,625		
TB-7230-DSQ-M-D	Diameter			\$ 1,205		
TB-7230-DSQ-M-DS	Diameter & Stem			\$ 1,625		
TB-7230-DSQ-M-BO	Balloon			\$ 1,305		
TB-7230-DSQ-MC-SQ	Square with Casters			\$ 1,425		
TB-7230-DSQ-MC-SS	Square & Stem with Casters			\$ 1,855		
TB-7230-DSQ-MC-D	Diameter with Casters			\$ 1,425		
TB-7230-DSQ-MC-DS	Diameter & Stem with Casters			\$ 1,855		
TB-7230-DSQ-FL	Flip Leg (for Nesting Tables)			\$ 2,055		
TB-7230-DSQ-FD	Folding Leg			\$ 2,055		

Edge Option:



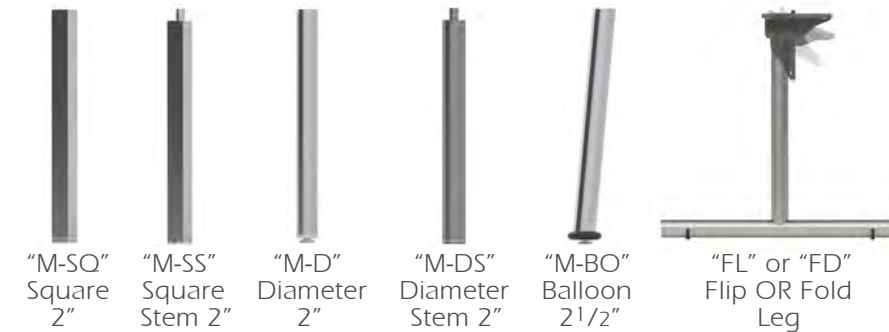

Metal Leg Options:

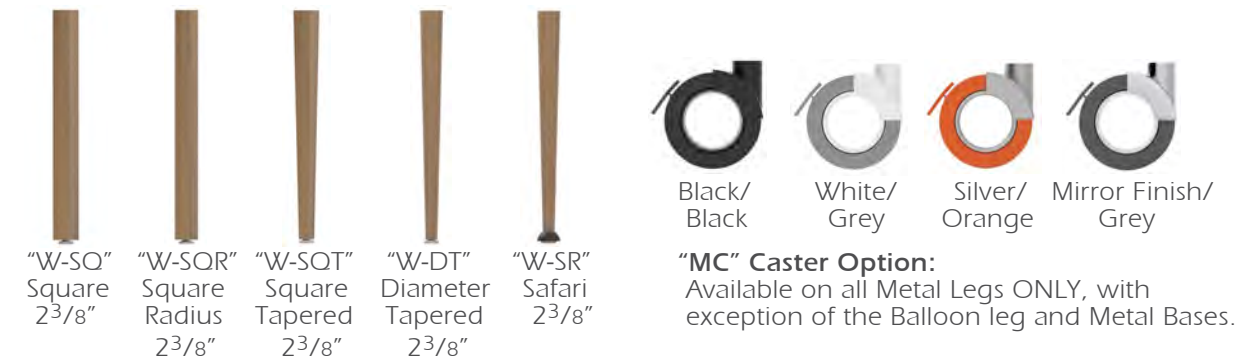

Wood Leg Options:



KREATIONS

MODEL NUMBER	PRODUCT	WIDTH	DEPTH	HEIGHT	PRICE	DESCRIPTION	
 <p>*Shown Above: TB-7224-DSQ-M-D</p>  <p>*Rectangle Table Shape</p>	Rectangle Table, 72" Width, 36" Depth	72"	36"	29"		Each Table Top is constructed using a 1 1/8" thick top with a Plastic Laminate top surface.	
		DROPPED SQUARE Edge;					All Metal legs are coated electrostatically with an epoxy powder coat paint.
		with WOOD Leg Option:	72"	36"	29"		NOTES:
	TB-7236-DSQ-W-SQ	Square				\$ 1,325	* Table heights of 25" (children), 27" (youth), and 32" (wheelchair) are available by request.
	TB-7236-DSQ-W-SQR	Square Radius				\$ 1,325	* Color of Metal Paint must be specified at the time of order.
	TB-7236-DSQ-W-SQT	Square Tapered				\$ 1,475	* Caster Leg options are recommended for Reading/Multipurpose Tables options and not meant to be used for stationary computer workstations.
	TB-7236-DSQ-W-DT	Diameter Tapered				\$ 1,605	* For all tables with casters legs, only 2 legs will have casters, and the other legs will have levelers. This will create a "wheelbarrow" style of table which will ensure ease of mobility.
	TB-7236-DSQ-W-SR	Safari				\$ 1,610	* Color of the Caster Option must be specified at the time of order.
		with METAL Leg Option:	72"	36"	29"		* For the Flip OR Fold Leg option, one T base leg comes with 2 hidden casters as shown in the image below
	TB-7236-DSQ-M-SQ	Square				\$ 1,260	
	TB-7236-DSQ-M-SS	Square & Stem				\$ 1,680	
	TB-7236-DSQ-M-D	Diameter				\$ 1,260	
	TB-7236-DSQ-M-DS	Diameter & Stem				\$ 1,680	
	TB-7236-DSQ-M-BO	Balloon				\$ 1,365	
	TB-7236-DSQ-MC-SQ	Square with Casters				\$ 1,485	
	TB-7236-DSQ-MC-SS	Square & Stem with Casters				\$ 1,910	
	TB-7236-DSQ-MC-D	Diameter with Casters				\$ 1,485	
TB-7236-DSQ-MC-DS	Diameter & Stem with Casters				\$ 1,910		
TB-7236-DSQ-FL	Flip Leg (for Nesting Tables)				\$ 2,120		
TB-7236-DSQ-FD	Folding Leg				\$ 2,120		
	Rectangle Table, 72" Width, 42" Depth	72"	42"	29"			
	DROPPED SQUARE Edge;						
	with WOOD Leg Option:	72"	42"	29"			
TB-7242-DSQ-W-SQ	Square				\$ 1,380		
TB-7242-DSQ-W-SQR	Square Radius				\$ 1,380		
TB-7242-DSQ-W-SQT	Square Tapered				\$ 1,535		
TB-7242-DSQ-W-DT	Diameter Tapered				\$ 1,665		
TB-7242-DSQ-W-SR	Safari				\$ 1,670		
	with METAL Leg Option:	72"	42"	29"			
TB-7242-DSQ-M-SQ	Square				\$ 1,315		
TB-7242-DSQ-M-SS	Square & Stem				\$ 1,740		
TB-7242-DSQ-M-D	Diameter				\$ 1,315		
TB-7242-DSQ-M-DS	Diameter & Stem				\$ 1,740		
TB-7242-DSQ-M-BO	Balloon				\$ 1,420		
TB-7242-DSQ-MC-SQ	Square with Casters				\$ 1,540		
TB-7242-DSQ-MC-SS	Square & Stem with Casters				\$ 1,965		
TB-7242-DSQ-MC-D	Diameter with Casters				\$ 1,540		
TB-7242-DSQ-MC-DS	Diameter & Stem with Casters				\$ 1,965		
TB-7242-DSQ-FL	Flip Leg (for Nesting Tables)				\$ 2,205		
TB-7242-DSQ-FD	Folding Leg				\$ 2,205		

Edge Option:



Metal Leg Options:

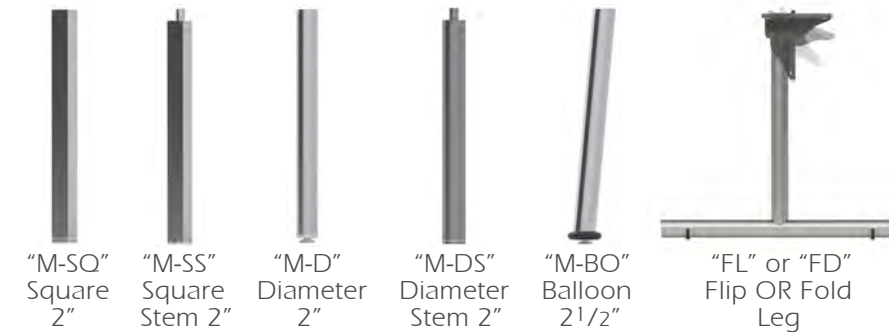

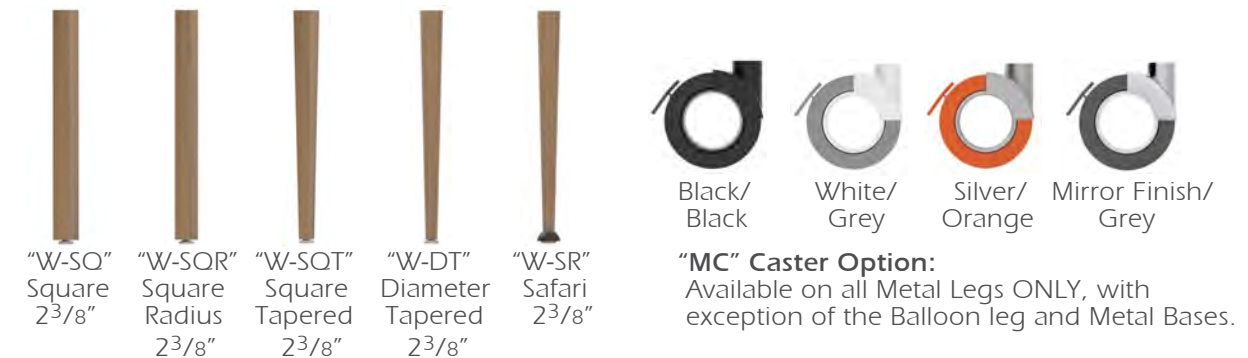

Wood Leg Options:



"MC" Caster Option:
Available on all Metal Legs ONLY, with exception of the Balloon leg and Metal Bases.

KREATIONS

MODEL NUMBER	PRODUCT	WIDTH	DEPTH	HEIGHT	PRICE	DESCRIPTION	
 <p>*Shown Above: TB-7224-DBN-M-D</p>  <p>*Rectangle Table Shape</p>	Rectangle Table, 72" Width, 24" Depth	72"	24"	29"		Each Table Top is constructed using a 1 1/8" thick top with a Plastic Laminate top surface.	
	DROPPED BULLNOSE Edge;					All Metal legs are coated electrostatically with an epoxy powder coat paint.	
	with WOOD Leg Option:					NOTES:	
	TB-7224-DBN-W-SQ	Square	72"	24"	29"	\$ 1,220	* Table heights of 25" (children), 27" (youth), and 32" (wheelchair) are available by request.
	TB-7224-DBN-W-SQR	Square Radius				\$ 1,220	* Color of Metal Paint must be specified at the time of order.
	TB-7224-DBN-W-SQT	Square Tapered				\$ 1,375	* Caster Leg options are recommended for Reading/Multipurpose Tables options and not meant to be used for stationary computer workstations.
	TB-7224-DBN-W-DT	Diameter Tapered				\$ 1,505	* For all tables with casters legs, only 2 legs will have casters, and the other legs will have levelers. This will create a "wheelbarrow" style of table which will ensure ease of mobility.
	TB-7224-DBN-W-SR	Safari				\$ 1,510	* Color of the Caster Option must be specified at the time of order.
	with METAL Leg Option:						* For the Flip OR Fold Leg option, one T base leg comes with 2 hidden casters as shown in the image below
	TB-7224-DBN-M-SQ	Square	72"	24"	29"	\$ 1,160	
	TB-7224-DBN-M-SS	Square & Stem				\$ 1,580	
	TB-7224-DBN-M-D	Diameter				\$ 1,160	
	TB-7224-DBN-M-DS	Diameter & Stem				\$ 1,580	
	TB-7224-DBN-M-BO	Balloon				\$ 1,260	
	TB-7224-DBN-MC-SQ	Square with Casters				\$ 1,380	
	TB-7224-DBN-MC-SS	Square & Stem with Casters				\$ 1,805	
	TB-7224-DBN-MC-D	Diameter with Casters				\$ 1,380	
	TB-7224-DBN-MC-DS	Diameter & Stem with Casters				\$ 1,805	
	TB-7224-DBN-FL	Flip Leg (for Nesting Tables)				\$ 1,995	
	TB-7224-DBN-FD	Folding Leg				\$ 1,995	
	Rectangle Table, 72" Width, 30" Depth	72"	30"	29"			
	DROPPED BULLNOSE Edge;						
	with WOOD Leg Option:						
TB-7230-DBN-W-SQ	Square	72"	30"	29"	\$ 1,280		
TB-7230-DBN-W-SQR	Square Radius				\$ 1,280		
TB-7230-DBN-W-SQT	Square Tapered				\$ 1,430		
TB-7230-DBN-W-DT	Diameter Tapered				\$ 1,560		
TB-7230-DBN-W-SR	Safari				\$ 1,565		
	with METAL Leg Option:						
TB-7230-DBN-M-SQ	Square	72"	30"	29"	\$ 1,215		
TB-7230-DBN-M-SS	Square & Stem				\$ 1,635		
TB-7230-DBN-M-D	Diameter				\$ 1,215		
TB-7230-DBN-M-DS	Diameter & Stem				\$ 1,635		
TB-7230-DBN-M-BO	Balloon				\$ 1,315		
TB-7230-DBN-MC-SQ	Square with Casters				\$ 1,440		
TB-7230-DBN-MC-SS	Square & Stem with Casters				\$ 1,865		
TB-7230-DBN-MC-D	Diameter with Casters				\$ 1,440		
TB-7230-DBN-MC-DS	Diameter & Stem with Casters				\$ 1,865		
TB-7230-DBN-FL	Flip Leg (for Nesting Tables)				\$ 2,065		
TB-7230-DBN-FD	Folding Leg				\$ 2,065		

Edge Option:

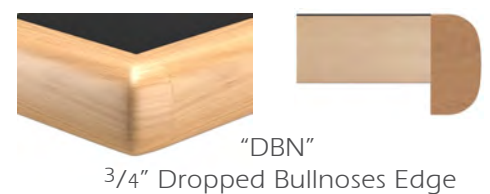



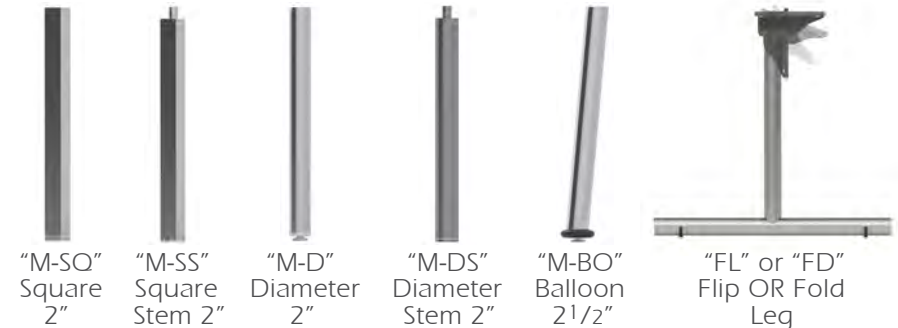



Metal Leg Options:









Wood Leg Options:





KREATIONS

MODEL NUMBER	PRODUCT	WIDTH	DEPTH	HEIGHT	PRICE	DESCRIPTION	
 <p>*Shown Above: TB-7224-DBN-M-D</p>  <p>*Rectangle Table Shape</p>	Rectangle Table, 72" Width, 36" Depth DROPPED BULLNOSE Edge; with WOOD Leg Option:	72"	36"	29"		Each Table Top is constructed using a 1 1/8" thick top with a Plastic Laminate top surface. All Metal legs are coated electrostatically with an epoxy powder coat paint. NOTES: * Table heights of 25" (children), 27" (youth), and 32" (wheelchair) are available by request. * Color of Metal Paint must be specified at the time of order. * Caster Leg options are recommended for Reading/Multipurpose Tables options and not meant to be used for stationary computer workstations. * For all tables with casters legs, only 2 legs will have casters, and the other legs will have levelers. This will create a "wheelbarrow" style of table which will ensure ease of mobility. * Color of the Caster Option must be specified at the time of order. * For the Flip OR Fold Leg option, one T base leg comes with 2 hidden casters as shown in the image below	
	TB-7236-DBN-W-SQ	Square	72"	36"	29"		\$ 1,335
	TB-7236-DBN-W-SQR	Square Radius					\$ 1,335
	TB-7236-DBN-W-SQT	Square Tapered					\$ 1,490
	TB-7236-DBN-W-DT	Diameter Tapered					\$ 1,615
	TB-7236-DBN-W-SR	Safari					\$ 1,620
	with METAL Leg Option:		72"	36"	29"		
	TB-7236-DBN-M-SQ	Square					\$ 1,270
	TB-7236-DBN-M-SS	Square & Stem					\$ 1,695
	TB-7236-DBN-M-D	Diameter					\$ 1,270
	TB-7236-DBN-M-DS	Diameter & Stem					\$ 1,695
	TB-7236-DBN-M-BO	Balloon					\$ 1,375
	TB-7236-DBN-MC-SQ	Square with Casters					\$ 1,495
	TB-7236-DBN-MC-SS	Square & Stem with Casters					\$ 1,920
	TB-7236-DBN-MC-D	Diameter with Casters					\$ 1,495
TB-7236-DBN-MC-DS	Diameter & Stem with Casters				\$ 1,920		
TB-7236-DBN-FL	Flip Leg (for Nesting Tables)				\$ 2,130		
TB-7236-DBN-FD	Folding Leg				\$ 2,130		
	Rectangle Table, 72" Width, 42" Depth DROPPED BULLNOSE Edge; with WOOD Leg Option:	72"	42"	29"		 <p>"DBN" 3/4" Dropped Bullnoses Edge</p> <p>Edge Option:</p> <p>Metal Leg Options:</p>  <p>"M-SQ" Square 2" "M-SS" Square Stem 2" "M-D" Diameter 2" "M-DS" Diameter Stem 2" "M-BO" Balloon 2 1/2" "FL" or "FD" Flip OR Fold Leg</p> <p>Wood Leg Options:</p>  <p>"W-SQ" Square 2 3/8" "W-SQR" Square Radius 2 3/8" "W-SOT" Square Tapered 2 3/8" "W-DT" Diameter Tapered 2 3/8" "W-SR" Safari 2 3/8"</p> <p>"MC" Caster Option: Available on all Metal Legs ONLY, with exception of the Balloon leg and Metal Bases.</p>  <p>Black/Black White/Grey Silver/Orange Mirror Finish/Grey</p>	
	TB-7242-DBN-W-SQ	Square	72"	42"	29"		\$ 1,395
	TB-7242-DBN-W-SQR	Square Radius					\$ 1,395
	TB-7242-DBN-W-SQT	Square Tapered					\$ 1,545
	TB-7242-DBN-W-DT	Diameter Tapered					\$ 1,675
	TB-7242-DBN-W-SR	Safari					\$ 1,680
	with METAL Leg Option:		72"	42"	29"		
	TB-7242-DBN-M-SQ	Square					\$ 1,330
	TB-7242-DBN-M-SS	Square & Stem					\$ 1,750
	TB-7242-DBN-M-D	Diameter					\$ 1,330
	TB-7242-DBN-M-DS	Diameter & Stem					\$ 1,750
	TB-7242-DBN-M-BO	Balloon					\$ 1,430
	TB-7242-DBN-MC-SQ	Square with Casters					\$ 1,555
	TB-7242-DBN-MC-SS	Square & Stem with Casters					\$ 1,980
	TB-7242-DBN-MC-D	Diameter with Casters					\$ 1,555
TB-7242-DBN-MC-DS	Diameter & Stem with Casters				\$ 1,980		
TB-7242-DBN-FL	Flip Leg (for Nesting Tables)				\$ 2,215		
TB-7242-DBN-FD	Folding Leg				\$ 2,215		

KREATIONS

MODEL NUMBER	PRODUCT	WIDTH	DEPTH	HEIGHT	PRICE	DESCRIPTION	
 <p>*Shown Above: TB-7224-DCH-M-D</p>  <p>*Rectangle Table Shape</p>	Rectangle Table, 72" Width, 24" Depth DROPPED CHAMFERED Edge; with WOOD Leg Option:	72"	24"	29"		Each Table Top is constructed using a 1 1/8" thick top with a Plastic Laminate top surface. All Metal legs are coated electrostatically with an epoxy powder coat paint. NOTES: * Table heights of 25" (children), 27" (youth), and 32" (wheelchair) are available by request. * Color of Metal Paint must be specified at the time of order. * Caster Leg options are recommended for Reading/Multipurpose Tables options and not meant to be used for stationary computer workstations. * For all tables with casters legs, only 2 legs will have casters, and the other legs will have levelers. This will create a "wheelbarrow" style of table which will ensure ease of mobility. * Color of the Caster Option must be specified at the time of order. * For the Flip OR Fold Leg option, one T base leg comes with 2 hidden casters as shown in the image below	
	TB-7224-DCH-W-SQ	Square	72"	24"	29"		\$ 1,220
	TB-7224-DCH-W-SQR	Square Radius					\$ 1,220
	TB-7224-DCH-W-SQT	Square Tapered					\$ 1,375
	TB-7224-DCH-W-DT	Diameter Tapered					\$ 1,505
	TB-7224-DCH-W-SR	Safari					\$ 1,510
		with METAL Leg Option:	72"	24"	29"		
	TB-7224-DCH-M-SQ	Square					\$ 1,160
	TB-7224-DCH-M-SS	Square & Stem					\$ 1,580
	TB-7224-DCH-M-D	Diameter					\$ 1,160
	TB-7224-DCH-M-DS	Diameter & Stem					\$ 1,580
	TB-7224-DCH-M-BO	Balloon					\$ 1,260
	TB-7224-DCH-MC-SQ	Square with Casters					\$ 1,380
	TB-7224-DCH-MC-SS	Square & Stem with Casters					\$ 1,805
	TB-7224-DCH-MC-D	Diameter with Casters					\$ 1,380
	TB-7224-DCH-MC-DS	Diameter & Stem with Casters					\$ 1,805
	TB-7224-DCH-FL	Flip Leg (for Nesting Tables)					\$ 1,995
TB-7224-DCH-FD	Folding Leg				\$ 1,995		
	Rectangle Table, 72" Width, 30" Depth DROPPED CHAMFERED Edge; with WOOD Leg Option:	72"	30"	29"		 <p>"DCH" 3/4" Dropped Chamfered Edge</p> <p>Edge Option:</p> <p>Metal Leg Options:</p>  <p>"M-SQ" Square 2" "M-SS" Square Stem 2" "M-D" Diameter 2" "M-DS" Diameter Stem 2" "M-BO" Balloon 2 1/2" "FL" or "FD" Flip OR Fold Leg</p> <p>Wood Leg Options:</p>  <p>"W-SQ" Square 2 3/8" "W-SQR" Square Radius 2 3/8" "W-SOT" Square Tapered 2 3/8" "W-DT" Diameter Tapered 2 3/8" "W-SR" Safari 2 3/8"</p>  <p>Black/Black White/Grey Silver/Orange Mirror Finish/Grey</p> <p>"MC" Caster Option: Available on all Metal Legs ONLY, with exception of the Balloon leg and Metal Bases.</p>	
TB-7230-DCH-W-SQ	Square	72"	30"	29"	\$ 1,280		
TB-7230-DCH-W-SQR	Square Radius				\$ 1,280		
TB-7230-DCH-W-SQT	Square Tapered				\$ 1,430		
TB-7230-DCH-W-DT	Diameter Tapered				\$ 1,560		
TB-7230-DCH-W-SR	Safari				\$ 1,565		
	with METAL Leg Option:	72"	30"	29"			
TB-7230-DCH-M-SQ	Square				\$ 1,215		
TB-7230-DCH-M-SS	Square & Stem				\$ 1,635		
TB-7230-DCH-M-D	Diameter				\$ 1,215		
TB-7230-DCH-M-DS	Diameter & Stem				\$ 1,635		
TB-7230-DCH-M-BO	Balloon				\$ 1,315		
TB-7230-DCH-MC-SQ	Square with Casters				\$ 1,440		
TB-7230-DCH-MC-SS	Square & Stem with Casters				\$ 1,865		
TB-7230-DCH-MC-D	Diameter with Casters				\$ 1,440		
TB-7230-DCH-MC-DS	Diameter & Stem with Casters				\$ 1,865		
TB-7230-DCH-FL	Flip Leg (for Nesting Tables)				\$ 2,065		
TB-7230-DCH-FD	Folding Leg				\$ 2,065		

KREATIONS

MODEL NUMBER	PRODUCT	WIDTH	DEPTH	HEIGHT	PRICE	DESCRIPTION	
 <p>*Shown Above: TB-7224-DCH-M-D</p>  <p>*Rectangle Table Shape</p>	Rectangle Table, 72" Width, 36" Depth	72"	36"	29"		Each Table Top is constructed using a 1 1/8" thick top with a Plastic Laminate top surface.	
	DROPPED CHAMFERED Edge;					All Metal legs are coated electrostatically with an epoxy powder coat paint.	
	with WOOD Leg Option:					NOTES:	
	TB-7236-DCH-W-SQ	Square	72"	36"	29"	\$ 1,335	* Table heights of 25" (children), 27" (youth), and 32" (wheelchair) are available by request.
	TB-7236-DCH-W-SQR	Square Radius				\$ 1,335	* Color of Metal Paint must be specified at the time of order.
	TB-7236-DCH-W-SQT	Square Tapered				\$ 1,490	* Caster Leg options are recommended for Reading/Multipurpose Tables options and not meant to be used for stationary computer workstations.
	TB-7236-DCH-W-DT	Diameter Tapered				\$ 1,615	* For all tables with casters legs, only 2 legs will have casters, and the other legs will have levelers. This will create a "wheelbarrow" style of table which will ensure ease of mobility.
	TB-7236-DCH-W-SR	Safari				\$ 1,620	* Color of the Caster Option must be specified at the time of order.
	with METAL Leg Option:						* For the Flip OR Fold Leg option, one T base leg comes with 2 hidden casters as shown in the image below
	TB-7236-DCH-M-SQ	Square	72"	36"	29"	\$ 1,270	
	TB-7236-DCH-M-SS	Square & Stem				\$ 1,695	
	TB-7236-DCH-M-D	Diameter				\$ 1,270	
	TB-7236-DCH-M-DS	Diameter & Stem				\$ 1,695	
	TB-7236-DCH-M-BO	Balloon				\$ 1,375	
	TB-7236-DCH-MC-SQ	Square with Casters				\$ 1,495	
	TB-7236-DCH-MC-SS	Square & Stem with Casters				\$ 1,920	
	TB-7236-DCH-MC-D	Diameter with Casters				\$ 1,495	
	TB-7236-DCH-MC-DS	Diameter & Stem with Casters				\$ 1,920	
	TB-7236-DCH-FL	Flip Leg (for Nesting Tables)				\$ 2,130	
	TB-7236-DCH-FD	Folding Leg				\$ 2,130	
	Rectangle Table, 72" Width, 42" Depth	72"	42"	29"			
	DROPPED CHAMFERED Edge;						
	with WOOD Leg Option:						
TB-7242-DCH-W-SQ	Square	72"	42"	29"	\$ 1,395		
TB-7242-DCH-W-SQR	Square Radius				\$ 1,395		
TB-7242-DCH-W-SQT	Square Tapered				\$ 1,545		
TB-7242-DCH-W-DT	Diameter Tapered				\$ 1,675		
TB-7242-DCH-W-SR	Safari				\$ 1,680		
	with METAL Leg Option:						
TB-7242-DCH-M-SQ	Square	72"	42"	29"	\$ 1,330		
TB-7242-DCH-M-SS	Square & Stem				\$ 1,750		
TB-7242-DCH-M-D	Diameter				\$ 1,330		
TB-7242-DCH-M-DS	Diameter & Stem				\$ 1,750		
TB-7242-DCH-M-BO	Balloon				\$ 1,430		
TB-7242-DCH-MC-SQ	Square with Casters				\$ 1,555		
TB-7242-DCH-MC-SS	Square & Stem with Casters				\$ 1,980		
TB-7242-DCH-MC-D	Diameter with Casters				\$ 1,555		
TB-7242-DCH-MC-DS	Diameter & Stem with Casters				\$ 1,980		
TB-7242-DCH-FL	Flip Leg (for Nesting Tables)				\$ 2,215		
TB-7242-DCH-FD	Folding Leg				\$ 2,215		

Edge Option:





Metal Leg Options:

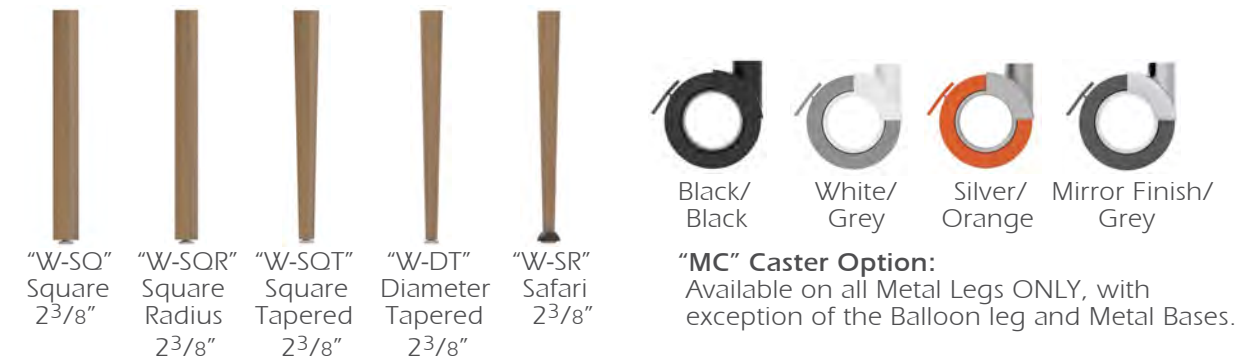

Wood Leg Options:



KREATIONS

MODEL NUMBER	PRODUCT	WIDTH	DEPTH	HEIGHT	PRICE	DESCRIPTION	
 <p>*Shown Above: TB-7224-AL-M-D</p>  <p>*Rectangle Table Shape</p>	Rectangle Table, 72" Width, 24" Depth	72"	24"	29"		Each Table Top is constructed using a 1 1/8" thick top with a Plastic Laminate top surface.	
		ALUMINUM Edge;					All Metal legs are coated electrostatically with an epoxy powder coat paint.
		with WOOD Leg Option:	72"	24"	29"		NOTES:
	TB-7224-AL-W-SQ	Square				\$ 1,070	* Table heights of 25" (children), 27" (youth), and 32" (wheelchair) are available by request.
	TB-7224-AL-W-SQR	Square Radius				\$ 1,070	* Color of Metal Paint must be specified at the time of order.
	TB-7224-AL-W-SQT	Square Tapered				\$ 1,220	* Caster Leg options are recommended for Reading/Multipurpose Tables options and not meant to be used for stationary computer workstations.
	TB-7224-AL-W-DT	Diameter Tapered				\$ 1,350	* For all tables with casters legs, only 2 legs will have casters, and the other legs will have levelers. This will create a "wheelbarrow" style of table which will ensure ease of mobility.
	TB-7224-AL-W-SR	Safari				\$ 1,355	* Color of the Caster Option must be specified at the time of order.
		with METAL Leg Option:	72"	24"	29"		* For the Flip OR Fold Leg option, one T base leg comes with 2 hidden casters as shown in the image below
	TB-7224-AL-M-SQ	Square				\$ 1,005	
	TB-7224-AL-M-SS	Square & Stem				\$ 1,425	
	TB-7224-AL-M-D	Diameter				\$ 1,005	
	TB-7224-AL-M-DS	Diameter & Stem				\$ 1,425	
	TB-7224-AL-M-BO	Balloon				\$ 1,110	
	TB-7224-AL-MC-SQ	Square with Casters				\$ 1,230	
	TB-7224-AL-MC-SS	Square & Stem with Casters				\$ 1,655	
	TB-7224-AL-MC-D	Diameter with Casters				\$ 1,230	
	TB-7224-AL-MC-DS	Diameter & Stem with Casters				\$ 1,655	
TB-7224-AL-FL	Flip Leg (for Nesting Tables)				\$ 1,845		
TB-7224-AL-FD	Folding Leg				\$ 1,845		
	Rectangle Table, 72" Width, 30" Depth	72"	30"	29"			
	ALUMINUM Edge;						
	with WOOD Leg Option:	72"	30"	29"			
TB-7230-AL-W-SQ	Square				\$ 1,115		
TB-7230-AL-W-SQR	Square Radius				\$ 1,115		
TB-7230-AL-W-SQT	Square Tapered				\$ 1,270		
TB-7230-AL-W-DT	Diameter Tapered				\$ 1,395		
TB-7230-AL-W-SR	Safari				\$ 1,405		
	with METAL Leg Option:	72"	30"	29"			
TB-7230-AL-M-SQ	Square				\$ 1,050		
TB-7230-AL-M-SS	Square & Stem				\$ 1,475		
TB-7230-AL-M-D	Diameter				\$ 1,050		
TB-7230-AL-M-DS	Diameter & Stem				\$ 1,475		
TB-7230-AL-M-BO	Balloon				\$ 1,155		
TB-7230-AL-MC-SQ	Square with Casters				\$ 1,280		
TB-7230-AL-MC-SS	Square & Stem with Casters				\$ 1,700		
TB-7230-AL-MC-D	Diameter with Casters				\$ 1,280		
TB-7230-AL-MC-DS	Diameter & Stem with Casters				\$ 1,700		
TB-7230-AL-FL	Flip Leg (for Nesting Tables)				\$ 1,905		
TB-7230-AL-FD	Folding Leg				\$ 1,905		

Edge Option:



"AL" 3mm Aluminum Edge *All table corners will be given a 6-inch radius for this edge option.

Metal Leg Options:

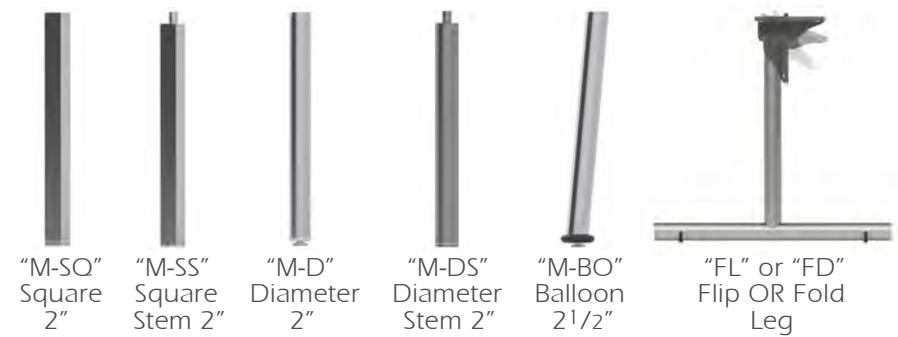

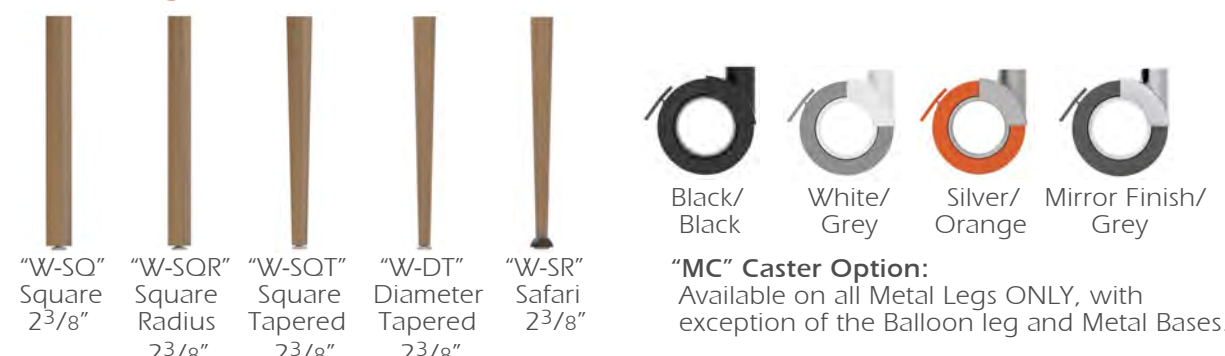

Wood Leg Options:



"MC" Caster Option: Available on all Metal Legs ONLY, with exception of the Balloon leg and Metal Bases.

KREATIONS

MODEL NUMBER	PRODUCT	WIDTH	DEPTH	HEIGHT	PRICE	DESCRIPTION	
 <p>*Shown Above: TB-7224-AL-M-D</p>  <p>*Rectangle Table Shape</p>	Rectangle Table, 72" Width, 36" Depth	72"	36"	29"		Each Table Top is constructed using a 1 1/8" thick top with a Plastic Laminate top surface.	
		ALUMINUM Edge;					All Metal legs are coated electrostatically with an epoxy powder coat paint.
		with WOOD Leg Option:	72"	36"	29"		NOTES:
	TB-7236-AL-W-SQ	Square				\$ 1,165	* Table heights of 25" (children), 27" (youth), and 32" (wheelchair) are available by request.
	TB-7236-AL-W-SQR	Square Radius				\$ 1,165	* Color of Metal Paint must be specified at the time of order.
	TB-7236-AL-W-SQT	Square Tapered				\$ 1,315	* Caster Leg options are recommended for Reading/Multipurpose Tables options and not meant to be used for stationary computer workstations.
	TB-7236-AL-W-DT	Diameter Tapered				\$ 1,445	* For all tables with casters legs, only 2 legs will have casters, and the other legs will have levelers. This will create a "wheelbarrow" style of table which will ensure ease of mobility.
	TB-7236-AL-W-SR	Safari				\$ 1,450	* Color of the Caster Option must be specified at the time of order.
		with METAL Leg Option:	72"	36"	29"		* For the Flip OR Fold Leg option, one T base leg comes with 2 hidden casters as shown in the image below
	TB-7236-AL-M-SQ	Square				\$ 1,100	
	TB-7236-AL-M-SS	Square & Stem				\$ 1,520	
	TB-7236-AL-M-D	Diameter				\$ 1,100	
	TB-7236-AL-M-DS	Diameter & Stem				\$ 1,520	
	TB-7236-AL-M-BO	Balloon				\$ 1,205	
	TB-7236-AL-MC-SQ	Square with Casters				\$ 1,325	
	TB-7236-AL-MC-SS	Square & Stem with Casters				\$ 1,750	
	TB-7236-AL-MC-D	Diameter with Casters				\$ 1,325	
TB-7236-AL-MC-DS	Diameter & Stem with Casters				\$ 1,750		
TB-7236-AL-FL	Flip Leg (for Nesting Tables)				\$ 1,960		
TB-7236-AL-FD	Folding Leg				\$ 1,960		
	Rectangle Table, 72" Width, 42" Depth	72"	42"	29"			
	ALUMINUM Edge;						
	with WOOD Leg Option:	72"	42"	29"			
TB-7242-AL-W-SQ	Square				\$ 1,210		
TB-7242-AL-W-SQR	Square Radius				\$ 1,210		
TB-7242-AL-W-SQT	Square Tapered				\$ 1,365		
TB-7242-AL-W-DT	Diameter Tapered				\$ 1,490		
TB-7242-AL-W-SR	Safari				\$ 1,500		
	with METAL Leg Option:	72"	42"	29"			
TB-7242-AL-M-SQ	Square				\$ 1,145		
TB-7242-AL-M-SS	Square & Stem				\$ 1,570		
TB-7242-AL-M-D	Diameter				\$ 1,145		
TB-7242-AL-M-DS	Diameter & Stem				\$ 1,570		
TB-7242-AL-M-BO	Balloon				\$ 1,250		
TB-7242-AL-MC-SQ	Square with Casters				\$ 1,375		
TB-7242-AL-MC-SS	Square & Stem with Casters				\$ 1,795		
TB-7242-AL-MC-D	Diameter with Casters				\$ 1,375		
TB-7242-AL-MC-DS	Diameter & Stem with Casters				\$ 1,795		
TB-7242-AL-FL	Flip Leg (for Nesting Tables)				\$ 2,030		
TB-7242-AL-FD	Folding Leg				\$ 2,030		

Edge Option:



3mm Aluminum Edge *All table corners will be given a 6-inch radius for this edge option.

Metal Leg Options:

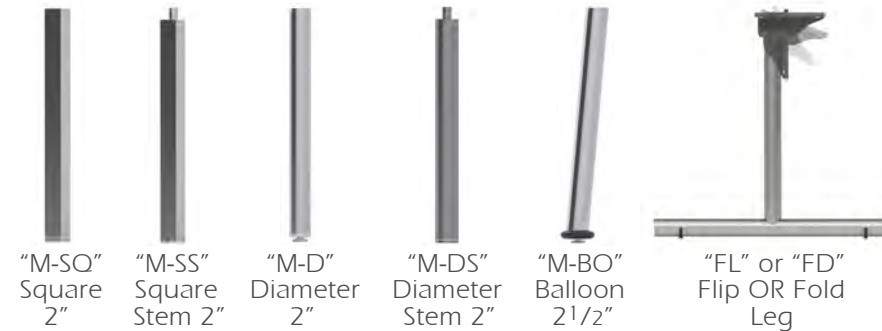

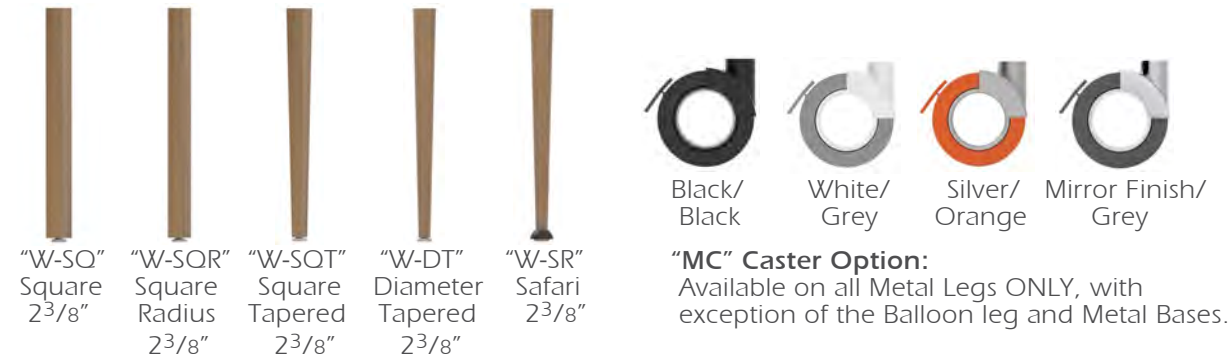

Wood Leg Options:



"MC" Caster Option:
Available on all Metal Legs ONLY, with exception of the Balloon leg and Metal Bases.

KREATIONS

MODEL NUMBER	PRODUCT	WIDTH	DEPTH	HEIGHT	PRICE	DESCRIPTION	
 <p>*Shown Above: TB-8442-AC-M-D</p>  <p>*Rectangle Table Shape</p>	Rectangle Table, 84" Width, 36" Depth	84"	36"	29"		Each Table Top is constructed using a 1" thick top with a Plastic Laminate top surface.	
		ACRYLIC Edge;					All Metal legs are coated electrostatically with an epoxy powder coat paint.
		with WOOD Leg Option:	84"	36"	29"		NOTES: * Table heights of 25" (children), 27" (youth), and 32" (wheelchair) are available by request. * Color of Metal Paint must be specified at the time of order. * Caster Leg options are recommended for Reading/Multipurpose Tables options and not meant to be used for stationary computer workstations. * For all tables with casters legs, only 2 legs will have casters, and the other legs will have levelers. This will create a "wheelbarrow" style of table which will ensure ease of mobility. * Color of the Caster Option must be specified at the time of order. * For the Flip OR Fold Leg option, one T base leg comes with 2 hidden casters as shown in the image below.
	TB-8436-AC-W-SQ	Square			\$ 1,105		
	TB-8436-AC-W-SQR	Square Radius			\$ 1,105		
	TB-8436-AC-W-SQT	Square Tapered			\$ 1,255		
	TB-8436-AC-W-DT	Diameter Tapered			\$ 1,385		
	TB-8436-AC-W-SR	Safari			\$ 1,395		
		with METAL Leg Option:	84"	36"	29"		
	TB-8436-AC-M-SQ	Square			\$ 1,040		
	TB-8436-AC-M-SS	Square & Stem			\$ 1,465		
	TB-8436-AC-M-D	Diameter			\$ 1,040		
	TB-8436-AC-M-DS	Diameter & Stem			\$ 1,465		
	TB-8436-AC-M-BO	Balloon			\$ 1,140		
	TB-8436-AC-MC-SQ	Square with Casters			\$ 1,270		
	TB-8436-AC-MC-SS	Square & Stem with Casters			\$ 1,690		
	TB-8436-AC-MC-D	Diameter with Casters			\$ 1,270		
TB-8436-AC-MC-DS	Diameter & Stem with Casters			\$ 1,690			
TB-8436-AC-FL	Flip Leg (for Nesting Tables)			\$ 1,900			
TB-8436-AC-FD	Folding Leg			\$ 1,900			
	Rectangle Table, 84" Width, 42" Depth	84"	42"	29"			
	ACRYLIC Edge;						
	with WOOD Leg Option:	84"	42"	29"			
TB-8442-AC-W-SQ	Square			\$ 1,155			
TB-8442-AC-W-SQR	Square Radius			\$ 1,155			
TB-8442-AC-W-SQT	Square Tapered			\$ 1,305			
TB-8442-AC-W-DT	Diameter Tapered			\$ 1,435			
TB-8442-AC-W-SR	Safari			\$ 1,445			
	with METAL Leg Option:	84"	42"	29"			
TB-8442-AC-M-SQ	Square			\$ 1,090			
TB-8442-AC-M-SS	Square & Stem			\$ 1,510			
TB-8442-AC-M-D	Diameter			\$ 1,090			
TB-8442-AC-M-DS	Diameter & Stem			\$ 1,510			
TB-8442-AC-M-BO	Balloon			\$ 1,190			
TB-8442-AC-MC-SQ	Square with Casters			\$ 1,315			
TB-8442-AC-MC-SS	Square & Stem with Casters			\$ 1,740			
TB-8442-AC-MC-D	Diameter with Casters			\$ 1,315			
TB-8442-AC-MC-DS	Diameter & Stem with Casters			\$ 1,740			
TB-8442-AC-FL	Flip Leg (for Nesting Tables)			\$ 1,975			
TB-8442-AC-FD	Folding Leg			\$ 1,975			

Edge Option:

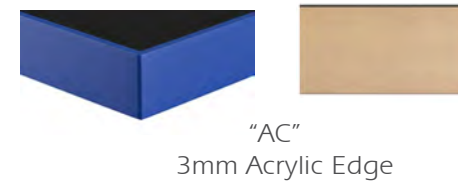

Metal Leg Options:



Wood Leg Options:

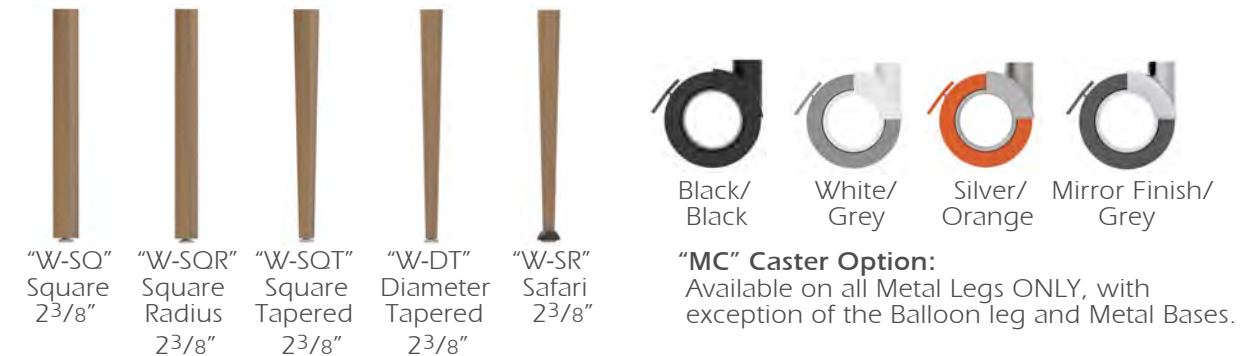

KREATIONS

MODEL NUMBER	PRODUCT	WIDTH	DEPTH	HEIGHT	PRICE	DESCRIPTION
	Rectangle Table, 84" Width, 48" Depth	84"	48"	29"		Each Table Top is constructed using a 1" thick top with a Plastic Laminate top surface.
	ACRYLIC Edge;					All Metal legs are coated electrostatically with an epoxy powder coat paint.
*Shown Above: TB-8442-AC-M-D	with WOOD Leg Option:	84"	48"	29"		NOTES: * Table heights of 25" (children), 27" (youth), and 32" (wheelchair) are available by request. * Color of Metal Paint must be specified at the time of order. * Caster Leg options are recommended for Reading/Multipurpose Tables options and not meant to be used for stationary computer workstations. * For all tables with casters legs, only 2 legs will have casters, and the other legs will have levelers. This will create a "wheelbarrow" style of table which will ensure ease of mobility. * Color of the Caster Option must be specified at the time of order. * For the Flip OR Fold Leg option, one T base leg comes with 2 hidden casters as shown in the image below.
	TB-8448-AC-W-SQ Square				\$ 1,205	
	TB-8448-AC-W-SQR Square Radius				\$ 1,205	
	TB-8448-AC-W-SQT Square Tapered				\$ 1,355	
	TB-8448-AC-W-DT Diameter Tapered				\$ 1,485	
	TB-8448-AC-W-SR Safari				\$ 1,490	
	with METAL Leg Option:	84"	48"	29"		
*Rectangle Table Shape	TB-8448-AC-M-SQ Square				\$ 1,140	
	TB-8448-AC-M-SS Square & Stem				\$ 1,560	
	TB-8448-AC-M-D Diameter				\$ 1,140	
	TB-8448-AC-M-DS Diameter & Stem				\$ 1,560	
	TB-8448-AC-M-BO Balloon				\$ 1,240	
	TB-8448-AC-MC-SQ Square with Casters				\$ 1,365	
	TB-8448-AC-MC-SS Square & Stem with Casters				\$ 1,790	
	TB-8448-AC-MC-D Diameter with Casters				\$ 1,365	
	TB-8448-AC-MC-DS Diameter & Stem with Casters				\$ 1,790	
	TB-8448-AC-FL Flip Leg (for Nesting Tables)				\$ 2,025	
	TB-8448-AC-FD Folding Leg				\$ 2,025	

Edge Option:

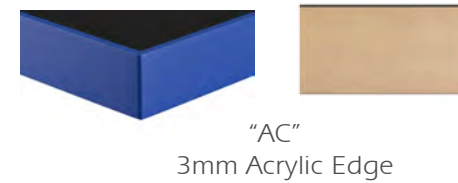

Metal Leg Options:

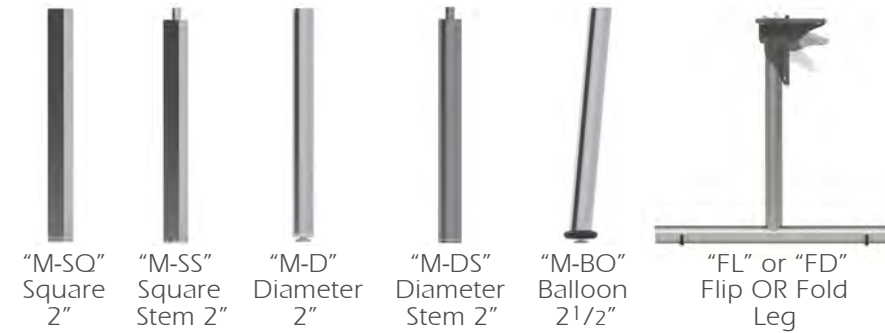

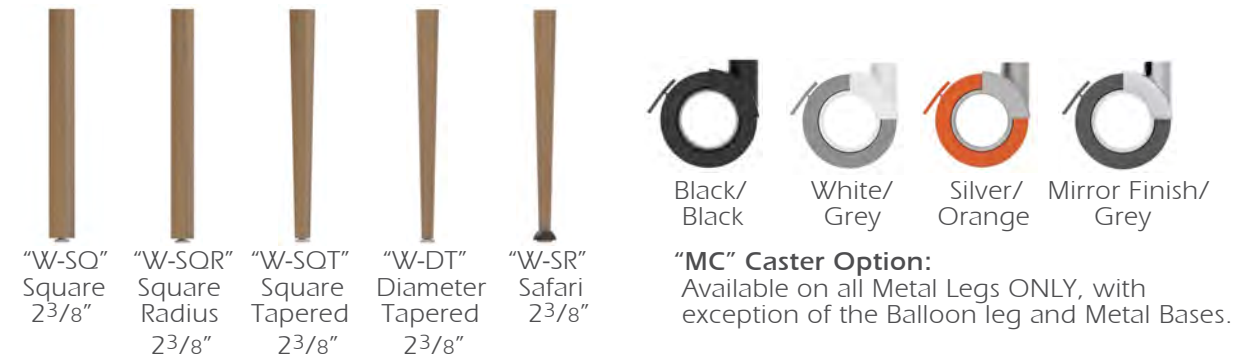

Wood Leg Options:



"MC" Caster Option:
Available on all Metal Legs ONLY, with exception of the Balloon leg and Metal Bases.

KREATIONS

MODEL NUMBER	PRODUCT	WIDTH	DEPTH	HEIGHT	PRICE	DESCRIPTION	
 <p>*Shown Above: TB-8442-SQ-M-D</p>  <p>*Rectangle Table Shape</p>	Rectangle Table, 84" Width, 36" Depth	84"	36"	29"		Each Table Top is constructed using a 1 1/8" thick top with a Plastic Laminate top surface.	
	SQUARE Edge;					All Metal legs are coated electrostatically with an epoxy powder coat paint.	
	with WOOD Leg Option:					NOTES:	
	TB-8436-SQ-W-SQ	Square	84"	36"	29"	\$ 1,295	* Table heights of 25" (children), 27" (youth), and 32" (wheelchair) are available by request.
	TB-8436-SQ-W-SQR	Square Radius				\$ 1,295	* Color of Metal Paint must be specified at the time of order.
	TB-8436-SQ-W-SQT	Square Tapered				\$ 1,445	* Caster Leg options are recommended for Reading/Multipurpose Tables options and not meant to be used for stationary computer workstations.
	TB-8436-SQ-W-DT	Diameter Tapered				\$ 1,575	* For all tables with casters legs, only 2 legs will have casters, and the other legs will have levelers. This will create a "wheelbarrow" style of table which will ensure ease of mobility.
	TB-8436-SQ-W-SR	Safari				\$ 1,585	* Color of the Caster Option must be specified at the time of order.
	with METAL Leg Option:						* For the Flip OR Fold Leg option, one T base leg comes with 2 hidden casters as shown in the image below.
	TB-8436-SQ-M-SQ	Square	84"	36"	29"	\$ 1,230	
TB-8436-SQ-M-SS	Square & Stem				\$ 1,655		
TB-8436-SQ-M-D	Diameter				\$ 1,230		
TB-8436-SQ-M-DS	Diameter & Stem				\$ 1,655		
TB-8436-SQ-M-BO	Balloon				\$ 1,330		
TB-8436-SQ-MC-SQ	Square with Casters				\$ 1,460		
TB-8436-SQ-MC-SS	Square & Stem with Casters				\$ 1,880		
TB-8436-SQ-MC-D	Diameter with Casters				\$ 1,460		
TB-8436-SQ-MC-DS	Diameter & Stem with Casters				\$ 1,880		
TB-8436-SQ-FL	Flip Leg (for Nesting Tables)				\$ 2,090		
TB-8436-SQ-FD	Folding Leg				\$ 2,090		
	Rectangle Table, 84" Width, 42" Depth	84"	42"	29"			
	SQUARE Edge;						
	with WOOD Leg Option:						
TB-8442-SQ-W-SQ	Square	84"	42"	29"	\$ 1,350		
TB-8442-SQ-W-SQR	Square Radius				\$ 1,350		
TB-8442-SQ-W-SQT	Square Tapered				\$ 1,505		
TB-8442-SQ-W-DT	Diameter Tapered				\$ 1,635		
TB-8442-SQ-W-SR	Safari				\$ 1,640		
	with METAL Leg Option:						
TB-8442-SQ-M-SQ	Square	84"	42"	29"	\$ 1,285		
TB-8442-SQ-M-SS	Square & Stem				\$ 1,710		
TB-8442-SQ-M-D	Diameter				\$ 1,285		
TB-8442-SQ-M-DS	Diameter & Stem				\$ 1,710		
TB-8442-SQ-M-BO	Balloon				\$ 1,390		
TB-8442-SQ-MC-SQ	Square with Casters				\$ 1,515		
TB-8442-SQ-MC-SS	Square & Stem with Casters				\$ 1,935		
TB-8442-SQ-MC-D	Diameter with Casters				\$ 1,515		
TB-8442-SQ-MC-DS	Diameter & Stem with Casters				\$ 1,935		
TB-8442-SQ-FL	Flip Leg (for Nesting Tables)				\$ 2,170		
TB-8442-SQ-FD	Folding Leg				\$ 2,170		

Edge Option:



Metal Leg Options:

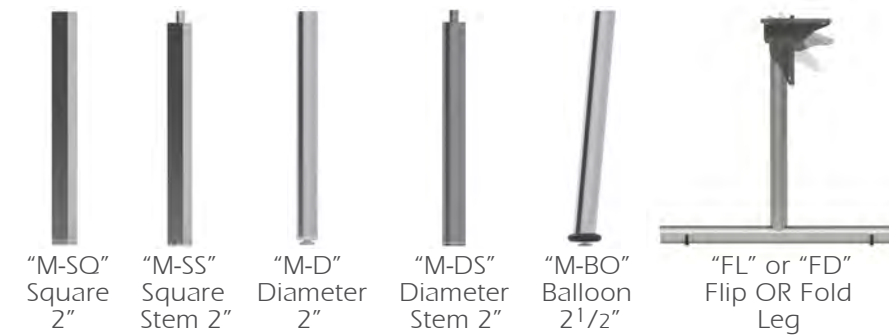

Wood Leg Options:

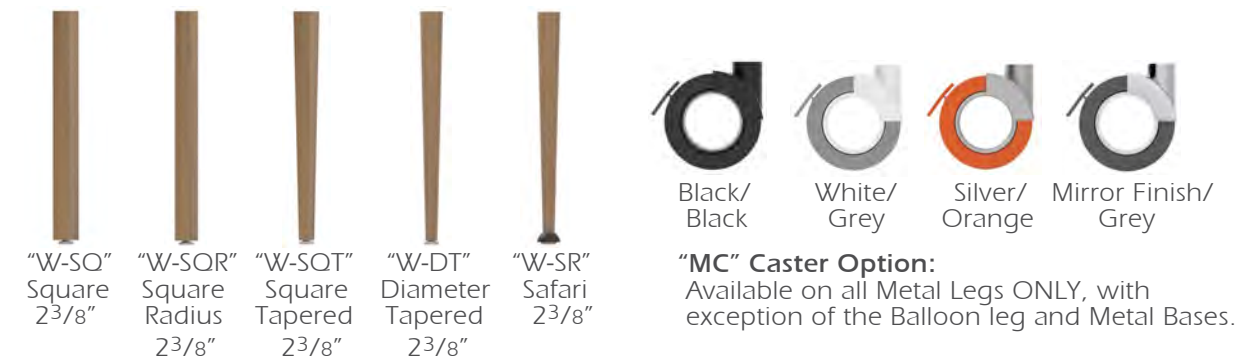

"MC" Caster Option:
Available on all Metal Legs ONLY, with exception of the Balloon leg and Metal Bases.

KREATIONS

MODEL NUMBER	PRODUCT	WIDTH	DEPTH	HEIGHT	PRICE	DESCRIPTION
 *Shown Above: TB-8442-SQ-M-D	Rectangle Table, 84" Width, 48" Depth	84"	48"	29"		Each Table Top is constructed using a 1 1/8" thick top with a Plastic Laminate top surface.
	SQUARE Edge;					All Metal legs are coated electrostatically with an epoxy powder coat paint.
 *Rectangle Table Shape	with WOOD Leg Option:	84"	48"	29"		NOTES: * Table heights of 25" (children), 27" (youth), and 32" (wheelchair) are available by request. * Color of Metal Paint must be specified at the time of order. * Caster Leg options are recommended for Reading/Multipurpose Tables options and not meant to be used for stationary computer workstations. * For all tables with casters legs, only 2 legs will have casters, and the other legs will have levelers. This will create a "wheelbarrow" style of table which will ensure ease of mobility. * Color of the Caster Option must be specified at the time of order. * For the Flip OR Fold Leg option, one T base leg comes with 2 hidden casters as shown in the image below.
	TB-8448-SQ-W-SQ Square				\$ 1,410	
	TB-8448-SQ-W-SQR Square Radius				\$ 1,410	
	TB-8448-SQ-W-SQT Square Tapered				\$ 1,565	
	TB-8448-SQ-W-DT Diameter Tapered				\$ 1,695	
	TB-8448-SQ-W-SR Safari				\$ 1,700	
	with METAL Leg Option:	84"	48"	29"		
	TB-8448-SQ-M-SQ Square				\$ 1,350	
	TB-8448-SQ-M-SS Square & Stem				\$ 1,770	
	TB-8448-SQ-M-D Diameter				\$ 1,350	
TB-8448-SQ-M-DS Diameter & Stem				\$ 1,770		
TB-8448-SQ-M-BO Balloon				\$ 1,450		
TB-8448-SQ-MC-SQ Square with Casters				\$ 1,570		
TB-8448-SQ-MC-SS Square & Stem with Casters				\$ 1,995		
TB-8448-SQ-MC-D Diameter with Casters				\$ 1,570		
TB-8448-SQ-MC-DS Diameter & Stem with Casters				\$ 1,995		
TB-8448-SQ-FL Flip Leg (for Nesting Tables)				\$ 2,235		
TB-8448-SQ-FD Folding Leg				\$ 2,235		

Edge Option:



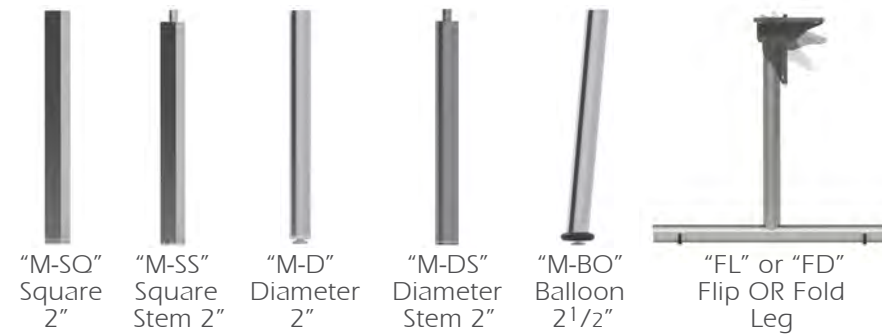

Metal Leg Options:

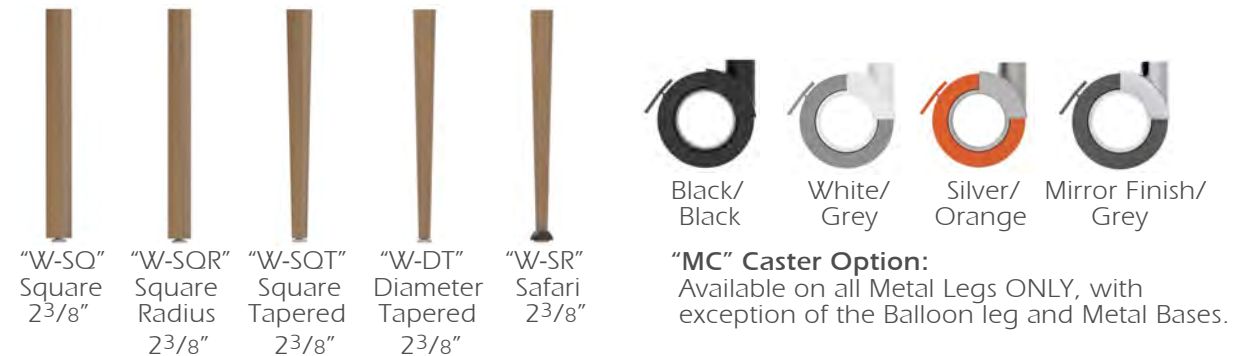

Wood Leg Options:



KREATIONS

MODEL NUMBER	PRODUCT	WIDTH	DEPTH	HEIGHT	PRICE	DESCRIPTION	
 <p>*Shown Above: TB-8442-DSQ-M-D</p>  <p>*Rectangle Table Shape</p>	Rectangle Table, 84" Width, 36" Depth	84"	36"	29"		Each Table Top is constructed using a 1 1/8" thick top with a Plastic Laminate top surface.	
		DROPPED SQUARE Edge;					All Metal legs are coated electrostatically with an epoxy powder coat paint.
		with WOOD Leg Option:	84"	36"	29"		NOTES:
	TB-8436-DSQ-W-SQ	Square				\$ 1,395	* Table heights of 25" (children), 27" (youth), and 32" (wheelchair) are available by request.
	TB-8436-DSQ-W-SQR	Square Radius				\$ 1,395	* Color of Metal Paint must be specified at the time of order.
	TB-8436-DSQ-W-SQT	Square Tapered				\$ 1,550	* Caster Leg options are recommended for Reading/Multipurpose Tables options and not meant to be used for stationary computer workstations.
	TB-8436-DSQ-W-DT	Diameter Tapered				\$ 1,680	* For all tables with casters legs, only 2 legs will have casters, and the other legs will have levelers. This will create a "wheelbarrow" style of table which will ensure ease of mobility.
	TB-8436-DSQ-W-SR	Safari				\$ 1,685	* Color of the Caster Option must be specified at the time of order.
		with METAL Leg Option:	84"	36"	29"		* For the Flip OR Fold Leg option, one T base leg comes with 2 hidden casters as shown in the image below
	TB-8436-DSQ-M-SQ	Square				\$ 1,330	
	TB-8436-DSQ-M-SS	Square & Stem				\$ 1,760	
	TB-8436-DSQ-M-D	Diameter				\$ 1,330	
	TB-8436-DSQ-M-DS	Diameter & Stem				\$ 1,760	
	TB-8436-DSQ-M-BO	Balloon				\$ 1,435	
	TB-8436-DSQ-MC-SQ	Square with Casters				\$ 1,560	
	TB-8436-DSQ-MC-SS	Square & Stem with Casters				\$ 1,980	
	TB-8436-DSQ-MC-D	Diameter with Casters				\$ 1,560	
TB-8436-DSQ-MC-DS	Diameter & Stem with Casters				\$ 1,980		
TB-8436-DSQ-FL	Flip Leg (for Nesting Tables)				\$ 2,195		
TB-8436-DSQ-FD	Folding Leg				\$ 2,195		
	Rectangle Table, 84" Width, 42" Depth	84"	42"	29"			
	DROPPED SQUARE Edge;						
	with WOOD Leg Option:	84"	42"	29"			
TB-8442-DSQ-W-SQ	Square				\$ 1,460		
TB-8442-DSQ-W-SQR	Square Radius				\$ 1,460		
TB-8442-DSQ-W-SQT	Square Tapered				\$ 1,615		
TB-8442-DSQ-W-DT	Diameter Tapered				\$ 1,745		
TB-8442-DSQ-W-SR	Safari				\$ 1,750		
	with METAL Leg Option:	84"	42"	29"			
TB-8442-DSQ-M-SQ	Square				\$ 1,395		
TB-8442-DSQ-M-SS	Square & Stem				\$ 1,820		
TB-8442-DSQ-M-D	Diameter				\$ 1,395		
TB-8442-DSQ-M-DS	Diameter & Stem				\$ 1,820		
TB-8442-DSQ-M-BO	Balloon				\$ 1,500		
TB-8442-DSQ-MC-SQ	Square with Casters				\$ 935		
TB-8442-DSQ-MC-SS	Square & Stem with Casters				\$ 2,045		
TB-8442-DSQ-MC-D	Diameter with Casters				\$ 1,620		
TB-8442-DSQ-MC-DS	Diameter & Stem with Casters				\$ 2,045		
TB-8442-DSQ-FL	Flip Leg (for Nesting Tables)				\$ 2,280		
TB-8442-DSQ-FD	Folding Leg				\$ 2,280		

Edge Option:



Metal Leg Options:

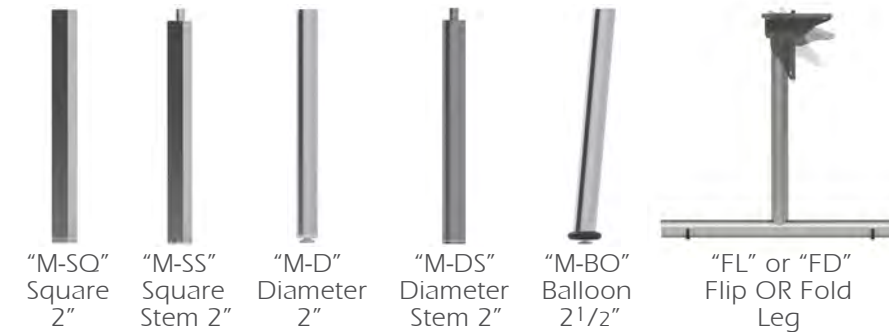

Wood Leg Options:



"MC" Caster Option:
Available on all Metal Legs ONLY, with exception of the Balloon leg and Metal Bases.

KREATIONS

MODEL NUMBER	PRODUCT	WIDTH	DEPTH	HEIGHT	PRICE	DESCRIPTION
	Rectangle Table, 84" Width, 48" Depth	84"	48"	29"		Each Table Top is constructed using a 1 1/8" thick top with a Plastic Laminate top surface.
	DROPPED SQUARE Edge;					All Metal legs are coated electrostatically with an epoxy powder coat paint.
	with WOOD Leg Option:	84"	48"	29"		NOTES: * Table heights of 25" (children), 27" (youth), and 32" (wheelchair) are available by request. * Color of Metal Paint must be specified at the time of order. * Caster Leg options are recommended for Reading/Multipurpose Tables options and not meant to be used for stationary computer workstations. * For all tables with casters legs, only 2 legs will have casters, and the other legs will have levelers. This will create a "wheelbarrow" style of table which will ensure ease of mobility. * Color of the Caster Option must be specified at the time of order. * For the Flip OR Fold Leg option, one T base leg comes with 2 hidden casters as shown in the image below
	TB-8448-DSQ-W-SQ Square				\$ 1,525	
	TB-8448-DSQ-W-SQR Square Radius				\$ 1,525	
	TB-8448-DSQ-W-SQT Square Tapered				\$ 1,680	
	TB-8448-DSQ-W-DT Diameter Tapered				\$ 1,805	
	TB-8448-DSQ-W-SR Safari				\$ 1,815	
	with METAL Leg Option:	84"	48"	29"		
	TB-8448-DSQ-M-SQ Square				\$ 1,460	
	TB-8448-DSQ-M-SS Square & Stem				\$ 1,885	
	TB-8448-DSQ-M-D Diameter				\$ 1,460	
	TB-8448-DSQ-M-DS Diameter & Stem				\$ 1,885	
	TB-8448-DSQ-M-BO Balloon				\$ 1,565	
	TB-8448-DSQ-MC-SQ Square with Casters				\$ 1,685	
	TB-8448-DSQ-MC-SS Square & Stem with Casters				\$ 2,110	
	TB-8448-DSQ-MC-D Diameter with Casters				\$ 1,685	
	TB-8448-DSQ-MC-DS Diameter & Stem with Casters				\$ 2,110	
	TB-8448-DSQ-FL Flip Leg (for Nesting Tables)				\$ 2,345	
	TB-8448-DSQ-FD Folding Leg				\$ 2,345	

*Shown Above:
TB-8442-DSQ-M-D



*Rectangle Table Shape

Edge Option:





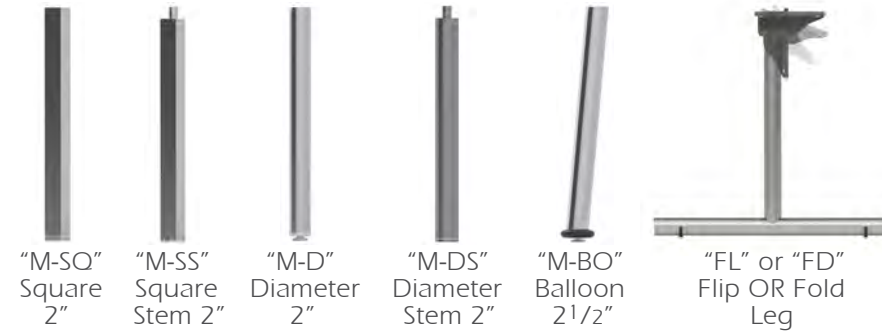

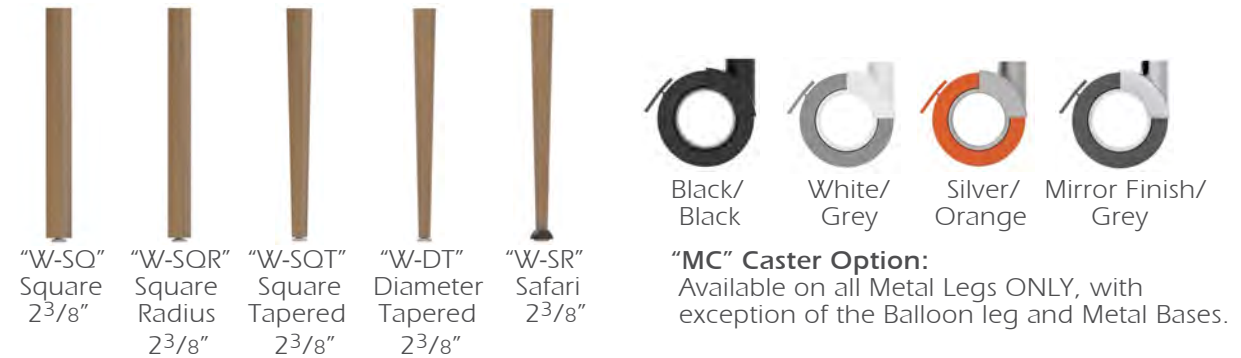

Metal Leg Options:



Wood Leg Options:



KREATIONS

MODEL NUMBER	PRODUCT	WIDTH	DEPTH	HEIGHT	PRICE	DESCRIPTION
 <p>*Shown Above: TB-8442-DBN-M-D</p>  <p>*Rectangle Table Shape</p>	Rectangle Table, 84" Width, 36" Depth DROPPED BULLNOSE Edge; with WOOD Leg Option:	84"	36"	29"		Each Table Top is constructed using a 1 1/8" thick top with a Plastic Laminate top surface. All Metal legs are coated electrostatically with an epoxy powder coat paint. NOTES: * Table heights of 25" (children), 27" (youth), and 32" (wheelchair) are available by request. * Color of Metal Paint must be specified at the time of order. * Caster Leg options are recommended for Reading/Multipurpose Tables options and not meant to be used for stationary computer workstations. * For all tables with casters legs, only 2 legs will have casters, and the other legs will have levelers. This will create a "wheelbarrow" style of table which will ensure ease of mobility. * Color of the Caster Option must be specified at the time of order. * For the Flip OR Fold Leg option, one T base leg comes with 2 hidden casters as shown in the image below Edge Option:  <p>"DBN" 3/4" Dropped Bullnoses Edge</p> Metal Leg Options:  <p>"M-SQ" Square 2" "M-SS" Square Stem 2" "M-D" Diameter 2" "M-DS" Diameter Stem 2" "M-BO" Balloon 2 1/2" "FL" or "FD" Flip OR Fold Leg</p> Wood Leg Options:  <p>"W-SQ" Square 2 3/8" "W-SQR" Square Radius 2 3/8" "W-SOT" Square Tapered 2 3/8" "W-DT" Diameter Tapered 2 3/8" "W-SR" Safari 2 3/8"</p>  <p>Black/Black White/Grey Silver/Orange Mirror Finish/Grey</p> "MC" Caster Option: Available on all Metal Legs ONLY, with exception of the Balloon leg and Metal Bases.
	TB-8436-DBN-W-SQ Square TB-8436-DBN-W-SQR Square Radius TB-8436-DBN-W-SQT Square Tapered TB-8436-DBN-W-DT Diameter Tapered TB-8436-DBN-W-SR Safari	84"	36"	29"	\$ 1,410 \$ 1,410 \$ 1,560 \$ 1,690 \$ 1,695	
	with METAL Leg Option:	84"	36"	29"	\$ 1,345 \$ 1,770 \$ 1,345 \$ 1,770 \$ 1,445 \$ 1,570 \$ 1,995 \$ 1,570 \$ 1,995 \$ 2,205 \$ 2,205	
	TB-8436-DBN-M-SQ Square TB-8436-DBN-M-SS Square & Stem TB-8436-DBN-M-D Diameter TB-8436-DBN-M-DS Diameter & Stem TB-8436-DBN-M-BO Balloon TB-8436-DBN-MC-SQ Square with Casters TB-8436-DBN-MC-SS Square & Stem with Casters TB-8436-DBN-MC-D Diameter with Casters TB-8436-DBN-MC-DS Diameter & Stem with Casters TB-8436-DBN-FL Flip Leg (for Nesting Tables) TB-8436-DBN-FD Folding Leg					
	Rectangle Table, 84" Width, 42" Depth DROPPED BULLNOSE Edge; with WOOD Leg Option:	84"	42"	29"	\$ 1,475 \$ 1,475 \$ 1,625 \$ 1,755 \$ 1,760	
	TB-8442-DBN-W-SQ Square TB-8442-DBN-W-SQR Square Radius TB-8442-DBN-W-SQT Square Tapered TB-8442-DBN-W-DT Diameter Tapered TB-8442-DBN-W-SR Safari					
	with METAL Leg Option:	84"	42"	29"	\$ 1,410 \$ 1,830 \$ 1,410 \$ 1,830 \$ 1,510 \$ 1,635 \$ 2,060 \$ 1,635 \$ 2,060 \$ 2,295 \$ 2,295	
	TB-8442-DBN-M-SQ Square TB-8442-DBN-M-SS Square & Stem TB-8442-DBN-M-D Diameter TB-8442-DBN-M-DS Diameter & Stem TB-8442-DBN-M-BO Balloon TB-8442-DBN-MC-SQ Square with Casters TB-8442-DBN-MC-SS Square & Stem with Casters TB-8442-DBN-MC-D Diameter with Casters TB-8442-DBN-MC-DS Diameter & Stem with Casters TB-8442-DBN-FL Flip Leg (for Nesting Tables) TB-8442-DBN-FD Folding Leg					

KREATIONS

MODEL NUMBER	PRODUCT	WIDTH	DEPTH	HEIGHT	PRICE	DESCRIPTION
	Rectangle Table, 84" Width, 48" Depth	84"	48"	29"		Each Table Top is constructed using a 1 1/8" thick top with a Plastic Laminate top surface.
	DROPPED BULLNOSE Edge;					All Metal legs are coated electrostatically with an epoxy powder coat paint.
*Shown Above: TB-8442-DBN-M-D	with WOOD Leg Option:	84"	48"	29"		NOTES: * Table heights of 25" (children), 27" (youth), and 32" (wheelchair) are available by request. * Color of Metal Paint must be specified at the time of order. * Caster Leg options are recommended for Reading/Multipurpose Tables options and not meant to be used for stationary computer workstations. * For all tables with casters legs, only 2 legs will have casters, and the other legs will have levelers. This will create a "wheelbarrow" style of table which will ensure ease of mobility. * Color of the Caster Option must be specified at the time of order. * For the Flip OR Fold Leg option, one T base leg comes with 2 hidden casters as shown in the image below
	Square				\$ 1,540	
	Square Radius				\$ 1,540	
	Square Tapered				\$ 1,690	
	Diameter Tapered				\$ 1,820	
	Safari				\$ 1,825	
	with METAL Leg Option:	84"	48"	29"		
	Square				\$ 1,475	
	Square & Stem				\$ 1,895	
	Diameter				\$ 1,475	
	Diameter & Stem				\$ 1,895	
	Balloon				\$ 1,575	
	Square with Casters				\$ 1,695	
	Square & Stem with Casters				\$ 2,125	
	Diameter with Casters				\$ 1,695	
	Diameter & Stem with Casters				\$ 2,125	
	Flip Leg (for Nesting Tables)				\$ 2,360	
	Folding Leg				\$ 2,360	



*Rectangle Table Shape

Edge Option:



"DBN"
3/4" Dropped Bullnoses Edge

Metal Leg Options:

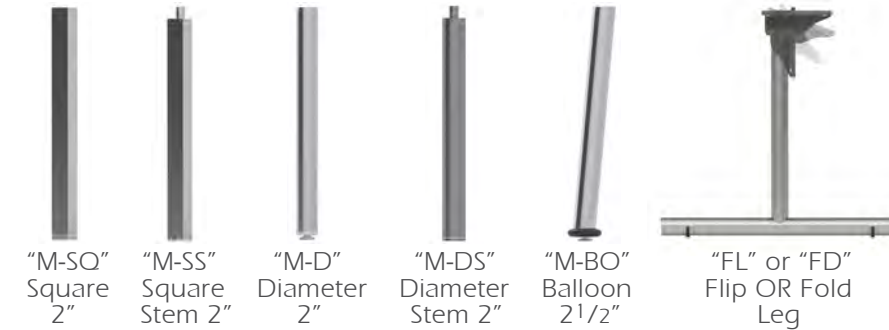

"M-SQ" Square 2"
"M-SS" Square Stem 2"
"M-D" Diameter 2"
"M-DS" Diameter Stem 2"
"M-BO" Balloon 2 1/2"
"FL" or "FD" Flip OR Fold Leg

Wood Leg Options:

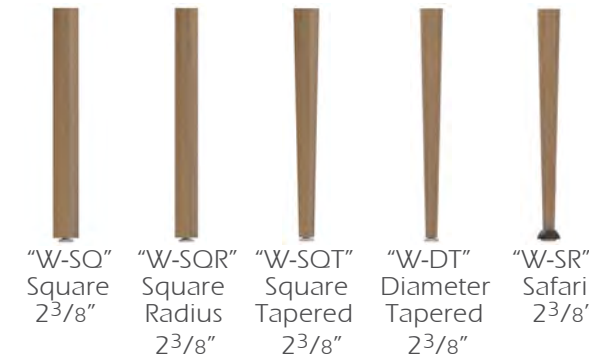



"W-SQ" Square 2 3/8"
"W-SQR" Square Radius 2 3/8"
"W-SOT" Square Tapered 2 3/8"
"W-DT" Diameter Tapered 2 3/8"
"W-SR" Safari 2 3/8"



"MC" Caster Option:
Available on all Metal Legs ONLY, with exception of the Balloon leg and Metal Bases.

KREATIONS

MODEL NUMBER	PRODUCT	WIDTH	DEPTH	HEIGHT	PRICE	DESCRIPTION	
 <p>*Shown Above: TB-8442-DCH-M-D</p>  <p>*Rectangle Table Shape</p>	Rectangle Table, 84" Width, 36" Depth	84"	36"	29"		Each Table Top is constructed using a 1 1/8" thick top with a Plastic Laminate top surface.	
		DROPPED CHAMFERED Edge;					All Metal legs are coated electrostatically with an epoxy powder coat paint.
		with WOOD Leg Option:	84"	36"	29"		NOTES:
	TB-8436-DCH-W-SQ	Square				\$ 1,410	* Table heights of 25" (children), 27" (youth), and 32" (wheelchair) are available by request.
	TB-8436-DCH-W-SQR	Square Radius				\$ 1,410	* Color of Metal Paint must be specified at the time of order.
	TB-8436-DCH-W-SQT	Square Tapered				\$ 1,560	* Caster Leg options are recommended for Reading/Multipurpose Tables options and not meant to be used for stationary computer workstations.
	TB-8436-DCH-W-DT	Diameter Tapered				\$ 1,690	* For all tables with casters legs, only 2 legs will have casters, and the other legs will have levelers. This will create a "wheelbarrow" style of table which will ensure ease of mobility.
	TB-8436-DCH-W-SR	Safari				\$ 1,695	* Color of the Caster Option must be specified at the time of order.
		with METAL Leg Option:	84"	36"	29"		* For the Flip OR Fold Leg option, one T base leg comes with 2 hidden casters as shown in the image below
	TB-8436-DCH-M-SQ	Square				\$ 1,770	
	TB-8436-DCH-M-SS	Square & Stem				\$ 1,345	
	TB-8436-DCH-M-D	Diameter				\$ 1,770	
	TB-8436-DCH-M-DS	Diameter & Stem				\$ 1,445	
	TB-8436-DCH-M-BO	Balloon				\$ 1,570	
	TB-8436-DCH-MC-SQ	Square with Casters				\$ 1,995	
	TB-8436-DCH-MC-SS	Square & Stem with Casters				\$ 1,570	
	TB-8436-DCH-MC-D	Diameter with Casters				\$ 1,995	
TB-8436-DCH-MC-DS	Diameter & Stem with Casters				\$ 2,205		
TB-8436-DCH-FL	Flip Leg (for Nesting Tables)				\$ 2,205		
TB-8436-DCH-FD	Folding Leg						
	Rectangle Table, 84" Width, 42" Depth	84"	42"	29"			
	DROPPED CHAMFERED Edge;						
	with WOOD Leg Option:	84"	42"	29"			
TB-8442-DCH-W-SQ	Square				\$ 1,475		
TB-8442-DCH-W-SQR	Square Radius				\$ 1,475		
TB-8442-DCH-W-SQT	Square Tapered				\$ 1,625		
TB-8442-DCH-W-DT	Diameter Tapered				\$ 1,755		
TB-8442-DCH-W-SR	Safari				\$ 1,760		
	with METAL Leg Option:	84"	42"	29"			
TB-8442-DCH-M-SQ	Square				\$ 1,410		
TB-8442-DCH-M-SS	Square & Stem				\$ 1,830		
TB-8442-DCH-M-D	Diameter				\$ 1,410		
TB-8442-DCH-M-DS	Diameter & Stem				\$ 1,830		
TB-8442-DCH-M-BO	Balloon				\$ 1,510		
TB-8442-DCH-MC-SQ	Square with Casters				\$ 1,635		
TB-8442-DCH-MC-SS	Square & Stem with Casters				\$ 2,060		
TB-8442-DCH-MC-D	Diameter with Casters				\$ 1,635		
TB-8442-DCH-MC-DS	Diameter & Stem with Casters				\$ 2,060		
TB-8442-DCH-FL	Flip Leg (for Nesting Tables)				\$ 2,295		
TB-8442-DCH-FD	Folding Leg				\$ 2,295		

Edge Option:



Metal Leg Options:

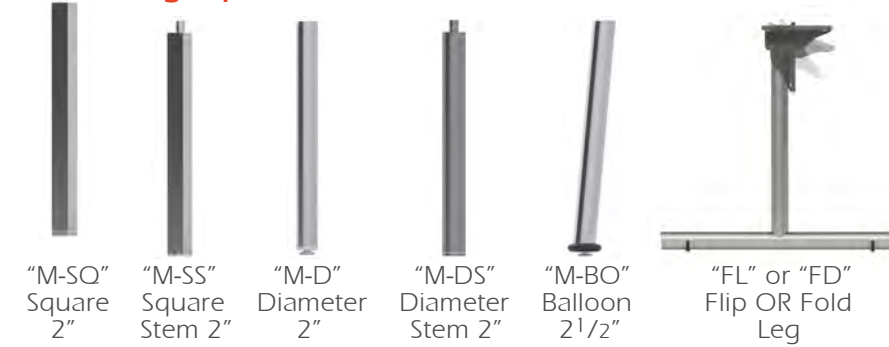

Wood Leg Options:

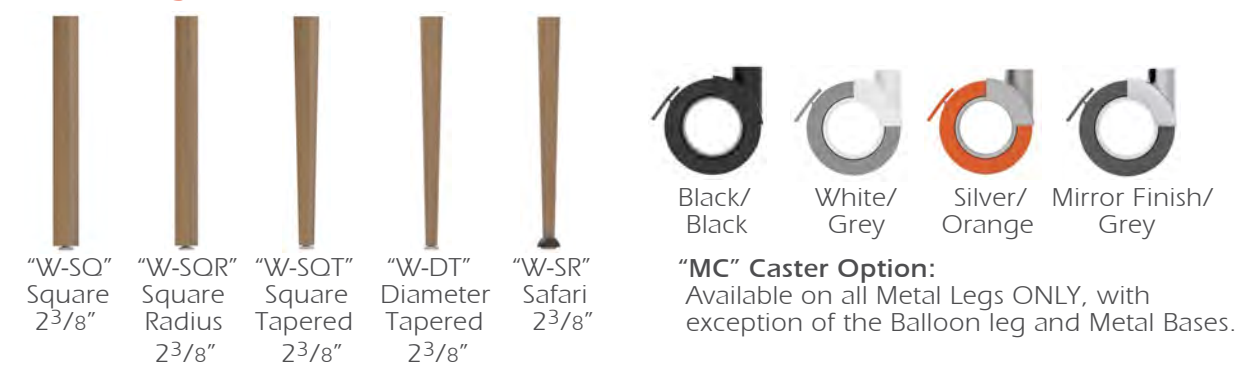

KREATIONS

MODEL NUMBER	PRODUCT	WIDTH	DEPTH	HEIGHT	PRICE	DESCRIPTION
	Rectangle Table, 84" Width, 48" Depth	84"	48"	29"		Each Table Top is constructed using a 1 1/8" thick top with a Plastic Laminate top surface.
	DROPPED CHAMFERED Edge;					All Metal legs are coated electrostatically with an epoxy powder coat paint.
*Shown Above: TB-8442-DCH-M-D	with WOOD Leg Option:	84"	48"	29"		NOTES: * Table heights of 25" (children), 27" (youth), and 32" (wheelchair) are available by request. * Color of Metal Paint must be specified at the time of order. * Caster Leg options are recommended for Reading/Multipurpose Tables options and not meant to be used for stationary computer workstations. * For all tables with casters legs, only 2 legs will have casters, and the other legs will have levelers. This will create a "wheelbarrow" style of table which will ensure ease of mobility. * Color of the Caster Option must be specified at the time of order. * For the Flip OR Fold Leg option, one T base leg comes with 2 hidden casters as shown in the image below
	TB-8448-DCH-W-SQ Square				\$ 1,540	
	TB-8448-DCH-W-SQR Square Radius				\$ 1,540	
	TB-8448-DCH-W-SQT Square Tapered				\$ 1,690	
	TB-8448-DCH-W-DT Diameter Tapered				\$ 1,820	
	TB-8448-DCH-W-SR Safari				\$ 1,825	
	with METAL Leg Option:	84"	48"	29"		
*Rectangle Table Shape	TB-8448-DCH-M-SQ Square				\$ 1,475	
	TB-8448-DCH-M-SS Square & Stem				\$ 1,895	
	TB-8448-DCH-M-D Diameter				\$ 1,475	
	TB-8448-DCH-M-DS Diameter & Stem				\$ 1,895	
	TB-8448-DCH-M-BO Balloon				\$ 1,575	
	TB-8448-DCH-MC-SQ Square with Casters				\$ 1,695	
	TB-8448-DCH-MC-SS Square & Stem with Casters				\$ 2,125	
	TB-8448-DCH-MC-D Diameter with Casters				\$ 1,695	
	TB-8448-DCH-MC-DS Diameter & Stem with Casters				\$ 2,125	
	TB-8448-DCH-FL Flip Leg (for Nesting Tables)				\$ 2,360	
	TB-8448-DCH-FD Folding Leg				\$ 2,360	

Edge Option:



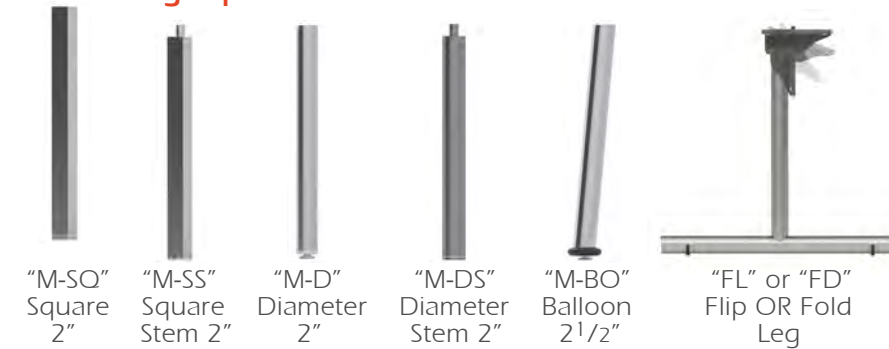

Metal Leg Options:

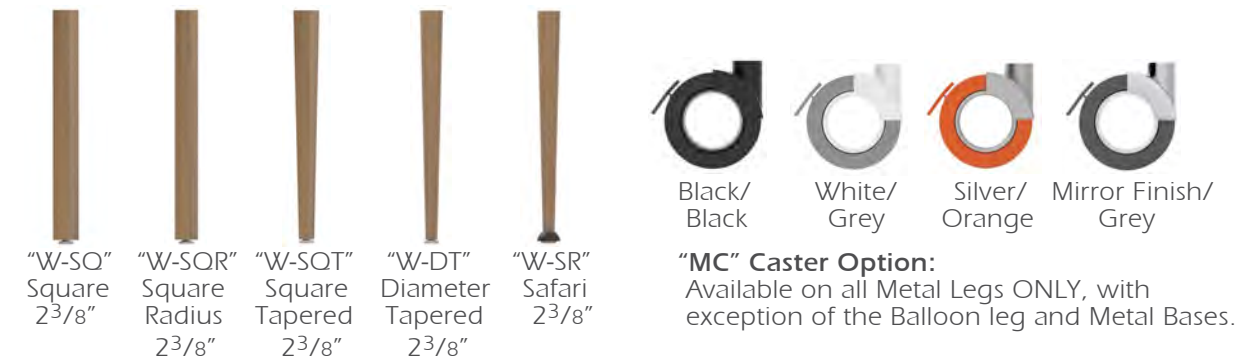

Wood Leg Options:



KREATIONS

MODEL NUMBER	PRODUCT	WIDTH	DEPTH	HEIGHT	PRICE	DESCRIPTION	
 <p>*Shown Above: TB-8442-AL-M-D</p>  <p>*Rectangle Table Shape</p>	Rectangle Table, 84" Width, 36" Depth	84"	36"	29"		Each Table Top is constructed using a 1 1/8" thick top with a Plastic Laminate top surface.	
		ALUMINUM Edge;					All Metal legs are coated electrostatically with an epoxy powder coat paint.
		with WOOD Leg Option:	84"	36"	29"		NOTES:
	TB-8436-AL-W-SQ	Square				\$ 1,220	* Table heights of 25" (children), 27" (youth), and 32" (wheelchair) are available by request.
	TB-8436-AL-W-SQR	Square Radius				\$ 1,220	* Color of Metal Paint must be specified at the time of order.
	TB-8436-AL-W-SQT	Square Tapered				\$ 1,370	* Caster Leg options are recommended for Reading/Multipurpose Tables options and not meant to be used for stationary computer workstations.
	TB-8436-AL-W-DT	Diameter Tapered				\$ 1,500	* For all tables with casters legs, only 2 legs will have casters, and the other legs will have levelers. This will create a "wheelbarrow" style of table which will ensure ease of mobility.
	TB-8436-AL-W-SR	Safari				\$ 1,505	* Color of the Caster Option must be specified at the time of order.
		with METAL Leg Option:	84"	36"	29"		* For the Flip OR Fold Leg option, one T base leg comes with 2 hidden casters as shown in the image below
	TB-8436-AL-M-SQ	Square				\$ 1,580	
	TB-8436-AL-M-SS	Square & Stem				\$ 1,155	
	TB-8436-AL-M-D	Diameter				\$ 1,580	
	TB-8436-AL-M-DS	Diameter & Stem				\$ 1,255	
	TB-8436-AL-M-BO	Balloon				\$ 1,380	
	TB-8436-AL-MC-SQ	Square with Casters				\$ 1,805	
	TB-8436-AL-MC-SS	Square & Stem with Casters				\$ 1,380	
	TB-8436-AL-MC-D	Diameter with Casters				\$ 1,805	
TB-8436-AL-MC-DS	Diameter & Stem with Casters				\$ 2,015		
TB-8436-AL-FL	Flip Leg (for Nesting Tables)				\$ 2,015		
TB-8436-AL-FD	Folding Leg						
	Rectangle Table, 84" Width, 42" Depth	84"	42"	29"			
	ALUMINUM Edge;						
	with WOOD Leg Option:	84"	42"	29"			
TB-8442-AL-W-SQ	Square				\$ 1,270		
TB-8442-AL-W-SQR	Square Radius				\$ 1,270		
TB-8442-AL-W-SQT	Square Tapered				\$ 1,425		
TB-8442-AL-W-DT	Diameter Tapered				\$ 1,555		
TB-8442-AL-W-SR	Safari				\$ 1,560		
	with METAL Leg Option:	84"	42"	29"			
TB-8442-AL-M-SQ	Square				\$ 1,205		
TB-8442-AL-M-SS	Square & Stem				\$ 1,635		
TB-8442-AL-M-D	Diameter				\$ 1,205		
TB-8442-AL-M-DS	Diameter & Stem				\$ 1,635		
TB-8442-AL-M-BO	Balloon				\$ 1,310		
TB-8442-AL-MC-SQ	Square with Casters				\$ 1,435		
TB-8442-AL-MC-SS	Square & Stem with Casters				\$ 1,855		
TB-8442-AL-MC-D	Diameter with Casters				\$ 1,435		
TB-8442-AL-MC-DS	Diameter & Stem with Casters				\$ 1,855		
TB-8442-AL-FL	Flip Leg (for Nesting Tables)				\$ 2,090		
TB-8442-AL-FD	Folding Leg				\$ 2,090		

Edge Option:



3mm Aluminum Edge *All table corners will be given a 6-inch radius for this edge option.

Metal Leg Options:

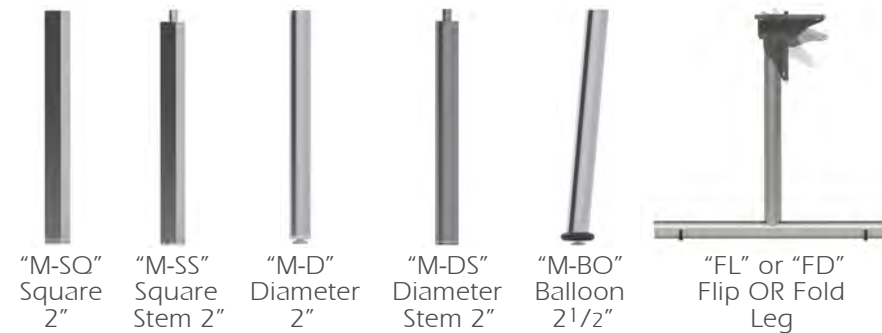

Wood Leg Options:

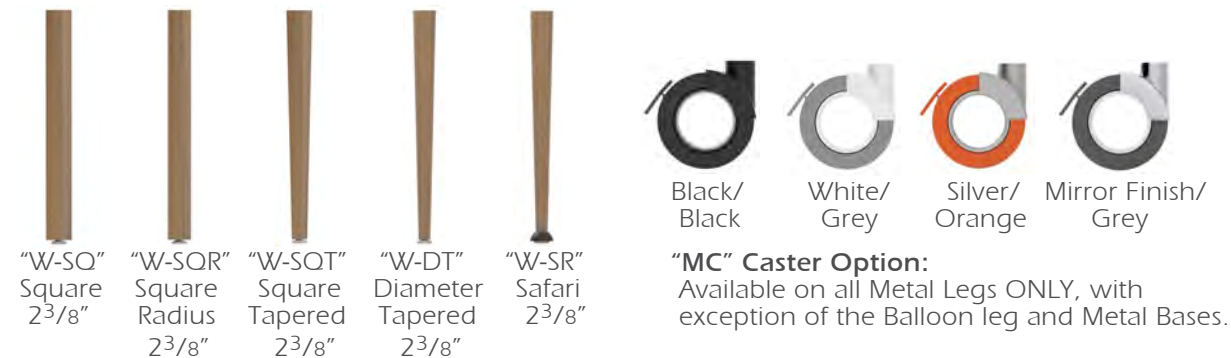

"MC" Caster Option:
Available on all Metal Legs ONLY, with exception of the Balloon leg and Metal Bases.

KREATIONS

MODEL NUMBER	PRODUCT	WIDTH	DEPTH	HEIGHT	PRICE	DESCRIPTION
	Rectangle Table, 84" Width, 48" Depth	84"	48"	29"		Each Table Top is constructed using a 1 1/8" thick top with a Plastic Laminate top surface.
	ALUMINUM Edge:					All Metal legs are coated electrostatically with an epoxy powder coat paint.
	with WOOD Leg Option:	84"	48"	29"		NOTES: * Table heights of 25" (children), 27" (youth), and 32" (wheelchair) are available by request. * Color of Metal Paint must be specified at the time of order. * Caster Leg options are recommended for Reading/Multipurpose Tables options and not meant to be used for stationary computer workstations. * For all tables with casters legs, only 2 legs will have casters, and the other legs will have levelers. This will create a "wheelbarrow" style of table which will ensure ease of mobility. * Color of the Caster Option must be specified at the time of order. * For the Flip OR Fold Leg option, one T base leg comes with 2 hidden casters as shown in the image below
	TB-8448-AL-W-SQ Square				\$ 1,330	
	TB-8448-AL-W-SQR Square Radius				\$ 1,330	
	TB-8448-AL-W-SQT Square Tapered				\$ 1,480	
	TB-8448-AL-W-DT Diameter Tapered				\$ 1,610	
	TB-8448-AL-W-SR Safari				\$ 1,615	
	with METAL Leg Option:	84"	48"	29"		
	TB-8448-AL-M-SQ Square				\$ 1,265	
	TB-8448-AL-M-SS Square & Stem				\$ 1,685	
	TB-8448-AL-M-D Diameter				\$ 1,265	
	TB-8448-AL-M-DS Diameter & Stem				\$ 1,685	
	TB-8448-AL-M-BO Balloon				\$ 1,365	
	TB-8448-AL-MC-SQ Square with Casters				\$ 1,490	
	TB-8448-AL-MC-SS Square & Stem with Casters				\$ 1,915	
	TB-8448-AL-MC-D Diameter with Casters				\$ 1,490	
	TB-8448-AL-MC-DS Diameter & Stem with Casters				\$ 1,915	
	TB-8448-AL-FL Flip Leg (for Nesting Tables)				\$ 2,125	
	TB-8448-AL-FD Folding Leg				\$ 2,125	

*Shown Above:
TB-8442-AL-M-D



*Rectangle Table Shape

Edge Option:



3mm Aluminum Edge *All table corners will be given a 6-inch radius for this edge option.

Metal Leg Options:

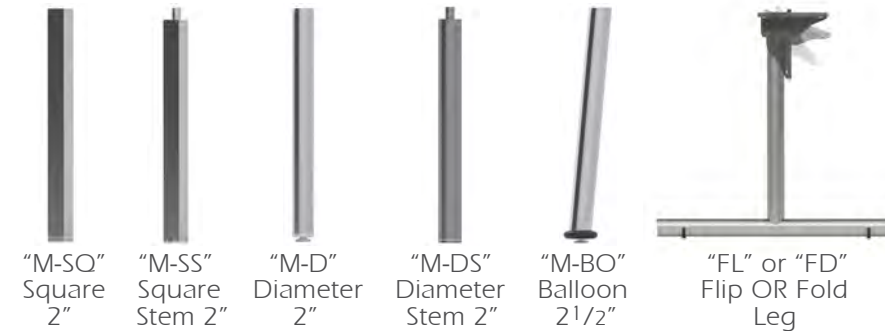

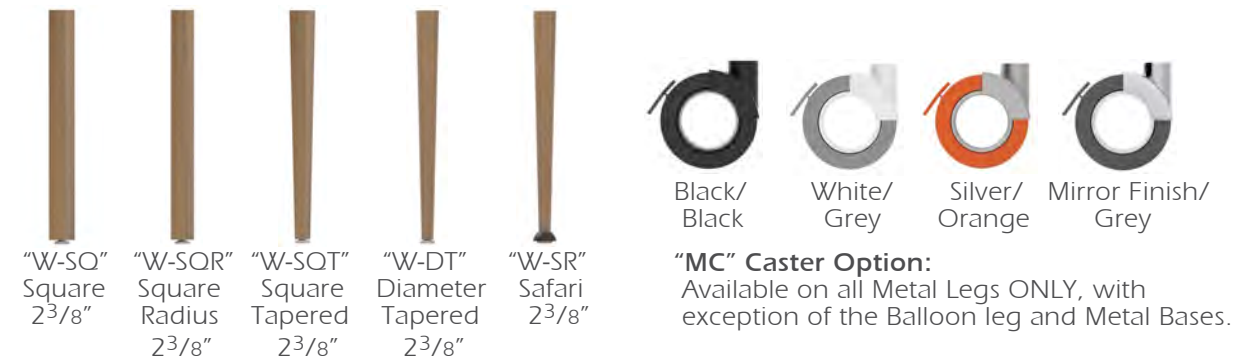

Wood Leg Options:



"MC" Caster Option:
Available on all Metal Legs ONLY, with exception of the Balloon leg and Metal Bases.

KREATIONS

MODEL NUMBER	PRODUCT	WIDTH	DEPTH	HEIGHT	PRICE	DESCRIPTION
 <p>*Shown Above: TB-9642-AC-M-D</p>  <p>*Rectangle Table Shape</p>	Rectangle Table, 96" Width, 36" Depth	96"	36"	29"		Each Table Top is constructed using a 1" thick top with a Plastic Laminate top surface.
	ACRYLIC Edge;					All Metal legs are coated electrostatically with an epoxy powder coat paint.
	with WOOD Leg Option:	96"	36"	29"		NOTES:
	TB-9636-AC-W-SQ	Square			\$ 1,150	* Table heights of 25" (children), 27" (youth), and 32" (wheelchair) are available by request.
	TB-9636-AC-W-SQR	Square Radius			\$ 1,150	* Color of Metal Paint must be specified at the time of order.
	TB-9636-AC-W-SQT	Square Tapered			\$ 1,300	* Caster Leg options are recommended for Reading/Multipurpose Tables options and not meant to be used for stationary computer workstations.
	TB-9636-AC-W-DT	Diameter Tapered			\$ 1,430	* For all tables with casters legs, only 2 legs will have casters, and the other legs will have levelers. This will create a "wheelbarrow" style of table which will ensure ease of mobility.
	TB-9636-AC-W-SR	Safari			\$ 1,440	* Color of the Caster Option must be specified at the time of order.
	with METAL Leg Option:	96"	36"	29"		* For the Flip OR Fold Leg option, one T base leg comes with 2 hidden casters as shown in the image below.
	TB-9636-AC-M-SQ	Square			\$ 1,085	
TB-9636-AC-M-SS	Square & Stem			\$ 1,505		
TB-9636-AC-M-D	Diameter			\$ 1,085		
TB-9636-AC-M-DS	Diameter & Stem			\$ 1,505		
TB-9636-AC-M-BO	Balloon			\$ 1,190		
TB-9636-AC-MC-SQ	Square with Casters			\$ 1,310		
TB-9636-AC-MC-SS	Square & Stem with Casters			\$ 1,735		
TB-9636-AC-MC-D	Diameter with Casters			\$ 1,310		
TB-9636-AC-MC-DS	Diameter & Stem with Casters			\$ 1,735		
TB-9636-AC-FL	Flip Leg (for Nesting Tables)			\$ 1,950		
TB-9636-AC-FD	Folding Leg			\$ 1,950		
	Rectangle Table, 96" Width, 42" Depth	96"	42"	29"		
	ACRYLIC Edge;					
	with WOOD Leg Option:	96"	42"	29"		
TB-9642-AC-W-SQ	Square			\$ 1,205		
TB-9642-AC-W-SQR	Square Radius			\$ 1,205		
TB-9642-AC-W-SQT	Square Tapered			\$ 1,355		
TB-9642-AC-W-DT	Diameter Tapered			\$ 1,485		
TB-9642-AC-W-SR	Safari			\$ 1,490		
	with METAL Leg Option:	96"	42"	29"		
TB-9642-AC-M-SQ	Square			\$ 1,140		
TB-9642-AC-M-SS	Square & Stem			\$ 1,565		
TB-9642-AC-M-D	Diameter			\$ 1,140		
TB-9642-AC-M-DS	Diameter & Stem			\$ 1,565		
TB-9642-AC-M-BO	Balloon			\$ 1,240		
TB-9642-AC-MC-SQ	Square with Casters			\$ 1,365		
TB-9642-AC-MC-SS	Square & Stem with Casters			\$ 1,790		
TB-9642-AC-MC-D	Diameter with Casters			\$ 1,365		
TB-9642-AC-MC-DS	Diameter & Stem with Casters			\$ 1,790		
TB-9642-AC-FL	Flip Leg (for Nesting Tables)			\$ 2,025		
TB-9642-AC-FD	Folding Leg			\$ 2,025		

Edge Option:

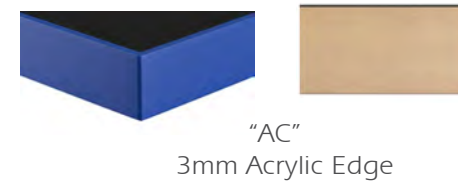

Metal Leg Options:

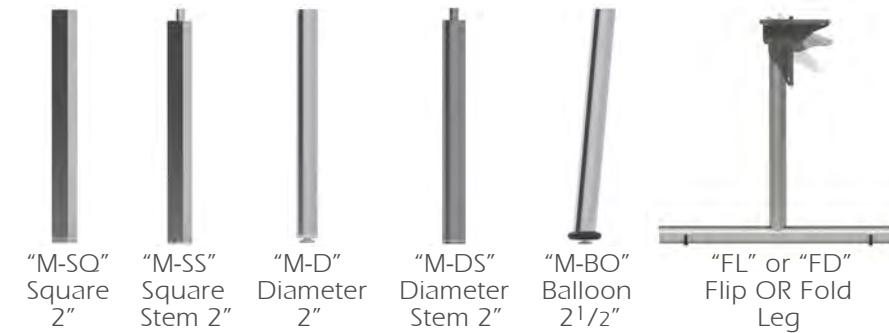

Wood Leg Options:

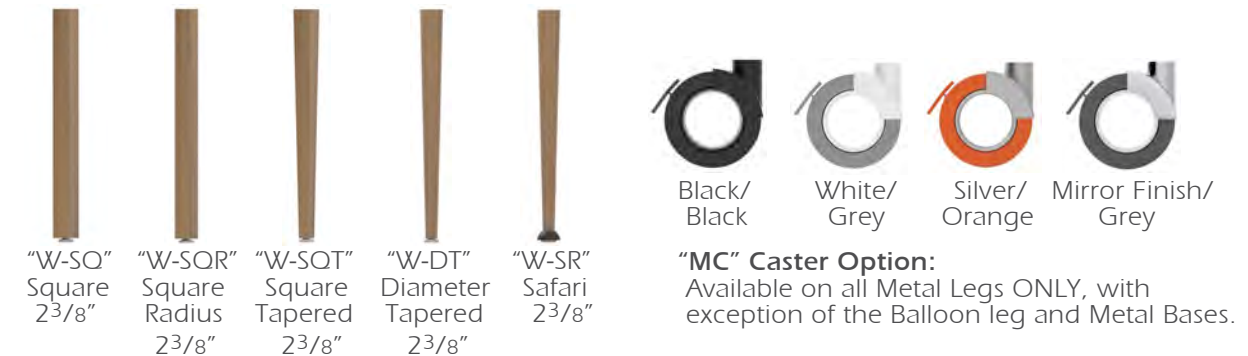

KREATIONS

MODEL NUMBER	PRODUCT	WIDTH	DEPTH	HEIGHT	PRICE	DESCRIPTION	
 <p>*Shown Above: TB-9642-AC-M-D</p>  <p>*Rectangle Table Shape</p>	Rectangle Table, 96" Width, 48" Depth	96"	48"	29"		Each Table Top is constructed using a 1" thick top with a Plastic Laminate top surface.	
	ACRYLIC Edge;					All Metal legs are coated electrostatically with an epoxy powder coat paint.	
	with WOOD Leg Option:					NOTES:	
	TB-9648-AC-W-SQ	Square	96"	48"	29"	\$ 1,335	* Table heights of 25" (children), 27" (youth), and 32" (wheelchair) are available by request.
	TB-9648-AC-W-SQR	Square Radius				\$ 1,335	* Color of Metal Paint must be specified at the time of order.
	TB-9648-AC-W-SQT	Square Tapered				\$ 1,490	* Caster Leg options are recommended for Reading/Multipurpose Tables options and not meant to be used for stationary computer workstations.
	TB-9648-AC-W-DT	Diameter Tapered				\$ 1,615	* For all tables with casters legs, only 2 legs will have casters, and the other legs will have levelers. This will create a "wheelbarrow" style of table which will ensure ease of mobility.
	TB-9648-AC-W-SR	Safari				\$ 1,625	* Color of the Caster Option must be specified at the time of order.
	with METAL Leg Option:						* For the Flip OR Fold Leg option, one T base leg comes with 2 hidden casters as shown in the image below.
	TB-9648-AC-M-SQ	Square	96"	48"	29"	\$ 1,270	
TB-9648-AC-M-SS	Square & Stem				\$ 1,695		
TB-9648-AC-M-D	Diameter				\$ 1,270		
TB-9648-AC-M-DS	Diameter & Stem				\$ 1,695		
TB-9648-AC-M-BO	Balloon				\$ 1,375		
TB-9648-AC-MC-SQ	Square with Casters				\$ 1,495		
TB-9648-AC-MC-SS	Square & Stem with Casters				\$ 1,920		
TB-9648-AC-MC-D	Diameter with Casters				\$ 1,495		
TB-9648-AC-MC-DS	Diameter & Stem with Casters				\$ 1,920		
TB-9648-AC-FL	Flip Leg (for Nesting Tables)				\$ 2,080		
TB-9648-AC-FD	Folding Leg				\$ 2,080		

Edge Option:

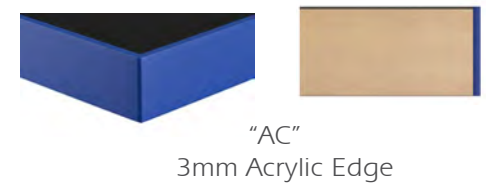

Metal Leg Options:

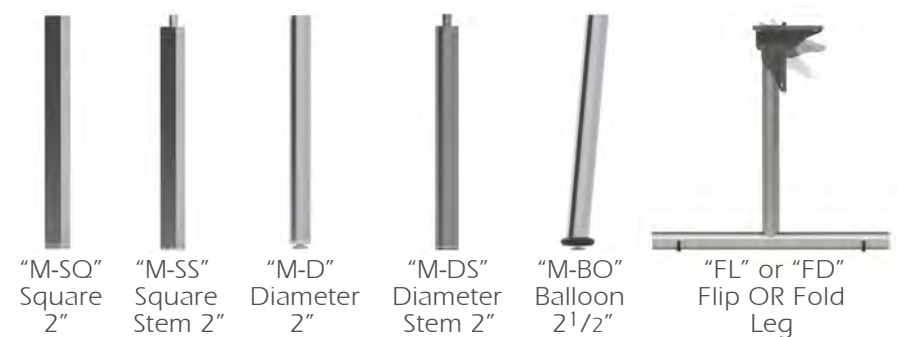



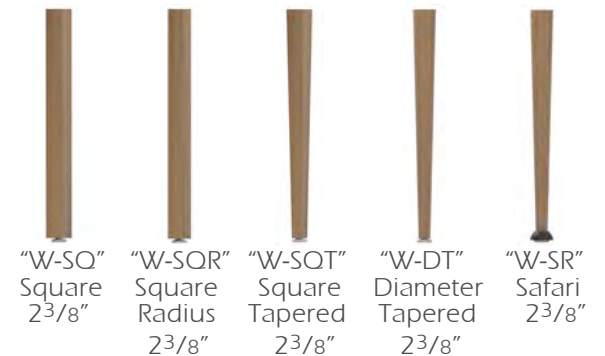



Wood Leg Options:

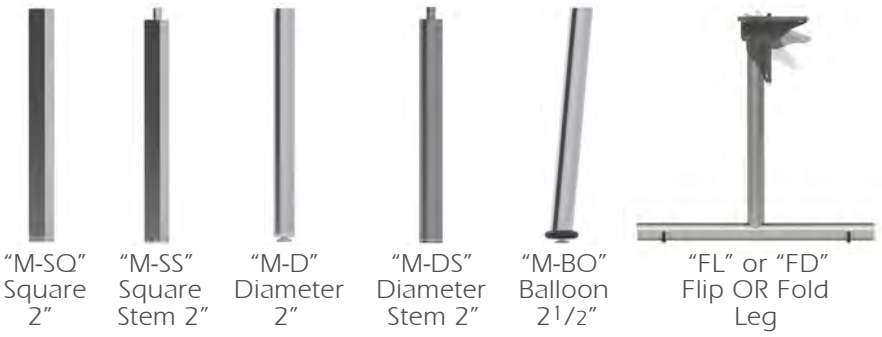
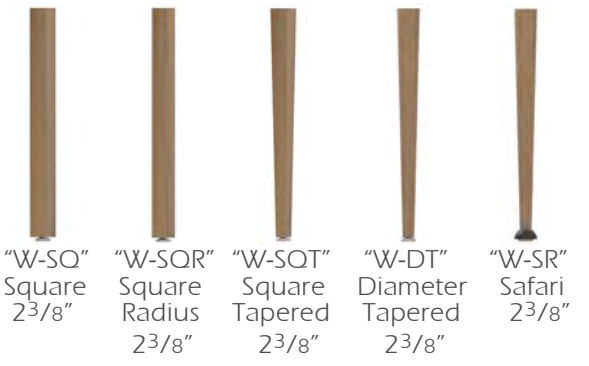

"MC" Caster Option:
Available on all Metal Legs ONLY, with exception of the Balloon leg and Metal Bases.

KREATIONS

MODEL NUMBER	PRODUCT	WIDTH	DEPTH	HEIGHT	PRICE	DESCRIPTION	
 <p>*Shown Above: TB-9642-SQ-M-D</p>  <p>*Rectangle Table Shape</p>	Rectangle Table, 96" Width, 36" Depth	96"	36"	29"		<p>Each Table Top is constructed using a 1 1/8" thick top with a Plastic Laminate top surface.</p> <p>All Metal legs are coated electrostatically with an epoxy powder coat paint.</p> <p>NOTES: * Table heights of 25" (children), 27" (youth), and 32" (wheelchair) are available by request. * Color of Metal Paint must be specified at the time of order. * Caster Leg options are recommended for Reading/Multipurpose Tables options and not meant to be used for stationary computer workstations. * For all tables with casters legs, only 2 legs will have casters, and the other legs will have levelers. This will create a "wheelbarrow" style of table which will ensure ease of mobility. * Color of the Caster Option must be specified at the time of order. * For the Flip OR Fold Leg option, one T base leg comes with 2 hidden casters as shown in the image below.</p> <p>Edge Option:</p>  <p>"SQ" 1/4" Square Edge</p> <p>Metal Leg Options:</p>  <p>"M-SQ" Square 2" "M-SS" Square Stem 2" "M-D" Diameter 2" "M-DS" Diameter Stem 2" "M-BO" Balloon 2 1/2" "FL" or "FD" Flip OR Fold Leg</p> <p>Wood Leg Options:</p>  <p>"W-SQ" Square 2 3/8" "W-SOR" Square Radius 2 3/8" "W-SQT" Square Tapered 2 3/8" "W-DT" Diameter Tapered 2 3/8" "W-SR" Safari 2 3/8"</p> <p>"MC" Caster Option: Available on all Metal Legs ONLY, with exception of the Balloon leg and Metal Bases.</p>  <p>Black/Black White/Grey Silver/Orange Mirror Finish/Grey</p> <p>KREATIONS</p>	
	TB-9636-SQ-W-SQ	SQUARE Edge;					
	TB-9636-SQ-W-SQR	with WOOD Leg Option:	96"	36"	29"		\$ 1,360
	TB-9636-SQ-W-SQT	Square					\$ 1,360
	TB-9636-SQ-W-DT	Square Radius					\$ 1,510
	TB-9636-SQ-W-DT	Square Tapered					\$ 1,640
	TB-9636-SQ-W-SR	Diameter Tapered					\$ 1,650
	TB-9636-SQ-W-SR	Safari					
	TB-9636-SQ-M-SQ	with METAL Leg Option:	96"	36"	29"		\$ 1,295
	TB-9636-SQ-M-SS	Square					\$ 1,715
	TB-9636-SQ-M-D	Square & Stem					\$ 1,295
	TB-9636-SQ-M-DS	Diameter					\$ 1,715
	TB-9636-SQ-M-BO	Diameter & Stem					\$ 1,395
	TB-9636-SQ-MC-SQ	Balloon					\$ 1,520
	TB-9636-SQ-MC-SS	Square with Casters					\$ 1,945
	TB-9636-SQ-MC-D	Square & Stem with Casters					\$ 1,520
TB-9636-SQ-MC-DS	Diameter with Casters				\$ 1,945		
TB-9636-SQ-FL	Diameter & Stem with Casters				\$ 2,155		
TB-9636-SQ-FL	Flip Leg (for Nesting Tables)				\$ 2,155		
TB-9636-SQ-FD	Folding Leg						
	Rectangle Table, 96" Width, 42" Depth	96"	42"	29"			
	SQUARE Edge;						
	with WOOD Leg Option:	96"	42"	29"	\$ 1,565		
TB-9642-SQ-W-SQ	Square				\$ 1,565		
TB-9642-SQ-W-SQR	Square Radius				\$ 1,715		
TB-9642-SQ-W-SQT	Square Tapered				\$ 1,845		
TB-9642-SQ-W-DT	Diameter Tapered				\$ 1,855		
TB-9642-SQ-W-SR	Safari						
	with METAL Leg Option:	96"	42"	29"	\$ 1,500		
TB-9642-SQ-M-SQ	Square				\$ 1,925		
TB-9642-SQ-M-SS	Square & Stem				\$ 1,500		
TB-9642-SQ-M-D	Diameter				\$ 1,925		
TB-9642-SQ-M-DS	Diameter & Stem				\$ 1,600		
TB-9642-SQ-M-BO	Balloon				\$ 1,730		
TB-9642-SQ-MC-SQ	Square with Casters				\$ 2,150		
TB-9642-SQ-MC-SS	Square & Stem with Casters				\$ 1,730		
TB-9642-SQ-MC-D	Diameter with Casters				\$ 2,150		
TB-9642-SQ-MC-DS	Diameter & Stem with Casters				\$ 2,385		
TB-9642-SQ-FL	Flip Leg (for Nesting Tables)				\$ 2,385		
TB-9642-SQ-FD	Folding Leg						

MODEL NUMBER	PRODUCT	WIDTH	DEPTH	HEIGHT	PRICE	DESCRIPTION
 *Shown Above: TB-9642-SQ-M-D	Rectangle Table, 96" Width, 48" Depth	96"	48"	29"		Each Table Top is constructed using a 1 1/8" thick top with a Plastic Laminate top surface.
	SQUARE Edge;					All Metal legs are coated electrostatically with an epoxy powder coat paint.
 *Rectangle Table Shape	with WOOD Leg Option:	96"	48"	29"		NOTES: * Table heights of 25" (children), 27" (youth), and 32" (wheelchair) are available by request. * Color of Metal Paint must be specified at the time of order. * Caster Leg options are recommended for Reading/Multipurpose Tables options and not meant to be used for stationary computer workstations. * For all tables with casters legs, only 2 legs will have casters, and the other legs will have levelers. This will create a "wheelbarrow" style of table which will ensure ease of mobility. * Color of the Caster Option must be specified at the time of order. * For the Flip OR Fold Leg option, one T base leg comes with 2 hidden casters as shown in the image below.
	TB-9648-SQ-W-SQ Square				\$ 1,630	
	TB-9648-SQ-W-SQR Square Radius				\$ 1,630	
	TB-9648-SQ-W-SQT Square Tapered				\$ 1,780	
	TB-9648-SQ-W-DT Diameter Tapered				\$ 1,910	
	TB-9648-SQ-W-SR Safari				\$ 1,920	
	with METAL Leg Option:	96"	48"	29"		
	TB-9648-SQ-M-SQ Square				\$ 1,565	
	TB-9648-SQ-M-SS Square & Stem				\$ 1,990	
	TB-9648-SQ-M-D Diameter				\$ 1,565	
TB-9648-SQ-M-DS Diameter & Stem				\$ 1,990		
TB-9648-SQ-M-BO Balloon				\$ 1,665		
TB-9648-SQ-MC-SQ Square with Casters				\$ 1,790		
TB-9648-SQ-MC-SS Square & Stem with Casters				\$ 2,215		
TB-9648-SQ-MC-D Diameter with Casters				\$ 1,790		
TB-9648-SQ-MC-DS Diameter & Stem with Casters				\$ 2,215		
TB-9648-SQ-FL Flip Leg (for Nesting Tables)				\$ 2,450		
TB-9648-SQ-FD Folding Leg				\$ 2,450		

Edge Option:





Metal Leg Options:

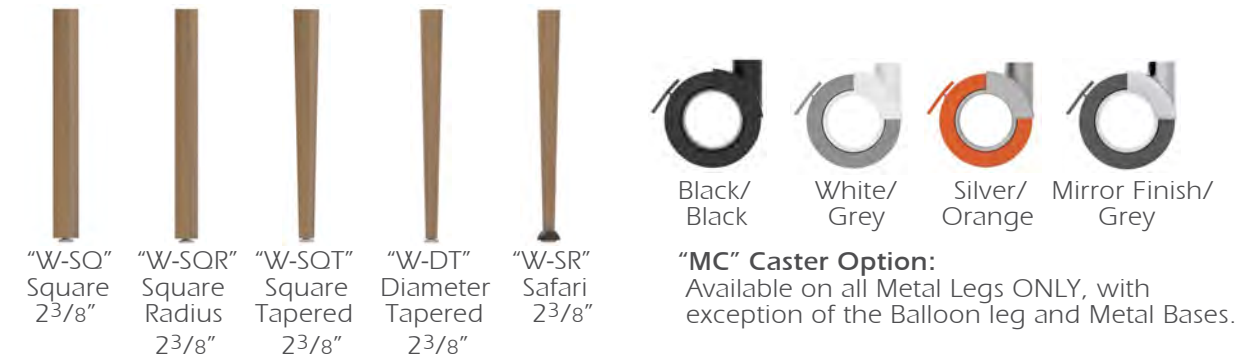

Wood Leg Options:



KREATIONS

MODEL NUMBER	PRODUCT	WIDTH	DEPTH	HEIGHT	PRICE	DESCRIPTION	
 <p>*Shown Above: TB-9642-DSQ-M-D</p>  <p>*Rectangle Table Shape</p>	Rectangle Table, 96" Width, 36" Depth	96"	36"	29"		Each Table Top is constructed using a 1 1/8" thick top with a Plastic Laminate top surface.	
		DROPPED SQUARE Edge;					All Metal legs are coated electrostatically with an epoxy powder coat paint.
		with WOOD Leg Option:	96"	36"	29"		NOTES:
	TB-9636-DSQ-W-SQ	Square				\$ 1,475	* Table heights of 25" (children), 27" (youth), and 32" (wheelchair) are available by request.
	TB-9636-DSQ-W-SQR	Square Radius				\$ 1,475	* Color of Metal Paint must be specified at the time of order.
	TB-9636-DSQ-W-SQT	Square Tapered				\$ 1,625	* Caster Leg options are recommended for Reading/Multipurpose Tables options and not meant to be used for stationary computer workstations.
	TB-9636-DSQ-W-DT	Diameter Tapered				\$ 1,755	* For all tables with casters legs, only 2 legs will have casters, and the other legs will have levelers. This will create a "wheelbarrow" style of table which will ensure ease of mobility.
	TB-9636-DSQ-W-SR	Safari				\$ 1,760	* Color of the Caster Option must be specified at the time of order.
		with METAL Leg Option:	96"	36"	29"		* For the Flip OR Fold Leg option, one T base leg comes with 2 hidden casters as shown in the image below
	TB-9636-DSQ-M-SQ	Square				\$ 1,410	
	TB-9636-DSQ-M-SS	Square & Stem				\$ 1,830	
	TB-9636-DSQ-M-D	Diameter				\$ 1,410	
	TB-9636-DSQ-M-DS	Diameter & Stem				\$ 1,830	
	TB-9636-DSQ-M-BO	Balloon				\$ 1,510	
	TB-9636-DSQ-MC-SQ	Square with Casters				\$ 1,635	
	TB-9636-DSQ-MC-SS	Square & Stem with Casters				\$ 2,060	
	TB-9636-DSQ-MC-D	Diameter with Casters				\$ 1,635	
TB-9636-DSQ-MC-DS	Diameter & Stem with Casters				\$ 2,060		
TB-9636-DSQ-FL	Flip Leg (for Nesting Tables)				\$ 2,270		
TB-9636-DSQ-FD	Folding Leg				\$ 2,270		
	Rectangle Table, 96" Width, 42" Depth	96"	42"	29"			
	DROPPED SQUARE Edge;						
	with WOOD Leg Option:	96"	42"	29"			
TB-9642-DSQ-W-SQ	Square				\$ 1,685		
TB-9642-DSQ-W-SQR	Square Radius				\$ 1,685		
TB-9642-DSQ-W-SQT	Square Tapered				\$ 1,840		
TB-9642-DSQ-W-DT	Diameter Tapered				\$ 1,965		
TB-9642-DSQ-W-SR	Safari				\$ 1,970		
	with METAL Leg Option:	96"	42"	29"			
TB-9642-DSQ-M-SQ	Square				\$ 1,620		
TB-9642-DSQ-M-SS	Square & Stem				\$ 2,045		
TB-9642-DSQ-M-D	Diameter				\$ 1,620		
TB-9642-DSQ-M-DS	Diameter & Stem				\$ 2,045		
TB-9642-DSQ-M-BO	Balloon				\$ 1,725		
TB-9642-DSQ-MC-SQ	Square with Casters				\$ 1,845		
TB-9642-DSQ-MC-SS	Square & Stem with Casters				\$ 2,270		
TB-9642-DSQ-MC-D	Diameter with Casters				\$ 1,845		
TB-9642-DSQ-MC-DS	Diameter & Stem with Casters				\$ 2,270		
TB-9642-DSQ-FL	Flip Leg (for Nesting Tables)				\$ 2,505		
TB-9642-DSQ-FD	Folding Leg				\$ 2,505		

Edge Option:



Metal Leg Options:

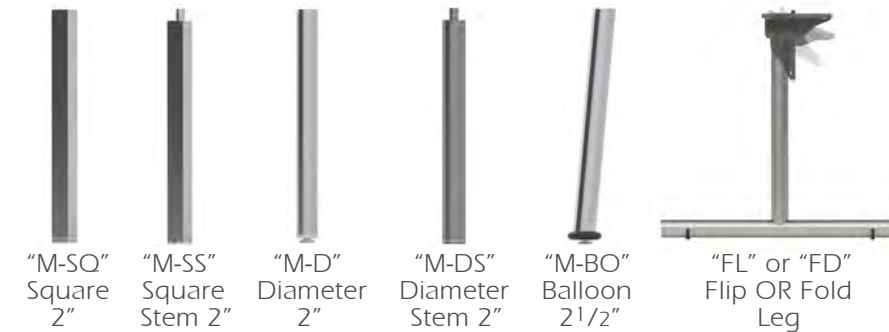

Wood Leg Options:

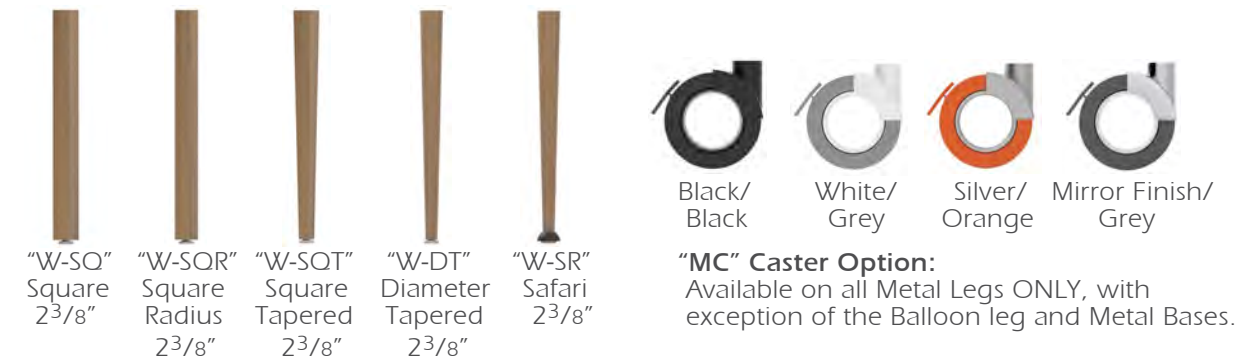

KREATIONS

MODEL NUMBER	PRODUCT	WIDTH	DEPTH	HEIGHT	PRICE	DESCRIPTION
	Rectangle Table, 96" Width, 48" Depth	96"	48"	29"		Each Table Top is constructed using a 1 1/8" thick top with a Plastic Laminate top surface.
	DROPPED SQUARE Edge;					All Metal legs are coated electrostatically with an epoxy powder coat paint.
	with WOOD Leg Option:	96"	48"	29"		NOTES: * Table heights of 25" (children), 27" (youth), and 32" (wheelchair) are available by request. * Color of Metal Paint must be specified at the time of order. * Caster Leg options are recommended for Reading/Multipurpose Tables options and not meant to be used for stationary computer workstations. * For all tables with casters legs, only 2 legs will have casters, and the other legs will have levelers. This will create a "wheelbarrow" style of table which will ensure ease of mobility. * Color of the Caster Option must be specified at the time of order. * For the Flip OR Fold Leg option, one T base leg comes with 2 hidden casters as shown in the image below
	TB-9648-DSQ-W-SQ Square				\$ 1,755	
	TB-9648-DSQ-W-SQR Square Radius				\$ 1,755	
	TB-9648-DSQ-W-SQT Square Tapered				\$ 1,905	
	TB-9648-DSQ-W-DT Diameter Tapered				\$ 2,035	
	TB-9648-DSQ-W-SR Safari				\$ 1,360	
	with METAL Leg Option:	96"	48"	29"		
	TB-9648-DSQ-M-SQ Square				\$ 1,690	
	TB-9648-DSQ-M-SS Square & Stem				\$ 2,115	
	TB-9648-DSQ-M-D Diameter				\$ 1,690	
	TB-9648-DSQ-M-DS Diameter & Stem				\$ 2,115	
	TB-9648-DSQ-M-BO Balloon				\$ 1,790	
	TB-9648-DSQ-MC-SQ Square with Casters				\$ 1,920	
	TB-9648-DSQ-MC-SS Square & Stem with Casters				\$ 2,340	
	TB-9648-DSQ-MC-D Diameter with Casters				\$ 1,920	
	TB-9648-DSQ-MC-DS Diameter & Stem with Casters				\$ 2,340	
	TB-9648-DSQ-FL Flip Leg (for Nesting Tables)				\$ 2,575	
	TB-9648-DSQ-FD Folding Leg				\$ 2,575	

*Shown Above:
TB-9642-DSQ-M-D



*Rectangle Table Shape

Edge Option:



Metal Leg Options:

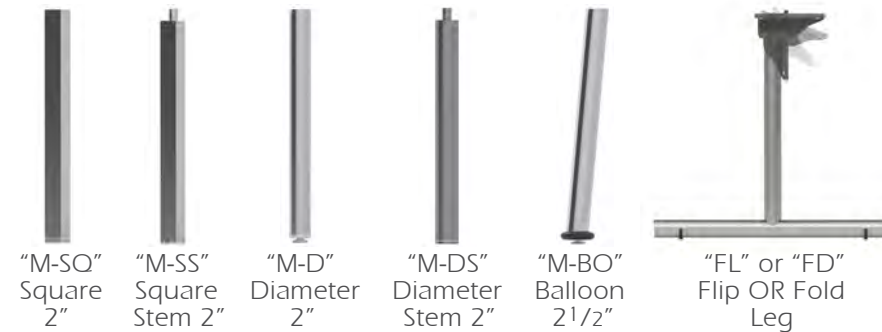



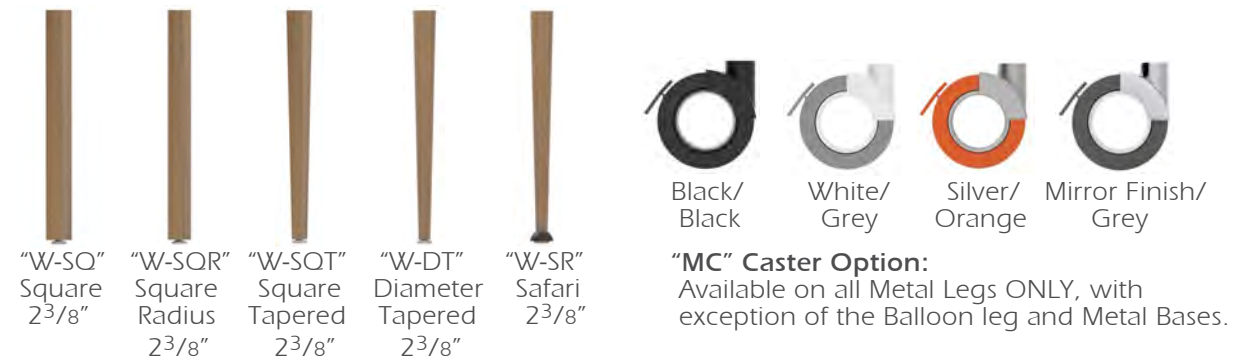



Wood Leg Options:



"MC" Caster Option:
Available on all Metal Legs ONLY, with exception of the Balloon leg and Metal Bases.

KREATIONS

MODEL NUMBER	PRODUCT	WIDTH	DEPTH	HEIGHT	PRICE	DESCRIPTION
 <p>*Shown Above: TB-9642-DBN-M-D</p>  <p>*Rectangle Table Shape</p>	Rectangle Table, 96" Width, 36" Depth DROPPED BULLNOSE Edge; with WOOD Leg Option:	96"	36"	29"		Each Table Top is constructed using a 1 1/8" thick top with a Plastic Laminate top surface. All Metal legs are coated electrostatically with an epoxy powder coat paint. NOTES: * Table heights of 25" (children), 27" (youth), and 32" (wheelchair) are available by request. * Color of Metal Paint must be specified at the time of order. * Caster Leg options are recommended for Reading/Multipurpose Tables options and not meant to be used for stationary computer workstations. * For all tables with casters legs, only 2 legs will have casters, and the other legs will have levelers. This will create a "wheelbarrow" style of table which will ensure ease of mobility. * Color of the Caster Option must be specified at the time of order. * For the Flip OR Fold Leg option, one T base leg comes with 2 hidden casters as shown in the image below Edge Option:   "DBN" 3/4" Dropped Bullnoses Edge Metal Leg Options:  "M-SQ" Square 2" "M-SS" Square Stem 2" "M-D" Diameter 2" "M-DS" Diameter Stem 2" "M-BO" Balloon 2 1/2" "FL" or "FD" Flip OR Fold Leg Wood Leg Options:  "W-SQ" Square 2 3/8" "W-SQR" Square Radius 2 3/8" "W-SOT" Square Tapered 2 3/8" "W-DT" Diameter Tapered 2 3/8" "W-SR" Safari 2 3/8" "MC" Caster Option:  Available on all Metal Legs ONLY, with exception of the Balloon leg and Metal Bases.
	TB-9636-DBN-W-SQ	Square	\$ 1,485			
	TB-9636-DBN-W-SQR	Square Radius	\$ 1,485			
	TB-9636-DBN-W-SQT	Square Tapered	\$ 1,635			
	TB-9636-DBN-W-DT	Diameter Tapered	\$ 1,765			
	TB-9636-DBN-W-SR	Safari	\$ 1,775			
	with METAL Leg Option:					
	TB-9636-DBN-M-SQ	Square	\$ 1,420			
	TB-9636-DBN-M-SS	Square & Stem	\$ 1,840			
	TB-9636-DBN-M-D	Diameter	\$ 1,420			
	TB-9636-DBN-M-DS	Diameter & Stem	\$ 1,840			
	TB-9636-DBN-M-BO	Balloon	\$ 1,520			
	TB-9636-DBN-MC-SQ	Square with Casters	\$ 1,645			
	TB-9636-DBN-MC-SS	Square & Stem with Casters	\$ 2,070			
	TB-9636-DBN-MC-D	Diameter with Casters	\$ 1,645			
	TB-9636-DBN-MC-DS	Diameter & Stem with Casters	\$ 2,070			
	TB-9636-DBN-FL	Flip Leg (for Nesting Tables)	\$ 2,280			
TB-9636-DBN-FD	Folding Leg	\$ 2,280				
	Rectangle Table, 96" Width, 42" Depth DROPPED BULLNOSE Edge; with WOOD Leg Option:	96"	42"	29"		
	TB-9642-DBN-W-SQ	Square	\$ 1,695			
	TB-9642-DBN-W-SQR	Square Radius	\$ 1,695			
	TB-9642-DBN-W-SQT	Square Tapered	\$ 1,850			
	TB-9642-DBN-W-DT	Diameter Tapered	\$ 1,980			
	TB-9642-DBN-W-SR	Safari	\$ 1,985			
	with METAL Leg Option:					
	TB-9642-DBN-M-SQ	Square	\$ 1,635			
	TB-9642-DBN-M-SS	Square & Stem	\$ 2,055			
	TB-9642-DBN-M-D	Diameter	\$ 1,635			
	TB-9642-DBN-M-DS	Diameter & Stem	\$ 2,055			
	TB-9642-DBN-M-BO	Balloon	\$ 1,735			
	TB-9642-DBN-MC-SQ	Square with Casters	\$ 1,855			
	TB-9642-DBN-MC-SS	Square & Stem with Casters	\$ 2,280			
	TB-9642-DBN-MC-D	Diameter with Casters	\$ 1,855			
	TB-9642-DBN-MC-DS	Diameter & Stem with Casters	\$ 2,280			
	TB-9642-DBN-FL	Flip Leg (for Nesting Tables)	\$ 2,520			
TB-9642-DBN-FD	Folding Leg	\$ 2,520				

KREATIONS

MODEL NUMBER	PRODUCT	WIDTH	DEPTH	HEIGHT	PRICE	DESCRIPTION
	Rectangle Table, 96" Width, 48" Depth	96"	48"	29"		Each Table Top is constructed using a 1 1/8" thick top with a Plastic Laminate top surface.
	DROPPED BULLNOSE Edge;					All Metal legs are coated electrostatically with an epoxy powder coat paint.
*Shown Above: TB-9642-DBN-M-D	with WOOD Leg Option:	96"	48"	29"		NOTES: * Table heights of 25" (children), 27" (youth), and 32" (wheelchair) are available by request. * Color of Metal Paint must be specified at the time of order. * Caster Leg options are recommended for Reading/Multipurpose Tables options and not meant to be used for stationary computer workstations. * For all tables with casters legs, only 2 legs will have casters, and the other legs will have levelers. This will create a "wheelbarrow" style of table which will ensure ease of mobility. * Color of the Caster Option must be specified at the time of order. * For the Flip OR Fold Leg option, one T base leg comes with 2 hidden casters as shown in the image below
	Square				\$ 1,765	
	Square Radius				\$ 1,765	
	Square Tapered				\$ 1,920	
	Diameter Tapered				\$ 2,045	
	Safari				\$ 2,055	
	with METAL Leg Option:	96"	48"	29"		
*Rectangle Table Shape	Square				\$ 1,700	
	Square & Stem				\$ 2,125	
	Diameter				\$ 1,700	
	Diameter & Stem				\$ 2,125	
	Balloon				\$ 1,805	
	Square with Casters				\$ 1,930	
	Square & Stem with Casters				\$ 2,350	
	Diameter with Casters				\$ 1,930	
	Diameter & Stem with Casters				\$ 2,350	
	Flip Leg (for Nesting Tables)				\$ 2,585	
	Folding Leg				\$ 2,585	

Edge Option:





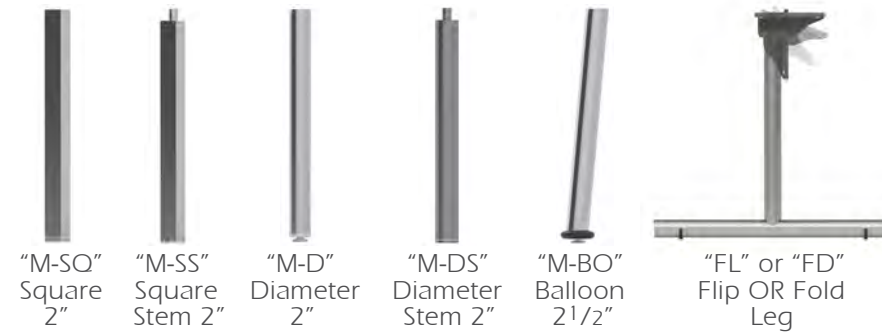

Metal Leg Options:

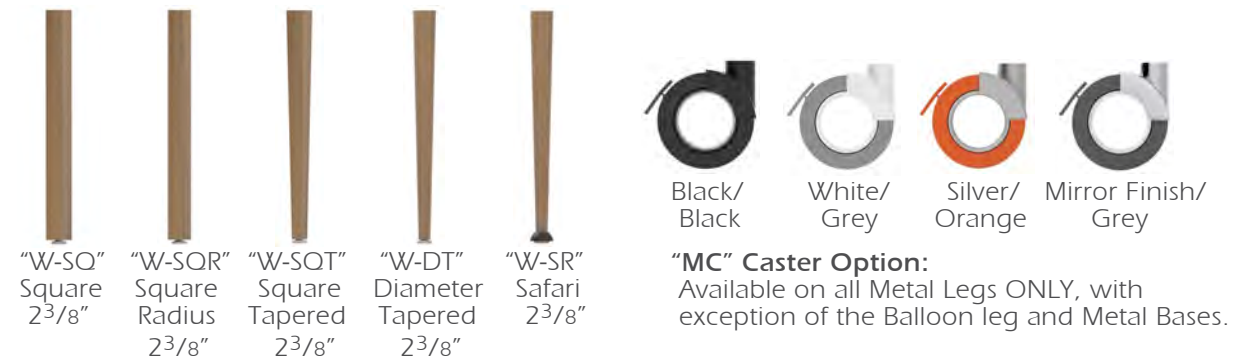

Wood Leg Options:



KREATIONS

MODEL NUMBER	PRODUCT	WIDTH	DEPTH	HEIGHT	PRICE	DESCRIPTION
 *Shown Above: TB-9642-DCH-M-D	Rectangle Table, 96" Width, 36" Depth DROPPED CHAMFERED Edge;	96"	36"	29"		Each Table Top is constructed using a 1 1/8" thick top with a Plastic Laminate top surface. All Metal legs are coated electrostatically with an epoxy powder coat paint.
	with WOOD Leg Option:	96"	36"	29"		NOTES: * Table heights of 25" (children), 27" (youth), and 32" (wheelchair) are available by request. * Color of Metal Paint must be specified at the time of order. * Caster Leg options are recommended for Reading/Multipurpose Tables options and not meant to be used for stationary computer workstations. * For all tables with casters legs, only 2 legs will have casters, and the other legs will have levelers. This will create a "wheelbarrow" style of table which will ensure ease of mobility. * Color of the Caster Option must be specified at the time of order. * For the Flip OR Fold Leg option, one T base leg comes with 2 hidden casters as shown in the image below
 *Rectangle Table Shape	TB-9636-DCH-W-SQ Square TB-9636-DCH-W-SQR Square Radius TB-9636-DCH-W-SQT Square Tapered TB-9636-DCH-W-DT Diameter Tapered TB-9636-DCH-W-SR Safari	96"	36"	29"	\$ 1,485 \$ 1,485 \$ 1,635 \$ 1,765 \$ 1,775	
	with METAL Leg Option:	96"	36"	29"	\$ 1,420 \$ 1,840 \$ 1,420 \$ 1,840 \$ 1,520 \$ 1,645 \$ 2,070 \$ 1,645 \$ 2,070 \$ 2,280 \$ 2,280	
	Rectangle Table, 96" Width, 42" Depth DROPPED CHAMFERED Edge;	96"	42"	29"		
	with WOOD Leg Option:	96"	42"	29"		
	TB-9642-DCH-W-SQ Square TB-9642-DCH-W-SQR Square Radius TB-9642-DCH-W-SQT Square Tapered TB-9642-DCH-W-DT Diameter Tapered TB-9642-DCH-W-SR Safari	96"	42"	29"	\$ 1,695 \$ 1,695 \$ 1,850 \$ 1,980 \$ 1,985	
	with METAL Leg Option:	96"	42"	29"	\$ 1,635 \$ 2,055 \$ 1,635 \$ 2,055 \$ 1,735 \$ 1,855 \$ 2,280 \$ 1,855 \$ 2,280 \$ 2,520 \$ 2,520	
	TB-9642-DCH-M-SQ Square TB-9642-DCH-M-SS Square & Stem TB-9642-DCH-M-D Diameter TB-9642-DCH-M-DS Diameter & Stem TB-9642-DCH-M-BO Balloon TB-9642-DCH-MC-SQ Square with Casters TB-9642-DCH-MC-SS Square & Stem with Casters TB-9642-DCH-MC-D Diameter with Casters TB-9642-DCH-MC-DS Diameter & Stem with Casters TB-9642-DCH-FL Flip Leg (for Nesting Tables) TB-9642-DCH-FD Folding Leg					Edge Option:  "DCH" 3/4" Dropped Chamfered Edge
						Metal Leg Options:  "M-SQ" Square 2" "M-SS" Square Stem 2" "M-D" Diameter 2" "M-DS" Diameter Stem 2" "M-BO" Balloon 2 1/2" "FL" or "FD" Flip OR Fold Leg
						Wood Leg Options:  "W-SQ" Square 2 3/8" "W-SQR" Square Radius 2 3/8" "W-SOT" Square Tapered 2 3/8" "W-DT" Diameter Tapered 2 3/8" "W-SR" Safari 2 3/8" "MC" Caster Option: Available on all Metal Legs ONLY, with exception of the Balloon leg and Metal Bases.

KREATIONS

MODEL NUMBER	PRODUCT	WIDTH	DEPTH	HEIGHT	PRICE	DESCRIPTION
	Rectangle Table, 96" Width, 48" Depth	96"	48"	29"		Each Table Top is constructed using a 1 1/8" thick top with a Plastic Laminate top surface.
	DROPPED CHAMFERED Edge;					All Metal legs are coated electrostatically with an epoxy powder coat paint.
*Shown Above: TB-9642-DCH-M-D	with WOOD Leg Option:	96"	48"	29"		NOTES: * Table heights of 25" (children), 27" (youth), and 32" (wheelchair) are available by request. * Color of Metal Paint must be specified at the time of order. * Caster Leg options are recommended for Reading/Multipurpose Tables options and not meant to be used for stationary computer workstations. * For all tables with casters legs, only 2 legs will have casters, and the other legs will have levelers. This will create a "wheelbarrow" style of table which will ensure ease of mobility. * Color of the Caster Option must be specified at the time of order. * For the Flip OR Fold Leg option, one T base leg comes with 2 hidden casters as shown in the image below
	TB-9648-DCH-W-SQ Square				\$ 1,765	
	TB-9648-DCH-W-SQR Square Radius				\$ 1,765	
	TB-9648-DCH-W-SQT Square Tapered				\$ 1,920	
	TB-9648-DCH-W-DT Diameter Tapered				\$ 2,045	
	TB-9648-DCH-W-SR Safari				\$ 2,055	
	with METAL Leg Option:	96"	48"	29"		
*Rectangle Table Shape	TB-9648-DCH-M-SQ Square				\$ 1,700	
	TB-9648-DCH-M-SS Square & Stem				\$ 2,125	
	TB-9648-DCH-M-D Diameter				\$ 1,700	
	TB-9648-DCH-M-DS Diameter & Stem				\$ 2,125	
	TB-9648-DCH-M-BO Balloon				\$ 1,805	
	TB-9648-DCH-MC-SQ Square with Casters				\$ 1,930	
	TB-9648-DCH-MC-SS Square & Stem with Casters				\$ 2,350	
	TB-9648-DCH-MC-D Diameter with Casters				\$ 1,930	
	TB-9648-DCH-MC-DS Diameter & Stem with Casters				\$ 2,350	
	TB-9648-DCH-FL Flip Leg (for Nesting Tables)				\$ 2,585	
	TB-9648-DCH-FD Folding Leg				\$ 2,585	

Edge Option:





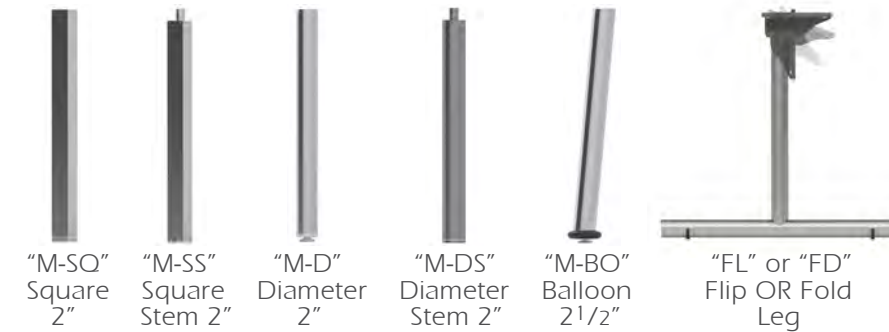

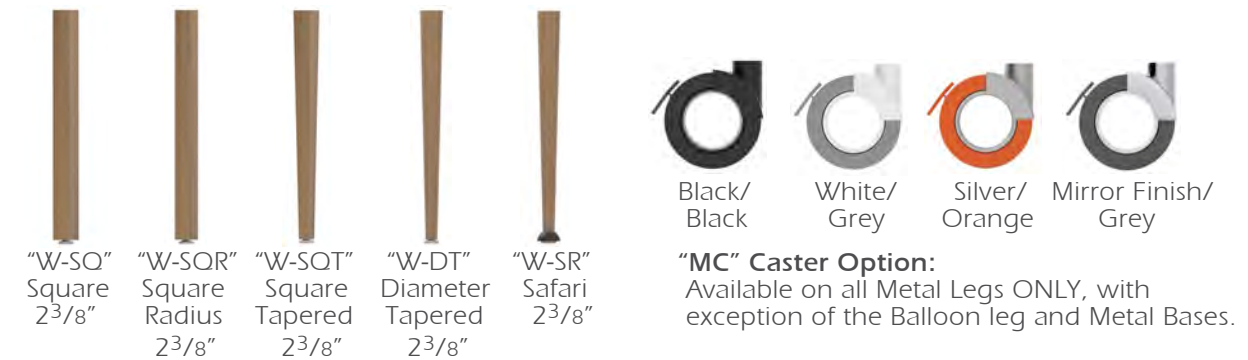

Metal Leg Options:



Wood Leg Options:



KREATIONS

MODEL NUMBER	PRODUCT	WIDTH	DEPTH	HEIGHT	PRICE	DESCRIPTION	
 <p>*Shown Above: TB-9642-AL-M-D</p>  <p>*Rectangle Table Shape</p>	Rectangle Table, 96" Width, 36" Depth	96"	36"	29"		Each Table Top is constructed using a 1 1/8" thick top with a Plastic Laminate top surface.	
	ALUMINUM Edge;					All Metal legs are coated electrostatically with an epoxy powder coat paint.	
	TB-9636-AL-W-SQ	with WOOD Leg Option: Square	96"	36"	29"	\$ 1,350	<p>NOTES:</p> <ul style="list-style-type: none"> * Table heights of 25" (children), 27" (youth), and 32" (wheelchair) are available by request. * Color of Metal Paint must be specified at the time of order. * Caster Leg options are recommended for Reading/Multipurpose Tables options and not meant to be used for stationary computer workstations. * For all tables with casters legs, only 2 legs will have casters, and the other legs will have levelers. This will create a "wheelbarrow" style of table which will ensure ease of mobility. * Color of the Caster Option must be specified at the time of order. * For the Flip OR Fold Leg option, one T base leg comes with 2 hidden casters as shown in the image below
	TB-9636-AL-W-SQR	Square Radius				\$ 1,350	
	TB-9636-AL-W-SQT	Square Tapered				\$ 1,425	
	TB-9636-AL-W-DT	Diameter Tapered				\$ 1,555	
	TB-9636-AL-W-SR	Safari				\$ 1,565	
	TB-9636-AL-M-SQ	with METAL Leg Option: Square	96"	36"	29"	\$ 1,210	
	TB-9636-AL-M-SS	Square & Stem				\$ 1,635	
	TB-9636-AL-M-D	Diameter				\$ 1,210	
TB-9636-AL-M-DS	Diameter & Stem				\$ 1,635		
TB-9636-AL-M-BO	Balloon				\$ 1,315		
TB-9636-AL-MC-SQ	Square with Casters				\$ 1,435		
TB-9636-AL-MC-SS	Square & Stem with Casters				\$ 1,860		
TB-9636-AL-MC-D	Diameter with Casters				\$ 1,435		
TB-9636-AL-MC-DS	Diameter & Stem with Casters				\$ 1,860		
TB-9636-AL-FL	Flip Leg (for Nesting Tables)				\$ 2,075		
TB-9636-AL-FD	Folding Leg				\$ 2,075		
	Rectangle Table, 96" Width, 42" Depth	96"	42"	29"			
	ALUMINUM Edge;						
TB-9642-AL-W-SQ	with WOOD Leg Option: Square	96"	42"	29"	\$ 1,475	<p>Edge Option:</p>  <p>"AL" 3mm Aluminum Edge *All table corners will be given a 6-inch radius for this edge option.</p> <p>Metal Leg Options:</p>  <p>"M-SQ" Square 2" "M-SS" Square Stem 2" "M-D" Diameter 2" "M-DS" Diameter Stem 2" "M-BO" Balloon 2 1/2" "FL" or "FD" Flip OR Fold Leg</p> <p>Wood Leg Options:</p>  <p>"W-SQ" Square 2 3/8" "W-SQR" Square Radius 2 3/8" "W-SOT" Square Tapered 2 3/8" "W-DT" Diameter Tapered 2 3/8" "W-SR" Safari 2 3/8"</p> <p>"MC" Caster Option: Available on all Metal Legs ONLY, with exception of the Balloon leg and Metal Bases.</p>  <p>Black/Black White/Grey Silver/Orange Mirror Finish/Grey</p>	
TB-9642-AL-W-SQR	Square Radius				\$ 1,475		
TB-9642-AL-W-SQT	Square Tapered				\$ 1,630		
TB-9642-AL-W-DT	Diameter Tapered				\$ 1,760		
TB-9642-AL-W-SR	Safari				\$ 1,765		
TB-9642-AL-M-SQ	with METAL Leg Option: Square	96"	42"	29"	\$ 1,410		
TB-9642-AL-M-SS	Square & Stem				\$ 1,840		
TB-9642-AL-M-D	Diameter				\$ 1,410		
TB-9642-AL-M-DS	Diameter & Stem				\$ 1,840		
TB-9642-AL-M-BO	Balloon				\$ 1,515		
TB-9642-AL-MC-SQ	Square with Casters				\$ 1,640		
TB-9642-AL-MC-SS	Square & Stem with Casters				\$ 2,060		
TB-9642-AL-MC-D	Diameter with Casters				\$ 1,640		
TB-9642-AL-MC-DS	Diameter & Stem with Casters				\$ 2,060		
TB-9642-AL-FL	Flip Leg (for Nesting Tables)				\$ 2,300		
TB-9642-AL-FD	Folding Leg				\$ 2,300		

KREATIONS

MODEL NUMBER	PRODUCT	WIDTH	DEPTH	HEIGHT	PRICE	DESCRIPTION
	Rectangle Table, 96" Width, 48" Depth	96"	48"	29"		Each Table Top is constructed using a 1 1/8" thick top with a Plastic Laminate top surface.
	ALUMINUM Edge:					All Metal legs are coated electrostatically with an epoxy powder coat paint.
	with WOOD Leg Option:	96"	48"	29"		NOTES: * Table heights of 25" (children), 27" (youth), and 32" (wheelchair) are available by request. * Color of Metal Paint must be specified at the time of order. * Caster Leg options are recommended for Reading/Multipurpose Tables options and not meant to be used for stationary computer workstations. * For all tables with casters legs, only 2 legs will have casters, and the other legs will have levelers. This will create a "wheelbarrow" style of table which will ensure ease of mobility. * Color of the Caster Option must be specified at the time of order. * For the Flip OR Fold Leg option, one T base leg comes with 2 hidden casters as shown in the image below
	TB-9648-AL-W-SQ Square				\$ 1,540	
	TB-9648-AL-W-SQR Square Radius				\$ 1,540	
	TB-9648-AL-W-SQT Square Tapered				\$ 1,690	
	TB-9648-AL-W-DT Diameter Tapered				\$ 1,820	
	TB-9648-AL-W-SR Safari				\$ 1,825	
	with METAL Leg Option:	96"	48"	29"		
	TB-9648-AL-M-SQ Square				\$ 1,475	
	TB-9648-AL-M-SS Square & Stem				\$ 1,900	
	TB-9648-AL-M-D Diameter				\$ 1,475	
	TB-9648-AL-M-DS Diameter & Stem				\$ 1,900	
	TB-9648-AL-M-BO Balloon				\$ 1,575	
	TB-9648-AL-MC-SQ Square with Casters				\$ 1,700	
	TB-9648-AL-MC-SS Square & Stem with Casters				\$ 2,125	
	TB-9648-AL-MC-D Diameter with Casters				\$ 1,700	
	TB-9648-AL-MC-DS Diameter & Stem with Casters				\$ 2,125	
	TB-9648-AL-FL Flip Leg (for Nesting Tables)				\$ 2,360	
	TB-9648-AL-FD Folding Leg				\$ 2,360	

*Shown Above:
TB-9642-AL-M-D



*Rectangle Table Shape

Edge Option:



"AL"
3mm Aluminum Edge *All table corners will be given a 6-inch radius for this edge option.

Metal Leg Options:

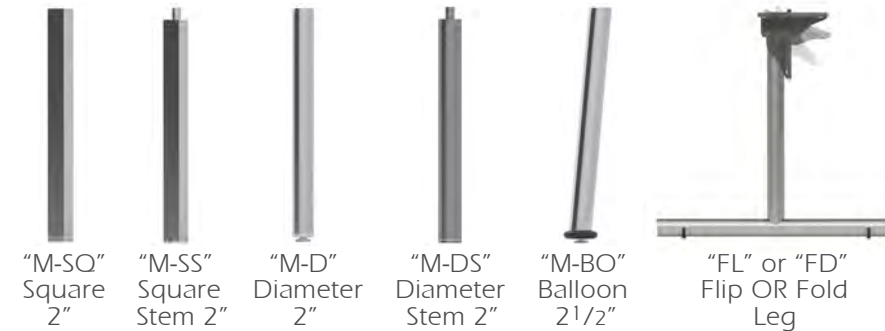

Wood Leg Options:



"MC" Caster Option:
Available on all Metal Legs ONLY, with exception of the Balloon leg and Metal Bases.

KREATIONS

MODEL NUMBER

PRODUCT

WIDTH DEPTH HEIGHT

PRICE

DESCRIPTION



*Shown Above:
TB-TZ4824-AC-M-D



*Trapezoidal Table Shape

MODEL NUMBER	PRODUCT	WIDTH	DEPTH	HEIGHT	PRICE
	Trapezoidal Table, 48" Width, 24" Depth	48"	24"	29"	
	ACRYLIC Edge;				
	with WOOD Leg Option:	48"	24"	29"	
TB-TZ4824-AC-W-SQ	Square				\$ 840
TB-TZ4824-AC-W-SOR	Square Radius				\$ 840
TB-TZ4824-AC-W-SOT	Square Tapered				\$ 995
TB-TZ4824-AC-W-DT	Diameter Tapered				\$ 1,125
TB-TZ4824-AC-W-SR	Safari				\$ 1,130
	with METAL Leg Option:	48"	24"	29"	
TB-TZ4824-AC-M-SQ	Square				\$ 780
TB-TZ4824-AC-M-SS	Square & Stem				\$ 1,200
TB-TZ4824-AC-M-D	Diameter				\$ 780
TB-TZ4824-AC-M-DS	Diameter & Stem				\$ 1,200
TB-TZ4824-AC-M-BO	Balloon				\$ 880
TB-TZ4824-AC-MC-SQ	Square with Casters				\$ 1,000
TB-TZ4824-AC-MC-SS	Square & Stem with Casters				\$ 1,425
TB-TZ4824-AC-MC-D	Diameter with Casters				\$ 1,000
TB-TZ4824-AC-MC-DS	Diameter & Stem with Casters				\$ 1,425

Each Table Top is constructed using a 1" thick top with a Plastic Laminate top surface.

All Metal legs are coated electrostatically with an epoxy powder coat paint.

NOTES:

- * Table heights of 25" (children), 27" (youth), and 32" (wheelchair) are available by request.
- * Color of Metal Paint must be specified at the time of order.
- * Caster Leg options are recommended for Reading/Multipurpose Tables options and not meant to be used for stationary computer workstations.
- * For all tables with casters legs, only 2 legs will have casters, and the other legs will have levelers. This will create a "wheelbarrow" style of table which will ensure ease of mobility.
- * Color of the Caster Option must be specified at the time of order.

Edge Option:



"AC"
3mm Acrylic Edge

Metal Leg Options:



"M-SQ" Square 2"
"M-SS" Square Stem 2"
"M-D" Diameter 2"
"M-DS" Diameter Stem 2"
"M-BO" Balloon 2 1/2"

Wood Leg Options:



"W-SQ" Square 2 3/8"
"W-SOR" Square Radius 2 3/8"
"W-SOT" Square Tapered 2 3/8"
"W-DT" Diameter Tapered 2 3/8"
"W-SR" Safari 2 3/8"



"MC" Caster Option:
Available on all Metal Legs ONLY, with exception of the Balloon leg and Metal Bases.

MODEL NUMBER

PRODUCT

WIDTH DEPTH HEIGHT

PRICE

DESCRIPTION



*Shown Above:
TB-TZ4824-SQ-M-D



*Trapezoidal Table Shape

MODEL NUMBER	PRODUCT	WIDTH	DEPTH	HEIGHT	PRICE
	Trapezoidal Table, 48" Width, 24" Depth	48"	24"	29"	
	SQUARE Edge;				
	with WOOD Leg Option:	48"	24"	29"	
TB-TZ4824-SQ-W-SQ	Square				\$ 955
TB-TZ4824-SQ-W-SQR	Square Radius				\$ 955
TB-TZ4824-SQ-W-SQT	Square Tapered				\$ 1,110
TB-TZ4824-SQ-W-DT	Diameter Tapered				\$ 1,235
TB-TZ4824-SQ-W-SR	Safari				\$ 1,240
	with METAL Leg Option:	48"	24"	29"	
TB-TZ4824-SQ-M-SQ	Square				\$ 890
TB-TZ4824-SQ-M-SS	Square & Stem				\$ 1,315
TB-TZ4824-SQ-M-D	Diameter				\$ 890
TB-TZ4824-SQ-M-DS	Diameter & Stem				\$ 1,315
TB-TZ4824-SQ-M-BO	Balloon				\$ 995
TB-TZ4824-SQ-MC-SQ	Square with Casters				\$ 1,115
TB-TZ4824-SQ-MC-SS	Square & Stem with Casters				\$ 1,540
TB-TZ4824-SQ-MC-D	Diameter with Casters				\$ 1,115
TB-TZ4824-SQ-MC-DS	Diameter & Stem with Casters				\$ 1,540

Each Table Top is constructed using a 1 1/8" thick top with a Plastic Laminate top surface.

All Metal legs are coated electrostatically with an epoxy powder coat paint.

NOTES:

- * Table heights of 25" (children), 27" (youth), and 32" (wheelchair) are available by request.
- * Color of Metal Paint must be specified at the time of order.
- * Caster Leg options are recommended for Reading/Multipurpose Tables options and not meant to be used for stationary computer workstations.
- * For all tables with casters legs, only 2 legs will have casters, and the other legs will have levelers. This will create a "wheelbarrow" style of table which will ensure ease of mobility.
- * Color of the Caster Option must be specified at the time of order.

Edge Option:



"SQ"
1/4" Square Edge

Metal Leg Options:

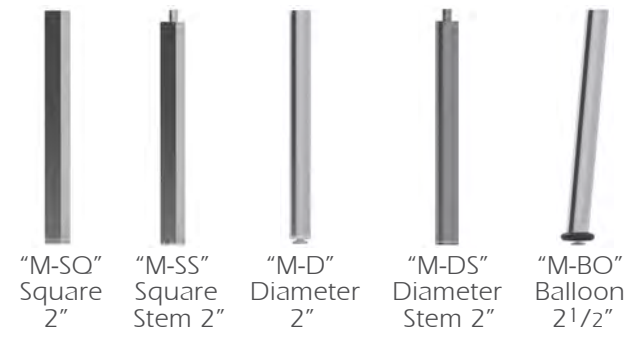

"M-SQ" Square 2"
"M-SS" Square Stem 2"
"M-D" Diameter 2"
"M-DS" Diameter Stem 2"
"M-BO" Balloon 2 1/2"



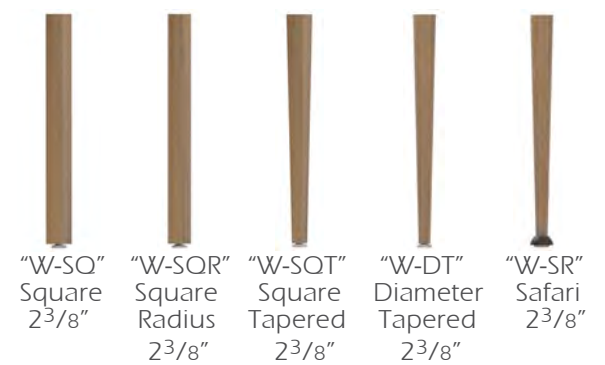

Wood Leg Options:





"W-SQ" Square 2 3/8"
"W-SQR" Square Radius 2 3/8"
"W-SQT" Square Tapered 2 3/8"
"W-DT" Diameter Tapered 2 3/8"
"W-SR" Safari 2 3/8"

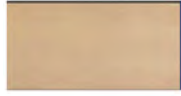

"MC" Caster Option:
Available on all Metal Legs ONLY, with exception of the Balloon leg and Metal Bases.

MODEL NUMBER	PRODUCT	WIDTH	DEPTH	HEIGHT	PRICE	DESCRIPTION	
 <p>*Shown Above: TB-T30-AC-M-D</p>  <p>*Triangle Table Shape</p>	Triangle Table, 30" Width, ACRYLIC Edge;	30"	30"	29"		Each Table Top is constructed using a 1" thick top with a Plastic Laminate top surface. All Metal legs are coated electrostatically with an epoxy powder coat paint.	
	TB-T30-AC-W-SQ TB-T30-AC-W-SQR TB-T30-AC-W-SOT TB-T30-AC-W-DT TB-T30-AC-W-SR	with WOOD Leg Option: Square Square Radius Square Tapered Diameter Tapered Safari	30"	30"	29"	\$ 760 \$ 760 \$ 875 \$ 970 \$ 980	<p>NOTES: * Table heights of 25" (children), 27" (youth), and 32" (wheelchair) are available by request. * Color of Metal Paint must be specified at the time of order.</p> <p>Edge Option:</p>   <p>"AC" 3mm Acrylic Edge</p> <p>Metal Leg Options:</p>  <p>"M-SQ" Square 2" "M-SS" Square Stem 2" "M-D" Diameter 2" "M-DS" Diameter Stem 2" "M-BO" Balloon 2 1/2"</p> <p>Wood Leg Options:</p>  <p>"W-SQ" Square 2 3/8" "W-SQR" Square Radius 2 3/8" "W-SOT" Square Tapered 2 3/8" "W-DT" Diameter Tapered 2 3/8" "W-SR" Safari 2 3/8"</p>
	TB-T30-AC-M-SQ TB-T30-AC-M-SS TB-T30-AC-M-D TB-T30-AC-M-DS TB-T30-AC-M-BO	with METAL Leg Option: Square Square & Stem Diameter Diameter & Stem Balloon	30"	30"	29"	\$ 715 \$ 1,030 \$ 715 \$ 1,030 \$ 790	
		Triangle Table, 36" Width, ACRYLIC Edge;	36"	36"	29"		
	TB-T36-AC-W-SQ TB-T36-AC-W-SQR TB-T36-AC-W-SOT TB-T36-AC-W-DT TB-T36-AC-W-SR	with WOOD Leg Option: Square Square Radius Square Tapered Diameter Tapered Safari	36"	36"	29"	\$ 800 \$ 800 \$ 915 \$ 1,015 \$ 1,020	
	TB-T36-AC-M-SQ TB-T36-AC-M-SS TB-T36-AC-M-D TB-T36-AC-M-DS TB-T36-AC-M-BO	with METAL Leg Option: Square Square & Stem Diameter Diameter & Stem Balloon	36"	36"	29"	\$ 755 \$ 1,070 \$ 755 \$ 1,070 \$ 830	

KREATIONS

MODEL NUMBER	PRODUCT	WIDTH	DEPTH	HEIGHT	PRICE	DESCRIPTION	
 *Shown Above: TB-TS48-AC-M-D	Trio-Squared Table, 48" Width,	48"	48"	29"		Each Table Top is constructed using a 1" thick top with a Plastic Laminate top surface.	
	ACRYLIC Edge;					All Metal legs are coated electrostatically with an epoxy powder coat paint.	
	with WOOD Leg Option:	48"	48"	29"		NOTES: * Table heights of 25" (children), 27" (youth), and 32" (wheelchair) are available by request. * Color of Metal Paint must be specified at the time of order.	
	TB-TS48-AC-W-SQ TB-TS48-AC-W-SQR TB-TS48-AC-W-SQT TB-TS48-AC-W-DT TB-TS48-AC-W-SR	Square Square Radius Square Tapered Diameter Tapered Safari				\$ 1,020 \$ 1,020 \$ 1,135 \$ 1,235 \$ 1,240	
	with METAL Leg Option:	48"	48"	29"			
 *Trio-Squared Table Shape	TB-TS48-AC-M-SQ TB-TS48-AC-M-SS TB-TS48-AC-M-D TB-TS48-AC-M-DS TB-TS48-AC-M-BO	Square Square & Stem Diameter Diameter & Stem Balloon				\$ 970 \$ 1,290 \$ 970 \$ 1,290 \$ 1,050	
	TB-TS48-AC-FP1 TB-TS48-AC-FP2 TB-TS48-AC-FP3 TB-TS48-AC-TP1 TB-TS48-AC-TP2 TB-TS48-AC-TP3	Flat Pedestal 19" H Flat Pedestal 29" H Flat Pedestal 42" H Trumpet 19" H Trumpet 29" H Trumpet 42" H	48"	48"	19" 29" 42" 19" 29" 42"	\$ 1,920 \$ 1,920 \$ 1,995 \$ 1,315 \$ 1,315 \$ 1,495	

Edge Option:

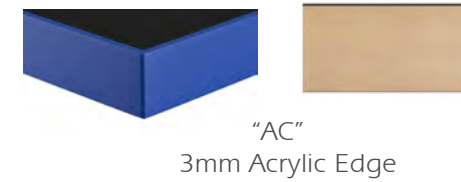

Metal Leg Options:

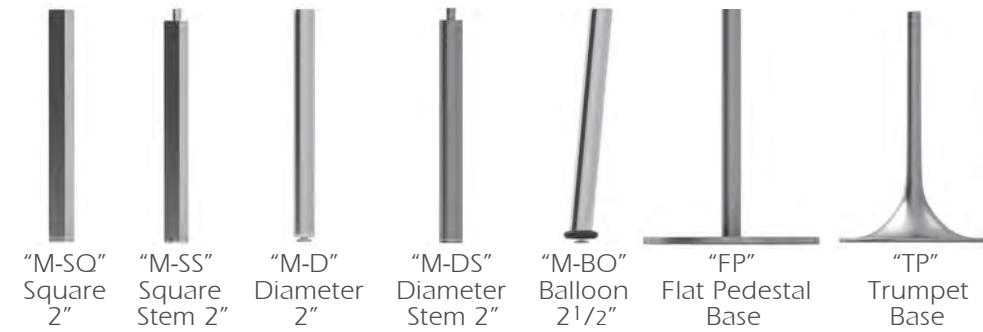

Wood Leg Options:

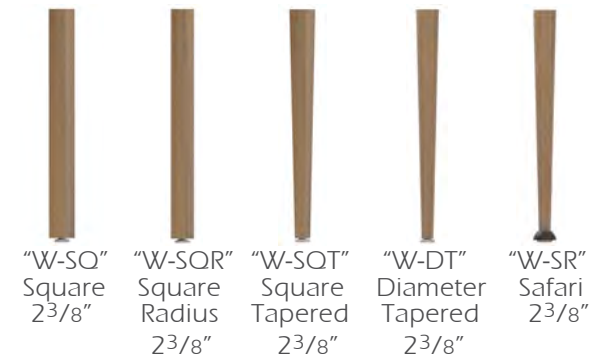

KREATIONS

MODEL NUMBER	PRODUCT	WIDTH	DEPTH	HEIGHT	PRICE	DESCRIPTION
 <p>*Shown Above: TB-TS60-AC-M-D</p>  <p>*Trio-Squared Table Shape</p>	Trio-Squared Table, 60" Width,	60"	60"	29"		Each Table Top is constructed using a 1" thick top with a Plastic Laminate top surface.
	ACRYLIC Edge;					All Metal legs are coated electrostatically with an epoxy powder coat paint.
	with WOOD Leg Option:	60"	60"	29"		NOTES:
	TB-TS60-AC-W-SQ Square				\$ 1,615	* Table heights of 25" (children), 27" (youth), and 32" (wheelchair) are available by request.
	TB-TS60-AC-W-SQR Square Radius				\$ 1,615	* Color of Metal Paint must be specified at the time of order.
	TB-TS60-AC-W-SQT Square Tapered				\$ 1,840	* Caster Leg options are recommended for Reading/Multipurpose Tables options and not meant to be used for stationary computer workstations.
	TB-TS60-AC-W-DT Diameter Tapered				\$ 2,035	* For all tables with casters legs, only 2 legs will have casters, and the other legs will have levelers. This will create a "wheelbarrow" style of table which will ensure ease of mobility.
	TB-TS60-AC-W-SR Safari				\$ 2,045	* Color of the Caster Option must be specified at the time of order.
	with METAL Leg Option:	60"	60"	29"		
	TB-TS60-AC-M-SQ Square				\$ 1,515	
TB-TS60-AC-M-SS Square & Stem				\$ 3,240		
TB-TS60-AC-M-D Diameter				\$ 1,515		
TB-TS60-AC-M-DS Diameter & Stem				\$ 3,240		
TB-TS60-AC-M-BO Balloon				\$ 1,670		
TB-TS60-AC-MC-SQ Square with Casters				\$ 1,630		
TB-TS60-AC-MC-SS Square & Stem with Casters				\$ 2,265		
TB-TS60-AC-MC-D Diameter with Casters				\$ 1,630		
TB-TS60-AC-MC-DS Diameter & Stem with Casters				\$ 2,265		

Edge Option:

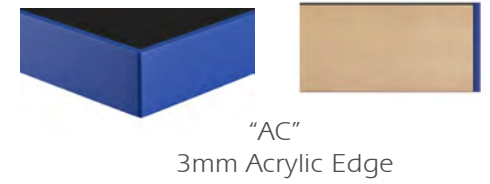

Metal Leg Options:

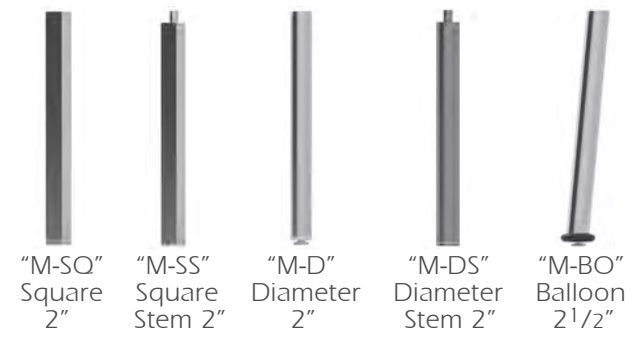



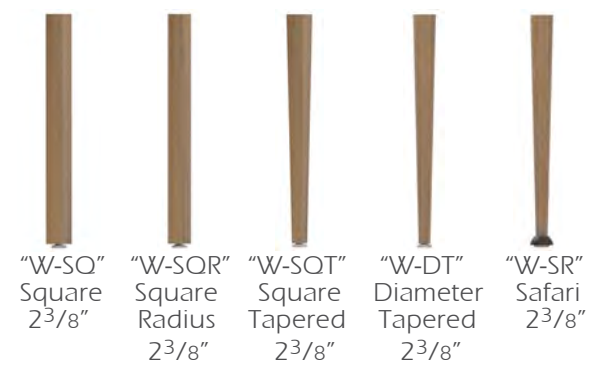

Wood Leg Options:



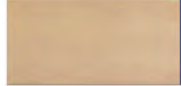

"MC" Caster Option:
Available on all Metal Legs ONLY, with exception of the Balloon leg and Metal Bases.

KREATIONS

MODEL NUMBER	PRODUCT	WIDTH	DEPTH	HEIGHT	PRICE	DESCRIPTION	
 *Shown Above: TB-TR48-AC-M-D	Trio-Round Table, 48" Width,	48"	48"	29"		Each Table Top is constructed using a 1" thick top with a Plastic Laminate top surface.	
	ACRYLIC Edge;					All Metal legs are coated electrostatically with an epoxy powder coat paint.	
	with WOOD Leg Option:	48"	48"	29"		NOTES: * Table heights of 25" (children), 27" (youth), and 32" (wheelchair) are available by request. * Color of Metal Paint must be specified at the time of order.	
	TB-TR48-AC-W-SQ TB-TR48-AC-W-SQR TB-TR48-AC-W-SQT TB-TR48-AC-W-DT TB-TR48-AC-W-SR	Square Square Radius Square Tapered Diameter Tapered Safari				\$ 985 \$ 985 \$ 1,095 \$ 1,190 \$ 1,200	
	with METAL Leg Option:	48"	48"	29"			
 *Trio-Round Table Shape	TB-TR48-AC-M-SQ TB-TR48-AC-M-SS TB-TR48-AC-M-D TB-TR48-AC-M-DS TB-TR48-AC-M-BO	Square Square & Stem Diameter Diameter & Stem Balloon				\$ 935 \$ 1,255 \$ 935 \$ 1,255 \$ 1,010	Edge Option:   "AC" 3mm Acrylic Edge
	TB-TR48-AC-FP1 TB-TR48-AC-FP2 TB-TR48-AC-FP3 TB-TR48-AC-TP1 TB-TR48-AC-TP2 TB-TR48-AC-TP3	Flat Pedestal 19" H Flat Pedestal 29" H Flat Pedestal 42" H Trumpet 19" H Trumpet 29" H Trumpet 42" H	48"	48"	19" 29" 42" 19" 29" 42"	\$ 1,880 \$ 1,880 \$ 1,955 \$ 1,280 \$ 1,280 \$ 1,460	Metal Leg Options:  "M-SQ" Square 2" "M-SS" Square Stem 2" "M-D" Diameter 2" "M-DS" Diameter Stem 2" "M-BO" Balloon 2 1/2" "FP" Flat Pedestal Base "TP" Trumpet Base
							Wood Leg Options:  "W-SQ" Square 2 3/8" "W-SQR" Square Radius 2 3/8" "W-SQT" Square Tapered 2 3/8" "W-DT" Diameter Tapered 2 3/8" "W-SR" Safari 2 3/8"

KREATIONS

MODEL NUMBER	PRODUCT	WIDTH	DEPTH	HEIGHT	PRICE	DESCRIPTION	
 <p>*Shown Above: TB-TR60-AC-M-D</p>	Trio-Round Table, 60" Width,	60"	60"	29"		Each Table Top is constructed using a 1" thick top with a Plastic Laminate top surface.	
	ACRYLIC Edge;					All Metal legs are coated electrostatically with an epoxy powder coat paint.	
	with WOOD Leg Option:	60"	60"	29"		NOTES: * Table heights of 25" (children), 27" (youth), and 32" (wheelchair) are available by request. * Color of Metal Paint must be specified at the time of order.	
	TB-TR60-AC-W-SQ TB-TR60-AC-W-SQR TB-TR60-AC-W-SQT TB-TR60-AC-W-DT TB-TR60-AC-W-SR	Square Square Radius Square Tapered Diameter Tapered Safari				\$ 1,310 \$ 1,310 \$ 1,425 \$ 1,520 \$ 1,525	
	with METAL Leg Option:	60"	60"	29"			
 <p>*Trio-Round Table Shape</p>	TB-TR60-AC-M-SQ TB-TR60-AC-M-SS TB-TR60-AC-M-D TB-TR60-AC-M-DS TB-TR60-AC-M-BO	Square Square & Stem Diameter Diameter & Stem Balloon			\$ 1,265 \$ 1,580 \$ 1,265 \$ 1,580 \$ 1,340		

Edge Option:

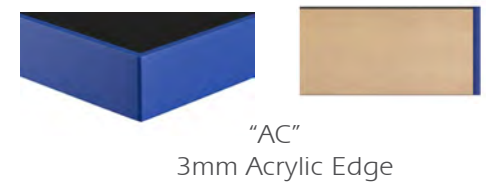

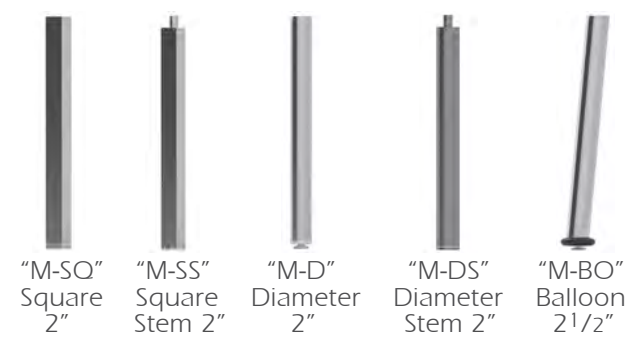

Metal Leg Options:

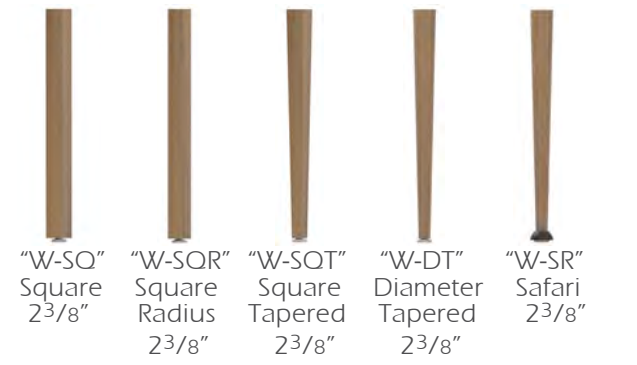

Wood Leg Options:



KREATIONS

MODEL NUMBER	PRODUCT	WIDTH	DEPTH	HEIGHT	PRICE	DESCRIPTION	
 <p>*Shown Above: TB-TL48-AC-M-D</p>	Trio-Link Table, 48" Width,	48"	48"	29"		<p>Each Table Top is constructed using a 1" thick top with a Plastic Laminate top surface.</p> <p>All Metal legs are coated electrostatically with an epoxy powder coat paint.</p> <p>NOTES: * Table heights of 25" (children), 27" (youth), and 32" (wheelchair) are available by request. * Color of Metal Paint must be specified at the time of order.</p>	
	ACRYLIC Edge;						
	with WOOD Leg Option:	48"	48"	29"			
	TB-TL48-AC-W-SQ TB-TL48-AC-W-SQR TB-TL48-AC-W-SQT TB-TL48-AC-W-DT TB-TL48-AC-W-SR	Square Square Radius Square Tapered Diameter Tapered Safari					\$ 1,020 \$ 1,020 \$ 1,135 \$ 1,235 \$ 1,240
	with METAL Leg Option:	48"	48"	29"			
 <p>*Trio-Link Table Shape</p>	TB-TL48-AC-M-SQ TB-TL48-AC-M-SS TB-TL48-AC-M-D TB-TL48-AC-M-DS TB-TL48-AC-M-BO	Square Square & Stem Diameter Diameter & Stem Balloon			\$ 970 \$ 1,290 \$ 970 \$ 1,290 \$ 1,050		
	TB-TL48-AC-FP1 TB-TL48-AC-FP2 TB-TL48-AC-FP3 TB-TL48-AC-TP1 TB-TL48-AC-TP2 TB-TL48-AC-TP3	Flat Pedestal 19" H Flat Pedestal 29" H Flat Pedestal 42" H Trumpet 19" H Trumpet 29" H Trumpet 42" H	48" 48" 48" 48" 48" 48"	48" 48" 48" 48" 48" 48"	19" 29" 42" 19" 29" 42"	\$ 1,920 \$ 1,920 \$ 1,995 \$ 1,315 \$ 1,315 \$ 1,495	

Edge Option:

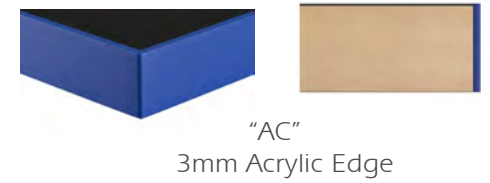

Metal Leg Options:

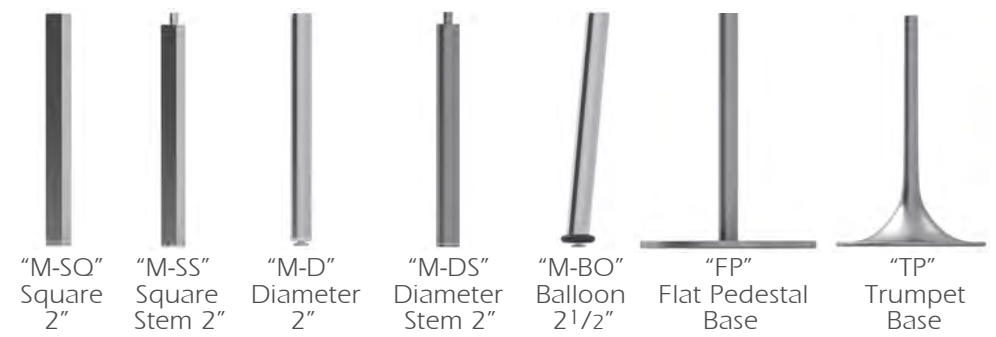

Wood Leg Options:

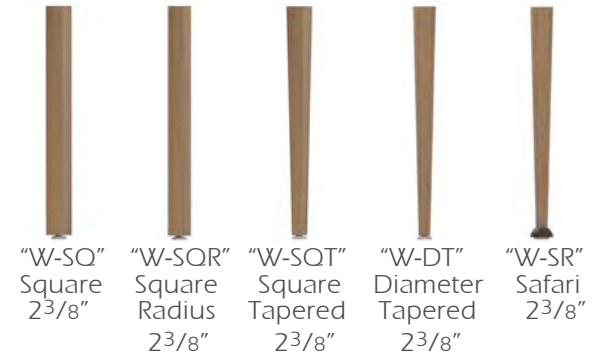

KREATIONS

MODEL NUMBER

PRODUCT

WIDTH DEPTH HEIGHT

PRICE

DESCRIPTION



*Shown Above:
TB-TL60-AC-M-D



*Trio-Link Table Shape

TB-TL60-AC-W-SQ
TB-TL60-AC-W-SQR
TB-TL60-AC-W-SQT
TB-TL60-AC-W-DT
TB-TL60-AC-W-SR

Trio-Link Table, 60" Width,
ACRYLIC Edge;
with WOOD Leg Option:
Square
Square Radius
Square Tapered
Diameter Tapered
Safari

60" 60" 29"

TB-TL60-AC-M-SQ
TB-TL60-AC-M-SS
TB-TL60-AC-M-D
TB-TL60-AC-M-DS
TB-TL60-AC-M-BO

with METAL Leg Option:
Square
Square & Stem
Diameter
Diameter & Stem
Balloon

60" 60" 29"

\$ 1,615
\$ 1,615
\$ 1,840
\$ 2,035
\$ 2,045

\$ 1,515
\$ 3,240
\$ 1,515
\$ 3,240
\$ 1,670

Each Table Top is constructed using a 1" thick top with a Plastic Laminate top surface.
All Metal legs are coated electrostatically with an epoxy powder coat paint.

NOTES:

- * Table heights of 25" (children), 27" (youth), and 32" (wheelchair) are available by request.
- * Color of Metal Paint must be specified at the time of order.

Edge Option:

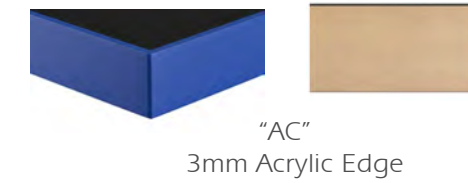

"AC"
3mm Acrylic Edge

Metal Leg Options:

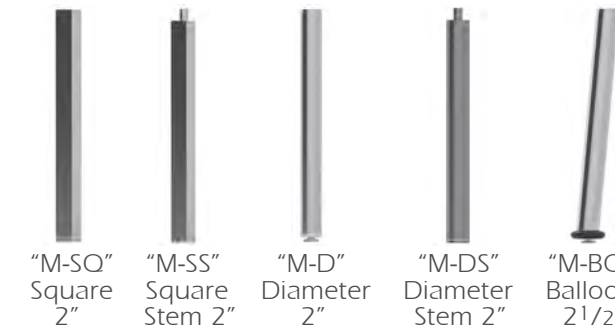

"M-SQ" Square 2"
"M-SS" Square Stem 2"
"M-D" Diameter 2"
"M-DS" Diameter Stem 2"
"M-BO" Balloon 2 1/2"

Wood Leg Options:

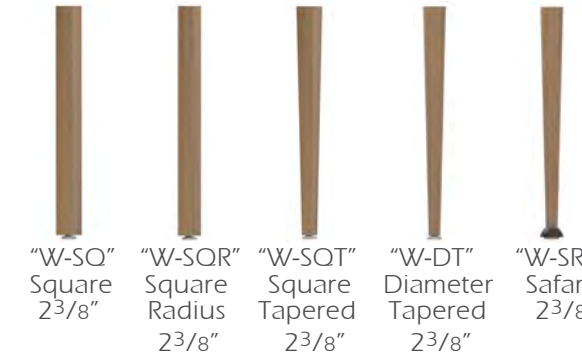

"W-SQ" Square 2 3/8"
"W-SQR" Square Radius 2 3/8"
"W-SQT" Square Tapered 2 3/8"
"W-DT" Diameter Tapered 2 3/8"
"W-SR" Safari 2 3/8"

KREATIONS

MODEL NUMBER

PRODUCT

WIDTH DEPTH HEIGHT

PRICE

DESCRIPTION

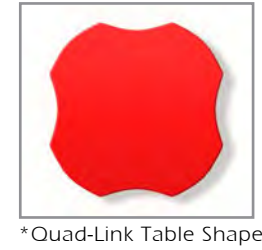

MODEL NUMBER	PRODUCT	WIDTH	DEPTH	HEIGHT	PRICE
	Quad-Link Table, 36" Width,	36"	36"	29"	
	ACRYLIC Edge;				
	with WOOD Leg Option:	36"	36"	29"	
TB-QL36-AC-W-SQ	Square				\$ 1,015
TB-QL36-AC-W-SQR	Square Radius				\$ 1,015
TB-QL36-AC-W-SQT	Square Tapered				\$ 1,165
TB-QL36-AC-W-DT	Diameter Tapered				\$ 1,295
TB-QL36-AC-W-SR	Safari				\$ 1,300
	with METAL Leg Option:	36"	36"	29"	
TB-QL36-AC-M-SQ	Square				\$ 950
TB-QL36-AC-M-SS	Square & Stem				\$ 1,370
TB-QL36-AC-M-D	Diameter				\$ 950
TB-QL36-AC-M-DS	Diameter & Stem				\$ 1,370
TB-QL36-AC-M-BO	Balloon				\$ 1,050
TB-QL36-AC-MC-SQ	Square with Casters				\$ 1,175
TB-QL36-AC-MC-SS	Square & Stem with Casters				\$ 1,530
TB-QL36-AC-MC-D	Diameter with Casters				\$ 1,175
TB-QL36-AC-MC-DS	Diameter & Stem with Casters				\$ 1,530
TB-QL36-AC-FP1	Flat Pedestal 19" H	36"	36"	19"	\$ 1,310
TB-QL36-AC-FP2	Flat Pedestal 29" H	36"	36"	29"	\$ 1,310
TB-QL36-AC-FP3	Flat Pedestal 42" H	36"	36"	42"	\$ 1,500
TB-QL36-AC-TP1	Trumpet 19" H	36"	36"	19"	\$ 1,030
TB-QL36-AC-TP2	Trumpet 29" H	36"	36"	29"	\$ 1,030
TB-QL36-AC-TP3	Trumpet 42" H	36"	36"	42"	\$ 1,400

Each Table Top is constructed using a 1" thick top with a Plastic Laminate top surface.

All Metal legs are coated electrostatically with an epoxy powder coat paint.

- NOTES:**
- * Table heights of 25" (children), 27" (youth), and 32" (wheelchair) are available by request.
 - * Color of Metal Paint must be specified at the time of order.
 - * Caster Leg options are recommended for Reading/Multipurpose Tables options and not meant to be used for stationary computer workstations.
 - * For all tables with casters legs, only 2 legs will have casters, and the other legs will have levelers. This will create a "wheelbarrow" style of table which will ensure ease of mobility.
 - * Color of the Caster Option must be specified at the time of order.

Edge Option:

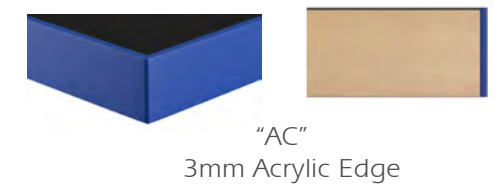

Metal Leg Options:

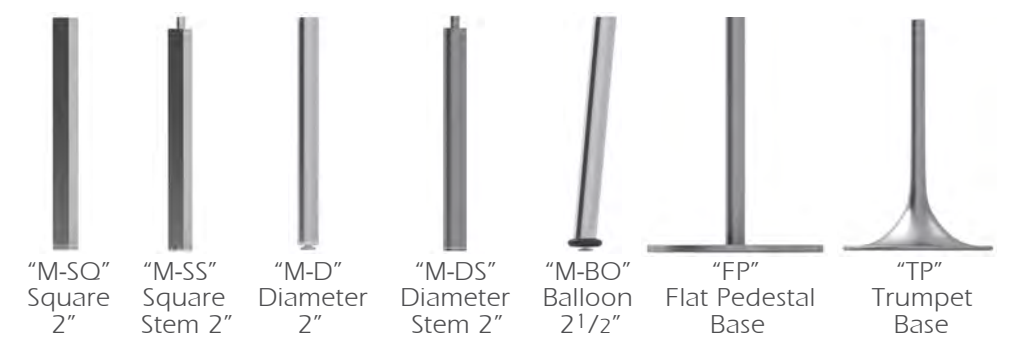

Wood Leg Options:

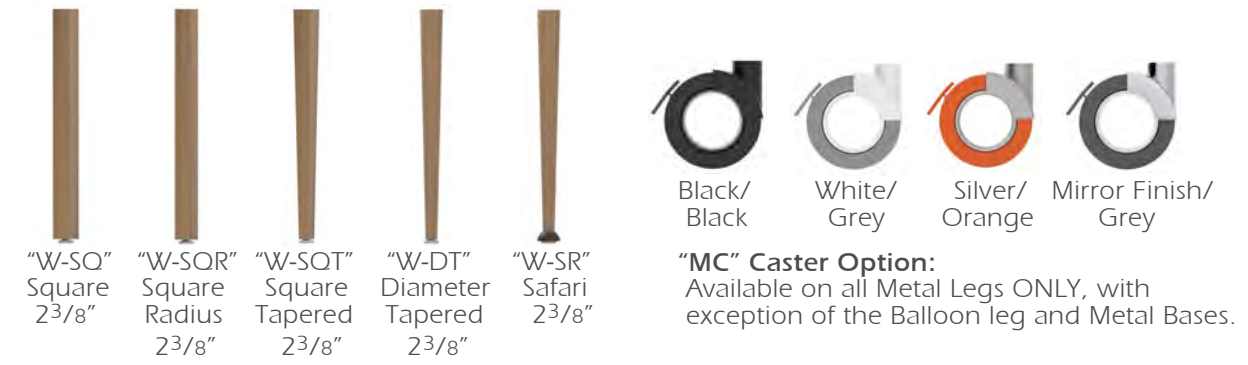

KREATIONS

MODEL NUMBER

PRODUCT

WIDTH DEPTH HEIGHT

PRICE

DESCRIPTION

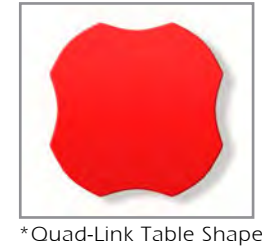

MODEL NUMBER	PRODUCT	WIDTH	DEPTH	HEIGHT	PRICE
	Quad-Link Table, 42" Width, ACRYLIC Edge;	42"	42"	29"	
	with WOOD Leg Option:	42"	42"	29"	
TB-QL42-AC-W-SQ	Square				\$ 1,065
TB-QL42-AC-W-SQR	Square Radius				\$ 1,065
TB-QL42-AC-W-SQT	Square Tapered				\$ 1,220
TB-QL42-AC-W-DT	Diameter Tapered				\$ 1,350
TB-QL42-AC-W-SR	Safari				\$ 1,355
	with METAL Leg Option:	42"	42"	29"	
TB-QL42-AC-M-SQ	Square				\$ 1,000
TB-QL42-AC-M-SS	Square & Stem				\$ 1,425
TB-QL42-AC-M-D	Diameter				\$ 1,000
TB-QL42-AC-M-DS	Diameter & Stem				\$ 1,425
TB-QL42-AC-M-BO	Balloon				\$ 1,105
TB-QL42-AC-MC-SQ	Square with Casters				\$ 1,225
TB-QL42-AC-MC-SS	Square & Stem with Casters				\$ 1,650
TB-QL42-AC-MC-D	Diameter with Casters				\$ 1,225
TB-QL42-AC-MC-DS	Diameter & Stem with Casters				\$ 1,650
TB-QL42-AC-FP1	Flat Pedestal 19" H	42"	42"	19"	\$ 1,555
TB-QL42-AC-FP2	Flat Pedestal 29" H	42"	42"	29"	\$ 1,555
TB-QL42-AC-FP3	Flat Pedestal 42" H	42"	42"	42"	\$ 1,630
TB-QL42-AC-TP1	Trumpet 19" H	42"	42"	19"	\$ 1,275
TB-QL42-AC-TP2	Trumpet 29" H	42"	42"	29"	\$ 1,275
TB-QL42-AC-TP3	Trumpet 42" H	42"	42"	42"	\$ 1,455

Each Table Top is constructed using a 1" thick top with a Plastic Laminate top surface.
All Metal legs are coated electrostatically with an epoxy powder coat paint.

- NOTES:**
- * Table heights of 25" (children), 27" (youth), and 32" (wheelchair) are available by request.
 - * Color of Metal Paint must be specified at the time of order.
 - * Caster Leg options are recommended for Reading/Multipurpose Tables options and not meant to be used for stationary computer workstations.
 - * For all tables with casters legs, only 2 legs will have casters, and the other legs will have levelers. This will create a "wheelbarrow" style of table which will ensure ease of mobility.
 - * Color of the Caster Option must be specified at the time of order.

Edge Option:

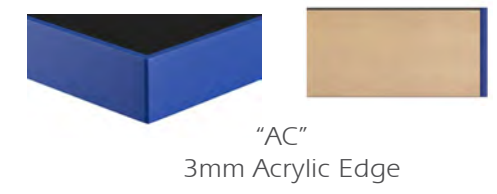

Metal Leg Options:

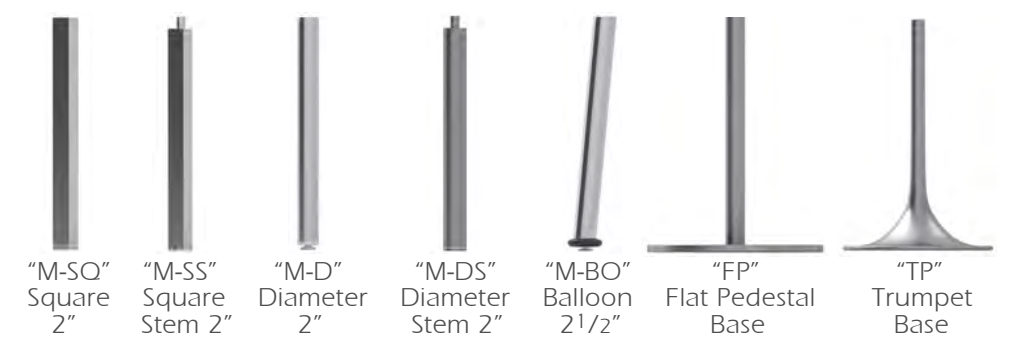

Wood Leg Options:

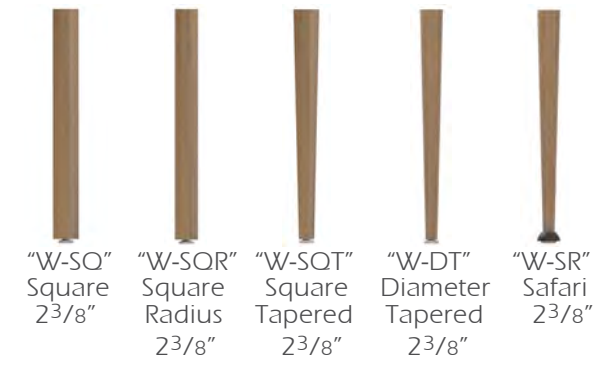

"MC" Caster Option:
Available on all Metal Legs ONLY, with exception of the Balloon leg and Metal Bases.

KREATIONS

MODEL NUMBER

PRODUCT

WIDTH DEPTH HEIGHT

PRICE

DESCRIPTION



*Shown Above:
TB-QL48-AC-M-D



*Quad-Link Table Shape

MODEL NUMBER	PRODUCT	WIDTH	DEPTH	HEIGHT	PRICE
	Quad-Link Table, 48" Width, ACRYLIC Edge;	48"	48"	29"	
	with WOOD Leg Option:	48"	48"	29"	
TB-QL48-AC-W-SQ	Square				\$ 1,125
TB-QL48-AC-W-SQR	Square Radius				\$ 1,125
TB-QL48-AC-W-SQT	Square Tapered				\$ 1,275
TB-QL48-AC-W-DT	Diameter Tapered				\$ 1,405
TB-QL48-AC-W-SR	Safari				\$ 1,410
	with METAL Leg Option:	48"	48"	29"	
TB-QL48-AC-M-SQ	Square				\$ 1,060
TB-QL48-AC-M-SS	Square & Stem				\$ 1,480
TB-QL48-AC-M-D	Diameter				\$ 1,060
TB-QL48-AC-M-DS	Diameter & Stem				\$ 1,480
TB-QL48-AC-M-BO	Balloon				\$ 1,160
TB-QL48-AC-MC-SQ	Square with Casters				\$ 1,285
TB-QL48-AC-MC-SS	Square & Stem with Casters				\$ 1,710
TB-QL48-AC-MC-D	Diameter with Casters				\$ 1,285
TB-QL48-AC-MC-DS	Diameter & Stem with Casters				\$ 1,710
TB-QL48-AC-FP1	Flat Pedestal 19" H	48"	48"	19"	\$ 1,935
TB-QL48-AC-FP2	Flat Pedestal 29" H	48"	48"	29"	\$ 1,935
TB-QL48-AC-FP3	Flat Pedestal 42" H	48"	48"	42"	\$ 2,010
TB-QL48-AC-TP1	Trumpet 19" H	48"	48"	19"	\$ 1,330
TB-QL48-AC-TP2	Trumpet 29" H	48"	48"	29"	\$ 1,330
TB-QL48-AC-TP3	Trumpet 42" H	48"	48"	42"	\$ 1,510

Each Table Top is constructed using a 1" thick top with a Plastic Laminate top surface.
All Metal legs are coated electrostatically with an epoxy powder coat paint.

NOTES:

- * Table heights of 25" (children), 27" (youth), and 32" (wheelchair) are available by request.
- * Color of Metal Paint must be specified at the time of order.
- * Caster Leg options are recommended for Reading/Multipurpose Tables options and not meant to be used for stationary computer workstations.
- * For all tables with casters legs, only 2 legs will have casters, and the other legs will have levelers. This will create a "wheelbarrow" style of table which will ensure ease of mobility.
- * Color of the Caster Option must be specified at the time of order.

Edge Option:

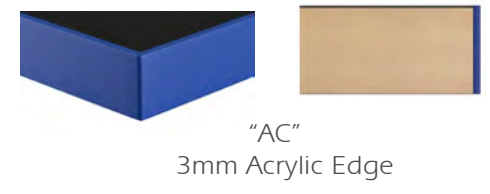

"AC"
3mm Acrylic Edge

Metal Leg Options:

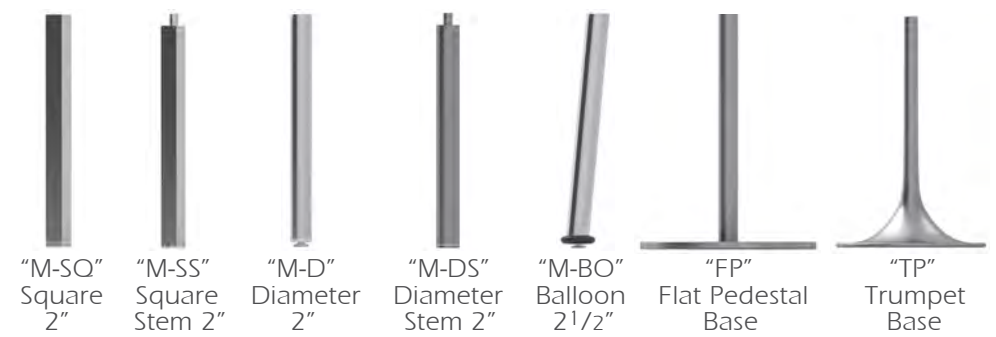

"M-SQ" Square 2"
"M-SS" Square Stem 2"
"M-D" Diameter 2"
"M-DS" Diameter Stem 2"
"M-BO" Balloon 2 1/2"
"FP" Flat Pedestal Base
"TP" Trumpet Base

Wood Leg Options:

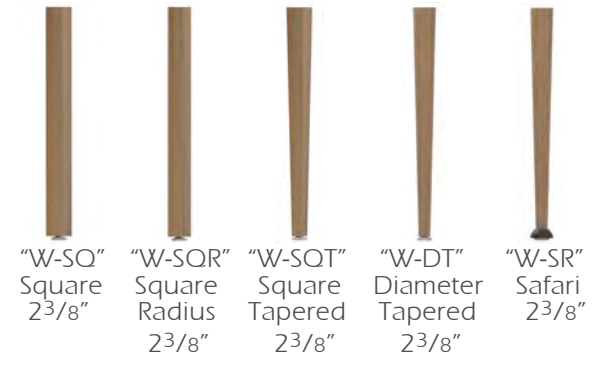

"W-SQ" Square 2 3/8"
"W-SQR" Square Radius 2 3/8"
"W-SQT" Square Tapered 2 3/8"
"W-DT" Diameter Tapered 2 3/8"
"W-SR" Safari 2 3/8"



"MC" Caster Option:
Available on all Metal Legs ONLY, with exception of the Balloon leg and Metal Bases.

KREATIONS

MODEL NUMBER

PRODUCT

WIDTH DEPTH HEIGHT

PRICE

DESCRIPTION



*Shown Above:
TB-QL60-AC-M-D



*Quad-Link Table Shape

- TB-QL60-AC-W-SQ
- TB-QL60-AC-W-SQR
- TB-QL60-AC-W-SQT
- TB-QL60-AC-W-DT
- TB-QL60-AC-W-SR

Quad-Link Table, 60" Width,
ACRYLIC Edge;
with WOOD Leg Option:
Square
Square Radius
Square Tapered
Diameter Tapered
Safari

60" 60" 29"

- \$ 1,525
- \$ 1,525
- \$ 1,715
- \$ 1,875
- \$ 1,885

- TB-QL60-AC-M-SQ
- TB-QL60-AC-M-SS
- TB-QL60-AC-M-D
- TB-QL60-AC-M-DS
- TB-QL60-AC-M-BO
- TB-QL60-AC-MC-SQ
- TB-QL60-AC-MC-SS
- TB-QL60-AC-MC-D
- TB-QL60-AC-MC-DS

with METAL Leg Option:
Square
Square & Stem
Diameter
Diameter & Stem
Balloon
Square with Casters
Square & Stem with Casters
Diameter with Casters
Diameter & Stem with Casters

60" 60" 29"

- \$ 1,445
- \$ 1,975
- \$ 1,445
- \$ 1,975
- \$ 1,570
- \$ 1,730
- \$ 2,255
- \$ 1,730
- \$ 2,255

Each Table Top is constructed using a 1" thick top with a Plastic Laminate top surface.
All Metal legs are coated electrostatically with an epoxy powder coat paint.

NOTES:

- * Table heights of 25" (children), 27" (youth), and 32" (wheelchair) are available by request.
- * Color of Metal Paint must be specified at the time of order.
- * Caster Leg options are recommended for Reading/Multipurpose Tables options and not meant to be used for stationary computer workstations.
- * For all tables with casters legs, only 2 legs will have casters, and the other legs will have levelers. This will create a "wheelbarrow" style of table which will ensure ease of mobility.
- * Color of the Caster Option must be specified at the time of order.

Edge Option:



"AC"
3mm Acrylic Edge

Metal Leg Options:



"M-SQ" Square 2"
"M-SS" Square Stem 2"
"M-D" Diameter 2"
"M-DS" Diameter Stem 2"
"M-BO" Balloon 2 1/2"

Wood Leg Options:



"W-SQ" Square 2 3/8"
"W-SQR" Square Radius 2 3/8"
"W-SQT" Square Tapered 2 3/8"
"W-DT" Diameter Tapered 2 3/8"
"W-SR" Safari 2 3/8"



"MC" Caster Option:
Available on all Metal Legs ONLY, with exception of the Balloon leg and Metal Bases.

Table of Contents 2-3

Product Materials & Finishes 4-7

3100 Series 8-9



3200 Series 10-11



4100 Series 12-13



4200 Series 14-15



5100 Series 16-17



6100 Series 18-19



7101 Series 18-19



8100 Series 20-21



8200 Series 20-21



9100 Series 22-23



9200 Series 22-23



Warranty 24-25

Terms & Conditions IBC

WOODS & FINISHES:

Natural Maple Standard



Natural Clear – M-NA

Maple Finishes

The following stains are available, add 10% to list



Honey Oak – M-HO



Castle Oak – M-CO



Richmond Cherry – M-RC



Mahogany – M-MA



Victorian Cherry – M-VI



Java – M-JA



Wenge – M-WE



English Oak – M-EN

Natural Red Oak Standard



Natural Clear – O-NA

Red Oak Finishes

The following stains are available, add 10% to list



Castle Oak – O-CO



Honey Oak – O-HO



English Oak – O-EN



Victorian Cherry – O-VI



Mahogany – O-MA



Richmond Cherry – O-RC



Java – O-JA



Wenge – O-WE

Natural Cherry Add 20% to list



Natural Clear – C-NA

Cherry Finishes

The following stains are available, add 30% to list



Honey Oak – C-HO



Richmond Cherry – C-RC

Natural Walnut Add 20% to list



Natural Clear – W-NA

Walnut Finishes

The following stain is available, add 30% to list



Java – W-JA

WOOD GRAIN LAMINATES:
Melamine Laminate Options



Hardrock Maple – L303



Fidlar's Maple – L363



Cognac Cherry – L448



Cherry Blossom – L449



Almond Cherry – L457



Samba Cherry – L460



Lambada Cherry – L461



Shiraz Cherry – L472



Tuxedo – 477



Hot Cinnamon – L480



Caramel Maple – L490



Antigua – L498



Borneo – L500

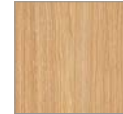

Ginger Snap Fruitwood – L518



Very Chic – L666

METAL PAINT COLORS:
(For Metal Panels & Legs)



Sparkle Silver – S11



Navy – B17



Charcoal – A230



Beige – H23



Blue – B11



Grey – A16



Antique White – W11



Teal – HG266



Black – N49



Ruby – R7



Green – G58



Black Sandtex – N31
Textured Finish



White – PS-111-W374

ACRYLIC EDGE COLORS:
(For Laminate Top Option Only)



Antique White – AC-W11



White – AC-SW811



Black – AC-N49



Charcoal – AC-A230



Grey – AC-A16



Ruby – AC-R7



Blue – AC-B11



Navy – AC-B17

HIGH PRESSURE LAMINATE: Work surface laminate shall be .050" thick and used with balancing backer sheet of no less than .028" thick. Laminate shall conform to standards set by the National Electrical Manufacturers' Association (NEMA).

FINISHING PROCEDURES: All materials shall be inspected and treated with a final sanding and polishing operation before any staining and final finishing can be performed. All machine and mill marks are removed. Once the polishing and sanding has been performed, the furniture will then undergo the following stain and finishing procedures:

- Step 1 A base stain will be uniformly applied, wiped and then allowed to dry under factory controlled conditions.
- Step 2 A uniform coat of sealer will be applied and allowed to dry.
- Step 3 Sealer will be lightly sanded using 240 grit silicon paper.
- Step 4 A catalytic lacquer of 34-45 degree sheen is evenly applied and allowed to dry under factory controlled conditions.

METAL FINISHING PROCEDURES: All metal components are thoroughly cleaned and coated electrostatically with an epoxy powder coat paint finish. The metal components are then oven baked and cured for a lasting finish.

NAVIGATE

MODEL NUMBER	PRODUCT	WIDTH	LENGTH	HEIGHT TOP / OVERALL
 *Monitor Arm and RFID Equipment shown are NOT Included	3100 Series; FIXED Unit Steel Panels, 6" Depth Patron Ledge, 3" Grommet, Wire Management;	34 1/4"	77"	30" / 36"
	NV-3100-L-F	LAMINATE Top & Ledge		
	NV-3100-C-F	CUSTOM Top & Ledge		



3101 Series; MOBILE Unit 4" Casters Steel Panels, 6" Depth Patron Ledge, 3" Grommet, Wire Management;	34 1/4"	77"	30" / 36"
NV-3101-L-M	LAMINATE Top & Ledge		
NV-3101-C-M	CUSTOM Top & Ledge		

PRICE	DESCRIPTION
\$ 10,255	<p>WORKSURFACE & LEDGE: Tops are constructed of 1" thick 3-ply particleboard core. The Tops' surfaces are laminated with a .050" thick high pressure plastic laminate sheet and bottom surface laminated with a backing sheet not less than .020" thick for balanced construction. All edges will be banded with a 1/8" thick acrylic edge.</p> <p>METAL ASSEMBLY: Metal components consists of a 16 gauge non-perforated main panel, a 16" gauge perforated return panel, and 2 1/2" diameter legs. As a standard the Main panel, Return panel and Legs will consist of ONE paint color option. Dual color combinations are available by request only. The application for Dual color finishes will be the following: Main panel with color #1, perforated return panel and legs with color #2.</p> <p>CASTER (Unit 3101 only): The unit comes with a 4" diameter swivel caster with brake.</p> <p>DECORATIVE PANEL: The front of the unit has a 1/4" thick frosted acrylic panel with diameter stand-off hardware. For custom decorative acrylic panel, please inquire with Palmieri for pricing.</p> <p>NOTES: * Custom Top and Ledge materials may include Solid Surface, Quartz, or Natural Stone. * Monitor, Monitor Arm, and RFID Equipment are NOT included. * Grommet, Wire Management, and RFID cut out location are included in the price. * Standard work surface height is 30". Optional ADA height of 32" is available by request. * Metal Paint color(s) for the Panels and Legs must be specified at the time of order.</p>
Inquire for Quote	

\$ 10,530
Inquire for Quote

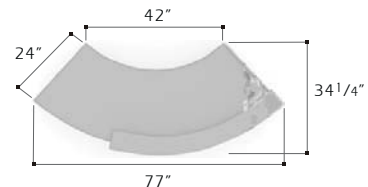

NAVIGATE



MODEL NUMBER	PRODUCT	WIDTH	LENGTH	HEIGHT TOP / OVERALL
 *Monitor Arm and RFID Equipment shown are NOT Included	3200 Series; FIXED Unit Wood/Steel Panels, 6" Depth Patron Ledge, 3" Grommet, Wire Management;	34 1/4"	77"	30" / 36"
	NV-3200-L-F	LAMINATE Top & Ledge		
	NV-3200-C-F	CUSTOM Top & Ledge		



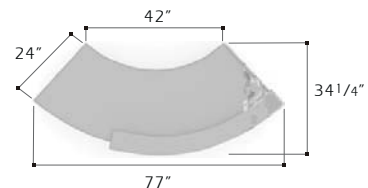

3201 Series; MOBILE Unit 4" Casters Wood/Steel Panels, 6" Depth Patron Ledge, 3" Grommet, Wire Management;	34 1/4"	77"	30" / 36"
NV-3201-L-M	LAMINATE Top & Ledge		
NV-3201-C-M	CUSTOM Top & Ledge		

PRICE	DESCRIPTION
\$ 11,055	<p>WORKSURFACE & LEDGE: Tops are constructed of 1" thick 3-ply particleboard core. The Tops' surfaces are laminated with a .050" thick high pressure plastic laminate sheet and bottom surface laminated with a backing sheet not less than .020" thick for balanced construction. All edges will be banded with a 1/8" thick acrylic edge.</p> <p>METAL ASSEMBLY: Metal components consists of a 16 gauge perforated return panel, and 2 1/2" diameter legs. As a standard the Return panel and Legs will consist of ONE paint color option.</p> <p>WOOD PANEL: The main panel's construction consists of a 1" thick 4-ply particleboard core with plain sliced veneer both faces.</p> <p>CASTER (Unit 3201 only): The unit comes with a 4" diameter swivel caster with brake.</p> <p>DECORATIVE PANEL: The front of the unit has a 1/4" thick frosted acrylic panel with diameter stand-off hardware. For custom decorative acrylic panel, please inquire with Palmieri for pricing.</p> <p>NOTES: * Custom Top and Ledge materials may include Solid Surface, Quartz, or Natural Stone. * Monitor, Monitor Arm, and RFID Equipment are NOT included. * Grommet, Wire Management, and RFID cut out location are included in the price. * Standard work surface height is 30". Optional ADA height of 32" is available by request. * Metal Paint color for the Return Panel and Legs must be specified at the time of order.</p>
Inquire for Quote	
\$ 11,330	
Inquire for Quote	

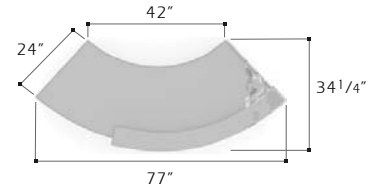

MODEL NUMBER	PRODUCT	WIDTH	LENGTH	HEIGHT TOP / OVERALL	PRICE	DESCRIPTION
	4100 Series; FIXED Unit Steel Panels, 6" Depth Patron Ledge.	34 1/4"	77"	30" / 36"		
NV-4100-L-F	LAMINATE Top & Ledge				\$ 10,225	WORKSURFACE & LEDGE: Tops are constructed of 1" thick 3-ply particleboard core. The Tops' surfaces are laminated with a .050" thick high pressure plastic laminate sheet and bottom surface laminated with a backing sheet not less than .020" thick for balanced construction. All edges will be banded with a 1/8" thick acrylic edge.
NV-4100-C-F	CUSTOM Top & Ledge				Inquire for Quote	METAL ASSEMBLY: Metal components consists of a 16 gauge non-perforated main panel, a 16" gauge perforated return panel, and 2 1/2" diameter legs. As a standard the Main panel, Return panel and Legs will consist of ONE paint color option. Dual color combinations are available by request only. The application for Dual color finishes will be the following: Main panel with color #1, perforated return panel and legs with color #2.
						CASTER (Unit 4101 only): The unit comes with a 4" diameter swivel caster with brake.
						DECORATIVE PANEL: The front of the unit has a 1/4" thick frosted acrylic panel with diameter stand-off hardware. For custom decorative acrylic panel, please inquire with Palmieri for pricing.
	4101 Series; MOBILE Unit 4" Casters Steel Panels, 6" Depth Patron Ledge.	34 1/4"	77"	30" / 36"		
NV-4101-L-M	LAMINATE Top & Ledge				\$ 10,500	NOTES: * Custom Top and Ledge materials may include Solid Surface, Quartz, or Natural Stone. * Standard work surface height is 30". Optional ADA height of 32" is available by request. * Metal Paint color(s) for the Panels and Legs must be specified at the time of order.
NV-4101-C-M	CUSTOM Top & Ledge				Inquire for Quote	





MODEL NUMBER	PRODUCT	WIDTH	LENGTH	HEIGHT TOP / OVERALL
	4200 Series; FIXED Unit Wood/Steel Panels, 6" Depth Patron Ledge.	34 1/4"	77"	30" / 36"
	NV-4200-L-F	LAMINATE Top & Ledge		
NV-4200-C-F	CUSTOM Top & Ledge			

	4201 Series; MOBILE Unit 4" Casters Wood/Steel Panels, 6" Depth Patron Ledge.	34 1/4"	77"	30" / 36"
	NV-4201-L-M	LAMINATE Top & Ledge		
NV-4201-C-M	CUSTOM Top & Ledge			

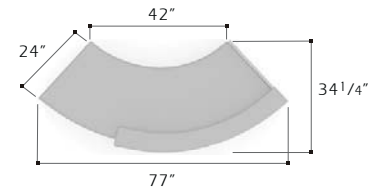
PRICE	DESCRIPTION
\$ 11,020	<p>WORKSURFACE & LEDGE: Tops are constructed of 1" thick 3-ply particleboard core. The Tops' surfaces are laminated with a .050" thick high pressure plastic laminate sheet and bottom surface laminated with a backing sheet not less than .020" thick for balanced construction. All edges will be banded with a 1/8" thick acrylic edge.</p> <p>METAL ASSEMBLY: Metal components consists of a 16 gauge perforated return panel, and 2 1/2" diameter legs. As a standard the Return panel and Legs will consist of ONE paint color option.</p> <p>WOOD PANEL: The main panel's construction consists of a 1" thick 4-ply particleboard core with plain sliced veneer both faces.</p> <p>CASTER (Unit 4201 only): The unit comes with a 4" diameter swivel caster with brake.</p> <p>DECORATIVE PANEL: The front of the unit has a 1/4" thick frosted acrylic panel with diameter stand-off hardware. For custom decorative acrylic panel, please inquire with Palmieri for pricing.</p> <p>NOTES: * Custom Top and Ledge materials may include Solid Surface, Quartz, or Natural Stone. * Standard work surface height is 30". Optional ADA height of 32" is available by request. * Metal Paint color for the Return Panel and Legs must be specified at the time of order.</p>
Inquire for Quote	
\$ 11,295	
Inquire for Quote	



MODEL NUMBER	PRODUCT	WIDTH	LENGTH	HEIGHT TOP / OVERALL
	5100 Series; FIXED Unit Steel Panel, 6" Depth Patron Ledge.	35 ³ / ₈ "	83 ¹ / ₂ "	30" / 36"
	NV-5100-L-F	LAMINATE Top & Ledge		
	NV-5100-C-F	CUSTOM Top & Ledge		

	5101 Series; MOBILE Unit 4" Casters Steel Panel, 6" Depth Patron Ledge.	35 ³ / ₈ "	83 ¹ / ₂ "	30" / 36"
	NV-5101-L-M	LAMINATE Top & Ledge		
	NV-5101-C-M	CUSTOM Top & Ledge		

PRICE	DESCRIPTION
\$ 11,305	<p>WORKSURFACE & LEDGE: Tops are constructed of 1" thick 3-ply particleboard core. The Tops' surfaces are laminated with a .050" thick high pressure plastic laminate sheet and bottom surface laminated with a backing sheet not less than .020" thick for balanced construction. All edges will be banded with a 1/8" thick acrylic edge.</p> <p>METAL ASSEMBLY: Metal components consists of a 16 gauge non-perforated main panel and 2 1/2" diameter legs. As a standard the Main panel and Legs will consist of ONE paint color option. Dual color combinations are available by request only. The application for Dual color finishes will be the following: Main panel with color #1, Legs with color #2.</p> <p>CASTER (Unit 5101 only): The unit comes with a 4" diameter swivel caster with brake.</p>

DECORATIVE PANEL:
The front of the unit has a 1/4" thick frosted acrylic panel with diameter stand-off hardware. For custom decorative acrylic panel, please inquire with Palmieri for pricing.

NOTES:
* Custom Top and Ledge materials may include Solid Surface, Quartz, or Natural Stone.
* Standard work surface height is 30". Optional ADA height of 32" is available by request.
* Metal Paint color(s) for the Panels and Legs must be specified at the time of order.

\$ 11,580

Inquire for Quote

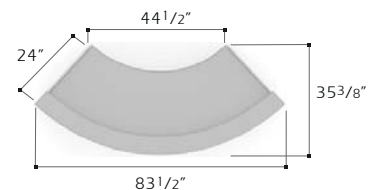

	MODEL NUMBER	PRODUCT	WIDTH	LENGTH	HEIGHT TOP / OVERALL
 <p>*Monitor Arm and RFID Equipment shown are NOT Included</p>		6100 Series; FIXED Unit Steel Panels, 2 Lockable Steel Doors, Fixed Interior Shelf, Wire Management,	40"	92 1/2"	36"
	NV-6100-L-F	LAMINATE Top			
	NV-6100-C-F	CUSTOM Top			

PRICE	DESCRIPTION
\$ 18,945	<p>WORKSURFACE: Tops are constructed of 1" thick 3-ply particleboard core. The Tops' surfaces are laminated with a .050" thick high pressure plastic laminate sheet and bottom surface laminated with a backing sheet not less than .020" thick for balanced construction. All edges will be banded with a 1/8" thick acrylic edge.</p> <p>METAL ASSEMBLY: Metal components consists of a 16 gauge non-perforated bowed service end, a 16 gauge perforated locking cupboard unit, and 2 1/2" diameter legs. As a standard the Bowed Service End, Cupboard unit, and Legs will consist of ONE paint color option. Dual color combinations are available by request only. The application for Dual color finishes will be the following: Bowed Service End with color #1, Cupboard and Legs with color #2.</p>
Inquire for Quote	

DECORATIVE PANEL:
The front of the unit has a 1/4" thick frosted acrylic panel with diameter stand-off hardware. For custom decorative acrylic panel, please inquire with Palmieri for pricing.

- NOTES:**
- * Custom Top materials may include Solid Surface, Quartz, or Natural Stone.
 - * Monitor, Monitor Arm, and RFID Equipment are NOT included.
 - * Grommet, Wire Management, and RFID cut out location are included in the price.
 - * Metal Paint color(s) for the Panels and Legs must be specified at the time of order.

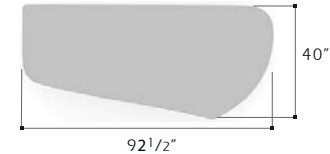





		7101 Series; MOBILE Unit 4" Casters Lockable Door Steel Panels,	20"	20"	30"
	NV-7101-L-M	LAMINATE Top			
	NV-7101-C-M	CUSTOM Top			





\$ 4,600	<p>WORKSURFACE: Same as worksurface for unit 6100 shown above.</p> <p>METAL ASSEMBLY: Metal components consists of a 16 gauge perforated locking cupboard unit. As a standard the unit will consist of ONE paint color option.</p>
Inquire for Quote	<p>CASTER: The unit comes with a 4" diameter swivel caster with brake.</p>

- NOTES:**
- * Custom Top materials may include Solid Surface, Quartz, or Natural Stone.
 - * Metal Paint color for the unit must be specified at the time of order.

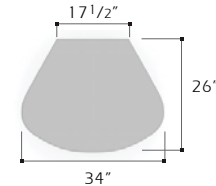
NAVIGATE







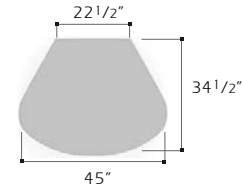









	MODEL NUMBER	PRODUCT	WIDTH	LENGTH	HEIGHT TOP / OVERALL	PRICE	DESCRIPTION
 <p>*Monitor with Arm shown NOT Included</p>		8100 Series; A.D.A. FIXED Unit, Steel Panels, 3" Grommet;	26"	34"	32"		<p>WORKSURFACE: Tops are constructed of 1" thick 3-ply particleboard core. The Tops' surfaces are laminated with a .050" thick high pressure plastic laminate sheet and bottom surface laminated with a backing sheet not less than .020" thick for balanced construction. All edges will be banded with a 1/8" thick acrylic edge.</p> <p>METAL ASSEMBLY: Metal components consists of a 16 gauge non-perforated Bowed or Concave (ADA option) Service End, and 2 1/2" diameter legs. As a standard the Bowed or Concave Service End, and Legs will consist of ONE paint color option. Dual color combinations are available by request only. The application for Dual color finishes will be the following: Bowed or Concave Service End with color #1, and legs with color #2.</p> <p>CASTER (Units 8101 & 8201 only): The unit comes with a 4" diameter swivel caster with brake.</p> <p>DECORATIVE PANEL: The front of the unit has a 1/4" thick frosted acrylic panel with diameter stand-off hardware. For custom decorative acrylic panel, please inquire with Palmieri for pricing.</p> <p>NOTES: * Custom Top and Ledge materials may include Solid Surface, Quartz, or Natural Stone. * Monitor, and Monitor Arm are NOT included. * Grommet is included in the price. * Metal Paint color(s) for the Panels and Legs must be specified at the time of order.</p>
	NV-8100-L-F	LAMINATE Top				\$ 11,210	
	NV-8100-C-F	CUSTOM Top				Inquire for Quote	
 <p>*Monitor with Arm shown NOT Included</p>		8101 Series; A.D.A. MOBILE Unit, 4" Casters Steel Panels, 3" Grommet;	26"	34"	32"		<p>CASTER (Units 8101 & 8201 only): The unit comes with a 4" diameter swivel caster with brake.</p> <p>DECORATIVE PANEL: The front of the unit has a 1/4" thick frosted acrylic panel with diameter stand-off hardware. For custom decorative acrylic panel, please inquire with Palmieri for pricing.</p> <p>NOTES: * Custom Top and Ledge materials may include Solid Surface, Quartz, or Natural Stone. * Monitor, and Monitor Arm are NOT included. * Grommet is included in the price. * Metal Paint color(s) for the Panels and Legs must be specified at the time of order.</p>
	NV-8101-L-M	LAMINATE Top				\$ 11,400	
	NV-8101-C-M	CUSTOM Top				Inquire for Quote	
 <p>*Monitor with Arm shown NOT Included</p>		8200 Series; FIXED Unit, Steel Panels, 3" Grommet;	26"	34"	36"		<p>CASTER (Units 8101 & 8201 only): The unit comes with a 4" diameter swivel caster with brake.</p> <p>DECORATIVE PANEL: The front of the unit has a 1/4" thick frosted acrylic panel with diameter stand-off hardware. For custom decorative acrylic panel, please inquire with Palmieri for pricing.</p> <p>NOTES: * Custom Top and Ledge materials may include Solid Surface, Quartz, or Natural Stone. * Monitor, and Monitor Arm are NOT included. * Grommet is included in the price. * Metal Paint color(s) for the Panels and Legs must be specified at the time of order.</p>
	NV-8200-L-F	LAMINATE Top				\$ 12,410	
	NV-8200-C-F	CUSTOM Top				Inquire for Quote	
 <p>*Monitor with Arm shown NOT Included</p>		8201 Series; MOBILE Unit, 4" Casters Steel Panels, 3" Grommet;	26"	34"	36"		<p>CASTER (Units 8101 & 8201 only): The unit comes with a 4" diameter swivel caster with brake.</p> <p>DECORATIVE PANEL: The front of the unit has a 1/4" thick frosted acrylic panel with diameter stand-off hardware. For custom decorative acrylic panel, please inquire with Palmieri for pricing.</p> <p>NOTES: * Custom Top and Ledge materials may include Solid Surface, Quartz, or Natural Stone. * Monitor, and Monitor Arm are NOT included. * Grommet is included in the price. * Metal Paint color(s) for the Panels and Legs must be specified at the time of order.</p>
	NV-8201-L-M	LAMINATE Top				\$ 12,600	
	NV-8201-C-M	CUSTOM Top				Inquire for Quote	

































MODEL NUMBER	PRODUCT	WIDTH	LENGTH	HEIGHT TOP / OVERALL	PRICE	DESCRIPTION
 <p>*Monitor Arm and RFID Equipment shown are NOT Included</p>	9100 Series; A.D.A. FIXED Unit, Steel Panels;	34 1/2"	45"	32"		<p>WORKSURFACE: Tops are constructed of 1" thick 3-ply particleboard core. The Tops' surfaces are laminated with a .050" thick high pressure plastic laminate sheet and bottom surface laminated with a backing sheet not less than .020" thick for balanced construction. All edges will be banded with a 1/8" thick acrylic edge.</p> <p>METAL ASSEMBLY: Metal components consists of a 16 gauge non-perforated Bowed or Concave (ADA option) Service End, and 2 1/2" diameter legs. As a standard the Bowed or Concave Service End, and Legs will consist of ONE paint color option. Dual color combinations are available by request only. The application for Dual color finishes will be the following: Bowed or Concave Service End with color #1, and legs with color #2.</p> <p>CASTER (Units 8101 & 8201 only): The unit comes with a 4" diameter swivel caster with brake.</p> <p>DECORATIVE PANEL: The front of the unit has a 1/4" thick frosted acrylic panel with diameter stand-off hardware. For custom decorative acrylic panel, please inquire with Palmieri for pricing.</p> <p>NOTES: * Custom Top and Ledge materials may include Solid Surface, Quartz, or Natural Stone. * Monitor, Monitor Arm, and RFID Equipment are NOT included. * Grommet, Wire Management, and RFID cut out location are included in the price. * Metal Paint color(s) for the Panels and Legs must be specified at the time of order.</p>
	NV-9100-L-F	LAMINATE Top	\$ 11,315	Inquire for Quote		
	NV-9100-C-F	CUSTOM Top				
 <p>*Monitor Arm and RFID Equipment shown are NOT Included</p>	9101 Series; A.D.A. MOBILE Unit, 4" Casters Steel Panels;	34 1/2"	45"	32"		<p>CASTER (Units 8101 & 8201 only): The unit comes with a 4" diameter swivel caster with brake.</p> <p>DECORATIVE PANEL: The front of the unit has a 1/4" thick frosted acrylic panel with diameter stand-off hardware. For custom decorative acrylic panel, please inquire with Palmieri for pricing.</p> <p>NOTES: * Custom Top and Ledge materials may include Solid Surface, Quartz, or Natural Stone. * Monitor, Monitor Arm, and RFID Equipment are NOT included. * Grommet, Wire Management, and RFID cut out location are included in the price. * Metal Paint color(s) for the Panels and Legs must be specified at the time of order.</p>
	NV-9101-L-M	LAMINATE Top	\$ 11,495	Inquire for Quote		
	NV-9101-C-M	CUSTOM Top				
 <p>*Monitor Arm and RFID Equipment shown are NOT Included</p>	9200 Series; FIXED Unit, Steel Panels;	34 1/2"	45"	36"		<p>WORKSURFACE: Tops are constructed of 1" thick 3-ply particleboard core. The Tops' surfaces are laminated with a .050" thick high pressure plastic laminate sheet and bottom surface laminated with a backing sheet not less than .020" thick for balanced construction. All edges will be banded with a 1/8" thick acrylic edge.</p> <p>METAL ASSEMBLY: Metal components consists of a 16 gauge non-perforated Bowed or Concave (ADA option) Service End, and 2 1/2" diameter legs. As a standard the Bowed or Concave Service End, and Legs will consist of ONE paint color option. Dual color combinations are available by request only. The application for Dual color finishes will be the following: Bowed or Concave Service End with color #1, and legs with color #2.</p> <p>CASTER (Units 8101 & 8201 only): The unit comes with a 4" diameter swivel caster with brake.</p> <p>DECORATIVE PANEL: The front of the unit has a 1/4" thick frosted acrylic panel with diameter stand-off hardware. For custom decorative acrylic panel, please inquire with Palmieri for pricing.</p> <p>NOTES: * Custom Top and Ledge materials may include Solid Surface, Quartz, or Natural Stone. * Monitor, Monitor Arm, and RFID Equipment are NOT included. * Grommet, Wire Management, and RFID cut out location are included in the price. * Metal Paint color(s) for the Panels and Legs must be specified at the time of order.</p>
	NV-9200-L-F	LAMINATE Top	\$ 12,510	Inquire for Quote		
	NV-9200-C-F	CUSTOM Top				
 <p>*Monitor Arm and RFID Equipment shown are NOT Included</p>	9201 Series; MOBILE Unit, 4" Casters Steel Panels;	34 1/2"	45"	36"		<p>WORKSURFACE: Tops are constructed of 1" thick 3-ply particleboard core. The Tops' surfaces are laminated with a .050" thick high pressure plastic laminate sheet and bottom surface laminated with a backing sheet not less than .020" thick for balanced construction. All edges will be banded with a 1/8" thick acrylic edge.</p> <p>METAL ASSEMBLY: Metal components consists of a 16 gauge non-perforated Bowed or Concave (ADA option) Service End, and 2 1/2" diameter legs. As a standard the Bowed or Concave Service End, and Legs will consist of ONE paint color option. Dual color combinations are available by request only. The application for Dual color finishes will be the following: Bowed or Concave Service End with color #1, and legs with color #2.</p> <p>CASTER (Units 8101 & 8201 only): The unit comes with a 4" diameter swivel caster with brake.</p> <p>DECORATIVE PANEL: The front of the unit has a 1/4" thick frosted acrylic panel with diameter stand-off hardware. For custom decorative acrylic panel, please inquire with Palmieri for pricing.</p> <p>NOTES: * Custom Top and Ledge materials may include Solid Surface, Quartz, or Natural Stone. * Monitor, Monitor Arm, and RFID Equipment are NOT included. * Grommet, Wire Management, and RFID cut out location are included in the price. * Metal Paint color(s) for the Panels and Legs must be specified at the time of order.</p>
	NV-9201-L-M	LAMINATE Top	\$ 12,695	Inquire for Quote		
	NV-9201-C-M	CUSTOM Top				



NAVIGATE

Introduction	1		Gilda	26-27
Table of Contents	2-7			
Product Materials & Finishes	8-13		Grace	28-29
Seating (Plastic & Wood/Metal)	14-59		Jade-P	30-31
 3-D Colour	14-17		Kicca	32-35
 Aries	18-19		Kuadra	36-37
 Boa	20-21		Manu	38-39
 Balloon	20-21		Milo	40-41
 Empire	22-23		Mya	40-41
 Fast	24-25		Nest	42-43
 Fusion	26-27			

	Nine	44-45	Lounge Seating		62-73
	Ongo	46-47		America	62-63
	Orbit	48-49		Bloom	64-65
	Pasha	50-51		Corfu	66-67
	Sabrina	52-53		Molecule	68-71
	Sixty	52-53		Penny	72-73
	Snow	54-55	Task Seating		74-77
	Tibro	56-57		Aqua	74-75
	Vesper-S	58-59		Link	74-75
	Web	60-61		Rite	76-77
				Seven	76-77

Wood Seating		78-105		Silver Sled	102-103
	Ambassador	78-79		Wogg 50	102-103
	Aspen	80-81		Wood Stool	104-105
	Avondale	82-83			
	Bulldog	84-89			
	Carlo Junior	90-91		Warranty	106
	Henry	92-93		Terms & Conditions	107
	Hudson	94-95			
	Lido	96-99			
	Montana	100-101			

MIRAGE FABRICS:

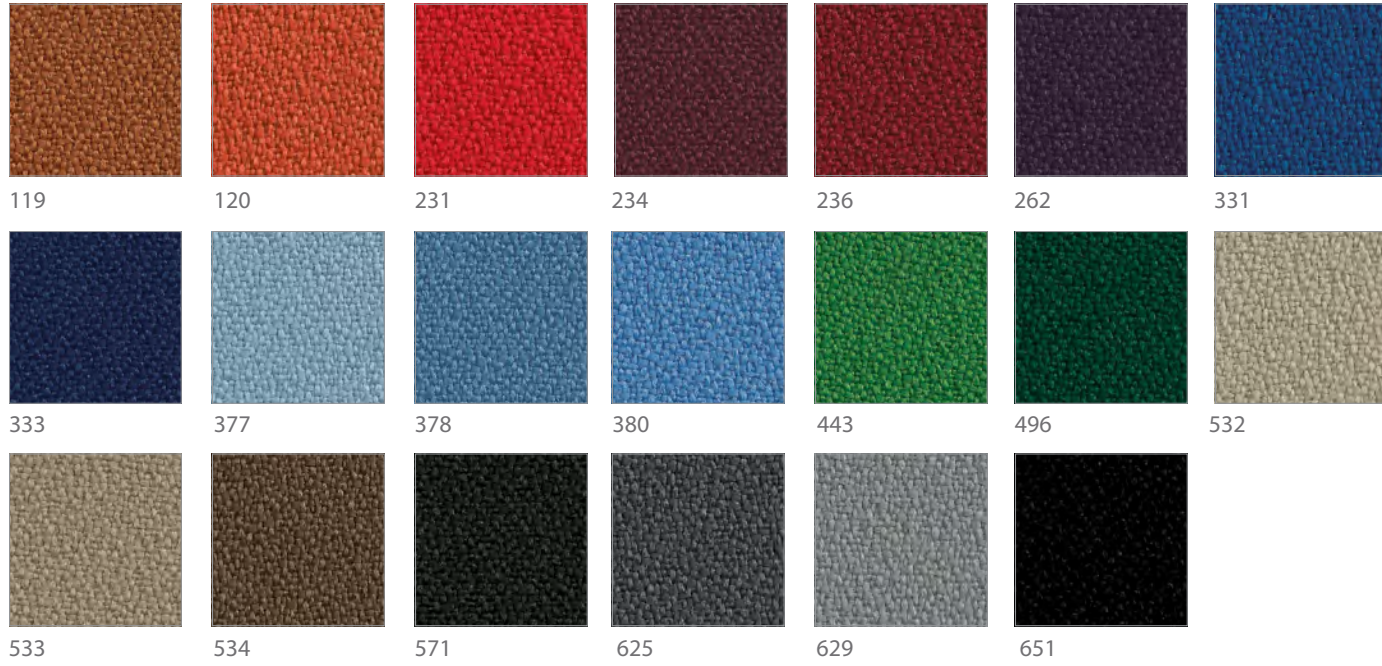

TORRE SOFT HALF GRAIN LEATHER:



NORD WOOL FABRICS:

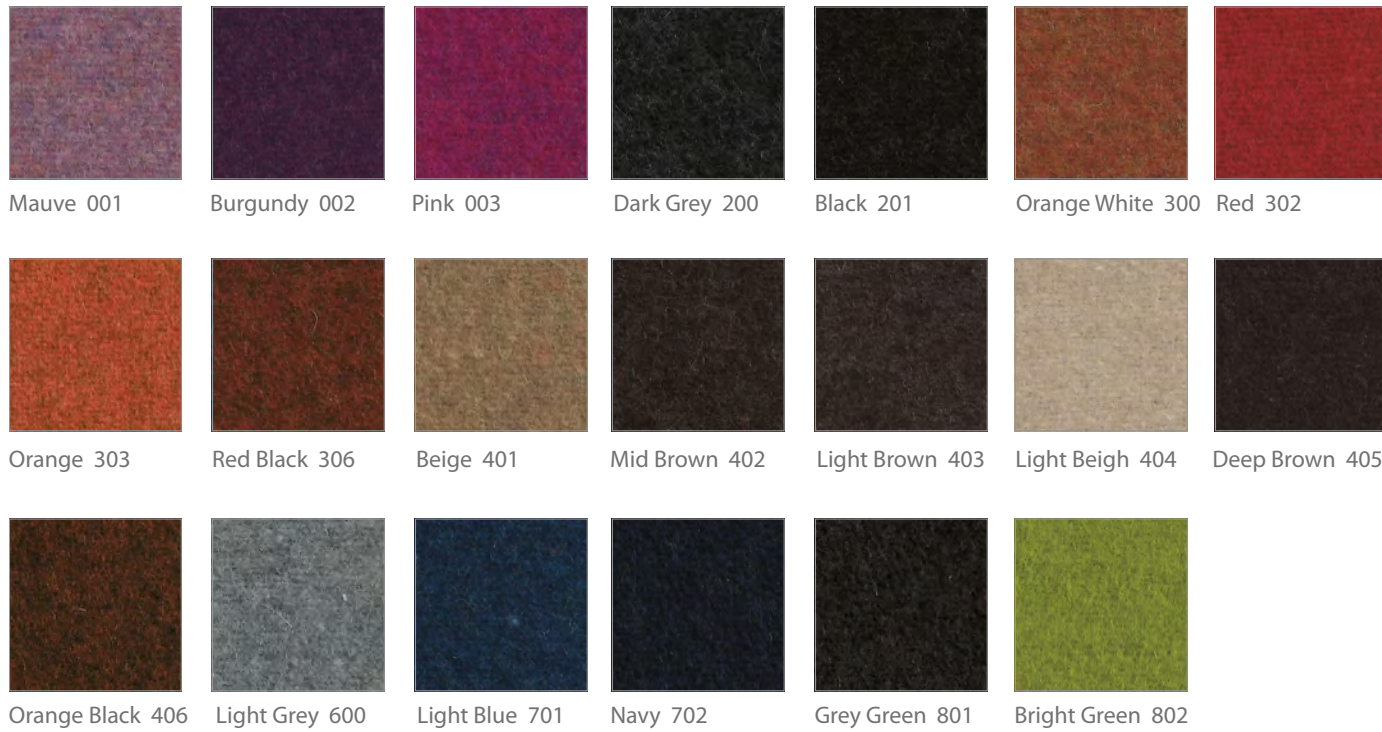

TORRE SOFT SPLIT LEATHER:



CORNERBLOCK FABRICS (J. ENNIS FABRICS):



Red 14 Burgundy 108 Terracotta 405 Brown 87 Purple 1009 Gold 59

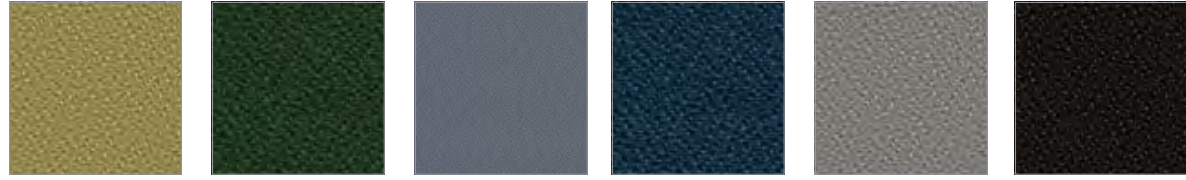

Eucalyptus 64 Green 208 Mist 32 Navy 308 Charcoal 908 Black 9009

MONACO FABRICS (J. ENNIS FABRICS):

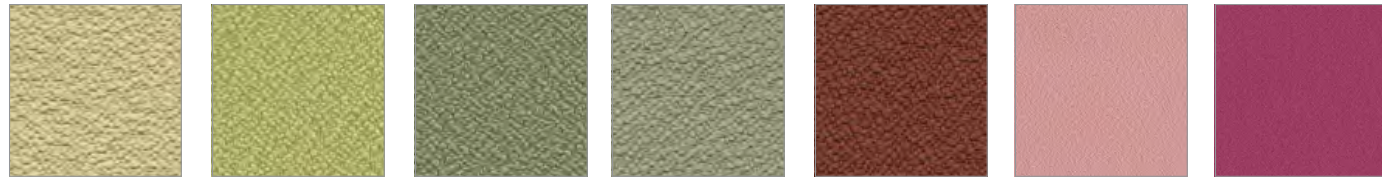

Mellow 51 Key Lime 2005 Basil 2004 Thyme 27 Rust 46 Rose 1001 Fuchsia 1003

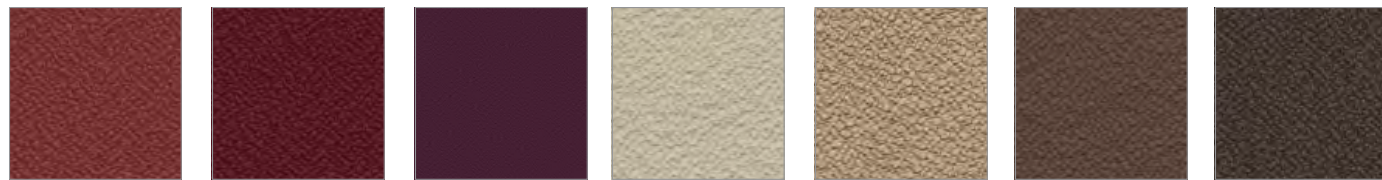

Salmon 104 Paprika 15 Port 17 Oyster 6009 Buff 66 Acorn 8006 Milk Chocolate 87

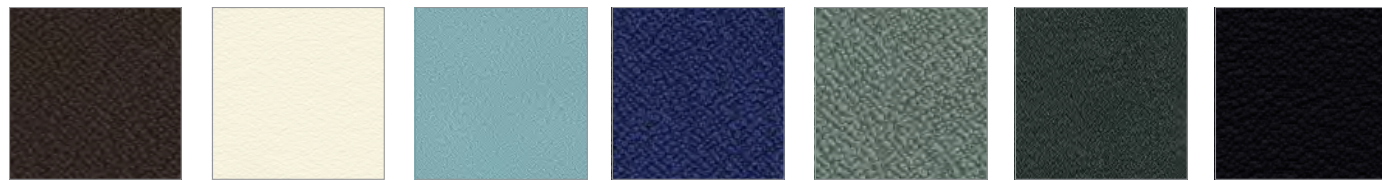

Truffle 8004 Snow 6001 Ice Blue 3006 Cobalt 35 Bay 39 Grey 92 Onyx 9009

GRANULAR FABRICS (J. ENNIS FABRICS):



Red 14 Burgundy 108 Brown 87 Taupe 6009 Gold 59

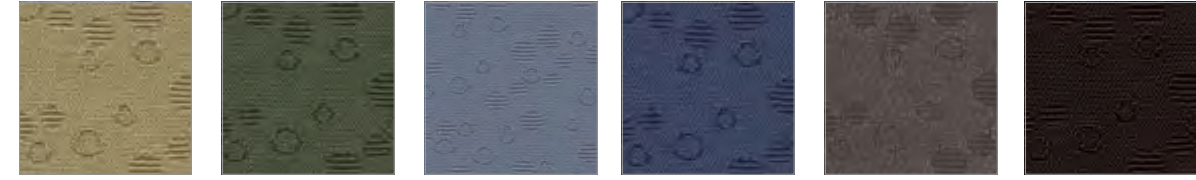

Eucalyptus 64 Green 208 Mist 32 Navy 308 Charcoal 908 Black 9009

TURNER VINYL (J. ENNIS FABRICS):



Lagoon 37 Pacific Blue 3003 Navy 3006 Citron 54 Sprig 205 Rust 14 Garnet 17



Plum 1009 White 3822 Vanilla 61 Cream 6003 Parchment 605 Taupe 3948 Sandstone 608



Tan 802 Mocha 808 Bisque 805 Earth 84 Brick 11 Wine 108 Chestnut 87



Chocolate 8020 Chinchilla 6009 Grey 9003 Steel 905 Black 9009

WOODS & FINISHES:

Natural Maple Standard



Natural Clear – M-NA

Maple Finishes

The following stains are available, add 10% to list



Honey Oak – M-HO

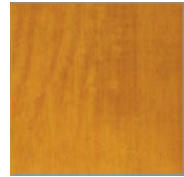

Castle Oak – M-CO



Richmond Cherry – M-RC



Mahogany – M-MA

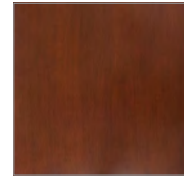

Victorian Cherry – M-VI

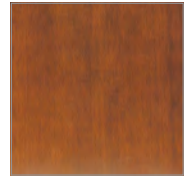

Java – M-JA

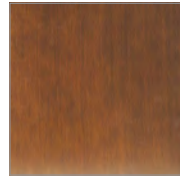

Wenge – M-WE

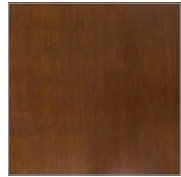

English Oak – M-EN

Natural Red Oak Standard



Natural Clear – O-NA

Red Oak Finishes

The following stains are available, add 10% to list

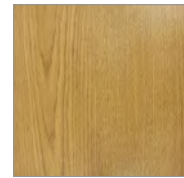

Castle Oak – O-CO



Honey Oak – O-HO

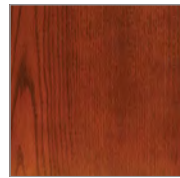

English Oak – O-EN



Victorian Cherry – O-VI

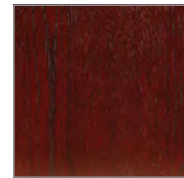

Mahogany – O-MA

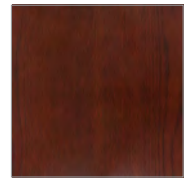

Richmond Cherry – O-RC

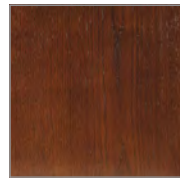

Java – O-JA



Wenge – O-WE

Natural Cherry Add 20% to list

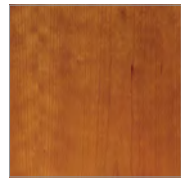

Natural Clear – C-NA

Cherry Finishes

The following stains are available, add 30% to list

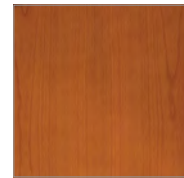

Honey Oak – C-HO



Richmond Cherry – C-RC

Natural Walnut Add 20% to list

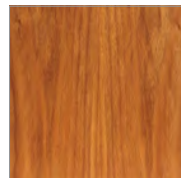

Natural Clear – W-NA

Walnut Finishes

The following stain is available, add 30% to list

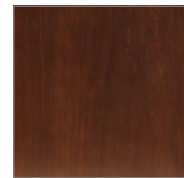

Java – W-JA

HARDWOODS: All hardwood materials used in the manufacturing of seating products shall be Northern grown hardwoods. Hardwoods will be air and kiln dried to a moisture content of 5-7%. All hardwoods shall be of grade "A" material, free of material stains, imperfections, conformity of grain, texture and color. Hardwood species shall be Northern grown Red Oak, and Clear White Northern Maple.

FINISHING PROCEDURES: All materials shall be inspected and treated with a final sanding and polishing operation before any staining and final finishing can be performed. All machine and mill marks are to be removed. Once the polishing and sanding has been performed, the furniture will then undergo the following stain and finishing procedures:





Step 1: A base stain will be uniformly applied, wiped and then allowed to dry under factory controlled conditions.





Step 2: A uniform coat of sealer will be applied and allowed to dry.

Step 3: Sealer will be lightly sanded using 240 grit silicon paper.

Step 4: A catalytic lacquer of 34-45 degree sheen is evenly applied and allowed to dry under factory controlled conditions.

METAL FINISHING PROCEDURES: All metal components are thoroughly cleaned and coated electrostatically with an epoxy powder coat paint finish. The metal components are then oven baked and cured for a lasting finish.

	MODEL NUMBER	NAME	SEAT HEIGHT	ARM HEIGHT	WIDTH	DEPTH	HEIGHT	FABRIC YARDS	LEATHER SQ FT	WEIGHT/VOLUME	LIST PRICE	DESCRIPTION
	TD-1-BL TD-1-RD TD-1-GR TD-1-OR TD-1-WH TD-1-GY	3D Colour Chair Black/White Red/White Green/White Orange/White White/White Grey/White	17 ³ / ₈ "		22"	20 ¹ / ₂ "	33"	N/A	N/A	13 Lbs 9 Cu Ft	\$ 490	<p>Polypropylene Shell: Front is White Matt Finished, and Scratch-Resistant Back is Shiny Finished and available in 6 colours: Black, Red, Orange, Green, Grey and White.</p> <p>Steel frame can be Matt and Polished Chromed, or Powder Coated as per seat colour choice.</p> <p>Colour options (add the preferred colour code to the model number).</p>
	TD-7-BL TD-7-RD TD-7-GR TD-7-OR TD-7-WH TD-7-BE	3D Colour Armchair Black/White Red/White Green/White Orange/White White/White /White	18"	25 ¹ / ₂ "	22 ³ / ₄ "	20 ¹ / ₂ "	33 ¹ / ₄ "	N/A	N/A	14.6 Lbs 9.5 Cu Ft	\$ 1,010	
	TD-3-BL TD-3-RD TD-3-GR TD-3-OR TD-3-WH TD-3-GY	3D Colour Sled Base Chair Black/White Red/White Green/White Orange/White White/White Grey/White	19"		21 ¹ / ₄ "	20 ¹ / ₄ "	33 ¹ / ₂ "	N/A	N/A	13.7 Lbs 9 Cu Ft	\$ 475	

	MODEL NUMBER	NAME	SEAT HEIGHT	ARM HEIGHT	WIDTH	DEPTH	HEIGHT	FABRIC YARDS	LEATHER SQ FT	WEIGHT/VOLUME	LIST PRICE	DESCRIPTION
	TD-5-BL TD-5-RD TD-5-GR TD-5-OR TD-5-WH TD-5-GY	3D Colour Stool Black/White Red/White Green/White Orange/White White/White Grey/White	29 ¹ / ₂ "		18 ⁷ / ₈ "	21 ⁵ / ₈ "	44 ⁵ / ₈ "	N/A	N/A	16.09 Lbs 7.06 Cu Ft	\$ 635	<p>Polypropylene Shell: Front is White Matt Finished, and Scratch-Resistant Back is Shiny Finished and available in 6 colours: Black, Red, Orange, Green, Grey and White.</p> <p>Steel frame can be Matt and Polished Chromed, or Powder Coated as per seat colour choice.</p> <p>Castor frame, with Swivel and Gas Lift device.</p> <p>Colour options (add the preferred colour code to the model number).</p>
	TD-6-BL TD-6-RD TD-6-GR TD-6-OR TD-6-WH TD-6-BE	3D Colour Sled Base Stool Black/White Red/White Green/White Orange/White White/White Beige/White	29 ¹ / ₂ "		21 ⁵ / ₈ "	20 ⁷ / ₈ "	44 ⁵ / ₈ "	N/A	N/A	14.6 Lbs 9.5 Cu Ft	\$ 575	
	TD-4-BL	Swivel Chair Black/White ONLY	17 ³ / ₈ "-22"		27 ¹ / ₂ "	27 ¹ / ₂ "	33"-38"	N/A	N/A	24.3 Lbs 15 Cu Ft	\$ 950	Swivel chair available in black colour option only.

	MODEL NUMBER	NAME	SEAT HEIGHT	ARM HEIGHT	WIDTH	DEPTH	HEIGHT	FABRIC YARDS	LEATHER SQ FT	WEIGHT/ VOLUME	LIST PRICE	DESCRIPTION
	AR-1-BL AR-1-GY	Aries Chair, 4 Legs Black Gey	19 ¹ / ₂ "		17"	17"	33 ¹ / ₂ "	N/A	N/A	8 Lbs.	\$ 210	The Aries Chair is constructed with a Plastic Shell, and Metal Frame with a Sled Base. The chair is available in Grey or Black color ONLY.
	AR-2-BL AR-2-GY	Aries Chair, Sled Base Black Gey	19 ¹ / ₂ "		17"	17"	33 ¹ / ₂ "	N/A	N/A	11.5 Lbs.	\$ 225	

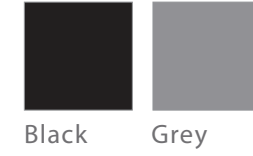



MODEL NUMBER	NAME	SEAT HEIGHT	ARM HEIGHT	WIDTH	DEPTH	HEIGHT
BOA-1	Boa Chair	18"		18"	23"	31"
BOA-1-C	Boa Children's Chair	14"		16"	15"	26"

FABRIC YARDS	LEATHER SQ FT	WEIGHT/ VOLUME	LIST PRICE
N/A	N/A	13 Lbs 7 Cu Ft	\$ 470
N/A	N/A	12 Lbs 4 Cu Ft	\$ 465

DESCRIPTION

The Boa Chair is constructed of a laminated Maple Seat and back with Polished Chrome Legs.

For the complete line of Maple Wood Finishes and options, refer to page 12 in this specification guide.



BO-1-C	Balloon Chair	15"		16 ³ / ₄ "	15 ¹ / ₂ "	30"
--------	---------------	-----	--	----------------------------------	----------------------------------	-----

N/A	N/A		\$ 575
-----	-----	--	--------

The Balloon Chair is Plywood Maple shell with Steel Legs epoxy coated in Silver, Red, Blue, or Yellow. Round feet options available in Blue, Black, and Red

For the complete line of Maple Wood Finishes and options, refer to page 12 in this specification guide.

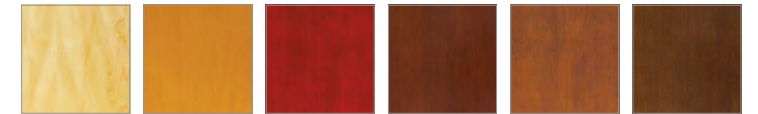



MODEL NUMBER	NAME	SEAT HEIGHT	ARM HEIGHT	WIDTH	DEPTH	HEIGHT	FABRIC YARDS	LEATHER SQ FT	WEIGHT/ VOLUME	LIST PRICE	DESCRIPTION
EM-1	Empire Chair	18"		21 1/2"	22 1/2"	33"	N/A	N/A	27 Lbs 5 Cu Ft	\$ 705	The Empire Chair has a 7-Ply 7/16" Molded Plywood seat and back with Maple Face Veneers. Also available upholstered with Fire Retardant Foam over a 7/16" thick Molded Plywood Shell. The Frame is Cold Rolled Tubular Steel finished with an Electrostatically applied Powder Epoxy.
EM-1-C	Empire Youth Chair	15"		16"	18 1/2"	28 1/2"	N/A	N/A	18 Lbs 5 Cu Ft	\$ 705	
EM-1-P	Empire Primary Chair	12"		16"	18 1/2"	24"	N/A	N/A	15 Lbs 5 Cu Ft	\$ 665	

For the complete line of Maple Wood Finishes and options, refer to page 12 in this specification guide.







EM-2	Empire Armchair	18"		21 1/2"	22 1/2"	33"	N/A	N/A	31 Lbs 5 Cu Ft	\$ 780
------	-----------------	-----	--	---------	---------	-----	-----	-----	-------------------	--------



EM-1U	Empire Chair, Upholstered	18"		21 1/2"	22 1/2"	33"			27 Lbs 5 Cu Ft	\$ 820
EM-1U-C	Empire Youth Chair, Upholstered	15"		16"	18 1/2"	28 1/2"			18 Lbs 5 Cu Ft	\$ 745
EM-1U-P	Empire Primary Chair, Upholstered	12"		16"	18 1/2"	24"			15 Lbs 5 Cu Ft	\$ 705







EM-2U	Empire Armchair, Upholstered	18"		21 1/2"	22 1/2"	33"			31 Lbs 5 Cu Ft	\$ 820
-------	------------------------------	-----	--	---------	---------	-----	--	--	-------------------	--------

	MODEL NUMBER	NAME	SEAT HEIGHT	ARM HEIGHT	WIDTH	DEPTH	HEIGHT	FABRIC YARDS	LEATHER SQ FT	WEIGHT/ VOLUME	LIST PRICE	DESCRIPTION
	FT-1-R FT-1-B	Fast Chair R. Leather Beechwood	17 ³ / ₄ "		16 ⁷ / ₈ "	21 ⁷ / ₈ "	30 ³ / ₄ "	0.71	11.1	15.65 Lbs 11.3 Cu Ft	\$ 300 \$ 755	The Fast Chair has a Chromed Base available with a Beechwood Shell or upholstered with R. Leather. There are 6 available colors for R. Leather:
	FT-2-R FT-2-B	Fast Sled Base R. Leather Beechwood	18 ¹ / ₂ "		21 ⁵ / ₈ "	20 ¹ / ₂ "	31 ¹ / ₂ "	0.71	11.84	15.65 Lbs 12.71 Cu Ft	\$ 325 \$ 825	
	FT-3-R FT-3-B	Fast Swivel R. Leather Beechwood	19 ¹ / ₄ "		19 ¹ / ₄ "	19 ¹ / ₄ "	32 ¹ / ₄ "	0.71	11.84	13.45 Lbs 10.24 Cu Ft	\$ 390 \$ 1,010	
	FT-4-R	Fast Stool R. Leather	25 ⁷ / ₈ "		18 ³ / ₄ "	20 ¹ / ₈ "	36 ⁷ / ₈ "	0.71	11.1	17.67 Lbs 8.12 Cu Ft	\$ 370	



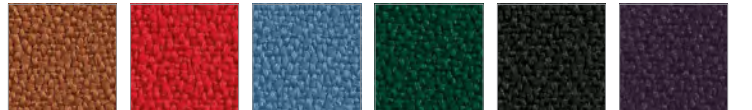

The Fast Chair is stackable up to 4-6 chairs high, and has an elegant handle in the frame located at the back of the chair.

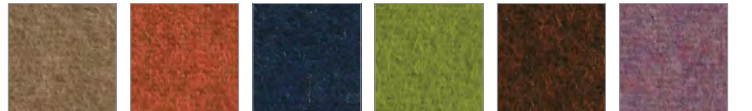







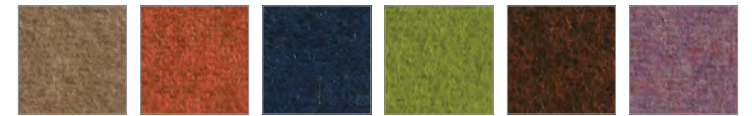
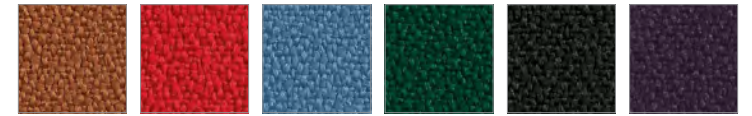



	MODEL NUMBER	NAME	SEAT HEIGHT	ARM HEIGHT	WIDTH	DEPTH	HEIGHT	FABRIC YARDS	LEATHER SQ FT	WEIGHT/VOLUME	LIST PRICE	DESCRIPTION
	FS-1-O FS-1-M	Fusion Chair Oak Maple	18"		17 ¹ / ₂ "	20"	35"	N/A	N/A		\$ 665	<p>The Fusion Chair has Steel Legs that are available in a powder coat paint finish, see page 15 for colour options. It is constructed of a laminated Oak or Maple Seat and Back with a standard Natural Clear Finish.</p> <p>For the complete line of Maple Wood Finishes and options, refer to page 12 in this specification guide.</p>  <p>For the complete line of Red Oak Wood Finishes and options, refer to page 10 in this specification guide.</p> 
	GL-1-NW GL-1-MR	Gilda Chair Nord Wool Mirage	19 ¹ / ₄ "		17 ³ / ₄ "	20 ¹ / ₂ "	35 ¹ / ₂ "	0.87	14.53	15 Lbs 10.59 Cu Ft	\$ 360 \$ 325	<p>The Gilda Chair is available with either a Chrome Frame or Matt-Chrome Frame in a selection of 20 Nord Wool Fabrics; or 20 Mirage Fabrics.</p> <p>The Chair is stackable.</p> <p>For the complete line of Mirage Fabrics available, refer to page 8 in this specification guide.</p> 
	GL-2-NW GL-2-MR	Gilda Chair with Matt-Chrome Frame Nord Wool Mirage	19 ¹ / ₄ "		17 ³ / ₄ "	20 ¹ / ₂ "	35 ¹ / ₂ "	0.87	14.53	15 Lbs 10.59 Cu Ft	\$ 580 \$ 545	<p>For the complete line of Nord Wool Fabrics available, refer to page 8 in this specification guide.</p> 

	MODEL NUMBER	NAME	SEAT HEIGHT	ARM HEIGHT	WIDTH	DEPTH	HEIGHT	FABRIC YARDS	LEATHER SQ FT	WEIGHT/ VOLUME	LIST PRICE	DESCRIPTION
	GR-1-WH GR-1-BL GR-1-RD GR-1-OR GR-1-LG	Grace Chair White Black Red Orange Light Green	18 ¹ / ₈ "		21 ⁵ / ₈ "	20 ⁷ / ₈ "	30 ¹ / ₈ "	N/A	N/A	11.24 Lbs 12.36 Cu Ft	\$ 370	The Grace is made of a glass fibre charged polypropylene, a matt, strong material, which is UV beam resistant and antistatic. The legs are made of solid steel tube. The chair has a thin curved back that embraces the arms obtaining a sinuous shape. Grace is stackable up to 6 chairs high.
	GR-2-WH GR-2-BL GR-2-RD GR-2-OR GR-2-LG	Grace Sled Base White Black Red Orange Light Green	18 ¹ / ₈ "		21 ⁵ / ₈ "	20 ⁷ / ₈ "	30 ¹ / ₈ "	N/A	N/A	12.35 Lbs 12 Cu Ft	\$ 325	The seat is available in the following five colours:  White Black Red Orange Light Green

	MODEL NUMBER	NAME	SEAT HEIGHT	ARM HEIGHT	WIDTH	DEPTH	HEIGHT	FABRIC YARDS	LEATHER SQ FT	WEIGHT/VOLUME	LIST PRICE	DESCRIPTION
	JP-1-NW JP-1-MR	Jade-P with Sled Base Nord Wool Mirage	18 ⁷ / ₈ "		17 ³ / ₄ "	20 ¹ / ₂ "	35 ⁷ / ₈ "	2.18	36.06	14.33 Lbs 10.59 Cu Ft	\$ 840 \$ 755	The Jade Chair is available with a Chrome Frame, Sled Base, a Chrome Frame with 4 Round Legs or a Chrome Frame with 4 Conic Legs in a selection of 20 Nord Wool Fabrics; or 20 Mirage Fabrics. For the complete line of Mirage Fabrics available, refer to page 8 in this specification guide.
	JP-2-NW JP-2-MR	Jade-P with 4 Round Legs Nord Wool Mirage	18 ¹ / ₈ "		24 ¹ / ₄ "	24 ¹ / ₂ "	33 ¹ / ₂ "	2.18	36.06	14.33 Lbs 10.59 Cu Ft	\$ 705 \$ 620	For the complete line of Nord Wool Fabrics available, refer to page 8 in this specification guide.
	JP-3-NW JP-3-MR	Jade-P with 4 Conic Legs Nord Wool Mirage	18 ¹ / ₈ "			23 ¹ / ₄ "	32 ¹ / ₄ "	2.18	36.06	37.48 Lbs 13.42 Cu Ft	\$ 1,110 \$ 1,010	



	MODEL NUMBER	NAME	SEAT HEIGHT	ARM HEIGHT	WIDTH	DEPTH	HEIGHT	FABRIC YARDS	LEATHER SQ FT	WEIGHT/ VOLUME	LIST PRICE	DESCRIPTION
 Stacks	KC-1-CR	Kicca Chair	18"		21 ¹ / ₄ "	21 ⁵ / ₈ "	30"	N/A	N/A	15 Lbs 15.5 Cu Ft	\$ 585	The Kicca Chair has a Polypropylene Shell available with Chromed Legs, Chromed Sled Base, Black Swivel Base, Chromed Stool Base or a Standard Black Caster Base. It is available in the following seven colours:  Cream       Black Green Blue Red Grey Orange
	KC-1-BL	Black										
	KC-1-GR	Green										
	KC-1-BU	Blue										
	KC-1-RD	Red										
	KC-1-GY	Grey										
	KC-1-OR	Orange										
 Stacks	KC-2-CR	Kicca Sled Base	18"		21 ¹ / ₄ "	21 ⁵ / ₈ "	30"	N/A	N/A	15 Lbs 15.5 Cu Ft	\$ 605	
	KC-2-BL	Black										
	KC-2-GR	Green										
	KC-2-BU	Blue										
	KC-2-RD	Red										
	KC-2-GY	Grey										
	KC-2-OR	Orange										
	KC-3-CR	Kicca Swivel Base	18"		21 ¹ / ₄ "	21 ⁵ / ₈ "	30"	N/A	N/A	50 Lbs 15.5 Cu Ft	\$ 935	
	KC-3-BL	Black										
	KC-3-GR	Green										
	KC-3-BU	Blue										
	KC-3-RD	Red										
	KC-3-GY	Grey										
	KC-3-OR	Orange										



Stacks



MODEL NUMBER	NAME	SEAT HEIGHT	ARM HEIGHT	WIDTH	DEPTH	HEIGHT
KC-5-CR	Kicca Stool	28 ³ / ₈ "		21 ¹ / ₄ "	21 ⁵ / ₈ "	39 ³ / ₄ "
KC-5-BL	Cream					
KC-5-GR	Black					
KC-5-BU	Green					
KC-5-RD	Blue					
KC-5-GY	Red					
KC-5-OR	Grey					
	Orange					

FABRIC YARDS	LEATHER SQ FT	WEIGHT/ VOLUME	LIST PRICE
N/A	N/A	25 Lbs 17 Cu Ft	\$ 735

DESCRIPTION

The Kicca Chair has a Polypropylene Shell available with Chromed Legs, Chromed Sled Base, Black Swivel Base, Chromed Stool Base or a Standard Black Caster Base. It is available in the following seven colours:



Cream





Black Green Blue Red Grey Orange

MODEL NUMBER	NAME	SEAT HEIGHT	ARM HEIGHT	WIDTH	DEPTH	HEIGHT
KC-4-CR	Kicca Swivel with Wheels	17 ³ / ₈ "-22"		21 ¹ / ₄ "	21 ⁵ / ₈ "	29"-33 ³ / ₄ "
KC-4-BL	Cream					
KC-4-GR	Black					
KC-4-BU	Green					
KC-4-RD	Blue					
KC-4-GY	Red					
KC-4-OR	Grey					
	Orange					

FABRIC YARDS	LEATHER SQ FT	WEIGHT/ VOLUME	LIST PRICE
N/A	N/A	50 Lbs 17.5 Cu Ft	\$ 840

SEATING

	MODEL NUMBER	NAME	SEAT HEIGHT	ARM HEIGHT	WIDTH	DEPTH	HEIGHT	FABRIC YARDS	LEATHER SQ FT	WEIGHT/ VOLUME	LIST PRICE	DESCRIPTION
	KU-1-IV KU-1-WH	Kuadra Chair Ivory White	17 ³ / ₄ "		18 ¹ / ₈ "	20 ⁷ / ₈ "	33 ¹ / ₈ "	N/A	N/A	11.9 Lbs 11.65 Cu Ft	\$ 270	The Kuadra Chair is made with a Technopolymer shell, which is flexible, strong, and scratch resistant. It is available in a white or ivory colour, with a steel frame.
	KU-2-IV KU-2-WH	Kuadra Armchair Ivory White	17 ³ / ₄ "	25 ⁷ / ₈ "	20 ¹ / ₂ "	20 ⁷ / ₈ "	33 ¹ / ₈ "	N/A	N/A	15.21 Lbs 12.71 Cu Ft	\$ 350	
	KU-3-IV KU-3-WH	Kuadra Sled base, round profile 10 mm Ivory White	17 ³ / ₄ "		21 ¹ / ₂ "	20 ¹ / ₈ "	33 ¹ / ₈ "	N/A	N/A	12.13 Lbs 9.53 Cu Ft	\$ 290	



MODEL NUMBER	NAME	SEAT HEIGHT	ARM HEIGHT	WIDTH	DEPTH	HEIGHT
--------------	------	-------------	------------	-------	-------	--------

MU-1-NW	Manu Rod	18 ⁷ / ₈ "	26 ³ / ₄ "	24"	23 ¹ / ₂ "	31 ⁷ / ₈ "
MU-1-MR	Nord Wool Mirage					

MU-2-NW	Manu-G with Round Swivel Base	18 ¹ / ₂ "	26 ³ / ₈ "	23 ⁵ / ₈ "	22 ⁷ / ₈ "	31 ¹ / ₈ "
MU-2-MR	Nord Wool Mirage					

FABRIC YARDS	LEATHER SQ FT	WEIGHT/ VOLUME	LIST PRICE
--------------	---------------	----------------	------------

1.75	29.06	24.25 11.3	\$ 705 \$ 630
------	-------	---------------	------------------

1.75	29.06	24.25 11.3	\$ 1,320 \$ 1,245
------	-------	---------------	----------------------

DESCRIPTION



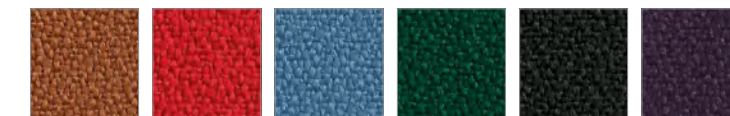

The Manu Chair is available with Chrome Legs or a Chromed Swivel Frame available in a selection of 20 Nord Wool Fabrics; or 20 Mirage Fabrics.



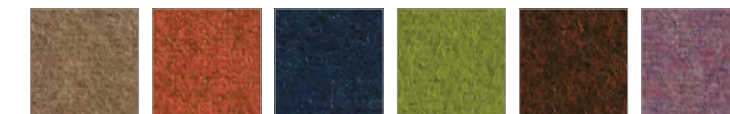



For the complete line of Mirage Fabrics available, refer to page 8 in this specification guide.



















For the complete line of Nord Wool Fabrics available, refer to page 8 in this specification guide.







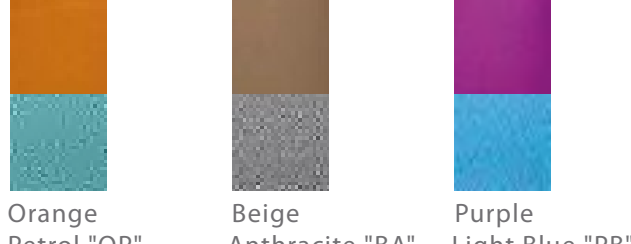

	MODEL NUMBER	NAME	SEAT HEIGHT	ARM HEIGHT	WIDTH	DEPTH	HEIGHT	FABRIC YARDS	LEATHER SQ FT	WEIGHT/ VOLUME	LIST PRICE	DESCRIPTION
	MI-1	Milo Chair			22"	20"	33"	N/A	N/A	13 Lbs 11 Cu Ft	\$ 485	The Milo Chair is available with Polished Chrome Legs or a 5 Star Black Polypropylene Base. It has a Plywood Maple seat and back available in standard Natural Clear Finish. For the complete line of Maple Wood Finishes and options, refer to page 12 in this specification guide.
	MI-4	Milo Swivel Armchair			22"	20"	33"	N/A	N/A	20 Lbs 11 Cu Ft	\$ 625	
	MY-1-WH MY-1-BL MY-1-RD MY-1-OR MY-1-SA	Mya Chair White Black Red Orange Sand	17 ³ / ₄ "		17 ¹ / ₄ "	18 ¹ / ₂ "	31"	N/A	N/A	12 Lbs 11 Cu Ft	\$ 770	The Mya Chair has a Polypropylene Shell with a Die-Casted Alluminium Powder Coated Frame with Tapered Legs. The Shell is available in 5 Colours:  White Black Red Orange Sand

	MODEL NUMBER	NAME	SEAT HEIGHT	ARM HEIGHT	WIDTH	DEPTH	HEIGHT	FABRIC YARDS	LEATHER SQ FT	WEIGHT/VOLUME	LIST PRICE	DESCRIPTION
	NT-1-BL NT-1-GY	Nest Chair Black Grey	17 1/2"		17 1/2"	17"	32"	N/A	N/A	8 Lbs.	\$ 265	The Nest Chair is constructed with a Polypropylene Shell, and Metal Frame with Sled Base. The back of the chair has small holes for ventilation. The chair is available in Grey or Black color ONLY.
	NT-2-BL NT-2-GY	Nest Armchair Black Grey	17 1/2"		17 1/2"	17"	32"	N/A	N/A	10 Lbs.	\$ 365	 Black Grey
	NT-3-BL NT-3-GY	Nest Chair, with Tablet Arm ONLY Black Grey	17 1/2"		17 1/2"	17"	32"	N/A	N/A	10 Lbs.	\$ 570	
	NT-3B-BL NT-3B-GY	Nest Chair, with Tablet Arm, AND Under Basket Black Grey	17 1/2"		17 1/2"	17"	32"	N/A	N/A	11 Lbs.	\$ 750	
	NT-4-BL NT-4-GY	Nest Barstool Black Grey	28 1/2"		17 1/2"	17 1/2"	43"	N/A	N/A	14 Lbs.	\$ 490	

MODEL NUMBER	NAME	SEAT HEIGHT	ARM HEIGHT	WIDTH	DEPTH	HEIGHT	FABRIC YARDS	LEATHER SQ FT	WEIGHT/ VOLUME	LIST PRICE	DESCRIPTION
	Chair, Flip-Up Arms, No Casters NE-1-GG Grey / Dark Grey NE-1-GB Grey / Black	17 1/2"		17 1/2"	17"	32"	N/A	N/A	8 Lbs.	\$ 670	<p>Nine chair is constructed with a polypropylene back and seat. The back has flexible movement for ergonomic comfort. The seat can flip-up for easy storage. All polypropylene parts are scratch proof. The chair has a unique tubular steel frame which is epoxy powder coated Grey. The flip-up arms are in Grey polypropylene reinforced with fiber-glass. Glides act as point of contact when stacking chairs to ensure neatly stacked arrangements. Nine can stack and nest with and without Anti-Panic Tablets.</p> <div style="display: flex; justify-content: space-around; align-items: center;"> <div style="text-align: center;">  Black Back/Seat </div> <div style="text-align: center;">  Dark Grey Back/Seat </div> </div> <p>Notes:</p> <p>*Minimum quantity of 20 Chair for each model</p> <div style="display: flex; justify-content: space-around; align-items: center;">   </div> <div style="display: flex; justify-content: space-around; align-items: center;">   </div>
	Chair, Flip-Up Arms, 4 Casters NE-2-GG Grey / Dark Grey NE-2-GB Grey / Black	17 1/2"		17 1/2"	17"	32"	N/A	N/A	10 Lbs.	\$ 725	
	Chair, Flip-Up Arms, No Casters, with Tablet NE-3-GG Grey / Dark Grey NE-3-GB Grey / Black	17 1/2"		17 1/2"	17"	32"	N/A	N/A	10 Lbs.	\$ 1,085	
	Chair, Flip-Up Arms, 4 Casters, with Tablet NE-4-GG Grey / Dark Grey NE-4-GB Grey / Black	17 1/2"		17 1/2"	17"	32"	N/A	N/A	11 Lbs.	\$ 1,145	

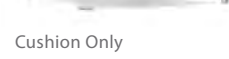
	MODEL NUMBER	NAME	SEAT HEIGHT	ARM HEIGHT	WIDTH	DEPTH	HEIGHT	FABRIC YARDS	LEATHER SQ FT	WEIGHT/VOLUME	LIST PRICE	DESCRIPTION
		Ongo Stool White Base	16 ¹ / ₂ "-25"		Seat 14" Dia. Base 16 ¹ / ₂ " Dia.			N/A	N/A	12.6 Lbs 3.7 Cu Ft	\$ 825	<p>The Ongo Stool has an ABS Plastic Base available in two colours, black or white.</p> <p>Comes with 3 interchangeable balls (steel, glass, and rubber) to vary the level of difficulty for your exercises with the ball track</p> <p>The Ongo stool is height adjustable a from 16¹/₂" seat height up to 25".</p> <p>The Ongo Stool is available in the following 12 Colours of Microfiber Knit Fabrics:</p> 
	ON-1-BL	Black Seat										
	ON-1-VO	Violet Seat										
	ON-1-BR	Brown Seat										
	ON-1-GY	Grey Seat										
	ON-1-RD	Red Seat										
	ON-1-OR	Orange Seat										
	ON-1-LB	Light Blue Seat										
	ON-1-BU	Blue Seat										
	ON-1-GR	Green Seat										
	ON-1-LG	Light Green Seat										
	ON-1-PR	Purple Seat										
	ON-1-DR	Dark Red Seat										
		Ongo Stool Black Base	16 ¹ / ₂ "-25"		Seat 14" Dia. Base 16 ¹ / ₂ " Dia.			N/A	N/A	12.6 Lbs 3.7 Cu Ft	\$ 825	
	ON-2-BL	Black Seat										
	ON-2-VO	Violet Seat										
	ON-2-BR	Brown Seat										
	ON-2-GY	Grey Seat										
	ON-2-RD	Red Seat										
	ON-2-OR	Orange Seat										
	ON-2-LB	Light Blue Seat										
	ON-2-BU	Blue Seat										
	ON-2-GR	Green Seat										
	ON-2-LG	Light Green Seat										
	ON-2-PR	Purple Seat										
	ON-2-DR	Dark Red Seat										
		Ongo Kit Stool	12"		14"	14"		N/A	N/A	6 Lbs	\$ 375	<p>The Ongo Kit is suitable for young children. It consists of a curved base and large intergrated balltack.</p> <p>Adjust the height of the Ongo Kit with the separate height extension kit. Each kit comes with 2 height extensions in 3" increments.</p>
	ON-K-PB	Purple/Light Blue										
	ON-K-OP	Orange/Petrol										
		Ongo Kit with Column Extension	15"-18"		14"	14"		N/A	N/A	6 Lbs	\$ 440	<p>The Ongo Kit is available in 3 combination colours only:</p> 
	ON-KCE-PB	Purple/Light Blue										
	ON-KCE-OP	Orange/Petrol										
ON-KCE-BA	Beige/Anthracite											
		Column Extensions for Ongo Kit (2/box)					3" each	N/A	N/A	1 Lbs	\$ 65	
	ON-CE-P	Purple										
	ON-CE-O	Orange										
ON-CE-B	Beige											

	MODEL NUMBER	NAME	SEAT HEIGHT	ARM HEIGHT	WIDTH	DEPTH	HEIGHT	FABRIC YARDS	LEATHER SQ FT	WEIGHT/VOLUME	LIST PRICE	DESCRIPTION
 <small>Stacks</small>	OR-1-BU	Orbit Chair	18"		21"	22"	31"	N/A	N/A	12.6 Lbs 3.7 Cu Ft	\$ 535	<p>The Orbit Chair is constructed of a Polypropylene Shell with Polished Chrome Legs available in the following 5 Colours:</p>  <p>Blue Red Green Charcoal Orange</p> <p>The Orbit Chair is stackable.</p>
	OR-1-RD	Blue										
	OR-1-GR	Red										
	OR-1-CH	Green										
	OR-1-OR	Charcoal										
	Orange											
 <small>Stacks</small>	OR-1C-BU	Orbit Children's Chair	14"		15"	15"	25"				\$ 435	
	OR-1C-RD	Blue										
	OR-1C-GR	Red										
	OR-1C-CH	Green										
	OR-1C-OR	Charcoal										
	Orange											

	MODEL NUMBER	NAME	SEAT HEIGHT	ARM HEIGHT	WIDTH	DEPTH	HEIGHT	FABRIC YARDS	LEATHER SQ FT	WEIGHT/VOLUME	LIST PRICE	DESCRIPTION
	PA-1-WH PA-1-BL PA-1-TR PA-1-TRS	White Chair Black Chair Transparent Chair Smoke Translucent Chair	17"	25 ³ / ₄ "	28"	29 ¹ / ₂ "	38 ¹ / ₂ "	N/A	N/A	21.4 Lbs 19 Cu Ft	\$ 960	The Pasha Collection is made from an Injection Molded Polycarbonate Shell available in 4 Colours: White, Black, Transparent, and Smoke Translucent.
	PA-C1-BL PA-C1-WH	Velvet Cushion Black White			22 ¹ / ₂ "	22"	4"	N/A	N/A	2.6 Lbs 1.2 Cu Ft	\$ 475 \$ 475	The Cushion is available in a Fire Retardant Velvet in Black or White; a Fire Retardant Fabric in Black or White; Black and Grey Plaid; or White and Grey Stripes.
	PA-C2-BL PA-C2-WH	Plain Cushion Black White									\$ 560 \$ 560	
	PA-C3	Plaid Cushion White/Black									\$ 730	
	PA-C4	Stripe Cushion White/Grey									\$ 730	
	PA-2-WH PA-2-BL PA-2-TR PA-2-TRS	White Ottoman Black Ottoman Transparent Ottoman Smoke Translucent Ottoman			23 ⁵ / ₈ "	20"	16"	N/A	N/A	11 Lbs 4.5 Cu Ft	\$ 435	
	PA-T-WH PA-T-BL	White Ottoman Tray Black Ottoman Tray			17 ¹ / ₂ "	13 ¹ / ₄ "	2 ³ / ₄ "	N/A	N/A	3.5 Lbs .5 Cu Ft	\$ 255	

Cushion Only

Ottoman Tray Only

SEATING



MODEL NUMBER	NAME	SEAT HEIGHT	ARM HEIGHT	WIDTH	DEPTH	HEIGHT	FABRIC YARDS	LEATHER SQ FT	WEIGHT/VOLUME	LIST PRICE	DESCRIPTION
SA-1-O SA-1-M	Sabrina Chair Oak Maple			21"	21"	33"	N/A	N/A		\$ 665	The Sabrina Chair has a Steel Painted Frame (specify colour for legs) with a Plywood Shell available in Oak or Maple with a standard Natural Clear Finish.

For the complete line of Maple Wood Finishes and options, refer to page 12 in this specification guide.



For the complete line of Red Oak Wood Finishes and options, refer to page 12 in this specification guide.



SI-1	Sixty Chair	18 ¹ / ₈ "		16 ¹ / ₂ "	22 ¹ / ₄ "	32 ¹ / ₄ "	N/A	N/A	11.63 Lbs 12 Cu Ft	\$ 370	The Sixty Chair has a Chromed or Lacquered Frame with a Natural Beechwood or Lacquered Seat and Back in a Natural Clear Finish.
------	-------------	----------------------------------	--	----------------------------------	----------------------------------	----------------------------------	-----	-----	-----------------------	--------	---



MODEL NUMBER	NAME	SEAT HEIGHT	ARM HEIGHT	WIDTH	DEPTH	HEIGHT
	Snow Chair	17 ⁷ / ₈ "		18 ¹ / ₂ "	21 ⁵ / ₈ "	31 ⁵ / ₈ "
SN-1-WH	White					
SN-1-GY	Grey					
SN-1-BL	Black					
SN-1-RD	Red					
SN-1-OR	Orange					
SN-1-GR	Green					
SN-1-BU	Blue					

FABRIC YARDS	LEATHER SQ FT	WEIGHT/ VOLUME	LIST PRICE
N/A	N/A	9.48 Lbs 11.65 Cu Ft	\$ 235

DESCRIPTION





The Snow is made from injected polypropylene, lightweight and UV rays resistant. The chair is ideal for both indoor and outdoor use. It also has a water outflow hold on the back of the seat. Snow is also stackable 8 chairs high and is available in the following 7 colours:









White







Grey Black Red Orange Green Blue

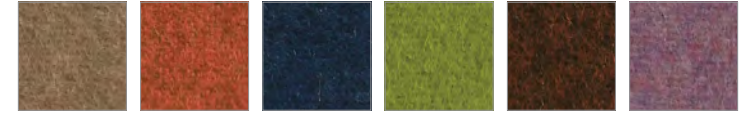
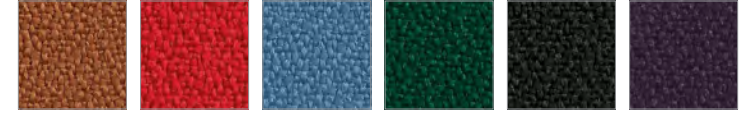





	MODEL NUMBER	NAME	SEAT HEIGHT	ARM HEIGHT	WIDTH	DEPTH	HEIGHT	FABRIC YARDS	LEATHER SQ FT	WEIGHT/ VOLUME	LIST PRICE	DESCRIPTION
	TB-1-M	Tibro Maple			21"	21"	34"	N/A	N/A	14 Lbs 11 Cu Ft	\$ 505	The Tibro Chair comes with Sandtex Silver Legs or a 5 Star Black Polypropylene Base. It has a Plywood Maple Shell available in standard Natural Clear Finish. For the complete line of Maple Wood Finishes and options, refer to page 12 in this specification guide.
	TB-2-M	Tibro Armchair Maple			21"	21"	34"	N/A	N/A	14 Lbs 11 Cu Ft	\$ 685	
	TB-3-M	Tibro Swivel Maple			24"	24"	30"	N/A	N/A	15 Lbs 11 Cu Ft	\$ 505	

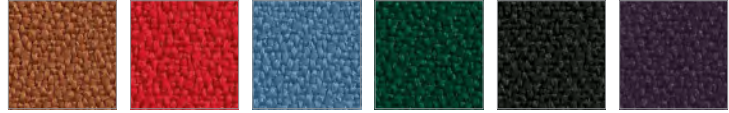
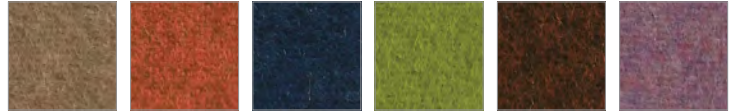

	MODEL NUMBER	NAME	SEAT HEIGHT	ARM HEIGHT	WIDTH	DEPTH	HEIGHT	FABRIC YARDS	LEATHER SQ FT	WEIGHT/ VOLUME	LIST PRICE	DESCRIPTION
		Vesper-S Chair	18 ¹ / ₂ "		18 ⁷ / ₈ "	20 ¹ / ₂ "	33 ¹ / ₈ "	0.77	12.92	14.33 Lbs 11.3 Cu Ft		The Vesper-S Chair is available with a Chrome Frame available in a selection of 20 Nord Wool Fabrics; or 20 Mirage Fabrics.
	VS-1-NW VS-1-MR	Nord Wool Mirage									\$ 420 \$ 385	
												For the complete line of Mirage Fabrics available, refer to page 8 in this specification guide.
		Vesper with 1 Pair of Linking Devices (left + right)	18 ¹ / ₂ "		18 ⁷ / ₈ "	20 ¹ / ₂ "	33 ¹ / ₈ "	0.77	12.92	15.33 Lbs 12 Cu Ft		
	VS-1-VK1-NW VS-1-VK1-MR	Nord Wool Mirage									\$ 450 \$ 415	
												For the complete line of Nord Wool Fabrics available, refer to page 8 in this specification guide.
		Vesper with 1 Arm (left or right)	18 ¹ / ₂ "	26 ¹ / ₈ "	18 ⁷ / ₈ "	20 ¹ / ₂ "	33 ¹ / ₈ "	0.77	12.92	15.33 Lbs 12 Cu Ft		
	VS-1-VK2-NW VS-1-VK2-MR	Nord Wool Mirage									\$ 490 \$ 450	
												NOTES: The Arm (CK2) and the Arm & Writing Table (CK3) additions both require a minimum quantity order of 20.
		Vesper with 1 Arm with Writing Table (left or right)	18 ¹ / ₂ "	26 ¹ / ₈ "	18 ⁷ / ₈ "	20 ¹ / ₂ "	33 ¹ / ₈ "	0.77	12.92	15.33 Lbs 12 Cu Ft		
	VS-1-VK3-NW VS-1-VK3-MR	Nord Wool Mirage									\$ 565 \$ 525	
												Vesper is stackable up to 8 chairs high.
		Vesper Armchair Chromed Arm	18 ¹ / ₂ "	26 ¹ / ₈ "	18 ⁷ / ₈ "	20 ¹ / ₂ "	33 ¹ / ₈ "	0.77	12.92	14.33 Lbs 11.3 Cu Ft		
	VS-1-VK4-NW VS-1-VK4-MR	Nord Wool Mirage									\$ 555 \$ 520	
	VK5	Vesper Trolley for 20 Chairs						N/A	N/A		\$ 505	







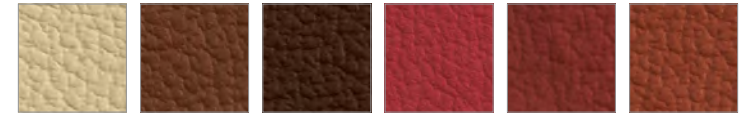
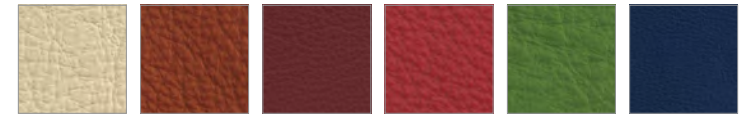
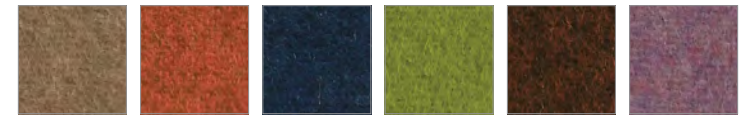
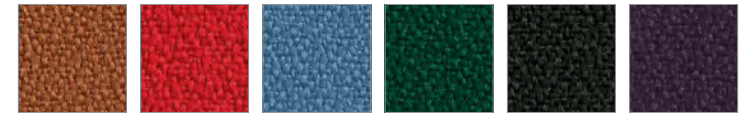

SEATING

MODEL NUMBER	NAME	SEAT HEIGHT	ARM HEIGHT	WIDTH	DEPTH	HEIGHT	FABRIC YARDS	LEATHER SQ FT	WEIGHT/ VOLUME	LIST PRICE	DESCRIPTION
	Web Chair with Plastic Seat and Back WEB-1-BL Black WEB-1-CR Cream WEB-1-BU Blue WEB-1-RD Red WEB-1-GR Green	18 ¹ / ₈ "		22 ⁵ / ₈ "	20 ¹ / ₈ "	32 ⁵ / ₈ "	N/A	N/A	13.22 Lbs 10.59 Cu Ft	\$ 275	The Web Chair has a Chrome Frame Sled Base with a Plastic Seat and Back as well as a Mesh Back with Plastic Seat option. The Mesh Back is available in Black ONLY. It is available in the following five colours:  Red Green Blue Cream Black
	Web Chair with Mesh Black Back WEB-2-BL Black Seat WEB-2-CR Cream Seat	18 ¹ / ₈ "		22 ⁵ / ₈ "	20 ¹ / ₈ "	32 ⁵ / ₈ "	N/A	N/A	13.22 Lbs 10.59 Cu Ft	\$ 325	NOTES: Web has a minimum quantity order of 20 chairs for both models. The Web Chair is stackable up to 10 chairs high without a trolley. With the proper chair trolley, Web can be stacked approximately 40 chairs high. But it is recommended that the chairs be stacked 25 chairs high with a trolley for better stability.
	WEB-3 Web Stacking Trolley, Black ONLY			25 ³ / ₄ "	29 ⁴ / ₅ "	20"			24.2 Lbs 10.60 Cu Ft	\$ 1,535	

	MODEL NUMBER	NAME	SEAT HEIGHT	ARM HEIGHT	WIDTH	DEPTH	HEIGHT	FABRIC YARDS	LEATHER SQ FT	WEIGHT/VOLUME	LIST PRICE	DESCRIPTION
	AM-1-NW AM-1-MR AM-1-SH AM-1-SP	America - 1 Seater Nord Wool Mirage Soft Half Grain Leather Soft Split Leather	18 ¹ / ₈ "		31 ¹ / ₂ "	29 ¹ / ₂ "	33 ¹ / ₂ "	2.62	44.13	38.58 Lbs 17.66 Cu Ft	\$ 1,155 \$ 1,045 \$ 1,730 \$ 1,220	<p>The America Series is available in a selection of 20 Nord Wool Fabrics; 20 Mirage Fabrics; 8 Soft Half Grain Leathers; or 8 Soft Split Leathers.</p> <p>For the complete line of Mirage Fabrics available, refer to page 8 in this specification guide.</p>  <p>For the complete line of Nord Wool Fabrics available, refer to page 8 in this specification guide.</p>  <p>For the complete line of Torre Half Grain Leathers available, refer to page 9 in this specification guide.</p>  <p>For the complete line of Torre Split Leathers available, refer to page 9 in this specification guide.</p> 
	AM-2-NW AM-2-MR AM-2-SH AM-2-SS	America - 2 Seater Nord Wool Mirage Soft Half Grain Leather Soft Split Leather	18 ¹ / ₈ "		47 ¹ / ₄ "	29 ¹ / ₂ "	33 ¹ / ₂ "	3.39	55.97	55.12 Lbs 26.48 Cu Ft	\$ 1,470 \$ 1,325 \$ 2,190 \$ 1,540	
	AM-3-NW AM-3-MR AM-3-SH AM-3-SS	America - 3 Seater Nord Wool Mirage Soft Half Grain Leather Soft Split Leather	18 ¹ / ₈ "		70 ⁷ / ₈ "	29 ¹ / ₂ "	33 ¹ / ₂ "	4.7	78.57	78.3 Lbs 38.85 Cu Ft	\$ 1,860 \$ 1,665 \$ 2,885 \$ 1,970	
	AM-4-NW AM-4-MR AM-4-SH AM-4-SS	America - Corner Nord Wool Mirage Soft Half Grain Leather Soft Split Leather	18 ¹ / ₈ "		29 ¹ / ₂ "	29 ¹ / ₂ "	33 ¹ / ₂ "	3.17	52.74	45 Lbs 16.24 Cu Ft	\$ 1,420 \$ 1,290 \$ 2,110 \$ 1,490	
	AM-5-NW AM-5-MR AM-5-SH AM-5-SS	America Ottoman Nord Wool Mirage Soft Half Grain Leather Soft Split Leather	18 ¹ / ₈ "		29 ¹ / ₂ "	29 ¹ / ₂ "	18 ¹ / ₈ "	1.64	26.91	27.56 Lbs 7.41 Cu Ft	\$ 840 \$ 780 \$ 1,185 \$ 875	





	MODEL NUMBER	NAME	SEAT HEIGHT	ARM HEIGHT	WIDTH	DEPTH	HEIGHT	FABRIC YARDS	LEATHER SQ FT	WEIGHT/VOLUME	LIST PRICE	DESCRIPTION
	CO-1-NW CO-1-MR CO-1-SH CO-1-SS	Corfu 1 Seater Nord Wool Mirage Soft Half Grain Leather Soft Split Leather	16 ¹ / ₈ "		37 ³ / ₈ "	31 ¹ / ₂ "	25 ¹ / ₄ "	3.83	37.67	61.73 Lbs 15.19 Cu Ft	\$ 1,170 \$ 1,010 \$ 1,985 \$ 1,045	The Corfu Series is available in a selection of 20 Nord Wool Fabrics; 20 Mirage Fabrics; 8 Soft Half Grain Leathers; or 8 Soft Split Leathers. For the complete line of Mirage Fabrics available, refer to page 8 in this specification guide.
	CO-2-NW CO-2-MR CO-2-SH CO-2-SS	Corfu 2 Seater Nord Wool Mirage Soft Half Grain Leather Soft Split Leather	16 ¹ / ₈ "		59 ¹ / ₈ "	31 ¹ / ₂ "	25 ¹ / ₄ "	5.36	88.26	79.37 Lbs 24.72 Cu Ft	\$ 1,540 \$ 1,320 \$ 2,675 \$ 1,650	For the complete line of Nord Wool Fabrics available, refer to page 8 in this specification guide.
	CO-3-NW CO-3-MR CO-3-SH CO-3-SS	Corfu 3 Seater Nord Wool Mirage Soft Half Grain Leather Soft Split Leather	16 ¹ / ₈ "		78"	31 ¹ / ₂ "	25 ¹ / ₄ "	7.22	118.4	94.8 Lbs 33.9 Cu Ft	\$ 1,995 \$ 1,690 \$ 3,510 \$ 2,130	For the complete line of Torre Half Grain Leathers available, refer to page 9 in this specification guide. For the complete line of Torre Split Leathers available, refer to page 9 in this specification guide.

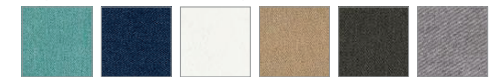
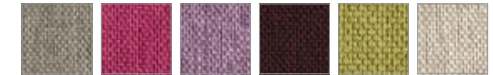
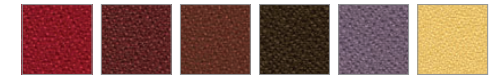

	MODEL NUMBER	NAME	SEAT HEIGHT	ARM HEIGHT	WIDTH	DEPTH	HEIGHT	FABRIC YARDS	LEATHER SQ FT	WEIGHT/VOLUME	LIST PRICE	DESCRIPTION
	BL-1-CB BL-1-FD BL-1-JY BL-1-CH	Bloom Round Cornerblock Fabric Foundation Fabric Journey Fabric Challenger Vinyl			16 ³ / ₄ "	16 ³ / ₄ "	16 ³ / ₄ "	1.5		6.6 Lbs 2.7 Cu Ft	\$ 719 \$ 719 \$ 719 \$ 773	The Bloom series is available in a selection of 12 Cornerblock Fabrics; 18 Foundation Fabrics; 20 Journey Fabrics or 40 Challenger Vinyls. For the complete line of Cornerblock Fabrics available, refer to page 2 in this specification guide.
	BL-2-CB BL-2-FD BL-2-JY BL-2-CH	Bloom Moon Cornerblock Fabric Foundation Fabric Journey Fabric Challenger Vinyl			16 ³ / ₄ "	16 ³ / ₄ "	16 ³ / ₄ "	1.5		6.4 Lbs 2.7 Cu Ft	\$ 789 \$ 789 \$ 789 \$ 827	For the complete line of Foundation Fabrics available, refer to page 2 in this specification guide.
	BL-3-CB BL-3-FD BL-3-JY BL-3-CH	Bloom 2 Seater Cornerblock Fabric Foundation Fabric Journey Fabric Challenger Vinyl			47 ⁵ / ₈ "	24 ⁵ / ₈ "	16 ³ / ₄ "	2.85		22 Lbs 11.4 Cu Ft	\$ 1,851 \$ 1,851 \$ 1,851 \$ 1,904	For the complete line of Journey Fabrics available, refer to page 4 in this specification guide.
	BL-4-CB BL-4-FD BL-4-JY BL-4-CH	Bloom Disc Cornerblock Fabric Foundation Fabric Journey Fabric Challenger Vinyl			16 ³ / ₄ "	16 ³ / ₄ "	2"	0.75			\$ 503 \$ 503 \$ 503 \$ 555	For the complete line of Challenger Vinyls available, refer to page 4 in this specification guide.
	BL-4-TRL	Bloom Disc Trolley			17 ¹ / ₂ "	16 ¹ / ₂ "	36"				\$ 1,696	Mobile trolley and storage of Bloom disc cushions capacity: 14 pcs.



SEATING

	MODEL NUMBER	PRODUCT	WIDTH	DEPTH	HEIGHT	PRICE	DESCRIPTION
	NM-SS-100-CH	30° Curve Solice Seating Challenger Vinyl	28"	24"	18"	\$ 1,878	The Solice seating series is available in a selection of 40 Challenger vinyls.
	NM-SS-200-CH	60° Curve Solice Seating Challenger Vinyl	54"	24"	18"	\$ 3,104	
	NM-SS-201-CH	Challenger Vinyl	43"	24"	18"	\$ 2,286	
	NM-SS-300-CH	Pentagon Solice Seating Challenger Vinyl	30"	29"	18"	\$ 2,119	
	NM-SS-301-CH	Challenger Vinyl	40"	38"	18"	\$ 2,560	

NM-SS-201 60° Curve Solice seating matches up with NM-100 & NM-101 Sola mobile shelving.



NM-SS-300 Pentagon and NM-SS-700 Rectangle Solice seating.







NM-SS-100, NM-SS-200 & NM-SS-201 30° & 60° Curve Solice seating.







NM-SS-200 60° Curve Solice seating.



	MODEL NUMBER	PRODUCT	WIDTH	DEPTH	HEIGHT	PRICE	DESCRIPTION
		Round Solice Seating					The Solice seating series is available in a selection of 40 Challenger vinyls.
	NM-SS-400-CH	Challenger Vinyl	24"	24"	18"	\$ 1,516	
	NM-SS-401-CH	Challenger Vinyl	36"	36"	18"	\$ 2,645	
	NM-SS-402-CH	Challenger Vinyl	48"	48"	18"	\$ 3,225	
		Half Round Solice Seating					
	NM-SS-500-CH	Challenger Vinyl	36"	18"	18"	\$ 2,400	
	NM-SS-501-CH	Challenger Vinyl	48"	24"	18"	\$ 2,645	

NM-SS-500 & NM-SS-601 Half Round & Square Solice seating.



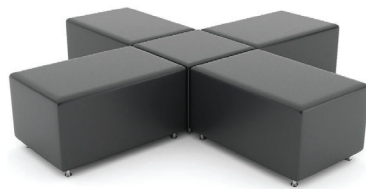

	MODEL NUMBER	PRODUCT	WIDTH	DEPTH	HEIGHT	PRICE	DESCRIPTION
		Square Solice Seating					The Solice seating series is available in a selection of 40 Challenger vinyls.
	NM-SS-600-CH	Challenger Vinyl	24"	24"	18"	\$ 1,636	
	NM-SS-601-CH	Challenger Vinyl	36"	36"	18"	\$ 1,920	
		Rectangle Solice Seating					
	NM-SS-700-CH	Challenger Vinyl	18"	36"	18"	\$ 1,672	
	NM-SS-701-CH	Challenger Vinyl	24"	36"	18"	\$ 1,757	
	NM-SS-702-CH	Challenger Vinyl	24"	48"	18"	\$ 1,926	

NM-SS-600 & NM-SS-701 Square and Rectangle Solice seating.



NM-SS-702 Rectangle Solice seating.

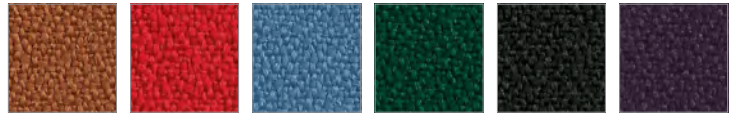
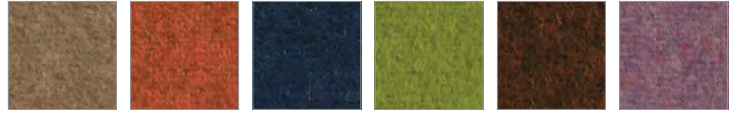

	MODEL NUMBER	NAME	SEAT HEIGHT	ARM HEIGHT	WIDTH	DEPTH	HEIGHT	FABRIC YARDS	LEATHER SQ FT	WEIGHT/VOLUME	LIST PRICE	DESCRIPTION
		RECTANGLE;										<p>The Molecule Series is available in either a selection of 20 Nord Wool Fabrics or 20 Mirage Fabrics.</p> <p>For the complete line of Mirage Fabrics available, refer to page 8 in this specification guide.</p>  <p>For the complete line of Nord Wool Fabrics available, refer to page 8 in this specification guide.</p> 
	ML-11-NW ML-11-NW	24" Width Nord Wool Mirage			23 ⁵ / ₈ "	30 ¹ / ₄ "	20"	2.3	39	39 Lbs 8.5 Cu Ft	\$ 1,070 \$ 950	
	ML-12-NW ML-12-MR	48" Width Nord Wool Mirage			47 ¹ / ₄ "	30 ¹ / ₄ "	20"	2.75	45.5	45.5 Lbs 16.5 Cu Ft	\$ 1,405 \$ 1,280	
	ML-13-NW ML-13-MR	71" Width Nord Wool Mirage			70 ³ / ₄ "	30 ¹ / ₄ "	20"	3.3	55	55 Lbs 25 Cu Ft	\$ 1,795 \$ 1,635	
		RECTANGLE, 1 SEMI-CIRCLE END;										
	ML-21-NW ML-21-MR	24" Width Nord Wool Mirage			23 ⁵ / ₈ "	30 ¹ / ₄ "	20"	2.5	42	42 Lbs 11 Cu Ft	\$ 1,170 \$ 1,060	
	ML-22-NW ML-22-MR	48" Width Nord Wool Mirage			47 ¹ / ₄ "	30 ¹ / ₄ "	20"	3	51	51 Lbs 19 Cu Ft	\$ 1,550 \$ 1,390	
	ML-23-NW ML-23-MR	71" Width Nord Wool Mirage			70 ³ / ₄ "	30 ¹ / ₄ "	20"	4	63.5	63.5 Lbs 27 Cu Ft	\$ 1,945 \$ 1,770	
		RECTANGLE, 2 SEMI-CIRCLE ENDS;										
	ML-31-NW ML-31-MR	24" Width Nord Wool Mirage			23 ⁵ / ₈ "	30 ¹ / ₄ "	20"	2.5	42	42 Lbs 13 Cu Ft	\$ 1,270 \$ 1,150	
	ML-32-NW ML-32-MR	48" Width Nord Wool Mirage			47 ¹ / ₄ "	30 ¹ / ₄ "	20"	3	51	51 Lbs 21 Cu Ft	\$ 1,650 \$ 1,520	
	ML-33-NW ML-33-MR	71" Width Nord Wool Mirage			70 ³ / ₄ "	30 ¹ / ₄ "	20"	4	63.5	63.5 Lbs 29 Cu Ft	\$ 2,075 \$ 1,900	

MODEL NUMBER	NAME	SEAT HEIGHT	ARM HEIGHT	WIDTH	DEPTH	HEIGHT	FABRIC YARDS	LEATHER SQ FT	WEIGHT/VOLUME	LIST PRICE	DESCRIPTION
ML-41-NW ML-41-MR	RECTANGLE, 1 SEMI-CIRCLE END, 1 ROUND END;										<p>The Molecule Series is available in a selection of 20 Nord Wool Fabrics or 20 Mirage Fabrics.</p> <p>For the complete line of Mirage Fabrics available, refer to page 8 in this specification guide.</p> 
	24" Width Nord Wool Mirage			23 ⁵ / ₈ "	30 ¹ / ₄ "	20"	3.2	53.5	53.5 Lbs 11 Cu Ft	\$ 1,490 \$ 1,330	
	48" Width Nord Wool Mirage			47 ¹ / ₄ "	30 ¹ / ₄ "	20"	4	67	67 Lbs 19 Cu Ft	\$ 1,930 \$ 1,680	
ML-42-NW ML-42-MR	71" Width Nord Wool Mirage			70 ³ / ₄ "	30 ¹ / ₄ "	20"	5.3	88	88 Lbs 27 Cu Ft	\$ 2,380 \$ 2,120	<p>For the complete line of Nord Wool Fabrics available, refer to page 8 in this specification guide.</p> 



ML-5-NW ML-5-MR	CIRCLE;			26" Dia		21 ⁵ / ₈ "	1.7	27.5	27.5 Lbs 8 Cu Ft	\$ 690 \$ 615	<p>The standard 26" Circle model is entirely covered in fabric, just like models ML-1 to ML-4.</p>
	Nord Wool Mirage										







ML-6-NW-LT ML-6-MR-LT	CIRCLE, WHITE LAMINATE TOP ONLY;			26" Dia		21 ⁵ / ₈ "	1.7	27.5	27.5 Lbs 8 Cu Ft	\$1,535 \$1,460	<p>The 26" Circle with a White Laminate Top and White Acrylic Edge. All other colors of laminate for this particular product are considered an upcharge.</p>
	Nord Wool Mirage										



ML-6-NW-LT- P-PS-T	CIRCLE, WHITE LAMINATE TOP, POWER SPHERE WITH 4 OUTLETS;			26" Dia		21 ⁵ / ₈ "	1.7	27.5	27.5 Lbs 8 Cu Ft	\$1,810	<p>The 26" Circle with a White Laminate Top, White Acrylic Edge, and Translucent Power Sphere with 4 Electrical Outlets. All other colors of laminate for this particular product are considered an upcharge.</p>
ML-6-MR-LT- P-PS-T	Nord Wool Mirage									\$1,735	

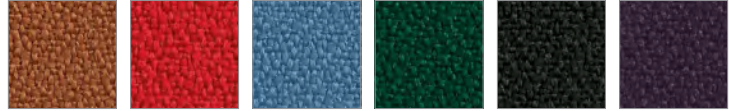
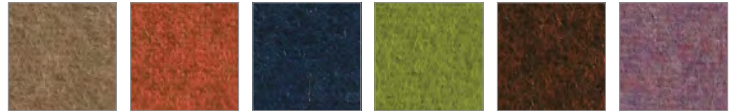

SEATING

	MODEL NUMBER	NAME	SEAT HEIGHT	ARM HEIGHT	WIDTH	DEPTH	HEIGHT	FABRIC YARDS	LEATHER SQ FT	WEIGHT/ VOLUME	LIST PRICE	DESCRIPTION
	PE-1-NW	Penny 1 Seater Nord Wool	16 ³ / ₄ "		17 ³ / ₈ "	17 ³ / ₈ "	16 ³ / ₄ "	0.93	15.6	8.82 Lbs 3.53 Cu Ft	\$ 275	<p>The Penny Series is available in a selection of 20 Nord Wool Fabrics; 20 Mirage Fabrics; 8 Soft Half Grain Leathers; or 8 Soft Split Leathers.</p> <p>For the complete line of Mirage Fabrics available, refer to page 8 in this specification guide.</p>  <p>For the complete line of Nord Wool Fabrics available, refer to page 8 in this specification guide.</p>  <p>For the complete line of Torre Half Grain Leathers available, refer to page 9 in this specification guide.</p>  <p>For the complete line of Torre Split Leathers available, refer to page 9 in this specification guide.</p> 
	PE-1-MR	Mirage									\$ 235	
	PE-1-SH	Soft Half Grain Leather									\$ 705	
	PE-1-SS	Soft Split Leather									\$ 300	
	PE-2-NW	Penny 2 Seater Nord Wool	16 ³ / ₄ "		34 ⁵ / ₈ "	17 ³ / ₈ "	16 ³ / ₄ "	1.48	24.22	17.64 Lbs 7.06 Cu Ft	\$ 395	
	PE-2-MR	Mirage									\$ 335	
	PE-2-SH	Soft Half Grain Leather									\$ 950	
	PE-2-SS	Soft Split Leather									\$ 435	



MODEL NUMBER	NAME	SEAT HEIGHT	ARM HEIGHT	WIDTH	DEPTH	HEIGHT
AQ-1-BL	Aqua Task Chair Black Mesh Back and Seat Only	16 ¹ / ₂ "-20 ¹ / ₂ "		19"	16 ¹ / ₂ "- 18 ¹ / ₂ "	43 ¹ / ₂ "- 49 ¹ / ₂ "

FABRIC YARDS	LEATHER SQ FT	WEIGHT/ VOLUME	LIST PRICE
		47 Lbs	\$ 1,365

DESCRIPTION
The Aqua task chair is constructed with a mesh back and seat for ergonomic comfort and support. It has an adjustable lumbar support, back angle adjustment, with back tension adjustment. Its arms have a SPA arm pad swivel and are height adjustable up to 3 inches. The chair height adjustment is done easily through a lever in the armrest. The chair has a 2 inch seat slider. The base is a five-star aluminium polished base with twin-wheel casters.





LK-1-TN	Link Task Chair Black Mesh Back Only Turner Vinyl Seat	16"-21 ¹ / ₂ "		19"	18 ¹ / ₂ "	39"-44"
---------	--	--------------------------------------	--	-----	----------------------------------	---------

47 Lbs	\$ 1,900
--------	----------

DESCRIPTION
The Link task chair is constructed with a polyester mesh back and polyurethane foam seat. The lumbar support is adjustable up to 2 inches. Tilting movements of the chair uses synchro multiblock, "fine" tilting adjustment and anti-return safety system. The seat swivel and height adjustment is obtained by a 4 inch pneumatic gas cylinder. The base is 5-star BIFMA approved.

The Link seat is upholstered in 1 of 26 available colors in Turner Vinyl. *Refer to page 10-11 in this specification guide.

	MODEL NUMBER	NAME	SEAT HEIGHT	ARM HEIGHT	WIDTH	DEPTH	HEIGHT	FABRIC YARDS	LEATHER SQ FT	WEIGHT/ VOLUME	LIST PRICE	DESCRIPTION
	RE-1-TN	Rite Task Chair Black Mest Back Only Turner Vinyl Seat	18"-22"		19"	19"	37"-46"			39 Lbs	\$ 1,180	<p>Rite task chair is constructed with a black mesh back and a upholstered molded foam seat. Rite has a tension knob, and 5 locking positions with "shock-resistance" black finish. The base is a 5-Star BIFMA approved black painted aluminium with VTW, Carpet Twin-Wheel casters.</p> <p>The Rite seat is upholstered in 1 of 26 available colors in Turner Vinyl. *Refer to page 10-11 in this specification guide.</p>
	SV-1-TN	Seven Task Chair; Black Polypropylene Back Only, Turner Vinyl Seat	16 ¹ / ₂ "-22"		20"	17"	37 ¹ / ₂ "- 42 ¹ / ₂ "			39 Lbs	\$ 1,325	<p>Seven task chair is constructed with a polypropylene back with a lumbar support in ABS, covered in soft black polyurethane. Seat cover is made of shock and scratch proof polypropylene, reinforced with steel square tubular bars. All foam is fire-retardant polyurethane. Adjustable armrest are chrome-plated steel with black polypropylene arm pads. Tilting movements of the chair uses synchro multiblock, "fine" tilting adjustment and anti-return safety system. The seat swivel and height adjustment is obtained with a pneumatic gas cylinder. The base is 5-star BIFMA approved.</p> <p>The Seven seat is upholstered in 1 of 26 available colors in Turner Vinyl. *Refer to page 10-11 in this specification guide.</p>





MODEL NUMBER	NAME	SEAT HEIGHT	ARM HEIGHT	WIDTH	DEPTH	HEIGHT	FABRIC YARDS	LEATHER SQ FT	WEIGHT/ VOLUME	LIST PRICE	DESCRIPTION
AB-1-O AB-1-M	Ambassador Chair Oak Maple	18"		20"	24"	36"	N/A	N/A	25 Lbs 6 Cu Ft	\$ 455 \$ 495	The Ambassador Chair is constructed of 1 1/4" Thick Solid Hardwood Material available in standard Natural Clear Finish. For the complete line of Maple Wood Finishes and options, refer to page 12 in this specification guide.
AB-2-O AB-2-M	Ambassador Armchair 18" Oak Maple			23 1/2"	24"	36"	N/A	N/A	27 Lbs 6 Cu Ft	\$ 555 \$ 590	For the complete line of Red Oak Wood Finishes and options, refer to page 12 in this specification guide.
AB-1U-O AB-1U-M	Ambassador Upholstered Chair Oak Maple	18"		20"	24"	36"			25 Lbs 6 Cu Ft	\$ 630 \$ 665	The Upholstered Ambassador Chair is 1 1/16" Thick Veneer Core Plywood with a 1 1/2" Thick Firm Grade Foam
AB-2U-O AB-2U-M	Ambassador Upholstered Armchair Oak Maple	18"		23 1/2"	24"	36"			27 Lbs 6 Cu Ft	\$ 665 \$ 705	

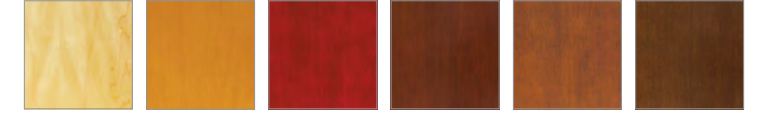

MODEL NUMBER	NAME	SEAT HEIGHT	ARM HEIGHT	WIDTH	DEPTH	HEIGHT	FABRIC YARDS	LEATHER SQ FT	WEIGHT/ VOLUME	LIST PRICE	DESCRIPTION
AP-1-O AP-1-M	Aspen Chair Oak Maple	18"		18 1/2"	22"	33"	N/A	N/A	25 Lbs 6 Cu Ft	\$ 475 \$ 515	The Aspen Chair is constructed of 1" Thick Solid Hardwood Material available in standard Natural Clear Finish. For the complete line of Maple Wood Finishes and options, refer to page 12 in this specification guide.
AP-2-O AP-2-M	Aspen Armchair Oak Maple	18"		22 1/2"	22"	33"	N/A	N/A	27 Lbs 6 Cu Ft	\$ 555 \$ 590	For the complete line of Red Oak Wood Finishes and options, refer to page 12 in this specification guide.
AP-1U-O AP-1U-M	Aspen Upholstered Chair Oak Maple	18"		18 1/2"	22"	33"			25 Lbs 6 Cu Ft	\$ 495 \$ 535	The Upholstered Aspen Chair is 11/16" Thick Veneer Core Plywood with a 1 1/2" Thick Firm Grade Foam
AP-2U-O AP-2U-M	Aspen Upholstered Armchair Oak Maple	18"		22 1/2"	22"	33"			27 Lbs 6 Cu Ft	\$ 535 \$ 570	





MODEL NUMBER	NAME	SEAT HEIGHT	ARM HEIGHT	WIDTH	DEPTH	HEIGHT	FABRIC YARDS	LEATHER SQ FT	WEIGHT/ VOLUME	LIST PRICE	DESCRIPTION
AV-1-O AV-1-M	Avondale Chair Oak Maple	17 ³ / ₄ "		19 ³ / ₄ "	19"	37"	N/A	N/A	18 Lbs 7.5 Cu Ft	\$ 495 \$ 530	The Avondale Chair is constructed of 1" Thick Solid Hardwood Material available in standard Natural Clear Finish. For the complete line of Maple Wood Finishes and options, refer to page 12 in this specification guide.
											
AV-2-O AV-2-M	Avondale Armchair Oak Maple	17 ³ / ₄ "		19 ³ / ₄ "	19"	37"	N/A	N/A	18 Lbs 7.5 Cu Ft	\$ 645 \$ 685	For the complete line of Red Oak Wood Finishes and options, refer to page 12 in this specification guide.
											
AV-1U-O AV-1U-M	Avondale Chair Upholstered Oak Maple	18 ¹ / ₂ "		19 ³ / ₄ "	19"	37"			18 Lbs 7.5 Cu Ft	\$ 530 \$ 570	The Upholstered Avondale Chair is 1 ¹ / ₁₆ " Thick Veneer Core Plywood with a 1 ¹ / ₂ " Thick Firm Grade Foam
AV-2U-O AV-2U-M	Avondale Armchair Upholstered Oak Maple	18 ¹ / ₂ "		19 ³ / ₄ "	19"	37"			18 Lbs 7.5 Cu Ft	\$ 570 \$ 605	



MODEL NUMBER	NAME	SEAT HEIGHT	ARM HEIGHT	WIDTH	DEPTH	HEIGHT
BD-1	Bulldog Side Chair	18 ¹ / ₄ "		18"	19"	35"

FABRIC YARDS	LEATHER SQ FT	WEIGHT/ VOLUME	LIST PRICE	DESCRIPTION
N/A	N/A	19 Lbs 9.31 Cu Ft	\$ 400	The Bulldog Chair is constructed from 100% Solid European Beech Hardwood available in standard Natural Clear Finish.

BD-2	Bulldog Armchair	18"	27"	17 ³ / ₄ "	19 ¹ / ₂ "	35"
------	------------------	-----	-----	----------------------------------	----------------------------------	-----

N/A	N/A	21 Lbs 9.3 Cu Ft	\$ 580	
-----	-----	---------------------	--------	--



BD-1U	Bulldog Upholstered Side Chair	18 ¹ / ₄ "		18"	19"	35"
-------	--------------------------------	----------------------------------	--	-----	-----	-----

.35	N/A	19 Lbs 9.31 Cu Ft	\$ 500	
-----	-----	----------------------	--------	--



The Upholstered Bulldog Chair has a 100% Solid European Beech Hardwood Seat; High Density Cushion Foam on Seat; Customer's Own Material Fabric Required for Upholstered Seats











BD-2U	Bulldog Upholstered Armchair	18"	27"	17 ³ / ₄ "	19 ¹ / ₂ "	35"
-------	------------------------------	-----	-----	----------------------------------	----------------------------------	-----





.35	N/A	21 Lbs 9.3 Cu Ft	\$ 680	
-----	-----	---------------------	--------	--

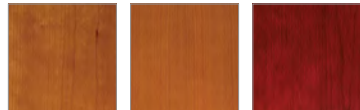

SEATING

	MODEL NUMBER	NAME	SEAT HEIGHT	ARM HEIGHT	WIDTH	DEPTH	HEIGHT	FABRIC YARDS	LEATHER SQ FT	WEIGHT/ VOLUME	LIST PRICE	DESCRIPTION
	BD-42-1	Bulldog 42" Bench Without Arms	18"		44 ¹ / ₂ "	18 ¹ / ₂ "	35"	N/A	N/A	40 Lbs 22 Cu Ft	\$ 1,100	The Bulldog Bench is constructed from 100% Solid European Beech Hardwood available in standard Natural Clear Finish.
	BD-42-2	Bulldog 42" Bench With Arms	18"	27"	44 ¹ / ₂ "	18 ¹ / ₂ "	35"	N/A	N/A	42 Lbs 22 Cu Ft	\$ 1,185	
	BD-60-1	Bulldog 60" Bench Without Arms	18"		59 ¹ / ₂ "	18 ¹ / ₂ "	35"	N/A	N/A	47 Lbs 29 Cu Ft	\$ 1,270	
	BD-60-2	Bulldog 60" Bench With Arms	18"	27"	59 ¹ / ₂ "	18 ¹ / ₂ "	35"	N/A	N/A	49 Lbs 29 Cu Ft	\$ 1,355	
	BD-42-1U	Bulldog Upholstered 42" Bench Without Arms	18"		44 ¹ / ₂ "	18 ¹ / ₂ "	35"			40 Lbs 22 Cu Ft	\$ 1,375	The Upholstered Bulldog Bench has a 100% Solid European Beech Hardwood Seat; High Density Cushion Foam on Seat; Customer's Own Material Fabric Required for Upholstered Seats
	BD-42-2U	Bulldog Upholstered 42" Bench With Arms	18"	27"	44 ¹ / ₂ "	18 ¹ / ₂ "	35"			42 Lbs 22 Cu Ft	\$ 1,460	
	BD-60-1U	Bulldog Upholstered 60" Bench Without Arms	18"		59 ¹ / ₂ "	18 ¹ / ₂ "	35"			47 Lbs 29 Cu Ft	\$ 1,760	
	BD-60-2U	Bulldog Upholstered 60" Bench With Arms	18"	27"	59 ¹ / ₂ "	18 ¹ / ₂ "	35"			49 Lbs 29 Cu Ft	\$ 1,845	

	MODEL NUMBER	NAME	SEAT HEIGHT	ARM HEIGHT	WIDTH	DEPTH	HEIGHT	FABRIC YARDS	LEATHER SQ FT	WEIGHT/ VOLUME	LIST PRICE	DESCRIPTION
	BD-B1	Bulldog Barstool	24"		18"	19"	41 ¹ / ₄ "	N/A	N/A	22 Lbs 10.3 Cu Ft	\$ 440	The Bulldog Barstool is constructed from 100% Solid European Beech Hardwood available in standard Natural Clear Finish.
	BD-B2	Bulldog Backless Barstool	24"		16"	15 ³ / ₄ "	24"	N/A	N/A	16 Lbs 10 Cu Ft	\$ 335	Barstools available in custom seat heights ranging from 24" to 30"; Standard Kickplates are brass. Chrome kickplates are available upon request for the same price
	BD-B1U	Bulldog Upholstered Barstool	24"		18"	19"	41 ¹ / ₄ "	.35	N/A	22 Lbs 10.3 Cu Ft	\$ 575	The Upholstered Bulldog Barstool has a 100% Solid European Beech Hardwood Seat; High Density Cushion Foam on Seat; Customer's Own Material Fabric Required for Upholstered Seats
	BD-B2U	Bulldog Upholstered Backless Barstool	24"		16"	15 ³ / ₄ "	24"	.35	N/A	16 Lbs 10 Cu Ft	\$ 475	

	MODEL NUMBER	NAME	SEAT HEIGHT	ARM HEIGHT	WIDTH	DEPTH	HEIGHT	FABRIC YARDS	LEATHER SQ FT	WEIGHT/ VOLUME	LIST PRICE	DESCRIPTION
	CA-12	Carlo Junior 12" Seat Height	12"		14"	14 1/2"	22"	N/A	N/A	5 1/2 Lbs 5.85 Cu Ft	\$ 215	<p>The Carlo Junior collection offers a 12" or 14" seat height. The construction is wood dowel and they are offered in any of our custom wood finishes. Available in wood seat only. Chair is stackable up to 6 chairs high.</p> <p>For the complete line of Maple Wood Finishes and options, refer to page 12 in this specification guide.</p> 
	CA-14	Carlo Junior 14" Seat Height	14"		14"	16"	25 1/2"	N/A	N/A	6 1/4 Lbs 5.85 Cu Ft	\$ 220	<p>For the complete line of Red Oak Wood Finishes and options, refer to page 12 in this specification guide.</p>  <p>For the complete line of Cherry Wood Finishes and options, refer to page 12 in this specification guide.</p>  <p>For the complete line of Walnut Wood Finishes and options, refer to page 12 in this specification guide.</p> 
												

	MODEL NUMBER	NAME	SEAT HEIGHT	ARM HEIGHT	WIDTH	DEPTH	HEIGHT	FABRIC YARDS	LEATHER SQ FT	WEIGHT/ VOLUME	LIST PRICE	DESCRIPTION
	HN-1	Henry Side Chair	18"		18 ¹ / ₄ "	20 ³ / ₄ "	34 ¹ / ₄ "	N/A	N/A	17 Lbs 9.3 Cu Ft	\$ 450	The Henry Series is constructed from 100% Solid European Beech Hardwood available in standard Natural Clear Finish.
	HN-1U	Henry Upholstered Side Chair	18"		18 ¹ / ₄ "	20 ³ / ₄ "	34 ¹ / ₄ "			17 Lbs 9.3 Cu Ft	\$ 550	The Upholstered Henry Series has a 100% Solid European Beech Hardwood Seat; High Density Cushion Foam on Seat; Customer's Own Material Fabric Required for Upholstered Seats.
	HN-B1	Henry Barstool	24"		18 ¹ / ₄ "	19 ¹ / ₄ "	37"	N/A	N/A	17 Lbs 10 Cu Ft	\$ 510	Barstools are available in custom seat heights ranging from 24" to 30"; Standard Kickplates are brass. Chrome kickplates are available upon request for the same price.
	HN-B1U	Henry Upholstered Barstool	30"		18 ¹ / ₄ "	19 ¹ / ₄ "	43"			17 Lbs 10 Cu Ft	\$ 610	





MODEL NUMBER	NAME	SEAT HEIGHT	ARM HEIGHT	WIDTH	DEPTH	HEIGHT	FABRIC YARDS	LEATHER SQ FT	WEIGHT/ VOLUME	LIST PRICE	DESCRIPTION
HU-1-O HU-1-M	Hudson Chair Oak Maple	18"		21"	20"	38"	N/A	N/A	18 Lbs 7.5 Cu Ft	\$ 495 \$ 540	The Hudson Chair is constructed of Solid Hardwood available in standard Natural Clear Finish. For the complete line of Maple Wood Finishes and options, refer to page 12 in this specification guide. 
HU-2-O HU-2-M	Hudson Armchair Oak Maple	18"	25 ⁵ / ₈ "	21"	20"	38"	N/A	N/A	19 Lbs 7.5 Cu Ft	\$ 570 \$ 620	For the complete line of Red Oak Wood Finishes and options, refer to page 12 in this specification guide. 
HU-1U-O HU-1U-M	Hudson Chair Upholstered Oak Maple	18"		21"	20"	38"			18 Lbs 7.5 Cu Ft	\$ 535 \$ 580	The Hudson Chair is also available with an upholstered seat constructed from High Density Upholstered Cushion Foam.
HU-2U-O HU-2U-M	Hudson Upholstered Armchair Oak Maple	18"	25 ⁵ / ₈ "	21"	20"	38"			19 Lbs 7.5 Cu Ft	\$ 605 \$ 655	







MODEL NUMBER	NAME	SEAT HEIGHT	ARM HEIGHT	WIDTH	DEPTH	HEIGHT	FABRIC YARDS	LEATHER SQ FT	WEIGHT/ VOLUME	LIST PRICE	DESCRIPTION
LD-1-O	Lido Chair Oak	18"		18 ¹ / ₂ "	18"	32"	N/A	N/A	23 Lbs 5 Cu Ft	\$ 365	<p>The Lido Chair is constructed of Solid Hardwood Frame with a ³/₄" Thick 3 Ply Shaped Plywood with Grade "A" Face Veneers on front and back Seat. The Lido Chair is available in standard Natural Clear Finish.</p> <p>For the complete line of Red Oak Wood Finishes and options, refer to page 12 in this specification guide.</p>  <p>The Lido Chair is also available with a ³/₈" Thick Shaped Plywood with a 1¹/₄" Thick Foam Covering Upholstered Seat and Back.</p>
LD-1-C-O	Lido Youth Chair Oak	16"		18 ¹ / ₂ "	18"	30"	N/A	N/A	23 Lbs 5 Cu Ft	\$ 365	
LD-1-J-O	Lido Juvenile Chair Oak	14"		16"	15 ¹ / ₂ "	26"	N/A	N/A	20 Lbs 4 Cu Ft	\$ 325	
LD-1-P-O	Lido Primary Chair Oak	12"		16"	15 ¹ / ₂ "	24"	N/A	N/A	20 Lbs 4 Cu Ft	\$ 325	
LD-2-O	Lido Armchair Oak	18"	24 ¹ / ₂ "	23"	18"	32"	N/A	N/A	27 Lbs 6 Cu Ft	\$ 440	
LD-3-O	Lido Sled Base Chair Oak	18"		18 ¹ / ₂ "	18"	32"	N/A	N/A	23 Lbs 5 Cu Ft	\$ 440	
LD-32-O	Lido Sled Base Armchair Oak	18"	24 ¹ / ₂ "	23"	18"	32"	N/A	N/A	27 Lbs 6 Cu Ft	\$ 475	



MODEL NUMBER	NAME	SEAT HEIGHT	ARM HEIGHT	WIDTH	DEPTH	HEIGHT	FABRIC YARDS	LEATHER SQ FT	WEIGHT/VOLUME	LIST PRICE	DESCRIPTION
LD-1U-O LD-1U-M	Lido Upholstered Oak Maple	18"		18 1/2"	18"	32"			23 Lbs 5 Cu Ft	\$ 495 \$ 535	<p>The Lido Chair is constructed of Solid Hardwood Frame with a 3/4" Thick 3 Ply Shaped Plywood with Grade "A" Face Veneers on front and back Seat. The Lido Chair is available in standard Natural Clear Finish.</p> <p>For the complete line of Maple Wood Finishes and options, refer to page 12 in this specification guide.</p>  <p>For the complete line of Red Oak Wood Finishes and options, refer to page 12 in this specification guide.</p>  <p>The Lido Chair is also available with a 3/8" Thick Shaped Plywood with a 1 1/4" Thick Foam Covering Upholstered Seat and Back.</p>
LD-1U-C-O LD-1U-C-M	Lido Upholstered Youth Chair Oak Maple	16"		18 1/2"	18"	30"			23 Lbs 5 Cu Ft	\$ 495 \$ 535	
LD-1U-J-O LD-1U-J-M	Lido Upholstered Juvenile Chair Oak Maple	14"		16"	15 1/2"	26"			20 Lbs 4 Cu Ft	\$ 460 \$ 495	
LD-1U-P-O LD-1U-P-M	Lido Upholstered Primary Chair Oak Maple	12"		16"	15 1/2"	24"			20 Lbs 4 Cu Ft	\$ 460 \$ 495	
LD-2U-O LD-2U-M	Lido Upholstered Armchair Oak Maple	18"	24 1/2"	23"	18"	32"			27 Lbs 6 Cu Ft	\$ 570 \$ 610	
LD-3U-O LD-3U-M	Lido Upholstered Sled Base Chair Oak Maple	18"		18 1/2"	18"	32"			23 Lbs 5 Cu Ft	\$ 610 \$ 650	
LD-32U-O LD-32U-M	Lido Upholstered Sled Base Chair Armchair Oak Maple	18"	24 1/2"	23"	18"	32"			27 Lbs 6 Cu Ft	\$ 650 \$ 685	

	MODEL NUMBER	NAME	SEAT HEIGHT	ARM HEIGHT	WIDTH	DEPTH	HEIGHT	FABRIC YARDS	LEATHER SQ FT	WEIGHT/VOLUME	LIST PRICE	DESCRIPTION
	MO-1	Montana Side Chair	18"		18 ¹ / ₂ "	21"	35"	N/A	N/A	13 Lbs 9.3 Cu Ft	\$ 450	The Montana Series is constructed from 100% Solid European Beech Hardwood available in standard Natural Clear Finish.
	MO-1U	Montana Upholstered 18" Side Chair			18 ¹ / ₂ "	21"	35"			13 Lbs 9.3 Cu Ft	\$ 550	The Upholstered Montana Series has a 100% Solid European Beech Hardwood Seat; High Density Cushion Foam on Seat; Customer's Own Material Fabric Required for Upholstered Seats.
	MO-B1	Montana Barstool	30"		17 ¹ / ₄ "	18 ¹ / ₄ "	43 ³ / ₄ "	N/A	N/A	20 Lbs 10 Cu Ft	\$ 510	Montana Barstools are available in custom seat heights ranging from 24" to 30"; Standard Kickplates are brass. Chrome kickplates are available upon request for the same price.
	MO-B1U	Montana Upholstered Barstool	30"		17 ¹ / ₄ "	18 ¹ / ₄ "	43 ³ / ₄ "			20 Lbs 10 Cu Ft	\$ 610	

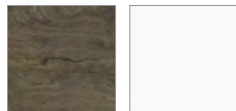
	MODEL NUMBER	NAME	SEAT HEIGHT	ARM HEIGHT	WIDTH	DEPTH	HEIGHT	FABRIC YARDS	LEATHER SQ FT	WEIGHT/ VOLUME	LIST PRICE	DESCRIPTION
	SS-1-O SS-1-M	Silver Sled Oak Maple	16 ³ / ₄ "		17"	18 ⁵ / ₈ "	32"	N/A	N/A	17 Lbs 5.5 Cu Ft	\$ 555 \$ 590	The Silver Sled Chair is constructed of Solid Hardwood available in Standard Natural Clear Finish. For the complete line of Maple Wood Finishes and options, refer to page 12 in this specification guide.
	SS-1U-O SS-1U-M	Silver Sled Upholstered Oak Maple	18 ¹ / ₄ "		17"	18 ⁵ / ₈ "	32"			17 Lbs 5.5 Cu Ft	\$ 630 \$ 665	For the complete line of Red Oak Wood Finishes and options, refer to page 12 in this specification guide.
	WG-1-BL WG-1-GY WG-1-OR WG-1-YE WG-1-LB	Wogg Chair Beech Black Dark Sea Grey Argovian Sun Zinc Light Sea Blue	18 ¹ / ₈ "		20 ¹ / ₂ "	19 ⁵ / ₈ "	31 ⁷ / ₈ "	N/A	N/A		\$ 2,220	Constructed from molded Beech or Ash wood available in the following colours.
	WG-2-BL WG-2-GY WG-2-OR WG-2-YE WG-2-LB WG-2-SM WG-2-PL	Wogg Chair Ash Black Dark Sea Grey Argovian Sun Zinc Light Sea Blue *Smoke *Pearl	18 ¹ / ₈ "		20 ¹ / ₂ "	19 ⁵ / ₈ "	31 ⁷ / ₈ "	N/A	N/A		\$ 2,665	 BL Black GY Dark Sea Grey OR Argovian Sun YE Zinc LB Light Sea Blue  *SM Smoke *PL Pearl

*Smoke and Pearl are only offered in the Ash Wood option.

SEATING



MODEL NUMBER	NAME	SEAT HEIGHT	ARM HEIGHT	WIDTH	DEPTH	HEIGHT	FABRIC YARDS	LEATHER SQ FT	WEIGHT/ VOLUME	LIST PRICE	DESCRIPTION
WO-18-M	18" Wood Stool Maple	18"			13"	18"	N/A	N/A	15 Lbs 4 Cu Ft	\$ 420	<p>The Wood Stool is constructed of Solid Hardwood available in Standard Natural Clear Finish.</p> <p>For the complete line of Maple Wood Finishes and options, refer to page 12 in this specification guide.</p> 
WO-24-M	24" Wood Stool Maple	24"			13"	24"	N/A	N/A	17 Lbs 5 Cu Ft	\$ 440	<p>For the complete line of Red Oak Wood Finishes and options, refer to page 12 in this specification guide.</p> 
WO-30-M	30" Wood Stool Maple	30"			13"	30"	N/A	N/A	20 Lbs 6 Cu Ft	\$ 460	