

ADandD Pop Link #CB5

Mounting for Keyence #CA-HX200C/M

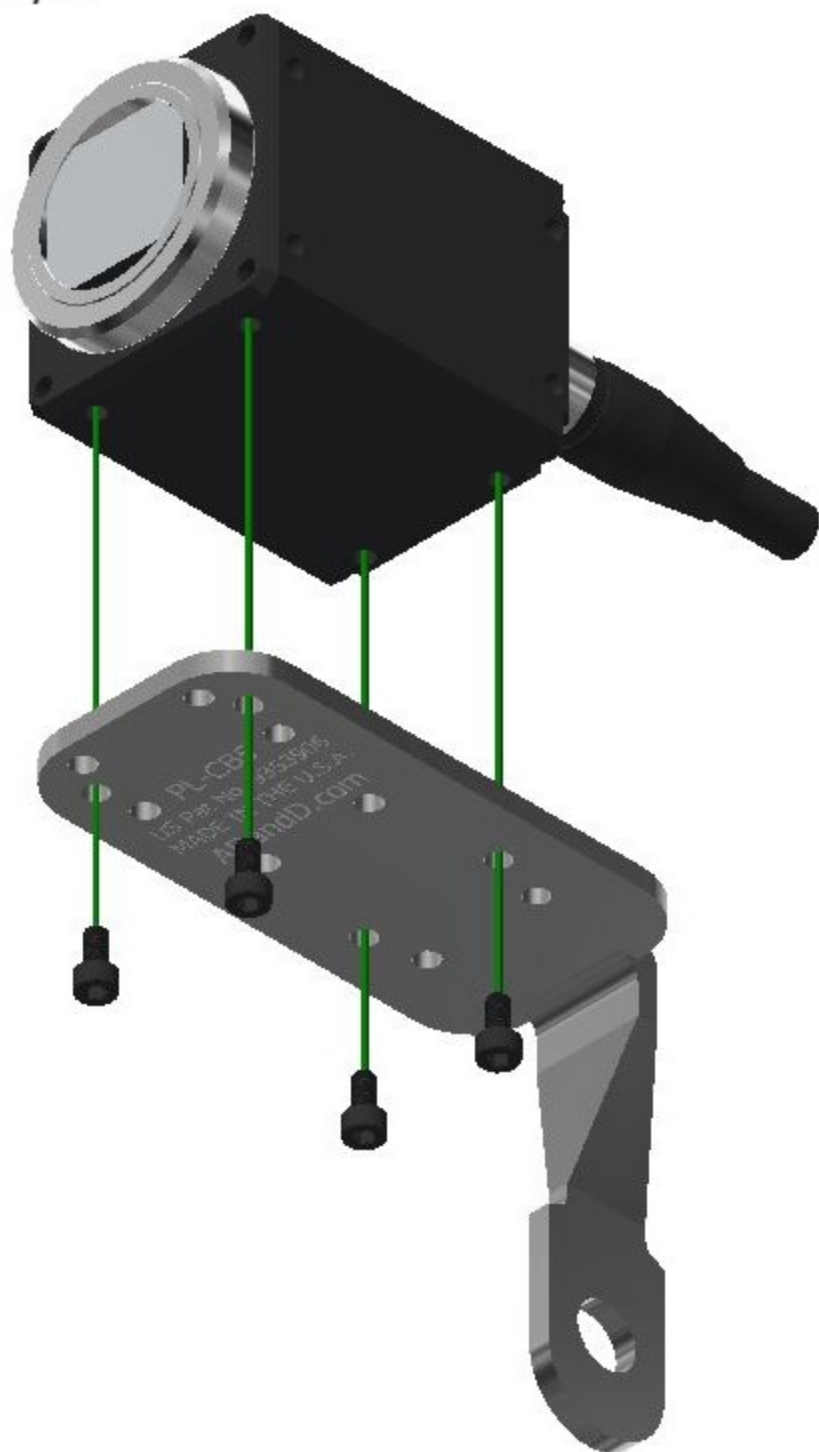

Included Hardware

(4) M3-.5 X 6mm Lg SHCS