

Turbo air
AIR CONDITIONER MANUFACTURER

4184 E. Conant St.
Long Beach, CA 90808
Tel. 888-900-1002
Fax. 310-900-1088
www.turboairinc.net

Project :

Model # :

Item # :

Qty :

Approval :

Condensing Unit

Model : TH040LR404A3



≡ FEATURES / BENEFITS ≡

- Blue anti-corrosion-fin increases the life span of the coil.
- Seamless inner groove copper tube increases the heat exchange rate by reducing the space between the fin and copper tube.
- Highest quality compressor in the world.

- Head pressure control stabilizes the freezing of liquid line, minimizes formation of flash gas to increase efficiency of the system, and prevents compressor damage by controlling high pressure.
- Experienced engineers have designed the system for maximum efficiency.
- Fan Blades : Specifically matched with motors and coil for maximum air movement and cooling.
- Control box is designed for easy installation.
- Low pressure control is adjustable.
- All the parts are compliant with industry standards and interchangeable with readily available parts.
- Wiring : Easily accessible. Compressor comes with a wiring harness that is manufactured with connections that will not come loose with vibration.
- Control box and service valves are located outside for easy service.
- Base : Heavy duty steel. Legs are 2-1/6" tall
- Cabinet : Prepainted with galvanized body. Protects against corrosion.
- All products carry UL, cUL, ISO 9001 approvals.

Condensing Unit

Model : TH040LR404A3

PERFORMANCE CHART

	40°F(SST)	30°F	25°F	20°F	0°F	-10°F	-20°F	-25°F
90°F(AMBIENT)	-	43970	39510	35150	20560	14980	11830	8690
95°F	-	41480	37270	33160	19400	14130	11160	8200
100°F	-	38980	35030	31180	18240	13290	10500	7700
110°F	-	36150	31240	27520	15210	11290	8920	6550

SPECIFICATION

	TH040LR404A3
Compressor	CS27K6E-PFV
Line Size	1/2" Liquid 1-1/8" Suction
Receiver 90%	18
Fan Data	1 Fan (3760CFM)
Dimensions	38.5(D) x 30.28(W) x 27.28(H)
Net Weight	281 Lbs
Power Supply	208-230/3ph/60hz
Compressor Amp	15.6
MCA	21.7
MOPD	30

Design and specifications subject to change without notice

- **WARRANTY :** 1 Year Compressor Warranty (4 Year extended warranty available)
1 Year Fan Motor and Parts Warranty

(unit : inch)

PLAN VIEW

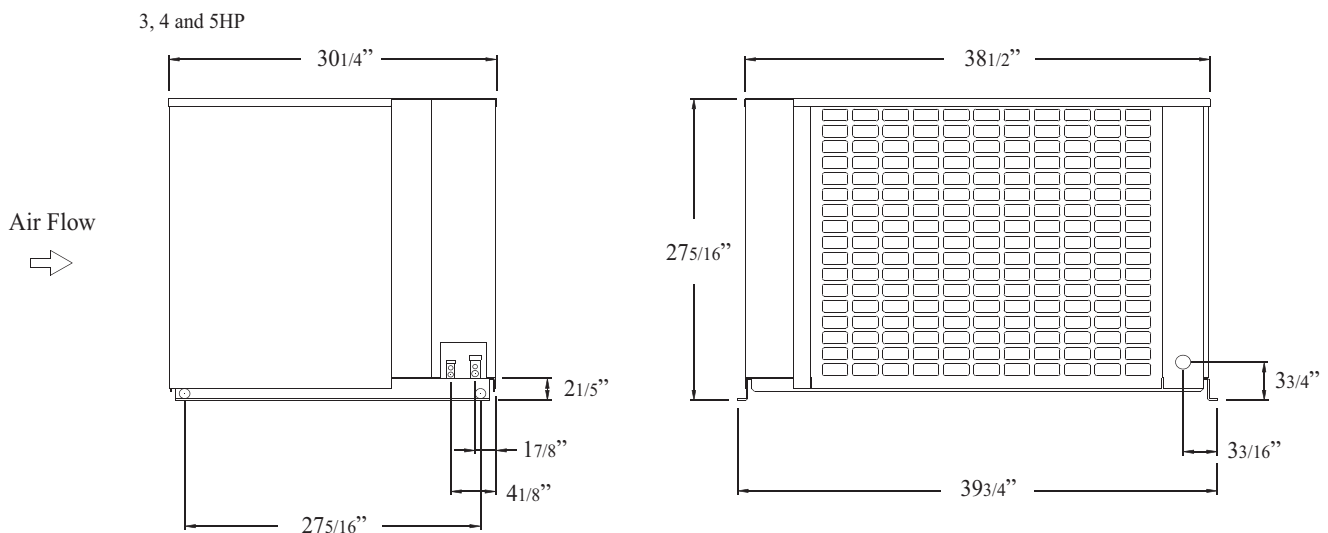

■ Toll Free : 888-900-1002

REFRIGERATOR MANUFACTURER
Turbo air

GERMAN KNIFE

RADIANCE

GREEN WORLD

AIR CONDITIONER MANUFACTURER
Turbo air