

BLDC Motor Fed by Ann Based MPPT Applied Solar PV Array for Water Pumping System Based On Luo Converter

K.Rajasri¹, Mr.P.Rajendar²

*P.G Student (Dept.Of.EEE), Assoc. Professor (Dept.Of.EEE)
Joginpally B.R.Engineering College*

Abstract - This project seeks to style a brushless DC motor, incorporating AI so as to make sure a smooth and reliable operation of the motor. The project also runs on solar power, making it a sustainable solution too. The principles of artificial neural networks (ANN) and symbolic logic are included as AI algorithms within the project. Maximum point tracking (MPPT), designed with ANN, is used to make sure that the solar power extracted by the solar array is maximum in the least times. The speed control of the motor is completed using symbolic logic, due to its accuracy in enforcing proper control by checking for the error margin to catch up on it.

Keywords: BLDC Motor, ANN, Luo Converter MPPT

I. INTRODUCTION

As the conventional energy sources are depleting day by day, the demand of renewable energy sources are raising with considered attention [1-3]. Solar power sources are promising renewable energy sources for developed and developing nations thanks to free, abundant and environmental friendliness nature. The standalone photovoltaic (PV) systems for water pumping applications are employed fo remote areas [4-5]. Due to grid absence in foreign places the standalone PV water pumping is installer for agricultural and household applications. Various electric motors are wont to drive the pumping system [6-7]. The DC motor based pumping system requires maintenance due to commutator and brush presence. Therefore, DC motors aren't frequently used for PV pumping applications. The only phase induction motors have also been used for driving low inertia torque load. Fuzzy logic may be a computational logic that works on the concepts of half-truths. Generally, the binary values of '0' and '1' are all that a machine can comprehend. Symbolic logic introduces the concept that those values also can be somewhere between the two; in other words, that it can possess infinitely many intermediate values. The opposite AI technology incorporated into the project is artificial neural network (ANN) [5]. To enable the machine to think artificially, the machine is trained. A known quantity or set of values are provided because the input. The machine processes this input initially, and suppose an extra value is provided because the question, the machine does manage to return as answer. However, the accuracy of this data is sort of circumspect. it's going to or might not be

the right answer. Then the machine has got to be trained so as to hone its accuracy and make sure that the output obtained is perfect

The static magnet brushless DC (BLDC) motor is used to drive a centrifugal pump coupled to its shaft. The BLDC motor is chosen due to its merits [7,9] useful for the event of suitable water pumping system. This electronically commutated BLDC motor [9] is supplied by a voltage source inverter (VSI) which is operated by fundamental switching leading to low switching losses. Suitability of the proposed SPV array fed water pumping system subjected to varied operating and environmental conditions is demonstrated by satisfactory simulated results using MATLAB/Simulink environment.

Due to complex control strategy, the induction motors aren't efficient for pumping applications. Therefore, during this research work Brushless DC (BLDC) motor has been considered because it has simple design control, low power range and need maintenance free operation compared to AC motors .

Distinct DC-DC converters were contend for optimizing PV module generated power with softstarting and controlling motor pump system [9-11]. The contemporary PV system has unsubstantial converse competency. Therefore, Maximum point Trackers (MPPT) is that the indispensable constituents required for optimal power tracking from PV modules. In contrast with different employed power converters, modern Luo converter has been considered for this research approach because it deliver better power/ density ratio with economical implementation [20]. Numerous MPPT methods are occupied viz. Perturb and Observe (P&O), Increment Conductance (INC), Fraction Short/Open circuit etc [12]. Under steady state operating conditions particular algorithms provide high outturn. But thes algorithms are found lacking under adverse weather with slow convergence velocity an unable to realize global point (GPP) for partial shading situations with high power oscillations around now . Recently different intelligent techniques viz. symbolic logic Control (FLC), Artificial Neural Network (ANN) has been employed for PV tracking [12]. However, due to complex fuzzy inference rules and individual sensor requirements, meta-heuristic algorithms are

employed nowadays. Genetic algorithm and artificial system are meta-heuristic algorithms used for non59 linear stochastic problem solution. However, the implementation of selection, mutation and crossover process is complex with reduced convergence computational period. Currently, Bio-inspired and swarm optimization are derived as MPPT techniques..

II. PROPOSED SYSTEM

The configuration of proposed ANN SPV array fed water pumping system employing Luo converter and BLDC motor drive is presented in Fig. 1. It consists of a SPV array feeding the water pumping system, a negative output elementary Luo converter as an intermediate DC-DC converter for MPPT, a 3 phase VSI supplying power to the motor-pump, a BLDC motor with inbuilt encoder to perform the electronic commutation by Hall signal sensing, a centrifugal pump

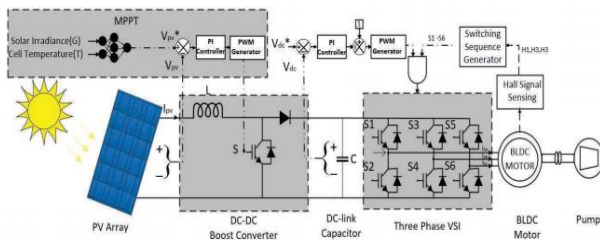

Fig 1: Topological implementation of ANN based Solar using DC-DC Converter and BLDC Motor

A. LUO CONVERTER

The design includes the solar array , which can work using the ANN-based MPPT algorithm to extract maximum power from the sun. The feedback to the motor is embedded with ANN I. this may enable speed control. The inverter is given PWM input. The PWM waveform is automatically optimized by the ANN algorithm. The PV cell receives sunlight and transducers it into electricity , making use of MPPT Algorithm. The MPPT Algorithm ensures that maximum sunlight are often absorbed by the panel. The DC/DC Boost Converter boosts the voltage of the incoming electric by using Artificial Neural Network. A non-detached bidirectional dc–dc converter is introduced. The proposed converter comprises of voltage gain and diminished exchanging pressure. High Gain DC-DC converter with their body diodes are utilized within the proposed converter. The voltage addition of the proposed converter is above past. The Solar is that the wellspring of the Converter. the load on converters gadgets and therefore the effectiveness of the proposed converter examined during this paper. At long last, the proposed converter model circuit is actualized to legitimize the legitimacy of the examination. during this proposition the exchanging stresses and exchanging misfortunes are to a point decreased contrasting

with Existing System the Luo converter as shown in below which can improve the voltage levels as per desired..

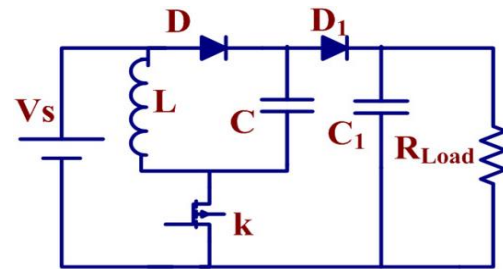

Fig 2: Luo Converter

$$\Delta I_{L1} = \frac{V_{in} * k * t}{L_1} = \frac{V_o - 2V_{in}(1-k) * T}{L_1} \rightarrow 1$$

$$V_{IN} = v_o * ((1-k)/(2-k)) \rightarrow 2$$

$$C2 = (k * v_o) / (f * R * dv) \rightarrow 3$$

B. MPPT based Artificial neural network

Fig: Steps involved in framing ANN

If a network has been framed for a specific application then subsequent step is training the synthetic neural network. to start this process initial weights are assumed randomly. Training of artificial neural network are often approached in two ways namely supervised and unsupervised. In supervised training, the output is understood so input is given as per the specified output. This process involves the comparison of resulting output and desired output in order that error value would be generated. The error value so obtained is propagating back and weights are adjusted and above said process continue until desired output is obtained. The set of knowledge which enable this whole process is named “training set”. On other unsupervised training are going to be preceded with random input as desired output isn’t predictable. So this process is additionally called as self-organization [12]. In Figure is layout of Typical Neural Network.

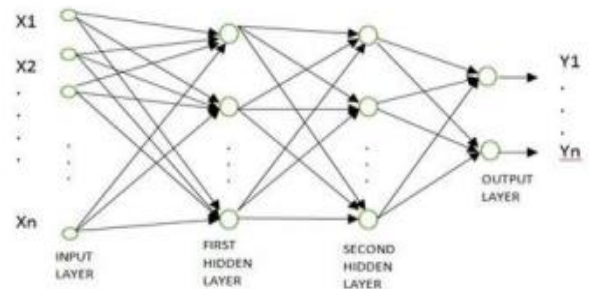

Fig 3: Typical Layout of Artificial Neural Network

Step1: Input to the synthetic Neural Network

Change in voltage or error voltage from the motor is given as input to the synthetic neural network.

Step2: Processing of Input

From multiple inputs, one input is chosen and assumed minimum value is subtracted and multiplied by the gain which is that the ratio of output range to input range and in some situation, additional bias is given to the input. This forms the primary layer of a man-made neural network.

Step 3: Output Processing

The output of the layer 1 is fed back as an input to the present layer 2 and therefore the output would be a two-dimensional Element. This element is formed dot products with the weights assumed then given to the transfer function and therefore the process of step 2 is completed during a reverse manner

III. ELECTRONIC COMMUTATION OF BLDC MOTOR

Motor power service make TETRA 142TR16.5 BLDC motor is chosen for the proposed SPV array fed water pumping system. Electronic commutation of BLDC motor is accomplished by operating three phase VSI in 120° conduction mode using six switching pulses generated consistent with the rotor position . The inbuilt encoder senses the rotor position on each 60° span, generates a specific set of three Hall Effect signals and accordingly the switching sequence for VSI is generated. Fundamental switching of VSI is attained by the electronic commutation of BLDC motor.

IV. SIMULINK DESIGN AND RESULTS

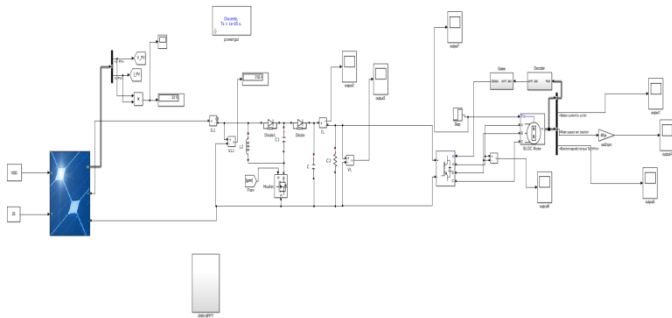

Fig 4 : Simulink ANN based solar Mppt of water pumping system using luo converter

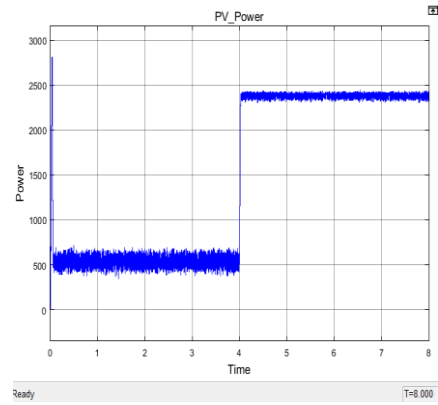

Fig 5 : Solar PV Power

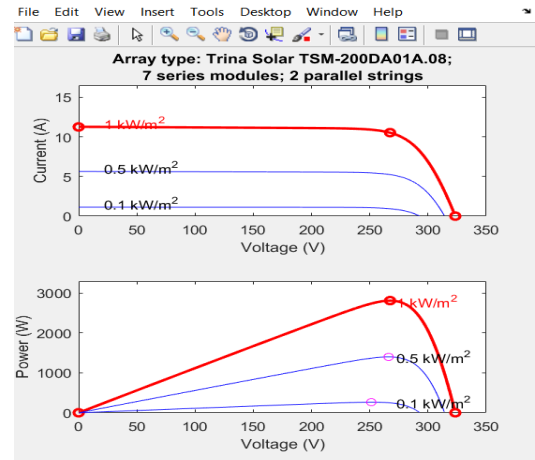

Fig : Solar PV array Characteristics

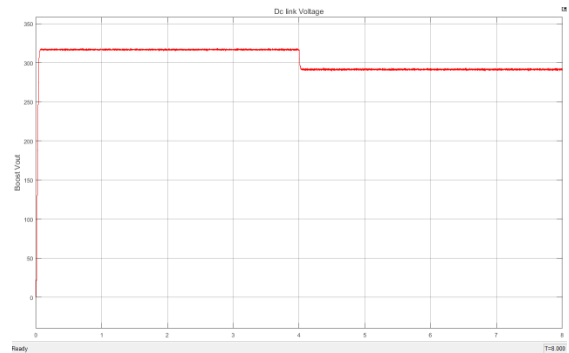

Fig 6 : Luo Converter output voltage (Dc link Voltage)

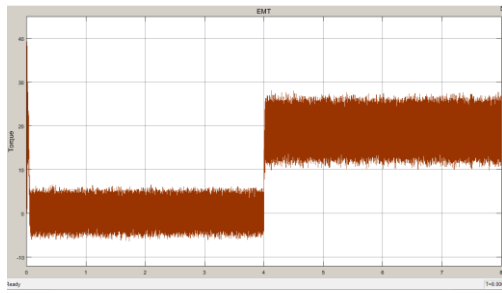

Fig 7: Electro Magnetic Torque

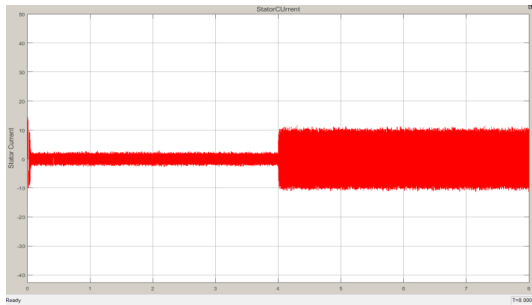

Fig 8: Stator Current

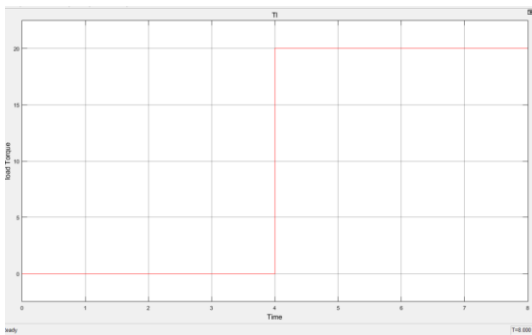

Fig 9:Load Torque

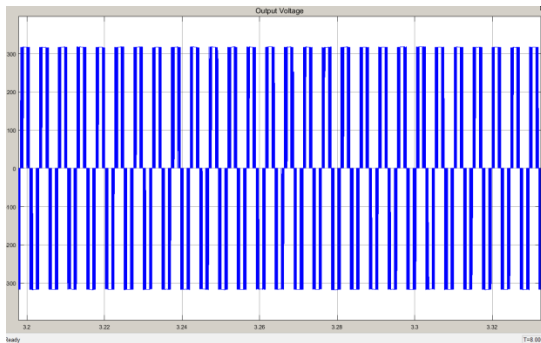

Fig 10:Inverter Output Voltage (Vout)

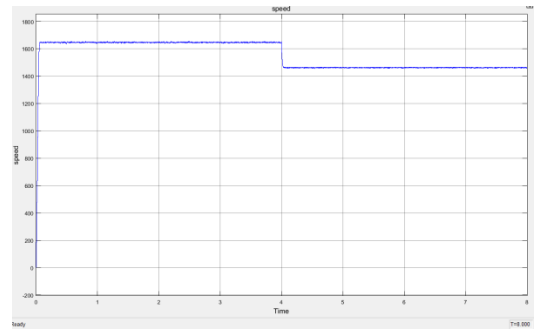

Fig 11:Speed of the Motor

V. CONCLUSION

A non-electrical information-based ANN MPPT is presented for sunlight-based force water siphoning framework utilizing BLDC engine. The goal was to present a stage size Artificial MPPT procedure and ideal demonstrating of the framework. The results have shown that utilization of ANN-based MPPT is one of possible alternative plan step size free activity of PV cluster driving water siphoning framework utilizing BLDC engine. It has been seen that the framework has astounding transient and consistent state execution over a wide scope of irradiance. Results have demonstrated the ideal presentation of the framework with the most noteworthy proficiency of 81.55% and keep up a constant progression of water even at the least irradiance with a productivity of 69.03%. Delicate turning over of BLDC engine is likewise accomplished utilizing a proposed strategy which is attractive for smooth activity of the engine siphon set.

VI. REFERENCES

- [1]. Rajan Kumar and Bhim Singh, "BLDC motor driven water pump fed by solar photovoltaic array using boost converter," in Annual IEEE India Conf. (INDICON), New Delhi, 2015.
- [2]. Bhim Singh and Ranjan Kumar, "Solar PV Array Fed Brushless DC Motor Driven water pump," in IEEE 6th International Conference on Power Systems (ICPS), New Delhi, 2016.
- [3]. B. Subudhi and R. Pradhan., "A comparative study on maximum PowerPoint tracking techniques for photovoltaic power systems," IEEE Trans. Sustain. Energy., vol. 4, no. 1, pp. 89-98, jan 2013.
- [4]. Lina M. Elobaid, Ahmed K. Abdelsalam and Ezeldin E. Zakzouk, "Artificial neural network-based photovoltaic maximum power point tracking techniques: a survey," IET Renewable Power Generation, vol. 9, no. 8, pp. 1043-63, 2015.
- [5]. NajetRebei, RabiaaGammoudi , Ali hmidet and Othman Hasnaoui, "Experimental Implementation Techniques of P&O MPPT Algorithm for PV Pumping System," in IEEE 11th International Multi-Conference on Systems, Signals & Devices, Barcelona, Spain, 2014.

- [6]. S.G. Malla, C.N. Bhende and S. Mishra, "Photovoltaic based water pumping system," in International Conference on Energy, Automation and Signal, Bhubaneswar, Odisha, India, 2011.
- [7]. B. Singh and R. Kumar, "Solar PV array fed water pump driven by BLDC motor using Landsman converter," IET Renew. Power. Gener., vol. 10, no. 4, pp. 474-484, 2016.
- [8]. Rajan Kumar and Bhim Singh, "Solar Photovoltaic Array Fed Luo Converter Based BLDC Motor Driven Water Pumping System," in 9th International Conference on Industrial and Information Systems, Gwalior, India, 2014.
- [9]. Songbai Zhang, Zheng Xu, Youchun Li, and Yixin Ni, "Optimization of MPPT Step Size in Stand-alone Solar Pumping Systems," in IEEE Power Engineering Society General Meeting, Montreal, Que., Canada, 2006.
- [10]. Rajan Kumar, Bhim Singh, Ambrish Chandra and Kamal Al-Haddad, "Solar PV array fed water pumping using BLDC motor drive with boost-buck converter," in IEEE Energy Conversion Congress and Exposition (ECCE), Montreal, QC, Canada, 2015.
- [11]. N. Mohan, T. M. Undeland and W. P. Robbins, Power Electronics Converters, Applications and Design 3rd ed., New Delhi: John Wiley & Sons Inc., 2010.
- [12]. Utkarsh Sharma, Shailendra Kumar and Bhim Singh, "Solar array fed water pumping system using induction motor drive," in IEEE 1st International Conference