



ROYAL CANADIAN ARMY CADETS

RED STAR

INSTRUCTIONAL GUIDE



SECTION 1

EO M221.01 – PERFORM THE DUTIES OF A SECTION MEMBER IN THE FIELD

Total Time: 30 min

PREPARATION

PRE-LESSON INSTRUCTIONS

Resources needed for the delivery of this lesson are listed in the lesson specification located in A-CR-CCP-702/PG-001, Chapter 4. Specific uses for said resources are identified throughout the Instructional Guide within the TP for which they are required.

Review the lesson content and become familiar with the material prior to delivering the lesson.

PRE-LESSON ASSIGNMENT

N/A.

APPROACH

An interactive lecture was chosen for this lesson to give direction on procedures to take as a section member on a weekend bivouac FTX.

INTRODUCTION

REVIEW

N/A.

OBJECTIVES

By the end of this lesson the cadet shall be expected to perform the duties of a section member in the field.

IMPORTANCE

It is important for cadets to know their role as a section member in a field environment. On a weekend bivouac FTX, section members will be given small leadership roles within their peer groups to assist with common duties such as setting up the bivouac site, maintaining safety and assisting other cadets.

Teaching Point 1**Discuss Environmental Considerations When Setting up a Bivouac Site**

Time: 5 min

Method: Interactive Lecture



Discuss the listed risks to consider in the field when setting up a bivouac site.

ENVIRONMENTAL CONSIDERATIONS

Fallen Trees/branches. Fallen trees/branches will minimize building effort when setting up a bivouac site. These trees and branches can be used for many components of the site. Fallen trees can mark boundaries, hold signs, and help weatherproof a site. However, care must be taken as cadets can easily trip over fallen trees/branches. A sharp branch can also cause damage to equipment such as tents and ground sheets. Tent sites should not be set up where fallen trees are present.

Dead Trees. Areas with dead trees should be avoided. These trees can easily fall during high winds and storms. Look closely for any branches that may fall. Dead trees lack strength and therefore should not be relied on in bivouac building efforts.

Poisonous Plants. Always look for poisonous plants prior to setting up a bivouac site. Common poisonous plants such as poison ivy, poison sumac and poison oak were identified in EO M121.05 (Recognize Environmental Hazards). Contact with poisonous plants causes severe itching of the skin, red inflammation and blistering. Contact should be avoided.

INSECT RISKS

Beehives and Hornet's Nests. In the field, beehives and hornet nests can be found in trees, shrubs and even in the ground. When nests are disturbed, bees and hornets will get defensive and sting. Always look for beehives and hornet's nests before setting up a site. A good sign that a hive or nest is nearby is when a large number of bees or hornets are flying around.



Figure 1 Hornet's Nest

Tawrell, P., Camping and Wilderness Survival, Leonard Paul Tawrell (p. 898)

Ant Hills. Once disturbed, ant hills can become a big nuisance. Check the ground for ant hills prior to setting up a bivouac site.



Figure 2 Ant Hill

Tawrell, P., Camping and Wilderness Survival, Leonard Paul Tawrell (p. 898)

ANIMAL RISKS

Small Trails. It is fairly common to see animals on small trails when in the field. When setting up a bivouac site, ensure that the site does not fall at the end of a trail. This could lead to an unexpected visit from animals. Small trails may lead to dens and watering holes.

Dens. Prior to setting up a bivouac site, look for any areas that may be near animal dens. A group of cadets could easily disturb resting animals. A den may be found on a trail or at the end of a trail in the field.

Watering Holes. Just like humans, animals need water. Bivouac sites should be near water; however, not too close. Sites should be set up approximately 60 m from water. When in the field, water sources can become contaminated very easily. Soap and feces are two of the most common sources. Distancing the bivouac site is also an important step to ensure that contaminants do not pollute the water.

CONFIRMATION OF TEACHING POINT 1

QUESTIONS

- Q1. What are some common environmental risks to consider when selecting a bivouac site?
- Q2. In the field, where are beehives and hornet nests usually found?
- Q3. What are some indications that animals may be close by?

ANTICIPATED ANSWERS

- A1. Fallen trees/branches, dead trees, and poisonous plants.
- A2. Beehives and hornet's nests can be found in trees, shrubs and even in the ground.
- A3. Small trails, dens and watering holes.

Teaching Point 2**Discuss Maintaining a Safe Site**

Time: 8 min

Method: Interactive Lecture



A well organized and clean bivouac site is especially important with respect to safety, particularly if the weather gets bad or if there is an emergency.

Discuss some of the simple steps that section members can follow to help ensure a safe site is maintained when in the field.

DISTANCE BETWEEN SHELTERS

There may be many cadets in the field at any given time. It is important that shelters are spread out through both the male and female lines. Shelters should be spaced at least two metres apart. Where guy lines exist, there must be adequate space between shelters so that cadets can easily walk without stepping over lines.

By spacing shelters a small distance, cadets are provided with privacy, while still being able to easily communicate.

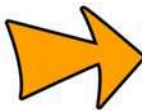

When night falls, shelters may be hard to see. When shelters are close together there is a greater chance of having an accident, such as tripping over guy lines.

MARKING THE BIVOUAC LAYOUT

Red Star cadets may be expected to assist in the set-up of a bivouac site.

Bivouac layout was discussed in EO M121.09 (Follow Camp Routine). Clearly marking these components is a great way to make sure everyone knows where they are.

Components of a bivouac site are:

- headquarters;
- first aid point;
- supply;
- toilets;
- wash station;
- mess/eating area;
- fire pit;
- fire point;
- in/out route for the safety vehicle;

- form-up area;
- food hang;
- vehicle parking area;
- drinking water point;
- petroleum, oils, and lubricants (POL) point;
- female/male quarters; and
- garbage point.

The following figure is a sample bivouac site.

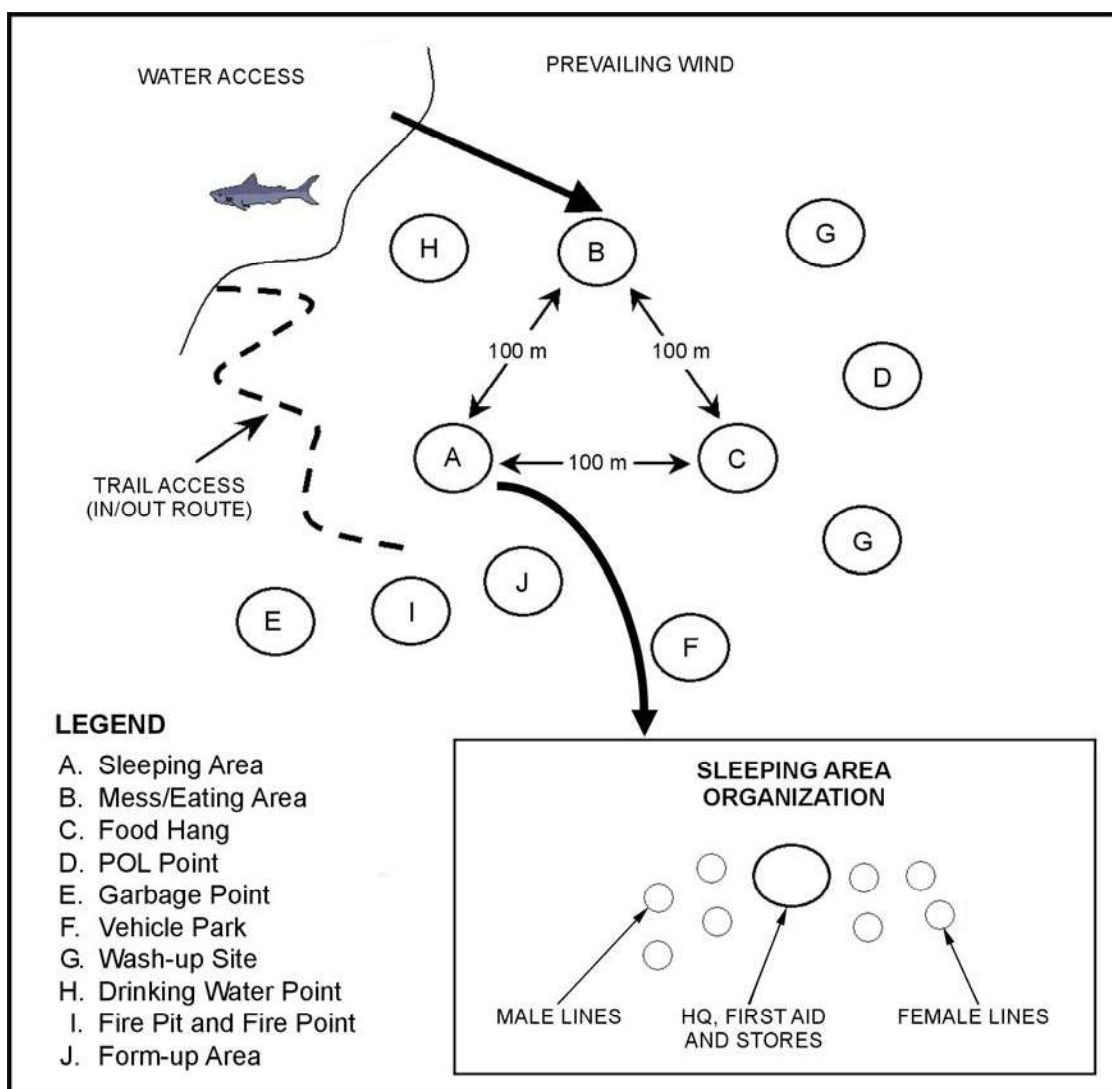
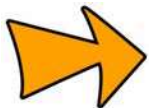

Figure 3 Sample Bivouac Site

D Cdt's 3, 2007, Ottawa ON: Department of National Defence



Areas that will be used after dark should be lit using glow sticks, lanterns or flashlights.

FIRE PROCEDURES



Upon arrival to a bivouac site, fire procedures will be explained in the safety briefing. It is extremely important that all cadets know and understand the cadet corps' fire procedures.

The fire pit, cooking area, POL point and supply are the areas with the highest risk of fire. All cadets must know where they are located along with actions to take if a fire occurs.

Fire procedures will differ depending on the location of the weekend bivouac FTX. For example, if the bivouac area is in a recognized park, the cadet corps must follow the park's fire procedures. If the bivouac area is on private property, the cadet corps will be expected to follow their established fire procedures.

ASSIST OTHER CADETS



Section members are naturally given leadership opportunities. Assisting other cadets is a key step in the development of leadership in the field.

Though Red Star cadets will not be given an abundance of opportunities to supervise others, there are some basic aspects of field training in which they can assist.

Supervision ensures **safety**. When tasks are being completed, an effective team will work together and assist each other.

Though Red Star cadets are not expected to supervise, as a section member in the field, they can assist their peers and the Green Star cadets in following camp routine.

Section members can assist by:

- setting up the components of the bivouac site;
- ensuring that all cadets know the bivouac layout;
- making sure that all drinking water is coming from drinking water points;
- storing and disposing of all garbage properly; and
- practicing safe behaviour individually and as a group.

CONFIRMATION OF TEACHING POINT 2

QUESTIONS

- Q1. What points should be considered in order to maintain a safe site?
- Q2. What components of a bivouac site have the highest risk of fire?
- Q3. What is the purpose of supervision?

ANTICIPATED ANSWERS

- A1. Shelters should have approximately two metres between them; bivouac components should be clearly marked; everyone should know the applicable fire procedures; and all cadets should be supervised and assisted whenever possible.
- A2. The fire pit, cooking area, POL point and supply area.
- A3. The purpose of supervision is safety.

Teaching Point 3

Discuss the Importance of Individual and Group Hygiene

Time: 7 min

Method: Interactive Lecture



By elaborating on the importance of these points, the cadets will begin to understand their role as a section member with the cadet corps. Individual and group hygiene are very important in the field. The cadets can positively influence younger cadets by setting a good example.

CHANGE CLOTHES REGULARLY

It is important to keep all clothing, especially underclothing and socks, as clean and dry as possible. Clothing, as well as the body, must stay clean and dry. Keeping clothes clean will lessen the chances of exposure to rashes and infections. Change clothes, especially socks and undergarments, regularly.

PROPERLY DISPOSE OF WASTE WATER

There will always be a quantity of waste water from personal bathing and cooking in the field.

Follow these steps to properly dispose of waste water.

1. Collect all large particles with a food strainer or cloth and place in the garbage.
2. Place the remaining waste water in a container.
3. Dig a small hole at least 60 m away from any water source.
4. Pour the waste water in the hole.
5. Fill in the hole with natural materials.

WASH REGULARLY

In order to minimize the spread of diseases, hand washing should be enforced when in the field. There are two common approaches to hand washing – hand sanitizers and soap and water.

It is important to always keep the hands clean. Having hand sanitizer is very convenient. When hand sanitizer is not available, use soap and water. Remember to dispose of all waste water.

Washing the body is very important and should be done daily. Pay special attention to areas of the body that are susceptible to rash and fungus infection (the scalp, the crotch, and between the toes).

USE DESIGNATED ABLUTION SITES

Outhouses and chemical toilets should be utilized whenever possible.

Disposing of waste must be done using good judgement and common sense. In an emergency:

- Always urinate at least 60 m away from trails and water sources. Urine will leave a smell and will attract animals once it evaporates.
- Feces can create a significant impact on the environment. Feces can contaminate water sources, spread disease, and affect others both visually and by smell.



Human waste should be deposited in cat holes dug 16 to 20 cm deep and at least 60 m away from water sources, camps and trails. Mix feces with some soil, using a small stick. Cover and disguise the cat hole when finished. Toilet paper should be packed out.

TREAT INJURIES AS SOON AS THEY OCCUR



Serious injuries should be immediately treated by a qualified first aider.

It is relatively easy for minor wounds to occur in a field setting. Injuries have the potential to become infected and it is important to know what to do as soon as these injuries occur.

On the spot treatment for injuries depends on the injury itself, knowledge and training of the people involved, medical materials present, the environment, correct diagnosis of the problem, and the ability to work under strained conditions.

Minor injuries are discussed further in EO M221.04 (Perform Basic First Aid).

CONFIRMATION OF TEACHING POINT 3

QUESTIONS

- Q1. Why is it important to keep clothes clean?
- Q2. What are the steps to properly dispose of waste water?
- Q3. How can one minimize the spread of diseases?

ANTICIPATED ANSWERS

- A1. Keeping clothes clean will lessen the chances of rashes and infections.
- A2. Follow these steps to properly dispose of waste water.
1. Collect all large particles with a food strainer or cloth and place in the garbage.
 2. Place the remaining waste water in a container.
 3. Dig a small hole at least 60 m away from any water source.
 4. Pour the waste water in the hole.
 5. Fill in the hole with natural materials.
- A3. Wash hands regularly.

Teaching Point 4**Discuss Receiving, Caring for, and Returning Equipment**

Time: 5 min

Method: Interactive Lecture



Cadets must know the importance of taking care of equipment. When equipment is not properly taken care of, performance is compromised and life of the equipment becomes shorter.

Stress the impact and importance of the following points.

RECEIVING, CARING FOR, AND RETURNING EQUIPMENT

Section equipment is normally stored either within the section or by the quartermaster when in the field. Section equipment, also referred to as stores, includes stoves, lanterns, pot sets, tents, water containers, etc.

When drawing stores, the following points shall be kept in mind:

- Equipment should be signed out only through the designated quartermaster (the designated quartermaster may be a section commander or supply officer).
- Equipment shall always be kept clean when not in use.
- Equipment shall be secured and stored when not in use. The performance of equipment is a vital part of a successful weekend bivouac FTX. Improper securing and storing contributes to loss of durability and a shorter life of the equipment.
- Any equipment loss/damage shall be reported to the designated quartermaster as soon as it occurs or is noticed.
- Equipment shall be returned to the designated quartermaster.

CONFIRMATION OF TEACHING POINT 4**QUESTIONS**

- Q1. Why should equipment be secured when not in use?
- Q2. Who signs in/out equipment?
- Q3. When should equipment loss/damage be reported?

ANTICIPATED ANSWERS

- A1. The performance of equipment is a vital part of a successful weekend bivouac FTX. Improper securing and storing contributes to loss of durability and a shorter life of the equipment.
- A2. Equipment is signed in/out through the designated quartermaster.
- A3. Equipment loss/damage should be reported as soon as it occurs or is noticed.

END OF LESSON CONFIRMATION

QUESTIONS

- Q1. What types of risks should be considered when setting up a bivouac site?
- Q2. How can section members supervise and assist other cadets in following camp routine?
- Q3. How can one minimize the spread of diseases?

ANTICIPATED ANSWERS

- A1. Environmental, insect and animal.
- A2. Section members can supervise and assist by:
- ensuring that all cadets know the bivouac layout;
 - making sure that all drinking water is coming from drinking water points;
 - storing and disposing of all garbage; and
 - practicing safe behaviour individually and as a group.
- A3. Wash hands regularly.

CONCLUSION

HOMEWORK/READING/PRACTICE

N/A.

METHOD OF EVALUATION

N/A.

CLOSING STATEMENT

As section members, the cadets are expected to assist with common duties. It is important to know what is expected of a section member so that every section member knows their place in the cadet corps while on a weekend bivouac FTX.

INSTRUCTOR NOTES/REMARKS

N/A.

REFERENCES

A0-036 A-CR-CCP-121/PT-001 D Cdts 3 (2000). *Royal Canadian Army Cadet Reference Book*. Ottawa, ON: Department of National Defence.

C0-111 (ISBN 978-0-9740820-2-3) Tawrell, P. (2006). *Camping and Wilderness Survival: The Ultimate Outdoors Book* (2nd ed.). Lebanon, NH: Leonard Paul Tawrell.

C2-016 (ISBN 0-517-88783-5) Curtis, R. (1998). *The Backpackers Field Manual: A Comprehensive Guide to Mastering Backcountry Skills*. New York, NY: Three Rivers Press.



ROYAL CANADIAN ARMY CADETS

RED STAR

INSTRUCTIONAL GUIDE



SECTION 2

EO M221.02 – IDENTIFY SECTION EQUIPMENT

Total Time:

60 min

PREPARATION

PRE-LESSON INSTRUCTIONS

Resources needed for the delivery of this lesson are listed in the lesson specification located in A-CR-CCP-702/PG-001, Chapter 4. Specific uses for said resources are identified throughout the Instructional Guide within the TP for which they are required.

Review the lesson content and become familiar with the material prior to delivering the lesson.

All items listed in each TP should be available when instructing this lesson. It is understood that some items will be unavailable due to local resource limitations.

Prepare a first aid kit for demonstration. Ensure it is fully equipped IAW A-CR-CCP-951/PT-002, *Royal Canadian Army Cadets Adventure Training Standards*.

PRE-LESSON ASSIGNMENT

N/A.

APPROACH

An interactive lecture was chosen for this lesson to identify section equipment, introduce a new subject and to present the different types of equipment available when participating in a weekend bivouac FTX.

INTRODUCTION

REVIEW

N/A.

OBJECTIVES

By the end of this lesson the cadet shall be expected to identify section equipment.

IMPORTANCE

It is important for cadets to know what equipment is available when going on a weekend bivouac FTX. Having knowledge of the equipment available and its uses allows cadets to prepare for a weekend bivouac FTX. The items selected can be tailored to meet the objective of the weekend bivouac FTX.

Teaching Point 1**Identify Types of Stoves and Lanterns**

Time: 15 min

Method: Interactive Lecture

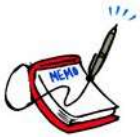

This TP is intended to give an overview of the different equipment available when selecting equipment for camping and trekking/hiking.

Provide cadets with an example of each item. Allow cadets to see the equipment up close and handle it carefully.

TYPES OF FUEL BURNING SYSTEMS

The options of available camping and trekking/hiking equipment are vast and vary depending on the manufacturer. There are three basic types of fuel burning systems, which are based on what they burn – liquid fuel, compressed gas and solid fuel.

Liquid Fuel. Liquid fuel stoves burn white gas—kerosene, alcohol or naphtha. They are the best choice for extremely cold conditions and high altitudes. The fuel is stored in a separate tank. In most cases, this tank uses a pump to help pressurize it. The tank should be filled only to the 3/4 point, leaving some air in the tank. Kerosene, alcohol or naphtha are cleaner fuels that leave little residue when burned.

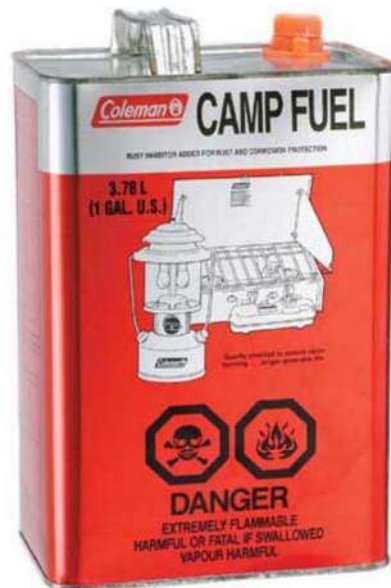

Figure 1 Coleman Naphtha Fuel

Canadian Tire, Copyright 1997-2007 by Canadian Tire Corporation Limited.

Retrieved 24 April 2007, from =1408474396672290&PRODUCT%3C

%3Eprd_id=845524443280741&bmUID=1177356005717&assortment=primary&fromSearch=true

Naphtha Fuel HYPERLINK "http://www.canadiantire.ca/browse/product_dei"

Compressed Gas. Compressed gas stoves burn butane, isobutene or propane. They are easy to turn on and off and require little maintenance. The heat produced is controlled easily and both the fuel and fuel canister are lighter than liquid fuel stoves. Compressed gas stoves do not work very well in cold temperatures. It is difficult to determine the amount of fuel remaining after use because the fuel is stored in a solid vessel.



Figure 2 Compressed Gas

Canadian Tire, Copyright 1997-2007 by Canadian Tire Corporation Limited. Retrieved 24 April 2007, from http://www.canadiantire.ca/browse/product_detail.jsp?FOLDER%3C%3Efolder_id=1408474396672290&bmUID=1178201728250&PRODUCT%3C%3Eprd_id=845524443280741&assortment=primary&fromSearch=true



Figure 3 Compressed Gas

Mountain Equipment Coop, Copyright 2007 by Mountain Equipment Coop. Retrieved 24 April 2007, from http://www.mec.ca/Products/product_detail.jsp?PRODUCT%3C%3Eprd_id=845524441775741&FOLDER%3C%3Efolder_id=2534374302696497&BMUID=1178201628346

Solid Fuel. Solid fuel burns flammable pellets, cubes or wood. These systems are simple and easy to use. Regulating temperature is hard at times as they commonly only burn what is added to them. There is little to no maintenance required on these stoves.

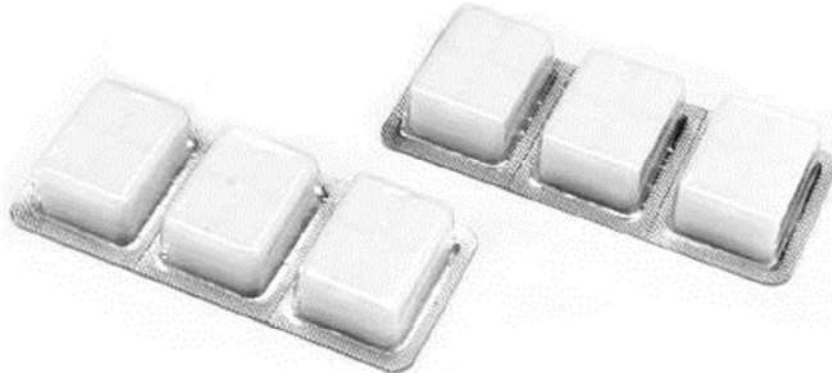

Figure 4 Esbit Stove Fuel

*Backpackgear Online.com, Copyright 2007 by Maguire and Johnson Web Services.
Retrieved 28 March 2007, from [http://www.mjsecure.com/backpackgearonline/
product_info.php?cPath=27&products_id=330&osCsid=dc36e4f96e5105dacd461c37f0788f17](http://www.mjsecure.com/backpackgearonline/product_info.php?cPath=27&products_id=330&osCsid=dc36e4f96e5105dacd461c37f0788f17)*

CAMPING STOVES

Single-burner. Single-burner stoves are portable stoves that allow one to cook anywhere without having to make a fire. These stoves store easily and can be carried along a trek with ease. Fuel is carried in a separate container to ensure there is no spillage of fuel in the pack.



Figure 5 Single-burner Coleman Stove

*Backpackgear Online.com, Copyright 2007 by Maguire and Johnson Web Services. Retrieved 28 March 2007,
from http://www.coleman.com/coleman/colemancom/detail.asp?product_id=533B705&categoryid=2020*



Figure 6 Single-burner MSR Stove

Mountain Equipment Coop, Copyright 2007 by Mountain Equipment Coop. Retrieved 24 April 2007, from http://www.mec.ca/Products/product_detail.jsp?PRODUCT%3C%3Eprd_id=845524441772275&FOLDER%3C%3Efolder_id=2534374302696497&bmUID=1175178016804

Two-burner. The two-burner stove is an efficient item that is particularly suited for the field. When travelling in groups, this stove can be carried in a supply vehicle or on a toboggan. This stove is equipped with two burners which can help speed up the cooking process.



Figure 7 Coleman Powerhouse Naphtha Two-burner Stove

Coleman Outdoor Company, Copyright 2006 by The Coleman Company, Inc. Retrieved 28 March 2007, from http://www.coleman.com/coleman/colemancom/detail.asp?product_id=425G499&categoryid=70023



Figure 8 Coleman Two-burner Propane Stove

Coleman Outdoor Company, Copyright 2006 by The Coleman Company, Inc. Retrieved 28 March 2007, from http://www.coleman.com/coleman/colemancom/detail.asp?product_id=5466A700&categoryid=70022

LANTERNS

Lanterns are designed to produce light. Each type of lantern will produce different amounts of light and last for many hours.

Single-mantle. Single-mantle lanterns which burn naphtha are clean. They can produce a dim, soft light and can burn bright like a beacon when required. The flame is adjustable and fuel consumption can range. This depends on the model type and light setting.

Dual-mantle. Dual-mantle lanterns burn naphtha. They produce more light than a single-mantle lantern. A soft light/glow can be produced and it is capable of burning bright like a beacon when required. The flame is adjustable and fuel consumption can range depending on the model type and light setting.

Battery-powered. Battery-powered lanterns provide a light that radiates from a centre bulb. The lantern has reflective surfaces above and below the light – reflecting light upward and outward. Bulbs and batteries are easily replaceable. These lanterns will run approximately 4 hours or more depending on model type.



Figure 9 Single-mantle Naphtha Lantern

Coleman Outdoor Company, Copyright 2006 by The Coleman Company, Inc. Retrieved 28 March 2007, from http://www.coleman.com/coleman/colemancom/detail.asp?product_id=288B700&categoryid=1015



Figure 10 Dual-mantle Naphtha Lantern

Coleman Outdoor Company, Copyright 2006 by The Coleman Company, Inc. Retrieved 28 March 2007, from http://www.coleman.com/coleman/colemancom/detail.asp?product_id=288B700&categoryid=1015



Figure 11 Mini Pack-away Battery Lantern

Coleman Outdoor Company, Copyright 2006 by The Coleman Company, Inc. Retrieved 28 March 2007, from http://www.coleman.com/coleman/colemancom/detail.asp?product_id=5315J725&categoryid=1045

CONFIRMATION OF TEACHING POINT 1

QUESTIONS

- Q1. What are the three types of fuel burning systems?
- Q2. What types of lanterns are there?
- Q3. What type(s) of fuel is used by a white gas system?

ANTICIPATED ANSWERS

- A1. Liquid, compressed and solid.
- A2. Single-mantle, dual-mantle, and battery-powered.
- A3. Kerosene, alcohol or naphtha.

Teaching Point 2

Identify Types of Field Tools

Time: 10 min

Method: Interactive Lecture



This TP is intended to give an overview of the different equipment available when selecting equipment for camping and trekking/hiking.

Provide cadets with an example of each item. Allow cadets to see the equipment up close and handle it carefully.

SINGLE-BIT AXE

The single-bit axe has a sharp, fully polished, tempered steel head. The axe handle inserts into the axe head also known as the single-bit. The axe requires very little maintenance—only sharpening when the blade is dull and occasionally adding a few drops of oil to prevent rusting. This tool may be used for cutting or splitting wood.



Figure 12 Single-bit Axe

D Cdts 3, 2007, Ottawa, ON: Department of National Defence

BOW SAW

The bow saw is a metal-framed saw in the shape of a bow with a coarse wide blade. It is mostly used for cutting trees and branches. The blade is toothed and suspended between two long narrow handles called “cheeks”.



Figure 13 Bow Saw

D Cdts 3, 2007, Ottawa, ON: Department of National Defence

CONFIRMATION OF TEACHING POINT 2

QUESTIONS

- Q1. What is a single-bit axe used for?
- Q2. What is the head of an axe made of?
- Q3. What is a bow saw and why is it used?

ANTICIPATED ANSWERS

- A1. A single-bit axe is a tool that is used for cutting or splitting wood.
- A2. The axe head is made of tempered steel.
- A3. The bow saw is a metal-framed saw in the shape of a bow with a coarse wide blade. It is mostly used for cutting trees and branches.

Teaching Point 3

Identify Liquid Storage Vessels

Time: 10 min

Method: Interactive Lecture



This TP is intended to give an overview of the different equipment available when selecting equipment for camping and trekking/hiking.

Provide cadets with an example of each item. Allow cadets to see the equipment up close and handle it carefully.

STOVE AND LANTERN FUEL VESSELS



Figure 14 Fuel Container

Mountain Equipment Coop, Copyright 2007 by Mountain Equipment Coop. Retrieved 28 March 2007, from http://www.mec.ca/Products/product_detail.jsp?PRODUC%3C%3Eprd_id=845524441772275&FOLDER%3C%3Efolder_id=2534374302696497&bmUID=1175178016804



Figure 15 Fuel Container

Mountain Equipment Coop, Copyright 2007 by Mountain Equipment Coop. Retrieved 28 March 2007, from http://www.mec.ca/Products/product_detail.jsp?FOLDER%3C%3Efolder_id=2534374302696497&PRODUCT%3C%3Eprd_id=845524442413091&bmUID=1175621430159



Figure 16 Fuel Container

Mountain Equipment Coop, Copyright 2007 by Mountain Equipment Coop. Retrieved 28 March 2007, from http://www.mec.ca/Products/product_detail.jsp;jsessionid=GSTxtlCM69T22xGcCGVwLn2T2Y83jV2cYHTJTXFIRIsGXMdYqQLC!-384445592?FOLDER%3C%3Efolder_id=2534374302696497&PRODUCT%3C%3Eprd_id=845524441776153&bmUID=1175621361170

Fuel containers for backpacking are either plastic or aluminium. Aluminium containers are usually a cylindrical aluminium bottle. Once a container is used for a particular type of fuel it should not be used for another fuel, as the substances may combine and deteriorate the container.

Plastic bottles are usually red in colour and are coated with a fluoropolymer inner coating that resists both gasoline and alcohol. Plastic fuel bottles should never be used as a tank for a stove or be pressurized with a pump.

WATER CONTAINER/CARRIER

Carrying water for a short day hike is usually no problem—one only requires a lightweight water bottle with a tight lid. When camping, a larger storage container is required.

Water Bottle. A water bottle may be used for any type of hike. Versatile equipment benefits the user. Choose bottles that can withstand the temperatures of freezing cold or boiling hot liquids.



Figure 17 Water Canteen

D Cds 3, 2007, Ottawa, ON: Department of National Defence



Figure 18 Nalgene Water Bottle

Mountain Equipment Coop, Copyright 2007 by Mountain Equipment Coop. Retrieved 28 March 2007, from http://www.mec.ca/Products/product_detail.jsp?PRODUCT%3C%3Eprd_id=845524442500177&FOLDER%3C%3Efolder_id=2534374302696609&bmUID=1177425692300

Water Carrier Bag. Water carrier bags are convenient for long treks where there is no water and for carrying water from a source to a campsite. Small bags are useful as they can be balanced on different parts of one's pack. Water bags can carry up to several litres of water.



Figure 19 MSR Water Bag

Mountain Equipment Coop, Copyright 2007 by Mountain Equipment Coop. Retrieved 24 April 2007, from http://www.mec.ca/Products/product_detail.jsp?PRODUCT%3C%3Eprd_id=845524441772631&FOLDER%3C%3Efolder_id=2534374302696609&bmUID=1177427868771

Jerry Can. A jerry can is a large water container that has a capacity of 20 L. This container is either green or black in colour and is identified with the word 'water', as seen in Figure 20.



Figure 20 Black and Green Jerry Can

D Cdts 3, 2007, Ottawa, ON: Department of National Defence

CONFIRMATION OF TEACHING POINT 3

QUESTIONS

- Q1. Containers of what two materials can store fuel?
- Q2. What colour is a jerry can?
- Q3. What is the capacity of a jerry can?

ANTICIPATED ANSWERS

- A1. Aluminium and plastic containers can store fuel.
- A2. A jerry can is black or green.
- A3. A jerry can holds 20 L of water.

Teaching Point 4

Identify the Contents of a First Aid Kit

Time: 15 min

Method: Interactive Lecture



This TP is intended to give an overview of a first aid kit. Lay out all items in the first aid kit and discuss each as listed.

FIRST AID KIT

When travelling with a group, carry a first aid kit of appropriate size and type for the group and the activities expected. The first aid kit must be readily available during training and must be carried with every group at all times.

Commercially available first aid kits are useful, but the contents need to be tailored for the field setting. The minimum contents of a first aid kit, as listed in A-CR-CCP-951-PT-002, are listed below:

Instruments

- **One Pair of Bandage Scissors.** Scissors are essential for cutting tape and bandages.
- **One Pair of Splinter Type Forceps.** Splinter type forceps resemble tweezers, and they are used for grasping and holding (e.g. removing wood splinters).
- **12 Safety Pins (Assorted Sizes).** A safety pin is a pin with a point that is bent back to the head and is held in a guard when closed. These are used to secure bandages, etc.
- **Two Splints.** A splint is stiff rigid material may be used for holding a limb or broken bone in a fixed position.
- **One Respirator With Valve.** A respirator with a valve is an apparatus for maintaining artificial respiration. It also provides separation between the casualty and the first-aider, protecting the transmission of infections when giving rescue breaths.

Dressings

Dressings are used to cover bleeding wounds. These dressings and bandages come in various sizes and types, to include:

- 25 separately wrapped sterile adhesive bandages (25 mm x 75 mm);
- 25 separately wrapped sterile gauze compresses (101.6 mm x 101.6 mm);
- 4 separately wrapped rolls of sterile gauze bandages (50 mm x 9 m);
- 4 separately wrapped rolls of sterile gauze bandages (101.6 mm x 9 m);
- 6 triangular bandages;
- 2 rolls of 75 mm wide elastic bandages;
- 4 separately wrapped sterile compress bandages (101.6 mm x 101.6 mm);
- 1 roll of adhesive plaster (25 mm x 9 m);
- 2 rolls of 50-g cotton batting; and

Antiseptic pads

Antiseptic pads are sterile, free from contamination. They are used to clean the area surrounding a wound. Each first aid kit shall contain 25 separately wrapped antiseptic pads.

Sugar

Sugar is included in a first aid kit in the event that a diabetic becomes hypoglycemic. Hypoglycemia occurs when there is a deficiency of glucose (sugar) in the bloodstream. The sugar is either mixed with water and consumed or ingested directly.

Equipment

- **Blanket of Wool or a Moisture-proof Insulating Material.** This can be any type of wool blanket or a survival/emergency foil blanket. Only one is required and it is used to keep a casualty warm.
- **Waterproof Lighter or Matches.** Waterproof lighter or matches are useful for creating fire. Matches should not be wasted and only used when improvised methods fail.
- **Latex Gloves.** These gloves are used to provide a sterile barrier between the first-aider and the casualty. There shall be a minimum of two pairs per first aid kit.

CONFIRMATION OF TEACHING POINT 4

QUESTIONS

- Q1. Why are scissors in a first aid kit?
- Q2. What purpose does sugar serve in a first aid kit?
- Q3. Why are there latex gloves in the first aid kit?

ANTICIPATED ANSWERS

- A1. Scissors are essential for cutting tape and bandages.
- A2. Sugar is used in the event that a diabetic went hypoglycemic. Hypoglycemia occurs when there is a deficiency of glucose (sugar) in the bloodstream.
- A3. Latex gloves are in a first aid kit to provide a sterile barrier between the first-aider and the casualty.

END OF LESSON CONFIRMATION



Complete either the equipment identification or questions for this TP's confirmation.
Hold up a piece of equipment and have the cadets identify it. Do this for five more items.

QUESTIONS

- Q1. What type of fuels can be used in equipment systems?
- Q2. What is the head of an axe made of?
- Q3. When going into the field, how many groups require a first-aid kit?

ANTICIPATED ANSWERS

- A1. Liquid, compressed and solid fuel can be used in equipment systems.
- A2. The axe head is made of tempered steel.
- A3. All groups that travel independently require a first-aid kit.

CONCLUSION

HOMEWORK/READING/PRACTICE

N/A.

METHOD OF EVALUATION

N/A.

CLOSING STATEMENT

Cadets have been provided with information on various types of equipment. This information allows cadets the opportunity to tailor their selection of equipment according to the needs of any weekend bivouac FTX.

INSTRUCTOR NOTES/REMARKS

N/A.

REFERENCES

A2-001 A-CR-CCP-951/PT-002 D Cdts 3. (2006). *Royal Canadian Army Cadets Adventure Training Safety Standards*. Ottawa, ON: Department of National Defence.

C0-111 (ISBN 0-9740820-2-8) Tawrell, P. (2006). *Camping and Wilderness Survival: The Ultimate Outdoors Book* (2nd ed.). Lebanon, NH: Leonard Paul Tawrell.

C2-010 (ISBN 0-375-70323-3) Rawlins, C., and Fletcher, C. (2004). *The Complete Walker IV*. New York, NY: Alfred A. Knopf.

C2-016 (ISBN 0-517-88783-5) Curtis, R. (1998). *The Backpacker's Field Manual: A Comprehensive Guide to Mastering Backcountry Skills*. New York, NY: Three Rivers Press.

C2-042 (ISBN 0-7566-0946-1) Berger, K. (2005). *Backpacking & Hiking*. New York, NY: DK Publishing, Inc.

THIS PAGE INTENTIONALLY LEFT BLANK



ROYAL CANADIAN ARMY CADETS

RED STAR

INSTRUCTIONAL GUIDE



SECTION 3

EO M221.03 – IDENTIFY PROVINCIAL/TERRITORIAL WILDLIFE

Total Time:

60 min

PREPARATION

PRE-LESSON INSTRUCTIONS

Resources needed for the delivery of this lesson are listed in the lesson specification located in A-CR-CCP-702/PG-001, Chapter 4. Specific uses for said resources are identified throughout the Instructional Guide within the TP for which they are required.

Review the lesson content and become familiar with the material prior to delivering the lesson.

Learning stations are a form of group work, where the cadets learn by sorting through information presented. When setting up learning stations, ensure there is enough room for each cadet to be comfortable, and adequate space for writing down information. When the cadets arrive at a learning station, all information needed shall already be available. These stations should be placed closely together to minimize time for movement; however far enough apart to avoid interruptions from other groups. For this lesson, choose and set up a minimum of four learning stations for provincial/territorial wildlife.

Photocopy handouts located at Annexes A and B.

PRE-LESSON ASSIGNMENT

N/A.

APPROACH

An in-class activity was chosen for TP1 as it is an interactive way to provoke thought and stimulate interest among cadets.

An interactive lecture was chosen for TP2 to orient the cadets to potential risks of animals in the field and present background material.

INTRODUCTION

REVIEW

N/A.

OBJECTIVES

By the end of this lesson the cadet shall be expected to know characteristics of their provincial/territorial wildlife, specifically those that may be encountered when in the field.

IMPORTANCE

It is important for cadets to be able to identify the wildlife in their province/territory. There are many species of wildlife throughout Canada, and they differ in each province. While on an expedition, cadets may encounter a variety of wildlife in their natural habitats. Most conflicts between man and nature can be avoided by being able to identify wildlife and knowing their specific characteristics. All cadets should be aware of what to do when they come across wildlife in the field.

Teaching Point 1

Introduce the Cadets to Provincial/Territorial Wildlife

Time: 40 min

Method: In-Class Activity



The provincial/territorial wildlife information sheets for this activity are located at Annex A.

The provincial/territorial wildlife worksheet for this activity is located at Annex B.



Cadets should be aware of any provincial/territorial wildlife left out of this activity. If time permits, give the cadets the opportunity to read the remaining information sheets.

ACTIVITY

OBJECTIVE

The objective of this activity is to gain knowledge of some provincial/territorial wildlife that cadets may encounter when in the field.

RESOURCES

- Provincial/territorial wildlife information sheets;
- Provincial/territorial wildlife worksheets; and
- Pens/pencils.

ACTIVITY LAYOUT

Four learning stations will be set up and clearly marked for each of the chosen wildlife and will include:

- provincial/territorial wildlife information sheets, which will include:
 - the general description;
 - the habitat;
 - the diet; and
 - any unique characteristics;
- provincial/territorial wildlife worksheets; and
- pens/pencils.

ACTIVITY INSTRUCTIONS

1. Divide cadets into four groups and place each group at one of the wildlife learning stations.
2. Assign each group a leader. The group leader will be responsible for assigning tasks to fellow cadets. Each station will need a recorder and a reader.
3. Cadets will have eight minutes at each station to fill out a provincial/territorial worksheet (it is only necessary for each group to fill out one worksheet).
4. After eight minutes, the groups will rotate clockwise to the next station, where they will have another eight minutes to complete a provincial/territorial worksheet.
5. Rotate the groups through the remaining stations.
6. Have the cadets share the information they recorded from the station they have just completed with the rest of the cadets. In most cases, the groups will have recorded the same information for each station. If a group has listed different information, it will be shared after the presenting group has finished.

SAFETY

N/A.

CONFIRMATION OF TEACHING POINT 1

The cadets' participation in the activity will serve as the confirmation of this TP.

Teaching Point 2

Discuss Potential Risks of Animals in the Field

Time: 10 min

Method: Interactive Lecture



The word “attack” is referred to numerous times throughout this TP. Ensure cadets are aware that an attack is a form of violence and does not always indicate injury or harm.

Though attacks are uncommon, stress the importance of knowing what to do if the situation ever arises.

BEARS

Bear attacks are uncommon. Wild animals generally prefer to avoid human contact and bears are no exception. Most documented encounters occurred when the bear's natural avoidance behaviour shifted to aggression. This shift is normally caused from one, or a combination of, the following:

- They are suddenly surprised.
- They are protecting young or food.
- They follow food and food-like odours to humans.
- They are provoked by other animals (e.g. dogs).
- They are accustomed to people and have lost their natural fear.

The best way to live safely with bears is to avoid contact with them. There are important prevention actions that can be taken, such as:

- making noise;
- hiking in groups and mainly in the daylight;
- staying on established trails;
- using extra caution when travelling near rushing water or into the wind;
- staying in open area as much as possible; and
- disposing of garbage frequently, in designated areas.



When hiking/training in an area that has bears, always have bear spray or pepper spray on hand.

If you carry bear spray, be aware that wind, spray distance, rain, freezing temperatures, and product shelf life can all influence its effectiveness.

When a Bear Attacks

According to Parks Canada there are two kinds of attacks, based on the bear's behaviour—defensive and predatory.

Defensive Attack. This attack normally occurs when the bear is feeding, protecting its young and/or unaware of a person's presence. It attacks mainly because it sees the person as a threat. It is the most common type of attack.

Predatory Attack. This attack normally occurs when the bear is stalking a person along a trail and then attacks. It may also happen at night.

In Tawrell, P., *Camping and Wilderness Survival*, Leonard Paul Tawrell states the following actions to take when a **black bear** attacks.

- Do not play dead.
- Fight back – hit its snout, try to poke a stick in its eye, throw dirt or rocks into its eyes, do anything to distract attention.
- Do not climb a tree or run. Black bears can climb trees very fast!

In Tawrell, P., *Camping and Wilderness Survival*, Leonard Paul Tawrell states the following actions to take when a **grizzly bear** attacks.

- Play dead by lying flat on the stomach with legs spread out, cover the neck with intertwined fingers, and have elbows covering the face. Spread the legs out to prevent the bear from rolling you over.
- Do not attempt to run, as the bear can outrun you and the action of running will trigger the bear's predatory instinct.
- If the bear rolls you over, keep rolling to land on the stomach.

- At this point the bear might get bored and leave. Do not move until it is clear that the bear has left. It might only be lying nearby and resting.
- If the bear starts to lick your wounds, the attack has turned very serious and fighting back is necessary. Try hitting it on its snout or poking a stick or finger in its eyes.



There are bear-specific characteristics to note.

Black Bears. Black bears have been known to be on the lookout for “easy” calories. Once they find human food or garbage (if they are food-conditioned), they continue to seek it out from backpacks, picnic tables, coolers, etc. When accustomed to humans, their natural fear fades and they take more chances to find food.

Grizzly Bears. The most common circumstance of attack is the “sudden encounter”. To decrease chances of coming into a conflict, regularly make noise when hiking.

Polar Bears. Polar bears have been known to stalk humans as prey. They do not generally attack, but if someone is alone, they are easy prey for a hungry polar bear. When in polar bear country, a firearm is essential for safety.

WOLVES

Most people will never see a wolf; they are shy and generally avoid humans. Wolves can, however, lose their fear of humans and may approach camping areas or homes.

Attacks by healthy wild wolves do occur but are rare. The majority of attacks have been from rabid wolves.

Preventative actions include:

- Never feed wolves or any other wildlife.
- Dispose of all garbage.
- Ignore them as much as possible if they come into sight.
- Never allow a wolf to get close.
- Never approach a wolf.

According to the International Wolf Centre, if a wolf acts aggressively (growls or snarls) or fearlessly, actions that should be taken include:

- raising and waving arms to appear larger;
- backing away slowly with back turned;
- making noise; and
- throwing objects.



There has never been a documented case of a healthy, wild wolf killing a person in North America. Most wolves are not dangerous to humans. Injuries that have occurred by wolves have been caused by a few wolves that became fearless of humans due to habituation (wolves becoming too comfortable in human inhabited areas).

COYOTES

Unlike wolves, coyotes do not have a natural fear of human beings. In highly populated areas, they are often seen patrolling, looking for garbage or small animals. Coyotes that are being fed will often bite, sometimes seriously.

Preventative actions include:

- Never feed coyotes or any other wildlife.
- Dispose of all garbage.
- Supervise children closely.
- Keep pets inside at night.
- Never approach a coyote.

According to the Government of Manitoba – Manitoba Conservation, if a person encounters a coyote actions that should be taken include:

- stopping immediately and remaining calm;
- raising and waving arms to appear larger;
- backing away slowly if it is not looking in the direction; and
- throwing stones or other objects.



Never turn away from a coyote or run since this will encourage a coyote to chase. If a coyote ever attacks, fight back.

COUGARS

Cougar attacks are unlikely among humans, partially because cougars do not perceive humans as prey. Cougar populations are growing throughout western Canada. Females with kittens and those that are cornered, surprised or feeding on a kill may act aggressively. Cougars often show curiosity toward human activities without behaving aggressively.

Cougars may display various behaviours as a warning before an attack, such as stalking, crouching, sweeping their tail, extending their eye contact, snarling, keeping their body low to the ground, and pumping their rear legs.

Some preventative actions include:

- Do not hike alone.
- If confronted, stay calm and do not run; it may stimulate the instinct to chase.
- Maintain eye contact and shout as calmly as possible.
- Try to appear larger by raising and waving arms.
- Arm yourself with a stick.
- Never turn your back.
- Do not “play dead”.
- Throw rocks.

In Tawrell, P., *Camping and Wilderness Survival*, Leonard Paul Tawrell states if a cougar attacks, fight back aggressively using any object nearby such as sticks or rocks.

CONFIRMATION OF TEACHING POINT 2

QUESTIONS

- Q1. What are some preventive actions to take against a bear attack?
- Q2. What action should be taken if a wolf growls or snarls at you?
- Q3. What steps should be taken if you encounter a cougar?

ANTICIPATED ANSWERS

- A1. Some preventive actions include:
- making noise;
 - hiking in groups and in daylight;
 - staying on established trails;
 - using extra caution when travelling near rushing water or into the wind;
 - staying in open area as much as possible; and
 - disposing of garbage frequently, in designated areas.
- A2. If a wolf acts aggressively (growls or snarls) or fearlessly, the following actions should be taken, such as:
- raising and waving arms;
 - backing away slowly with back turned;
 - making noise; and
 - throwing objects.
- A3. Preventative actions for cougar encounters include:
- Do not hike alone.
 - If confronted, stay calm and do not run; it may stimulate the instinct to chase.
 - Maintain eye contact and shout as calmly as possible.
 - Try to appear larger.
 - Arm yourself with a stick.
 - Never turn your back.
 - Do not "play dead".
 - Throw rocks.

END OF LESSON CONFIRMATION

The cadets' participation in the activity in TP1 will serve as the confirmation of this lesson.

CONCLUSION

HOMEWORK/READING/PRACTICE

N/A.

METHOD OF EVALUATION

N/A.

CLOSING STATEMENT

Recognizing provincial/territorial wildlife is an important aspect of field training. Since cadets spend time training and hiking in the field, it is essential to recognize the wildlife that are present as well as to know how to coexist with them.

INSTRUCTOR NOTES/REMARKS

N/A.

REFERENCES

C0-111 (ISBN 978-0-9740820-2-8) Tawrell, P. (2006). *Camping and Wilderness: The Ultimate Outdoors Book* (2nd ed.). Lebanon, NH: Leonard Paul Tawrell.

C0-121 Canadian Wildlife Service and Canadian Wildlife Federation. (2007). *Hinterland Who's Who – Species*. Retrieved 26 February 2007, from <http://www.hww.ca/hww.asp?id=1&pid0>

C0-122 (ISBN 0-618-15313-6) Bowers, Nora, Bowers, Rick, and Kaufman, Kenn. (2004). *Kaufman Focus Guides: Mammals of North America*. New York, NY: Houghton Mifflin Company.

C2-043 The Hunting Outfitters. (2007). *The Hunting Outfitters*. Retrieved 9 February 2007, from <http://www.huntingoutfitters.com>.

C2-059 Parks Canada. (2007). *Bears and People: A Guide to Safety and Conservation on the Trail*. Retrieved 5 March 2007, from http://www.pc.gc.ca/pn-np/inc/PM-MP/visit/visit12a_e.pdf.

C2-060 International Wolf Center. (2003). *Wolves and Humans – Are Wolves Dangerous to Humans?* Retrieved 5 March 2007, from http://www.wolf.org/wolves/learn/basic/pdf/wh_are_wolves_dangerous.pdf.

C2-061 Waterton Park Information Services. (2007). *Reference Information Section*. Retrieved 5 March 2007, from <http://www.watertoninfo.com/r/pred.html>.

C2-062 International Wolf Center. (2002). *Living with Wolves: Tips for Avoiding Conflicts*. Retrieved 5 March 2007, from http://www.wolf.org/wolves/learn/basic/pdf/wh_avoiding%20conflict.pdf.

C2-064 Minnesota Trappers Association. (2007). *Canadian Lynx*. Retrieved 12 March 2007, from <http://www.mntrappers.com/lynx.html>.

C2-074 Manitoba Conservation. (2007). *Living with Wildlife in Manitoba*. Retrieved 25 April 2007, from http://www.gov.mb.ca/conservation/wildlife/problem_wildlife/pdf/coyote.html.

PROVINCIAL/TERRITORIAL WILDLIFE

		
<h3>THE RED FOX</h3>	<h3>RED FOX LOCATIONS</h3>	<h3>RED FOX TRACKS</h3>
<p><i>Bowers, N., Bowers, R., and Kaufman, K., Kaufman Focus Guides: Mammals of North America, Houghton Mifflin Company (p. 131)</i></p>	<p><i>Bowers, N., Bowers, R., and Kaufman, K., Kaufman Focus Guides: Mammals of North America, Houghton Mifflin Company (p. 130)</i></p>	<p><i>Canadian Wildlife Service & Canadian Wildlife Federation, 2003, Hinterland Who's Who - Mammal Fact Sheets. Retrieved 26 February 2007, from http://www.hww.ca/hww2p.asp?id=102&cid=0</i></p>
<p>The red fox is a small, dog-like mammal, with a sharp pointed face and ears. It has a lightly built body, a coat of lustrous long fur, and a large bushy tail. Generally, male foxes are bigger than females. Adult foxes weigh between 3.6 and 6.8 kg and are normally between 90 and 112 cm in length. Size varies between individuals and geographic locations—those in the north are normally bigger.</p>		
<p>The colour of the coat of a red fox is normally a variation of reddish brown, but can be silver, black, or even have a black cross on the back. The lower legs and feet of the red fox are usually blackish, and the tail has a white tip.</p>		
<p>Red foxes are Canada's most widespread mammal. They are found in all provinces and territories. Foxes are normally found in areas where there is a mix of open field and wooded or brushy country; however, they can also survive easily in a city.</p>		
<p>A fox is both a hunter and a scavenger. Their diet consists of rodents, rabbits, birds, insects, fruit, earthworms, reptiles, and carrion (dead flesh). Wolves, coyotes, and dogs will chase and sometimes kill foxes when the opportunity presents itself.</p>		
<p>Humans hunt foxes for their fur. Hunting and trapping are not authorized during the season when young are being raised. Hunting season occurs in early winter when the fur is good quality for trapping. Nuisance foxes are often destroyed on a local basis.</p>		
<p>Rabies is a contagious and fatal viral disease that is transferred through the saliva of the affected animal to a human. It causes madness and convulsions. Foxes have occasionally become a menace to public health, especially in rural areas, when epidemics of rabies sweep through wild mammal populations. Once symptoms are confirmed, rabid foxes should be avoided. When rabid, the normally shy foxes show no fear of people and are often seen in daylight. In advanced stages of the disease, they may foam at the mouth.</p>		

Figure A-1 The Red Fox







		 <p>ABOUT 10 cm</p>
<p>THE CARIBOU</p> <p><i>Bowers, N., Bowers, R., and Kaufman, K., Kaufman Focus Guides: Mammals of North America, Houghton Mifflin Company (p. 159)</i></p>	<p>CARIBOU LOCATIONS</p> <p><i>Bowers, N., Bowers, R., and Kaufman, K., Kaufman Focus Guides: Mammals of North America, Houghton Mifflin Company (p. 158)</i></p>	<p>CARIBOU TRACK</p> <p><i>Bowers, N., Bowers, R., and Kaufman, K., Kaufman Focus Guides: Mammals of North America, Houghton Mifflin Company (p. 158)</i></p>
<p>The caribou is a member of the deer family. They are very tough and able to survive year-round in harsh climates. Their short, stocky bodies conserve heat, their long legs help them move through snow, and their long dense winter coats provide effective insulation, even during periods of low temperature and high wind.</p> <p>Caribou normally have dark faces and noses, light cream-coloured necks, and blackish legs. Size and colour will vary with location. The Southern Woodland Caribou is the largest and darkest; Peary's Caribou of the high Arctic islands is the smallest and palest. Colour will also vary with season. Caribou will be dark and brown in summer, and pale and grey in the winter. Unlike other deer, both males and females have antlers. Their antlers shed annually. Bulls (males) lose theirs shortly after the fall and cows (females) keep theirs until calving in the spring. Female antlers have a fuzzy covering, called velvet, which contains blood vessels that carry nutrients for growth.</p> <p>Caribou dwell in a variety of places such as forests, mountains, and tundra. In summer, caribou feed on a wide variety of plant material, including grasses, shrubs, sedges, twigs, and mushrooms. In winter, they feed mainly on lichens.</p> <p>When the caribou is in danger, it rears up on its hind legs and deposits a scent that alerts other caribou to the threat.</p> <p>It is believed that the caribou's name was derived from the Mi'kmaq word "xalibu" which means "the one who paws", mainly because they have very versatile hooves. In the winter, their hooves grow to an incredible length, giving them firm footing on crusty snow. In the summer, their hooves are worn away by travel over hard ground and rocks. They function as efficient scoops in the snow when trying to uncover lichens. Caribou are also excellent swimmers and their hooves function well as paddles.</p> <p>There are four subspecies of caribou in Canada: woodland, Peary, barren-ground west of the Mackenzie River (also known as Grant's caribou), and barren-ground east of the Mackenzie River. The Mackenzie River is located in the Northwest Territories, and it flows into the Arctic Ocean.</p>		

Figure A-2 The Caribou

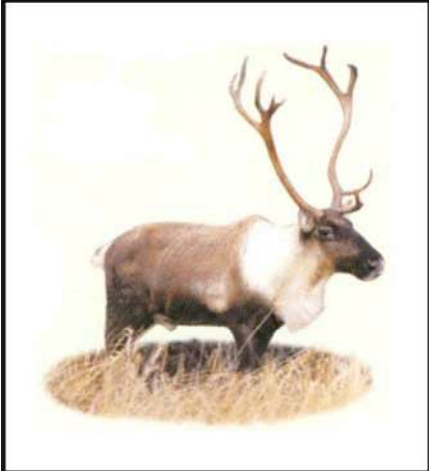
		 <p>ABOUT 6.5 cm</p>
<p>THE WHITE-TAILED DEER</p> <p><i>Bowers, N., Bowers, R., and Kaufman, K., Kaufman Focus Guides: Mammals of North America, Houghton Mifflin Company (p. 151)</i></p>	<p>WHITE-TAILED DEER LOCATIONS</p> <p><i>Bowers, N., Bowers, R., and Kaufman, K., Kaufman Focus Guides: Mammals of North America, Houghton Mifflin Company (p. 150)</i></p>	<p>WHITE-TAILED DEER TRACK</p> <p><i>Bowers, N., Bowers, R., and Kaufman, K., Kaufman Focus Guides: Mammals of North America, Houghton Mifflin Company (p. 150)</i></p>

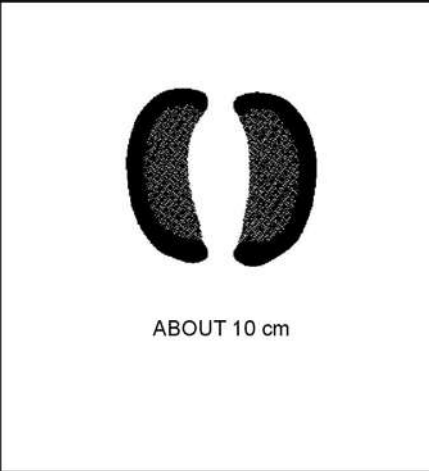
The white-tailed deer is very well known in Canada. It is recognized by its habit of flourishing its tails over its back, revealing a stark white underside and white buttocks. The tail has a broad base and is about 30 cm long. When lowered, it is brown with a white fringe. In summer, the white-tailed deer has reddish fur on the back and sides and is white beneath; in winter, the upper parts turn greyish. Full grown white-tailed deer typically exceed one metre at shoulder height and weight about 110 kg (245 lbs); however, those in northern regions can weigh up to 200 kg (440 lbs).

The antlers of a mature white-tailed deer curve forward and have single points that project upward and often slightly inward. Males grow new antlers each year. One of every 1000 females bear small, simple antlers. Occasionally, white-tailed deer will get their antlers hopelessly entangled with those of another male during a mating season battle, resulting in the slow death of both animals.



White-tailed deer can be found in open forests bordering fields and natural meadows. They are browsers and grazers, feeding on a wide variety of plant materials, from twigs and leaves to grasses, berries, acorns, and fungi. At times, white-tailed deer will eat row crops and garden plants.

When alarmed, the deer leaps (its hind feet hitting the ground before its front feet), flags its tail, and shows the bright white underside.

Deer reproduce quickly. A healthy herd is capable of almost doubling its numbers during one good year. Although a series of severe winters may tend to reduce the range of the white-tailed deer, a few positive years allow it to reoccupy the lost ground, rebuild populations, and even extend range further northward.

Deer in Canada are relatively free of serious diseases or parasites. Typically, their natural predators are the wolf, coyote, and bobcat. These predators have been greatly reduced in number and only occasionally exert significant pressure on the white-tailed deer. Free-roaming dogs sometimes take a heavy toll on deer of all ages; particularly in late winter when crusted snow aids dogs but hinders weakened deer. Deer may have difficulty surviving in the winter, especially if there are too many competing for food, or if the snow is deep.

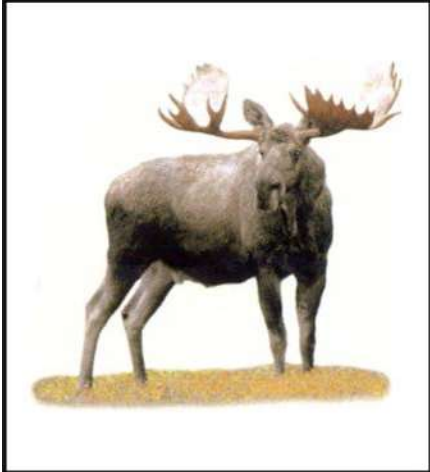
Figure A-3 The White-tailed Deer

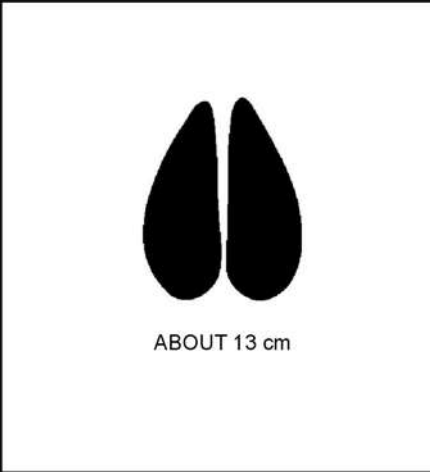
		 <p>ABOUT 13 cm</p>
<p>THE MOOSE</p> <p><i>Bowers, N., Bowers, R., and Kaufman, K., Kaufman Focus Guides: Mammals of North America, Houghton Mifflin Company (p. 155)</i></p>	<p>MOOSE LOCATIONS</p> <p><i>Bowers, N., Bowers, R., and Kaufman, K., Kaufman Focus Guides: Mammals of North America, Houghton Mifflin Company (p. 154)</i></p>	<p>MOOSE TRACK</p> <p><i>Bowers, N., Bowers, R., and Kaufman, K., Kaufman Focus Guides: Mammals of North America, Houghton Mifflin Company (p. 154)</i></p>

Moose have long, slim legs. Their bodies have massive muscles at the shoulders, giving them a humped appearance. The head is heavy and compact, and the nose extends in a long, mournful-looking arch. Most moose have a pendant of fur-covered skin that hangs about 30 cm long from the throat, commonly referred to as a bell. Their colour varies from dark brown, almost black, to reddish or greyish brown, with grey or white legs. Big bulls (males) weigh up to 600 kg (1320 lbs) in most of Canada; however, the subspecies found in the Yukon territory can weigh as much as 800 kg (1760 lbs). Moose have a great appetite and will consume up to 20 kg (45 lbs) of food per day. Their preferred food includes aquatic plants in the summer, twigs and woody stems in the winter, willow, and aspen leaves. The eyesight of the moose is extremely poor; however, they have great senses of smell and hearing.

Like other members of the deer family, moose normally shed their antlers. Most moose will lose them in November, but some younger bulls may carry them until April. Their antlers can span up to 150 cm. Moose antlers have a broad flattening throughout and are pale, sometimes white.

Moose can tolerate cold weather well, but suffer in the heat because they cannot perspire. During summer, moose can be found in marshy and watered areas, trying to cool off. Moose are excellent divers and swimmers, as are their young.

Despite their huge size, adult moose are sometimes taken by predators such as wolves, black bears, and grizzly bears. Wolves and bears try to catch calves, but the mother moose can often successfully defend by striking out powerfully with her hooves. People should always avoid females with calves.

Ticks are common on moose, especially in late winter. Moose are significantly weakened because the ticks suck blood which causes them to rub off their hair, and hence causes heat loss. When food is lacking, moose may develop a parasitic tapeworm called hydatid.

Moose have adapted well to human activities and are an important economic resource in Canada. Moose hunting generates over \$500 million annually in economic activity. With continued management, they should always be part of Canadian culture.

Figure A-4 The Moose



		 <p>ABOUT 4 cm</p>
THE SKUNK	SKUNK LOCATIONS	SKUNK TRACK
<i>Bowers, N., Bowers, R., and Kaufman, K., Kaufman Focus Guides: Mammals of North America, Houghton Mifflin Company (p. 105)</i>	<i>Bowers, N., Bowers, R., and Kaufman, K., Kaufman Focus Guides: Mammals of North America, Houghton Mifflin Company (p. 104)</i>	<i>Bowers, N., Bowers, R., and Kaufman, K., Kaufman Focus Guides: Mammals of North America, Houghton Mifflin Company (p. 104)</i>
<p>The striped skunk is about the size of a cat. It has a stout body, a small head, short legs, and a bushy tail. The thick, glossy fur is black, with a thin white stripe down the centre of its face and a broad white stripe beginning on the back of the head. The tail is mostly black, and the stripes may extend down it, usually to a clump of white at the tip.</p> <p>The striped skunk has long, straight claws for digging out burrows of mice, ripping apart old logs for grubs and larvae, and digging in the sand for turtle eggs. It moves slowly and relies on its scent glands for safety.</p> <p>The striped skunk is a useful small mammal that inhabits farmlands, grasslands, and forests. They generally live in the abandoned dens of woodchucks, foxes, or other mammals of similar or larger size and will occasionally make their own dens. Skunks can also be found in stumps, rock piles, or refuse heaps. If a skunk digs its own den, it will be simple. A skunk will gather leaves by placing them under its body and then shuffle along to the den with the leaves between its legs as it moves. They are normally seen late afternoon and through the night.</p> <p>A striped skunk diet consists of insects, mice, shrews, ground squirrels, young rabbits, birds' eggs, and a variety of plants. They are an important predator on insect pests. It is preyed upon by bobcats and large birds. Motorists are also a great hazard to the skunk. Like porcupines, they are overly confident of their defence mechanism and often pay heavily for their manners when crossing highways.</p> <p>Skunks belong to the weasel family, all of whose members have well-developed scent glands and a musky odour. The striped skunk will spray a bad smelling fluid to defend itself. This spray can travel as far as six metres, and the smell is strong enough to be carried almost one kilometre in the wind. The scent is produced by a thick, yellow, oily fluid, secreted by two glands located on each side of the anus. The glands are about the size of a grape and contain about a tablespoon of musk. They are connected by tubes to two small nipples that are hidden when the tail is down, and exposed when the tail is raised. The musk is normally discharged as a last measure after repeated warning signs. They will usually try to retreat from a human or large enemy. An angry skunk will growl or hiss, and stamp its front feet rapidly. They may even walk a short distance on its front feet with its tail high in the air. The striped skunk cannot spray from this position. To perform this defence, the skunk usually humps its back and turns in a U-shaped position so that both the head and the tail face the enemy.</p>		

Figure A-5 The Striped Skunk







		
THE RACCOON	RACCOON LOCATIONS	RACCOON TRACKS
<i>Bowers, N., Bowers, R., and Kaufman, K., Kaufman Focus Guides: Mammals of North America, Houghton Mifflin Company (p. 99)</i>	<i>Bowers, N., Bowers, R., and Kaufman, K., Kaufman Focus Guides: Mammals of North America, Houghton Mifflin Company (p. 98)</i>	<i>Bowers, N., Bowers, R., and Kaufman, K., Kaufman Focus Guides: Mammals of North America, Houghton Mifflin Company (p. 98)</i>
<p>Raccoons are well-known for their mischievous-looking black face mask. They are normally greyish in colour with a tail marked by five to ten alternating black and brown rings. Body colouration varies from albino (white), to black or brown. Raccoons begin to shed their fur in the spring, which lasts for about three months. Their head is broad, with a pointed snout. Their short rounded ears measure about four to six centimetres. Raccoons have black eyes. The body and tail length for adults averages about 80 cm; males are generally larger than females. Size varies with climate.</p> <p>Raccoons are able to live in a wide range of habitats. They can be found in hardwood swamps, forests, marshes, farmlands, and even in cities. They always favour the vicinity of water and trees and are plentiful in wooded swamps.</p> <p>Raccoons will consume practically any food item, plant or animal. They like corn, crayfish, nuts, and fruits, but there is a seasonal shift in diet depending on availability of food items. They are a familiar “masked bandit”, and have been long known to raid garbage cans and garden plots at night.</p> <p>The name raccoon is derived from the Algonquian word arakun, meaning “he scratches with his hand”. They use their front feet like hands to manipulate food items and are famed for appearing to “wash” their food before eating it.</p> <p>Since the raccoon can be easily tamed when young, many people have had their lives enriched by a close association with this intelligent, inquisitive animal. Males, however, may become aggressive as they mature and usually end up being returned to the wild. The raccoon is one of the few creatures that are capable of making the adjustment from family pet back to wild animal.</p>		

Figure A-6 The Raccoon

		 <p>FRONT ABOUT 11.5 cm</p> <p>HIND ABOUT 9.5 cm</p>
<p>THE GRAY WOLF</p>	<p>GRAY WOLF LOCATIONS</p>	<p>GRAY WOLF TRACKS</p>
<p><i>Bowers, N., Bowers, R., and Kaufman, K., Kaufman Focus Guides: Mammals of North America, Houghton Mifflin Company (p. 127)</i></p>	<p><i>Bowers, N., Bowers, R., and Kaufman, K., Kaufman Focus Guides: Mammals of North America, Houghton Mifflin Company (p. 126)</i></p>	<p><i>Bowers, N., Bowers, R., and Kaufman, K., Kaufman Focus Guides: Mammals of North America, Houghton Mifflin Company (p. 126)</i></p>

Wolves, also known as gray wolves, vary in colour. They are often grey-brown, but can also be black, white, or reddish. They have long bushy tails. Their colour variation is a good example of natural selection; since those found in the north are normally white and those found in forests will normally have greyish, greenish, and brownish coats. Wolves look a lot like a German Sheppard, but they have a narrower chest, longer legs, and bigger feet. When running, wolves carry their tails straight out behind them.

Wolves have a highly organized social structure that centres on a dominant male and a dominant female. A dominant wolf will hold its tail high and stand stiff-legged. They are very territorial.

Gray wolves live in packs of five to ten which normally consist of a breeding pair, their young from recent years, and sometimes unrelated wolves. All pack members cooperate in hunting and sharing kills. They travel great distances over home ranges. When hunting, they can put on bursts of speed up to 70 kilometres per hour. In addition to preying on hoofed animals such as moose or bison, they take hares, beavers, and many smaller creatures. Wolves communicate, and maintain distance from other packs, by howling.

The main prey of wolves are large mammals such as deer, moose, caribou, and elk. Wolves also eat a variety of smaller mammals and birds, but these rarely make up more than a small part of their diet. Wolves work hard for their food. Studies show that they kill only about one large mammal for every 10 chased. In winter, they usually kill old and young animals. When prey numbers decline, the entire pack of wolves will prey on all age groups. In summer, much of the wolves' diet consists of young animals born that year, because they are the easiest to catch.

The wolf was once a much criticized animal. In popular children's tales like *Little Red Riding Hood* and *The Boy Who Cried Wolf*, the wolf is made out to be a raider and a killer of livestock and people. There are no records of wolves killing humans in Canada or the United States. Today, many people know that scientists studying wolves have lived very close to dens where there were pups without being attacked. In areas where wolves are hunted or trapped, they fear people and are very wary. However, in remote places, such as the Canadian Arctic, they show little fear and will often allow people to live near them.

Figure A-7 The Gray Wolf





		
THE CANADIAN LYNX	CANADIAN LYNX LOCATIONS	CANADIAN LYNX TRACKS
<i>Bowers, N., Bowers, R., and Kaufman, K., Kaufman Focus Guides: Mammals of North America, Houghton Mifflin Company (p. 139)</i>	<i>Bowers, N., Bowers, R., and Kaufman, K., Kaufman Focus Guides: Mammals of North America, Houghton Mifflin Company (p. 138)</i>	<i>Minnesota Trappers Association, Mike Stutz, 2007, Minnesota Trappers Association - Canadian Lynx. Retrieved 12 March 2007, from http://www.mntrappers.com/lynx.html</i>
<p>The Canadian lynx resembles a very large domestic cat. It has a short tail, long legs, large feet, and prominent ear tufts. Its winter coat is light grey and slightly speckled with long guard hairs; the under fur is brownish, and the ear tufts and the tip of the tail are black. The summer coat is much shorter than the winter coat and has a reddish brown cast.</p> <p>Its large feet, which are covered during the winter by a dense growth of coarse hair, help the lynx travel over snow. The Canadian lynx can spread its toes in soft snow, expanding its "snowshoes". The lynx has large eyes and ears and relies on its acute sight and hearing when hunting. The lynx's claws, like those of most other cats, are retractable and used primarily for catching prey and fighting.</p> <p>The lynx makes a variety of sounds, like those made by house cats, but louder.</p> <p>The Canadian lynx generally lives in forested wilderness areas. It prefers old growth boreal forests with dense undercover of wood and windfalls. However, it will populate other types of habitat as long as they contain some forest cover and adequate numbers of prey, in particular snowshoe hares.</p> <p>As long as they are not disturbed, lynx are remarkably tolerant of human settlement. Like the cougar and bobcat, the Canadian lynx tends to be secretive, active at night and rarely seen.</p> <p>The lynx preys almost exclusively on the snowshoe hare. Since snowshoe hare populations follow a 10 year cycle, lynx numbers dramatically vary, building to a peak as hare populations increase, and then crashing. Their supplement diet consists of grouse, voles, mice, squirrels, and foxes. They may also supplement their diet with carrion or dead flesh from big game such as deer.</p> <p>The Canadian lynx normally hunts alone and during the night. A lynx can jump as far as 6.5 m, which equals about four hops for a hare.</p>		

Figure A-8 The Canadian Lynx

		 <p>FRONT ABOUT 15 cm</p> <p>HIND ABOUT 18 cm</p>
<p>THE BLACK BEAR</p> <p><i>Bowers, N., Bowers, R., and Kaufman, K., Kaufman Focus Guides: Mammals of North America, Houghton Mifflin Company (p. 143)</i></p>	<p>BLACK BEAR LOCATIONS</p> <p><i>Bowers, N., Bowers, R., and Kaufman, K., Kaufman Focus Guides: Mammals of North America, Houghton Mifflin Company (p. 142)</i></p>	<p>BLACK BEAR TRACKS</p> <p><i>Bowers, N., Bowers, R., and Kaufman, K., Kaufman Focus Guides: Mammals of North America, Houghton Mifflin Company (p. 142)</i></p>

The black bear is a heavy, bulky, thickset mammal. It is normally about 150 cm long and varies in height from 100 to 120 cm. An adult bear has a moderate-sized head, a straight facial profile, and a tapered nose with long nostrils. The black bear has flexible lips, which are free from its gums, and a long tongue, which helps it gather tiny food items such as blueberries and ants. Their ears are rounded and their eyes are small. The tail is short and not easily seen. An average adult male weighs about 180 kg (400 lbs), whereas an average adult female weighs about 100 kg (220 lbs).

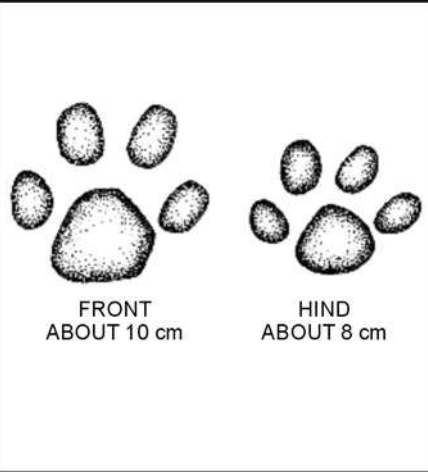
Despite its name, the black bear varies in colour. In eastern Canada, black bears are normally all black with a brown muzzle (front portion of the face). In western Canada, they can be seen as black, brown, cinnamon, or blond. Generally, cubs in a litter will be the same colour as their mother.

The black bear can be found in a variety of habitats, but it prefers heavily wooded areas and dense bush land. They are capable of travelling great distances and have been found 80 km or more from their homes.

The black bear will eat pretty much anything. Most of their food is plants, especially in the late summer and autumn when berries and nuts are available. In the spring, some bears may prey upon newborn moose calves, deer fawns, caribou calves, or elk calves. Bears drink frequently and are more often than not found near water.

The activity pattern of black bears varies from area to area depending on a number of factors, including human interaction. They are generally active from dawn until dark. Bears have been known to have human contact.

Biologists believe that trees repeatedly clawed and marked by bears serve as a form of communication. Adult males use these trees frequently, presumably to announce their presence to potential mates or rivals. Black bears appear awkward as the shuffle along, but can run as fast as 50 kilometres per hour if necessary. They are good swimmers and frequently cross rivers and small lakes. They climb very well with a series of quick bounds, grasping the tree with their forepaws and pushing with their hind legs. They can fall from a tree of heights up to about 4.5 m and appear unshaken.

The black bear has poor eyesight, but its senses of hearing and smell are very well developed. Under good atmospheric conditions, bears can detect carrion, or flesh of dead animals, which they scavenge.

Figure A-9 The Black Bear



Figure A-10 The Grizzly Bear



		 <p>FRONT ABOUT 12 cm</p> <p>HIND ABOUT 20 cm</p>
<p>THE POLAR BEAR</p> <p><i>Bowers, N., Bowers, R., and Kaufman, K., Kaufman Focus Guides: Mammals of North America, Houghton Mifflin Company (p. 147)</i></p>	<p>POLAR BEAR LOCATIONS</p> <p><i>Bowers, N., Bowers, R., and Kaufman, K., Kaufman Focus Guides: Mammals of North America, Houghton Mifflin Company (p. 146)</i></p>	<p>POLAR BEAR TRACKS</p> <p><i>National Wildlife Federation, 2005, eNature - Polar Bear. Retrieved 22 March 2007, from http://www.enature.com/fieldguides/detail.asp?shapeID=1026&curGroupID=5&lgfromWhere=&curPageNum=4&viewType=tracks</i></p>
<p>The polar bear is the largest land carnivore, or meat eater. The white coat of a polar bear will often appear cream or yellow against arctic ice. Adult males measure from 240 to 260 cm in total length and usually weigh from 400 to 600 kg (880 to 1320 lbs); however, they can weigh as much as 800 kg (1760 lbs) – about the weight of a small car. Adult females are about half the size of males. The polar bear has a long body, neck, and skull. They have large canine teeth and the grinding surfaces of their cheek teeth are jagged, which is an adaptation of a carnivorous diet. Polar bear claws are brownish in colour, short, fairly straight, sharply pointed, and non-retractable.</p> <p>Polar bears prefer areas of ice, which they use for a hunting platform and protective cover, combined with snow drifts, refrozen cracks, and areas of open water surrounded by ice. This habitat preference is closely linked to the presence of their favourite food, ringed seals. They are superbly adapted to their arctic surroundings. Their thick winter coats, with glossy guard hairs and dense under fur, and the thick layer of fat beneath the skin protect them against the cold. Guard hairs shed water easily, so after a swim the polar bear can shake itself off like a dog to decrease chilling and speed the drying process. The white colour of the polar bear also serves as camouflage.</p> <p>The bears' normal pace is a slow, lumbering walk of about 5 to 6 km per hour. They may gallop when chased, but they do not run for long periods of time. When hunting, polar bears rely mainly on their sense of smell. They can detect seal breathing holes covered by layers of ice and snow 90 cm or more thick and up to a kilometre away. Polar bears are excellent swimmers, using their large front paws as powerful oars, while their rear paws trail behind and act like rudders. Underwater, they keep their eyes open. A polar bear may remain below the surface for over a minute.</p> <p>Polar bears will usually not attack humans except to protect their cubs or because they are starving.</p> <p>Although polar bears are not in immediate danger of extinction, they face threats common to all large predators: human violation on their habitat, illegal hunting, and chemical contaminants in their prey. A new threat appears to be global warming or climate change, which is affecting the polar bear's habitat by reducing the total ice cover in the Arctic, thinning the permanent pack of ice of the central polar basin, and changing the timing of freeze-up and break-up in more southerly areas, such as Hudson Bay.</p> <p>The polar bear has been designated as a species of special concern in Canada because of characteristics that make it particularly sensitive to human activities and natural events.</p>		

Figure A-11 The Polar Bear

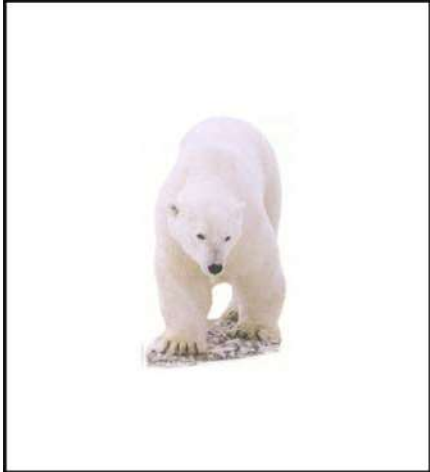

THE BALD EAGLE

Canadian Wildlife Service & Canadian Wildlife Federation, 2003, Hinterland Who's Who - Bird Fact Sheets. Retrieved 26 February 2007, from <http://www.hww.ca/hww2p.asp?id=27&cid=0>

DISTRIBUTION OF THE BALD EAGLE

-  BREEDING RANGE
-  WINTERING RANGE
-  BREEDING AND WINTERING RANGE



BALD EAGLE LOCATIONS

Canadian Wildlife Service & Canadian Wildlife Federation, 2003, Hinterland Who's Who - Bird Fact Sheets. Retrieved 26 February 2007, from <http://www.hww.ca/hww2p.asp?id=27&cid=0>

The bald eagle is Canada's largest bird of prey. One of 59 species of eagles in the world, the bald eagle is one of two eagles in North America (the other is the Golden Eagle). It is the only eagle found exclusively in North America.

Bald eagles are enormous birds. They have a wing span of about two metres. When perched, a fully grown bald eagle measures about 76 cm tall. It is not uncommon for a bald eagle to weigh over seven kilograms. On average, females are larger than males and juveniles are larger but lighter in weight than adults of the same sex. Adults have a dark brown (almost black) body that contrasts sharply with the white feathers on the head and tail, and the yellow beak, eyes, and legs. It takes a young bald eagle four or five years to achieve this distinct colouration.

Bald eagles can see three or four times farther than most people, which is a huge advantage to a bird that hunts and scavenges. They have a sufficient sense of hearing but their senses of taste and smell are poorly developed.

Bald eagles feed primarily on fish, aquatic birds, and mammals, which they may take alive or find dead. The majority of live food consumed consists of the sick or those wounded by hunters. To kill and handle prey, bald eagles have massive beaks, large talons, and oversized feet equipped with small spikes, called spicules. They take food any way they can, stealing from other birds, scavenging on dead flesh, and hunting in flight, from a perch, on the ground, or in shallow water. They will sometimes feed in groups, but rarely cooperate when hunting. Generally, adults are likely to hunt and kill, whereas younger birds rely on scavenging and stealing.

Canadian bald eagle populations are currently relatively stable, although the situation varies regionally. Currently, populations in coastal British Columbia, the boreal forest, and the Atlantic provinces are doing well. Local populations in southern Ontario and New Brunswick, as well as the lower 48 states of the United States, are endangered.

If mortality rates continue to be high, population growth will be slow. However, if suitable habitats remain available and human disturbance is kept to a minimum, the magnificent soaring bird will be enjoyed for many years to come.

Figure A-12 The Bald Eagle







		 <p>ABOUT 9 cm</p>
THE COUGAR	COUGAR LOCATIONS	COUGAR TRACK
<i>Bowers, N., Bowers, R., and Kaufman, K., Kaufman Focus Guides: Mammals of North America, Houghton Mifflin Company (p. 137)</i>	<i>Bowers, N., Bowers, R., and Kaufman, K., Kaufman Focus Guides: Mammals of North America, Houghton Mifflin Company (p. 136)</i>	<i>Bowers, N., Bowers, R., and Kaufman, K., Kaufman Focus Guides: Mammals of North America, Houghton Mifflin Company (p. 136)</i>
<p>In Canada, cougar, mountain lion, puma, and panther are all the same species. Like all cats, the cougar has a muscular, deep-chested body, with a round and short head. Its whiskers are well developed and its eyes are large. The most distinctive feature of the cougar is its long tail, which is useful for balance.</p> <p>Cougars vary considerably in size and weight throughout their range. Adult cougars weigh about 1.4 times more than females. An average weight for a male cougar is about 70 kg (155 lbs); and about 40 kg (88 lbs) for a female. Colours range from reddish orange or orange grey to dark chocolate brown. Cougars have black on the tips of their ears and tails, and black markings on their faces. A kitten cougar will be spotted at birth, but the spots will disappear before their first birthday. Cougars have very strong necks and muscular jaws with long canine teeth.</p> <p>Cougars live in a wide range of vegetation. Cover, in the form of vegetation and irregular landscape is important to cougars. Even where their home ranges overlap, cougars avoid each other. Adults of both sexes travel alone, except when mating or when females are accompanied by their kittens. Because cougars reside at the top of the food chain, healthy cougar populations are good indicators of healthy and balanced ecosystems.</p> <p>Like all cats, cougars hunt more by sight and hearing than by scent. They stalk their prey to within two or three great leaps and then launch a lightening-fast charge that ends with the cougar striking the prey with full impact of the charge and bearing it to the ground. Cougars hunt deer, elk, and moose calves. They will also hunt small mammals such as porcupines, beavers, coyotes, snowshoe hares, ground squirrels, and birds. Cougars typically kill their own food. Scavenging or eating dead animals is rare.</p> <p>In places where cougar hunting is allowed, it is the most common cause of death. Since cougars frequently kill prey larger than themselves, they are continually exposed to the risk of serious injuries, which eventually take their toll. The cougar has virtually disappeared in the east. Fortunately, sufficient wilderness remained in the west and enabled the cougar to survive.</p>		

Figure A-13 The Cougar

		 <p>FRONT ABOUT 7 cm LONG 7.6 cm WIDE</p> <p>HIND ABOUT 17 cm LONG 13 cm WIDE</p>
THE BEAVER	BEAVER LOCATIONS	BEAVER TRACKS
<p>Canadian Wildlife Service & Canadian Wildlife Federation, 2003, <i>Hinterland Who's Who - Mammal Fact Sheets</i>. Retrieved 25 April 2007, from http://www.hww.ca/hww2p.asp?id=102&cid=0</p>	<p>Canadian Wildlife Service & Canadian Wildlife Federation, 2003, <i>Hinterland Who's Who - Mammal Fact Sheets</i>. Retrieved 25 April 2007, from http://www.hww.ca/hww2p.asp?id=102&cid=0</p>	<p>Canadian Wildlife Service & Canadian Wildlife Federation, 2003, <i>Hinterland Who's Who - Mammal Fact Sheets</i>. Retrieved 25 April 2007, from http://www.hww.ca/hww2p.asp?id=102&cid=0</p>

The beaver is the largest rodent in North America. An adult beaver has a tail that is approximately 30 cm long, will weigh 16 to 32 kg (35 to 70 lbs) and can measure up to 1.3 m long. The beaver is normally brown and very round and compact. It is very slow on land but an excellent swimmer. It can swim about 7 km per hour if it is alarmed. The beaver has very large hind feet, which help it swim. It can use its paws to carry sticks, stones and mud. Their paws are also a great help in construction.

The beaver is commonly found in forested areas where water is present or nearby. It spends the majority of its life logging. One beaver will cut down an average of 216 trees a year. It can cut a tree 40 cm in diameter! A single beaver will usually cut one tree, but sometimes two will work on a large one. In the winter, the beaver's main diet is sticks. It will shift from a wood to a herbivore diet when spring arrives and new growth appears. In the summer, the beaver will eat grasses, herbs, leaves of woody plants, fruits and aquatic plants.

The beaver is a superb builder. Its best-known structure, the dam, is only built by beavers that need to enlarge their underwater habitat that will be open to them in the winter. The dam creates a deep pond that will not freeze to the bottom, which provides storage for winter food and year-round underwater access secure from predators.

The beaver's tail has important uses both in the water and on land. It may be 30 cm long, up to 18 cm wide and 4 cm thick. It is covered with leathery scales and coarse hairs and is very muscular. The beaver uses its tail as a rudder in the water. It also serves as a counterbalance and support when it is walking on its hind legs while carrying building materials like mud, stones, or branches with its front paws.

The beaver falls prey to wolves, coyotes, bears, lynx and wolverines when looking for food on the shore or travelling over land.

The beaver has had a great influence on Canada's history. Canadians now celebrate the beaver as a national symbol on stamps, coins and emblems. There are also hundreds of Canadian lakes, towns, rivers and hill ranges that bear the name of this great rodent.

Figure A-14 The Beaver



Figure A-15 The Coyote

		 <p>FRONT ABOUT 5 cm</p> <p>HIND ABOUT 7.5 cm</p>
<p>THE PORCUPINE</p> <p><i>Bowers, N., Bowers, R., and Kaufman, K., Kaufman Focus Guides: Mammals of North America, Houghton Mifflin Company (p. 108)</i></p>	<p>PORCUPINE LOCATIONS</p> <p><i>Canadian Wildlife Service & Canadian Wildlife Federation, 2003, Hinterland Who's Who - Mammal Fact Sheets. Retrieved 25 April 2007, from http://www.hww.ca/hww2p.asp?id=102&cid=0</i></p>	<p>PORCUPINE TRACKS</p> <p><i>Bowers, N., Bowers, R., and Kaufman, K., Kaufman Focus Guides: Mammals of North America, Houghton Mifflin Company (p. 108)</i></p>
<p>The porcupine has a short, blunt-nosed face with small eyes. Its ears are small and round, almost concealed by its hair. The porcupine has humped shoulders and short legs. It is Canada's second largest rodent, next to the beaver. Adult males reach an average weight of 12 lbs (5.5 kg) after six years, whereas females will reach about 10 lbs (4.5 kg). The total length averages 68–100 cm and the height at the shoulders is about 30 cm. The porcupine has a coat comprised of a soft, brown, woolly undercoat and coarse, long guard hairs. At the base, each guard hair is brown, and becomes darker near the tip. The tip may be different colours in different places—white in eastern areas and yellow in western areas.</p> <p>The porcupine can be found in most areas and spends the majority of winter in a den. The porcupine feeds largely on the inner bark of trees in winter as well as a variety of plants. One of the best-known and least-liked eating habits is that of chewing wood and leather in and around camps. When human-made objects are not available, the porcupine will chew bones and cast-off antlers.</p> <p>On the porcupine's face the quills are about 1.2 cm long; on the back they can be up to 12.5 cm in length. There are no quills on the muzzle, legs, or under parts of the body. These quills are hollow and are embedded in the skin. When alarmed, a small muscle that is attached to each quill pulls it upright in the fur. About 0.6 cm from the tip, the quill tapers to a fine point that is covered by several dozen small black barbs. These barbs feel slightly rough to the touch, but when they are moist (as they get when embedded in the flesh), they swell and work the quill further in. The porcupine has been estimated to have over 30 000 quills. When quills are lost, they are replaced by new quills, which are white and sharp and remain firmly anchored in the skin until they are fully grown. When in danger, the porcupine will first try to escape. When escape is not an option, the porcupine will hump its back and tuck its head between the shoulders. With all quills erect, it will pivot on its front feet, keeping its back to the enemy. As the back feet stomp around, the tail will be lashed around. The momentum of the tail detaches the loose quills, which fly through the air giving the impression that they were thrown.</p> <p>Porcupine quills have been found embedded in several predators including the coyote, cougar, bobcat, red fox, lynx, bear and wolf. Some more experienced predators learn to avoid the quills and kill the porcupine by biting its head or by flipping it and exposing its unprotected belly. Being short-sighted and a slow mover, the porcupine is a frequent victim in forest fires and on roadways.</p>		

Figure A-16 The Porcupine

PROVINCIAL/TERRITORIAL

WILDLIFE WORKSHEET

NAME OF WILDLIFE:

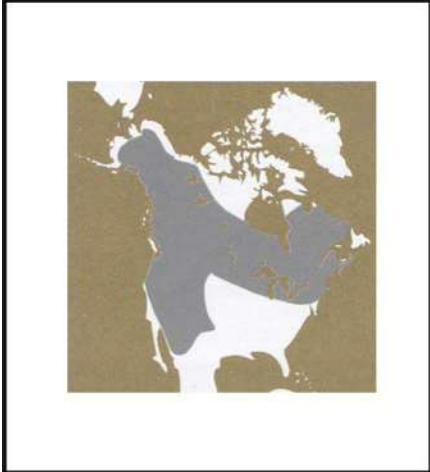
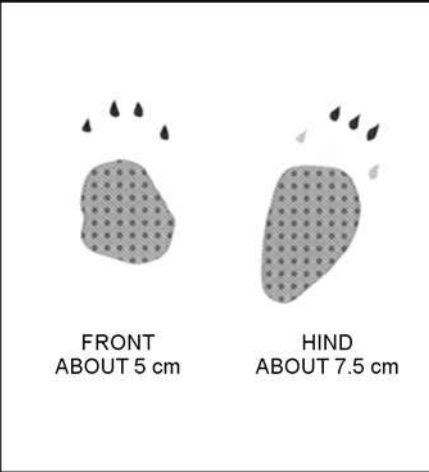
GENERAL DESCRIPTION:

HABITAT:

DIET:

UNIQUE CHARACTERISTICS:

THIS PAGE INTENTIONALLY LEFT BLANK



ROYAL CANADIAN ARMY CADETS

RED STAR

INSTRUCTIONAL GUIDE



SECTION 4

EO M221.04 – PERFORM BASIC FIRST AID

Total Time:

30 min

PREPARATION

PRE-LESSON INSTRUCTIONS

Resources needed for the delivery of this lesson are listed in the lesson specification located in A-CR-CCP-702/PG-001, Chapter 4. Specific uses for said resources are identified throughout the Instructional Guide within the TP for which they are required.

Review the lesson content and become familiar with the material prior to delivering the lesson.

PRE-LESSON ASSIGNMENT

N/A.

APPROACH

A demonstration was chosen for TP1 and TP2 as it allows the instructor to explain and demonstrate the skills the cadet is expected to acquire.

A performance was chosen for TP3 as it provides an opportunity for the cadets to practice basic first aid under supervision.

INTRODUCTION

REVIEW

N/A.

OBJECTIVES

By the end of this lesson the cadet shall be expected to perform basic first aid for minor wounds and first-degree burns.

IMPORTANCE

It is important for cadets to be able to treat minor wounds and first-degree burns in a field setting. Basic first aid training gives cadets basic knowledge and skills which, if applied correctly, may prevent further injuries and discomfort to the injured.

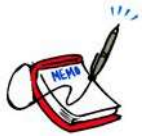

Knowing what to do during a first aid situation is important. However, cadets shall seek a qualified first-aider whenever an injury occurs.

Teaching Point 1

Identify and Treat Minor Wounds

Time: 5 min

Method: Demonstration

MINOR WOUNDS

Minor wounds are those that do not have severe bleeding. Bleeding wounds can be internal (inside the body) or external (outside the body). Some common external bleeding wounds are:

- abrasions and scrapes; and
- cuts.

Almost any external bleeding wound can be serious. There is always a risk of infection when the skin's top layer is broken. Knowing how to identify and treat minor wounds is essential to reduce the risk of infection or aggravation.

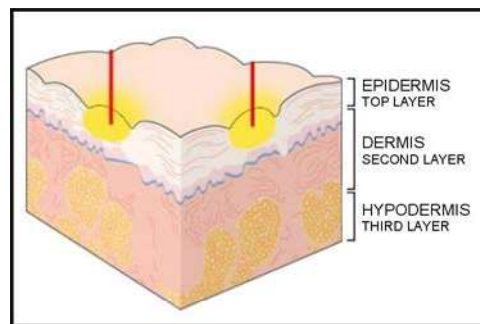

Figure 1 Layers of Skin

Irishhealth.com, Copyright 2007 by Irishhealth.com. Retrieved 17 March 2007, from <http://irishhealth.com/indez.html?level=4&con=467>

Abrasions and Scrapes

Abrasions are located on the top layer of the skin. They occur when the skin is scraped or rubbed away and are often painful. The skin may bleed small amounts of blood.

Cuts

Cuts are breaks in the top or second layer of the skin. There is often some minor bleeding involved.



Figure 2 Leg Scrape

TheFatManWalking.com, Copyright 2006 by The FatManWalking.com. Retrieved 6 March 2007, from <http://www.thefatmanwalking.com/page/65492/?jsessionid=mni5xlvdqm9>

TREATMENT OF MINOR WOUNDS

Emergency care for treating minor wounds has three basic objectives:

- to control bleeding;
- to prevent further injury; and
- to reduce the risk of infection.



A cadet should help with a demonstration on the principles of cleaning and treating a wound.

Follow the principles listed below when cleaning and treating a minor wound, to avoid infection.

1. Wash hands with soap and water and put gloves on, if available.
2. Do not cough or breathe directly over the wound.
3. Fully expose the wound, without touching it.
4. Gently wash loose material from the surface of the wound. Wash and dry the surrounding skin with clean dressings, cleaning the wound with clean gauze wiping from the centre of the wound to the edge of the wound. (An antibiotic cream can be used on surface wounds and abrasions).
5. Cover the wound promptly with a sterile dressing.
6. Tape the dressing in place.
7. Remove and dispose of the gloves and wash your hands and any other skin area that may have been in contact with the casualty's blood.



Figure 3 Washing the Wound

Medline Plus, Medical Encyclopedia, Copyright 2007 by US National Library of Medicine. Retrieved 19 March 2007, from http://www.nlm.nih.gov/medecineplus/ency/presentations/100208_4.htm



Figure 4 Dressing and Taping the Wound

Medline Plus, Medical Encyclopedia, Copyright 2007 by US National Library of Medicine. Retrieved 19 March 2007, from http://www.nlm.nih.gov/medecineplus/ency/presentations/100208_4.htm

CONFIRMATION OF TEACHING POINT 1

QUESTIONS

- Q1. Which layer of skin can be affected by a minor wound?
- Q2. What is the first thing to do before treating a minor wound?
- Q3. When washing the wound, what motion should be used?

ANTICIPATED ANSWERS

- A1. Epidermis or top layer can be affected by a minor wound .
- A2. Wash hands with soap and put on gloves.
- A3. Wipe away from the centre of the wound to the edge of the wound.

Teaching Point 2**Identify Types of Burns and Treat First-degree Burns**

Time: 10 min

Method: Demonstration

TYPE OF BURNS

Figure 5 Types of Burns

Medline Plus, Medical Encyclopedia, Copyright 2007 by US National Library of Medicine. Retrieved 19 March 2007, from http://www.nlm.nih.gov/medecineplus/ency/presentations/100208_4.htm

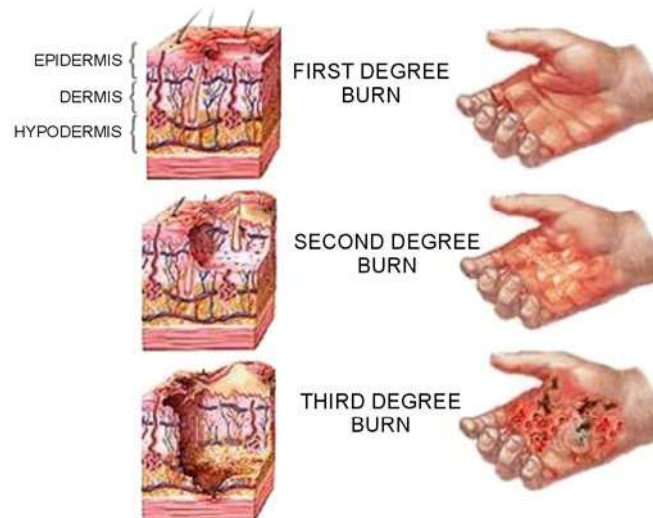

Ask cadets for the signs and symptoms of the various types of burns.

First-degree Burns

These are also called superficial burns and only affect the top layer of skin. Hot liquids, heat, and the sun are the main causes.

Signs and symptoms of a first-degree burn include:

- pinkish-reddish skin;
- slight swelling of the area;
- mild to moderate pain in the area; and
- sore, dry skin.



Figure 6 First-degree Burn

Trip Report-World Championship in Japan. Retrieved 17 March 2007, from http://homepages.paradise.net.nz/mischief/cp_japan_trip_report.html

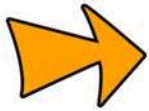

Cadets who have been sunburned have had a first-degree burn.

Second-degree Burns

These affect the second layer of skin. Hot liquids, the sun, chemicals, and fire are the main causes.

Signs and symptoms of a second-degree burn include:

- raw-looking, moist skin;
- skin colouring that may range from white to cherry red;
- blisters containing clear fluid; and
- extreme pain in the area.



Figure 7 Second-degree Burn

Sickkids.ca. Copyright 1999 by The Hospital for Sick Children. Retrieved 6 March 2007, from <http://www.sickkids.ca/plasticsurgery/section.asp?s=Burns&slD=4489&ss=About+Burns&ssID=4496>

Third-degree Burns

These affect the third layer of skin and can extend into the muscle. Contact with extreme heat sources (e.g. hot liquids and solids, direct flame, chemicals) and electricity are the main causes.

Signs and symptoms of a third-degree burn include:

- dry, leathery skin;
- pearly white, tan, grey, or charred black skin;
- blood vessels or bone may be visible,
- little or no pain (nerves are destroyed);
- breathing problems; and
- shock.



Figure 8 Third-degree Burn

Sickkids.ca. Copyright 1999 by The Hospital for Sick Children. Retrieved 6 March 2007, from <http://www.sickkids.ca/plasticsurgery/section.asp?s=Burns&slD=4489&ss>About+Burns&sslD=4496>

TREATMENT OF FIRST-DEGREE BURNS



All burns should be brought immediately to a qualified first-aider.

A cadet should help with a demonstration on the principles of cleaning and treating a burn.

Heat Burns

These are the most common types of burns, and are caused by sources of heat such as flames from stoves, lanterns, and fires. A scald is a heat burn caused by hot liquid or steam.

To treat a heat burn:

1. Immerse the burn in cool water (if this is not possible, flush the burn with cool water and cover it with a clean, wet cloth).
2. Cool the burn until the pain is reduced.
3. Avoid the affected area.

4. When the pain has lessened, cover the burn with a clean, lint-free dressing.
5. Seek medical attention, if necessary.



Figure 9 Cooling the Burn

Medline Plus, Medical Encyclopedia, Copyright 2007 by US National Library of Medicine. Retrieved 19 March 2007, from http://www.nlm.nih.gov/medecineplus/ency/presentations/100213_1.htm



Figure 10 Dressing the Burn

Medline Plus, Medical Encyclopedia, Copyright 2007 by US National Library of Medicine. Retrieved 19 March 2007, from http://www.nlm.nih.gov/medecineplus/ency/presentations/100213_1.htm

Sunburns. These are also called radiation burns. Sunburns are caused by over-exposure to sunlight and can be prevented by wearing sunscreen of a high sun protection factor (SPF), long sleeves, and wide-brimmed hats. Sunburns range from mild to serious.

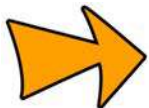

SPF indicates the time a person using sunscreen can be exposed to sunlight before getting a sunburn. For example, a person who would normally burn after 12 minutes in the sun would expect to burn after 120 minutes if protected by a sunscreen with SPF 10.

The higher the SPF, the more protection a sunscreen offers against ultraviolet radiation (UV).

To treat a minor sunburn:

- seek shade;
- gently sponge the area with cool water;
- cover the area with a cool wet towel;
- repeat as needed to relieve pain;

- pat the skin dry;
- apply medicated sunburn lotion (ointment); and
- seek medical attention, if necessary.



Blisters caused by sunburns should not be broken.

Fevers and vomiting indicate serious sunburn and medical attention should be sought immediately.

CONFIRMATION OF TEACHING POINT 2

QUESTIONS

- Q1. What is the most common first-degree burn a cadet can suffer?
- Q2. Name two signs or symptoms of a third-degree burn.
- Q3. What is the first thing to do in a case of heat burn?

ANTICIPATED ANSWERS

- A1. Sunburn.
- A2. Dry, leathery skin; pearly white, tan, grey, or charred black skin; blood vessels or bone may be visible; little or no pain (nerves are destroyed); breathing problems and shock.
- A3. Immerse the burn in cool water, flush the burn with cool water or apply a wet cloth. The burn should be cooled until the pain is reduced.

Teaching Point 3

Perform Basic First Aid

Time: 10 min

Method: Performance

ACTIVITY

OBJECTIVE

The objective of this activity is to allow cadets to practice performing basic first aid on simulated minor wounds and burns.

RESOURCES

- Gauze;
- Gloves;
- Scissors;
- Sterile dressing; and
- Tape.

ACTIVITY LAYOUT

N/A.

ACTIVITY INSTRUCTIONS

1. Divide cadets into pairs.
2. Have one cadet perform first aid for a minor wound (arm or hand) and after, have the other cadet perform first aid for a burn (arm or hand).
3. Rotate through the pairs and make corrections as required.
4. Upon completion, review procedures for treating a minor wound and a first-degree burn.

SAFETY

N/A.

END OF LESSON CONFIRMATION

The cadets' participation in the in-class activity in TP3 will serve as the confirmation of this lesson.

CONCLUSION

HOMEWORK/READING/PRACTICE

N/A.

METHOD OF EVALUATION

N/A.

CLOSING STATEMENT

On expeditions, injuries can occur quickly and without warning. The ability to react quickly by providing on-site help will reduce the discomfort level of the injured person until medical attention is available.

INSTRUCTOR NOTES/REMARKS

N/A.

REFERENCES

C0-102 (ISBN 1-894070-56-9) St. John Ambulance. (2006). *First Aid Training: First on the Scene Student Reference Guide*. Ottawa, ON: St. John Ambulance.

C0-123 St. John Ambulance Canada. (2004). *Seasonal Safety Tips: September 2004 Be Casual, Not a Casualty*. Retrieved 27 February 2007 from http://www.sja.ca/English/safety_tips/September.asp.



ROYAL CANADIAN ARMY CADETS

RED STAR

INSTRUCTIONAL GUIDE

SECTION 5

EO M221.05 – TIE KNOTS



Total Time:

90 min

PREPARATION

PRE-LESSON INSTRUCTIONS

Resources needed for the delivery of this lesson are listed in the lesson specification located in A-CR-CCP-702/PG-001, Chapter 4. Specific uses for said resources are identified throughout the Instructional Guide within the TP for which they are required.

Review the lesson content and become familiar with the material prior to delivering the lesson.

Make copies of knot-tying instructions, located at Annex A.

PRE-LESSON ASSIGNMENT

N/A.

APPROACH

A practical activity was chosen for TP1 as it is an interactive way to allow cadets to experience tying knots. This activity contributes to the development of knot-tying skills and knowledge in a fun and challenging setting.

Demonstration and performance was chosen for TP2 and TP3 as it allows the instructor to explain and demonstrate knot-tying while providing an opportunity for the cadets to practice knot-tying under supervision.

INTRODUCTION

REVIEW

N/A.

OBJECTIVES

By the end of this lesson the cadet shall be expected to coil a rope and tie the following knots:

- bowline;
- fisherman's knot;
- double fisherman's knot; and
- double overhand running knot.

IMPORTANCE

It is important for cadets to know how to tie knots and work with rope. Knots can be used during field training, for building shelters, securing equipment, and also in everyday life.

Teaching Point 1

Review Green Star Knots

Time: 20 min

Method: Practical Activity



Refer to EO M121.03 (Tie Knots and Lashings) for knot-tying instructions.

ACTIVITY

OBJECTIVE

The objective of this activity is to review knots instructed in Green Star. The cadets must have a good knowledge of these knots before moving on to other knots.

RESOURCES

- Six pieces of rope for tying knots (per group);
- Six railings or dowels for tying hitches;
- Sheet of flipchart paper/blackboard/whiteboard; and
- A marker/chalk.

ACTIVITY LAYOUT

An area must be chosen, large enough to accommodate the entire group.

ACTIVITY INSTRUCTIONS

1. On a sheet of flipchart paper/blackboard/whiteboard write the following knots:
 - thumb (overhand);
 - reef (square);
 - figure of eight;
 - double figure of eight;
 - clove hitch; and
 - half hitch.
2. Divide the cadets into equal groups of no more than ten cadets.
3. Within each group, pair up the cadets. If there is an uneven number, a person will have to be paired up twice, so that everyone has a partner. Pairs must have the same dominant hand (two right-handed cadets or two left-handed cadets).

4. All cadets are to stand in line, in their groups, facing their partner.
5. Once instructed to begin, each pair of cadets will begin to tie the listed knots (in the order that they appear). Each cadet will only be allowed to use their dominant hand to tie the knots. The pair will have to work together, both only with one hand.
6. Knot-tying will begin with the first pair. Once they have the knot tied, they will untie it, and then pass the rope to the next pair in their group. Upon receiving the rope, the next pair may begin to tie the first knot. The first pair will tie the next knot on the list, then untie it, and pass the piece of rope down, and so on. Pairs may begin tying as soon as they have been given the rope.
7. Once all knots have been tied, the pair may sit and begin to cheer on the rest of their group.



If there are an uneven number of cadets, the cadets who will be in two groups should be placed at the front of the line and the other cadets should be placed at the back. Once the first pairs are finished, the cadets can move to the back to complete the activity again.

SAFETY

N/A.

CONFIRMATION OF TEACHING POINT 1

The cadets' participation in the activity will serve as the confirmation of this TP.

Teaching Point 2

Explain the Uses of, Demonstrate, and Allow Time to Practice Tying Knots

Time: 50 min

Method: Demonstration and Performance



Provide an explanation and demonstration of the complete knot and then break the knot down into its steps.

Provide a demonstration of each step and have the cadets complete each step. Ensure the cadets have enough time to complete each step.

Each knot must be instructed individually. Distribute handouts with tying instructions (located at Annex A).

A review of the parts of a rope, from EO M121.03 (Tie Knots and Lashings) may be required before beginning TP2.

BOWLINE

Uses. In climbing, it is used as a safety measure during ascent and is clipped into the carabiner. It is often called the rescue knot because it makes a simple loop that does not slip. It can be used to tie around yourself, to throw to someone who needs a lifeline, or to secure objects (such as canoes to a wharf).

Qualities. It does not slip, come loose, or jam.

Faults. It is difficult to untie when the rope is under strain.

Procedure

1. With the standing part of the rope away from you, take the working end in your right hand and place it on top of the standing part.
2. Put your thumb under the standing part.
3. Twist your right hand 180 degrees away from you, to form a simple over hand loop (looks like a number six), and pull the working end up through.
4. Take the working end round behind the standing part.
5. Bring the working end down through the loop. Tighten the bowline by holding on to the bight formed by the end and pulling hard on the standing part.

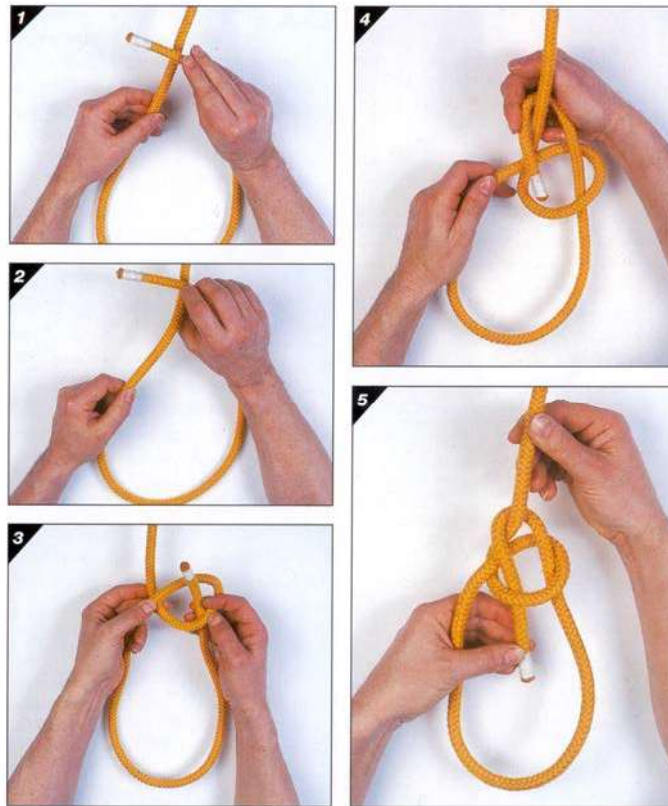

Figure 1 Bowline

Pawson, D., Pocket Guide to Knots & Splices, Chartwell Books, Inc. (p. 164)

FISHERMAN'S KNOT

Uses. To join two pieces of rope together. It is commonly used by anglers and climbers.

Qualities. It does not slip, come loose, or jam.

Faults. It is difficult to untie when fine rope is used.

Procedure

1. Lay the ropes alongside each other, end to end. Take one of the ropes and bring it over the other and under itself.
2. Make an overhand knot around the second rope.
3. Make an overhand knot around the standing part of the first rope.
4. Slide together to complete the knot.
5. Tighten to finish the fisherman's knot.
6. Tape ends if used in climbing to avoid slipping.

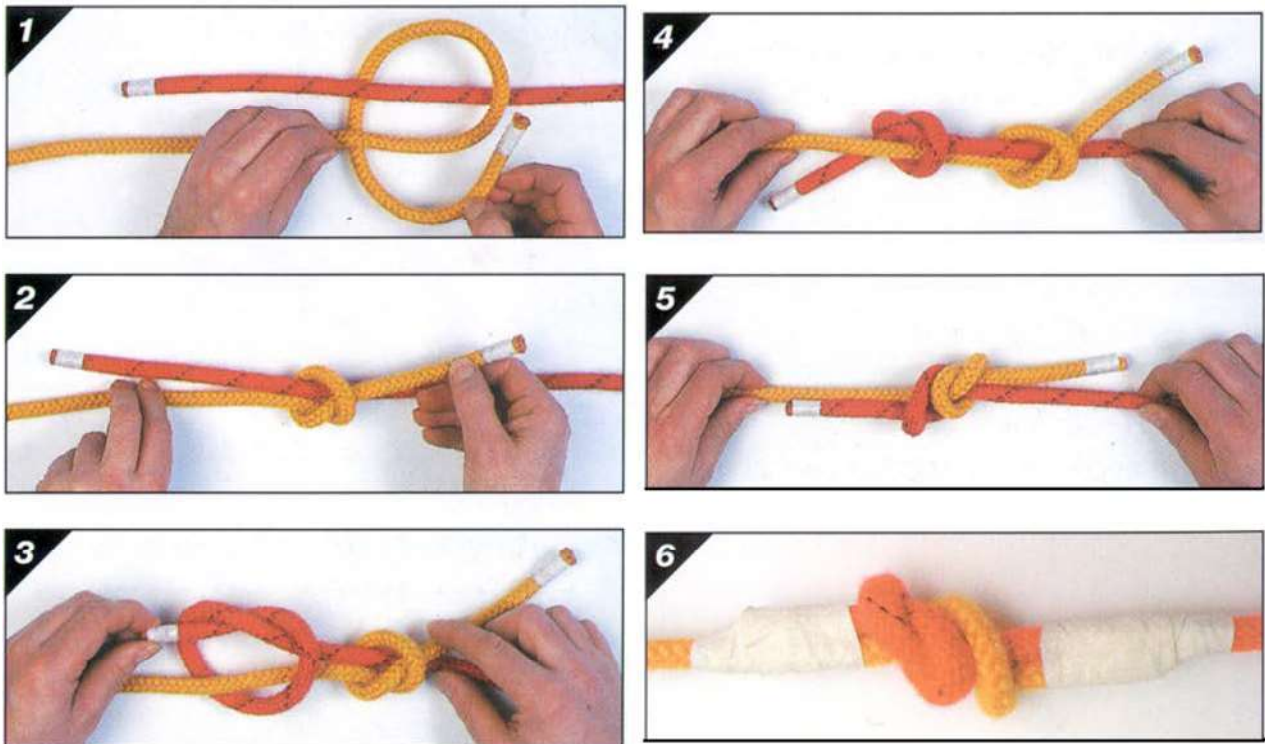

Figure 2 Fisherman's Knot

Pawson, D., Pocket Guide to Knots & Splices, Chartwell Books, Inc. (p. 116)

DOUBLE FISHERMAN'S KNOT

Uses. To join two pieces of rope together. It is commonly used by anglers and climbers. It is ideal for slippery line or rope.

Qualities. It does not slip, come loose, or jam.

Faults. It is difficult to untie when fine rope is used.

Procedure

1. With the first rope, make a double overhand knot around the body of the second rope.
2. Make a double overhand knot around the body of the first rope.
3. Pull tight and slide together. The knots should make “X’s” on the same side.

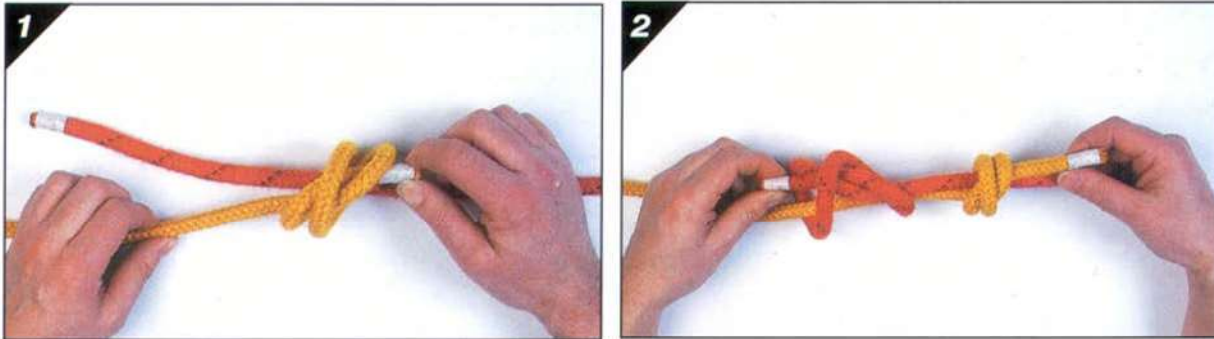

Figure 3 Double Fisherman's Knot Steps 1 and 2

Pawson, D., Pocket Guide to Knots & Splices, Chartwell Books, Inc. (p. 117)



Figure 4 Double Fisherman's Knot Step 3

40th Fife Scout Troop, 2007, Knotting the Thumb Knot. Retrieved 3 May 2007, from <http://www.users.zetnet.co.uk/whitelaw/knots/dfish.jpg>

DOUBLE OVERHAND RUNNING KNOT

Uses. This sliding loop grips tightly around an object. It is ideal for fixing a lanyard fast to the arms of sunglasses or spectacles so they can hang around a person's neck when not in use.

Procedure

1. Make a loop with a fairly long working end on top.
2. With fingers parallel to the standing part, wrap around the standing part three times.
3. Put the working end down through the “tunnel” where the fingers are.
4. Tighten the turns by pulling on the working end, working the turns snugly together.

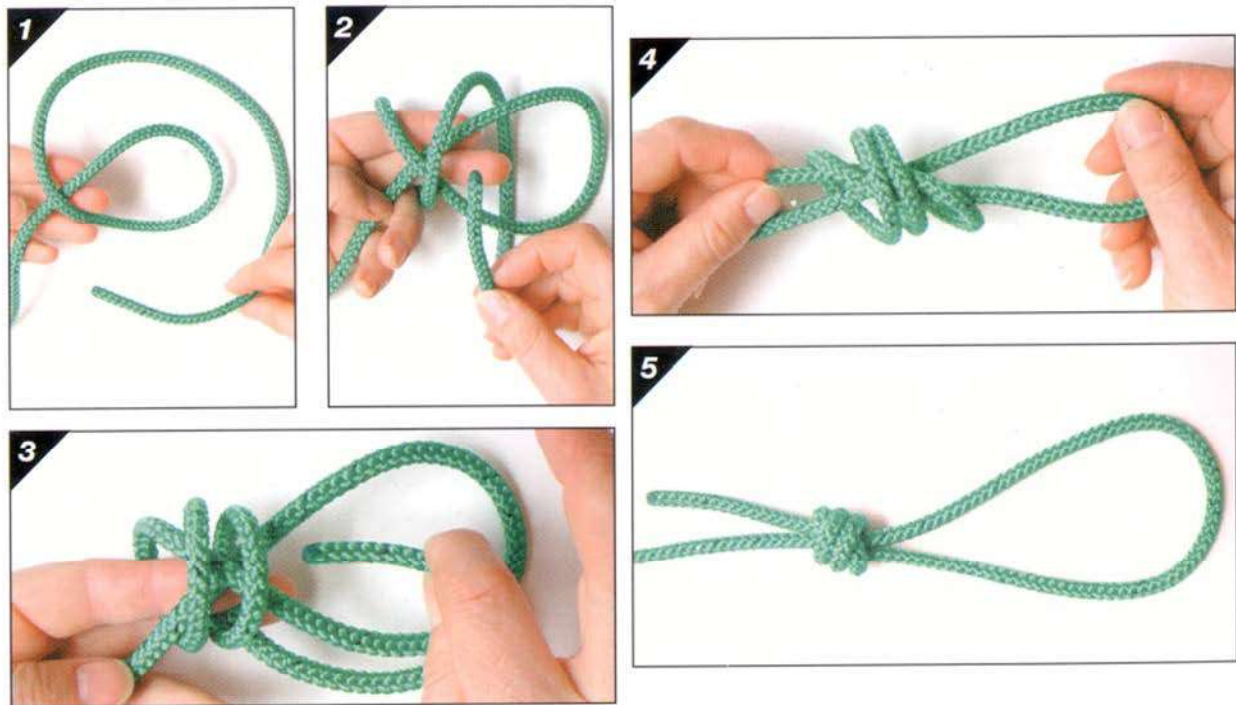

Figure 5 Double Overhand Running Knot

Pawson, D., Pocket Guide to Knots & Splices, Chartwell Books, Inc. (p. 177)



The same knot must be made at the other end of the rope in order to fix it to the arms of sunglasses or spectacles. When two knots are made, the knots can be easily adjusted by pulling on each end to the desired length.

CONFIRMATION OF TEACHING POINT 2

Tie the following knots:

- bowline;
- fisherman's knot;
- double fisherman's knot; and
- double overhand running knot.

Teaching Point 3

Explain the Uses of, Demonstrate, and Allow Time to Practice Coiling a Rope

Time: 10 min

Method: Demonstration and Performance

COILING A ROPE

Ropes should always be coiled because it makes rope storage neat and compact. Otherwise, they will become a mass of knots and tangles. Any rope that is being coiled should be clean and ready to be put away.

Procedure

1. Coiling will be clockwise; however, this may differ for left-handed people. Run your coiling hand (dominant) along the rope until you have about an arm span of rope.
2. Bring your dominant hand towards your holding hand and use your index finger and thumb to twist the line in the direction that the coil is going. Normally, a 180 degree or 360 degree twist will suffice. This will ensure that the rope does not twist or kink when in the coil.
3. Lay the rope into your holding hand. There should be no kinks in the coil.
4. Steps 1–3 will be repeated until there is approximately one metre of rope left.
5. Take the last length of rope and wrap it three or four times around the outside of the coils that were previously made.
6. Make a loop with the remaining rope and thread it through the upper area between the coils and the wraps (not all the way).
7. Open the loop over the top of the coil.
8. Tighten the loop by pulling on its end. The rope is now coiled.



Figure 6 Coiling a Rope

Bigon, M. and Regazzoni, G. The Morrow Guide to Knots, Quill/William Morrow (p. 23)

The dominant hand will be the coiling hand; the non-dominant hand will hold the coiled rope. Prior to beginning, take one end of the rope into the non-dominant hand. Let the end fall about six inches out of your hand, towards you.

CONFIRMATION OF TEACHING POINT 3

The cadets' participation in coiling a rope will serve as the confirmation of this TP.

END OF LESSON CONFIRMATION

The cadets' participation in tying knots and coiling a rope will serve as the confirmation of this lesson.

CONCLUSION

HOMEWORK/READING/PRACTICE

N/A.

METHOD OF EVALUATION

N/A.

CLOSING STATEMENT

Knowing what knots to tie when situations arise is an important aspect of field training and can also be used in everyday life. Being able to construct a quality knot will prove useful in a variety of situations such as climbing, towing, and even making a glasses strap or a strap for sunglasses when other means are not available.

INSTRUCTOR NOTES/REMARKS

N/A.

REFERENCES

C2-007 (ISBN 0-7858-1446-9) Pawson, D. (2001). *Pocket Guide to Knots and Splices*. Edison, NJ: Chartwell Books, Inc.

C2-073 (ISBN 0-688-01226-4) Bigon, M. and Regazzoni, G. (1982). *The Morrow Guide to Knots*. New York, NY: Quill/William Morrow.

THIS PAGE INTENTIONALLY LEFT BLANK

KNOT-TYING INSTRUCTIONS

BOWLINE

Uses. In climbing, it is used as a safety measure during ascent and is clipped into the carabiner. It is often called the rescue knot because it makes a simple loop that does not slip. It can be used to tie around yourself, to throw to someone who needs a lifeline, or to secure objects (such as canoes to a wharf).

Procedure

1. With the standing part of the rope away from you, take the working end in your right hand and place it on top of the standing part.
2. Put your thumb under the standing part.
3. Twist your right hand 180 degrees away from you, to form a simple over hand loop (looks like a number six), and pull the working end up through.
4. Take the working end round behind the standing part.
5. Bring the working end down through the loop. Tighten the bowline by holding on to the bight formed by the end and pulling hard on the standing part.

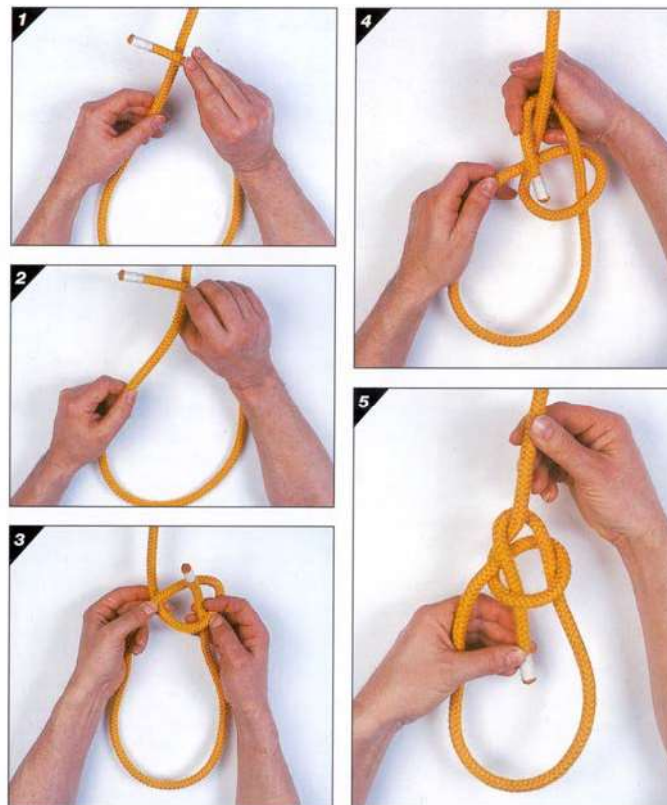

BOWLINE

Figure A-1 Bowline

Pawson, D., Pocket Guide to Knots & Splices, Chartwell Books, Inc. (p. 164)

FISHERMAN'S KNOT

Uses. To join two pieces of rope together. It is commonly used by anglers and climbers.

Procedure

1. Lay the ropes alongside each other, end to end. Take one of the ropes and bring it over the other and under itself.
2. Make an overhand knot around the second rope.
3. Make an overhand knot around the standing part of the first rope.
4. Slide together to complete the knot.
5. Tighten to finish the fisherman's knot.
6. Tape ends if used in climbing to avoid slipping.

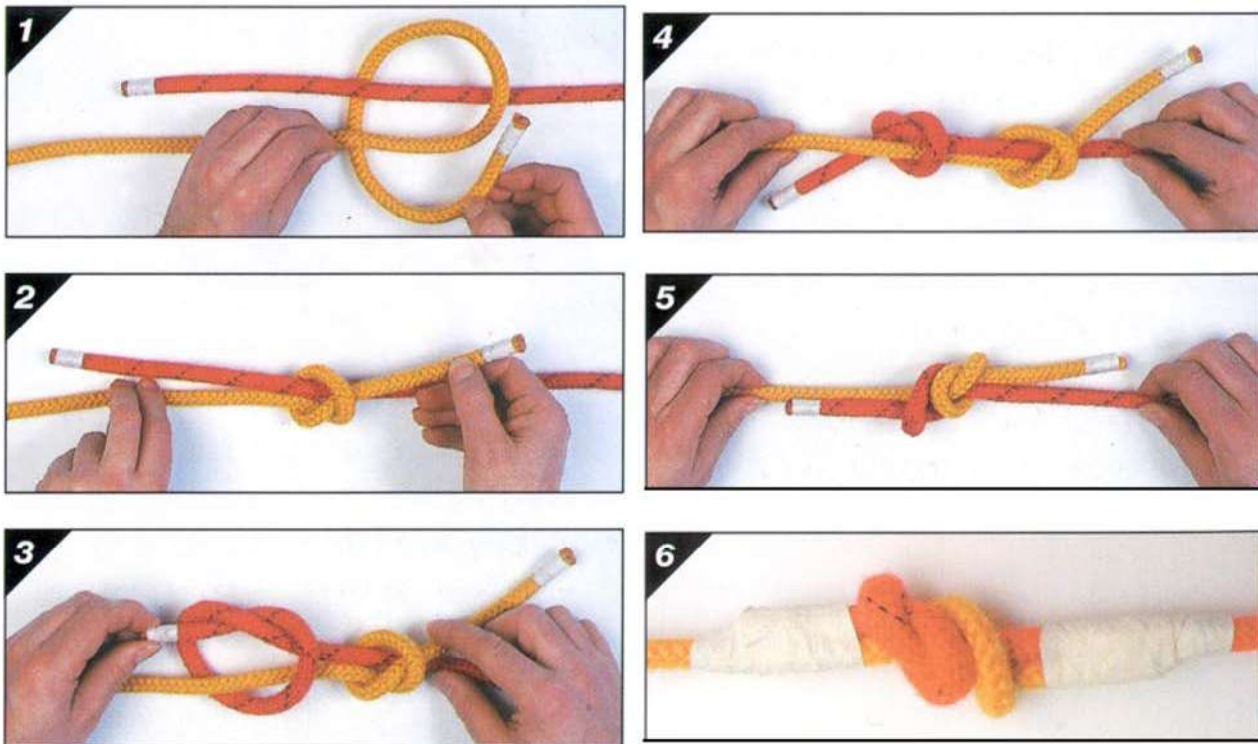

FISHERMAN'S KNOT

Figure A-2 Fisherman's Knot

Pawson, D., Pocket Guide to Knots & Splices, Chartwell Books, Inc. (p. 116)

DOUBLE FISHERMAN'S KNOT

Uses. To join two pieces of rope together. It is commonly used by anglers and climbers. It is ideal for slippery line or rope.

Procedure

1. With the first rope, make a double overhand knot around the body of the second rope.
2. Make a double overhand knot around the body of the first rope.
3. Pull tight and slide together. The knots should make "X's" on one side.

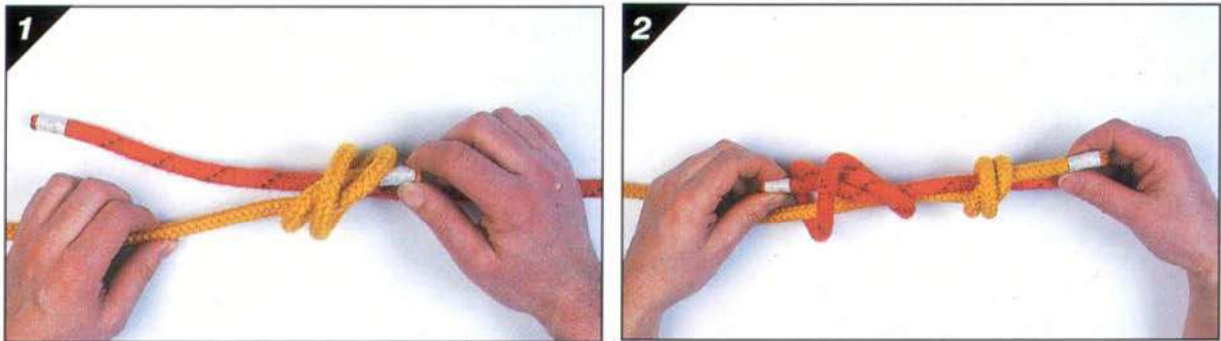

STEPS 1 AND 2

Pawson, D., Pocket Guide to Knots & Splices, Chartwell Books, Inc. (p. 117)



STEP 3

40th Fife Scout Troop, 2007, Knotting the Thumb Knot. Retrieved 3 May 2007, from <http://www.users.zetnet.co.uk/whitelaw/knots/dfish.jpg>

Figure A-3 Double Fisherman's Knot

DOUBLE OVERHAND RUNNING KNOT

Uses. This sliding loop grips tightly around an object. It is ideal for fixing a lanyard fast to the arms of sunglasses or spectacles so they can hang around a person's neck when not in use.

Procedure

1. Make a loop with a fairly long working end on top.
2. With fingers parallel to the standing part, wrap around the standing part three times.
3. Put the working end down through the "tunnel" where the fingers are.
4. Tighten the turns by pulling on the working end, working the turns snugly together.

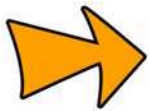

The same knot must be made at the other end of the rope in order to fix it to the arms of sunglasses or spectacles. When two knots are made, the knots can be easily adjusted by pulling on each end to the desired length.

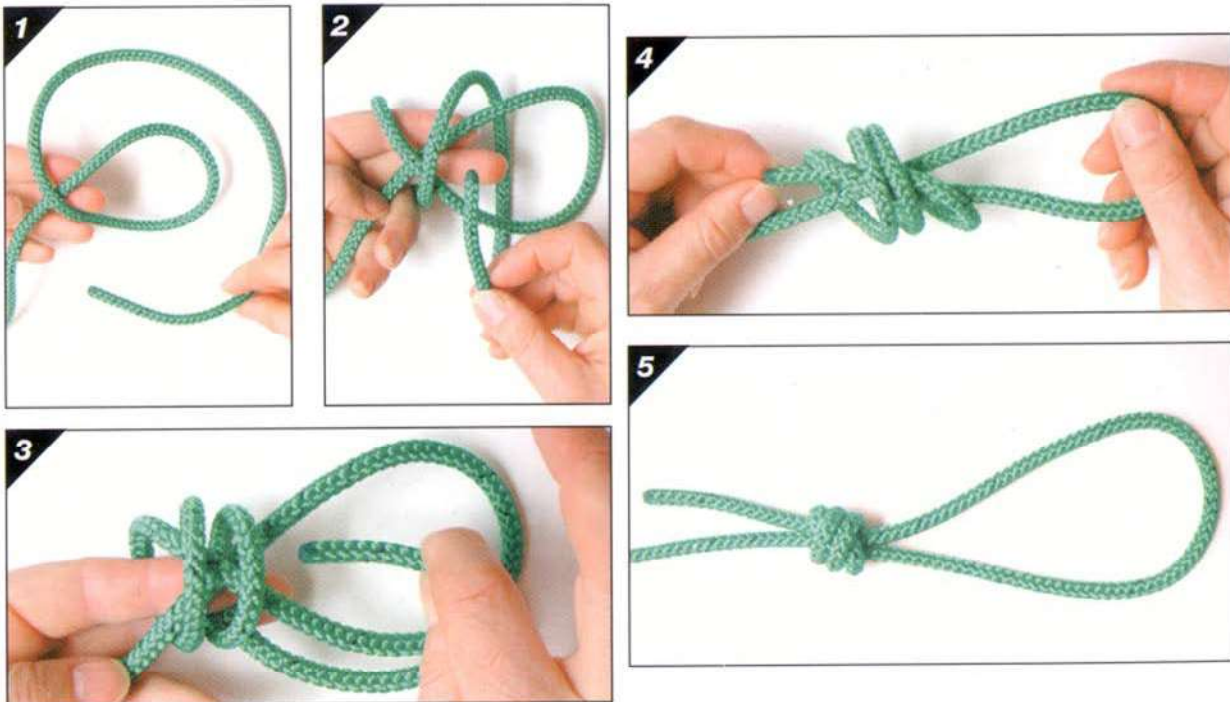

DOUBLE OVERHAND RUNNING KNOT

Figure A-4 Double Overhand Running Knot

Pawson, D., Pocket Guide to Knots & Splices, Chartwell Books, Inc. (p. 117)



ROYAL CANADIAN ARMY CADETS

RED STAR

INSTRUCTIONAL GUIDE



SECTION 6

EO M221.06 – CONSTRUCT A HOOCHIE SHELTER

Total Time:

90 min

PREPARATION

PRE-LESSON INSTRUCTIONS

Resources needed for the delivery of this lesson are listed in the lesson specification located in A-CR-CCP-702/PG-001, Chapter 4. Specific uses for said resources are identified throughout the Instructional Guide within the TP for which they are required.

Review the lesson content and become familiar with the material prior to delivering the lesson.

Prior to the lesson, select a site that exemplifies the factors to consider when selecting a site for a hoochie shelter. A hoochie shelter may be constructed prior to beginning this lesson, for illustration purposes.

PRE-LESSON ASSIGNMENT

N/A.

APPROACH

Interactive lecture was chosen for TP1 to present basic or background material on constructing a hoochie shelter.

Demonstration was chosen for TP2 and TP3 to allow the instructor to explain and demonstrate constructing a hoochie shelter.

Performance was chosen for TP4 as it provides an opportunity for the cadets to practice constructing a hoochie shelter under supervision.

INTRODUCTION

REVIEW

N/A.

OBJECTIVES

By the end of this lesson the cadet shall be expected to construct and tear down a hoochie shelter.

IMPORTANCE

It is important for cadets to know how to construct and tear down a hoochie shelter as a method of creating a minimalist shelter during expeditions. In some instances, during expeditions, cadets may prefer to use a lightweight tarp or hoochie shelter for protection from the elements as well as from insects and animals rather than a tent, which would be much heavier.

Teaching Point 1**Explain Factors to Consider When Selecting a Hoochie Site**

Time: 10 min

Method: Interactive Lecture

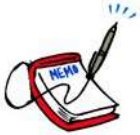

Have a pre-selected site prepared to construct a hoochie shelter. The area must exemplify factors to consider when selecting a hoochie site.

When selecting a site for a hoochie shelter, the following factors should be considered:

- Two trees approximately two metres (six feet) apart, will provide adequate space for a shelter.
- Cover will provide protection from the elements.
- An elevated area will allow for water drainage.
- Flat ground will provide a comfortable sleeping surface.
- A sheltered area will provide protection from the wind and direct sunlight.
- Checking for dead trees and tree limbs in the immediate area will reduce potential dangers and risks.

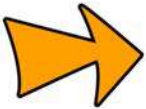

Although trees may offer protection, they can be dangerous. Avoid trees with dead branches or on windswept fields, especially trees that lean at pronounced angles. Check above and around the tent site, as trees and branches may fall and hurt or kill someone.

CONFIRMATION OF TEACHING POINT 1**QUESTIONS**

- Q1. When selecting a site for a hoochie shelter, how far apart should the trees be?
- Q2. Why should the site be on an elevated area?
- Q3. When selecting a site, what should one check for to reduce potential dangers and risks?

ANTICIPATED ANSWERS

- A1. The two trees should be approximately six feet apart.
- A2. An elevated area will allow for water drainage.
- A3. Checking for dead trees and tree limbs in the immediate area will reduce potential dangers and risks.

Teaching Point 2**Explain and Demonstrate the Procedure for Constructing and Tearing Down a Hoochie Shelter**

Time: 20 min

Method: Demonstration



This TP should be delivered as the hoochie shelter is constructed. Demonstrate and explain each step.

A previously constructed shelter may be used for illustration.

CONSTRUCTING A HOOCHIE SHELTER**Checking the Groundsheets**

Prior to commencing construction, all materials should be checked for fatigue and wear, especially the two groundsheets, to include:

- Groundsheets should not have holes that would allow rain or other objects into the completed shelter.
- The rubberized interior coating on groundsheets should be checked for deterioration and flaking, which results from age and being stored when still wet.
- Ensure that the two zippers match up and will form a strong bond. Different manufacturers of the groundsheets may use different zippers, which may not fit together properly.
- Grommets on each groundsheet should be in good repair so they can hold pegs/twine effectively.



Figure 1 Grommet

D Cdts 3, 2006, Ottawa, ON: Department of National Defence

Zippering the Groundsheets Together

The two groundsheets are zipped together to form a sufficient bond. Ensure that the two zippers are the same length and are not worn out because the bond may be compromised.



Figure 2 Zipping Groundsheets

D Cdts 3, 2006, Ottawa, ON: Department of National Defence



Figure 3 Joining Groundsheets

D Cdts 3, 2006, Ottawa, ON: Department of National Defence

Tying the Shelter to Trees

Tie each end of the zipped together groundsheets to the two trees by passing the twine through the grommets located at each end of the zipper. A knot that is reliable and will provide stability shall be used such as clove hitch or the overhand knot. The shelter should be tied as high as the waist of the tallest occupant. If tied to the correct grommets the flap of material over the zipper will naturally sit covering the zipper.



Figure 4 Joined Groundsheets

D Cdts 3, 2006, Ottawa, ON: Department of National Defence



Figure 5 Tying the Shelter to a Tree

D Cdts 3, 2006, Ottawa, ON: Department of National Defence

Securing the Groundsheets Between Trees

The shelter, built at waist height, will allow enough head room for someone to sit upright, when completed. The two groundsheets should be pulled as tight as possible between the two trees. This tightness will prevent rain from collecting and will stop the shelter from sagging after extended use. When tying the shelter, ensure that the flap at the peak of the shelter covers the zipper. Make certain there is enough room on one of the ends for an entrance and exit.



Figure 6 Securing Groundsheets

D Cdts 3, 2006, Ottawa, ON: Department of National Defence



Figure 7 Pegging the Grommets

D Cdts 3, 2006, Ottawa, ON: Department of National Defence

Pegging the Grommets

Two grommets are located down the centre of each groundsheet. Twine may be used to tie these grommets to surrounding trees. To create more space in the shelter, tie the grommets to a branch that crosses the apex of the hoochie or use twine and sticks to peg them into the ground.

Pulling the Groundsheets Taut (Tight)

Any objects that will secure each corner of the groundsheets 5 cm above the ground will be sufficient to use as pegs. After the corners are pegged, peg the remaining grommets on each side. When each side of the shelter is pegged, it should result in a flush, taut surface with no wrinkles. This taut surface will allow for efficient run-off of rain.



Figure 8 Groundsheets Pulled Taunt

D Cdts 3, 2006, Ottawa, ON: Department of National Defence

TEARING DOWN A HOOCHIE SHELTER



Tearing down a hoochie shelter will be conducted during the tear down of the bivouac site. The cadets shall, under supervision, tear down their hoochie shelter with their partner.

Tearing down a hoochie takes much less time than constructing one.

To tear down a hoochie:

1. Take all personal equipment out of the hoochie shelter.
2. Cut the twine tying the hoochie shelter to the trees.
3. Pull the pegs from the ground.
4. Pull/cut off any twine used to tie the grommets to the pegs. Make sure there are no sticks left in the grommet holes.
5. Unzip the groundsheets. Shake off any dirt and debris that may have fallen on it.

6. Fold the groundsheets.
7. Return the ground to its original state and clean up garbage.



Groundsheets **must be dry** before they can be folded and stored. They may have to be laid out to dry.

Depending on the quartermaster, groundsheets may be folded or rolled. All must be folded or rolled in the same way and tied so they will not come apart.

CONFIRMATION OF TEACHING POINT 2

QUESTIONS

- Q1. Why do groundsheets need to be checked prior to setting up a hoochie shelter?
- Q2. How high should the shelter be tied?
- Q3. How high off the ground should a hoochie be pegged?

ANTICIPATED ANSWERS

- A1. Groundsheets need to be checked for fatigue and wear.
- A2. Shelters should be at waist height of the tallest occupant.
- A3. A hoochie should be pegged 5 cm off the ground.

Teaching Point 3

Explain and Demonstrate Setting Up Personal Space

Time: 5 min

Method: Demonstration

SETTING UP PERSONAL SPACE

Air Mattress. The air mattress will be placed down the sides of the hoochie shelter.

Sleeping Bag. The sleeping bag will be rolled up and placed at the top of the air mattress. It can be unrolled at bed time.

Rucksack. The rucksack will be placed at the head of the air mattress.

Boots. Boots will be placed at the end of the air mattress, by the entrance.

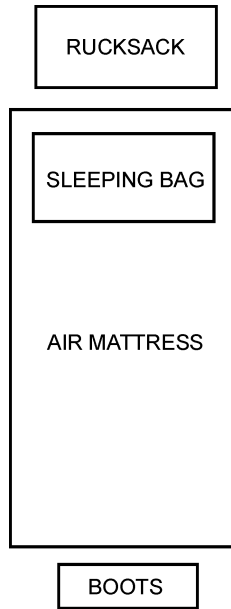

Figure 9 Personal Sleeping Space

D Cds 3, 2007, Ottawa, ON: Department of National Defence

CONFIRMATION OF TEACHING POINT 3

QUESTIONS

- Q1. Will the sleeping bag be rolled or unrolled on the air mattress?
- Q2. Where is the rucksack placed?
- Q3. Where will boots be placed?

ANTICIPATED ANSWERS

- A1. The sleeping bag will be rolled on the air mattress, until you are ready for bed.
- A2. The rucksack is placed at the head of the air mattress.
- A3. Boots will be placed at the end of the air mattress, by the entrance.

Teaching Point 4

Construct a Hoochie Shelter

Time: 45 min

Method: Performance

ACTIVITY

OBJECTIVE

The objective of this activity is for the cadets to construct a hoochie shelter.

RESOURCES

- Groundsheets (one per cadet);
- Sleeping bag (one per cadet);
- Air mattress (one per cadet);
- Twine or bungee cord;
- A knife (one per two cadets); and
- Sticks for pegging.

ACTIVITY LAYOUT

Choose an area in which each pair of cadets can set up a hoochie shelter between two trees that are approximately two metres (six feet) apart.

ACTIVITY INSTRUCTIONS

1. Divide cadets into pairs (same gender).
2. Assign each pair the required resources.
3. Have cadets gather sticks for pegging.
4. Have cadets construct a hoochie.
5. Have cadets organize their personal space.
6. Cadets will check their hoochie shelters to ensure:
 - a. there is room for two people to sleep and sit upright;
 - b. the lines are secure; and
 - c. it is waterproof.

SAFETY

- Cadets will respect boundaries for the activity.
- Cadets will ensure safe tool use at all times.



Inspect the cadets' hoochies to ensure they are well constructed and safe to sleep in.

CONFIRMATION OF TEACHING POINT 4

The cadets' participation in the activity will serve as the confirmation of this TP.

END OF LESSON CONFIRMATION

The cadets' participation in constructing a hoochie shelter and setting up personal space will serve as the confirmation of this lesson.

CONCLUSION

HOMEWORK/READING/PRACTICE

N/A.

METHOD OF EVALUATION

N/A.

CLOSING STATEMENT

Constructing a hoochie is an important skill for Army Cadets. Shelter allows the cadet to stay comfortable and protected while participating in expeditions and weekend bivouac FTXs.

INSTRUCTOR NOTES/REMARKS

Tearing down a hoochie shelter will be confirmed during the tear down of the bivouac site.

REFERENCES

C2-004 (ISBN 1-896713-00-9) Tawrell, P. (1996). *Camping and Wilderness Survival: The Ultimate Outdoors Book*. Green Valley, ON: Paul Tawrell.

C2-008 (ISBN 0-00-265314-7) Wiseman, J. (1999). *The SAS Survival Handbook*. Hammersmith, London: HarperCollins Publishers.



ROYAL CANADIAN ARMY CADETS

RED STAR

INSTRUCTIONAL GUIDE



SECTION 7

EO M221.07 – USE SECTION EQUIPMENT

Total Time: 60 min

Time: 60 min

PREPARATION

PRE-LESSON INSTRUCTIONS

Resources needed for the delivery of this lesson are listed in the lesson specification located in A-CR-CCP-702/PG-001, Chapter 4. Specific uses for said resources are identified throughout the Instructional Guide within the TP for which they are required.

Review the lesson content and become familiar with the material prior to delivering the lesson.

Divide cadets into groups as resources allow.

Coleman stoves and lanterns will be fuelled prior to this lesson.

Obtain logs for cadets to chop and saw.

PRE-LESSON ASSIGNMENT

N/A.

APPROACH

An interactive lecture was chosen for TP1 and TP3 to introduce the safe handling of section equipment when participating in a weekend bivouac FTX.

Demonstration and performance was chosen for TP2, TP4 and TP5 as it allows the instructor to explain and demonstrate the uses of section equipment while providing an opportunity for the cadets to operate this equipment under supervision.

INTRODUCTION

REVIEW

N/A.

OBJECTIVES

By the end of this lesson the cadet shall be expected to use section equipment to include lighting and extinguishing a two-burner stove and a dual-mantle lantern. Cadets are also expected to employ safe tool use.

IMPORTANCE

It is important for cadets to know how to use section equipment to prevent accidents and injuries, and to increase the life of equipment.

Teaching Point 1

Identify the Characteristics of the Two-burner Stove

Time: 5 min

Method: Interactive Lecture



The Coleman two-burner stove Model M425F710C was used in the production of this lesson. However, instructors may substitute another stove when conducting this lesson.

CHARACTERISTICS

The following are characteristics of the Coleman two-burner stove:

- It is capable of operating with a clean, smokeless flame.
- The flame can be quickly extinguished.
- It is easily ignited in cold weather.
- It does not rattle when packed.
- It is easy to refuel.
- It has no noxious odours.
- Fuel in the tank will not spill when being carried in any position.
- It cools off quickly.
- It is easily cleaned and repaired.

Operational Temperature

The Coleman two-burner stove, when shielded from the wind, can be used in temperatures as low as -52° C.

Fuel Type

The stove uses naphtha.

Parts and Accessories



The diagram provided is for part identification, not disassembly purposes.

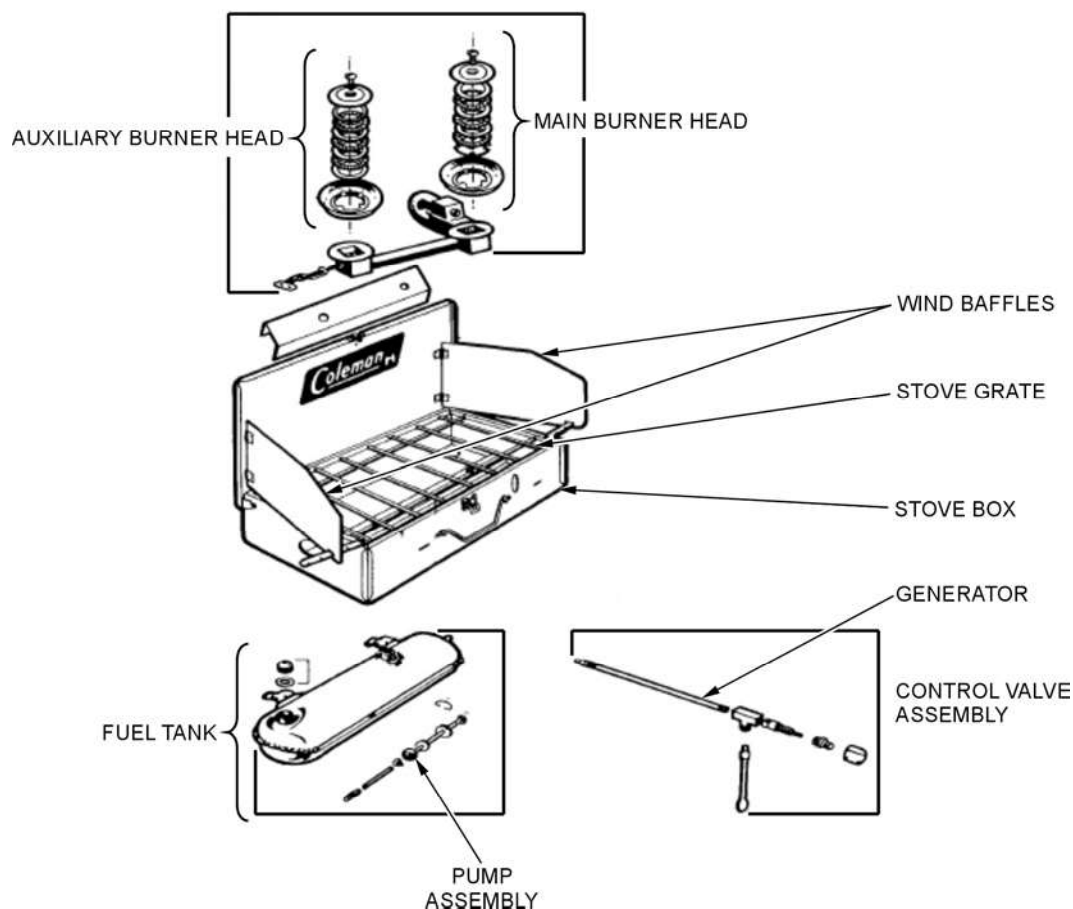

Figure 1 Parts of the Coleman Two-burner Stove

B-GG-302-002/FP-001, Basic Cold Weather Training: Arctic and Sub-arctic Operations (Vol. 2) (p. 2-75)

Stove Box. This is the container in which the burners are stored along with the fuel tank and generator.

Control Valve Assembly. This consists of the valve wheel, nut and body. Its function is to regulate the flow of pressurized fuel from the fuel tank through the generator to the burner head.

Main Burner Head. The main burner head is located on the right of the stove and consists of a burner cap and a small screw with a series of burner rings. The entire assembly sits in a large burner bowl. The main burner control knob is located on the valve and generator assembly.

Auxiliary Burner Head. The auxiliary burner head is located on the left of the stove and consists of a burner cap and small screw along with a series of small burner rings. The entire assembly sits in a small burner bowl. The auxiliary burner control is located on the left side of the stove box.

Pump Assembly. The pump assembly is fitted into the tank and is held in place by a pump cap clip.

Fuel Tank. The fuel tank is red in colour. This tank is only intended to be filled to three quarters full, allowing air in for pressurization. The tank fits on the front of the stove box when in use, and is stored inside the stove box.

Wind Baffles. The wind baffles shelter the burners from wind.

Stove Grate. The stove grate supports pot sets.

Generator. The generator supplies fuel to the burners. Fuel passing through the generator is heated by the main burner.

Precautions

Hazards are few if precautions are taken. Follow these few simple rules:

- Never leave the stove unattended.
- Do not use a stove as a heating device or in enclosed spaces such as buildings, tents or caves.
- Never remove the fuel tank or loosen the filler cap on the fuel tank while the stove is in operation.
- Always fill and light the stove outside in a well ventilated area, away from open flame, heat and combustibles.
- Use only naphtha fuel.
- Store away from open flame or excessive heat.
- Always ensure wind baffles and lid supports are securely positioned before lighting the stove.
- Before transporting or storing, ensure the stove is cool. Loosen the filler cap to release air pressure and retighten. Turn the control knob off.
- If the stove catches light, turn off the fuel supply, close the wind baffles and drop the stove lid.
- When using the stove ensure a fire extinguisher is available.



It is important to stress to cadets that stoves and lanterns must not be used in enclosed spaces such as buildings and tents. The burning of naphtha and other fuels results in the release of carbon monoxide. Carbon monoxide binds with haemoglobin 200 to 250 times better than oxygen, and disrupts almost all physiologic and neurologic systems, even in fairly low concentrations. Because the gas is heavier than air, it pools in the low ground of tents and caves where outdoor enthusiasts sleep, and will not go away – for days even – unless it's forced out by a strong, persistent direct draft of cold air at the height of the pooled gas. Preventing the problem in the first place requires a similarly active draft – at the stove or lantern or below, not at the top of the tent or cave as was once thought. According to one recent research study, asphyxiation in tenting situations kills three times as many people yearly as mountaineering does. Other research has linked even moderate exposure to carbon monoxide to significant long-term effects, including depressed mood, apathy, disorientation, irritability and amnesia – several of which occur in 100 per cent of individuals exposed and can be measure years after the initial exposure. Risks also increase in higher altitudes.

CONFIRMATION OF TEACHING POINT 1

QUESTIONS

- Q1. What is the lowest operational temperature of the Coleman stove?
- Q2. What type of fuel is used in the Coleman stove?
- Q3. What are three precautions to take when operating the Coleman stove?

ANTICIPATED ANSWERS

- A1. When shielded from the wind, it can be used in temperatures as low as -52 °C.
- A2. The Coleman stove uses naphtha.
- A3. Three precautions to take when operating the Coleman stove are:
- Do not use the stove as a heater.
 - Never remove or loosen the filler cap on the fuel tank while the stove is in operation.
 - Never leave the stove unattended.
 - Always fill and light the stove outside, away from open flame, heat and combustibles.
 - Never remove the fuel tank while the stove is in operation.
 - Use only naphtha fuel.
 - Store away from open flame or excessive heat.
 - Always ensure wind baffles and lid supports are securely positioned before lighting the stove.
 - Do not use in dining tents.
 - Before transporting or storing, ensure the stove is cool. Loosen the filler cap to release air pressure and retighten. Turn the control knob off.

Teaching Point 2

Explain, Demonstrate and Have the Cadets Operate a Two-burner Stove

Time: 15 min

Method: Demonstration and Performance



For this skill lesson, it is recommended that instruction take the following format:

1. Explain and demonstrate the complete skill while cadets observe.
2. Explain and demonstrate each step required to complete the skill. Monitor cadets as they imitate each step.
3. Monitor the cadets' performance as they practice the complete skill.

Note: Assistant instructors may be employed to monitor cadet performance.

ASSEMBLY

To assemble the Coleman stove:

1. Unlatch and open the stove (Figure 2).
2. Open and secure the wind baffles (Figure 3).
3. Lift the grate and remove the fuel tank (Figure 4).
4. Install the fuel tank. Ensure the generator passes through the large hole in the front of the stove and is inserted into the opening in the mixing chamber above the burner. Insert hanger brackets on the tank into the slots located on the front of the stove case (Figure 4).

5. Secure the safety chain (Figure 5).
6. Close the grate (Figure 6).
7. Ensure the auxiliary burner valve is in the closed position (Figure 7).



Figure 2 Closed Stove

D Cds 3, 2007, Ottawa, ON: Department of National Defence



Figure 3 Wind Baffles

D Cds 3, 2007, Ottawa, ON: Department of National Defence



Figure 4 Installing the Fuel Tank

D Cdts 3, 2007, Ottawa, ON: Department of National Defence



Figure 5 Securing the Safety Chain

D Cdts 3, 2007, Ottawa, ON: Department of National Defence



Figure 6 Closed Gate

D Cdts 3, 2007, Ottawa, ON: Department of National Defence



Figure 7 Auxiliary Burner Control

D Cds 3, 2007, Ottawa, ON: Department of National Defence

LIGHTING AND EXTINGUISHING THE COLEMAN STOVE

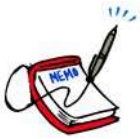

The Coleman stove fuel tank should have been fuelled previous to this lesson, however, the fuel tank will have to be pressurized through pumping.

Pumping the Fuel Tank

1. Make sure the control knob is in the OFF position.
2. Turn the pump rod two full turns counterclock wise.
3. Place the thumb over the air vent of the pump rod handle.
4. Pump thirty to forty full strokes to pressurize the fuel tank.
5. Turn the pump rod clockwise until it is closed tight.

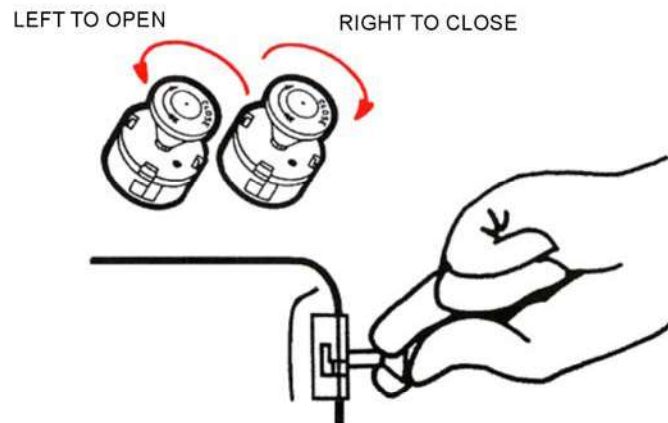
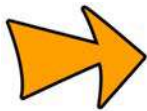

Figure 8 Pumping the Fuel Tank

Coleman Camp Stove Model M425F710C Instructions for use, by The Canadian Coleman Co., Mississauga, ON

Lighting the Main Burner



During colder conditions, it may be necessary to warm the generator prior to lighting. This can be accomplished by applying a small amount of fuel to the main burner directly and lighting it with a match. The burning fuel will heat the generator, heating the fuel inside and facilitating the lighting of the burner. When the generator is not adequately heated it is possible for liquid fuel to pool in the stove which is very dangerous.

1. Ensure the auxiliary valve is in the closed position and the tank is pumped.
2. Do not lean over the stove while lighting.
3. Hold a lit match near the master burner.
4. Turn the instant light lever up to light.
5. Turn the control knob to the LIGHT position or setting.
6. Monitor the flame.
7. When the flame turns blue in colour (approximately one minute), turn the instant light lever down and turn the control knob to the desired heat setting (HI – LO).

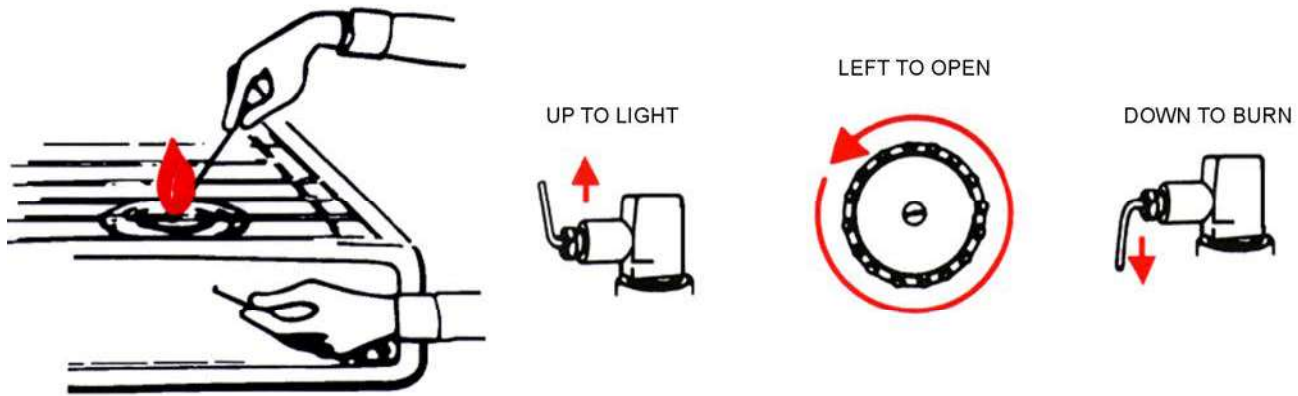
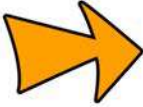

Figure 9 Lighting the Main Burner

Coleman Camp Stove Model M425F710C Instructions for use, by The Canadian Coleman Co., Mississauga, ON

 Should the stove fail to light or the match goes out before ignition, turn the control knob to the OFF position and wait two minutes before attempting to light the stove again.

Lighting the Auxiliary Burner

1. After the main burner has been lit, the auxiliary burner may be lit.
2. Hold a match to the auxiliary burner. Open the auxiliary valve located on the side of the stove box, next to the burner (the main burner may require adjustment after lighting the auxiliary burner).

Extinguishing the Burner

1. Close the auxiliary burner valve.
2. Remove cookware from the stove and turn the instant light lever up to LIGHT position and let burn for one minute. This cleans heavier parts of fuel from the generator.
3. Turn the control knob clockwise to the OFF position and close firmly.

 A small flame on the main burner will continue to burn for a few minutes, until the fuel empties from the generator.

STORING THE COLEMAN STOVE AFTER USE

To store the Coleman stove:

1. Allow the stove to cool before packing.
2. Ensure the stove is clean and any dirt, matches, etc. are emptied from the stove box.
3. Ensure the auxiliary burner valve is in the closed position.
4. Open the grate.
5. Remove the safety chain.

6. Uninstall the fuel tank and remove it from the generator.
7. Place the fuel tank inside the stove box.
8. Close the grate.
9. Close and fold in the wind baffles.
10. Close the cover and latch the box.
11. Store the stove in a cool, dry location.

CONFIRMATION OF TEACHING POINT 2

QUESTIONS

- Q1. How is the Coleman stove assembled?
- Q2. How many pumps pressurize a fuel tank?
- Q3. What is the first step in extinguishing the Coleman stove?

ANTICIPATED ANSWERS

- A1. To assemble the Coleman stove complete the following steps:
 1. Unlatch and open the stove.
 2. Open and secure the wind baffles.
 3. Lift the grate and remove fuel tank.
 4. Install the fuel tank. Ensure that the generator passes through the large hole in the front of the stove and is inserted into the opening in the mixing chamber above the burner. Insert hanger brackets on the tank into the slots located on the front of the stove case.
 5. Secure the safety chain.
 6. Close the grate.
 7. Ensure auxiliary burner valve is in the closed position.
- A2. Pump thirty to forty full strokes to pressurize a fuel tank.
- A3. The first step in extinguishing the Coleman stove is close the auxiliary burner valve.

Teaching Point 3

Identify the Characteristics of the Dual-mantle Lantern

Time: 5 min

Method: Interactive Lecture

CHARACTERISTICS

Coleman lanterns are designed to burn naphtha—a very flammable liquid fuel. This fuel is pressurized in a tank attached to the unit, heated in a generator and then burned as a gas. For best results, keep lanterns clean and in good working condition.

The characteristics of the dual-mantle Coleman lantern include:

- a weight of 2.25 kg (5 lbs); and
- a 1 L fuel tank capacity which allows 7 hours of burn time on HIGH and 14 hours on LOW.

Parts and Accessories



Figure 10 Coleman Dual-mantle Lantern

D Cds 3, 2007, Ottawa, ON: Department of National Defence

Ventilator. Allows for heat and exhaust to evacuate the lantern.

Generator. Provides pressurized fuel to the mantle.

Mantle. Emits a bright light by the burning naphtha fuel.

Handle. Allows the user to carry or hang the lantern.

Pyrex Globe. Protects the mantle from foreign debris. The globe also reduces the amount of oxygen entering the lantern.

Filter Cap. Seals the fuel tank.

Control Knob. Controls the amount of fuel entering the generator, controlling the brightness of the lantern.

Tank. Is a fuel storage reservoir.

Pump. Pumps air into the fuel tank, pressurizing the tank.

Precautions

Hazards are few when precautions are taken. In addition to the precautions taken with stoves caution must be taken to ensure that lantern mantles with holes in them are replaced prior to use.

CONFIRMATION OF TEACHING POINT 3

QUESTIONS

- Q1. What is the fuel capacity of the dual-mantle tank?
- Q2. Where should the lantern be used?
- Q3. What is the purpose of the handle?

ANTICIPATED ANSWERS

- A1. The dual-mantle lantern fuel tank holds 1 L.
- A2. The lantern should be used in ventilated or open areas.
- A3. The handle allows the user to carry or hang the lantern.

Teaching Point 4

**Explain, Demonstrate and Have the Cadets Practice
Operating the Dual-mantle Lantern**

Time: 10 min

Method: Demonstration and Performance



For this skill lesson, it is recommended that instruction take the following format:

1. Explain and demonstrate the complete skill while cadets observe.
2. Explain and demonstrate each step required to complete the skill. Monitor cadets as they emulate each step.
3. Monitor the cadets' performance as they practice the complete skill.

Note: Assistant instructors may be employed to monitor cadet performance.

ASSEMBLY

The lantern does not require assembly or disassembly except replacing the mantles. Before operating the lantern, the cadet should verify that the handle is in place and that the screw on top of the ventilator is tight.

LIGHTING AND EXTINGUISHING THE COLEMAN DUAL-MANTLE LANTERN



The lantern should have been fuelled previous to this lesson; however, the lantern will have to be pressurized through pumping. When a mantle is replaced it should be burned prior to use. By burning the mantle, the mantle shrinks down in size ensuring that combustion of the fuel takes place at the mantle. When the mantle is not burned prior to use fuel can leak out of the mantle prior to combustion.

Pumping the Fuel Tank

1. Make sure the control knob is in the OFF position.
2. Turn the pump rod two full turns counterclockwise.
3. Place the thumb over the air vent of the pump rod handle.

4. Pump thirty to forty full strokes to pressurize the fuel tank.
5. Turn the pump rod to clockwise until it is closed tight.

Lighting the Lantern



Do not position the hands or head above the lantern when lighting. Mantles are very fragile and shall be avoided when using a match to light the lantern.

1. Insert a lit match through the hole in the bottom of the burner frame.
2. Turn the control knob to the LIGHT position.
3. When the mantle burns bright white, turn the control knob to the ON position.
4. Add more air pressure to the tank. Air pressure may be added while the lantern is in operation. Good air pressure is important for maximum light output.

Extinguishing the Lantern

1. Turn the control knob to the OFF position.
2. Allow the remaining fuel to burn off.

STORING THE LANTERN AFTER USE

To store the Coleman lantern:

1. Ensure the lantern is cool.
2. Wipe and clean away any dirt.
3. Drain the fuel into a fuel storage container.
4. Place in a cool, dry location.

CONFIRMATION OF TEACHING POINT 4

QUESTIONS

- Q1. How many pumps pressurize a lantern fuel tank?
- Q2. Where is the match inserted to light the lantern?
- Q3. How is a lantern extinguished?

ANTICIPATED ANSWERS

- A1. Pump thirty to forty full strokes to pressurize a lantern fuel tank.
- A2. Insert a lit match through the hole in the bottom of the burner frame.
- A3. To extinguish, turn the control knob to the OFF position and allow the lantern to burn off the remaining fuel.

Teaching Point 5**Explain, Demonstrate and Have the Cadets Practice Safely Handling of Field Tools**

Time: 15 min

Method: Demonstration and Performance



For this skill lesson, it is recommended that instruction take the following format:

1. Explain and demonstrate the complete skill while cadets observe.
2. Explain and demonstrate each step required to complete the skill. Monitor cadets as they imitate each step.
3. Monitor the cadets' performance as they practice the complete skill.

Note: Assistant instructors may be employed to monitor cadet performance.



When using tools, everyone should:

- Store tools in a secure place. Never leave them lying around or touching the ground.
- Always use the right tool for the job.
- Follow the safety procedures for using the equipment.
- Keep the edges and blades sharp and handles tight.
- Clean and lightly oil steel parts before storage.

AXE

Before using an axe, the tightness of the handle should be checked. If it is loose, the wedge needs to be driven further down or a new wedge should be made using hardwood. The handle must not be cracked or split.

Determining Sharpness

The axe blade should be sharp. If it is not, it can be dangerous, as it will not bite/cut properly and will tend to glance/skip off the wood being cut. Greater force will be required to use it, sacrificing control. A file is best for removing burrs (chips) on the axe blade, and a whetstone for sharpening the edge.

Holding

The axe should be carried by holding it by the handle just below the head, the cutting edge in front and pointing slightly away from the person.

Before storing, the axe should be carefully cleaned and put back in its sheath. When outdoors, the axe can also be driven into the dry stump of a dead tree when not in use.

Chopping Angle

To maximize chopping, cuts should be made at angles of 45 degrees. At angles less than 45 degrees, the axe can deflect off the tree. This can be very dangerous. At angles greater than 45 degrees, the axe will be ineffective as the blade will not chip away pieces of wood but just insert itself into the tree.

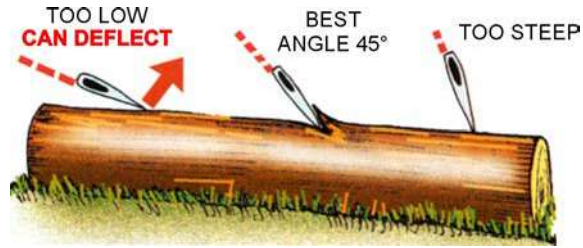

Figure 11 Chopping Angle

Tawrell, P., Camping and Wilderness Survival, Leonard Paul Tawrell (p. 409)

Direction of Fall

When using an axe to cut a tree:

1. Plan an escape route in case the tree falls toward you. Beware of hornets or wasp's nests.
2. Check that the axe is sharp and the head is secure on the handle.
3. Set up a safe distance from other people.
4. Remove any branches and nearby shrubs that can deflect the axe.
5. Secure footing.
6. Swing with short, smooth strokes. This will keep one on target.
7. Cuts are most efficient at 45 degree angles and easily eject wood chips.
8. Check the direction of lean.
9. Carefully cut until the tree is ready to fall. When the tree falls and other people are present, yell **TIMBER!**

The first cut should be made on the side of the tree facing the direction of the desired fall. This is often decided by the lean of the tree. The cut should not be more than halfway through the tree. The back cut commences slightly above and opposite the first cut. Both cuts should be at 45 degree angles.

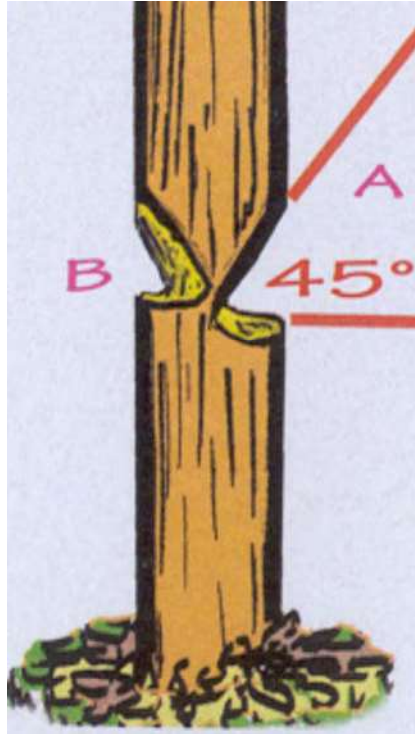

Figure 12 Direction of Fall

Tawrell, P., Camping and Wilderness Survival, Leonard Paul Tawrell (p. 496)

BOW SAW

Holding and Cutting a Log

When using a bow saw to cut wood:

1. Use steady strokes without excessive weight on the blade.
2. Ensure the wood is secured by using a log support. This will help prevent the saw from getting pinched by the log, allowing the weight of the cut end to open the cut (Figure 12).

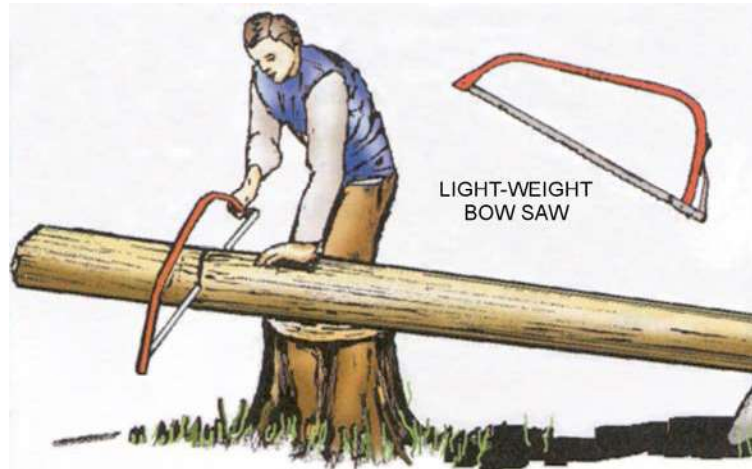

Figure 13 Cutting a Log

Tawrell, P., Camping and Wilderness Survival, Leonard Paul Tawrell (p. 500)

Direction of Fall

When using a bow saw to cut a tree:

1. Chop a notch with an axe in the direction the tree is to fall. This is called a bridge.
2. Saw on the opposite side of the tree from the notch, one or two inches above the lower surface of the notch (see Figure 14). This is very important because if sawn below the notch, the tree can kick back, pinch the blade and may go out of control.
3. Withdraw the saw when the tree starts to fall. The tree will fall with the help of the bridge.

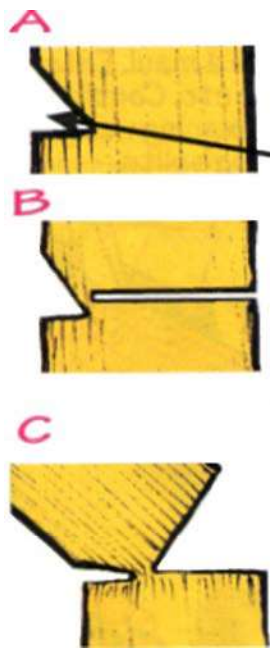

Figure 14 Cutting a Tree With a Saw

Tawrell, P., Camping and Wilderness Survival, Leonard Paul Tawrell (p. 500)

ACTIVITY

Time: 10 min

OBJECTIVE

The objective of this activity is to practice chopping and sawing a log.

RESOURCES

- Logs for cadets to chop and saw;
- 1 axe per group; and
- 1 bow saw per group.

ACTIVITY LAYOUT

N/A.

ACTIVITY INSTRUCTIONS

1. Divide cadets into groups of no more than five.
2. Cadets will cut and saw a log of wood using an axe and a bow saw.
3. Every cadet will be given an opportunity to cut and saw.

SAFETY

Cadets will be directly supervised by an instructor employing safe tool handling at all times.

CONFIRMATION OF TEACHING POINT 5

QUESTIONS

- Q1. What should be checked on an axe before using it?
- Q2. What angle will maximize the chop of an axe?
- Q3. What type of strokes should be used when sawing?

ANTICIPATED ANSWERS

- A1. Before using an axe, the tightness of the handle should be checked. The handle must not be cracked or split and the axe blade should be sharp.
- A2. A 45 degree angle will maximize the chop of an axe.
- A3. Use steady strokes without excessive weight on the blade.

END OF LESSON CONFIRMATION

QUESTIONS

- Q1. What should be oiled on an axe after use?
- Q2. What is the lowest operational temperature of the Coleman Stove?
- Q3. Why do cadets not use Coleman Stoves or Lanterns in an enclosed space?

ANTICIPATED ANSWERS

- A1. The steel head on an axe should be oiled after use.
- A2. When shielded from the wind, the lowest operational temperature of a Coleman stove is -52° C.
- A3. Stoves and Lanterns produce carbon monoxide which binds with haemoglobin resulting in effects such as depressed mood, apathy, disorientation, irritability, amnesia and even death.

CONCLUSION

HOMEWORK/READING/PRACTICE

N/A.

METHOD OF EVALUATION

N/A.

CLOSING STATEMENT

During a weekend bivouac FTX, everyone will use tools to construct portions of the bivouac site. It is key to know how to use the tools and equipment provided, as it will help ensure everyone's safety and will help keep the tools in good condition.

INSTRUCTOR NOTES/REMARKS

Fire extinguishers shall be located within 15 m of operating stoves and lanterns.

REFERENCES

A2-010 B-GG-302-002/FP-001 FMC (1982). *Basic Cold Weather Training: Arctic and Sub-arctic Operations* (Vol. 2). Ottawa, ON: Department of National Defence.

C0-111 (ISBN 978-0-9740820-2-8) Tawrell, P. (2006). *Camping and Wilderness Survival: The Ultimate Outdoors Book* (2nd ed.). Lebanon, NH: Leonard Paul Tawrell.



ROYAL CANADIAN ARMY CADETS

RED STAR

INSTRUCTIONAL GUIDE



SECTION 8

EO M221.08 – PREPARE AN INDIVIDUAL MEAL PACKAGE (IMP)

Total Time:

30 min

PREPARATION

PRE-LESSON INSTRUCTIONS

Resources needed for the delivery of this lesson are listed in the lesson specification located in A-CR-CCP-702/PG-001, Chapter 4. Specific uses for said resources are identified throughout the Instructional Guide within the TP for which they are required.

Review the lesson content and become familiar with the material prior to delivering the lesson.

Immediately prior to this lesson bring water to a boil and have it waiting at a simmer. This water will be used to heat the IMP. Also, have some potable water boiled and ready for any additional food items in the IMP that require hot water.

PRE-LESSON ASSIGNMENT

N/A.

APPROACH

An interactive lecture was chosen for TP1 and TP2 to introduce the cadets to meal preparation in the field and to generate interest.

Demonstration and performance was chosen for TP3 as it allows the instructor to explain and demonstrate how to prepare an IMP while providing an opportunity for the cadets to practice under supervision.

INTRODUCTION

REVIEW

N/A.

OBJECTIVES

By the end of this lesson the cadet shall be expected to prepare an IMP.

IMPORTANCE

It is important for cadets to know how to prepare the different components of an IMP. The IMP will provide energy to fuel the body enabling a cadet to continue tasks and activities in the field. The IMP is most often consumed during expeditions in the absence of kitchen facilities.

Teaching Point 1**Discuss Field Meals**

Time: 5 min

Method: Interactive Lecture



Cadets may have some knowledge of the different types of rations available from Green Star or the General Training Course.

Provide the cadets with as many visual examples as possible. This lesson is conducted in the field, so fresh and IMP meals should be available. If hay boxes are available be sure to use them as an example.

TYPES OF FIELD MEALS

Eating regularly in the field is a very important aspect of maintaining strength and energy. Even though a cadet may be preoccupied, it is important to eat as much healthy food as possible when engaged in physical outdoor activities. Cold weather, strenuous exercise and constant activity require a lot of energy. Only a good, healthy meal can replace energy.

Fresh Rations

Fresh rations are raw food prepared in the field. Fresh rations require preparation and cooking. This type of ration usually does not store/keep well and must be cooked within a day of entering the field (e.g. hot dogs, hamburgers, steak, eggs, etc.).

Hay Boxes

Hay boxes contain fresh rations that have been prepared by a kitchen facility. The food is stored in insulated containers (hay boxes) that continue to keep this food warm without fuel (the warm metal inserts are kept warm because of the food stored within). A hay box is very similar to a thermos – keeping cold food cold or hot food hot.

Box Lunches

These meals are made as a replacement for meals that would normally be consumed at a kitchen. They may be used for planned trips where, either as a result of the timings or the route used, kitchen facilities are not accessible for meals. Box lunches usually contain sandwiches, fruit, veggies, juice, etc.

IMPs

Each IMP includes a main course (meat or vegetarian), vegetables and fruit in sealed foil pouches, and dried foods in paper/tinfoil pouches. All of the food items are safe to eat cold and dry—they may not taste as good as hot food, though. High sugar items like chocolate, hard candies, drink mixes, as well as coffee and tea are also included.

IMPs were developed to meet a typical day's three meal requirement. These meals are identified as breakfast, lunch and supper. They contain between 1400 and 1800 calories—enough calories for an adult performing strenuous tasks for prolonged periods. If inactive or working at lower levels of effort, eating IMPs could cause a person to gain weight.

WATER REQUIREMENTS

Bringing Water to the Field. When warming/heating IMPs, potable water is not required. Pond, lake or spring water that has not been filtered or treated will suffice.

Water Used for Cooking IMPs Is Not Potable. The water used for cooking IMPs may become contaminated with aluminium oxide from the outside of the IMP pouches. This makes the water unsafe to drink and should be treated as grey (washing) water and disposed of appropriately.

Boiling or Treating Water From Unknown Sources. When drawing water from any source that may not be safe, it must be boiled rapidly for 5 minutes before it is consumed.

CONFIRMATION OF TEACHING POINT 1

QUESTIONS

- Q1. What are the four types of rations available?
- Q2. IMPs are identified by what type of meals?
- Q3. Can water from boiled IMPs be consumed?

ANTICIPATED ANSWERS

- A1. Fresh, box lunches, hay boxes and IMPs.
- A2. Breakfast, lunch and supper.
- A3. No. The water becomes contaminated with aluminium oxide from the outside of the IMP pouches.

Teaching Point 2

Discuss the Characteristics and Contents of an IMP

Time: 5 min

Method: Interactive Lecture



During this TP, if available, have two IMPs. One breakfast meal and either a lunch or supper meal is best.

Describe the physical look of the IMP and discuss each item contained within. Give examples of how to use each item.

Show the difference in items between the breakfast and the other meals, note the cereal and hot chocolate items.

CHARACTERISTICS OF AN IMP

The IMP is a small-packaged meal that:

- is no bigger than a large dictionary;
- weighs 850 grams (14 ounces, one pound is equal to 16 ounces);
- contains approximately 1400 to 1800 calories;
- is available in three different meal types—breakfast, lunch and supper. Each type of meal has six different courses; and
- contains some similar contents.

CONTENTS OF AN IMP

	BREAKFAST	LUNCH	SUPPER
COMMON	1. Main meal pouch 2. Dessert pouch 3. Matches 4. Paper towel 5. Spoon 6. Beverage crystals		
MEAL-SPECIFIC	1. Coffee and hot chocolate with condiments 2. Cereal	1. Coffee and tea with condiments 2. Chocolate bar 3. Bread/crackers and jam	1. Coffee and tea with condiments 2. Chocolate bar or cookies 3. Soup 4. Side dish
<p>Note: contents change yearly. This list is intended to identify the key items in an IMP.</p>			

CONFIRMATION OF TEACHING POINT 2

QUESTIONS

- Q1. How heavy is an IMP?
- Q2. What is the approximate size of an IMP?
- Q3. Name five items that are common to each IMP.

ANTICIPATED ANSWERS

- A1. About 850 grams or 14 ounces.
- A2. No bigger than a large dictionary.
- A3. Main meal pouch, dessert pouch, spoon, paper towel, and matches.

Teaching Point 3

Explain, Demonstrate, and Allow Time for the Cadets, as a Group, to Prepare and Cook IMPs

Time: 15 min

Method: Demonstration and Performance

	<p>Issue each cadet an IMP for their next meal. Demonstrate preparing an IMP for cooking and have cadets follow along.</p> <p>Explain how to use each item in the IMP.</p>
---	--

COOKING IMPS

Although IMPs can be consumed cold, they should be heated when possible. Cooking IMPs is simply a matter of:

1. placing the foil pouch, with the entrée sealed inside, in boiling water;
2. heating for 5 minutes and then removing the pouch from the boiling water;
3. placing the pouch back into the cardboard package from which it came (tear a strip off the top of the package to allow easier access to the food); and
4. tearing open the foil pouch and enjoying.



IMPs require only a small amount of water to heat. The heat produced from boiling water and steam is very effective when heating the foil package.

Other food articles will have specific instructions, such as adding water, for their preparation.

Each IMP contains paper, cardboard and foil garbage. One way of reducing the amount of excess garbage that will have to be carried is to “break down” the rations before packing. This entails selecting only the food items that will be consumed and leaving behind the extra packaging. Always carry extra food as a person is often hungrier when performing physical activity than when packing.

ACTIVITY

Time: 10 min

OBJECTIVE

The objective of this activity is to have cadets prepare an IMP for a meal.

RESOURCES

- IMP (one per cadet);
- 2 Pots (large enough to hold IMPs and to boil potable water);
- Fuelled two-burner naphtha stove;
- Pot set;
- Potable water; and
- Matches.

ACTIVITY LAYOUT

Designated cooking area in a field setting.

ACTIVITY INSTRUCTIONS

1. Provide each cadet with an IMP meal appropriate for the time of day.
2. Have cadets follow along, preparing their IMPs for consumption.

3. Explain and demonstrate how to use, heat and consume all items in the IMP.
4. Cadets will consume the IMP they prepared following the tips they have learned.

SAFETY

Ensure caution when operating stoves and handling the IMPs once they are removed from the hot water. Caution, the boiling water produces a very hot steam that can scald the skin, causing a serious burn.

CONFIRMATION OF TEACHING POINT 3

The cadets' participation in the activity in TP3 will serve as a confirmation of this lesson.

END OF LESSON CONFIRMATION

The cadets' participation in the activity in TP3 will serve as a confirmation of this lesson.

CONCLUSION

HOMEWORK/READING/PRACTICE

N/A.

METHOD OF EVALUATION

N/A.

CLOSING STATEMENT

An IMP provides nutrients and energy for the active Army Cadet, especially during vigorous expedition training. Learning to prepare IMPs contents is a skill that will be needed while taking part in expedition training.

INSTRUCTOR NOTES/REMARKS

This lesson is best instructed prior to a meal hour.

REFERENCES

A2-042 A-85-269-001/FP-003 Canadian Forces. (1986). *Food Service Manual: Field Feeding* (Vol. 1). Ottawa, ON: Department of National Defence.



ROYAL CANADIAN ARMY CADETS

RED STAR

INSTRUCTIONAL GUIDE



SECTION 9

EO M221.09 – MAINTAIN SECTION EQUIPMENT FOLLOWING A FIELD TRAINING EXERCISE (FTX)

Total Time: 60 min

PREPARATION

PRE-LESSON INSTRUCTIONS

Resources needed for the delivery of this lesson are listed in the lesson specification located in A-CR-CCP-702/PG-001, Chapter 4. Specific uses for said resources are identified throughout the Instructional Guide within the TP for which they are required.

Review the lesson content and become familiar with the material prior to delivering the lesson.

This lesson is intended to be conducted following a weekend bivouac FTX. The equipment used on the FTX will be used as training aids, to include:

- a Coleman two-burner stove,
- a dual-mantle lantern,
- a pot set,
- a axe,
- a bow saw,
- a groundsheet,
- a bucket/wash basin, and
- rags.

Divide the cadets into groups of no more than four. Provide each group with basin of water and a rag or cloth. During each TP each group should be given a piece of the equipment being discussed. Have cadets follow along with the instruction, maintaining the equipment as it is covered.

PRE-LESSON ASSIGNMENT

N/A.

APPROACH

Demonstration and performance was chosen for this lesson as it allows the instructor to explain and demonstrate the cleaning and storing of section equipment while providing an opportunity for the cadets to practice these skills.

INTRODUCTION

REVIEW

N/A.

OBJECTIVES

By the end of this lesson the cadet shall be expected to maintain section equipment.

IMPORTANCE

It is important for cadets to learn how to maintain section equipment. Cleaning and storing equipment prolongs the life of the equipment. Through regimented cleaning practices, equipment will be slow to corrode and rust ensuring a long life.

Teaching Point 1

**Explain, Demonstrate and Have the Cadets Practice
Cleaning and Storing a Two-burner Stove**

Time: 10 min

Method: Demonstration and Performance



Provide each group with a Coleman two-burner stove. Have cadets follow along with the instruction, cleaning equipment as it is covered.

CLEANING SOLUTION

Cleaning the Coleman two-burner stove requires only a light mixture of dish soap and water and an old rag or cloth. To mix the solution, apply a few drops of dish soap in a wash bucket filled with warm water.

CLEANING

After use, the Coleman two-burner stove may be left with deposits of soot (fuel exhaust) and the remnants of food. Cleaning after use will prolong the life of the stove and delay corrosion of the metal surfaces. Parts of the Coleman two-burner stove shall be wiped clean using the cleaning solution and a rag/cloth.

The Inner and Outer Wind Baffles. The inner baffles usually become dirty and are often dirtier than the outer baffles as a result of the burning of fuel and food splashing over the pots and pans. Thoroughly wipe clean both sides of the baffles.



Figure 1 Wind Baffles

D Cds 3, 2007, Ottawa, ON: Department of National Defence

The Fuel Tank. The fuel tank shall be wiped clean. The fuel tank contains many ledges and crevices that require careful cleaning.



Figure 2 Fuel Tank

D Cds 3, 2007, Ottawa, ON: Department of National Defence

The Grate. The grate becomes dirty through direct contact with cooking utensils. Food is continuously spilled and burned onto the grate. Clean the grate of any food remnants. The grate may be stained by the heat of the flames and cannot be cleaned.

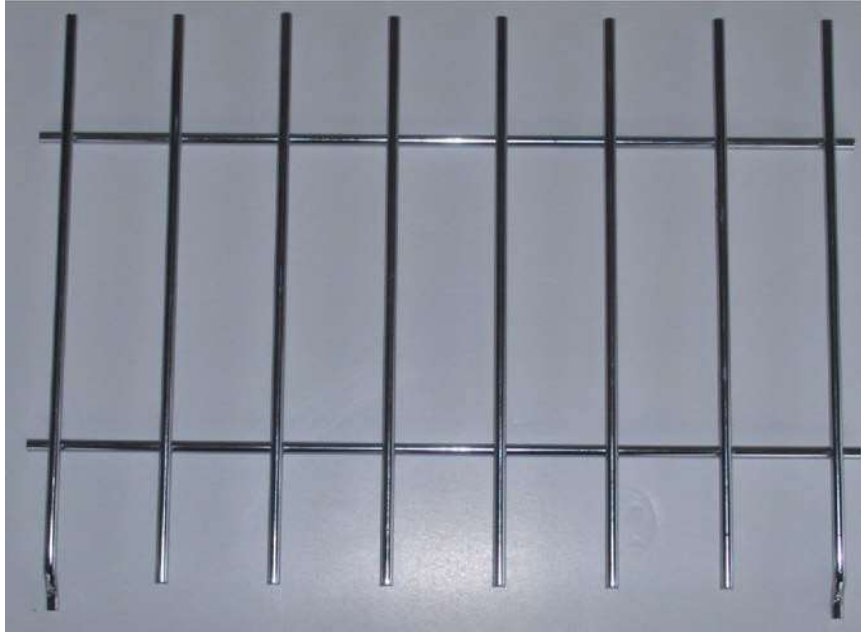

Figure 3 Grate

D Cds 3, 2007, Ottawa, ON: Department of National Defence

The Stove Box. The stove box protects the burner from dirt and debris; however, when in use, the box will collect dirt and debris. The inside of the box is subject to the spillage of food, dirt and dust. The inside and outside of the stove box shall be cleaned thoroughly because the settling of debris and dirt will speed corrosion.



Figure 4 Stove Box

D Cds 3, 2007, Ottawa, ON: Department of National Defence

INSPECTING FOR DAMAGE

After the stove has been cleaned, it must be inspected for damage. Check the following parts and report any damages:

- stove box;
- control valve assembly;
- main burner head;
- auxiliary burner head;
- pump assembly;
- wind baffles;
- stove grate; and
- fuel tank.

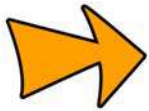

Damages should be recorded on a piece of coloured paper, preferably red, and attached to the damaged part. If the equipment is not suitable for use, remove it from usable equipment and report to the designated quartermaster to have the item replaced or repaired.

ENSURING THE FUEL TANK IS EMPTY PRIOR TO STORAGE

Ensure the tank is stored with no remaining pressure. To release the pressure loosen the filler cap until pressure is gone, then retighten the cap.

The fuel tank must be emptied prior to storage. Any remaining fuel should be drained into a fuel container. To drain the fuel tank, use a funnel and pour the remaining contents of the fuel tank into a fuel container. Then allow the remaining fuel to evaporate by placing the open fuel tank outside in a well ventilated area.

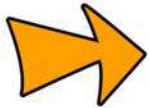

Drain the fuel tank outside and use a spill pan in case spillage occurs.

STORING

Store the Coleman stove in a cool, dry location away from moisture.

CONFIRMATION OF TEACHING POINT 1



The cadet's participation in cleaning the Coleman two-burner stove will serve as the confirmation of this TP. Questions have been provided if additional confirmation is required.

QUESTIONS

- Q1. What should be used as a cleaning solution?
- Q2. What areas of the wind baffles usually become dirty?
- Q3. How should damages be recorded?

ANTICIPATED ANSWERS

- A1. A mild solution of dish soap and water.
- A2. The inner baffles usually become dirty as a result of the burning of fuel and food splashing over from the pots and pans.
- A3. Damages should be recorded on a piece of coloured paper, preferably red, and attached to the damaged part.

Teaching Point 2

Explain, Demonstrate and Have the Cadets Practice Cleaning and Storing a Dual-mantle Lantern

Time: 10 min

Method: Demonstration and Performance



Provide each group with a dual-mantle lantern. Have the cadets follow along with the instruction, cleaning equipment as it is covered.

CLEANING SOLUTION

Cleaning the Coleman dual-mantle lantern requires only a light mixture of dish soap and water and an old rag/cloth. To mix the solution, apply a few drops of dish soap in a wash bucket filled with water.

CLEANING

After use, the Coleman dual-mantle lantern is left with deposits of soot (fuel exhaust) and possibly dirt or mud from being placed on the ground. Cleaning after use will prolong the life of the lantern and delay corrosion of the metal surfaces. Some parts of the Coleman dual-mantle lantern shall be wiped clean using the cleaning solution and a rag/cloth.

The Ventilator and Bail Assembly. The ventilator allows heat and exhaust to escape from the lantern. The exhaust builds up a residue on the ventilator, bail (handle) assembly and its metal parts. This residue over time becomes very greasy and dirty in appearance. Remove the ventilator and bail assembly by unscrewing the ventilator screw or uncoupling the handle and lifting clear the ventilator and bail assembly. Wipe clean the complete ventilator and bail assembly using the cleaning solution and a rag/cloth.

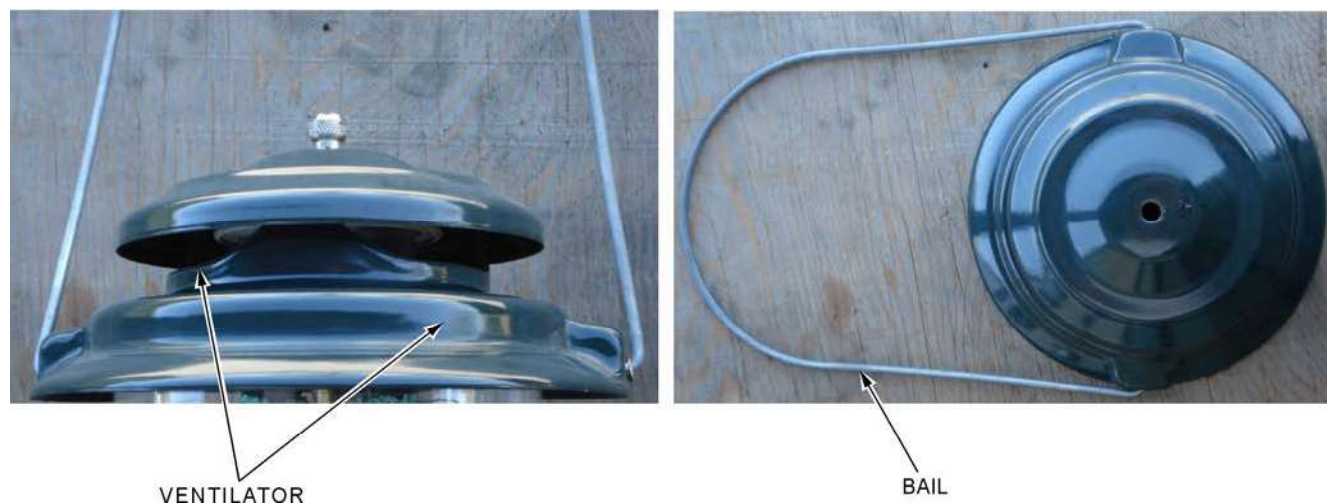

Figure 5 Ventilator and Bail Assembly

D Cdts 3, 2007, Ottawa, ON: Department of National Defence

The Globe. The globe, which protects the mantles, is made of glass. This glass becomes dirty during use. It also becomes dirty from bugs, dirt and dust that constantly come in contact with the glass. The glass becomes smudged reducing the amount of light that is emitted from the lantern. Remove the globe from the lantern, carefully lifting it over the mantles. Clean the globe using the cleaning solution and a rag/cloth.

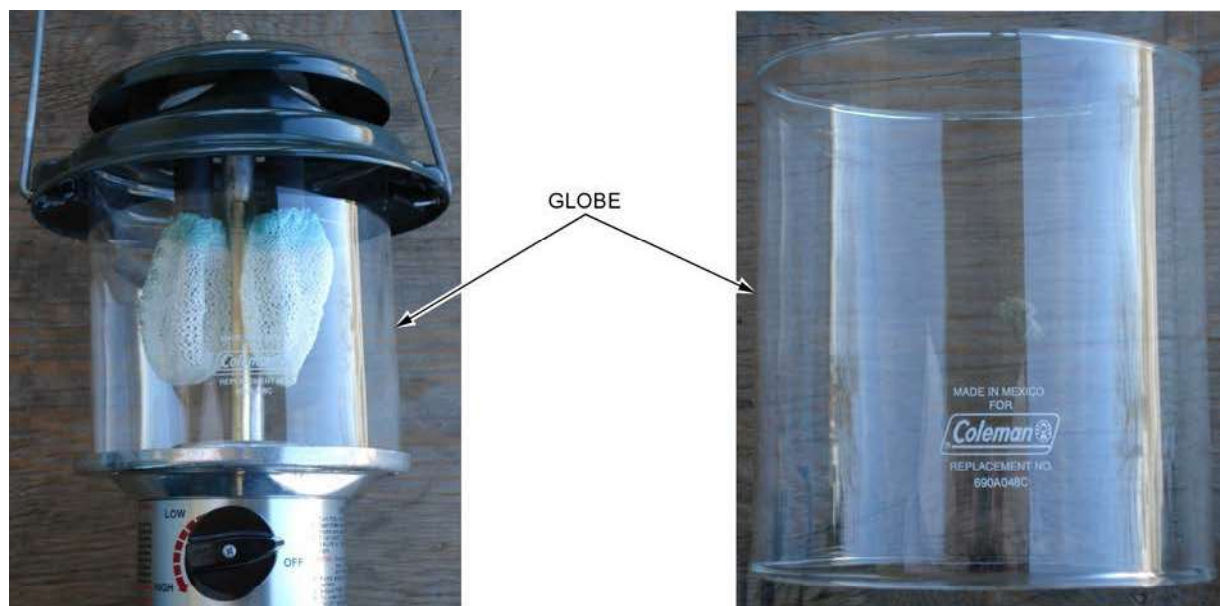

Figure 6 Globe

D Cdts 3, 2007, Ottawa, ON: Department of National Defence

The Fuel Tank. The fuel tank is the reservoir that stores fuel, otherwise known as the font. The fuel tank is used to rest the lantern on flat surfaces, whether it be the ground or a table. This area collects little residue from the exhaust of the lantern; however, it is exposed to moisture and dirt. Cleaning the outside of fuel tank with the cleaning solution is important to slow the corrosion of the metal.



Figure 7 Fuel Tank

D Cdts 3, 2007, Ottawa, ON: Department of National Defence

INSPECTING FOR DAMAGE

After the lantern has been cleaned, it must be inspected for damage. Check the following parts and report any damages:

- ventilator;
- mantle;
- bail;
- globe;
- filler cap;
- control knob;
- fuel tank; and
- pump.

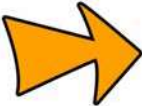

Damages should be recorded on a piece of coloured paper, preferably red, and attached to the damaged part. If the equipment is not suitable for use, remove from usable equipment and report to the designated quartermaster to have the item replaced or repaired.

ENSURING THE FUEL TANK IS EMPTY PRIOR TO STORAGE

Ensure the fuel tank is stored with no remaining pressure. To release the pressure, loosen the filler cap until the pressure is gone, then retighten the cap.

The fuel tank must be emptied prior to storage. Any remaining fuel should be drained into a fuel container. To drain the fuel tank, use a funnel and pour the remaining contents of the fuel tank into a fuel container.



Drain the fuel tank outside and use a spill pan in case spillage occurs.

STORING

Store the Coleman lantern in a cool, dry location away from moisture.

CONFIRMATION OF TEACHING POINT 2



The cadets' participation in cleaning the lantern will serve as the confirmation of this TP. Questions have been provided if additional confirmation is required.

QUESTIONS

- Q1. How does the globe become dirty?
- Q2. What causes the ventilator to become dirty?
- Q3. What parts should be checked for damage?

ANTICIPATED ANSWERS

- A1. The globe becomes dirty from bugs, dirt and dust that constantly come in contact with the glass.
- A2. The ventilator becomes dirty from the exhaust. The exhaust builds up a residue on the ventilator, bail (handle) assembly and its metal parts. This residue over time becomes very greasy and dirty in appearance.
- A3. The following parts should be checked for damage:
 - ventilator;
 - mantle;
 - bail;
 - globe;
 - filler cap;
 - control knob;
 - fuel tank; and
 - pump.

Teaching Point 3**Explain, Demonstrate and Have the Cadets Practice
Cleaning and Storing a Pot Set**

Time: 10 min

Method: Demonstration and Performance



Provide each group with a pot set. Have cadets follow along with the instruction, cleaning equipment as it is covered.

CLEANING SOLUTION

Cleaning a pot requires only a light mixture of dish soap and water and an old rag/cloth. To mix the solution, apply a few drops of dish soap in a wash bucket filled with water.

CLEANING

After use, the pot set may be left with deposits of food, soot from burning flames and possibly dirt or mud from being placed on the ground. Cleaning the inner and outer walls after use will prolong the life of the pot set and keep it sanitary.

DRYING

Once all parts have been washed it is important to dry the set. To dry the set, air dry or use a dry cloth to absorb the remaining moisture. Storing a wet pot set can be dangerous and unsanitary. A pot set that is stored wet may eventually become mouldy. This may result in someone becoming sick.



Figure 8 Pot Set

D Cdts 3, 2007, Ottawa, ON: Department of National Defence

INSPECTING FOR DAMAGE

After the pot set has been cleaned and dried it must be inspected for damage. Check the following parts and report any damages:

- pot walls;
- handle;

- handle hinge;
- cover; and
- additional smaller pots, if included.

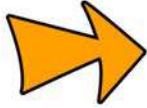

Damages should be recorded on a piece of coloured paper, preferably red, and attached to the damaged part. If the unit is not suitable for use, remove from usable equipment and report to the designated quartermaster to have the item replaced or repaired.

STORING

Store the pot set in a cool dry, location away from moisture.

CONFIRMATION OF TEACHING POINT 3



The cadets' participation in cleaning the pot set will serve as the confirmation of this TP. Questions have been provided if additional confirmation is required.

QUESTIONS

- Q1. What parts of the pot must be cleaned?
- Q2. Why should a pot set be dried?
- Q3. What parts of a pot set must be checked for damage?

ANTICIPATED ANSWERS

- A1. The inner and outer walls and the cover must be cleaned.
- A2. A pot set that is not dried and is stored wet may become mouldy and unsanitary to use for cooking.
- A3. The following parts should be checked for damage:
 - pot walls;
 - handle;
 - handle hinge;
 - cover; and
 - additional smaller pots, if included.

Teaching Point 4**Explain, Demonstrate and Have the Cadets Practice
Cleaning and Storing the Following Field Tools**

Time: 10 min

Method: Demonstration and Performance



Provide each group with field tools. Have cadets follow along with the instruction, cleaning equipment as it is covered.

AXE**Washing and Drying**

Cleaning an axe with a cleaning solution is only required when the axe is noticeably covered in dirt or clay. If the axe must be washed, ensure to thoroughly dry the surfaces as left over moisture may rust the axe head and degrade the wooden handle.

Applying Storage Oil

To avoid rusting, rub a few drops of oil on the axe head. It will reduce the chances of corrosion to the axe blade. Oil type is not important.

The axe handle should be rubbed with linseed oil. Linseed oil helps wood retain its natural moisture content which retards cracking, chipping, and shrinking. Linseed oil also repels water.

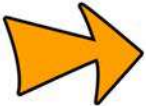

To keep the handle well oiled drill a one quarter inch diameter hole three inches into the butt of the handle. Fill with linseed oil and plug the hole with a wood stopper.

Inspecting for Damage

After the axe has been cleaned and oiled it must be inspected for damage.

Handle. The handle should be inspected for chipping, cracks or splits that may weaken the wood of the handle. Look around the area where the head of the axe and the handle meet. It is common to find splits and cracks here.

Axe Head. The axe head should be checked to ensure it is tight and does not wobble or move. Check the blade for any dents or chips and feel the sharpness of the blade by gently rubbing the thumb across the blade.



Damages should be recorded on a piece of coloured paper, preferably red, and attached to the damaged part. If the unit is not suitable for use, remove from usable equipment and report to the designated quartermaster to have the item replaced or repaired.

Storing

Store the axe in a cool, dry location away from moisture.



Figure 9 Single-bit Axe

D Cds 3, 2007, Ottawa, ON: Department of National Defence

BOW SAW

Washing and Drying

Cleaning a saw with a cleaning solution is only required when the saw is noticeably covered in dirt or clay. If the saw must be washed, ensure to thoroughly dry the surfaces as left over moisture may rust the saw handle and blade.

Applying Storage Oil

To avoid rusting, put a few drops of oil on the blade. It will reduce the chances of corrosion to the saw blade. Oil type is not important. If there is a buildup of tree sap on the blade use kerosene to remove the deposits.

Inspecting for Damage

After the saw has been cleaned and oiled it must be inspected for damage.

Blade. Inspect the blade for dull or missing teeth and if it has lost shape. If any of these damages exist, the blade must be replaced.

Handles or “Cheeks”. Inspect the handles to ensure they are still in good repair. Ensure the metal has not become fatigued (weak in areas) or no major dents are apparent that may weaken the saw.

Frame. Much like the handles, inspect the frame for any metal fatigue or dents that may weaken the saw.



Damages should be recorded on a piece of coloured paper, preferably red, and attached to the damaged part. If the equipment is not suitable for use, remove from usable equipment and have the item replaced or repaired.

Storing

Store the bow saw in a cool, dry location away from moisture.



Figure 10 Bow Saw

D Cdts 3, 2007, Ottawa, ON: Department of National Defence

CONFIRMATION OF TEACHING POINT 4



The cadets' participation in cleaning field tools will serve as the confirmation of this TP. Questions have been provided if additional confirmation is required.

QUESTIONS

- Q1. What should be used to remove a buildup of tree sap on the blade?
- Q2. When inspecting for damage to the blade, what should a person look for?
- Q3. What should be placed on the blade to prevent rusting or corrosion?

ANTICIPATED ANSWERS

- A1. Kerosene is to be used when removing tree sap from the blade.
- A2. Inspect the blade for dull or missing teeth and if it has lost its shape.
- A3. A light coating of any type of oil will prevent rusting or corrosion of the metal blade.

Teaching Point 5**Explain, Demonstrate and Have the Cadets Practice
Cleaning and Storing Groundsheets**

Time: 10 min

Method: Demonstration and Performance



Provide each group with a groundsheet. Have cadets follow along with the instruction, cleaning and folding the groundsheet as it is covered.

WASHING AND DRYING

Cleaning a groundsheet is only required when it is noticeably covered in dirt or clay. If the groundsheet must be washed, use only water. Any type of cleaning solution will remove the waterproofing elements of the groundsheet. Ensure to thoroughly dry the surfaces, as left over moisture may break down and weaken the groundsheet.

FOLDING

To fold the groundsheet complete the following steps:

1. Ensure the groundsheet is completely dry.
2. Lay the groundsheet out, with the inside facing up (Step 1, Figure 11).
3. Fold the ends in to make a rectangle (Step 2, Figure 11).
4. Fold in half by bringing the right side to the left side (Step 3, Figure 11).
5. Fold the ends to the centre – right end to the centre, left end to the centre (Step 4, Figure 11).
6. Fold in half bringing right side to the left side (Step 5, Figure 11).
7. If the storage bin is smaller make more folds following the same pattern to reach the desired size for storage.



STEP 1



STEP 2



STEP 3

Figure 11 (Sheet 1 of 2) Folding a Groundsheet
D Cdts 3, 2007, Ottawa, ON: Department of National Defence



STEP 4



STEP 5

Figure 11 (Sheet 2 of 2) Folding a Groundsheet
D Cds 3, 2007, Ottawa, ON: Department of National Defence

STORING

The groundsheet should be stored in a cool, dry location out of direct sunlight. Storage bins or large plastic containers work well to organize and store groundsheets.

CONFIRMATION OF TEACHING POINT 5



The cadets' participation in folding a groundsheet will serve as the confirmation of this TP. Questions have been provided if additional confirmation is required.

QUESTIONS

- Q1. What should be used to clean a groundsheet?
- Q2. What would a cleaning solution do to a groundsheet?
- Q3. Where should a groundsheet be stored?

ANTICIPATED ANSWERS

- A1. Water should be used to clean a groundsheet.
- A2. A cleaning solution may damage or remove the waterproofing of the groundsheet.
- A3. A groundsheet should be stored in a cool dry location out of direct sunlight.

END OF LESSON CONFIRMATION

The cadets' participation in cleaning and inspecting the equipment will serve as the confirmation of this lesson.

CONCLUSION

HOMEWORK/READING/PRACTICE

N/A.

METHOD OF EVALUATION

N/A.

CLOSING STATEMENT

The ability to maintain section equipment after use in the field will prolong its life. Allowing cadets to clean and maintain section equipment will develop a sense of ownership, ensure the items are well cared for and will ensure they last for others to use.

INSTRUCTOR NOTES/REMARKS

N/A.

REFERENCES

C0-111 ISBN 978-0-9740820-2-8) Tawrell, P. (2006). *Camping and Wilderness Survival: The Ultimate Outdoors Book* (2nd ed.). Lebanon, NH: Leonard Paul Tawrell.

THIS PAGE INTENTIONALLY LEFT BLANK



ROYAL CANADIAN ARMY CADETS

RED STAR

INSTRUCTIONAL GUIDE



SECTION 10

EO C221.01 – PARTICIPATE IN A DISCUSSION ON CANADA'S WILDERNESS CONSERVATION EFFORTS

Total Time:

60 min

PREPARATION

PRE-LESSON INSTRUCTIONS

Resources needed for the delivery of this lesson are listed in the lesson specification located in A-CR-CCP-702/PG-001, Chapter 4. Specific uses for said resources are identified throughout the Instructional Guide within the TP for which they are required.

Review the lesson content and become familiar with the material prior to delivering the lesson.

PRE-LESSON ASSIGNMENT

N/A.

APPROACH

An interactive lecture was chosen for TP1, TP2, and TP4 to introduce the cadets to wilderness conservation and to generate interest.

An in-class activity was chosen for TP3 as it is an interactive way to provoke thought and stimulate interest among cadets.

INTRODUCTION

REVIEW

N/A.

OBJECTIVES

By the end of this lesson the cadet shall have developed an appreciation for Canada's wilderness conservation efforts.

IMPORTANCE

It is important for cadets to appreciate the wilderness environment as well as understand the impact they have on it. The environment is very fragile and each cadet should have respect for the land we share. As Army Cadets, there is a need to contribute to efforts which help keep the natural environment's integrity.

Teaching Point 1**Define and Explain Environmental Terms**

Time: 10 min

Method: Interactive Lecture

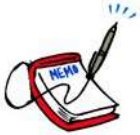

Explain the following terms.

ENVIRONMENTAL TERMS

Conservation. Conservation is defined as using natural resources (e.g. soil, water, minerals, wildlife, and sunlight) in a way that ensures continued availability for future generations. It includes the preservation, maintenance, usage, restoration, and enhancement of the environment.

Land Ethic. Land ethic is respecting, valuing, and having concern for the natural world.

Ecosystem. An ecosystem is the interaction of living organisms and their environment. Ecosystems include:

- **Abiotic Components.** Physical elements such as water and rocks.
- **Biodiversity.** A composition of communities which have different species. For example, species found in a rainforest will differ from species found in the tundra.
- **Ecosystem Processes.** The engines that make ecosystems work, such as fires, floods, and predation (animals preying on other animals).

Ecological Integrity. Ecosystems have integrity when all components (abiotic, biodiversity, and ecosystem processes) are functioning together. People should enjoy parks without damaging these components.

Natural Resources Canada. Natural Resources Canada (NRCan) is responsible for ensuring proper development of Canada's natural resources, including energy, forests, minerals, and metals. They maintain an up-to-date knowledge base of Canadian land masses and resources.

NRCan is responsible for developing policies and programs to enhance the contribution of the natural resource sector to the economy and to improve the quality of life for all Canadians.

Provincial and National Parks. Provincial and national parks are owned by all Canadians. They are protected from most human development and pollution. The aim of these parks is to promote enjoyment by the public while conserving and enhancing the natural beauty, wildlife, and cultural heritage they contain. These parks are protected by government laws.

The mandate of national parks is to protect lands and waters that represent Canada's natural coast to coast diversity, in a way that restores or maintains ecological integrity, and in a way that allows for visitor activities and appreciation.

Crown Land. Any land that is owned by the federal or provincial government is crown land. Control and authority is placed on the Crown. The amount of crown land varies from province to province. National parks, provincial parks, native reserves, federal military bases, and provincial forests are all various forms of crown land.

Protected Areas. To ensure natural features are safe, areas of land are declared protected. Once declared protected, these areas are subject to numerous laws which help safeguard its interests. There are many protected areas across Canada, such as the Nahanni National Park Reserve of Canada, located in the Northwest Territories.

CONFIRMATION OF TEACHING POINT 1

QUESTIONS

- Q1. What is conservation?
- Q2. What are the three components of an ecosystem?
- Q3. What is a protected area?

ANTICIPATED ANSWERS

- A1. Conservation is defined as using natural resources (e.g. soil, water, minerals, wildlife, sunlight) in a way that ensures continued availability for future generations. It includes the preservation, maintenance, usage, restoration, and enhancement of the environment.
- A2. The three components of an ecosystem are abiotic components, biodiversity, and ecosystem processes.
- A3. A protected area is an area of land that has been declared protected.

Teaching Point 2

Discuss Human Impact on Park Environments

Time: 15 min

Method: Interactive Lecture



There are many ways cadets can contribute to minimizing the level of human impact on park environments. Though these points are tailored to Parks Canada and national parks, they should be considered for any bivouac site used by cadets.

ECOSYSTEM MANAGEMENT

By working closely with other land management agencies, Parks Canada demonstrates leadership in their goal to develop a better understanding of the relationship between existing land use practices and their effects on the natural environment.

It involves an understanding and a partnership among all those whose activities influence the ecological integrity of the park. For example, a cadet corps holding a weekend bivouac FTX may put strain on the environment through daily activities such as setting up shelters, constructing and lighting fires, and disposing of wastes. Other agencies and people also have an impact on this park ecology.

The concept of partnerships is also important since universities, conservation organizations, and the private sector have a lot to contribute towards research and environmental monitoring initiatives within national parks.

SUSTAINABLE DEVELOPMENT

Sustainable development involves meeting the needs of the present without compromising the needs of future generations. It is a way of thinking and acting. It is also a way of ensuring that social, economic, and environmental considerations are integrated into our decisions and our actions. Choices made now will affect choices that people can make for years to come.

The Government of Canada submits a sustainable development strategy (SDS) to Parliament every three years. Once this is approved, Parks Canada develops their SDS which outlines how they will integrate the principles into their policies, programs, legislation, and operations.

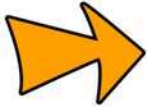

Sustainable development strategies are developed every three years and can be accessed by searching “sustainable development strategy” in the Parks Canada or Environment Canada Website.

ENVIRONMENT CANADA’S PROTECTED AREAS

The purpose of Environment Canada’s protected areas is to preserve rich and diverse populations. The Canadian Wildlife Service (CWS) is a part of Environment Canada. CWS is responsible for the protection and management of migratory birds and nationally significant habitats and endangered species. They also work on other wildlife issues of national and international importance, as they arise.

CWS works with many groups to ensure that areas are protected. There are approximately 11.8 million hectares of protected wildlife habitat – an area more than twice the size of Nova Scotia.

Components of this network include:

- National Wildlife Areas (NWAs),
- Migratory Bird Sanctuaries (MBSs), and
- Marine Wildlife Areas (MWAs).

Most protected areas permit public access and some offer visitor facilities, activities, and services. There may be exhibits, trails, brochures, and viewing stands to help visitors understand their surroundings. Canadian Wildlife Services has prohibited visitation to some protected areas during critical periods such as nesting and moulting (shedding feathers or hair).

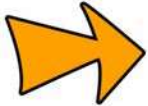

To find out more information about Environment Canada’s protected areas, consult the following Websites:

- <http://www.cws-scf.ec.gc.ca>, or
- <http://www.hww.ca/hww2.asp?cid=4&id=231>.

LOCAL, REGIONAL, AND GLOBAL CONCERNS

Movement of Exotic Species

Exotic species are also commonly known as invasive species and refer to plants, animals, fungi, or other organisms that have been accidentally or purposefully introduced to an area outside of their origin.

Introductions can be accidental or intentional. The results of these introductions can vary from damaging the habitat to having no effect. A species may be introduced because it appears to be beneficial for the environment or through planting impure seeds. Some species may appear after disasters such as forest fires. Humans may carry some of these species when travelling. Species have been found on vehicles and clothing. This is normally accidental.

Though the majority of introduced plant species do not pose ecological or economic problems, some have become quite harmful in their new habitat. For an introduced species to become an invader, it must arrive, survive, and thrive.



An invasive species: The Zebra Mussel

The zebra mussel, which originated in eastern Europe, is a freshwater mollusc that was accidentally introduced to the Great Lakes. It was discharged in water from ship's ballast tanks in 1986, and has flourished ever since. After being in a favourable environment for about five years, it can reach densities of hundreds of thousands per square metre.

The zebra mussel is a nuisance species and brings with it many concerns. It blocks conduits (water intakes, pipelines, tunnels), corrodes ship hulls, covers wrecks, causes loss of habitat, and changes the performance of ecosystems. There have been a few solutions tried, which have not been very effective. The cost of the invasion can cost millions of dollars each year, mainly for cleaning and control measures.

Air and Water Pollution

Air pollution is a huge environmental concern. The quality of air is an important factor in the quality of life. It is generated by many sources, such as the burning of fossil fuels from industries, transportation, and heating.

Water sources such as lakes, rivers, streams, and runoffs become polluted when feces come into contact with the water. As a rule, a person should be at least 60 m from water before defecating. Animal feces will also pollute water sources.

Greenhouse Gas Emissions

(Adapted from *The Climate is Changing our National Parks*, Parks Canada, Government of Canada).

The Earth's climate changes through natural processes, but also as a result of greenhouse gas (GHG) emissions.

There has been an increase in global temperature over the last 100 years. The effects of climate change are evident on a local to a global scale. Sea levels are rising, polar ice is melting and weather is becoming less predictable.

Parks Canada is trying to reduce the GHG impacts of its operations and activities, by:

- reducing the size, fuel use, and GHG emissions of its passenger cars and light trucks;
- improving the energy-efficiency of its buildings and facilities; and
- increasing the use of renewable energy technologies.

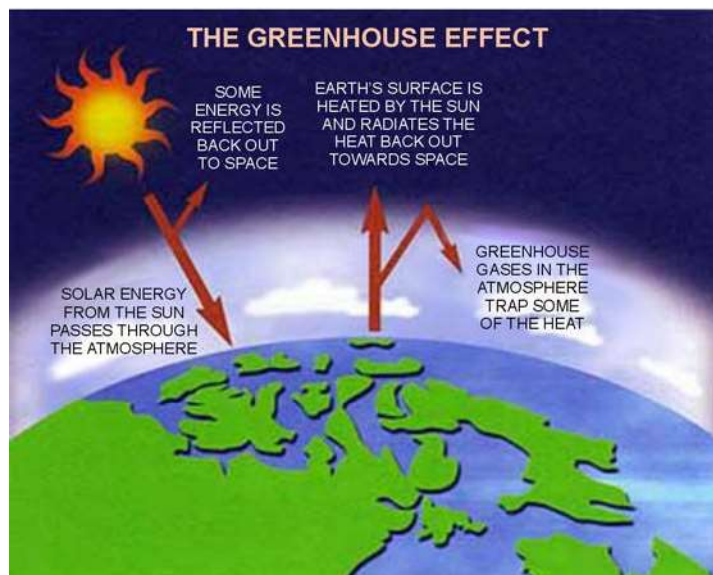

Figure 1 The Greenhouse Effect

Parks Canada, 2007, The Climate is Changing our National Parks. Copyright 2007 by Government of Canada. Retrieved 21 March 2007, from http://www.pc.gc.ca/docs/v-g/ie-ei/cc/climate_e.asp

Solid Waste Management

Everything carried into a site should be carried out. Park communities are no exception. Collectively, park residences and commercial establishments such as restaurants and hotels generate huge volumes of garbage and food waste.

Bears are a huge concern directly related to waste management. Bear-proof management of garbage is essential for the safety of people and the protection of bears and other wildlife.

Efforts to reduce, reuse, and recycle go a long way to cutting down on the amount of garbage generated. This helps reduce the consumption of valuable resources and the need for valuable land to be converted to landfills.

Wastewater Management

There will always be some leftover water, either from cooking or bathing. Never dispose of wastewater close to a stream. If it must be done, carry the water at least 60 m away from streams or lakes. Dishwater should be strained and scattered.

Water Conservation

Drinking contaminated water can be very serious. When camping, conserve whatever water you have and seek a reliable source as soon as possible.

CONFIRMATION OF TEACHING POINT 2

QUESTIONS

- Q1. A sustainable development strategy is planned and implemented how often?
- Q2. Approximately how much area is designated as protected wildlife habitats?
- Q3. What are the local, regional, and global concerns?

ANTICIPATED ANSWERS

- A1. A sustainable development strategy is planned for and implemented for three years.
- A2. Approximately 11.8 million hectares of land is declared as protected wildlife habitat.
- A3. The local, regional, and global concerns are movement of exotic species, air and water pollution, greenhouse gas emissions, solid waste management, wastewater management, and water conservation.

Teaching Point 3**Conduct a Conservation Activity**

Time: 15 min

Method: In-Class Activity

ACTIVITY**OBJECTIVE**

The objective of this activity is to brainstorm environmental efforts in which the cadets can participate to help conserve the environment.

RESOURCES

- One sheet of flipchart paper per group;
- Tape; and
- A marker.

ACTIVITY LAYOUT

N/A.

ACTIVITY INSTRUCTIONS

1. Divide the cadets into groups of a maximum of six.
2. Allow five minutes for the cadets to brainstorm, writing their responses on flipchart paper. Ask the cadets about the environmental efforts they take to help conserve the environment:
 - at home;
 - at school; and
 - in the field.



Following the principles of Leave No Trace camping is a key step in environmental conservation.

3. Tape each group's flipchart paper on a wall or in a place visible to all the cadets.
4. Discuss the points that the cadets brainstormed.

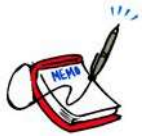

Some points may not be easy to implement; however, there are always small steps that cadets can take to ensure that people enjoy the environment for years to come.

SAFETY

N/A.

CONFIRMATION OF TEACHING POINT 3

The cadets' participation in the in-class activity will serve as the confirmation of this TP.

Teaching Point 4

Discuss the Duties of Park Conservation Officials

Time: 10 min

Method: Interactive Lecture

DUTIES OF PARK CONSERVATION OFFICIALS

Study, Monitor, and Manage Ecosystems

Park conservation officials ideally have an education in natural science or natural resource management. Their knowledge is used to collect scientific information, assess the condition of heritage resources, and monitor ecological integrity. They contribute to the preparation of management plans and play a direct role in implementing ecosystem management plans. This involves research, monitoring wildlife, capturing animals, and relocating them in rare instances when they pose a public safety hazard.

Serve as Public Spokespersons

Park conservation officials are normally well trained and educated. They are great advocates for the public. It is their duty to keep the public informed about park issues, and to deliver public safety programs. Through public education and awareness, visitors understand their role in park conservation and accident prevention.

Conduct Search and Rescue Operations

Park conservation officials are trained in first aid and rescue procedures. They respond when people are lost, injured, or endangered. Park conservation officials are responsible for providing search and rescue missions and evacuations in all kinds of terrain and environmental conditions. They implement avalanche control, fire prevention, wildlife/human safety measures, and safety inspections. Cooperation with police, provincial conservation officers, and other resource management and enforcement agencies is a vital key.

Maintain Public Safety

Park conservation officials assess the risks involved from visitor activities. This includes monitoring environmental hazards and reducing incidents through public education and awareness.

Enforce Park-Specific Laws and Regulations

Each park has a set of rules for the public to abide by. Park conservation officials ensure that these rules are being followed, and impose penalties to those who disobey.

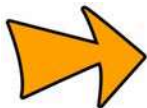

For more information about on the duties of park officials, visit Parks Canada's Website at http://www.pc.gc.ca/agen/empl/itm3-/emp3a2_e.asp.

CONFIRMATION OF TEACHING POINT 4

QUESTIONS

- Q1. Ideally, what type of education do park officials have?
- Q2. How do park officials serve the public?
- Q3. What types of search and rescue procedures do park officials implement?

ANTICIPATED ANSWERS

- A1. Ideally, park officials are educated in natural science or natural resource management.
- A2. Park officials serve the public through public education and awareness, visitors understand the role of park officials in park conservation and accident prevention.
- A3. Park officials implement avalanche control, fire prevention, wildlife/human safety measures, and safety inspections.

END OF LESSON CONFIRMATION

QUESTIONS

- Q1. What are provincial and national parks?
- Q2. What is Parks Canada doing to try to reduce the GHG impacts of its operations and activities?
- Q3. What are the duties of park conservation officials?

ANTICIPATED ANSWERS

- A1. Provincial and national parks are owned by all Canadians. They are protected from most human development and pollution. The aim of these parks is to promote enjoyment by the public while conserving and enhancing the natural beauty, wildlife, and cultural heritage they contain. These parks are protected by government laws.
- A2. Parks Canada is trying to reduce the GHG impacts of its operations and activities by:
- reducing the size, fuel use, and GHG emissions of its passenger cars and light trucks;
 - improving the energy efficiency of its buildings and facilities; and
 - increasing the use of renewable energy technologies.
- A3. Park conservation officials are responsible for studying, monitoring and managing ecosystems, serving as public spokespersons, conducting search and rescue operations, maintaining public safety and enforcing park-specific laws and regulations.

CONCLUSION

HOMEWORK/READING/PRACTICE

N/A.

METHOD OF EVALUATION

N/A.

CLOSING STATEMENT

There are small steps that everyone can take to help conserve the environment. Protecting the environment is everyone's responsibility. When cadets are in the field, conservation should be a key factor when making decisions that could affect the environment.

INSTRUCTOR NOTES/REMARKS

This lesson may be delivered by a guest speaker. The guest speaker should present park-specific duties for which they are responsible, while stressing the importance of conserving the environment.

REFERENCES

C2-052 Parks Canada. (2007). *Parks Canada*. Retrieved 22 February 2007, from http://www.pc.gc.ca/agen/index_E.asp.

C2-053 Canadian Wildlife Service and Canadian Wildlife Federation. (2007). *Hinterland Who's Who – Environment Canada's Protected Areas Network*. Retrieved 22 February 2007, from <http://www.hww.ca/hww2.asp?cid=4&id=231>.

C2-054 Office of the Auditor General of Canada. (2007). *Office of the Auditor General of Canada*. Retrieved 22 February 2007, from <http://www.oag-bvg.gc.ca/domino/oag-bvg.nsf/html/menue.html>.

C2-066 Environment Canada. (2007). *Canada's Clean Air Act*. Retrieved 21 March 2007, from <http://www.ec.gc.ca/cleanair-airpur/default.asp?lang=En&n=6EBBF05D-1>.

C2-067 Natural Resources Canada. (2007). *About Us*. Retrieved 21 March 2007, from http://www.nrcan-nrcan.gc.ca/inter/aboutus_e.html.

C2-070 Environment Canada. (2004). *Canadian Wildlife Service: Focus on the Canadian Wildlife Service*. Retrieved 23 March 2007, from http://www.cws-scf.ec.gc.ca/focus_e.cfm#targ1.

C2-071 Environment Canada. (2002). *The Unfolding Story of the Zebra Mussel in the St. Lawrence River*. Retrieved 23 March 2007, from http://www.qc.ec.gc.ca/csl/pub/pub004_e.html.



ROYAL CANADIAN ARMY CADETS

RED STAR

INSTRUCTIONAL GUIDE



SECTION 11

EO C221.02 – CONSTRUCT FIELD AMENITIES

Total Time:

180 min

PREPARATION

PRE-LESSON INSTRUCTIONS

Resources needed for the delivery of this lesson are listed in the lesson specification located in A-CR-CCP-702/PG-001, Chapter 4. Specific uses for said resources are identified throughout the Instructional Guide within the TP for which they are required.

Review the lesson content and become familiar with the material prior to delivering the lesson.

Make copies of the handouts located at Annexes A and B for each cadet.

PRE-LESSON ASSIGNMENT

Each cadet must gather three sticks or poles approximately one inch in diameter prior to this lesson.

APPROACH

Demonstration and performance was chosen for TP1 as it allows the instructor to explain and demonstrate tying lashings while providing an opportunity for the cadets to practice tying lashings under supervision.

A practical activity was chosen for TP2 as it is an interactive way to allow the cadet to experience building field amenities in a safe, controlled environment. This activity contributes to the development of lashing skills and knowledge in a fun and challenging setting.

INTRODUCTION

REVIEW

A review of the parts of a rope, from EO M121.03 (Tie Knots and Lashings) may be required before beginning this lesson.

OBJECTIVES

By the end of this lesson the cadet shall have constructed two field amenities, using knots and lashings.

IMPORTANCE

It is important for cadets to know how to tie knots and lashings. Constructing field amenities is a fun way to incorporate knot tying to enhance a field training site.

Teaching Point 1**Explain, Demonstrate, and Allow Time for Cadets to Practice Tying Lashings**

Time: 40 min

Method: Demonstration and Performance



Distribute handouts for tying lashings.

For this skill lesson it is recommended that instruction take the following format:

1. Explain and demonstrate that complete skill while cadets observe.
2. Explain and demonstrate each step required to complete the skill. Monitor cadets as they imitate each step.
3. Monitor the cadets' performance as they practice the complete skill.

Note: Assistant instructors may be employed to monitor cadet performance.

SHEER LASHING

Also called a round lashing, it has two distinct uses. First, it creates an A-frame or set of sheer legs. Second, two or three sheer lashings can be used to bind poles together to make a longer spar (horizontal pole).

Procedure

1. Make a clove hitch around both poles.
2. Wrap the standing end around both poles, trapping the working end of the clove hitch underneath.
3. Make eight to ten more wraps around the poles.
4. Bring the rope up between the spars and make two tight turns parallel to the poles.
5. Make a clove hitch around one of the poles.
6. Ensure the lashing is tight and secure.
7. Sheer lashing opened to create a pair of sheer legs or an A-frame.

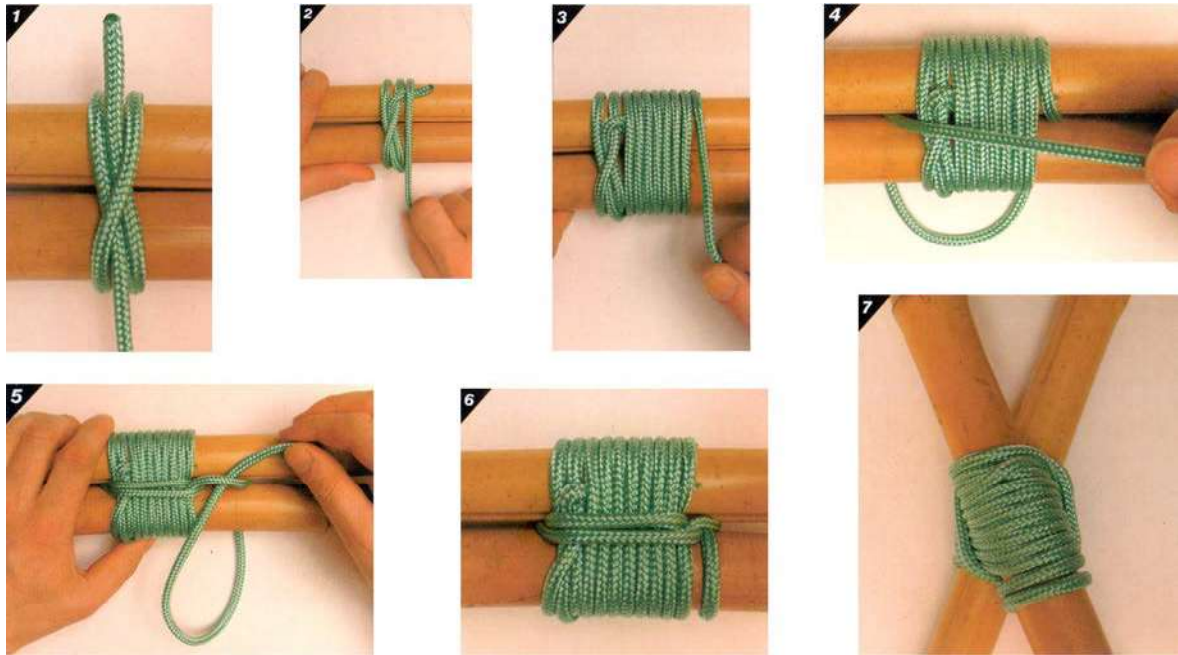

Figure 1 Sheer Lashing

Pawson, D., *Pocket Guide to Knots & Splices*, Chartwell Books, Inc. (pp. 184-185)

SQUARE LASHING

A square lashing secures two poles together at 90 degrees. The rope used to make the lashing should be considerably smaller than the size of the poles. For the lashing to be effective, each turn must be pulled as tight as possible as it is made.

Procedure

1. With the vertical pole on top of the horizontal pole, make a clove hitch. The vertical pole runs up and down, and the horizontal pole left to right.
2. Bring all of the rope around and behind the horizontal pole.
3. Tightly bring the rope over the vertical pole and back behind the horizontal pole, back to the clove hitch.
4. Continue to make three complete turns around the poles, pulling the rope tight after each turn.
5. After passing the clove hitch, tightly bring the rope to the horizontal pole from behind and start wrapping around the two poles. These wraps are called frapping turns.
6. Make two complete sets of frapping turns.
7. Make a clove hitch around the horizontal pole.
8. Ensure lashing is tight and secure.

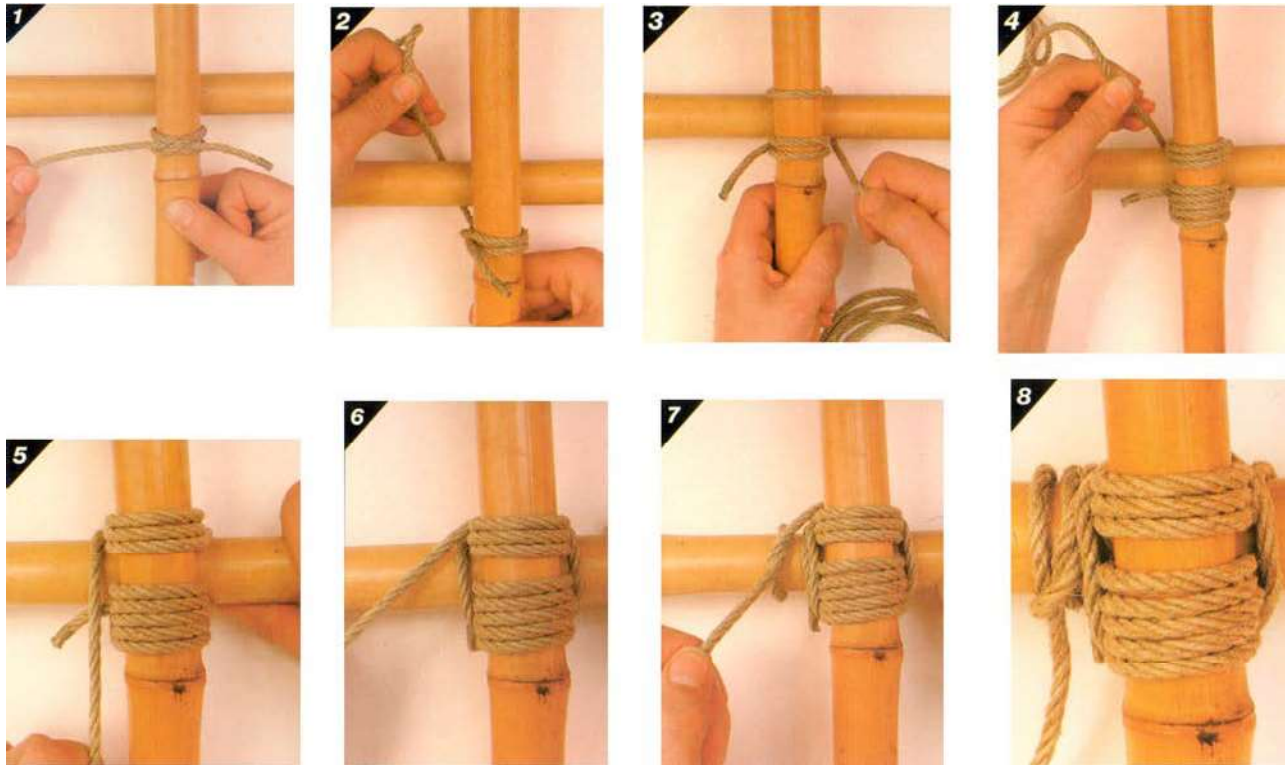

Figure 2 Square Lashing

Pawson, D., Pocket Guide to Knots & Splices, Chartwell Books, Inc. (pp. 180-181)

TIMBER HITCH



The timber hitch is included because it is required for the diagonal lashing. It should not take a great amount of time to complete.

Procedure

1. Take the standing end and wrap it around the object, then around the standing part of the rope.
2. Twist the working part around itself by wrapping it around the working end.
3. Continue making twists until the twisted rope is long enough to go around the object. Pull on the standing part to tighten the hitch.



Figure 3 Timber Hitch

Pawson, D., Pocket Guide to Knots & Splices, Chartwell Books, Inc. (p. 139)

DIAGONAL LASHING

A diagonal lashing is used at a crossing point, to prevent poles from springing apart.

Procedure

1. Make a timber hitch around the two crossed poles.
2. Make a turn around the two crossed poles, pulling the timber hitch tight.
3. Make three more complete turns in the same direction, pulling them tight.
4. Change direction by coming around one of the poles.
5. Make four full turns around the two poles at right angles to the original turns, pulling them tight.
6. Take the working end of the rope around one of the poles, making a frapping turn.
7. Make two complete frapping turns.
8. Make a clove hitch.
9. Ensure lashing is tight and secure.

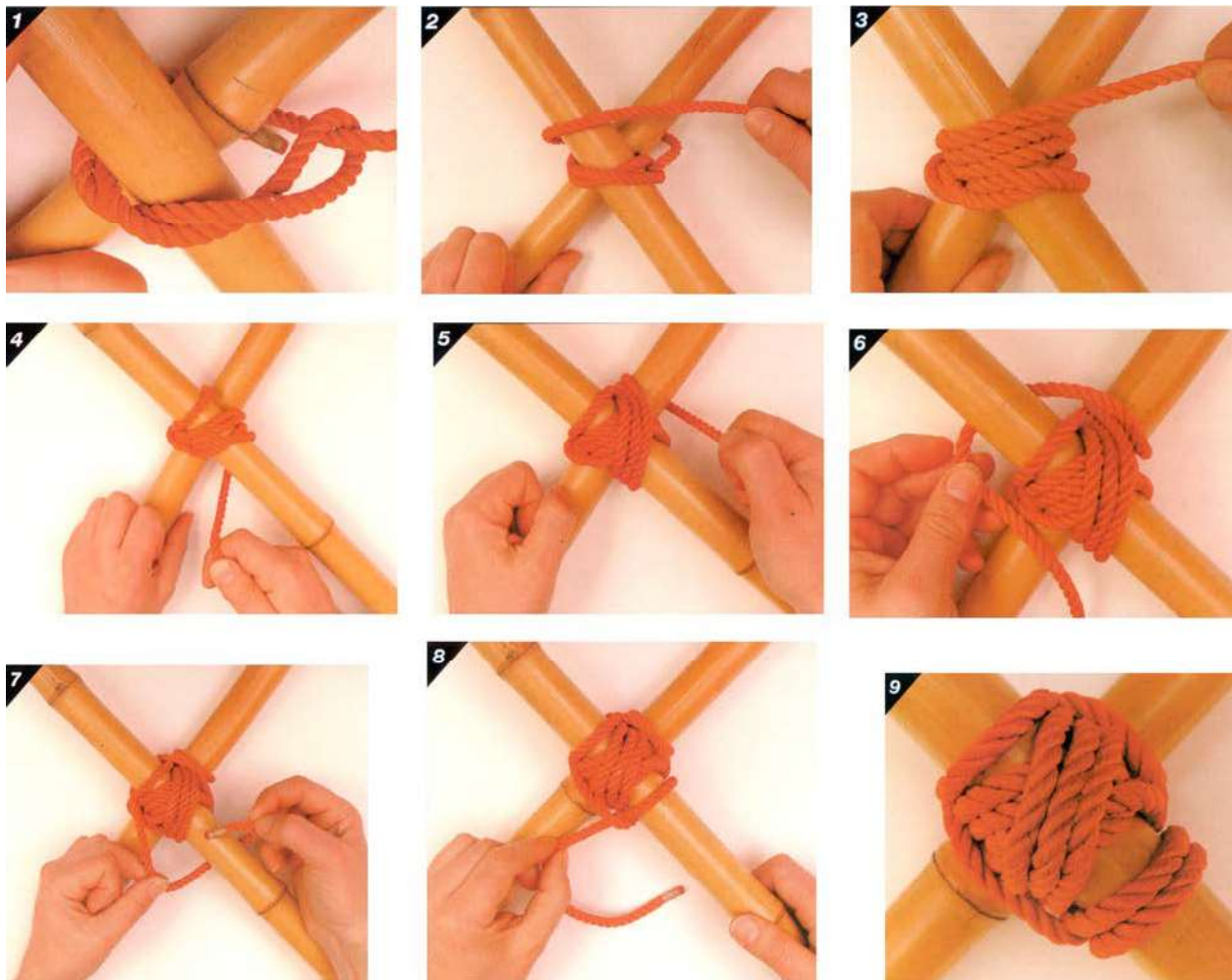



Figure 4 Diagonal Lashing

Pawson, D., Pocket Guide to Knots & Splices, Chartwell Books, Inc. (pp. 182-183)

FIGURE-OF-EIGHT LASHING

The figure-of-eight lashing is used to join three poles together, to create a tripod.



When making a figure-of-eight lashing, the poles shall be placed staggered (see diagram below).



Procedure

1. Make a clove hitch around one of the outside poles. Bring the rope under and over the other poles.
2. Go around the pole furthest away from the start and weave the rope back over and under.

3. Continue to weave the rope under and over eight times. Bring the rope up in between any two poles.
4. Pull the rope parallel to the poles and put in two frapping turns.
5. Make three frapping turns in between the remaining poles.
6. Make a clove hitch around the pole that already has a clove hitch (from the beginning) at the opposite end.
7. Open up the poles.

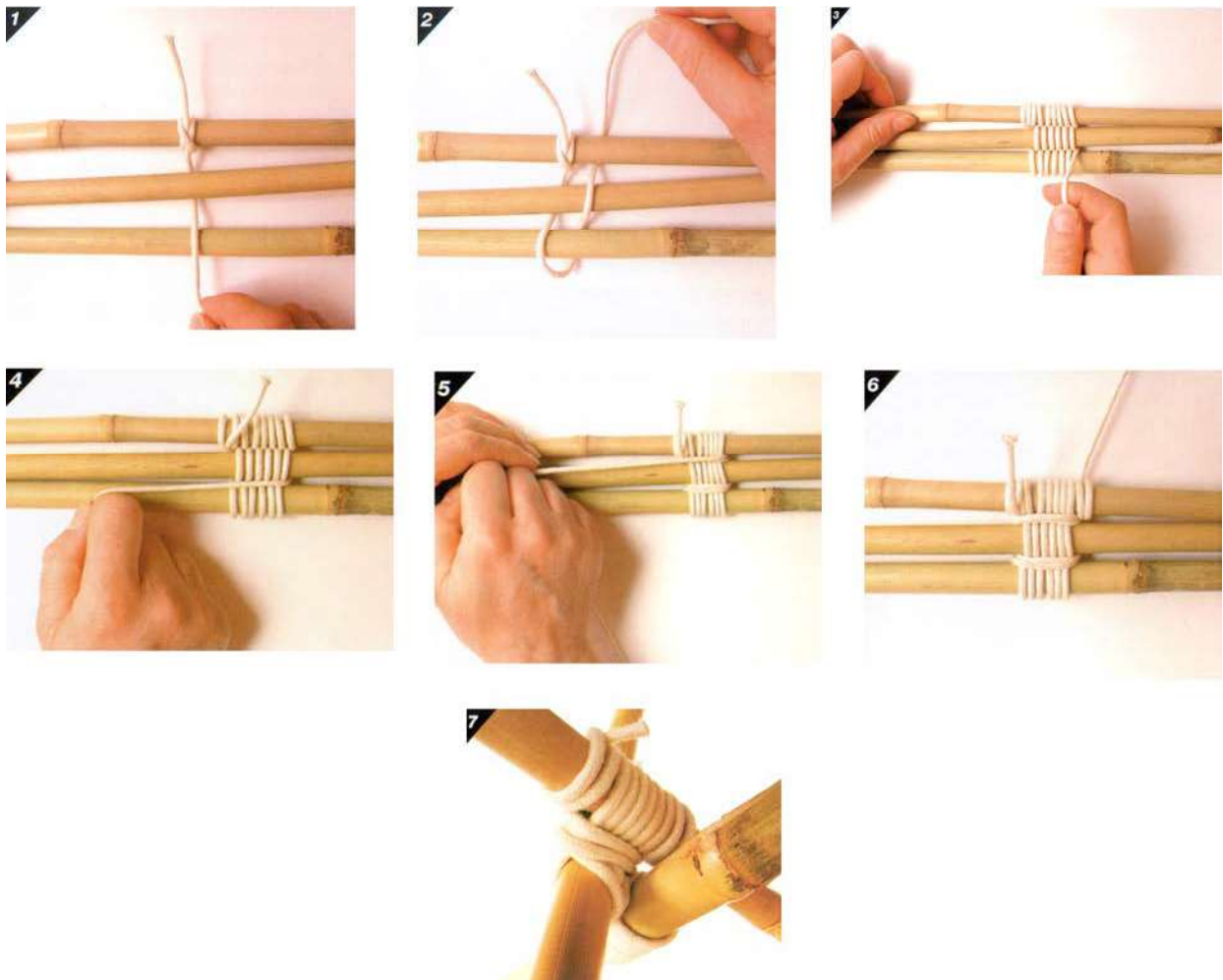

Figure 5 Figure-of-eight Lashing

Pawson, D., Pocket Guide to Knots & Splices, Chartwell Books, Inc. (pp. 187-188)

CONFIRMATION OF TEACHING POINT 1

The cadets' participation in tying the lashings will serve as the confirmation of this TP.

Teaching Point 2**Construct Field Amenities**

Time: 130 min

Method: Practical Activity

FIELD AMENITIES

Field amenities will be chosen from the following:

- a bench with back rest;
- a camp table;
- a bulletin board; and
- a podium.



Pictures and instructions of field amenities are located at Annex B.

ACTIVITY**OBJECTIVE**

The objective of this activity is to construct field amenities for a bivouac site, using the knots and lashings learned.

RESOURCES

- Rope;
- Natural resources, found in the field;
- 4 lb axe (36-inch handle);
- 24-inch bow saw; and
- Diagrams of field amenities (located at Annex B).

ACTIVITY LAYOUT

N/A.

ACTIVITY INSTRUCTIONS

1. Divide cadets into groups with a minimum of four and a maximum of eight.
2. Depending on need and availability of resources, allow cadets to choose the field amenity they will construct.
3. Distribute instructions located at Annex B. Cadets will be required to select and utilize the most effective knots and lashings to make their field amenity.

4. When amenities are completed, allow time for groups to view all constructed amenities.
5. Depending on local regulations, all material used in the construction shall be redistributed to the area once the activity is completed.

SAFETY

- Ensure cadets are employing safe tool use at all times.
- The wood chosen for the field amenities must be strong enough to hold a substantial amount of weight.
- Established boundaries shall be respected at all times.

CONFIRMATION OF TEACHING POINT 2

The cadets' participation in the activity will serve as the confirmation of this TP.

END OF LESSON CONFIRMATION

The cadets' participation in the construction of field amenities in TP2 will serve as the confirmation of this lesson.

CONCLUSION

HOMEWORK/READING/PRACTICE

N/A.

METHOD OF EVALUATION

N/A.

CLOSING STATEMENT

Field amenities will enhance any base camp. They are relatively easy to construct and are a fun way to reinforce usage of knots. They can make cadets comfortable in the field when it is a home away from home.

INSTRUCTOR NOTES/REMARKS

Natural resources found in the field, such as fallen or dead wood, are to be used for construction. Instructors are to confirm with local authorities that natural resources may be used for this activity.

If field amenities are being evaluated, they shall be judged on stability, quality of lashings, and overall appearance.

REFERENCES

C2-007 (ISBN 0-7858-1446-9) Pawson, D. (2001). *Pocket Guide to Knots and Splices*. Edison, NJ: Chartwell Books, Inc.

C2-008 (ISBN 0-00-265314-7) Wiseman, J. (1999). *The SAS Survival Handbook*. Hammersmith, London: HarperCollins Publishers.

C2-046 PioneeringProjects.org (2004). *PioneeringProjects.org*. Retrieved 20 February 2007, from <http://www.pioneeringprojects.org/projects/index.htm>.

THIS PAGE INTENTIONALLY LEFT BLANK

TYING LASHINGS

SHEER LASHING

Procedure

1. Make a clove hitch around both poles.
2. Wrap the standing end around both poles, trapping the working end of the clove hitch underneath.
3. Make eight to ten more wraps around the poles.
4. Bring the rope up between the spars and make two tight turns parallel to the poles.
5. Make a clove hitch around one of the poles.
6. Ensure the lashing is tight and secure.
7. Sheer lashing opened to create a pair of sheer legs or an A-frame.

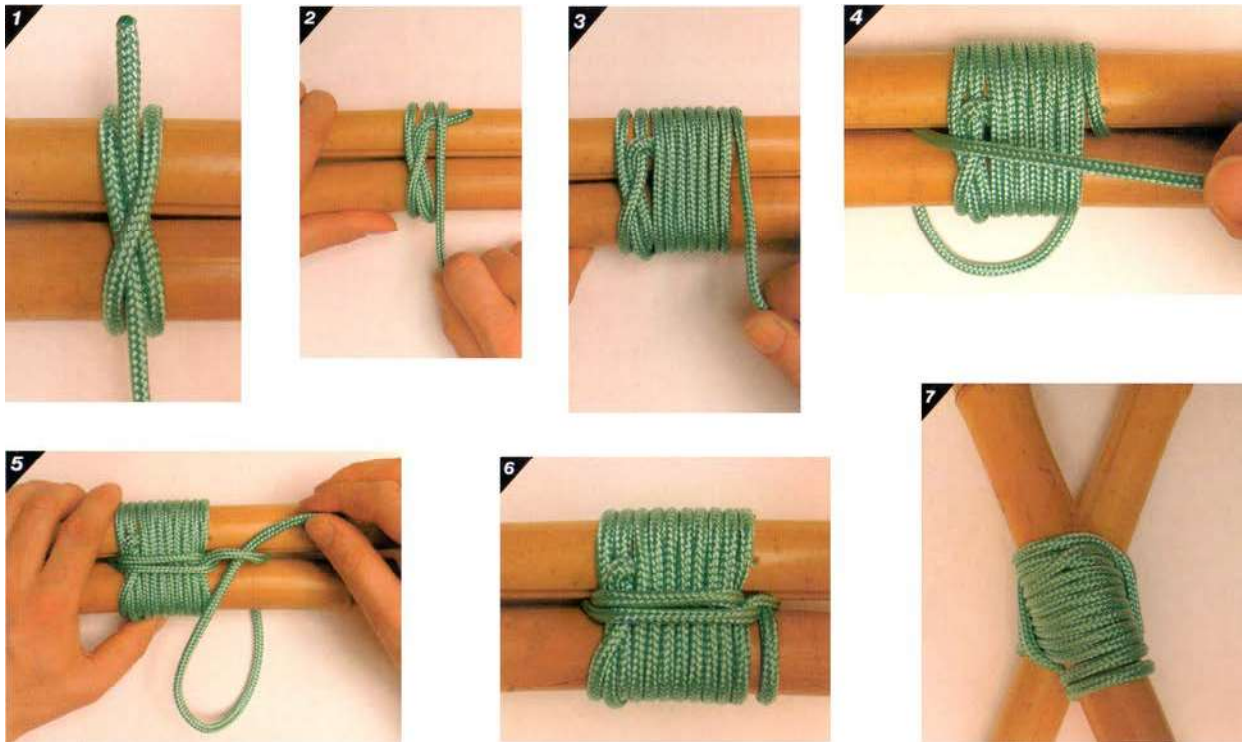

Figure A-1 Sheer Lashing

Pawson, D., Pocket Guide to Knots & Splices, Chartwell Books, Inc. (pp. 184-185)

SQUARE LASHING

Procedure

1. With the vertical pole on top of the horizontal pole, make a clove hitch. The vertical pole runs up and down, and the horizontal pole left to right.
2. Bring all of the rope around and behind the horizontal pole.
3. Tightly bring the rope over the vertical pole and back behind the horizontal pole, back to the clove hitch.
4. Continue to make three complete turns around the poles, pulling the rope tight after each turn.
5. After passing the clove hitch, tightly bring the rope to the horizontal pole from behind and start wrapping around the two poles. These wraps are called frapping turns.
6. Make two complete sets of frapping turns.
7. Make a clove hitch around the horizontal pole.
8. Ensure lashing is tight and secure.

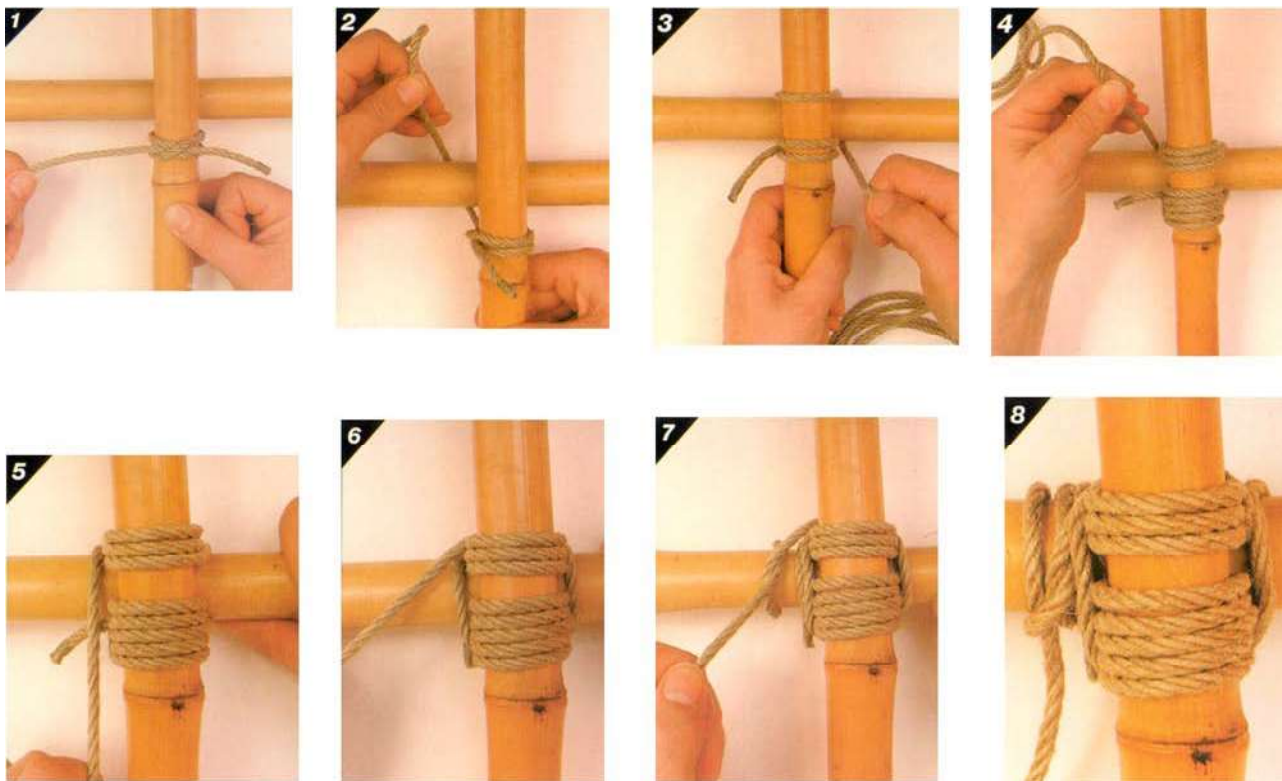

Figure A-2 Square Lashing

Pawson, D., Pocket Guide to Knots & Splices, Chartwell Books, Inc. (pp. 180-181)

DIAGONAL LASHING

Procedure

1. Make a timber hitch around the two crossed poles.
2. Make a turn around the two crossed poles, pulling the timber hitch tight.
3. Make three more complete turns in the same direction, pulling them tight.
4. Change direction by coming around one of the poles.
5. Make four full turns around the two poles at right angles to the original turns, pulling them tight.
6. Take the working end of the rope around one of the poles, making a frapping turn.
7. Make two complete frapping turns.
8. Make a clove hitch.
9. Ensure lashing is tight and secure.

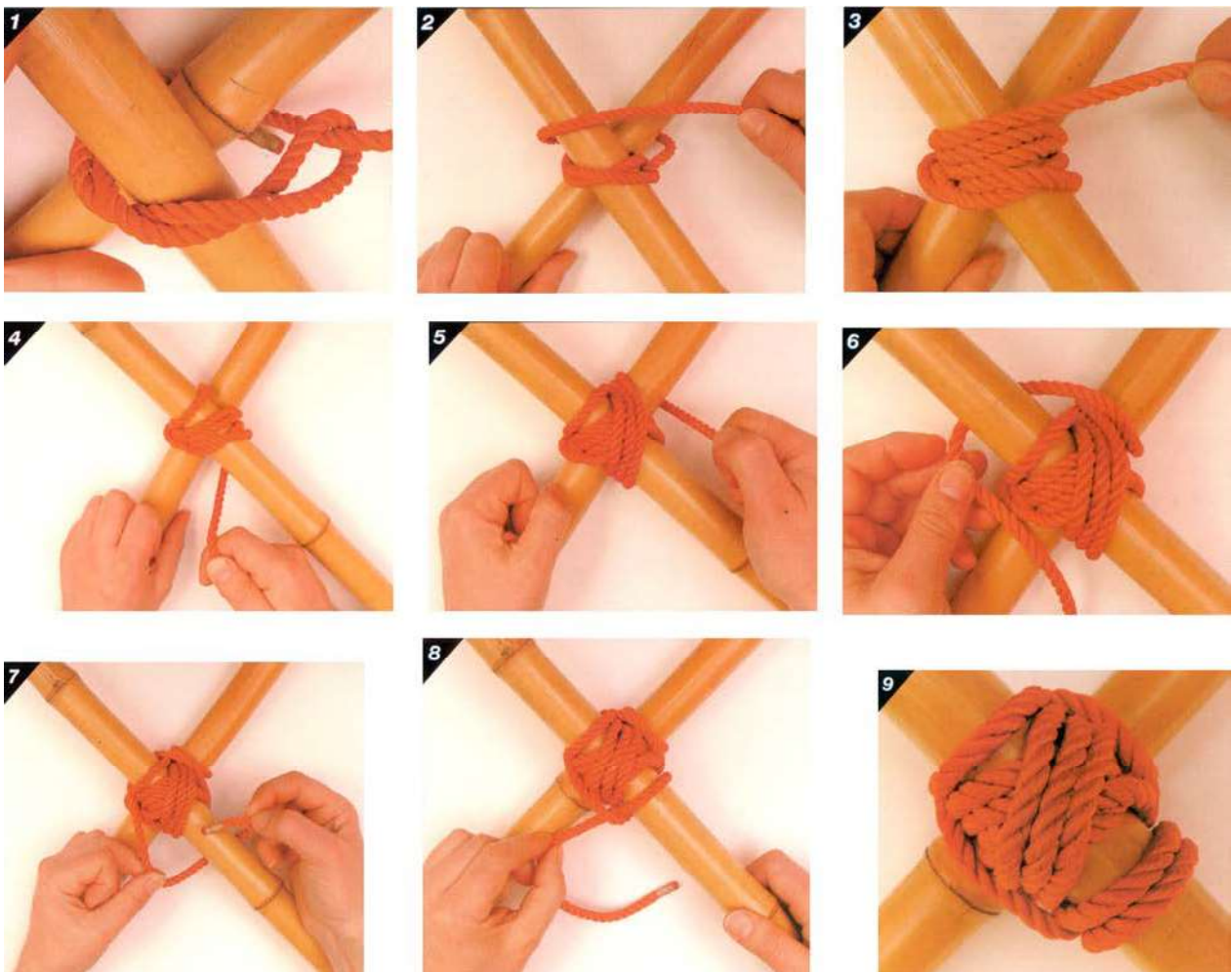

Figure A-3 Diagonal Lashing

Pawson, D., Pocket Guide to Knots & Splices, Chartwell Books, Inc. (pp. 182-183)

FIGURE-OF-EIGHT LASHING

Procedure

1. Make a clove hitch around one of the outside poles. Bring the rope under and over the other poles.
2. Go around the pole furthest away from the start and weave the rope back over and under.
3. Continue to weave the rope under and over eight times. Bring the rope up in between any two poles.
4. Pull the rope parallel to the poles and put in two frapping turns.
5. Make three frapping turns in between the remaining poles.
6. Make a clove hitch around the pole that already has a clove hitch (from the beginning) at the opposite end.
7. Open up the poles.

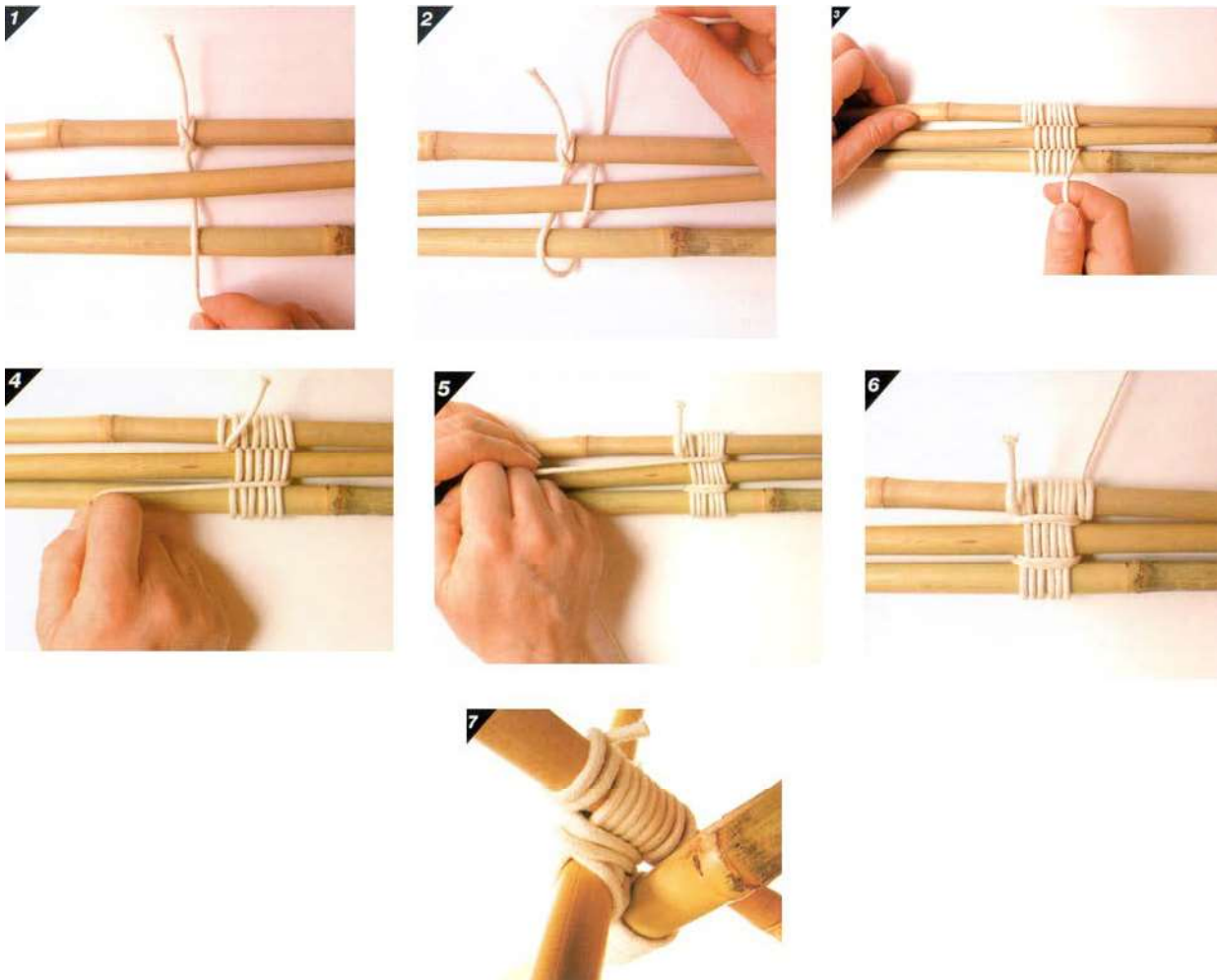

Figure A-4 Figure-of-eight Lashing

Pawson, D., Pocket Guide to Knots & Splices, Chartwell Books, Inc. (pp. 187-188)

FIELD AMENITIES

BENCH WITH BACK REST

Instructions

1. Find a large area.
2. Obtain the following resources:
 - a large quantity of rope;
 - eight round pieces of wood/logs approximately two metres each;
 - two round pieces of wood/logs approximately one metre each; and
 - two round pieces of wood/logs approximately one half metre each.
3. Begin by constructing the sitting portion of the bench by attaching four long pieces of wood to the one metre pieces, using square lashings.
4. Drive the two long and two short pieces of wood that will be used as the legs of the bench into the ground.
5. Lash the sitting portion onto the legs, using square lashings.
6. Construct the back rest using square lashings and attach it to the long legs in the ground.

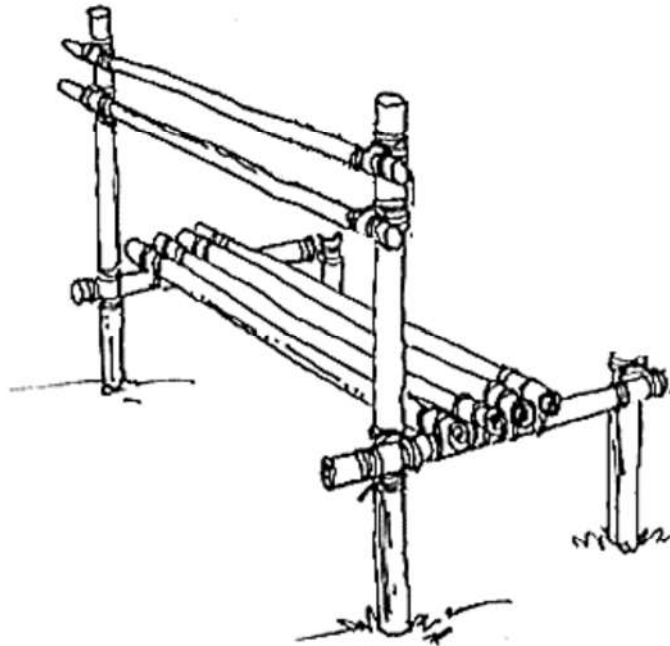

BENCH WITH BACK REST

Figure B-1 Bench With Back Rest

*PioneeringProjects.org, by A. Miller, 2004, Projects, Copyright 2001 from PioneeringProjects.org.
Retrieved 20 February 2007, from <http://www.pioneeringprojects.org/projects/index.htm>*

CAMP TABLE

Instructions

1. Find a large area.
2. Obtain the following resources:
 - a large quantity of rope,
 - four round pieces of wood/logs approximately three metres each;
 - six round pieces of wood/logs approximately two metres each;
 - two round pieces of wood/logs approximately one metre and a half each; and
 - fourteen round pieces of wood/logs approximately one half metre each.
3. Construct a figure-of-eight lashing around the four long pieces of wood, to make an A-frame.
4. Construct the table top, using square lashings.
5. Attach the table top portion to the long poles, using square lashings.
6. Make the sitting portion using square lashings and attach it to the long poles using square lashings.

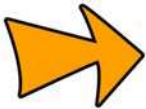

The best lashing to use for the peak of the camp table is the figure-of-eight lashing. It must be tied using the indicated steps; however, there will be four poles used instead of three.

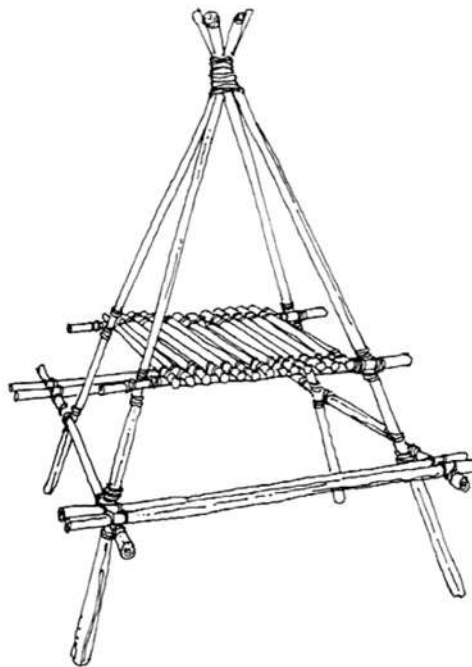

CAMP TABLE

Figure B-2 Camp Table

*PioneeringProjects.org, by A. Miller, 2004, Projects, Copyright 2001 from PioneeringProjects.org.
Retrieved 20 February 2007, from <http://www.pioneeringprojects.org/projects/index.htm>*

BULLETIN BOARD

Instructions

1. Find a large area.
2. Obtain the following resources:
 - a large quantity of rope;
 - two thick round pieces of wood/logs approximately two metres each;
 - two round pieces of wood/logs approximately two metres each; and
 - twelve round pieces of wood/logs approximately one metre each.
3. Construct the canopy portion of the bulletin board using square lashings.
4. Tie the ends of the thin two metre wood to the thick two metre wood with a sheer lashing.
5. Use diagonal lashings to fasten the thin two metre wood to the canopy.
6. Square lash the end of the canopy to the thick wood.
7. Drive the two thick round pieces of wood into the ground.

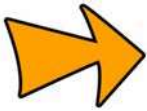

A flat piece of wood or a piece of bristol board can be used for the background of the bulletin board.

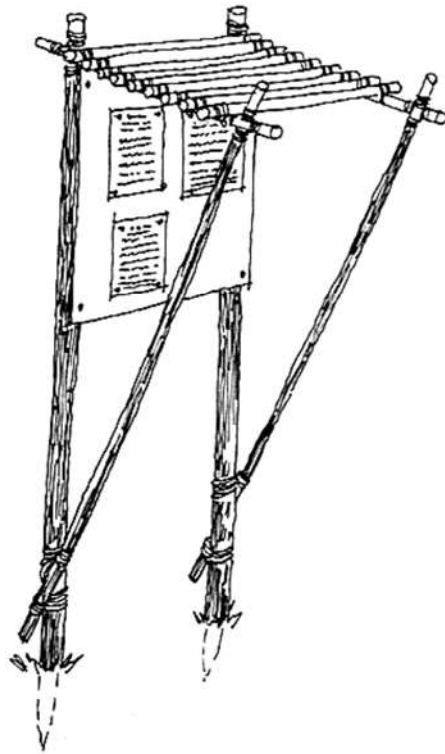

BULLETIN BOARD

Figure B-3 Bulletin Board

*PioneeringProjects.org, by A. Miller, 2004, Projects, Copyright 2001 from PioneeringProjects.org.
Retrieved 20 February 2007, from <http://www.pioneeringprojects.org/projects/index.htm>*

PODIUM

Instructions

1. Find a large area.
2. Obtain the following resources:
 - a large quantity of rope;
 - twelve to fifteen round pieces of wood/logs approximately one half metre each; and
 - eight round pieces of wood/logs approximately one and a half metres each.
3. Construct the table portion of the podium using square lashings.
4. Construct the base of the podium using square lashings. The X portion will provide needed support and requires diagonal lashings.
5. Square lash the table portion of the podium to the base.

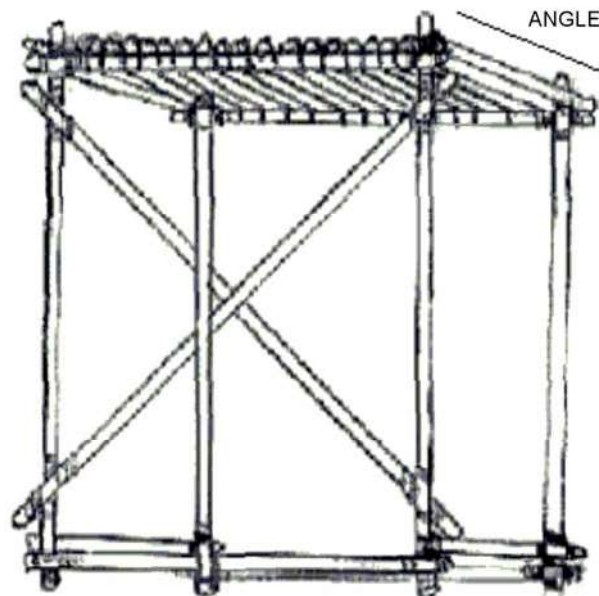

PODIUM

Figure B-4 Podium

*PioneeringProjects.org, by A. Miller, 2004, Projects, Copyright 2001 from PioneeringProjects.org.
Retrieved 20 February 2007, from <http://www.pioneeringprojects.org/projects/index.htm>*

THIS PAGE INTENTIONALLY LEFT BLANK



ROYAL CANADIAN ARMY CADETS

RED STAR

INSTRUCTIONAL GUIDE



SECTION 12

EO C221.03 – IDENTIFY SPECIES OF TREES

Total Time:

60 min

PREPARATION

PRE-LESSON INSTRUCTIONS

Resources needed for the delivery of this lesson are listed in the lesson specification located in A-CR-CCP-702/PG-001, Chapter 4. Specific uses for said resources are identified throughout the Instructional Guide within the TP for which they are required.

Review the lesson content and become familiar with the material prior to delivering the lesson.

Prior to this lesson, it is recommended that instructors consult local resources to identify the most common species of trees within the area.

Prior to this lesson, find an area containing as many types of trees as possible. With brightly coloured tape, mark four trees that cadets can identify. Prepare activity instructions according to the area.

Photocopy Annex A for each cadet for the activity in TP3.

For an indoor activity, photocopy Annex B to post in the classroom. Ensure all references are removed.

PRE-LESSON ASSIGNMENT

N/A.

APPROACH

An interactive lecture was chosen for TP1 and TP2 to introduce species of trees and to generate interest.

A practical activity was chosen for TP3 as it is an interactive way to identify species of trees and to confirm the cadet's comprehension of the material.

INTRODUCTION

REVIEW

N/A.

OBJECTIVES

By the end of this lesson the cadet shall identify species of trees.

IMPORTANCE

It is important for cadets to know about species of trees so they may gain a greater understanding of the ecosystem and develop an appreciation for the outdoors.

Teaching Point 1

Identify Characteristics of Deciduous Trees

Time: 20 min

Method: Interactive Lecture

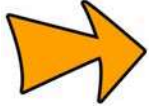

There are approximately 170 species of trees in Canada.

Deciduous trees are often called broadleaved trees because they shed annually in the fall. They change colour and lose their leaves before winter. Deciduous trees may produce flowers and fruit depending on the season.

The most common deciduous trees in Canada are:

- alder;
- beech;
- birch;
- chestnut;
- elm;
- hickory;
- maple; and
- oak.

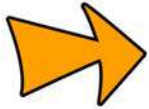

Deciduous trees account for the majority of tree species in Canada.

ENVIRONMENT

Deciduous trees are mainly found in the boreal forest. A milder climate is better for deciduous trees.



Figure 1 Map of the Forest Regions of Canada

Natural Resources Canada, 2004, The Atlas of Canada, Retrieved 29 March 2007, from http://atlas.nrca.gc.ca/site/English/learningresources/theme_modules/borealforest/forest_regions.jpg/image_view

SEEDS

Deciduous trees have seeds contained within a fruit or a flower.

LEAF ATTACHMENT

Deciduous trees are usually identified by their leaves. There are three types of leaf attachment: alternate, opposite and whorled leaves.

Alternate Leaves. They are attached to alternating nodes along the branch. There is a single leaf at each node. The alder, beech, birch, cherry, elm and oak trees all have alternate leaves.



Figure 2 Alternate Leaf Arrangement

University of Kentucky, College of Agriculture - Online Publications - Forestry Publications Youth Education, 2007, Introducing Yourself to Trees, Copyright 2007 by University of Kentucky, College of Agriculture. Retrieved 22 March 2007, from <http://www.ca.uky.edu/agc/pubs/for/for65/1b.gif>

Opposite Leaves. They are attached to the branch directly opposite one another. There are two leaves at each node. The chestnut, hickory and maple trees all have opposite leaves.

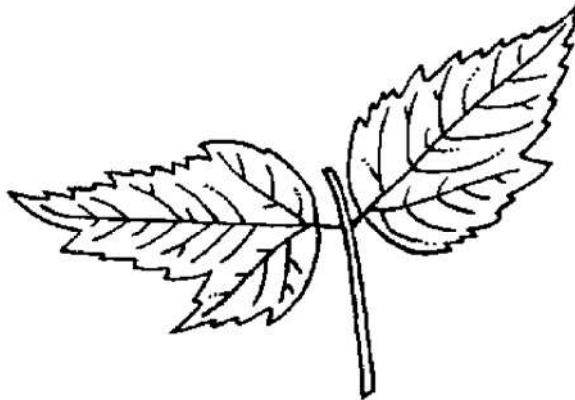

Figure 3 Opposite Leaf Arrangement

University of Kentucky, College of Agriculture - Online Publications - Forestry Publications Youth Education, 2007, Introducing Yourself to Trees, Copyright 2007 by University of Kentucky, College of Agriculture. Retrieved 22 March 2007, from <http://www.ca.uky.edu/agc/pubs/for/for65/1a.gif>

Whorled Leaves. They are attached to the tip of the twig in a circle. There are more than two leaves at each node. Fruit trees like apple and plum trees usually have whorled leaves.



Figure 4 Whorled Leaf Arrangement

University of Kentucky, College of Agriculture - Online Publications - Forestry Publications Youth Education, 2007, Introducing Yourself to Trees, Copyright 2007 by University of Kentucky, College of Agriculture. Retrieved 22 March 2007, from <http://www.ca.uky.edu/agc/pubs/for/for65/1a.gif>

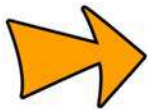

Plants and trees that have whorled leaves often have opposite leaf pairs as well.

LEAF TYPE

Deciduous trees can have two types of leaves – simple and compound leaves.

Simple Leaves. Simple leaves are composed of one leaf. All types of alder, beech, birch, chestnut, elm, maple and oak trees fall under the simple leaf category.



Figure 5 Simple Leaf

Natural Resources Canada, 2002, Round Leaves, Retrieved 22 March 2007, from http://www.cfl.scf.mcan.gc.ca/imfec-idecf/hosttrees/deciduous/leaves_round.html

Compound Leaves. Compound leaves are composed of several leaflets and they make up the entire leaf. All types of hickory trees fall under this category.



Figure 6 Compound Leaf

Natural Resources Canada, 2002, Compound Leaves, Retrieved 22 March 2007, from http://www.cfl.scf.rncan.gc.ca/imfec-idecf/hosttrees/deciduous/leaves_compound.html

BARK

Bark protects trees from the outside world, against weather elements, diseases and insects. It also keeps moisture in during dry periods.

Deciduous trees have different types of bark depending on the tree and its environment.

Red Alder Bark. The bark is thin, greenish on young trees, turning grey to whitish with age. The colour may also be ashy-gray. It is often draped with moss.



Figure 7 Red Alder Bark

Lichens of North America, 2007, Lichens and Ecosystems, Copyright 2007 for Stephen and Sylvia Sharnoff. Retrieved 30 March 2007, from <http://www.lichen.com/bigpix/aldersbare.html>

Beech Bark. The bark is smooth and has ridges. The colour can range from gray to blue-gray.



Figure 8 American Beech Bark

Ibiblio, the Public's Library and Digital Archive, 2006, Index of/botnet/angiospermbark. Retrieved 30 March 2007, from <http://www.ibiblio.org/botnet/angiospermbark/beechn.jpg>

Birch Bark. The bark is thin, white to reddish-brown, with dark horizontal slits. It peels in papery strips, exposing reddish-orange inner bark, which will gradually turn black with age.



Figure 9 Birch Bark

Richard's Notes, 2004, White Birch Bark, Copyright 2004 by Richard's Note. Retrieved 27 March 2007, from <http://www.richardsnotes.org/archives/2004/03/page/2/>



The bark of all species of birch is excellent for tinder, kindling and torches. It is full of resinous oil which blazes up and will burn in the wind.

Chestnut Bark. The bark colour may range from dark to pale brown with touches of gray. It is broken into broad, flattened scaly ridges.



Figure 10 Chestnut Bark

Bioimages, Copyright 2002 by Bioimages. Retrieved 30 March 2007, from <http://www.cas.vanderbilt.edu/bioimages/species/aehi.htm>

Elm Bark. The bark is dark gray in flat-topped ridges.



Figure 11 Elm Bark

Bioimages, Copyright 2002 by Bioimages. Retrieved 30 March 2007, from <http://www.cas.vanderbilt.edu/image/u/ulse--brlarge16180.htm>

Hickory Bark. The bark is composed of long and shaggy rectangular pieces.



Figure 12 Hickory Bark

Firewood, Copyright 2007 by Donnan.com. Retrieved 27 March 2007, from <http://www.donnan.com/firewood.htm>

Maple Bark. The bark is scaly and creased.



Figure 13 Sugar Maple Bark

Firewood, Copyright 2007 by Donnan.com. Retrieved 27 March 2007, from <http://www.donnan.com/firewood.htm>

Oak Bark. The bark is usually greyish-black with thick grooves and scales. It is composed of vertical blocks of scaly plates.



Figure 14 Oak Bark

Firewood, Copyright 2007 by Donnan.com. Retrieved 27 March 2007, from <http://www.donnan.com/firewood.htm>

USAGE

Deciduous trees are also called hardwood. Thirty-two species of deciduous trees are used commercially. The following illustrates some of the various products made from hardwood:

- furniture (dining room tables, coffee tables, beds, bookcases, etc.);
- musical instruments (guitars, banjos, violins, drums, drumsticks, etc.);
- pencils;
- tool handles;
- ladders;
- picnic tables; and
- telephone poles.

FIREWOOD

Hardwood is slow burning, producing good steady heat but poor light.

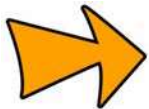

Alder, beech, birch, chestnut, elm, hickory, maple and oak are classified under hardwood.

Maple wood ignites easily and it makes a steady flame.

CONFIRMATION OF TEACHING POINT 1**QUESTIONS**

- Q1. Why are deciduous trees called broadleaves?
- Q2. Name the three types of leaf attachment.
- Q3. Name four of the most common deciduous trees in Canada.

ANTICIPATED ANSWERS

- A1. Deciduous trees are often called broadleaves because they shed annually in the fall.
- A2. Alternate, opposite and whorled.
- A3. Alder, beech, birch, chestnut, elm, hickory, maple and oak.

Teaching Point 2**Identify Characteristics of Coniferous Trees**

Time: 20 min

Method: Interactive Lecture

Coniferous trees are collectively referred to as conifers or evergreens. They all have leaves that look like needles (pines or spruces) or scales (cedars). Coniferous trees generally have persistent foliage (leafage) consisting of needles or scales.

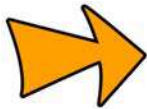

Persistent foliage is a characteristic of evergreen trees. It means they do not shed their leaves in the fall.

Coniferous trees are usually distinguished from one another by their bark, the number of needles in each bundle, the way the needles are arranged on the twigs, and the cone size, shape and colour.

The most common coniferous trees in Canada are:

- cedar;
- fir;
- hemlock;
- larch;
- pine;
- spruce; and
- tamarack.

ENVIRONMENT

Coniferous trees are mainly found in the northern hemisphere, in cool climates. They populate the boreal forest and the mountains.

SEEDS

Coniferous seeds are not contained in a fruit. The seeds are born on scales which are grouped together to form a cone. The cone is the reproductive structure of the coniferous tree. It consists of a central axis covered with scales that are tightly pressed together. At maturity, cones contain seeds. Cones are like flowers.



Figure 15 Cones

The Canadian Encyclopedia, 2007, Conifers, Copyright 2007 by Alberta Forest Service, Retrieved 22 March 2007, from <http://www.thecanadianencyclopedia.com/index.cfm?PgNm=TCE&Params=A1SEC818695>

NEEDLE ARRANGEMENT

There are three types of needle arrangement – single, clustered and overlapping scales.

Single Needle. The needles are not joined in a bundle. There is only one needle. Fir, hemlock and spruce trees all fall under this category.



Figure 16 Single Needle Fir

Blue Ridge Community College, 2007, Arboretum-Interactive Key, Retrieved 27 March 2007, from http://www1.brcc.edu/murray/interactive_key/key/needles/nl.htm

Clustered Needles. Clustered needles are wrapped at the base. Larch, pine and tamarack trees fall under this category.



Figure 17 Clustered Needles

Wildflowers of Prince Edwards County, 2003, White Pine, Retrieved 23 March 2007 from <http://www.pec.on.ca/wildflowers/flowers.php?id=514>

Overlapping Scales. Only trees in the cedar family have this type of needle.



Figure 18 Red Cedar Overlapping Scales

Wikipedia, 2006, Thuja Plicata. Retrieved 30 March 2007, from http://en.wikipedia.org/wiki/thuja_plicata



Canada's aboriginal people would boil six 10 cm cedar branches in a large pot of 4 litres of water to make cedar tea.

BARK

Bark protects the tree from the outside world, against weather elements, diseases and insects. It also keeps moisture in during dry periods.

Coniferous trees have different types of bark depending on the tree and its environment.

Cedar Bark. Cedar bark is grey, stringy and tears off in long strips on mature trees. It is fibrous and irregularly creased.



Figure 19 Cedar Bark

Natural Resources Canada, 2002, Conifers, Retrieved 27 March 2007, from <http://www.cfl.scf.mcan.gc.ca/imfec-idecf/hosttrees/conifers/cedar.html>

Fir Bark. Fir bark is usually covered with resin blisters. The bark generally resembles scaly plates.



Figure 20 Fir Bark

Bioimages, Copyright 2002 by Bioimages. Retrieved 27 March 2007, from <http://www.cas.vanderbilt.edu/bioimages/image/a/abfr--br11426.htm>

Hemlock Bark. Dark brown to reddish-brown, becoming thick and strongly grooved with age.



Figure 21 Hemlock Bark

Ministry of Forest and Range – Government of British Columbia, 2001, Tree Book Western Hemlock, Copyright 2001 for the Province of British Columbia. Retrieved 30 March 2007, from <http://www.for.gov.bc.ca/hfd/librarydocuments/treebook/westernhemlock.htm>

Larch Bark. Mature trees develop a thick, grooved plate-like bark with cinnamon-coloured scales.



Figure 22 Western Larch Bark

Ministry of Forest and Range – Government of British Columbia, 2001, Tree Book Western Larch, Copyright 2001 for the Province of British Columbia. Retrieved 30 March 2007, from <http://www.for.gov.bc.ca/hfd/librarydocuments/treebook/westernlarch.htm>

Pine Bark. Pine bark is usually thin, smooth, and chalky-white on young stems; as the tree gets older, the bark becomes thicker and forms narrow, brown, scaly plates.



Figure 23 Pine Bark

Bioimages, Copyright 2002 by Bioimages. Retrieved 27 March 2007, <http://www.cas.vanderbilt.edu/bioimages/image/p/pivi2-brmedium13509.htm>

Spruce Bark. Spruce bark is usually loose, scaly, and greyish-brown. It may have resin blisters.



Figure 24 Spruce Bark

St. Mary's School, 2003, Mrs. Zvonar's Tree Page, Copyright 2003 for St. Mary's School. Retrieved 27 March 2007, from http://www.stmarysschool.net/whitesprucetree_cb.html

Tamarack Bark. Tamarack bark is usually red-brown, thin, and scaly.



Figure 25 Tamarack Bark

Ministry of Forest and Range – Government of British Columbia, 2001, Tree Book Tamarack, Copyright 2001 for the Province of British Columbia. Retrieved 30 March 2007, from <http://www.for.gov.bc.ca/hfd/librarydocuments/treebook/tamarack.htm>

USAGE

Twenty-three species of coniferous trees are used commercially. Conifers are mainly used for paper production and timber. They can also be used for:

- floors;
- mouldings; and
- bookcases.

FIREWOOD

Softwood makes a hot and fast burning fire; unfortunately, it does not last long.



Spruce is a poor fuel but it makes a good blaze for building up a fire.

CONFIRMATION OF TEACHING POINT 2

QUESTIONS

- Q1. Why are coniferous trees called evergreens?
- Q2. Name the two types of needles on coniferous trees.
- Q3. Name two of the most common coniferous trees in Canada.

ANTICIPATED ANSWERS

- A1. They do not shed their leaves in the winter.
- A2. Simple and clustered.
- A3. Cedar, fir, hemlock, larch, pine, spruce and tamarack.

Teaching Point 3

Conduct an Identification Activity

Time: 10 min

Method: Practical Activity



If an outside area with trees is not available, conduct the second activity in this TP.

ACTIVITY (OUTDOORS)

OBJECTIVE

The objective of this activity is for the cadets to identify at least one deciduous and one coniferous tree.

RESOURCES

- Bright-coloured tape; and
- Answer sheet located at Annex A.

ACTIVITY LAYOUT

Prior to the lesson, identify an area containing as many types of trees as possible. The four trees to identify should be marked with bright-coloured tape.

ACTIVITY INSTRUCTIONS

1. Have the cadets step outside the building and gather at the pre-determined area.
2. Outline safety rules.
3. Distribute the answer sheet located at Annex A.
4. Cadets should walk around the area and identify, on their answer sheet, the marked trees.
5. After five minutes, have the cadets gather around and review their answers.

SAFETY

Brief the cadets on any safety rules or boundaries pertaining to the outside activity.

ACTIVITY (INDOORS)

OBJECTIVE

The objective of this activity is for the cadets to identify at least one deciduous and one coniferous tree.

RESOURCES

- Tape;
- Answer sheet located at Annex A; and
- Pictures of trees located at Annex B.

ACTIVITY LAYOUT

Pictures of five different trees (located at Annex B) should be posted around the classroom.

ACTIVITY INSTRUCTIONS

1. Distribute the answer sheet located at Annex A.
2. Have the cadets walk around the room and identify the trees on the pictures.
3. After five minutes, have the cadets gather around and review their answers.



The five different trees in Annex B are:

- Species A – birch;
- Species B – hickory;
- Species C – oak;
- Species D – cedar;
- Species E – larch; and
- Species F – spruce.

SAFETY

N/A.

CONFIRMATION OF TEACHING POINT 3

The cadet's participation in the activity will serve as the confirmation of this TP.

END OF LESSON CONFIRMATION**QUESTIONS**

- Q1. Name four of the most common deciduous trees in Canada.
- Q2. What type of coniferous tree has overlapping scales?
- Q3. Name four of the most common coniferous trees in Canada.

ANTICIPATED ANSWERS

- A1. Alder, beech, birch, chestnut, elm, hickory, maple and oak.
- A2. Cedar.
- A3. Cedar, fir, hemlock, larch, pine, spruce and tamarack.

CONCLUSION

HOMEWORK/READING/PRACTICE

N/A.

METHOD OF EVALUATION

N/A.

CLOSING STATEMENT

Being familiar with the surrounding environment is essential to expeditions and weekend bivouac FTX. This knowledge will provide a better understanding of the species of trees needed for skills such as fire building or constructing field amenities.

INSTRUCTOR NOTES/REMARKS

N/A.

REFERENCES

- C0-117 (ISBN 1-58238-092-9) Brockman F.C. (2001). *Trees of North America: A Guide to Field Identification*. New York, USA: St. Martin's Press.
- C0-137 Natural Resources Canada. (2002). *Provincial Trees*. Retrieved 22 March 2007, from <http://www.cfl.scf.mcan.gc.ca/imfec-idecf/hosttrees/provincialtrees.html>.
- C2-004 (ISBN 1-896713-00-9) Tawrell, P. (1996). *Camping and Wilderness Survival: The Ultimate Outdoors Book*. Green Valley, ON: Paul Tawrell.
- C2-016 (ISBN 0-517-88783-5) Curtis, R. (1998). *The Backpacker's Field Manual: A Comprehensive Guide to Mastering Backcountry Skills*. New York, NY: Three Rivers Press.
- C2-068 (ISBN 0-425-10572-5) Brown, T., Jr., and Morgan B. (1983). *Tom Brown's Field Guide: Wilderness Survival*. New York, NY: The Berkley Publishing Group.

ANSWER SHEET

TREE IDENTIFICATION

1.
2.
3.
4.
5.

Notes

THIS PAGE INTENTIONALLY LEFT BLANK

PICTURES OF TREES

SPECIES A



Figure B-1 Tree Grove

Degree Confluence Project, 2006, Russia:Smolenskaya, Copyright 2006 for Alex Jarrett. Retrieved 4 April 2007 from <http://www.confluence.org/photo.php?visitid=8546&pic=ALL>



Figure B-2 Tree Bark

Richard's Notes, 2004, White Birch Bark, Copyright 2004 by Richard's Note. Retrieved 27 March 2007, from <http://www.richardsnotes.org/archives/2004/03/page/2/>

SPECIES B



Figure B-3 Tree

Wikipedia, 2006, Hickory. Copyright 2003 by Susan Sweeney. Retrieved 4 April 2007, from <http://en.wikipedia.org/wiki/hickory>



Figure B-4 Tree Bark

Firewood, Copyright 2007 by Donnan.com. Retrieved 27 March 2007, from <http://www.donnan.com/firewood.htm>

SPECIES C



Figure B-5 Tree

Islandnet.com, 2004, Beacon Hill Park History 1842-2004, Copyright 2004 by Janis Ringuette. Retrieved 4 April 2007, from <http://www.islandnet.com/beaconhillpark/contents/chapter1.htm>



Figure B-6 Tree Bark

Firewood, Copyright 2007 by Donnan.com. Retrieved 27 March 2007, from <http://www.donnan.com/firewood.htm>

SPECIES D



Figure B-7 Tree

Ministry of Forest and Range – Government of British Columbia, 2001, Tree Book-Yellow Cedar, Copyright 2001 by the Province of British Columbia. Retrieved 30 March 2007, from <http://www.for.gov.bc.ca/hfd/librarydocuments/treebook/yellowcedar.htm>



Figure B-8 Tree Bark

Wikipedia, 2006, Thuja Plicata. Retrieved 30 March 2007, from http://en.wikipedia.org/wiki/thuja_plicata

SPECIES E



Figure B-9 Tree

Ministry of Forest and Range – Government of British Columbia, 2001, Tree Book-Western Larch, Copyright 2001 by the Province of British Columbia. Retrieved 30 March 2007, from <http://www.for.gov.bc.ca/hfd/librarydocuments/treebook/westernlarch.htm>



Figure B-10 Tree Bark

Ministry of Forest and Range – Government of British Columbia, 2001, Tree Book Western Larch, Copyright 2001 by the Province of British Columbia. Retrieved 30 March 2007, from <http://www.for.gov.bc.ca/hfd/librarydocuments/treebook/westernlarch.htm>

SPECIES F



Figure B-11 Tree

Ashcroft Farm, 2006, Type of Christmas Trees, Copyright 2006 by Ashcroft Farm. Retrieved 4 April 2007, from <http://www.ashcroftfarm.com/types.html>



Figure B-12 Tree Bark

St. Mary's School, 2003, Mrs. Zvonar's Tree Page, Copyright 2003 by St. Mary's School. Retrieved 27 March 2007, from http://www.stmarysschool.net/whitesprucetree_cb.html