

Ezekiel 4.

The master key to unlock the Bible's chronology

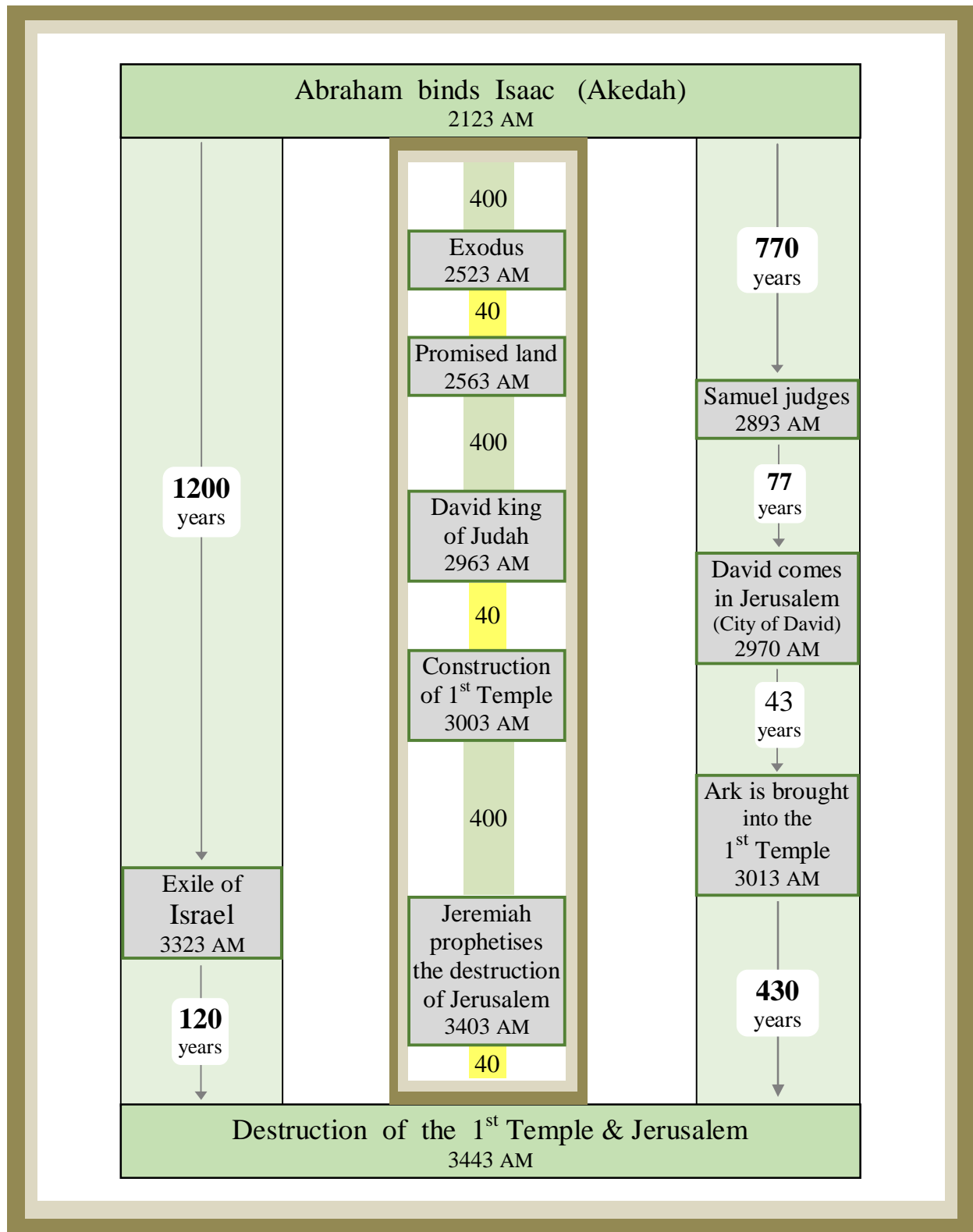

If the only achievement of this book was the discovery of this pattern, I would be satisfied. But there is so much more..

Yves Peloquin



"Make the mind of this people dull, and stop their ears, and shut their eyes, so that they may not look with their eyes, and listen with their ears, and comprehend with their minds, and turn and be healed."

Isaiah 6:10

It is the glory of God to conceal a matter;
to search out a matter is the glory of kings.

Prov 25:2 NIV

Dédié à Marie-Paule mon épouse, sans
qui je n'aurais jamais pu m'investir avec
autant d'énergie dans cette recherche, et
à mes trois enfants :

Jeanne, Émile, Évelyne
qui ont si souvent été privés de ma
présence.

Also dedicated to my father Leo
(1921-1994 AD) from whom I learned the
names of Jacob's children. I believe he
was one of the great...great grandsons of
Leah, first wife of the patriarch Jacob.



The First Part

| | |
|--|----------|
| The house of Judah sin that lasted 40 days (years) | page 12 |
| The house of Israel sin that lasted 390 days (years) | page 16 |
| A siege that last 430 days (390 days + 40 days) | page 26 |
| Why an iron wall | page 34 |
| Left side/Right side | page 38 |
| The feeding of Ezekiel during his siege | page 43 |
| The need to have Ezekiel tied up | page 44 |
| Prophesying against the siege of Jerusalem | page 49 |
| Ezekiel's bare arm | page 57 |
| Ezekiel eating defiled food | page 66 |
| The 430 years and 400 years to Exodus | page 76 |
| Ezekiel shaves his hair | page 88 |
| Ezekiel is weighing and dividing the hair | page 96 |
| Ezekiel's hair growing again | page 103 |
| Daniel 70-week & post exile chronology | page 112 |
| Ezekiel's fasting | page 132 |
| Ezekiel's famine of words | page 135 |
| Conclusion of first part | page 140 |

Second Part

| | |
|---|----------|
| Setting a true chronology of the Bible | page 141 |
| The timeline of Joseph | page 142 |
| Sabbath and Jubilee | page 146 |
| Yeshua's ministry | page 149 |
| The time of Joshua | page 158 |
| Oppressions and Judges | page 161 |
| Pilgrimage of fathers and sons | page 175 |
| When did Abraham marry | page 177 |
| Did the Israelites wait 19 y. in Kadesh Barnea? | page 173 |
| Understanding Judah & Israel EXILE | page 178 |
| Numbers 37-73 and the timing of Samson | page 192 |
| Was Solomon 17 years old when he became king? | page 194 |
| Unseal chronological patterns in 28 charts | page 195 |
| Conclusion of second part | page 224 |

| | | |
|------------|---|----------|
| Appendix A | From Adam to Abraham (the basic timeline) | page 227 |
| Appendix B | Abraham's family tree | page 230 |
| Appendix C | Akedah Exodus Crucifixion | page 233 |
| Appendix D | Synchronizing the calendar | page 254 |
| Appendix E | The Bible's timeline | page 255 |
| Appendix F | Hidden link between 3443 and 3993 | page 264 |
| Appendix G | Daniel 8:14 '2300 evenings & mornings' .. | page 265 |
| Appendix H | Daniel 12:11-12 1,290 days & 1,335 days | page 268 |
| Appendix I | Daniel 70 th week | page 269 |
| Appendix J | King of Israel | page 277 |
| Appendix K | 77 People of authority (11 + 22 + 44) | page 278 |
| Appendix L | The 12 symbolical acts of Ezekiel 4-5 | page 279 |

Ezekiel 4. The master key to unlock the Bible's chronology

By Yves Peloquin
Montréal, Canada

Created Dec 2004
(Year 5966 AM)

<http://www.EzekielMasterKey.com>

Email:
Yves.Peloquin@bell.net

Last update Aug 13, 2017
(Year **5979 AM**)

Several solutions have been proposed to explain the 390 and the 40 years symbolized by Ezekiel's 390 and 40 days. None has been very convincing so far.

The following observation is therefore indisputable: in spite of the fact that Ezekiel spent a very long period (430 days) on his sides to perform a sign to the house of Israel, no one has ever come up with any hidden interpretation that could match (and justify) the prophet's amazing task? This book shall propose a fresh new way to understand Ezekiel 4.

The Siege of Jerusalem prophesied

Ezek 4:1-13

4:1 "Now, son of man, take a clay tablet, put it in front of you and draw the city of Jerusalem on it. 2 Then lay siege to it: Erect siege works against it, build a ramp up to it, set up camps against it and put battering rams around it. 3 Then take an iron pan, place it as an iron wall between you and the city and turn your face toward it. It will be under siege, and you shall besiege it. This will be a sign to the house of Israel. 4 "Then lie on your left side and put the sin of the house of Israel upon yourself. You are to bear their sin for the number of days you lie on your side. 5 I have assigned you the same number of days as the years of their sin. So for 390 days you will bear the sin of the house of Israel. 6 "After you have finished this, lie down again, this time on your right side, and bear the sin of the house of Judah. I have assigned you 40 days, a day for each year. 7 Turn your face toward the siege of Jerusalem and with bare arm prophesy against her. 8 I will tie you up with ropes so that you cannot turn from one side to the other until you have finished the days of your siege. 9 "Take wheat and barley, beans and lentils, millet and spelt; put them in a storage jar and use them to make bread for yourself. You are to eat it during the 390 days you lie on your side. 10 Weigh out twenty shekels of food to eat each day and eat it at set times. 11 Also measure out a sixth of a hin of water and drink it at set times. 12 Eat the food as you would a barley cake; bake it in the sight of the people, using human excrement for fuel." 13 The LORD said, "In this way the people of Israel will eat defiled food among the nations where I will drive them."

It is certain that some important chronological information can be obtained by correctly interpreting the sign performed by Ezekiel. After all, we already know that when he was lying for 390 and 40 days, he was then symbolically portraying one period of sin that lasted 390 years and another that lasted 40 years. No doubts that these two values will lead us to the discovery of some solid markers in the Bible chronology once we have them correctly understood.

But there is more information to be obtained from Ezek 4-5 than what has been suggested until now. We will see in the following pages that while he was lying on his sides Ezekiel was performing more than a dozen different symbolical acts each one portraying an independent set of events that had or would take place over distinct periods of either 390, 40, or 430 years.

From a few basic sequences of events whose timeline are well known, we are going to, while identifying each Ezekiel 4-5 symbolical act, find out the timing of every **meaningful biblical event**. Figuratively speaking, this book has been designed like a ladder. Where each rung allow a workman to go higher and higher, here most chapters will introduce a new Ezekiel 4-5 symbolical act and consolidate it by using the chronological information validated in the previous chapters. As we move on, several paths of reliable events will keep expanding until it becomes possible to merge them into a tightly interconnected network.

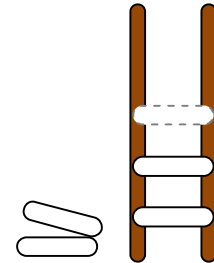

A unique feature pertaining to the development of this work will be obvious in the first part of the book. I decided that no biblical event would be associated to a specific date. Indeed, each event will be featured in its relationship with other. Thus similar to what is done in the Bible's narration, the emphasis will be exclusively over the length of time (# of years) separating the events between themselves (i.e. **relative dating**). No matter how destabilizing it will feel, this approach is necessary to establish a fundamental timeline that owes nothing to any material found outside the Bible.

Like many of you already know, once the chronology of the patriarchs has been figured out it is impossible to move on in a straight manner to reach the time of Moses, Aaron, Joshua and Caleb. This is why I believe the bible chronology should be handled like a jigsaw puzzle where it is sometime more efficient to complete different areas according their color or form then trying fitting individual piece directly on the main picture. We will see how it can be done.

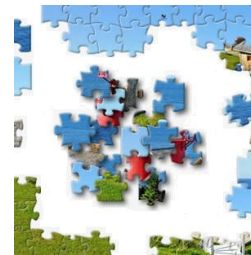

In the second part of the book, dates will be anchored to each biblical event (i.e. **absolute dating**). This is a prerequisite to adequately discuss about the occurrence of the sabbatical years, highlight the use of palindromic dates (Ex. Destruction of the first Temple in 3443 AM), to project the likely timing of the future re-emergence of the Lost-Tribes of Israel, and of course to produce the detailed biblical timeline expected in this kind of work.

By the end of the book more than 180 biblical events will have been firmly dated and presented in spectacular patterns. Truly, never before was a biblical chronology elaborated around so many markers and with such an abundance of **self-validating mechanisms**.

I just mentioned that this chronology will display some spectacular patterns. In fact patterns are a major outcome of this chronology. They come in so many forms and they involve so many events that one could ask ourselves: Why were all those events inscribed in such a vast network of patterns? The likely answer is that the patterns, by their sole presence, are a proof of the accuracy of the dates leading to them. Given that a random set of dates would rarely lead to a harmonious and spectacular pattern, finding a large number of them, interacting between each other, compels us to accept the involvement of a Master Designer.

Let's start with four examples of spectacular patterns to show evidence of design.

First example: The age of the last four patriarchs / followed by my own 2000 years pattern

| | | |
|---------|-----|-----------|
| Abraham | 175 | Gen 25:7 |
| Isaac | 180 | Gen 35:28 |
| Jacob | 147 | Gen 47:28 |
| Joseph | 110 | Gen 50:26 |

Part of the following was observed by Stanley Gevirtz in an article called 'The Life Spans of Joseph and Enoch and the Parallelism'

Here the age of these four closely related and most central patriarchs of the Bible are used to produce the following mathematical relationship.

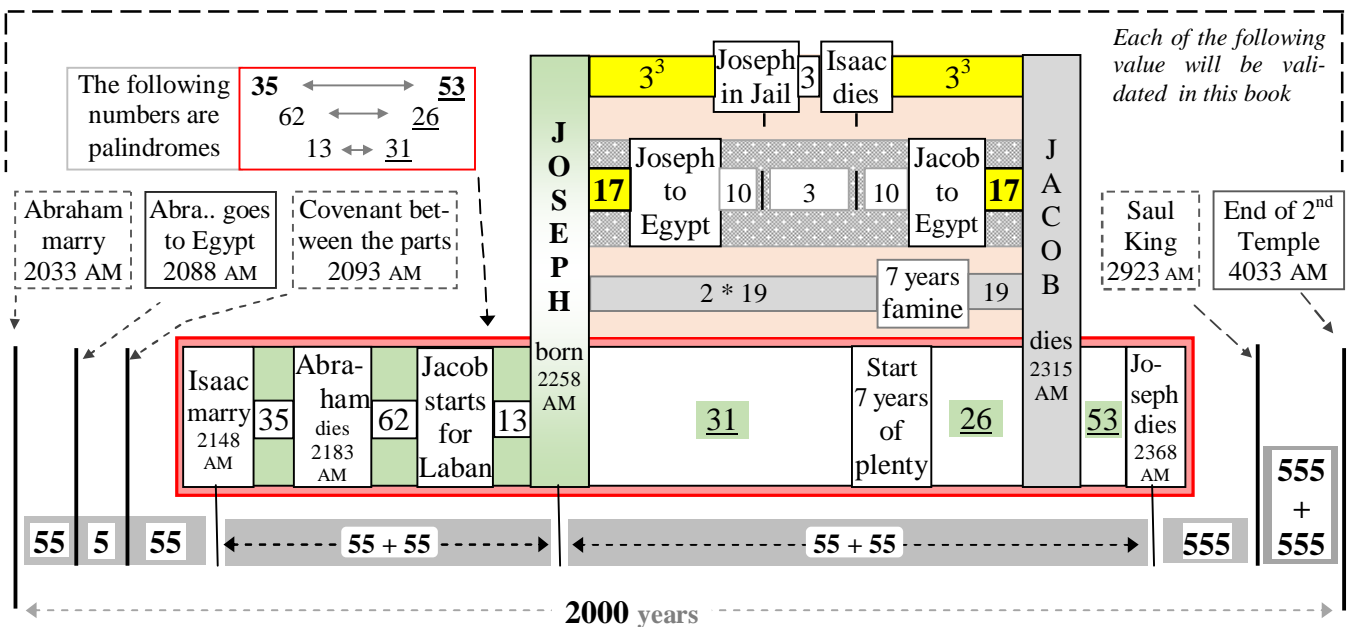
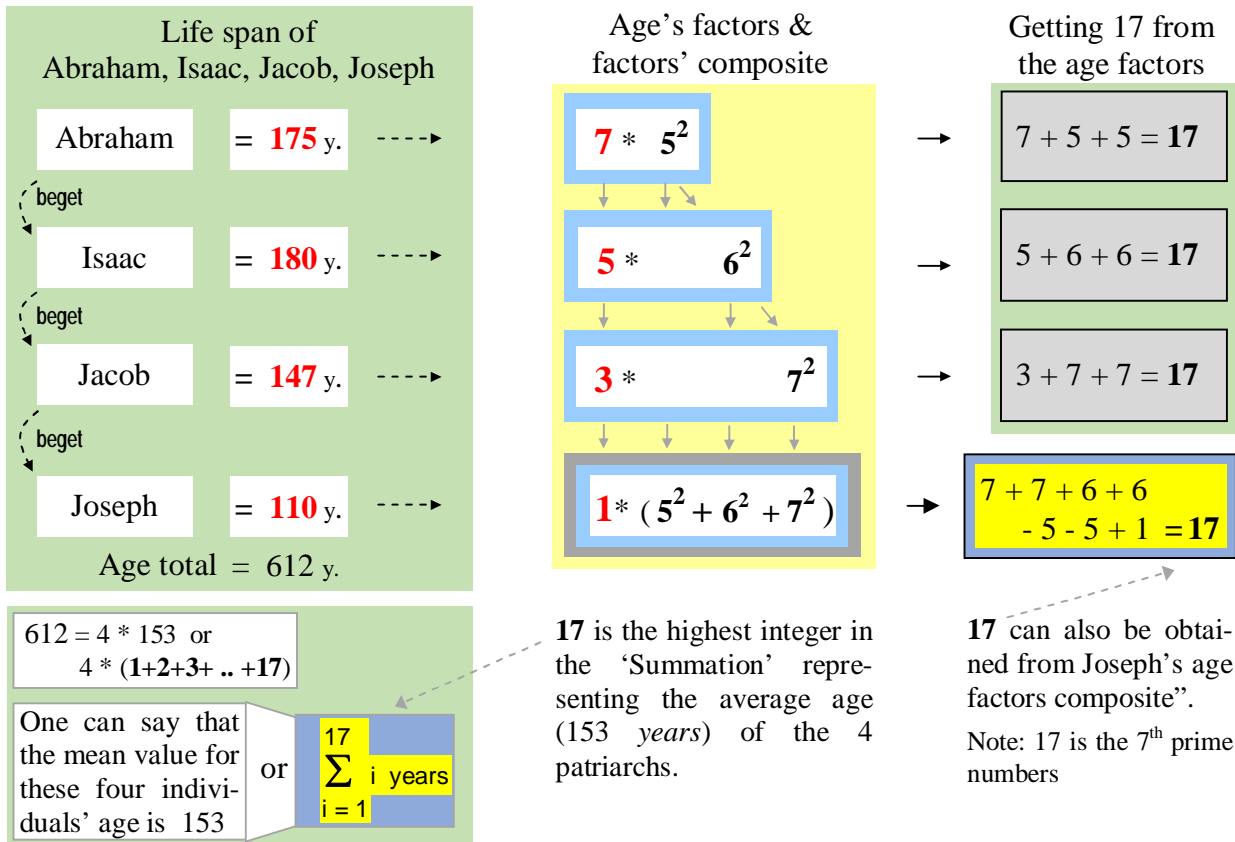

Second example : Genesis 1:1

The very first verse of the Bible tells us that God created the universe

Gen 1:1 In the beginning God created the heavens and the earth.

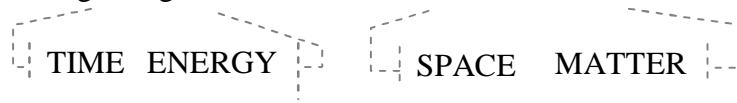

Here is Gen 1:1 in Hebrew with the Gematria¹ value expressed for each letter of the 7 words.

| GENESIS 1:1 | | | | | | |
|---|---------------|----------------------|----------------|--------------------|---------------|-----------------------------------|
| 7 | 6 | 5 | 4 | 3 | 2 | 1 |
| 90 200 1 5 | 400 1 5 | 40 40 300 5 | 400 1 40 | 40 5 30 1 | 200 2 1 | 400 10 300 1 200 2 |
| הָאָרֶץ | וָאֵת | הַשָּׁמַיִם | אֵת | אֱלֹהִים | בָּרָא | בְּרֵאשִׁית |
| earth the | and | heaven the | | God | created | beginning the In |
| 296 | 407 | 395 | 401 | 86 | 203 | 913 |
| ← 7 letters → | | ← 7 letters → | | ← 14 letters → | | ← 14 letters → |
| ← The 7 words use 28 letters (i.e. 1+2+3+4+5+6+7 letters) → | | | | | | |

The forth word 'את' (i.e. central word) is untranslatable. Its two letters, the letter Aleph א and the letter Tav ת are the very first and the very last letter of the Hebrew alphabet.

The gematria value of the 7 Hebrew words of Gen 1:1 leads to some fascinating information².

Total gematria = 913 + 203 + 86 + 401 + 395 + 407 + 296 = **2701**

2701 = 37 * 73 (37 & 73 are **Mirror Numbers** i.e. MN)

37 is the 12th prime number } **12 & 21** are MN)
73 is the 21th prime number.

2701 + 1072 = 3773 (Note: 2701 & 1072 are MN) = 7 * 7 * 77

| | | | |
|--|-------------------|-------|---|
| 1 st word + 3 rd word | = 913 + 86 | = 999 | Keep in mind for next page, if you rotate 999 you will obtain 666 |
| 2 nd word + 4 th word + 5 th word | = 203 + 401 + 395 | = 999 | |
| 6 th word + twice the 7 th word | = 407 + 296 + 296 | = 999 | |

If we add words #3, #5 and #6 (God, heaven, and, i.e. 86 + 395 + 407) we obtain 888

If we add words #3, #5 and #7 (God, heaven, earth, i.e. 86 + 395 + 296) we obtain **777**

777 = 37 * 7 * 3

¹ In the Hebrew alphabet each character has a value. A gematria of a word is the sum of these characters values.

² This information should be credited to Vernon Jenkins Ref 'The other bible code' on Internet

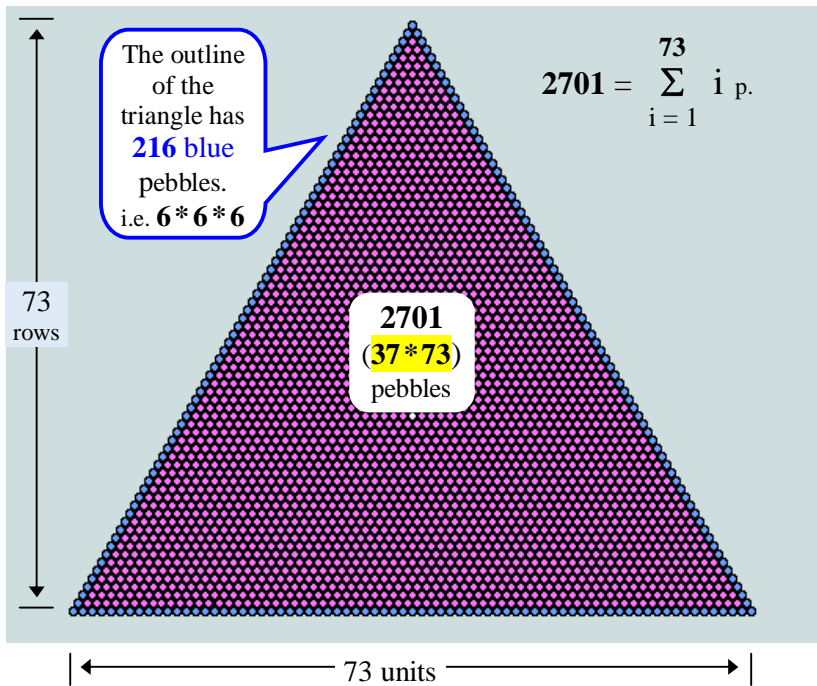

2701 is a triangular number and can be expressed like this:
 $1+2+3+\dots+71+72+73$

To visualize the value **2701**, we will build a triangle by aligning small pebbles (p) the following way:

there will be
1 pebble on the first row,
2 on the second,
3 on the third
...
73 pebbles on the 73th

There are 2701 pebbles in all.

Without adding or losing any pebble, we can transform the previous geometric structure in four perfectly fitting new ones.

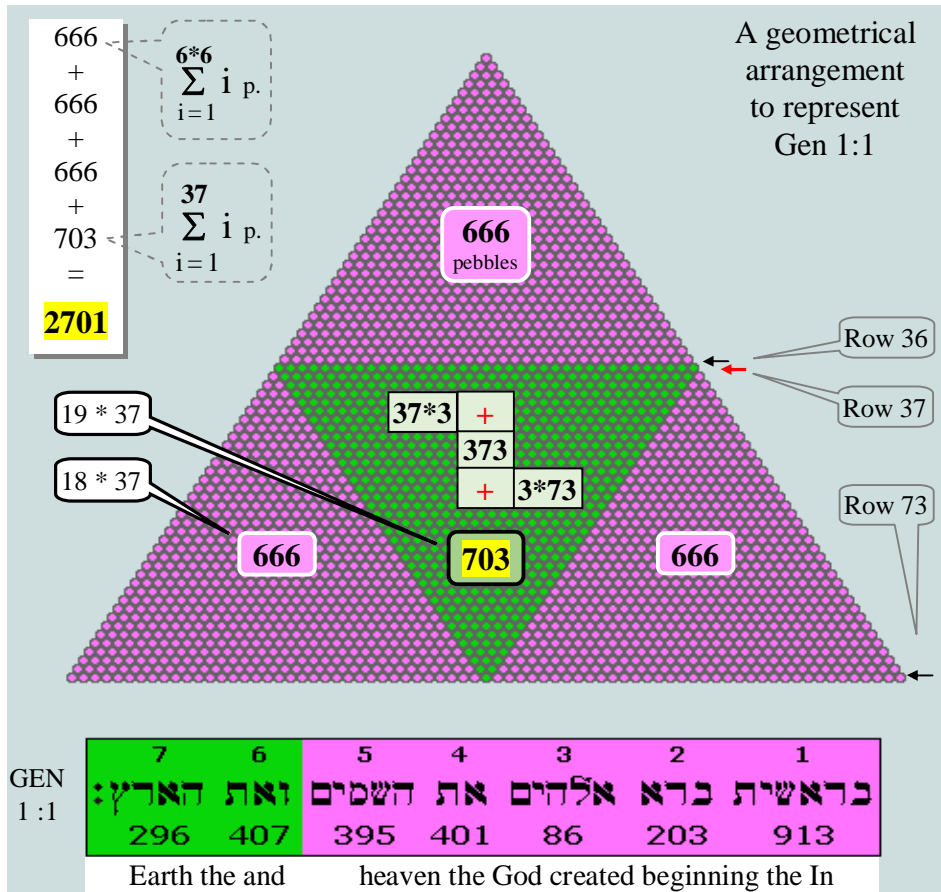

Notice

The first 5 words (gematria value of Gen 1:1)
i.e. (913, 203, 86, 401, 395)
add up to **3 * 666**

The last two words
'and the earth'

(gem. value of Gen 1:1)
i.e. (407, 296)
add up to **703**

Interesting:

$$666 = (6 + 6 + 6) * 37$$

$$666 = 1^6 - 2^6 + 3^6$$

$$666 = 2^2 + 3^2 + 5^2 + 7^2 + 11^2 + 13^2 + 17^2$$

(i.e. Sum of the square of the first 7 prime numbers)

$$666 = 1 + 2 + 3 + 4 + 567 + 89$$

$$= 123 + 456 + 78 + 9$$

$$= 9 + 87 + 6 + 543 + 21$$

Third example : The High Priest's Breastplate³

In Exodus 28 we are told that the High Priest was going to wear a piece of garment called the Breastplate. Over this garment was disposed, on 4 rows, 12 precious stones on which were engraved the **names of each tribe of Israel**, one name on each stone. Now lets see some surprising facts found by Ian Mallett and Vernon Jenkins. Independantly of its power, the breastplate was hiding the absolute cleverness of God.



To demonstrate this we need to see the breastplate as a mathematical matrix in which the name of each tribe of Israel is replaced by its gematria value⁴. The following table gives us the gematria's values corresponding to each tribe's name. (The tribe's order can be found in Gen 29:32-Gen 20:20, Gen 41:51-52)

| # | Tribe | Hebrew | gematria |
|---|----------|------------|----------|
| 1 | Reuben | רְאוּבֵן | 259 |
| 2 | Simeon | מְעִישׁוֹן | 466 |
| 3 | Judah | יְהוּדָה | 30 |
| 4 | Dan | דָּן | 54 |
| 5 | Naphtali | נַפְתָּלִי | 570 |
| 6 | Gad | גָּד | 7 |

| | | | |
|----|----------|------------|-----|
| 7 | Asher | אֲשֵׁר | 501 |
| 8 | Issachar | יִשָּׁשכָר | 830 |
| 9 | Zebulun | זְבֻלוּן | 95 |
| 10 | Benjamin | בְּנִימִין | 162 |
| 11 | Manasseh | מְנַשֶּׁה | 395 |
| 12 | Ephraim | אֶפְרַיִם | 331 |

| | | |
|-----------------------|------------------------|------------------------|
| 3 | 2 | 1 |
| 30 Judah | 466 Simeon | 259 Reuben |
| 6 | 5 | 4 |
| 7 Gad | 570 Naphtali | 54 Dan |
| 9 | 8 | 7 |
| 95 Zebulun | 830 Issachar | 501 Asher |
| 12 | 11 | 10 |
| 331 Ephraim | 395 Manasseh | 162 Benjamin |

Here we have each matrix's row filled from right to left with the name of each tribe according the order of their birth.

Notice two important rules:

The name of 'LEVI' is not used in the matrix. The Breastplate was weared by a Levite therefore there was no need to represent that tribe with a stone.

The name of **Joseph** is not used either. Instead we replace it with the names of his two sons (**Manasseh & Ephraim**) who were adopted by Jacob (Gen 48:5).

The first interesting fact in this matrix is that the sum of all the gematria value = **3700**.

$$= 259 + 466 + 30 + 54 + 570 + 7 + 501 + 830 + 95 + 162 + 395 + 331$$

$$\mathbf{3700 = 10 * 10 * 37}$$

³ The following description should be entirely credited to two individuals, one is called Ian Mallett and the other is Vernon Jenkins whose work can be seen at <http://www.whatabeginning.com/> under 'AN ORACLE RESTORED'

⁴ In the Hebrew alphabet each character has a value and the gematria of a word is the sum of these values.

| | | |
|----------------------|-----------------------|-----------------------|
| 3 30 Judah | 2 466 Simeon | 1 259 Reuben |
| 6 7 Gad | 5 570 Naphtali | 4 54 Dan |
| 9 95 Zebulun | 8 830 Issachar | 7 501 Asher |
| 12 331 Ephraim | 11 395 Manasseh | 10 162 Benjamin |

The combined value of the greens squares
(259+30+570+501+95+395)

$$= 1850$$

or

$$50 * 37$$

The combined value of the oranges squares
(466+54+7+830+162+331)

$$= 1850$$

or

$$50 * 37$$

| | | |
|----------------------|-----------------------|-----------------------|
| 3 30 Judah | 2 466 Simeon | 1 259 Reuben |
| 6 7 Gad | 5 570 Naphtali | 4 54 Dan |
| 9 95 Zebulun | 8 830 Issachar | 7 501 Asher |
| 12 331 Ephraim | 11 395 Manasseh | 10 162 Benjamin |

The combined value of the yellows squares
(259+466+54+570+501)

$$= 1850$$

or

$$50 * 37$$

The combined value of the blues squares
(30+7+830+95+162+395+331)

$$= 1850$$

or

$$50 * 37$$

Interesting:

The gematria of Gen 1:1 (i.e. 2701) is found in the Breastplate's matrix

| | | |
|----------------|-----------------|-----------------|
| 30 Judah | 466 Simeon | 259 Reuben |
| 7 Gad | 570 Naphtali | 54 Dan |
| 95 Zebulun | 830 Issachar | 501 Asher |
| 331 Ephraim | 395 Manasseh | 162 Benjamin |

$$30 + 466 + 259 + 570 + 54 + 95 + 501 + 331 + 395 = \mathbf{2701}$$

$$7 + 830 + 162 = \mathbf{999}$$

Fourth example: The seven resurrections.

There are plenty of example showing that the number ‘7’ has a special meaning in the Bible

At the creation of the world, the **seventh day** was set apart from the previous six days. This is the only day which does not mention any new creative elements. Day 7 is also the only day that does not have the repeated formula, “And there was evening and there was morning. It is obvious that the seventh day is special.

Special too was the **7th patriarch** ‘Enoch’ (Adam, Seth, Enosh, Kenan, Mahalalel, Jared, Enoch). Gen 5:24 Enoch walked with God; then he was no more, because God took him away.

Joshua and Israel marched around Jericho **seven** times while **seven** priests blew **seven** trumpets before the walls came crashing down (Joshua 6:3-4).

On a recommendation of the prophet Elisha, Naaman, commander of the army of the king of Aram, was cure of leprosy by going to wash himself **7 times** in the Jordan (ref 2 King 5:1-14)

God instituted **7 feast days**. There are 4 in the spring : Passover, Unleavened bread, First fruits, Feast of Weeks. And there are 3 in the fall: Trumpets (Rosh Hashanah), Atonement (Yom Kippur), Tabernacles (Sukkot).

Yeshua was the **7th individual** brought back to life in the Bible. His resurrection is especially special giving that the 6 previous one are part of an unexpected pattern⁵ organized around the post mortem stage of those who died.

A double sequence of three post mortem stages

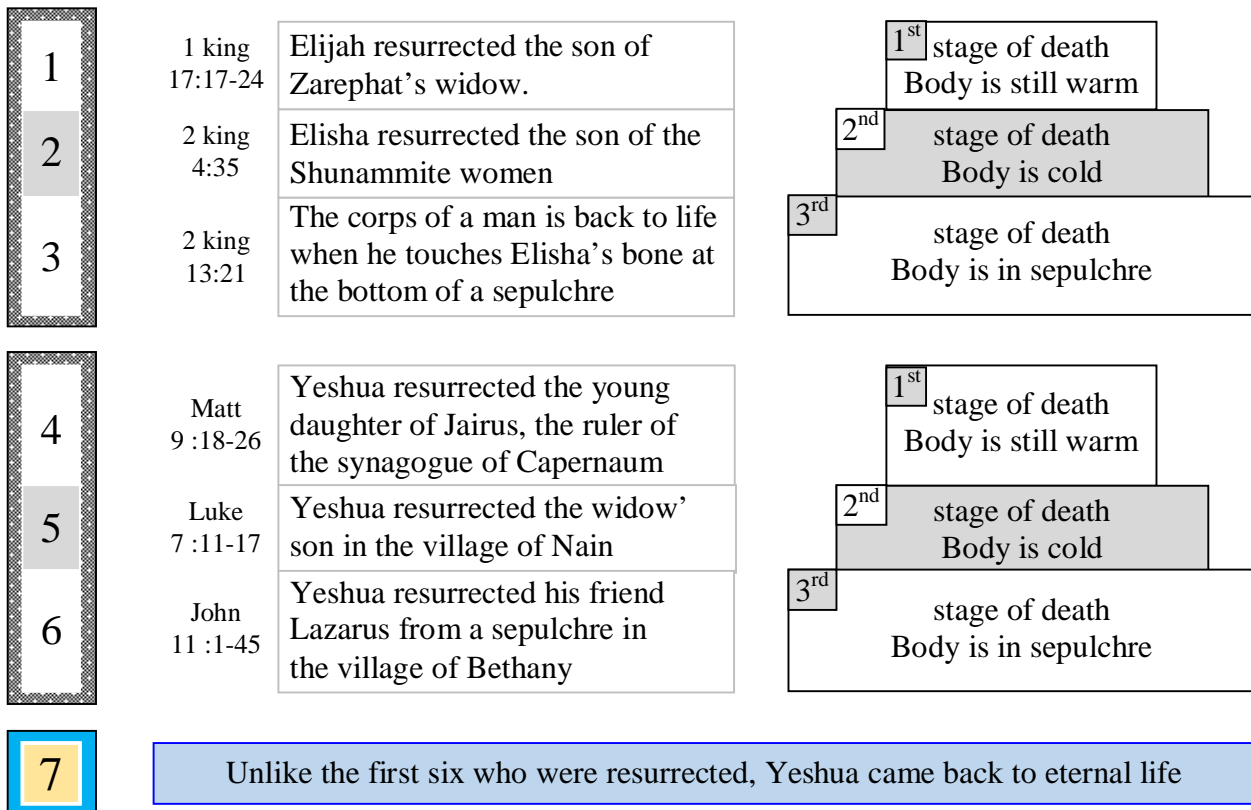

⁵ I learned about this pattern in ‘The Resurrection Pattern’ by Darek Barefoot

Apart of the second half of the first example, I have nothing to do with the previous four examples. I have included them at the beginning of this book with one goal in mind, show the readers that patterns are an integral part of the biblical message and therefore they should be sought as if they were precious gems. I know by experience that when they are found they are often awe-inspiring. It is the way of the Bible: The right understanding leads to great discoveries.

Let’s try to understand what we are told in Ezekiel 4-5

The 40 years imputed to the house of Judah

The logical start for the ‘40 years of sin’ of Judah should be 40 years before the destruction of Jerusalem by Nebuchadnezzar’s army, but this solution presents a major flaw and is therefore totally unacceptable.

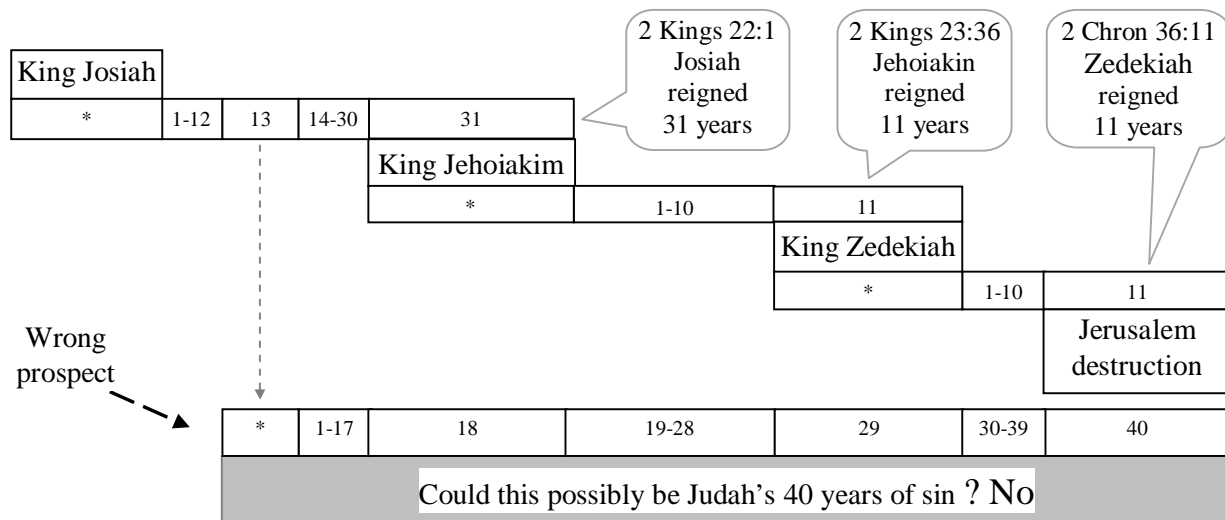

As we can see, going backwards 40 years from Jerusalem’s destruction in the 11th year of Zedekiah brings us into the 13th year⁶ of Josiah. Why would the “40 years of sin” start in the kingship of one of the few kings who really sought God’s approval? King Josiah was responsible for major reform that brought his people closer to God:

- Jer 22:15-16 Did not your father [Josiah] have food and drink? He did what was right and just, so all went well with him. He defended the cause of the poor and needy...
- 2 Kings 23:25 Neither before nor after Josiah was there a king like him who turned to the LORD as he did-with all his heart and with all his soul and with all his strength...

Have you considered this? Before Josiah’s reign, many of the previous kings had led the people astray for the whole duration of their reign. Weren’t these ‘years’ also years of sin? Why should they be ignored? Why did God restrict the period of sin to 40 years when we could easily count hundreds of years of sinful reign?

⁶ Jeremiah started prophesying the same year : Jer. 25:3 For twenty-three years--from the thirteenth year of Josiah son of Amon king of Judah until this very day--the word of the LORD has come to me and I have spoken to you again and again, but you have not listened.

A premise } Given that the 40-year of sin (alluded by the 40 days of sin in Ezek 4:6) represents a fixed period, we can deduce that there was a period without sin before and after this 40-year of sin. If this were not the case it wouldn't be possible to mark the beginning and the end of these 40 years.

Here is a new way to look at it:

When Ezekiel was told to bear the sin of the house of Judah, he was not told to bear all the sins of Judah; the request was much more specific than that. **He was going to bear ONLY one sin, one sin that lasted 40 years.** All other sins committed by Judah could have lasted hundreds of years, or they could have been preceded and followed by years without sin; in the end these other sins were irrelevant to Ezekiel's 40 years of Sin.

HOUSE OF JUDAH HISTORY

| | | | | |
|--------------------------------------|----------------------------|--------------------|----------------------------|-------------------------|
| Solomon dies | X years | 40 years | Y years | Jerusalem's destruction |
| Kingdom splits (Ref 1 King 12:16) | Absence of the special sin | Special Sin | Absence of the special sin | |

What was Judah's special Sin?

- Ezek 5:11-12 Therefore as surely as I live, declares the Sovereign LORD, because you have **defiled my sanctuary** with all your vile images and detestable practices, I myself will withdraw my favor; I will not look on you with pity or spare you. A third of your people will die of the plague or perish by famine inside you; a third will fall by the sword outside your walls; and a third I will scatter to the winds and pursue with drawn sword.

See also 2 Kings 21:7, Jer 7:30, 2 Chron 33:4-6, 2 Chron 33:7

➔ ➔ ➔ **Defilement of God's Temple** ← ← ←

Defiling the Temple (His dwelling place) was certainly an abomination in the eyes of God, something worse than anything else the people could have done.

We have now to answer three questions:

- Who did it?
- How and when was it stopped?
- When did it start?

Who did it?

- 2 Kings 21:7-9 He took the carved Asherah pole he had made and put it in the temple **Manasseh** led them astray, so that they did more evil than the nations the LORD had destroyed before the Israelites.

See also Jer 15:3-4, 2 Kings 23:26-27, 2 Kings 24:2-4

So who did it? ➔ King Manasseh defiled the Temple.

How and when was it stopped?

- 2 Kings 23:4 The king ordered Hilkiah the high priest, the priests next in rank and the doorkeepers to remove from the temple of the LORD all the articles made for Baal and Asherah and all the starry hosts. He burned them outside Jerusalem in the fields of the Kidron Valley and took the ashes to Bethel.
- 2 Kings 23:21-23 The king gave this order to all the people: "Celebrate the Passover to the LORD your God, as it is written in this Book of the Covenant." Not since the days of the judges who led Israel, nor throughout the days of the kings of Israel and the kings of Judah, had any such Passover been observed. But **in the eighteenth year of King Josiah**, this Passover was celebrated to the LORD in Jerusalem

See also 2 Kings 23:1-3, 2 Kings 23:7, 2 Kings 23:11-12

When was it stopped? → The Temple was purified in Josiah's 18th year.

When did the '40 years of sin' start?

We know from 2 Kings 23:23 that Josiah cleansed the Temple in the 18th year of his kingship:

We also know from Ezek 4:6 that the Sin lasted 40 years (expressed as 40 days).

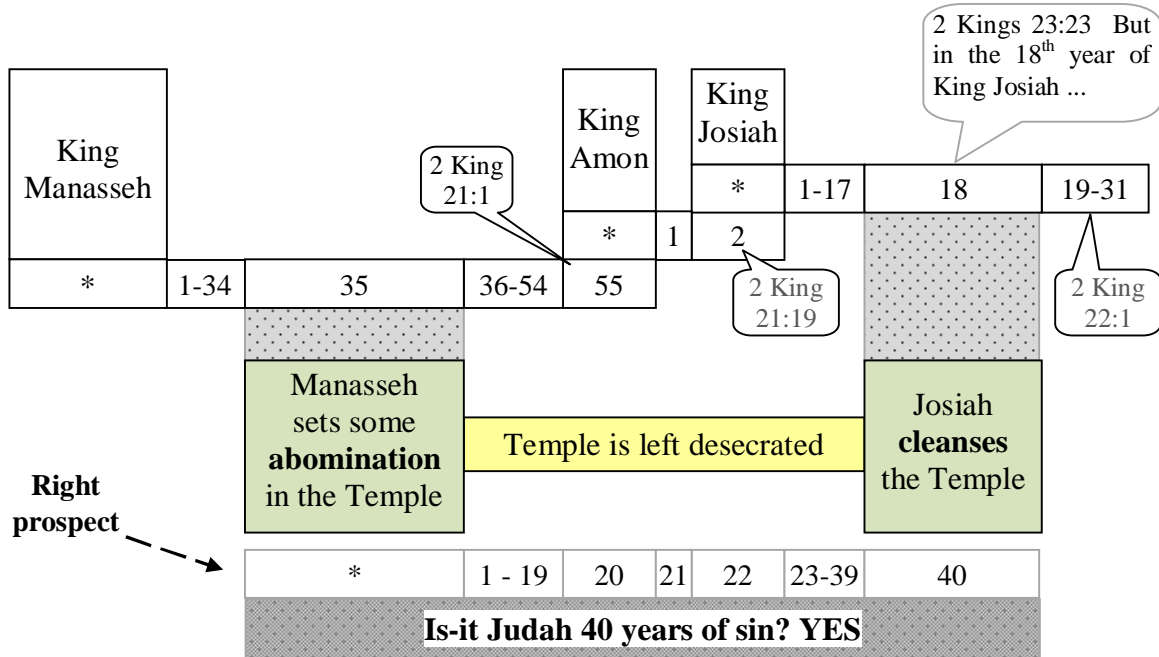

It's a simple matter to go back 40 years from the 18th year of Josiah and find that the starting point of this desecration (abomination) happened in Manasseh 35th year of reign.

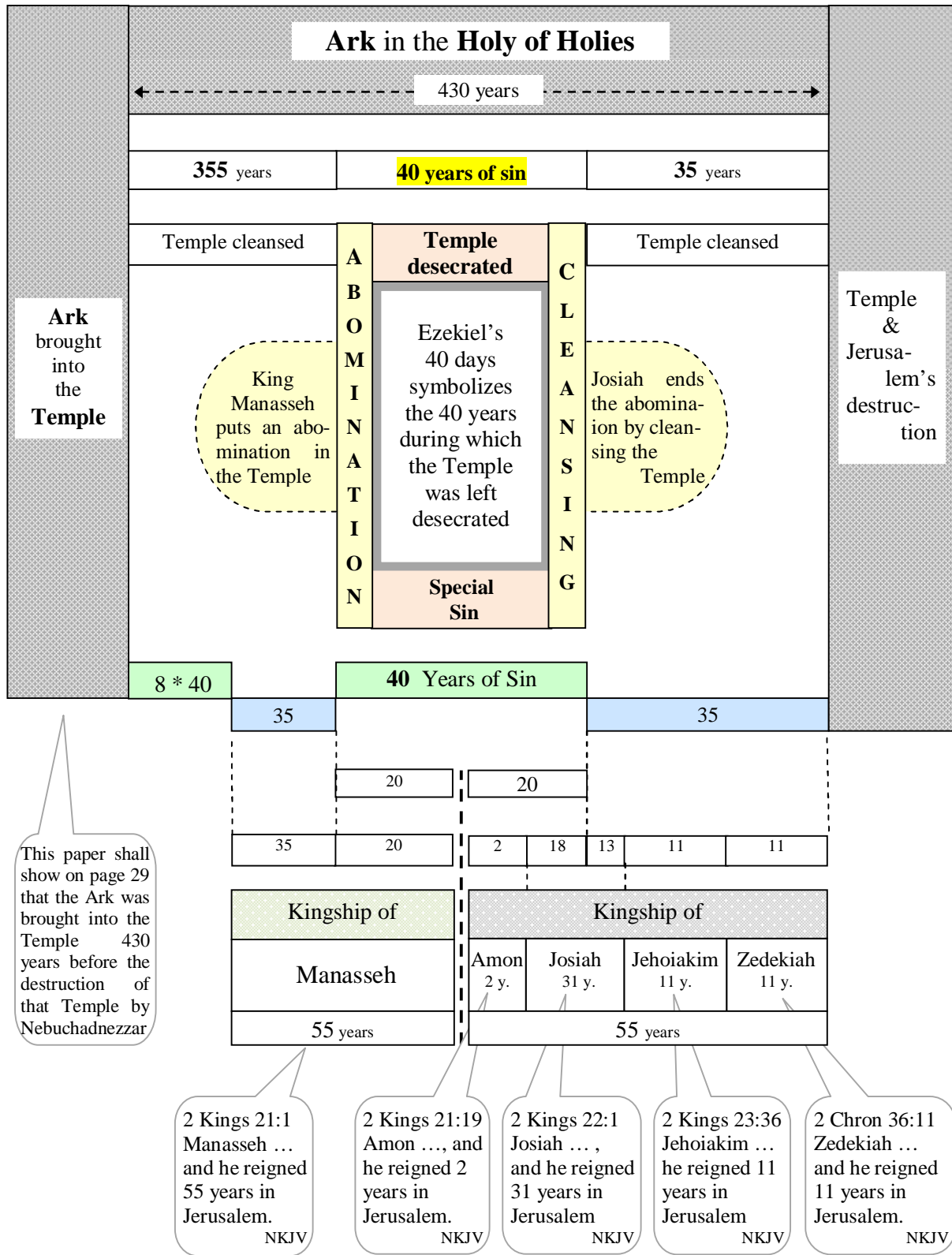

Figure 1. Judah's 40 years of Sin

The 390 years imputed to the house of Israel

The house of Israel's sin that we are looking for needs to satisfy the following 5 requirements:

- #1. Unique and never done before
- #2. Started at a specific time
- #3. Ended at a specific time
- #4. Lasted 390 years (and involve the same people from the start to the end)
- #5. Inflamed God

Here, contrary to the house of Judah's very unique sin that we have identified earlier, no such sin can be found in relation to the house of Israel. We have to consider the only other alternative: **the '390 years of sin' refers to a time in which numerous sins were committed.** Given that it is very unlikely that all those sins started on the same day, the beginning that we are looking for must be linked to an event involving the 12 tribes and must have been so disgraceful to God that it became the start of the 390 years of sin. Unsurprisingly, there is such an event.

- Hos 9:9 They have sunk deep into corruption, as **in the days of Gibeah**. God will remember their wickedness and punish them for their sins.
- Hos 10:9 "**Since the days of Gibeah**, you have sinned, O Israel, and there you have remained.

Judges 19 describes what happened in Gibeah. It can be summarized the following way:

A Levite and his concubine found shelter for the night in an old man's house in Gibeah. During the night the concubine was abused by some of the wicked men of the city while this Levite showed no concern for her. The woman was found lying on the threshold of the house in the morning. Later, the Levite dismembered his concubine (while she might have been still alive) and sent one part to every tribe of Israel:

- Judg 19:29 When he reached home, he took a knife and cut up his concubine, limb by limb, into twelve parts and sent them into all the areas of Israel.

The disastrous outcome of this event was that the 12 tribes were involved in a fratricidal war for the first time.

- Among the 11 tribes who fought against Benjamin there was more than 40,000 victims.
- Benjamin's tribe was nearly exterminated⁷. Among all the men, woman and children of that tribe only 600 soldiers survived by hiding for 4 months⁸.

⁷ Judg 20:48 The men of Israel went back to Benjamin and put all the towns to the sword, including the animals and everything else they found. All the towns they came across they set on fire.

⁸ Judg 20:46-47 On that day twenty-five thousand Benjamite swordsmen fell, all of them valiant fighters. But six hundred men turned and fled into the desert to the rock of Rimmon, where they stayed four months. NIV

The incident at Gibeah is the perfect candidate for the start⁹ of the 390-year period.

- ❖ Hosea (10:9) called the 'days of Gibeah' 'the start of a period of sin'. This is exactly what we are looking for.
- ❖ What happened was unique.¹⁰

Notice that the original intent of the men of Gibeah (Benjamites) was to commit **an abomination** prescribed by the law of God. Compare¹¹ Judge 19:22 and Lev 18:22. Therefore, both periods of sin (390 years and 40 years¹²) are associated with abominations.

When did the Gibeah incident happen?

Phinehas, the grandson of Aaron, was officiating when it happened. It situates the incident in the period following the arrival in the Promised Land:

- Judg 20:27-28 And the Israelites inquired of the LORD. (In those days the ark of the covenant of God was there, with Phinehas son of Eleazar, the son of Aaron, ministering before it.)

Israel served the Lord until all the elders who had witnessed the Exodus died. That makes it unlikely that the Gibeah incident happened before the death of Joshua:

- Josh 24:31 Israel served the LORD throughout the lifetime of Joshua and of the elders who outlived him and who had experienced everything the LORD had done for Israel.

If we speculate that the elders who outlived Joshua were at least 15 years old at the time of the Exodus (old enough to have understood what was going on) but younger than 20 years old (otherwise they would have died before reaching the promised land, a direct outcome of the spy event as stipulated in Num 14:29) we have a group of people aged at least 60 years old at the division of the land. All those elders could have died during the next 30 years after the division of the land.

Note that Josh. 24:31 implies that Israel stopped serving the Lord not long after the death of all those witnesses.

⁹ There is no doubt that Israel was already sinning long before the event of Gibeah but the ABOMINATION that was committed at that time was worse than everything else.

¹⁰ Judg. 19:30 Everyone who saw it said, "Such a thing has never been seen or done, not since the day the Israelites came up out of Egypt

¹¹ Judg 19:22 "Bring out the man who came to your house so we can have sex with him."
Lev 18:22 Thou shalt not lie with mankind, as with womankind: it is abomination.

¹² 2 Kings 21:11 "Because Manasseh king of Judah has done these abominations (he has acted more wickedly than all the Amorites who were before him, and has also made Judah sin with his idols),

The following figure gives the chronology of some important events that occurred during the Exodus period.

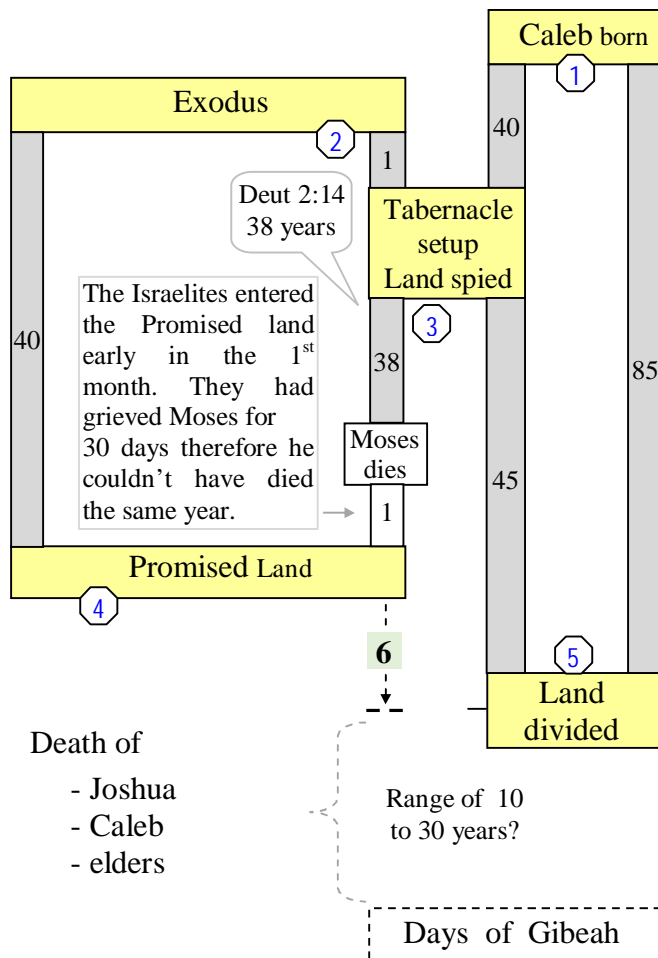

From 3 to 5 & From 1 to 5

Josh. 14:10 "Now then, just as the LORD promised, he has kept me alive for forty-five years since the time he said this to Moses, while Israel moved about in the desert. So here I am today, **eighty-five** years old!"

From 1 to 3

Josh. 14:7 I was **forty years** old when Moses the servant of the LORD sent me from Kadesh Barnea to explore the land.

From 2 to 3

Num 10:11-12 On the twentieth day of the second month of the second year, Then the Israelites set out from the Desert of Sinai ...

The land was spied in the **second year**.

From 2 to 4

Num 14:33-34 For **forty years**--you will suffer for your sins

From 4 to 5

Land was divided **6 years** after coming in the Promised Land. $85 - 40 - 38 - 1$

Figure 2. Land divided

We are told in Ezekiel 4. that the '390 years of sin' are associated with the 'House of Israel', however the event of Gibeah involved the 12 tribes of Israel. Could Ezekiel have used the term 'House of Israel' with the 12 tribes¹³ in mind? Yes, the two Hebrew words (beeyt-Yisraa'eel) transliterated as 'the House of Israel' in Ezekiel 4:4 were also used to point to the twelve tribes in other instances¹⁴ and this, a long time before the split of the two Kingdoms.

- Ex 16:31 And the house of Israel called its name Manna. NKJV
Nobody will contest the fact that Moses was here referring to the 12 tribes of Israel:
- Ruth 4:11 The LORD make the woman that is come into thine house like Rachel and like Leah, which two did build the house of Israel: NKJV

¹³ 'House of Israel' is the term often used to point to the group of 10 tribes who chose Jeroboam as King after Solomon's death. Ref 1 King 12:20.

¹⁴ Strong #1004 = beeyt- and Strong # 3478 = Yisraa'eel are also found together in Ex 40:38, Lev 10:6, Lev 17:3, :8, :10, Lev 22 :18, Num 20 :29, Josh 21 :45, Ruth 4 :11, 1 Sam 7:2 , :3, 2 Sam 1:12

Following the Gibeah incident the Israelites kept sinning for several hundred years. During that time:

- They were often oppressed in response to their worshipping of others gods.
- The Ark was captured.
- They rejected God their true King.
- God rejected Saul their first king.

It would have been an amazing change if the people had suddenly succeeded in reforming themselves after all these years, yet, according to Ezekiel the period of sin lasted no more than 390 years. What could have happened to justify that the count of years of sin came to a stop after 390 years?

The answer seems to be directly related to God's dwelling place:

- Deut 12:4-5 You must not worship the LORD your God in their way. **But you are to seek the place the LORD your God will choose from among all your tribes to put his Name there for his dwelling.**

At the time of the Gibeah incident God's "permanent" dwelling place was at Shiloh (**under the jurisdiction of Ephraim**¹⁵), however He abandoned it and chose Zion instead.

- Ps 78:59 he rejected Israel completely.
- Ps 78:68 but he chose the tribe of Judah, Mount Zion, which he loved.

If it can be shown that God's dwelling place was moved to Zion exactly 390 years after the Gibeah incident, we would have a very strong argument to explain why Israel's years of Sin did not go over the 390 mark; the logic would be that by moving to a new dwelling place, God was heralding an important change. Offering a new beginning (see p. 23) to the people by bringing to an end the counting of the years of their sins would be in harmony with the notion of an important change.

Paying attention to the Ark of covenant location

God rejected the House of Israel (He left Shiloh)

- 1 Sam 4:22 The glory has departed from Israel, for the ark of God has been captured."

We have something truly unique here: as a sign that He had rejected the House of Israel and His dwelling place in Shiloh, God sent the Ark into captivity:

- 1 Sam 3:11 And the LORD said to Samuel: "See, I am about to do something in Israel that will make the ears of everyone who hears of it tingle.

God chose the House of Judah (He came to Zion)

Years later the Ark would again be used, but this time to show that God was coming to His new dwelling place in Zion.

¹⁵ Jer 31:9 because I am Israel's father, and Ephraim is my firstborn son. NIV

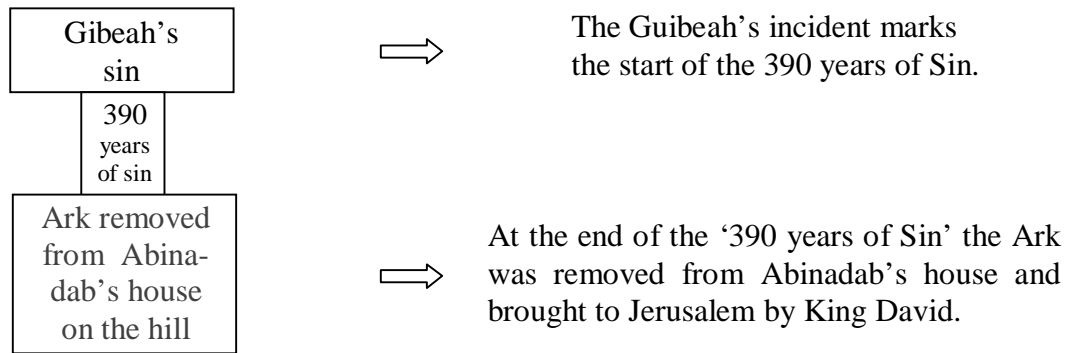

When the time came to bring the Ark into Jerusalem David had to fetch it from the house of Abinadab. In 2 Sam 6:3 we are told that Abinadab's house was on a **hill**. Why are we told this seemingly useless detail? It doesn't appear to bring anything to the story and from the reader's perspective that 'hill' could have been any hill.

The Hebrew word translated as '**hill**' in 2 Sam 6:3 is the very same word used in Judges 19 to designate the Benjamite town of '**Gibeah**'. Interesting, isn't it? The implication here is that we were not merely informed that the house of Abinadab was on an 'unknown' hill, impossible to identify, but we were rather told that this house was at Gibeah, the same 'Gibeah' that was involved with the start of the 390 years of Sin. Notice that while most English translations of the Bible have the house of Abinadab on a hill, the KJV has located it at 'Gibeah':

- 2 Sam 6:3 And they set the ark of God upon a new cart, and brought it out of the house of Abinadab that was in Gibeah: KJV

Obviously 'Gibeah' and 'hill' are from the same Hebrew word. Which one the author of 2 Sam 6:3 had in mind when he wrote the verse is hard to determine but we can speculate in favor of 'Gibeah'.

The town of Gibeah was where King Saul (the first king of Israel) lived during his whole kingship. Therefore, it would be reasonable to think that, at one time during his kingship, he had the Ark brought to Gibeah so that it could be close to him. Was not David going to do exactly the same when he moved to Jerusalem?

- 2 Sam 6:12 O David went down and brought up the ark of God from the house of Obed-Edom to the City of David with rejoicing. NIV

As we can see, the start and the end of the 390 years of sin are both related to Gibeah somehow.

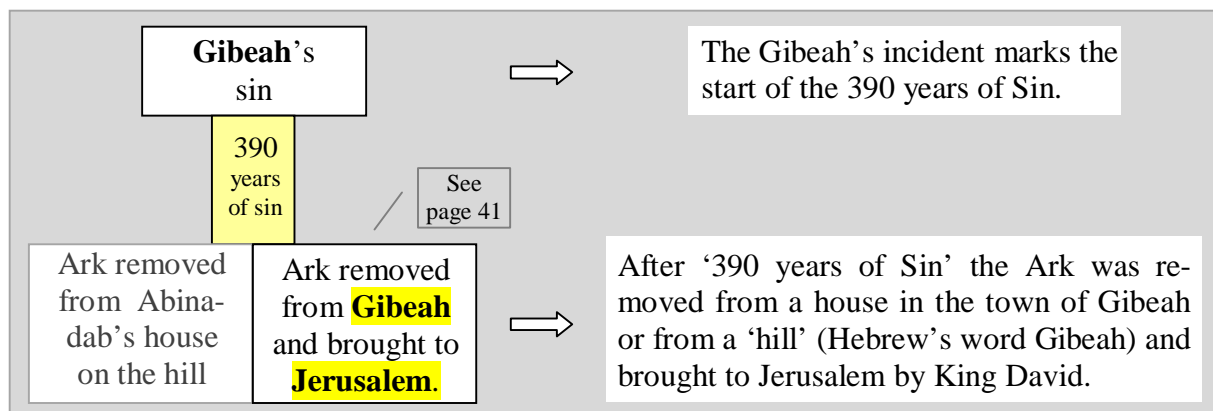

The following 7 points will highlight some interesting parallels between the Start (S1-S7) and the End (E1-E7) of that 390-year period. They confirm that the two events are related somehow.

| | | |
|-----------|---|-----------|
| S1 | <p>There was no King in Israel at that time:</p> <ul style="list-style-type: none"> • Judg 19:1 In those days Israel had no king. | |
| | <p>David was the first king to reign over all Israel.</p> | E1 |

| | | |
|-----------|--|-----------|
| S2 | <p>The Levite wouldn't go to Jerusalem for sanctuary:</p> <ul style="list-style-type: none"> • Judg 19:12 No We won't go into an alien city, whose people are not Israelites. | |
| | <p>The Ark could not be brought to its new sanctuary without the participation of the Levites:</p> <ul style="list-style-type: none"> • 1 Chron 15:12-13 "You are the heads of the Levitical families; you and your fellow Levites are to consecrate yourselves and bring up the ark of the LORD, the God of Israel, to the place I have prepared for it. It was because you, the Levites, did not bring it up the first time that the LORD our God broke out in anger against us. | E2 |

| | | |
|-----------|---|-----------|
| S3 | <p>The Levite wouldn't go to Jerusalem because it was occupied by the Jebusites:</p> <ul style="list-style-type: none"> • Judg 19:11-12 "Come, let's stop at this city of the Jebusites and spend the night." His master replied, "No. | |
| | <p>When David came to Jerusalem, a few years before he brought the Ark, the first thing he and his army did was to remove the Jebusites from the city:</p> <ul style="list-style-type: none"> • 2 Sam 5:6 The king and his men marched to Jerusalem to attack the Jebusites, who lived there. | E3 |

| | | |
|-----------|--|-----------|
| S4 | <p>The Levite dismembered his concubine in 12 parts:</p> <ul style="list-style-type: none"> • Judg 19:29 When he reached home, he took a knife and cut up his concubine, limb by limb, into twelve parts and sent them into all the areas of Israel. | |
| | <p>The last Benjamite king over Israel was Ish-Bosheth and he was killed by two of his own compatriots. The surprising thing about this is that all three Benjamites men were dismembered and the total number of their limbs was also 12.</p> <p style="margin-left: 40px;">Ish-Boseth's head was cut off: = 2 parts.</p> <ul style="list-style-type: none"> • 2 Sam 4:7 After they stabbed and killed him, they cut off his head. <p style="margin-left: 40px;">Recab and Baanah, Ish-Boseth's murderer: 5 parts each = 10 parts</p> <ul style="list-style-type: none"> • 2 Sam 4:12 They cut off their hands and feet and hung the bodies by the pool in Hebron. | E4 |

S5 The people of Israel who came to fight at Gibeah didn't want to go to war against the whole tribe of Benjamin. They sent men among the Benjamites to negotiate the surrender of the wicked men of Gibeah who had abused the Levite concubine:

- Judg 20:13 Now surrender those wicked men of Gibeah so that we may put them to death and purge the evil from Israel."

Unexpectedly the **Benjamites refused to listen to their brother** and chose to protect those who were guilty.
All the Benjamite woman and children were killed during the following war. (Jud 20:48)

Of all the people gathered in Jerusalem for the bringing in of the Ark, the only one (we are told) who didn't show a joyful heart during the event was Michal, the King's wife. She despised David because he was dancing before the Ark:

- 2 Sam 6:16 As the ark of the LORD was entering the City of David, Michal daughter of Saul watched from a window. And when she saw King David leaping and dancing before the LORD, she despised him in her heart.

Unexpectedly Michal, a **Benjamite** (daughter of Saul) **refused to humble herself**.

This Benjamite woman didn't have any children until the day of her death. (2 Sam 6:23)

E5

S6 After having fought and won against the Benjamites, the people of Israel went to Bethel ('**house of God**') to repent of the gravity of their action.

→ The people fasted:

- Judg 21:2 The people went to Bethel, where they sat before God until evening, raising their voices and weeping bitterly.

→ Presented burnt offerings and fellowship offerings:

- Judg 21:4 and presented burnt offerings and fellowship offerings.

After the Ark was brought to Zion (its new **dwelling place**)

→ David presented burnt offerings and fellowship offering:

- 1 Chron 16:2 After David had finished sacrificing the burnt offerings and fellowship offerings

→ And they were fed:

- 1 Chron 16:3 Then he gave a loaf of bread, a cake of dates and a cake of raisins to each Israelite man and woman.

E6

S7 One outcome of the Gibeah incident was the near extinction of the Benjamites. Of the 600 men who survived 200 needed to find a wife among the other tribes. It was agreed that they could pick one from **among the girls that were dancing at Shiloh**. (see Jud 21:20-22)

When the Ark came to Zion **David was seen leaping and dancing** before the Lord:

- 2 Sam 6:16 and when she saw King David leaping and dancing before the LORD

E7

NOTE: In each case the dancing was very special and the person doing it would never have to do it again.

-- The girls of Shiloh were dancing to find a husband (otherwise the author of Jud 21:22 would have used a much stronger word than 'complaint' to describe the people's protestation. Notice also that only the girls' fathers and brothers were involved, if the matter had been dramatic the whole town would have joined in.).

-- The King was dancing in the street (a very unusual sight) because the Ark was coming to Zion. He would never have to do it again.

It was previously said (on page 19) that the count of years was stopped in the 390th year because that year (when the Ark was brought to Jerusalem) the Israelites were offered a new beginning. Were they really offered a new beginning?

Bringing the Ark to Jerusalem was a major event in the history of the 12 tribes and it was done with the approbation of God and every leader of Israel¹⁶.



When the right time came everybody¹⁷ in Israel was mobilized to bring the Ark and each one had the proper attitude for transforming that day into a grand celebration.

Holiness

- 1 Chron 15:12-13 "You are the heads of the fathers' houses of the Levites; sanctify yourselves, you and your brethren, that you may bring up the ark of the LORD God of Israel to the place I have prepared for it.

Respect

- 2 Sam 6:13 And so it was, when those bearing the ark of the LORD had gone six paces, that he sacrificed oxen and fatted sheep.

Humility

- 2 Sam 6:14 Then David danced before the LORD with all his might; and David was wearing a linen ephod.

Joy

- 2 Sam 6:15 So David and all the house of Israel brought up the ark of the LORD with shouting and with the sound of the trumpet.

When the Ark reached its new Tabernacle in Zion (the tent used at the previous location was not brought with the Ark) David offered a peace offering¹⁸ to God in the name of all the people¹⁹.

And then David blessed²⁰ all the people **in the name of God.**

¹⁶ 1 Chron 13:1-3 Then David consulted with the captains of thousands and hundreds, and with every leader. And David said to all the assembly of Israel, "If it seems good to you, and if it is of the LORD our God, let us send out to our brethren everywhere who are left in all the land of Israel, and with them to the priests and Levites who are in their cities and their common-lands, that they may gather together to us; and let us bring the ark of our God back to us NKJV

¹⁷ 1 Chron 15:3 David assembled all Israel in Jerusalem to bring up the ark of the LORD to the place he had prepared for it.

¹⁸ Peace Offering. This sacrifice celebrated covering of sin, forgiveness by God, and the restoration of a right and meaningful relationship with God and with life itself. (from Nelson's Illustrated Bible Dictionary, Copyright (c)1986, Thomas Nelson Publishers)

¹⁹ 2 Sam 5:1-2 All the tribes of Israel came to David at Hebron and said, "We are your own flesh and blood. ... And the LORD said to you, 'You will shepherd my people Israel, and you will become their ruler.'"

David's blessing is the key element in my belief that the count of 'year of sin' was then stopped. In those days the people were not collectively blessed on a regular basis and the last time they had been was on Mount Gerizim (Josh 8:33-34) when Joshua did it (400 years earlier). Therefore, David's blessing was so exceptional that its implication cannot be neglected.

There would have been no point in God allowing David to pass special favours to the 12 tribes if at the same time He intended to keep cumulating the years of their sin.

When was the Ark brought to Jerusalem?

David first 7 years as King were in Hebron:

- 2 Sam. 5:5 In Hebron he reigned over Judah for seven years and six months, and in Jerusalem he reigned over all Israel and Judah for thirty-three years.

So the Ark did not come to Jerusalem before David's 8th year of reign. In fact, we will see a little further in this paper (on page 64) that the Ark was probably brought to Jerusalem 3 years after David came to the city.

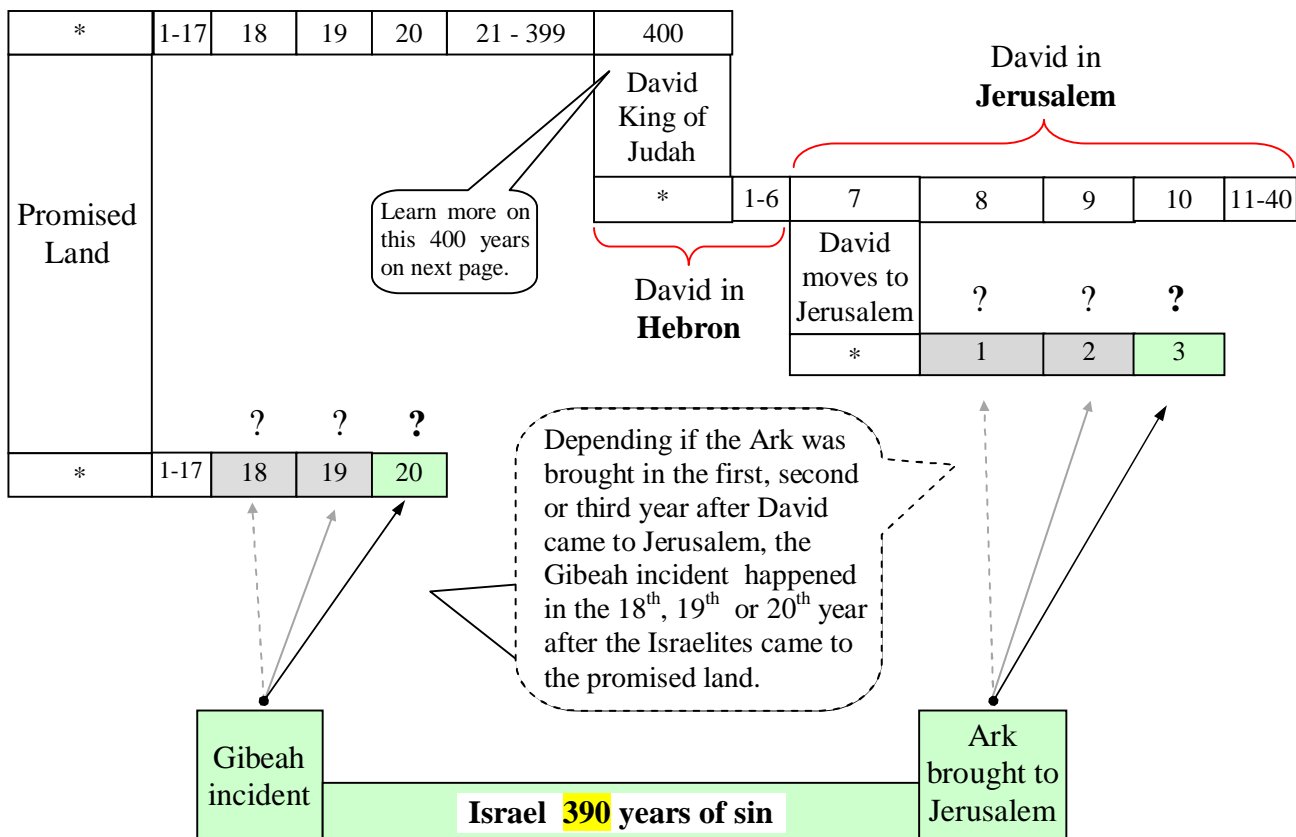

The 390 years of sin associated with the House of Israel is **the time period between the Gibeah incident and the coming of the Ark to Jerusalem.**

²⁰ 2 Sam 6:18 he blessed the people in the name of the LORD Almighty. NIV

David's reign

The following chart shows that David began to reign 400 years after the Israelites came to the Promised Land. For more explanation, read my paper "The 44 Hebrew monarchs (A Chronology of two kingdoms)"

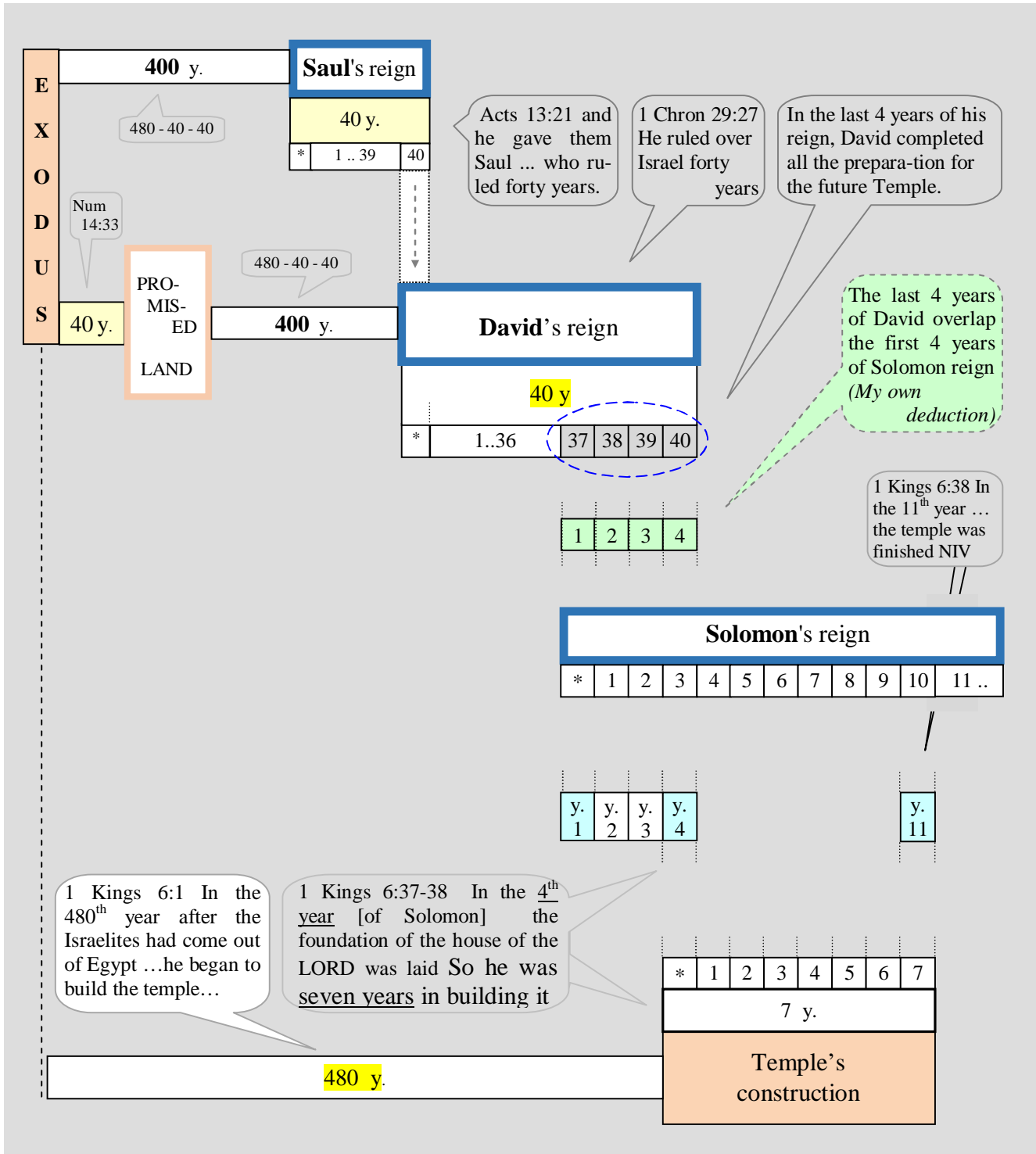

Ezekiel's 430-year SIEGE of Jerusalem

Ezekiel was asked to symbolize a siege that would end with the destruction of Jerusalem.

- Ezek 4:1-3 ... and portray on it a city, Jerusalem. **Lay siege against it**, **build a siege wall** against it, and heap up a mound against it; set camps against it also, and place battering rams against it all around. Moreover take for yourself an iron plate, and set it as an iron wall between you and the city. Set your face against it, and **it shall be besieged**, and you shall **lay siege** against it. NKJV
- Ezek 5:14 Moreover **I will make you a waste** and a reproach among the nations that are all around you, in the sight of all who pass by. NKJV

To do it, he had to lie on his side in front of an image of the city for 430 days, a number obtained by combining the 390 days assigned to the House of Israel with the 40 days assigned to the House of Judah:

- Ezek 4:5-7 ... So for **390** days you will bear the sin of the house of Israel. "After you have finished this, I have assigned you **40** days, a day for each year.

A major point has to be understood about the duration of Ezekiel's siege. No matter that the 430 days are a composite of the 390 days and 40 days, it would be erroneous to deduce that Ezekiel performed two different sieges (one 390-day siege against Israel and one 40-day siege against Judah.). Ezekiel's siege had nothing to do with the side on which he was lying on. During the **whole 430 days** of his act Ezekiel had been continually facing the image of Jerusalem; therefore he was portraying a single and uninterrupted siege of the city.

Using the rule that a day stands for a year²¹ **Ezekiel portrayed a siege that lasted 430 years**. As we know, it was Nebuchadnezzar, King of Babylon, who achieved the destruction of Jerusalem. He came to Jerusalem in the 9th year of the reign of Zedekiah (King of Judah), he laid a siege in front of the city and, in the 11th year of the reign of the King of Judah, succeeded in piercing the wall. Jerusalem was then burned down and the Temple destroyed. **Nebuchadnezzar's siege lasted less than 2 years:**

- 2 Kings 25:1-4 So in the ninth year of Zedekiah's reign, on the tenth day of the tenth month, Nebuchadnezzar king of Babylon marched against Jerusalem with his whole army. He encamped outside the city and built siege works all around it. The city was kept under siege until the eleventh year of King Zedekiah.Then the city wall was broken through

Why did the symbolic siege that Ezekiel was portraying had a duration of 430 years (day = year) when it is so obvious that Nebuchadnezzar's siege only lasted 2 years? There could be only one possible explanation. Even though those two sieges ended with the destruction of Jerusalem,

Ezekiel's siege was not depicting Nebuchadnezzar's siege at all.

Was Jerusalem under siege for 430 years? Yes it was.

²¹ As explained in Ezek. 4:5 I have assigned the same number of days as the years of their sin.

Who was holding the siege and when?

By lying on his side during 430 days, in front of an image of Jerusalem, Ezekiel was symbolizing 'somebody else's siege'.

Now, if we understand correctly the role of a prophet (Ezekiel in this particular case) we can say that he is a substitute for the word of God and we could venture to say that he is also a substitute for God himself:

- Ezek 7:1-2 The word of the LORD came to me:
- Amos 3:8 the Sovereign LORD has spoken- who can but prophesy?
- Jer 20:9 his word is in my heart like a fire, a fire shut up in my bones. I am weary of holding it in; indeed, I cannot.

Ezekiel's symbolic action is a sign that mirrors a real action:

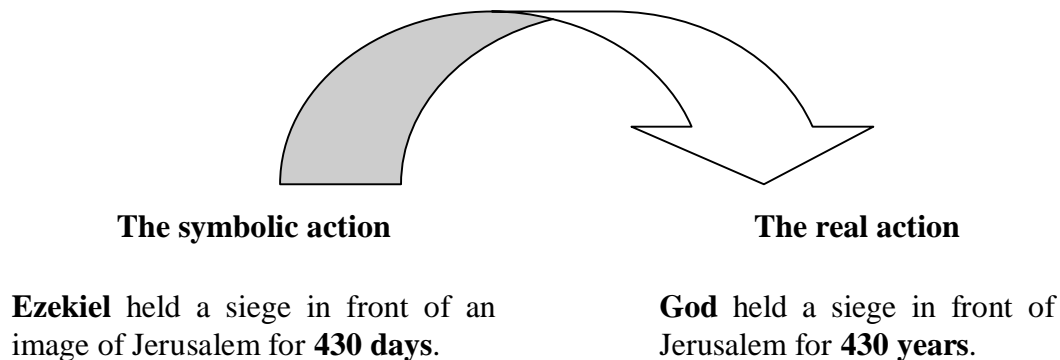

Did God keep Jerusalem under siege²² for 430 years?

A siege is established when a foreign army comes to a fortified city, builds a camp and, no matter how long it takes, pressures this city until its people capitulate. This is the military concept of a siege.

But let's suppose that Ezekiel was not portraying the human military siege that everybody has assumed, but instead a divine siege. Do we have the three basic elements: army, camp, city?

What is the mighty army? **The ark of covenant**, of course:

- Josh 3:4 But keep a distance of about a thousand yards between you and the ark; do not go near it."

²² If this siege lasted 430 years and ended with Jerusalem's destruction, it must have started during Solomon's reign.

- 1 Sam 4:6-7 when they learned that the ark of the LORD had come into the camp, the Philistines were afraid.
- 1 Sam 5:3 When the people of Ashdod rose early the next day, there was Dagon, fallen on his face on the ground before the ark of the LORD!
- 1 Sam 5:10 the people of Ekron cried out, "They have brought the ark of the god of Israel around to us to kill us and our people."
- 1 Sam 6:19 But God struck down some of the men of Beth Shemesh, putting seventy of them to death because they had looked into the ark of the LORD

Did it come to a new location? **It was brought to the Temple:**

- 1 Kings 8:3-4 When all the elders of Israel had arrived, the priests took up the ark, and they brought up the ark [*in the temple*]

Do we have a fortified camp? Yes, the **Holy of Holies inside the Temple:**

- Ezek 24:21 I am about to desecrate my sanctuary-**the stronghold** in which you take pride,
- 1 Kings 6:19-20 He prepared the inner sanctuary within the temple to set the ark of the covenant of the LORD there.
- 2 Sam 6:2-3 the ark of God, which is called by the Name, the name of the LORD Almighty, who is enthroned between the cherubim that are on the ark.
- Ezek 43:6-7 I heard someone speaking to me from inside the temple. He said: "Son of man, this is the place of my throne and the place for the soles of my feet.
- Ezek 9:3 Now the glory of the God of Israel went up from above the cherubim, where it had been, and moved to the threshold of the temple.
- 1 Kings 8:11 for the glory of the LORD filled his temple.
- 1 Kings 8:12-13 "The LORD has said that he would dwell in a dark cloud; I have indeed built a magnificent temple for you, a place for you to dwell forever."

The ark of the covenant, sitting in the inner sanctuary of the Temple was, for the people of Jerusalem, a constant reminder (430 years) of the alliance they had agreed with God.

- Ex 34:10 Then the LORD said: "I am making a covenant with you.

- Jer 25:6 Do not follow other gods to serve and worship them; do not provoke me to anger with what your hands have made
- Jer 44:4-6 Again and again I sent my servants the prophets, who said, 'Do not do this detestable thing that I hate!' But they did not listen or pay attention; they did not turn from their wickedness or stop burning incense to other gods. Therefore, my fierce anger was poured out; it raged against the towns of Judah and the streets of Jerusalem and made them the desolate ruins they are today.
- Jer 44:10 To this day they have not humbled themselves or shown reverence, nor have they followed my law and the decrees I set before you and your fathers.

The whole Temple was filled with the power of God:

- 1 Kings 8:10-11 When the priests withdrew from the Holy Place, the cloud filled the temple of the LORD. And the priests could not perform their service because of the cloud, for the glory of the LORD filled his temple.
- Ezek 24:21 I am about to desecrate my sanctuary-**the stronghold** in which you take pride,

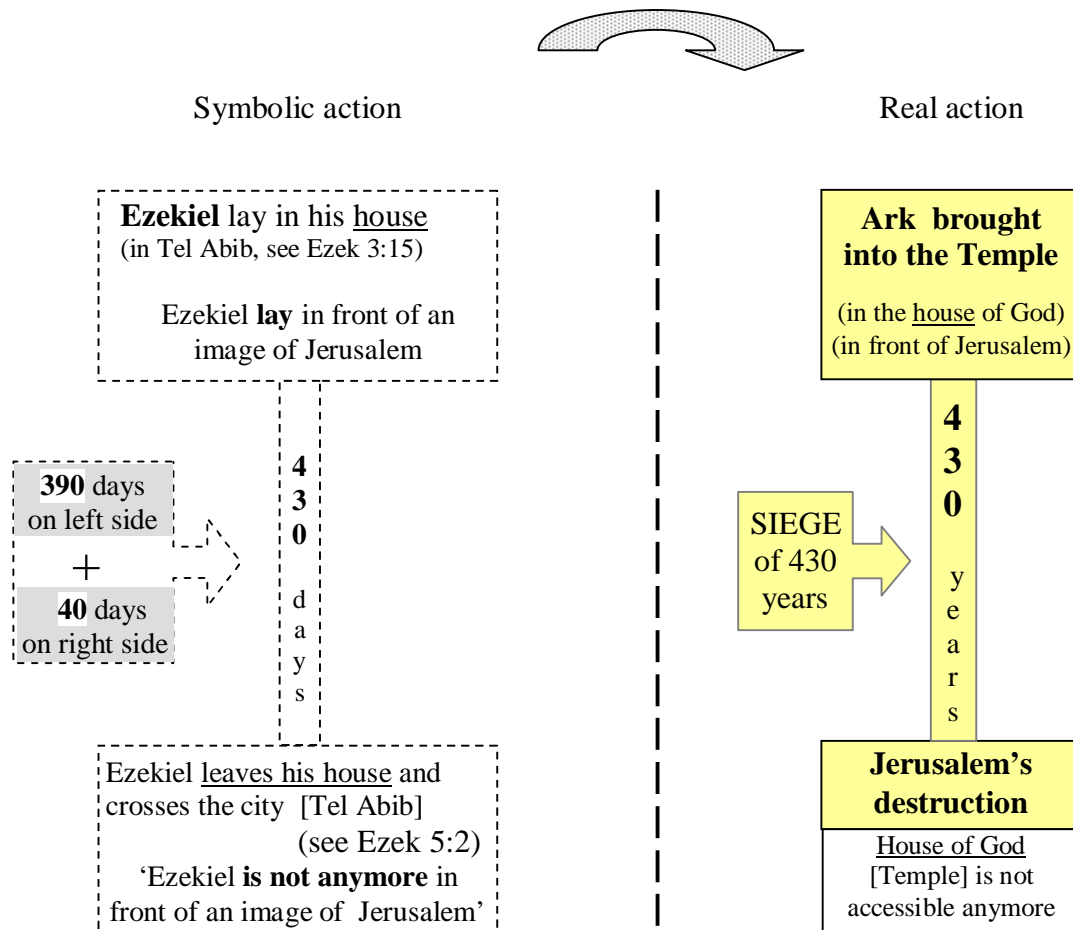

Figure 3. God's 430 years SIEGE

The Temple

The Temple built by Solomon was the third stage of a design conceived by God. Five of those stages are known, the first one was used in the book of Genesis and the last one belongs in the book of Revelation.

- | | | |
|---|--|---|
| #1. The Garden of Eden's layout (Genesis) | | It is outside the scope of this paper to discuss how each structure mirrors a unique pattern but under a different form. Suffice it to say that from the first structure to the last, elements had been evolving from their physical representation toward a spiritual counterpart in heaven. |
| #2. The Tabernacle of Moses (Exodus) | | |
| #3. Solomon's Temple (King) | | |
| #4. Ezekiel's Temple (Ezekiel) | | |
| #5. The heavenly Throne of God (Revelation) | | |

It is important for the comprehension of 'Ezekiel 4-5' to realize that because each structure shares the same design, we can borrow information supplied in one stage and apply it to the next stage (and vice versa).

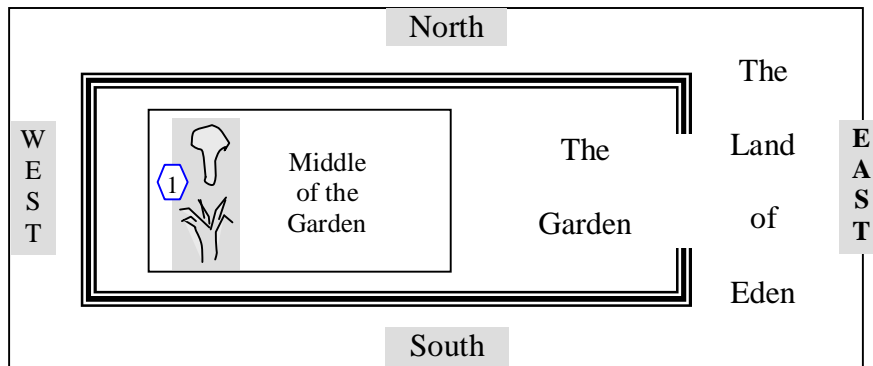

Same layout

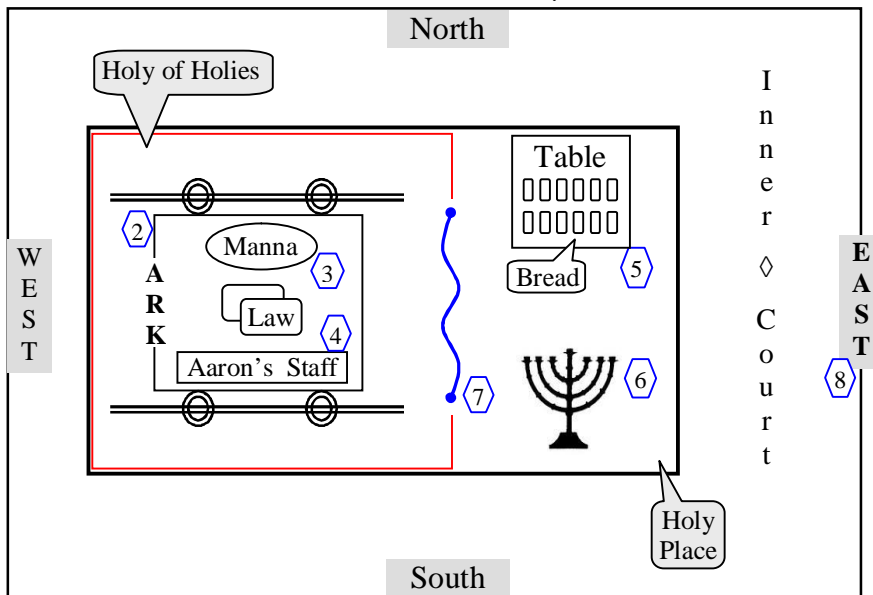

The Garden of Eden was in the Land of Eden. In the middle of the garden was a very special place where two unique trees were found. One was called the Tree of Life and the other the Tree of Good and Evil

In the tabernacle of Moses, in the inner room called the Holy of Holies, was the Ark, that contained the Pot of Manna and Aaron's staff.

In the 2nd structure the pot of manna and Aaron's staff typify the tree of life and the tree of good and evil of the first structure. We know that Aaron's staff is related to almonds (Num 17:8-9) so it is probably the case for one of the two trees found in the middle of the garden.

① Gen. 2:9 In the middle of the garden were the tree of life and the tree of the knowledge of good and evil.

② In the Temple the Ark contained only the Law:

- 1 Kings 8:9 9 There was nothing in the ark except the two stone tablets that Moses had placed in it at Horeb, where the LORD made a covenant with the Israelites after they came out of Egypt.

But at Sinai there was also some manna and Aaron's staff:

- Heb. 9:4 This ark contained the gold jar of manna, Aaron's staff that had budded, and the stone tablets of the covenant.

A representation of the manna and Aaron's staff will be kept in the following schemas for their symbolic value.

③ Ex 16:34 Aaron put the manna in front of the Testimony,

Ex 16:33 So Moses said to Aaron, "Take a jar and put an omer of manna in it. Then place it before the LORD to be kept for the generations to come."

NOTE 1 : That was in Moses' Tabernacle

NOTE 2 : The Manna is situated on the north side since this is the side where the bread will be. See item 4.

④ Num. 17:8 Aaron's staff, which represented the house of Levi, had not only sprouted but had budded, blossomed and produced almonds.

NOTE 1 : That was in Moses' Tabernacle.

NOTE 2 : Aaron's staff is situated on the south side since this is the side where the lamp will be. See item 5.

⑤ Ex. 26:35 Place the table outside the curtain on the north side

Ex. 40:23 and set out the bread on it before the LORD

Lev. 24:6 Set them in two rows, six in each row,

⑥ Ex. 26:35 put the lampstand opposite it on the south side.

Ex. 25:32-33 Six branches are to extend from the sides of the lampstand-
-three on one side and three on the other. Three cups shaped like almond flowers with buds and blossoms are to be on one branch, three on the next branch, and the same for all six branches extending from the lampstand.

⑦ 2 Chron. 3:14 He made the curtain of blue, purple and crimson yarn and fine linen, with cherubim worked into it.

⑧ Two of the structures were facing 'EAST' and it must be the case for the others.

Garden of Eden: Gen. 2:8 Now the LORD God had planted a garden in the east, in Eden;

Ezekiel Temple : Ezek. 8:16 With their backs toward the temple of the LORD and their faces toward the east, they were bowing down to the sun in the east

Now, instead of visualizing Ezekiel in his home, we will depict him in the Temple²³ of Solomon..

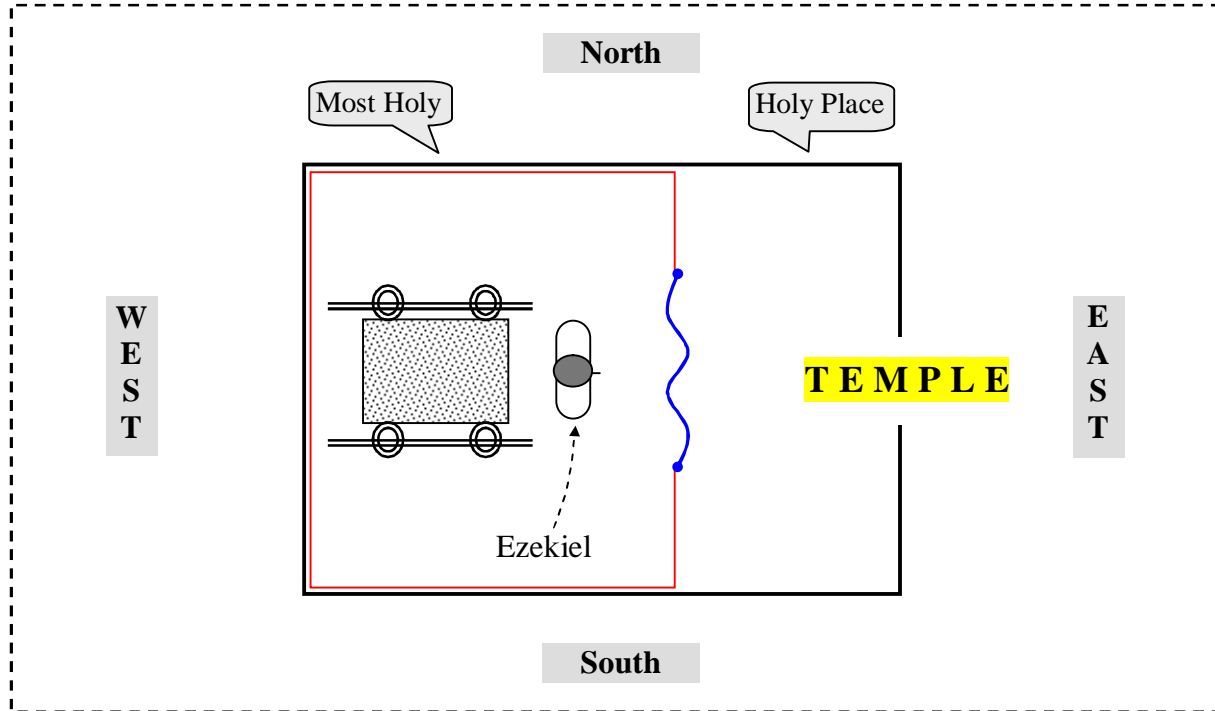

Figure 4. Temple of Solomon²⁴

It is indisputable that Ezekiel was physically in his home when he lay on his side for 430 days, but he then was portraying the siege that was going on in the Temple of Solomon. With that in mind it is natural to symbolically represent Ezekiel in the Temple²⁵, the intended location of his action.

To help us analyze this siege we need a small artifice. We are going to borrow some of the features of Moses' Tabernacle and transpose them into Solomon's Temple; they will occupy the same position. Can we do that? Yes. Remember that Ezekiel's action is highly symbolic; it is a sign²⁶. Surely we are allowed some digression as long as it helps us understand the message we are being told.

The Tabernacle of Moses and the Temple of Solomon are two different structures sharing an identical design that was conceived by God.²⁷ Every piece of furniture found in them have a counterpart in the Heavenly Throne of God and occupy a very specific location in the design. To transpose them from one structure to the other²⁸ is not going to alter their symbolic value.

²³ Ezekiel was a priest. Ezek. 1:3 the word of the LORD came to Ezekiel the priest

²⁴ Of all the furniture found in Solomon's Temple only the Ark is shown here.

²⁵ Some years later Ezekiel was shown the future Temple. Ref : Ezek. 43:5 Then the Spirit lifted me up and brought me into the inner court, and the glory of the LORD filled the temple.

²⁶ Ezek. 4:3 This will be a sign to the house of Israel.

²⁷ Ezek. 43:11 make known to them the design of the temple-its arrangement, its exits and entrances-its whole design and all its regulations ... so that they may be faithful to its design

Before we continue with Ezekiel we need to alter our representation of the Temple of Solomon a little more and get closer to what it really looked like. The following representation is the subject of an entire paper, 'Secrets of the Holy Ark' by Tony Badillo²⁹.

According to Mr Badillo the plan of the whole floor of the Temple depicted a human body whose face was located in the Holy of Holies.

From Tony Badillo's paper we learn that:

- The two cherubims standing behind the Ark, represented the eyes of the face
- The Ark with its poles on each side was the nose and its two nostrils
- There were two protuberances³⁰ indented in the veil by the two poles
- There was a stair separating the Holy of Holies from the Holy Place
- This stair portrays the mouth of the Temple face
- The Golden Altar was at the bottom of the stair

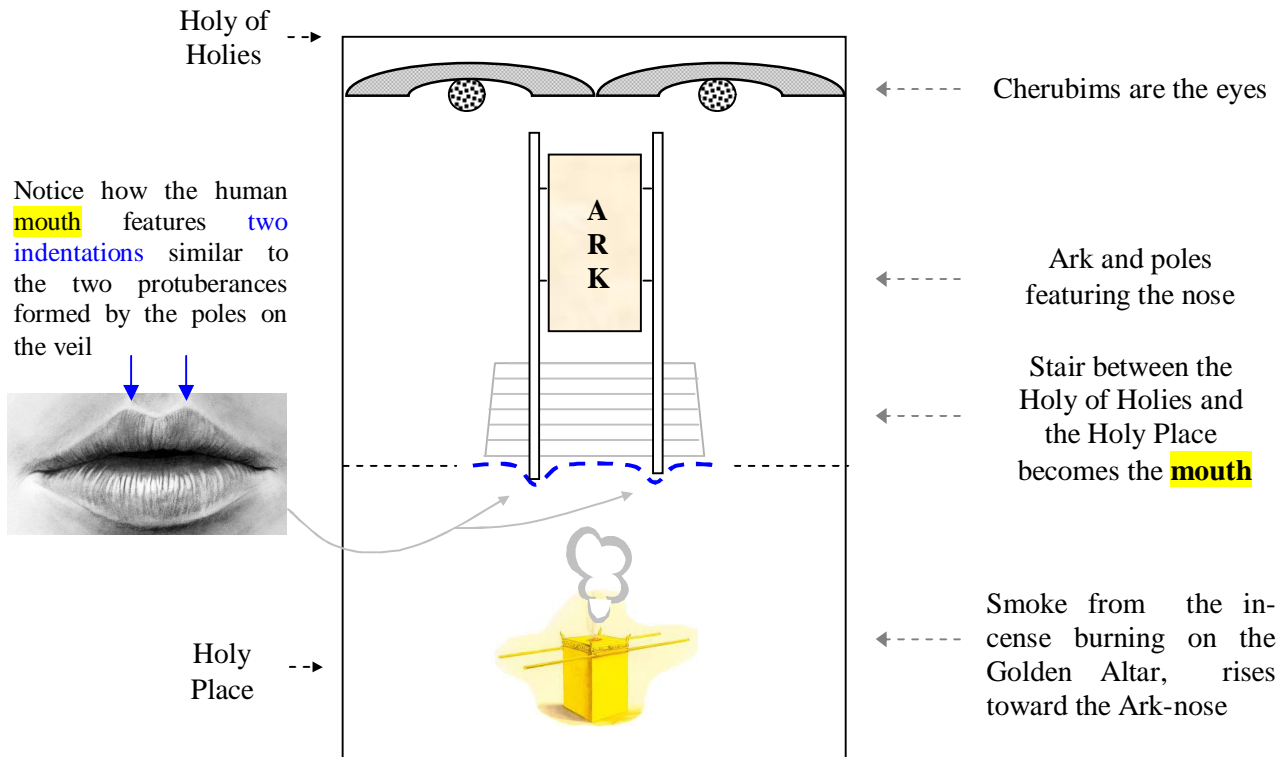
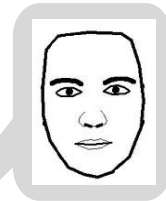

Figure 5 Temple Face

²⁸ The two structures are also directly linked to the 12 tribes of Israel. The Tabernacle of Moses was created at the start of the Exodus; it was eventually replaced by Solomon's Temple which lasted until all the 12 tribes had finally been sent into captivity.

²⁹ Use a search engine like Google.com to do a search with the following keywords:

Ark of the Covenant Secrets badillo

³⁰ 1 Kings 8:8 These poles were so long that their ends could be seen from the Holy Place in front of the inner sanctuary, but not from outside the Holy Place;

WALL OF IRON

There is an aspect of Ezekiel's re-enactment (Ezek. 4) that has been quite puzzling and came as a complete surprise when I finally understood it. We first read that Ezekiel was told to draw 'carve' on a clay tile the city of Jerusalem (and its wall) and have all the military equipment needed for a siege leaned up against it:

- Ezek 4:1-3 "Now, son of man, take a clay tablet, put it in front of you and draw the city of Jerusalem on it. Then lay siege to it: Erect siege works against it, build a ramp up to it, set up camps against it and put battering rams around it.

And then we read this very unexpected statement:

- Ezek 4:3 Then **take an iron pan**, place it as an iron wall between you and the city and turn your face toward it.

If the tile with the carving of Jerusalem, the wall and the military apparatus, form a whole,

why was there a need to further add another wall (the iron pan) between Ezekiel and that tile?

Ezekiel

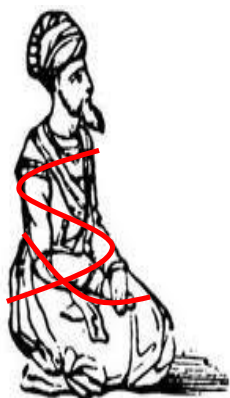

Iron pan



Tile



Ezekiel sketched the city of Jerusalem, the wall and the military arsenal on a fresh and newly made clay brick

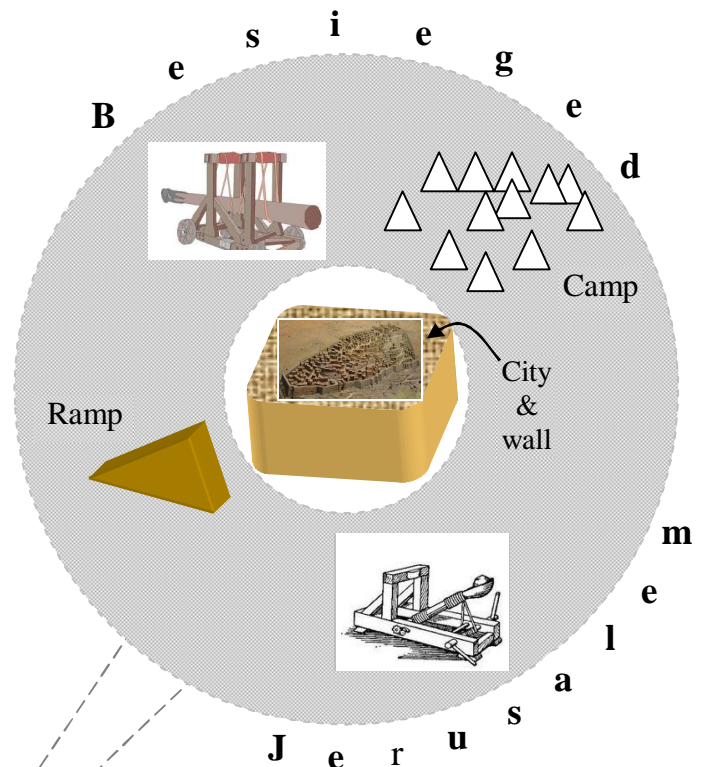

No matter how you look at it, **if** the iron wall (iron pan) was meant to be part of the military siege, it is wrongly located. But suppose the real purpose of the iron wall ('qiy'r') was to bring to mind a separation between two rooms (the Hebrew word 'qiy'r' refers to the internal or external wall of a house and has nothing to do with the wall of a city (chowmat))

Let's remember that although Ezekiel was physically lying in his home it was meant to represent him symbolically **lying in the Jerusalem Temple**. Doesn't this fact directly point to the real purpose of the 'iron pan'?

It is not an overstatement to say that the Temple's Holy of Holies was the most inaccessible location of Israel. The high priest was the only one to enter it and for a single day each year. However, the only thing that separated the most holy from the holy room was a **veil**. *Parochet*

- Ex 26:33 Hang the curtain from the clasps and place the ark of the Testimony behind the curtain. **The curtain will separate the Holy Place from the Most Holy Place**
- 2 Chron 3:14 He made the curtain of blue, purple and crimson yarn and fine linen, with cherubim worked into it.

That veil was as efficient as an IRON WALL.

Isn't it ironic that Ezekiel was told to use an 'IRON PAN' to represent the Temple's veil? Iron was among the hardest material to be found at the time of Ezekiel while the curtain offered hardly any resistance.

And there is more. Notice that Ezekiel was asked to turn³¹ his **face toward the iron pan** in front of him. By doing this he was portraying the **Temple's face**, in front of the **veil**, as depicted³² by the furniture in the Holy of Holies.

Notice also that during his siege Ezekiel was **tied up** in front of the **iron pan** (representing the veil). Isn't it quite appropriate that the **veil** separating the Holy of Holies from the Holy Place was crisscrossed with **gold chains**?

- 1 Kings 6:21 Solomon covered the inside of the temple with pure gold, and he extended gold chains across the front of the inner sanctuary, which was overlaid with gold.

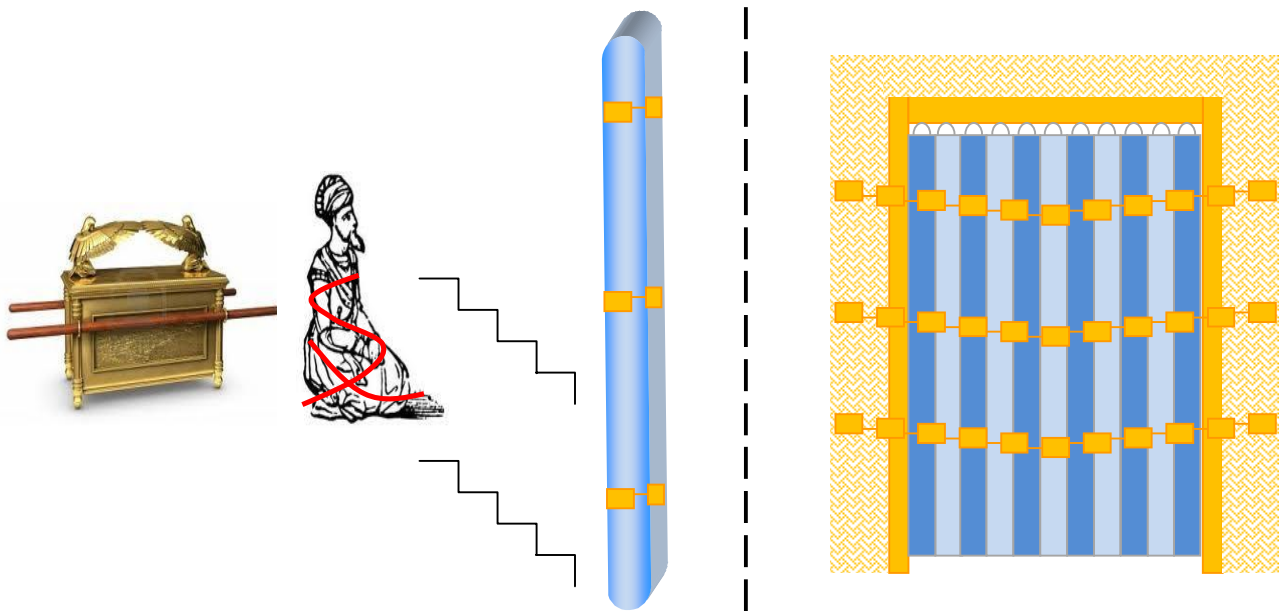

³¹ Ezek 4:3 Then take an iron pan, place it as an iron wall between you and the city and turn your face toward it.

³² See page 33 about the Temple's floor plan and Tony Badillo.

Ezekiel went through a cleansing ritual

Even though there is no direct reference to support it, we do have here a strong indication that Ezekiel's action **was really intended to show what was going on in the Temple.**

No commentator seems to have noticed it but Ezekiel, just before lying on his side for 430 days, went through the cleansing ritual that he described in Ezek. 44:26-27. This ritual was prescribed to the priests **before they entered the Temple.**

Ezek. 44:26-27 After he is cleansed, ¹
they shall count seven days ²
for him. And on the day that he goes to the sanctuary ³
to minister in the sanctuary,
he must offer his sin offering ⁴
in the inner court," says the Lord GOD ⁵

God's house

Now see how Ezekiel fulfilled each point:

1 Ezek. 2:1-3 Then **the Spirit entered me** when He spoke to me, and set me on my feet; and I heard Him who spoke to me. And He said to me: "Son of man, I am sending you to the children of Israel,

Ezek. 3:3 "Son of man, eat this scroll I am giving you and fill your stomach with it." So I ate it, and **it tasted as sweet as honey** in my mouth.

2 Ezek. 3:15 Then I came to the captives at Tel Abib, who dwelt by the River Chebar; and I sat where they sat, and remained there **astonished among them seven days.**

Ezek. 3:24 Then the Spirit came into me and raised me to my feet. He spoke to me and said: "**Go, shut yourself inside your house.**

3 Note: Just before that, Ezekiel had been in the presence of the Glory
Ezek 3:23 And the glory of the LORD was standing there... and **I fell face down**

4 Ezek. 4:10 Weigh out twenty shekels of food to eat each day and eat it at set times.

Ezek. 4:3 Then take an iron pan, place it as an iron wall between you and the city.

5 *The iron pan represents the veil and given that the pan was between Ezekiel and the city, Ezekiel's action put him symbolically in the Holy of Hollies.*

Ezekiel in his symbolic location with all the Temple's features in place

TEMPLE

composite

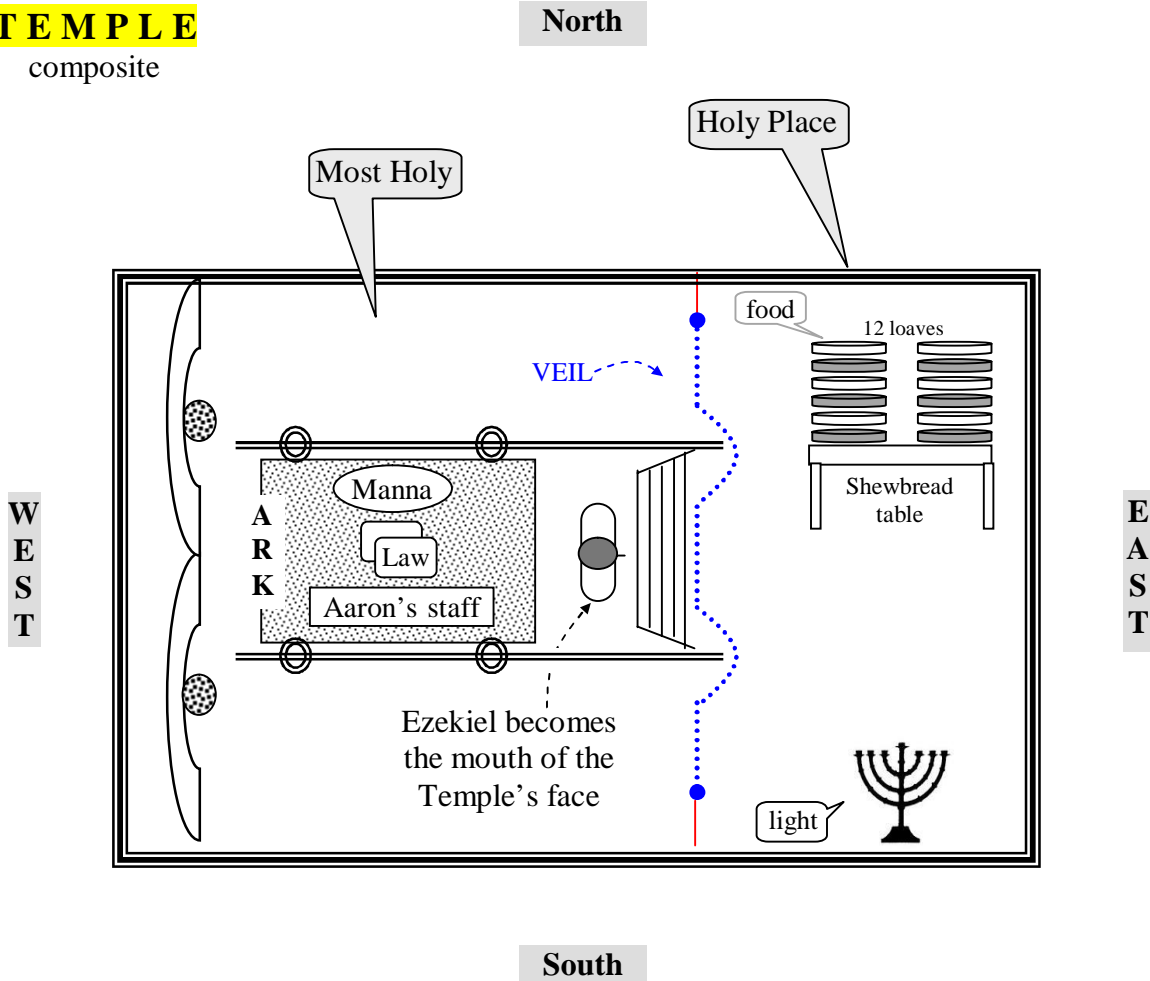

Notice that Ezekiel stands in front of the curtain, at the top of the stair, exactly where the **‘Temple’s mouth’** (see Temple Face on page 33) happens to be. This detail is of some importance given the number of times Ezekiel had previously been warned about speaking when it would be time:

Ezek 2:4 I am sending you to them, and you shall say to them ... NKJV

Ezek 2:7 You shall speak My words to them, NKJV

Ezek 3:1 "Son of man, eat what you find; eat this scroll, and go, speak to the house of Israel."

Ezek 3:4 "Son of man, go to the house of Israel and speak with My words to them.

Ezek 3:11 and speak to them and tell them, 'Thus says the Lord GOD,'

Ezek 3:26 I will make your tongue cling to the roof of your mouth ...

It is very meaningful to have Ezekiel (the **“Prophet”** of YHWH) the future Watchman of Israel (Ezek 33:7) becoming the **mouth** of the Temple’s face.

LEFT SIDE / RIGHT SIDE

Two houses

↑

and

↓

Two animals

The house of Israel represented the 12 tribes and, since the 390 years of sin is attributed to the house of Israel (not the kingdom of Israel), the 390 years of sin involved the 12 tribes. The house of Israel was somewhat under the leadership of Joseph's son Ephraim, who was blessed profusely by Jacob:

- Jer 31:9 For I am a Father to Israel, And Ephraim is My firstborn. NKJV

And Ephraim is associated with a calf (a bull, an ox):

- Jer 31:18 "I have surely heard **Ephraim's** moaning: 'You disciplined me like an unruly **calf**,



→ Ephraim

The house of Judah represented the tribes of Benjamin and Judah, since the 40 years of sin is attributed to the house of Judah, the 40 years of sin involve only those two tribes. The tribe of Judah assumed leadership of the house.

Judah is associated with a lion:

- Gen 49:9 You are a **lion's** cub, O **Judah**;



→ Judah

Two animals

↑

and

↓

Two sides

At the beginning of Ezekiel a creature with four faces was seen. This creature gives us the key to understand why the left³³ side was attributed to the house of Israel and the right side to the house of Judah:

- Ezek 1:10 Their faces looked like this: ... and on the right side each had the face of a lion, and on the left the face of an ox;

Grazing animal mouth



Bull

Ephraim
House of Israel

Crowned animal head



Lion

Judah
House of Judah

L
E
F
T

R
I
G
H
T

Notice that the left side is associated with a grazing animal (bull, cow, calf) whose distinctive feature is the activity of its mouth. However, for obvious reasons, the distinctive feature of the lion, associated with the right side, is its head (crowned with a mane, a symbol of majesty).

³³ The ancient usage of such terminology was based upon the proposition that one faced the East (the rising sun); and thus the left stood for the North, the right stood for the South; and the East was always considered "the front." Since Northern Israel (Samaria) lay north of Jerusalem, the "right" and "left" designation applied to the Ten Northern tribes and to Judah, respectively. See Coffman's Commentaries on the Bible

Ezekiel is lying on his left side for 390 days

For the first 390 days of his siege's re-enactment Ezekiel was lying on his left side:

- Ezek 4:5 For I have laid on you the years of their iniquity, according to the number of the days, three hundred and ninety days; so you shall bear the iniquity of the house of Israel. NKJV

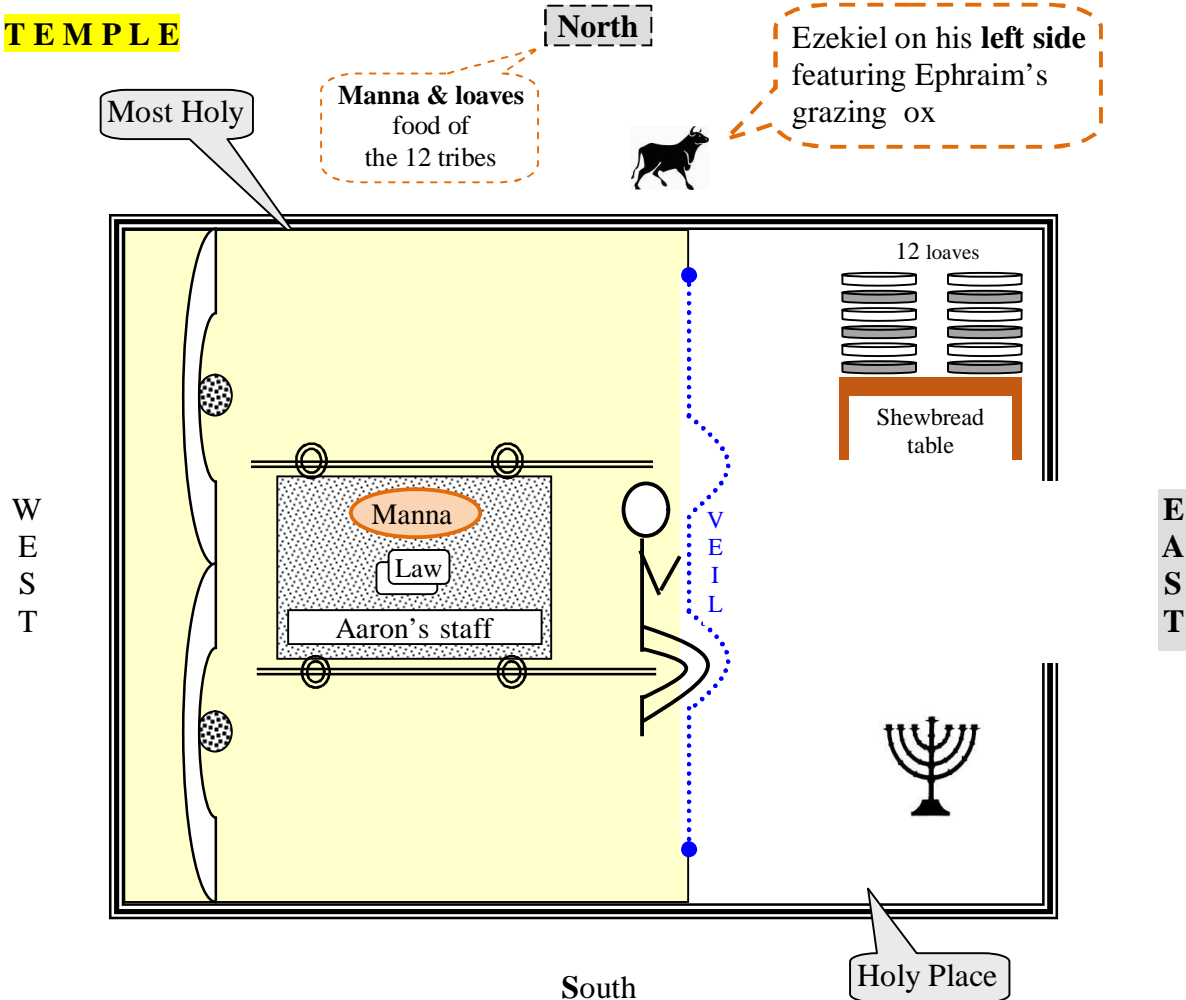

Figure 6. Ezekiel on his left side for 390 days (mouth toward north)

Notice: Ezekiel's mouth³⁴ on the north side with 'the food' of the temple

The first 390 days of Ezekiel's siege are characterized by his access to food:³⁵

- Ezek 4:9-10 Take wheat and barley, beans and lentils, millet and spelt; put them in a storage jar and use them to make bread for yourself. You are to eat it during the 390 days you lie on your side.

The two items³⁶ on the north side (borrowed from the Tabernacle) are related to **food** and characterize the **12 tribes** as abundantly blessed by God..

³⁴ The 'mouth' is the distinctive feature of the grazing ox representing Ephraim.

³⁵ There is no mention of food in the second part of Ezekiel's siege (40 days). This will be discussed later.

³⁶ Manna food of the 12 tribes at Exodus. And the 12 loaves representing the 12 tribes.

Ezekiel is lying on his right side for 40 days

For the second part of his siege, the last 40 days, Ezekiel was lying on his right side:

- Ezek 4:6 "After you have finished this, lie down again, this time on your right side, and bear the sin of the house of Judah.

TEMPLE

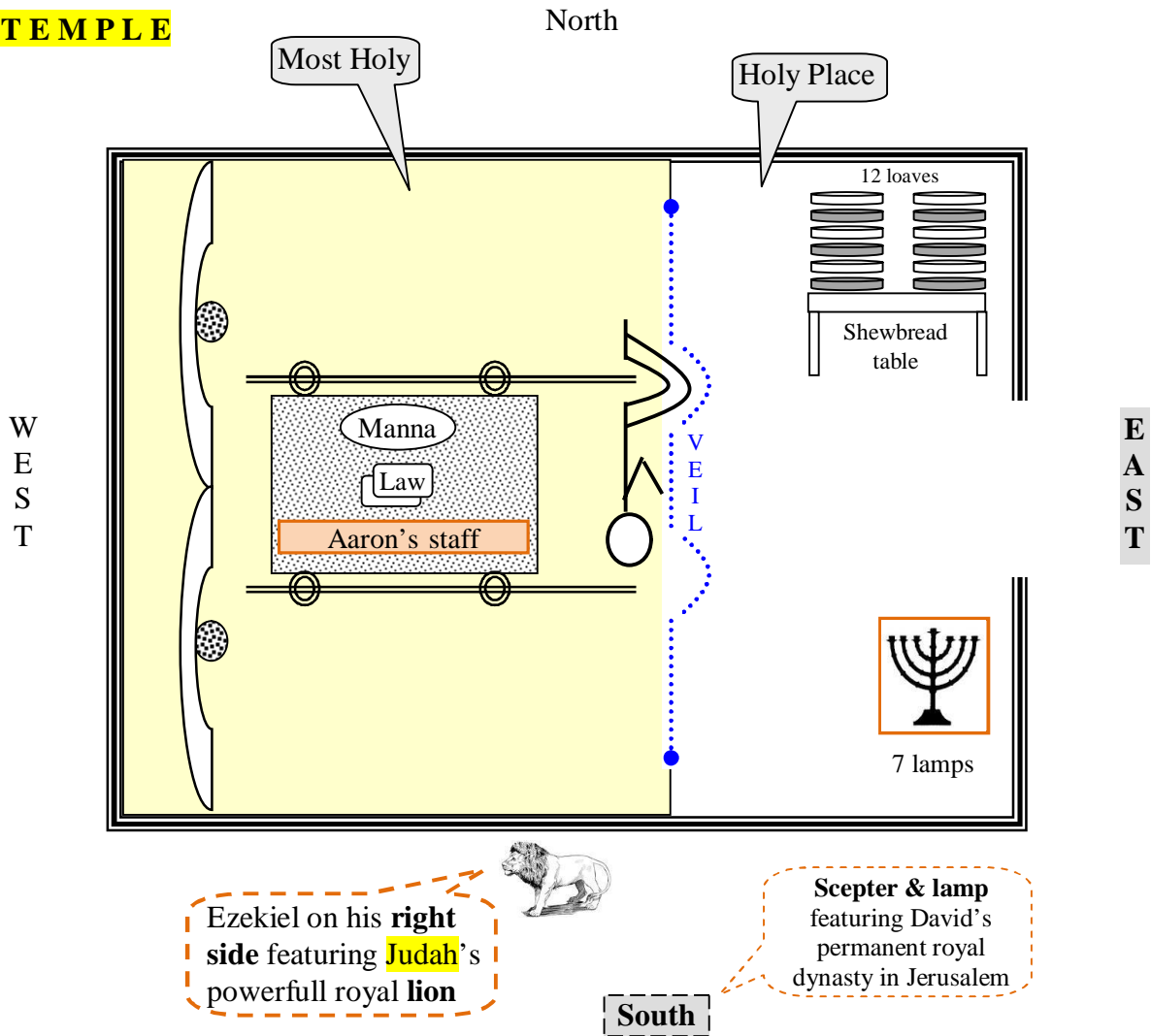

Figure 7. Ezekiel on his right side for 40 days (head toward south)

Ezekiel's head³⁷ on the south side with the Temple's objects symbolizing 'authority'.

Notice: Ezekiel was not fed during the 40 days and as we should expect there is no trace of food on the south side.

³⁷ The 'head', is the distinctive feature of the crowned lion representing Judah.

The two items on the south side (borrowed from the Tabernacle) characterize Judah³⁸ as a guide.

The STAFF

- Ezek 19:11 Its branches were strong, fit for a ruler's scepter.
- Gen 49:10 The scepter will not depart from Judah

Sceptre emblem and sign of power

Lamp = Monarch
2 Sam 1:17



The LAMP

- 1 Kings 11:36-37 I will give one tribe to his son so that David my servant may always have a lamp before me in Jerusalem, the city where I chose to put my Name.
- 2 Kings 8:19 Nevertheless, for the sake of his servant David, the LORD was not willing to destroy Judah. He had promised to maintain a lamp for David and his descendants forever.

Judah had to keep the scepter and by association, the law.

The start of the 40 years of sin is directly connected with the abandoning of the law:

- 2 Kings 21:8-9 if only they will be careful to do everything I commanded them and will keep the whole Law that my servant Moses gave them." But the people did not listen. Manasseh led them astray,

The end of the 40 years of sin came with the rediscovery of the book of the law:

- 2 Kings 22:3,11 In the eighteenth year of his reign, King Josiah ... When the king heard the words of the Book of the Law, he tore his robes.

During the 390-year period of sin the Ark was under the care of the 12 tribes whose leadership was assumed (symbolically) by Ephraim. The **symbol of Ephraim is an ox**.

At the end of the 390 years of sin the Ark was removed from the house of Abinadab³⁹ and David attempted to bring it to Jerusalem by putting it on a cart that was drawn by **oxen**. It was a failure and the Ark was left at the house of Obed-Edom.

Three months later the Ark was successfully brought to Zion. This time the Ark was carried on the Levites' shoulders while they were following King David, a man crowned like a **lion**⁴⁰ (**Judah's symbol**).

The Ark coming to Jerusalem marks the end of Israel 390-year of sin

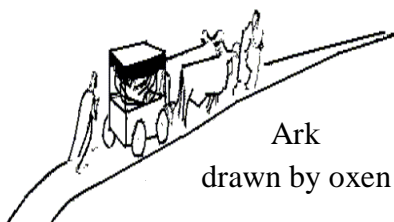

Ark drawn by oxen

3 months later



Ark on Levites shoulders following David, the Lion-king of Judah

³⁸ According to Jacob's blessings (Gen 49:10) Judah is forever a ruler.

³⁹ See 2 Sam 6:3

⁴⁰ The Ark went from the Ox to the Lion, another way to show that it was leaving Ephraim to come to dwell in Judah.

We have already seen many small details to back up our deduction that Ezekiel's performance was meant to be set in the Temple (although it was physically held in his home). Here is a final piece of evidence to strengthen this conclusion.

Prior to going to his house for 430 days, Ezekiel was engulfed in a celestial vision of the Lord's throne (or celestial Temple). At one point in this vision, while he was (**A**) in the Lord's dwelling place, Ezekiel heard from (**B**) behind him the noise of flapping (**D**) wings belonging to (**C**) four living creatures:

- Ezek 1:5 Also from within it came the likeness of **four** living creatures. NKJV
- Ezek 3:12-13 Then the Spirit lifted me up, and I heard **behind** me a great thunderous voice: "Blessed is the glory of the LORD from **His place!**" **I also heard the noise of the wings** of the **living creatures** that **touchd one another**, NKJV

Now, with the description of Ezekiel's vision in mind, let's see how each element of that vision can also be found in the Temple's composite that became Ezekiel's symbolic surroundings while he was lying in his own house.

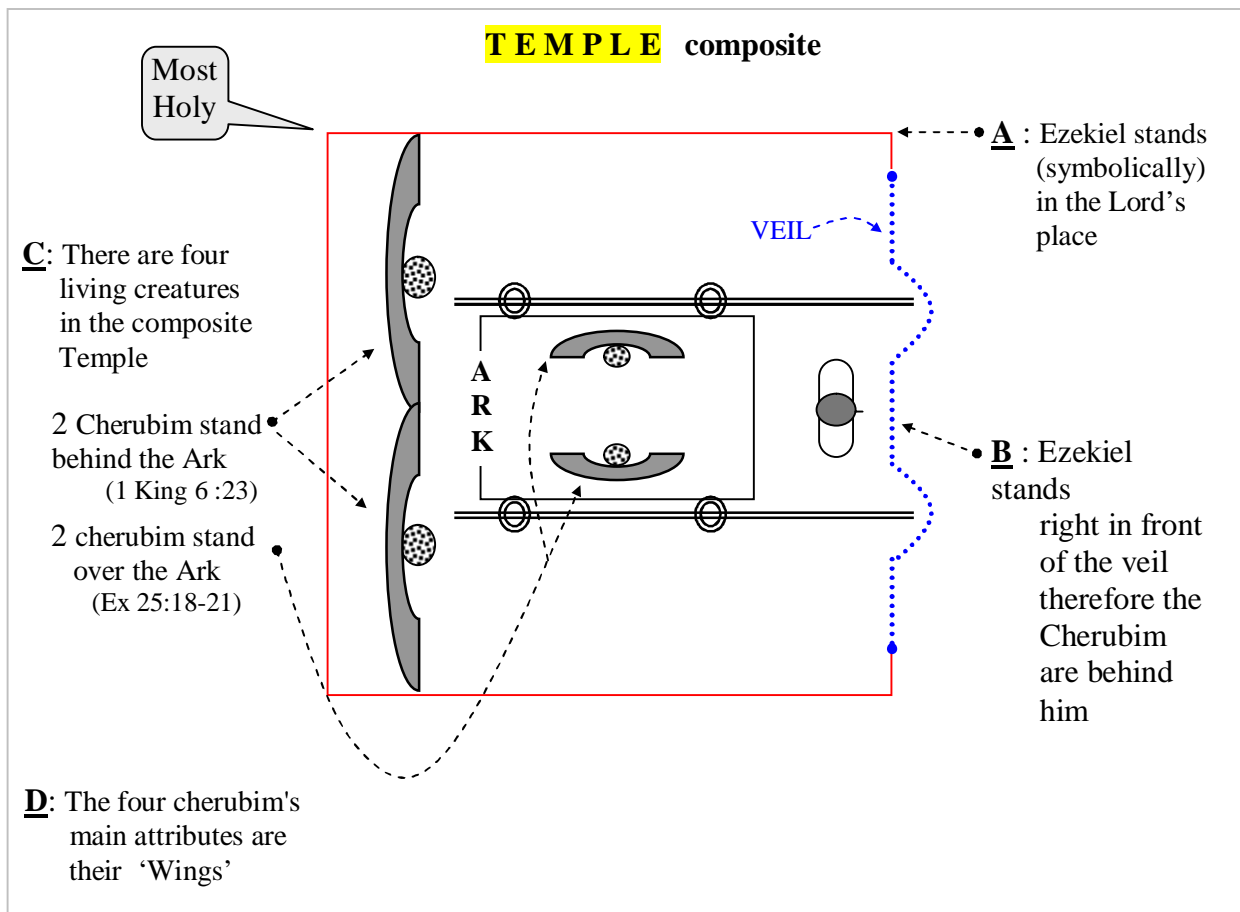

Can there be any doubts left when so many pieces point in the same direction?

Food and no food

A major difference between the two periods enacted by Ezekiel, while laying on his sides, has to do with food. For the first 390 days he was told to eat some food, which was not the case for the following 40 days. It is strange, isn't it? Why was Ezekiel not offered any food during the 40 days he was lying on his right side? No doubt Ezekiel had access to a supply of food; he had filled the jar himself at the beginning of the first period:

- Ezek. 4:9 "Take wheat and barley, beans and lentils, millet and spelt; put them in a storage jar and use them to make bread for yourself.

His access to all the water he wanted is even more obvious. Ezekiel was asked to measure it just before he drank it, but nowhere was he told that he had to stock it:

- Ezek 4:11 Also measure out a sixth of a hin of water and drink it at set times.

It is clear that God instructed Ezekiel to eat in the 390 days⁴¹ of the first period and not in the following 40 days⁴², even though, as I believe, there was food and water available. There is only one word that can give light to the whole situation: FASTING.

40 days of fasting for the sin of Judah

This is a very interesting thought and it becomes quite convincing when we realize that the food on the first 390 days had a **dual purpose**. It was used to feed Ezekiel - he wouldn't have survived without food - but its main purpose was to be used as a SIN OFFERING.

A sin offering offered 390 times for the sin of Israel

According to Lev 5:11-13 a sin offering couldn't have any oil and it was given to a priest. Ezekiel, a priest, didn't put any oil in his food. Notice also that Ezekiel had to eat at 'set time', as if he was following a ritual.

- Ezek 4:9 "Take wheat and barley, beans and lentils, millet and spelt; put them in a storage jar and **use them to make bread** for yourself.
- Ezek 4:10-11 And your food which you eat shall be by weight, twenty shekels a day; **from time to time** you shall eat it.

Ezekiel's food (sin offering) was corrupted when it was cooked over dung (Ezek 4:12-13). Unsurprisingly the 390 years period associated with it was also characterized by corruption:

- Hos 9:9 They have sunk deep into corruption, as in the days of Gibeah.

There is much more to say about the 390 days of food and the 40 days without any. We will see later that these two periods were also among Ezekiel major symbolical acts.

Ref: Ezekiel ate defiled food for 390 days on page 66
Ezekiel fasts during 40 days on page 132

⁴¹ Have you notice that while on his left side, the side associated with the grazing animal, Ezekiel cooked his food (Eze 4:15) over a fire fueled with cow manure?

⁴² Another interesting fact: the left side is associated with grazing animals who feed and drink most of the time. Ezekiel on his left side had access to food and water every day. It was not the case when he turned on his right side and had to fast for 40 days. And what was the animal associated with the right side? A lion, an hunting animal that could go days without food and water.

Why was there a need to tie Ezekiel during the 430 days of his siege?

- Ezek 4:8 I will tie you up with ropes so that you cannot turn from one side to the other until you have finished the days of your siege.

It is obvious in Eze 4:8 that Ezekiel was physically tied⁴³ for the whole 430 days (390 + 40) of his siege. But to be tied for 430 days is an awfully long time and we should seek an hidden meaning behind this very harsh treatment. Why did it have to be done that way? Was God afraid that Ezekiel wouldn't hold his position on each side and therefore needed to be tied? Absolutely not, Ezekiel was a priest whose entire life had been devoted to God.

- Ezek 4:14 Then I said, "Not so, Sovereign LORD! I have never defiled myself. From my youth until now I have never eaten anything found dead or torn by wild animals. No unclean meat has ever entered my mouth."

He didn't weep or lament when he lost his wife because he was told not to do so:

- Ezek 24:18 So I spoke to the people in the morning, and in the evening my wife died. The next morning I did as I had been commanded.

If the ropes were not used to force Ezekiel to obey then we have to conclude that they were used for a symbolical purpose. It is said in Ezek 4:8 that the prophet could not turn on the other side before the right time. Thus Ezekiel was first portraying somebody tied for 390 days and then someone tied for 40 days. A two parts symbolical act that brought freedom at the end. Without surprise the Bible has nothing to say about anybody that could have been tied for 430 years (390 + 40). But then, did we correctly understand what was meant by the rope symbol?

What if the ropes that were put on Ezekiel were not meant to symbolize somebody tied? What if those ropes were no more than an artifact used to symbolize somebody held prisoner? By binding Ezekiel, wasn't it the proper way to symbolically represent somebody confined in a specific location?

- Ezek 3:25 And you, son of man, they will tie with ropes; you will be bound so that you cannot go out among the people.

If we are right about this we should be able to find an important individual who had been in prison for 430 days⁴⁴ and did recover his freedom at the end of a siege. Don't we have the perfect candidate in the person of Jeremiah the prophet?

- Jer 38:6 So they took Jeremiah and put him into the cistern NIV
- Jer 38:28 Now Jeremiah remained in the court of the prison until the day that Jerusalem was taken.

⁴³ The reader is already aware that Ezekiel was **tied** in front of an iron wall which symbolised the veil of the Holy of Holies. That veil was also criss-crossed by **chains**. See discussion on Iron Wall on page 35.

⁴⁴ in this context we discard a 430-year period as it wouldn't make any sense

| | |
|--|---------|
| Ezekiel lying on his left and right sides while being tied up | |
| 430 days | |
| 390 days | 40 days |
| food | no food |

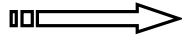

| | |
|-------------------------|--------------------|
| Jeremiah's imprisonment | |
| 430 days ? | |
| 390 days ? | 40 days ? |
| Feed with bread | No food / not feed |

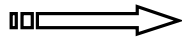

In a cistern
Jer 38:6

In the prison's yard
Jer 38:13,28

Ezek 4:8 I will tie you up with ropes so that you cannot turn from one side to the other until you have finished the days of your siege. NIV

Jer 38:6 They lowered Jeremiah by **ropes** into the cistern

Jer 38:13 So they drew up Jeremiah with cords, and took him up out of the dungeon: and Jeremiah remained in the court of the prison. KJV
Jer 38:28 So Jeremiah abode in the court of the prison until the day that Jerusalem was taken: and he was there when Jerusalem was taken. KJV

Jeremiah's story doesn't specify that he was held prisoner exactly 430 days but a careful reading of the book of Jeremiah and an understanding of the sequence of events surrounding Nebuchadnezzar's siege against Jerusalem, do strengthen this belief. **Furthermore** Jeremiah was held captive in **two different locations**. First in a **cistern** in which he was **feed** (Jer 37:21) every day, then in the **court of the prison** at a time where there was **no more food** in the city (Jer 38:9)

The timeline of Jeremiah's actions

- #1. Nebuchadnezzar attacked Jerusalem in Zedekiah's 9th year, 10th month, 10th day. (This is **about 560 days** before Jerusalem was captured in the 11th year, 4th month, 9th day of Zedekiah): See Jer 52:4 and 2 Kings 25:1
- #2. While Jerusalem and a few other cities were still resisting, Jeremiah told King Zedekiah that he and the city would be captured but the King would die peacefully: (Jer 34:2-7). Zedekiah made a covenant to free all the slaves (Jer 34:8-9). Then **Nebuchadnezzar ended the siege of Jerusalem** (Jer 37:5). The King didn't maintain the covenant and everybody took back their slaves: (Jer 34:11, Jer 34:16). Jeremiah announced that Nebuchadnezzar would be back (Jer 34:21-22, 37:7-8)

IN PRISON - - - - -

- #3. Jeremiah wanted to leave Jerusalem but was arrested and accused of trying to join the then leaving Babylonian army (Jer 37:4, 37:11-12, 37:15-16).
- #4. As prophesied earlier (see #2) the Babylonian army came back.
- #5. King Zedekiah who was worried about what was going to happen to him, had Jeremiah brought to the palace for questioning: See Jer 37:17. Jeremiah was fearing for his life in the dungeon (Jer 37:20-21). While a prisoner Jeremiah bought a field (Jer 32:1-3, 32:6-7)

#6. Turning point No more bread -----

Zedekiah inquires from Jeremiah (Jer 21:1-2) and was told about the imminent destruction of Jerusalem (Jer 21:7, 38:2). Pashur and his men had previously lowered Jeremiah in a dungeon (cistern) to kill him (Jer 38:6). The Cushite Ebed-Melech rescued Jeremiah after telling the King that Jeremiah would die if he was kept in the dungeon since **there was no more bread in the city:**

- Jer 38:9 ... For there is no more bread in the city." NKJV

#7. With the bread gone, the famine started.

- Ezek 4:16-17 Son of man, surely I will cut off the supply of bread in Jerusalem; they shall eat bread by weight and with anxiety, and shall drink water by measure and with dread, that they may lack bread and water, and be dismayed with one another,
- Lam 4:9 Those killed by the sword are better off than those who die of famine; racked with hunger, they waste away for lack of food from the field.
- Lam 2:20 Should women eat their offspring, the children they have cared for?

#8. People dying everywhere. The food was completely gone, the wall was broken and the city was captured:

- Jer 52:6 By the **ninth day of the fourth month** the famine in the city had become so severe that there was no food for the people to eat
- Jer 38:28 Now Jeremiah remained in the court of the prison until the day that Jerusalem was taken. And he was there when Jerusalem was taken.
- Jer 39:2 In the eleventh year of Zedekiah, in the fourth month, on the ninth day of the month, the city was penetrated.

Given that the length of Ezekiel's siege is divided into two periods of time (390 and 40 days), we can speculate that Jeremiah's stay in prison was also divided in a similar way.

| | | | |
|---------------------------------|---|---|--|
| E Z E K I E L | 3 9 0 | <p>During the first 390 days Ezekiel had access to food</p> <ul style="list-style-type: none"> Ezek 4:9 "Take wheat and barley, beans and lentils, millet and spelt; put them in a storage jar and use them to make bread for yourself. You are to eat it during the 390 days you lie on your side | o n h i s s i d e s |
| | Turning point (Ezekiel starts fasting) | | |
| | 4 0 | <p>During the following 40 days Ezekiel was fasting (already discussed in this work)</p> | |

In each case the turning point is related to **food**.

| | | | |
|--------------------------------------|--------------------------------------|---|---|
| J E R E M I A H | ? 3 9 0 ? | <p>In the first part (points #3, #4, #5 of the previous chronology of Jeremiah) there was food in Jerusalem and we are told that Jeremiah received his daily bread:</p> <ul style="list-style-type: none"> Jer 37:21 King Zedekiah then gave orders for Jeremiah to be placed in the courtyard of the guard and given bread from the street of the bakers each day until all the bread in the city was gone. | C I S T E R N t h e n Y A R d |
| | Turning point (No more bread) | | |
| | ? 4 0 ? | <p>In the second part (points #6, #7, #8) the famine progressed in the city.</p> <p>This period started when Jeremiah was put in a dungeon and the King was told that there was no more bread in the city:</p> <ul style="list-style-type: none"> Jer 38:9 and he is likely to die from hunger in the place where he is. For there is no more bread in the city." NKJV <p>At the end of the period (which corresponds to the end of Jeremiah's imprisonment) there is no more food in the city:</p> <ul style="list-style-type: none"> Jer 52:6 By the ninth day of the fourth month the famine in the city had become so severe that there was no food for the people to eat. <p>We know that this period had to be short (40 days?); point #7 describes the terrible conditions that prevailed in the city once the food started to become scarce.</p> | |

As mentioned a few pages back we won't find in Jeremiah's writing any confirmation that his imprisonment lasted exactly 430 days and it was divided into an initial period of 390 days followed by a period of 40 days. **We got those numbers by recognizing in Ezekiel's binding a symbolic reference to Jeremiah's imprisonment.** Nevertheless, not having a direct statement from Jeremiah about those numbers doesn't mean he left us clueless.

We are told that Jeremiah was arrested during the period of Nebuchadnezzar's interrupted siege (see #3 earlier). We are also told that the people abandoned the covenant they had made when they realized that Nebuchadnezzar was not threatening them anymore. This betrayal of the covenant led to the return of Nebuchadnezzar, which in turn led King Zedekiah, in the 10th year of his kingship, to consult Jeremiah.

All those events happened in a short time and given that we are told that King Zedekiah met Jeremiah sometime in the 10th year of his Kingship⁴⁵, we know they all happened between the 480th and the 98th day before the capture of Jerusalem⁴⁶.

Fixing Jeremiah's whole imprisonment to 430 days
is in agreement with 'between 480 and 98 days'.

The famine that prevailed toward the end of Nebuchadnezzar's siege started when the bread became unavailable and ended when the food was gone completely. This progression couldn't have evolved in just a few days; it had to last several weeks. Indeed, Ezekiel implied that the famine would be progressive:

- Ezek 5:16 I will bring more and more famine upon you and cut off your supply of food.

Another important fact about this famine is that one third of the population died from starvation and sickness:

- Ezek 5:12 A third of your people will die of the plague or perish by famine inside you

Before they started dying from starvation the people had been desperately eating any possible scrap of food they found. In the end they even ate their own flesh (see #7). We shouldn't doubt that it must have taken weeks of privation and starvation before they persuaded themselves to do such a terrible thing:

- Ezek 4:17 They will be **appalled at the sight of each other** and will waste away because of their sin.
- Lam 4:9 Those killed by the sword are better off than those who die of famine; racked with hunger, **they waste away for lack of food** from the field.

Fixing Jeremiah's second part of imprisonment to 40 days
is in agreement with the progression of the famine just described.

⁴⁵ Jer 32:1 This is the word that came to Jeremiah from the LORD in the tenth year of Zedekiah king of Judah, which was the eighteenth year of Nebuchadnezzar.

⁴⁶ Not knowing in what part of the 10th year of Zedekiah those events took place we use the earliest (First day of the 10th year) and the latest (last day of the 10th year). Zedekiah was captured in the fourth month of his 11th year.

Prophecy against the siege of Jerusalem

- Ezek 4:7 Therefore thou shalt set thy face toward the siege of Jerusalem, and thine arm shall be uncovered, and thou shalt prophesy against it. KJV

By using the words ‘**against it**’ the translators of Ezek 4:7 may have misled us into believing that Ezekiel was going to prophesy about (against) Nebuchadnezzar’s future siege of Jerusalem. This is doubtful that it was the purpose. What would he have accomplished by prophesying for 430 days about the coming destruction of Jerusalem? Who would have benefited from it? Ezekiel was confined in the privacy of his home where he might have been, as far as we know, alone most of the time.

As an alternative to the words ‘against it’ I suggest using ‘**upon it**’. At once it introduces the possibility that Ezekiel was simply asked to perform an act of prophesying while he was looking toward the sketch he had drawn on a tile (which represented the siege of Jerusalem).

We don’t know what Ezekiel was prophesying about, there is no message recorded. But it doesn’t matter given that

he was not doing it to inform anybody.

What nobody understood until now is the fact that Ezekiel’s prophesying was done as **an independent symbolic act**. In this particular case it was the act of ‘prophesying’ in itself that was used to reveal something hidden rather than the information that was prophesied.

T H E P R O P H E T

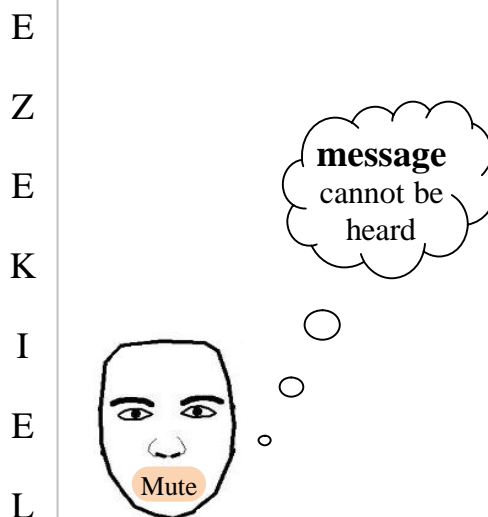

Similar to the other symbolic acts⁴⁷ that Ezekiel had performed during the period of 430 days, this new one was also done according to familiar pattern: during the first 390 days the prophet prophesied while lying on his left side (House of Israel), and during the following 40 days he prophesied while lying on his right side (House of Judah).

As we will see in the following pages, we can point to two different periods (**390 years and 40 years**) of Israel’s history during which prophetic communication was a major characteristic.

⁴⁷ Like lying on his sides, eating food, being tied.

390 years of prophecy for the House of Israel (North side)

In all likelihood the first period portrayed by Ezekiel's prophesying starts with "Moses' escapes from Egypt" and ends with the 'capture of the Ark'.

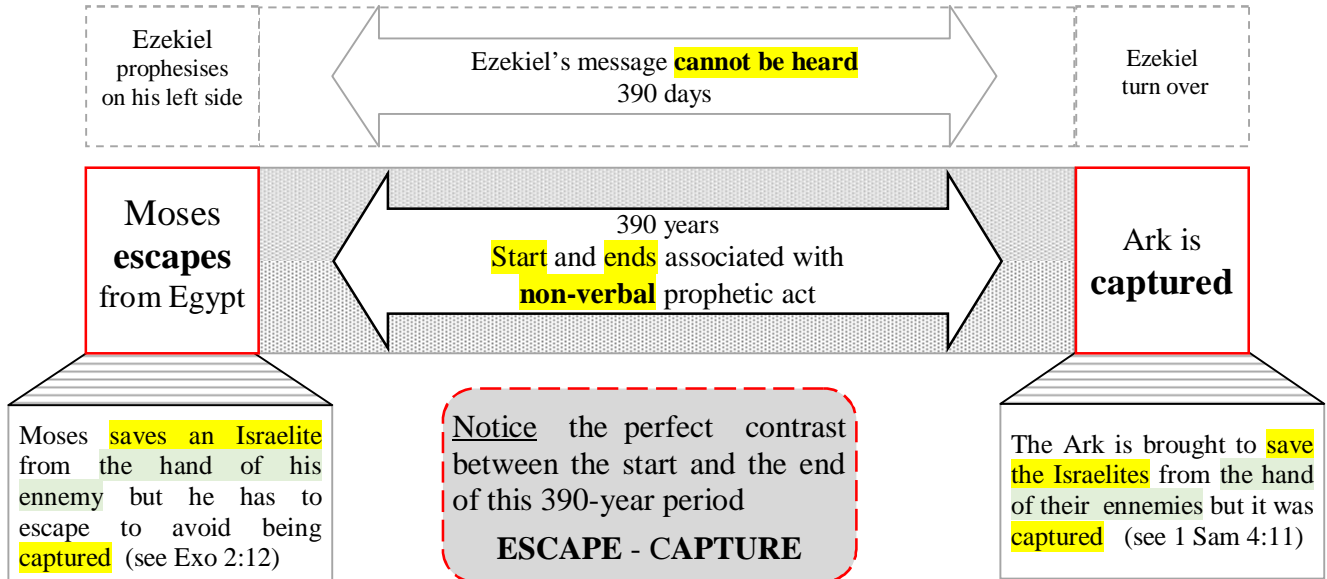

Escape from Egypt

Was Moses' escape a prophetic event and does it qualify for the start of any period? The answer to both questions is yes. In fact, we will see that "Moses' escape from Egypt" not only started '390 years of prophetic events' it also marks the beginning of a series of events that went on for 40 years and whose echo can be heard during the next 40 years of Exodus. An appropriate way to view these first 40 years of what I call the '390 years of prophetic events' would be to see them as the 40 years of Moses' phantom Exodus.

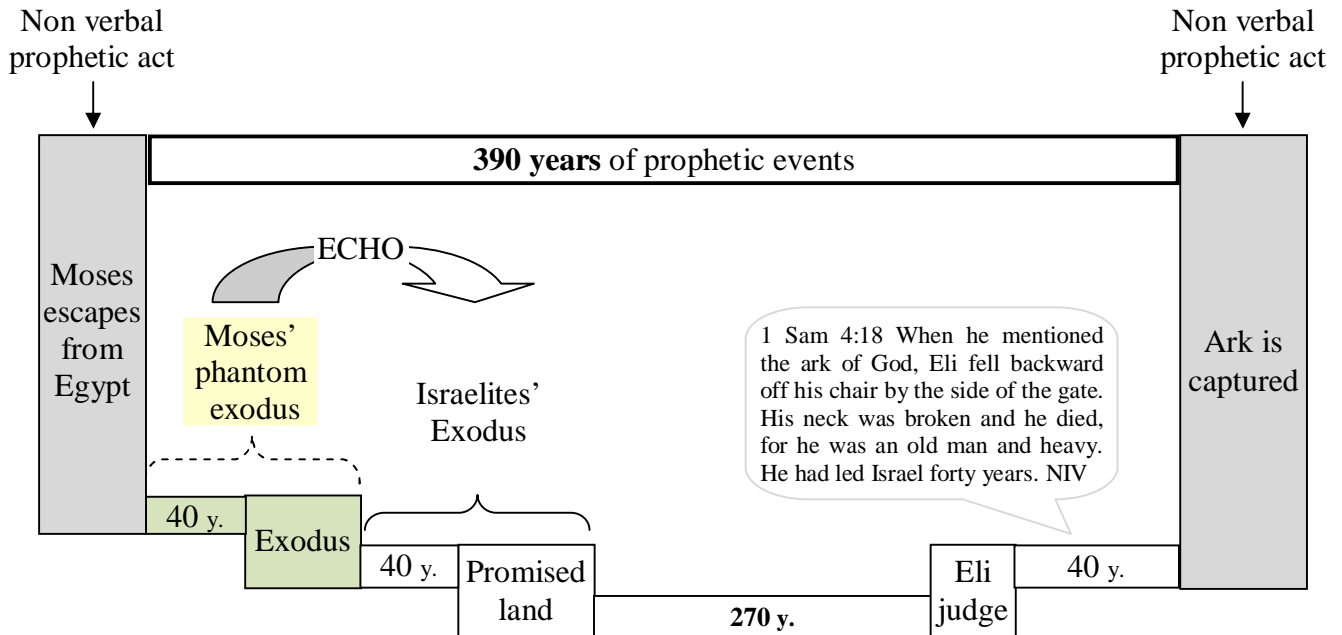

Here we have 10 events that took place during Moses' phantom exodus and are echoed during the Israelites' Exodus.

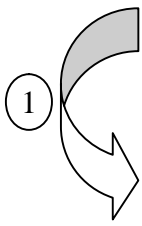

Moses sees his people's hardship:

- Ex 2:11 and it came to pass in those days, when Moses was grown, that he went out unto his brethren, and looked on their burdens KJV

God see his people's hardship:

- Ex 3:7 And the LORD said, I have surely seen the affliction of my people which are in Egypt, and have heard their cry by reason of their taskmasters; for I know their sorrows; KJV.
-

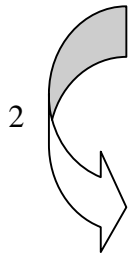

Moses rescues one Israelite:

- Ex 2:11 and he spied an Egyptian smiting an Hebrew, one of his brethren. KJV

Moses rescues every Israelite:

- Ex 3:10 and I will send thee unto Pharaoh, that thou mayest bring forth my people the children of Israel out of Egypt. KJV
-

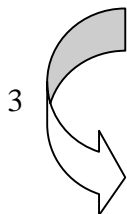

Moses kills an Egyptian soldier and **buries him in the sand:**

- Ex 2:12 he slew the Egyptian, and hid him in the sand. KJV

Moses would **bury** the whole Egyptian army **in the water:**

- Ex 14:28 And the waters returned, and covered the chariots, and the horsemen, and all the host of Pharaoh that came into the sea after them; there remained not so much as one of them. KJV
-

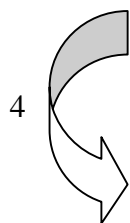

Moses is told by an Israelite that he isn't his Judge:

- Ex 2:14 Who made thee a prince and a judge over us? KJV

Moses becomes ruler and Judge over every Israelite:

- Ex 18:13 And it came to pass on the morrow, that Moses sat to judge the people: and the people stood by Moses from the morning unto the evening. KJV

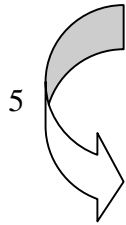

Pharaoh plans to kill Moses but he will never see him again:

- Ex 2:15 Now when Pharaoh heard this thing, he sought to slay Moses.

Pharaoh [a different one] threatens Moses that he will kill him next time he sees him but they will never meet again:

- Ex 10:28 And Pharaoh said unto him, Get thee from me, take heed to thyself, see my face no more; for in that day thou seest my face thou shalt die. KJV
-

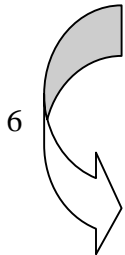

Moses flees from Egypt to avoid being captured:

- Ex 2:15 Now when Pharaoh heard this thing, he sought to slay Moses. But Moses fled from the face of Pharaoh, and dwelt in the land of Midian KJV

Moses helps all of Israel to flee from Egypt and regain their freedom:

- Ex 12:31-33 ... Rise up, and get you forth from among my people, both ye and the children of Israel; and go, serve the LORD, as ye have said. .. And the Egyptians were urgent upon the people, that they might send them out of the land in haste; KJV

Note: Pharaoh authorized Israelites to take a three-day journey to worship their God. Pharaoh never authorized them to leave permanently. We can therefore say that Moses and all the Israelites escaped from Egypt.



Moses leaves Egypt and crosses a desert.

(It is here assumed that the Medianites' land borders a desert.)

The Israelites leave Egypt and cross the sea:

- Ex 14:22 And the children of Israel went into the midst of the sea upon the dry ground: and the waters were a wall unto them on their right hand, and on their left. KJV
-

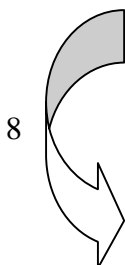

Moses goes to the Sinai and talks to God:

- Ex 3:4 God called unto him out of the midst of the bush, and said, Moses, Moses. And he said, Here am I. KJV

The Israelites go to the Sinai and hear God talking to Moses:

- Ex 19:9 And the LORD said unto Moses, Lo, I come unto thee in a thick cloud, that the people may hear when I speak with thee, and believe thee for ever. KJV
- Ex 19:18-19 and the whole mount quaked greatly. And when the voice of the trumpet sounded long, and waxed louder and louder, Moses spake, and God answered him by a voice. KJV

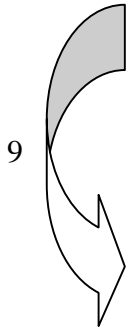

At the end of 'Moses' phantom exodus' one of his sons (it could be both), born in the wilderness, is circumcised:

- Ex 4:25 Then Zipporah took a sharp stone, and cut off the foreskin of her son, KJV

At the end of the Israelites' Exodus, all those born in the wilderness are circumcised:

- Josh 5:3 And Joshua made him sharp knives, and circumcised the children of Israel at the hill of the foreskins. KJV
- Josh 5:5 but all the people that were born in the wilderness by the way as they came forth out of Egypt, them they had not circumcised. KJV

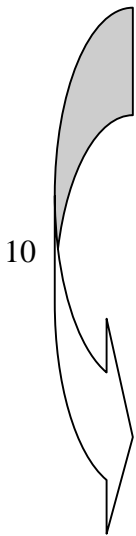

Moses' phantom Exodus could have lasted 40 years:

- Acts 7:23 And when he was full forty years old, it came into his heart to visit his brethren the children of Israel. KJV
- Ex 7:7 And Moses was [80] years old, and Aaron [83] years old, when they spake unto Pharaoh. KJV

NOTE: To those who might be reticent to accept any reference from the book of Act, I suggest that they **postulate** from here on that Moses was 40 years old when he fled from Egypt and that the Exodus occurred 40 years later. At the end of this 'paper' they will be in a much better position to evaluate the soundness of this postulate.

Israel's Exodus lasted 40 years:

- Num 14:33 And your children shall wander in the wilderness forty years, KJV

Ark captured (End of the 390 years)

We have seen that the start of the 390 (prophetic) years was initiated by the 'escape of Moses from Egypt', an event symbolizing the exodus that was about to occur for the twelve tribes.

At the opposite end of the period, 390 years later, a calamity that must have been felt by every member of the twelve tribes took place. At the time, some of the tribes were engaged in a battle against their oppressors, the Philistines. Expecting that it would bring them some divine help, the Israelites brought the Ark of the Covenant onto the battlefield. They were defeated and the Philistines took the Ark with them.

Before saying more about the 'capture of the Ark', here is a cursory layout that shows how these 390 years (of prophecy) relate to others events.

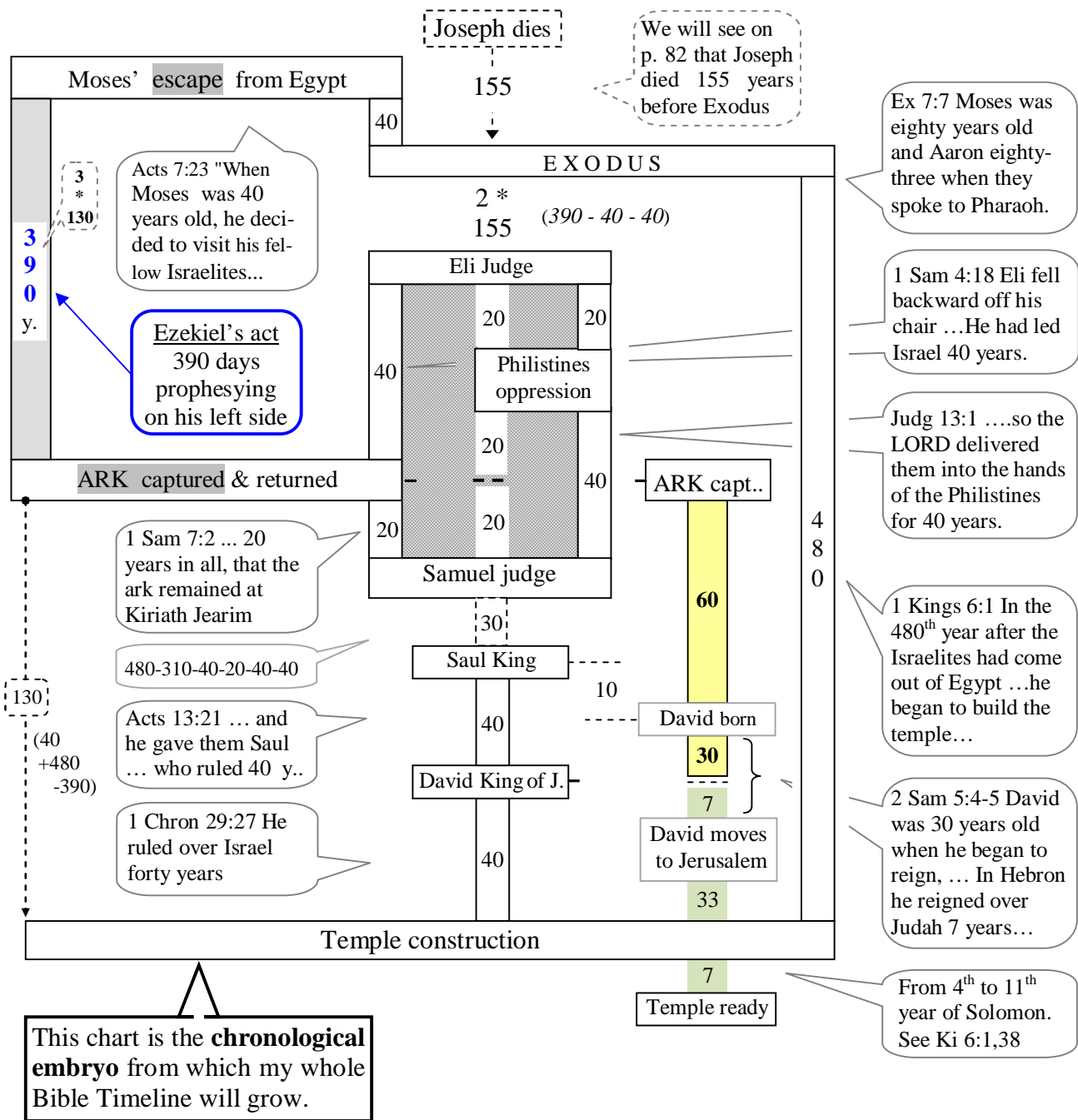

Besides having conveniently happened 390 years⁴⁸ after “Moses’ escape from Egypt”, did the ‘capture of the Ark’ mark the end of this ongoing ‘prophetic’ period? We need to keep in mind that there was a break after Ezekiel’s first 390 days of prophesying. When he turned over, his action was fully accomplished in regard to the House of Israel. The finality expressed in Ezekiel’s action (turning over) had to be found also at the end of the 390 year period that we are looking at.

But to our question we can answer a strong ‘yes’. The Capture of the Ark was nothing less than God’s proclamation that He was leaving his dwelling place in Shiloh:

- 1 Sam 4:22 She said, "The glory has departed from Israel, for the ark of God has been captured."

⁴⁸ This is part of the hidden information found in Ezekiel 4.

The Ark never came back to Shiloh after its capture. The departure was permanent. The capture of the Ark was a prophetic event that had been hinted to Samuel some years earlier:

- 1 Sam 3:11 And the LORD said to Samuel: "See, I am about to do something in Israel that will make the ears of everyone who hears of it tingle.

Samuel was informed of the future capture of the Ark while lying in the Temple. We can hardly fail to see the connection with Ezekiel 'symbolically' lying in the Temple while indirectly portraying Samuel in the same situation:

- 1 Sam 3:9,15 So Eli told Samuel, "Go and lie down, and if he calls you, say, 'Speak, LORD, for your servant is listening.'" So Samuel went and lay down in his place... Samuel lay down until morning and then opened the doors of the house of the LORD.
- Ezek 4:4 "Then lie on your left side and put the sin of the house of Israel upon yourself.

Parallels between Moses and Samuel

- The start of the 390 years began with a prophetic sign performed by Moses (his **escape from** Egypt) and ended with a prophetic sign revealed to Samuel some time before it occurred (Ark's **capture**).
- Both prophets (Moses and Samuel) were highly regarded in the eyes of God:
 - Jer 15:1 Then the LORD said to me, "Even if Moses and Samuel stood before Me, My mind would not be favorable toward this people.
- Moses was the first judge of Israel. (He is the one who anointed the first High Priest [Aaron].)
Samuel was the last Judge. (He is the one who anointed the first king [Saul].)
- Both of them owe their life to the unusually strong will of their mother (not their father):
 - Ex 2:3 Then she placed the child [**Moses**] in it and put it among the reeds along the bank of the Nile.
 - 1 Sam 1:11 "O LORD Almighty, if you will only look upon your servant's misery and remember me, and not forget your servant but give her a son[**Samuel**],
- Neither of them was raised by their mother.
Moses was raised by Pharaoh's daughter after having been weaned by his mother.
Samuel was raised by Eli in the Temple at Shiloh after having been weaned by his mother.
- Each one stood on Holy ground.
Moses went up the Sinai and Samuel used to lie down in the Temple.

40 years of prophecy for the House of Judah (South side)

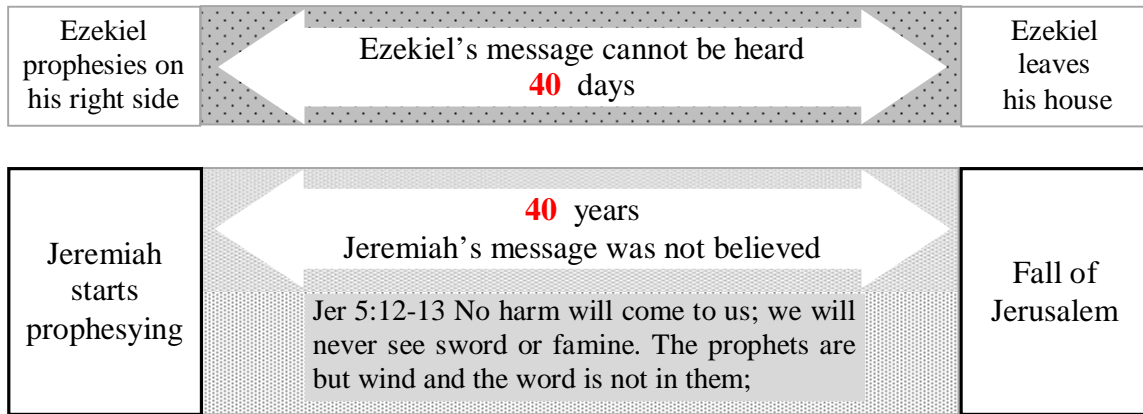

Exactly 40 years before the destruction of Jerusalem, the prophet Jeremiah was mandated to prophesy against Jerusalem:

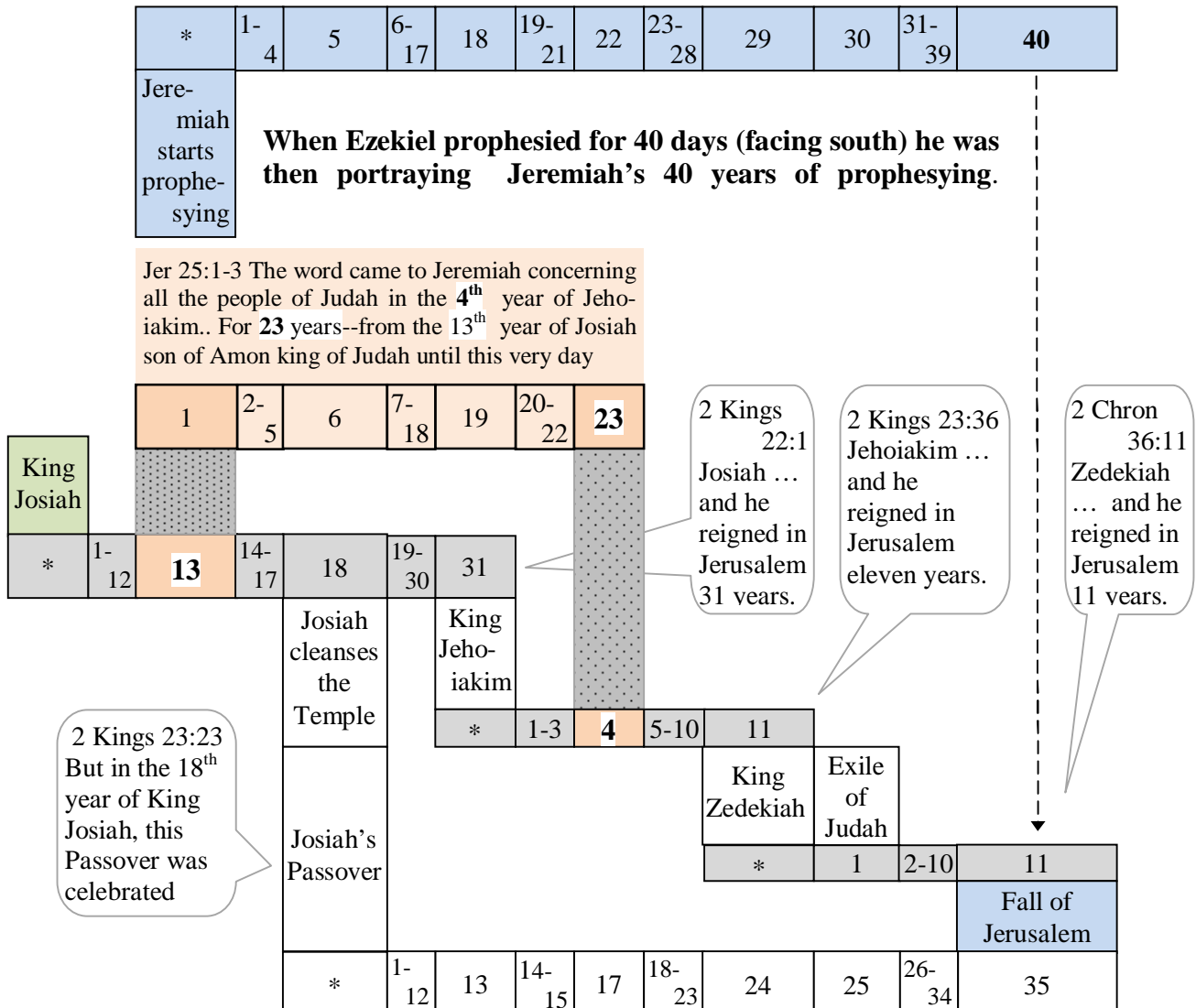

With bare arm . . . (390 + 40 days)

Besides prophesying while lying on his side Ezekiel was instructed to do it **with his arm uncovered**:

- Ezek 4:7 Turn your face toward the siege of Jerusalem and with bare arm prophesy against her.

The request seems so unimportant that the casual reader doesn't give it a second thought and if he does he probably fails to understand the purpose of it.

Some commentators rightly associated 'the bare arm' of Ezekiel as a sign of power or fighting. In biblical times, it was customary for a soldier about to engage in a fight to uncover his right arm. This was done to prevent his garment being in the way while manipulating the sword. Aware of this information, we should refrain from assuming that Ezekiel's bare arm was a sign of the imminent siege⁴⁹ coming against Jerusalem. If it had been intended that way, it would have been lessened by Ezekiel's appearance, as he was lying and tied during the whole time. And besides that, the siege had already been portrayed on a tile; there was no need to call our attention to it again.



The only other reference where the two words, 'Chaasap' and 'et- z^arowa' (translated 'bare' and 'arm') appear together is in Isa 52:10:

- Isa 52:10 The LORD hath made bare his holy arm in the eyes of all the nations; and all the ends of the earth shall see the salvation of our God.

It is obvious here that the subject of Isa 52:10 is God's powerful accomplishment for his people.

Now, since Ezekiel was specifically chosen by God to act in the present performance and since he was doing it in his capacity of a prophet, we may conclude that Ezekiel's 'bare arm' was a substitute for God's 'bare arm'. Ezekiel, by having his arm bare, was performing yet another symbolic act, which was also dependent on the time that he lay on his sides. However, in the present case there is no need to differentiate between what was going on during the first 390 days and what was going on during the last 40 days. In the end Ezekiel had been laying bare arm for **430 days**, even⁵⁰ if he had to turn over at one time.

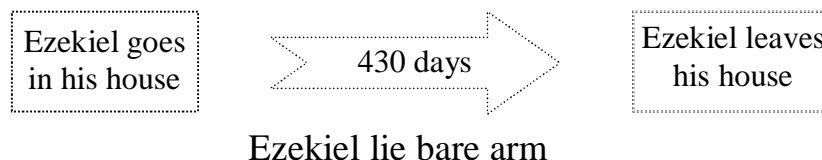

⁴⁹ Nebuchadnezzar' siege

⁵⁰ When Ezekiel turned to the other side at the end of the first 390 days, it did create a break for many symbolic acts that were currently going on but it was not the case with the 'bare arm' one. Laying South-north facing East rather than laying North-south facing East had no impact on Ezekiel's bare arm. The symbolic act kept going on until the 430th day.

Ezekiel's portraying of God's powerful arm for 430 days was intended to remind us of the 430-year period that started at the Exodus.

430 years under God's protection

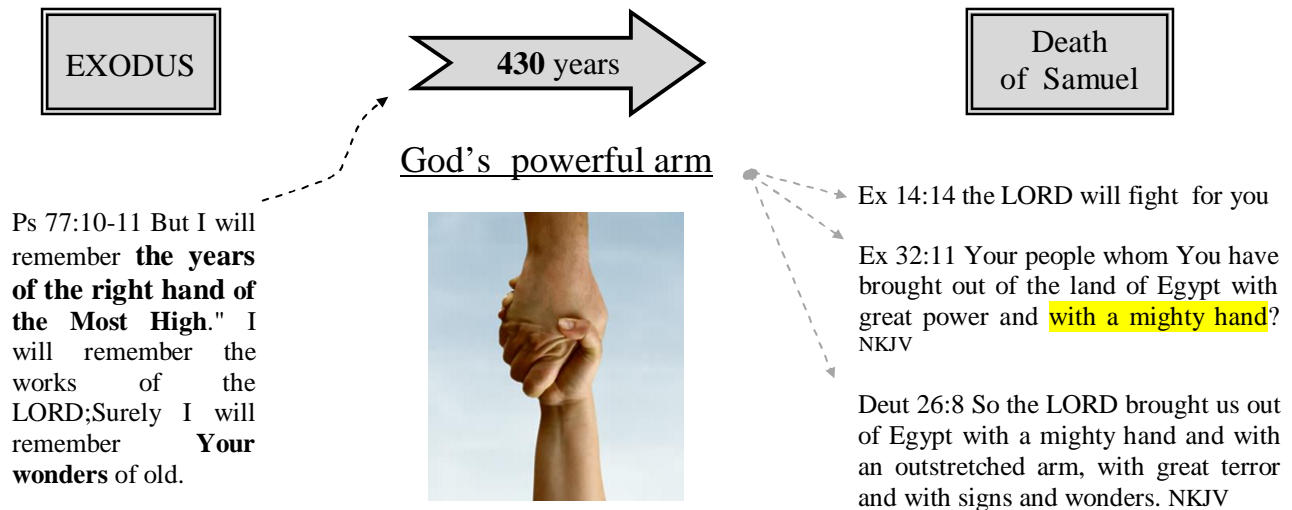

Before the Exodus, God's manifestations of power had been extremely rare and were never witnessed by more than a few individuals if at all. At the Exodus, God's mighty power was manifested in such a spectacular way that nobody could have pretended not to have heard about it. In the space of a single day every family⁵¹ in Egypt lost a son, a father or a brother while several millions of Israelites, untouched by the tragedy, left the country:

- Ex 12:12 "On that same night I will pass through Egypt **and strike down** every firstborn
- Ex 13:3 "Commemorate this day, the day you came out of Egypt, out of the land of slavery, because the LORD brought you out of it **with a mighty hand**
- Ex 7:4 Then **I will lay my hand on Egypt** and with mighty acts of judgment I will bring out my divisions, my people the Israelites.

By his mighty power God opened the sea and allowed the 12 tribes to cross it on dry land:

- Ex 14:13-14 Moses answered the people, "Do not be afraid. Stand firm and you will see the deliverance the LORD will bring you today. The Egyptians you see today you will never see again. **The LORD will fight for you;** you need only to be still."
- Isa 43:16-17 he who made a way through the sea, a path through the mighty waters, who drew out the chariots and horses, the army and reinforcements together,

In the 40 years following the Exodus the 12 tribes witnessed almost every day the manifestation⁵² of God's power:

- Ex 13:22 He took not away the pillar of the cloud by day, nor the pillar of fire by night, from before the people.

⁵¹ There was a dead in every house (Ex 12:30), the first born of every animal was also put to death. (Ex 12:29)

⁵² See also Deut 2:7, Num 11:31, Num 9:15-16

- Deut 8:16 He gave you manna to eat in the desert, something your fathers had never known,
- Ex 17:6 Strike the rock, and water will come out of it for the people to drink."
- Deut 8:4 Your clothes did not wear out and your feet did not swell during these forty years.

After the Israelites had entered the Promised Land they became accountable for their behavior. For several hundred years they were ruled by oppressors or rescuers:

- Josh 23:10 One of you routs a thousand, because the LORD your God fights for you, just as he promised.
- Judg 2:14-15 In his anger against Israel the LORD handed them over to raiders who plundered them. He sold them to their enemies all around, whom they were no longer able to resist. Whenever Israel went out to fight, **the hand of the LORD was against them** to defeat them,
- Judg 2:18 Whenever the LORD raised up a judge for them, he was with the judge and **saved them out of the hands of their enemies** as long as the judge lived;

The 430 years under God's special protection ended with Samuel's death, the last and one of the greatest of the judges. During Samuel's lifetime the Ark was captured⁵³, the Philistines were permanently subdued⁵⁴, and two kings were anointed⁵⁵.

The people rejected God. There was a good reason to end the 430 years of God's protection (mighty arm) at the time of Samuel's death. The Israelites in their blindness, voluntarily rejected that special protection by asking for a king:

- 1 Sam 8:6 But when they said, "Give us a king to lead us," this displeased Samuel;
- 1 Sam 8:7 And the LORD told him: "Listen to all that the people are saying to you; it is not you they have rejected, **but they have rejected me as their king.**

There was no equivocation, they didn't need God's arm to fight for them anymore, their new king would protect them:

- 1 Sam 8:19-20 But the people refused to listen to Samuel. "No!" they said. "**We want a king over us.** Then we will be like all the other nations, **with a king to lead us and to go out before us and fight our battles.**"

At the end of Samuel's life (the last Judge of Israel), all ties with the past were done away with. God's manifestation of power became again extremely rare.

⁵³ 1 Sam 3:11 And the LORD said to Samuel: "See, I am about to do something in Israel that will make the ears of everyone who hears of it tingle.

⁵⁴ 1 Sam 7:12-13 "Thus far has the LORD helped us." So the Philistines were subdued and did not invade Israelite territory again.

⁵⁵ Saul (see 1 Sam 15:17) & David (see 1 Sam 16:13)

The 3 blocks view

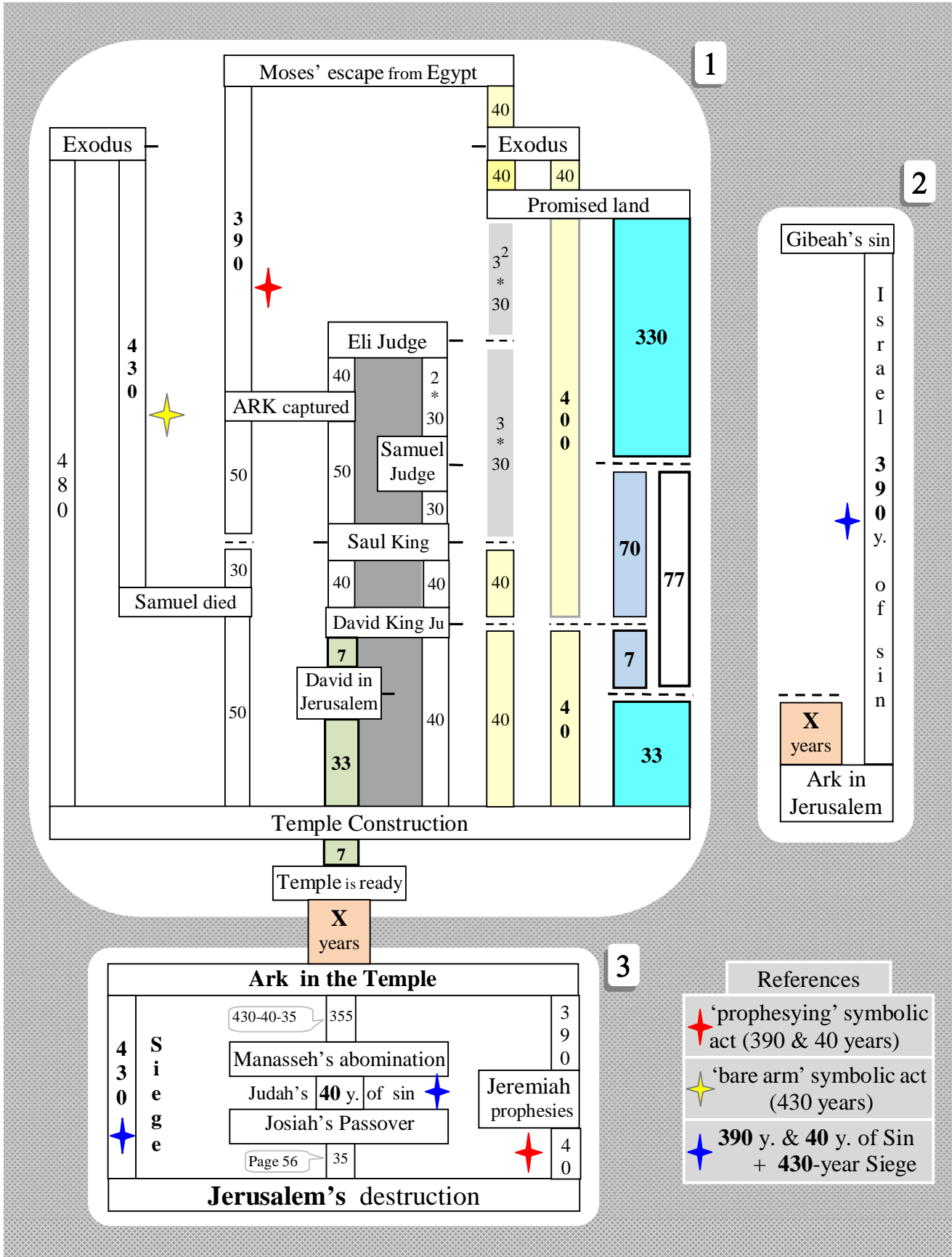

The previous figure combines all the information obtained from Ezekiel 4. so far. As we can see, the chronology of the period from “Moses’ escape” to “Jerusalem’s destruction” can be divided into three blocks of information. Now, we will try to link those three blocks together.

Between block 1 and block 3

By postulating that the Ark was brought into the Temple three years after the end of its construction, one observes (see Figure 8. Blocks 1 and 3 reunited on page 62’) that many events can now be linked together by either meaningful values or by original patterns.

Most of us took for granted that the Ark was brought into the Temple right at the end of the 7 years of its construction, which cannot be the case.

According 1 King 6:38 the Temple was ready in the **month of Bull** (the 8th month), 7 years after the start of its construction:

- 1 Kings 6:38 In the eleventh year in the month of Bul, the eighth month, the temple was finished in all its details according to its specifications. He had spent seven years building it.

But the Ark was brought in the **month of Ethanim** (the 7th month):

- 1 Kings 8:2-4 All the men of Israel came together to King Solomon at the time of the festival in the month of Ethanim, the seventh month. When all the elders of Israel had arrived, the priests took up the ark, 4 and they brought up the ark of the LORD

The Ark could not have been brought to the Temple one month before this one was ready. Therefore the only way to reconcile the information we are given is to recognize that the Ark was brought the following year at the earliest. In fact, the following figure shows that a delay of three years generates a vast collection of pattern and represent the best possible solution.

A three-year wait is quite acceptable given that the Temple, once its structure was completed (after 7 years), needed to be properly dressed before becoming operational. Thousands of people had worked on the structure, but only a few and exceptionally skilled workers were involved with the temple furnishing:

- 1 Kings 7:13-14 King Solomon sent to Tyre and brought Hiram ... Hiram was highly skilled and experienced in all kinds of bronze work. He came to King Solomon and did all the work assigned to him.
- 1 Kings 7:48-50 Solomon also made all the furnishings that were in the Lord’s temple: the golden altar; the golden table on which was the bread of the Presence; the lampstands of pure gold (five on the right and five on the left, in front of the inner sanctuary); the gold floral work and lamps and tongs; the pure gold basins, wick trimmers, sprinkling bowls, dishes and censers; and the gold sockets for the doors of the innermost room, the Most Holy Place, and also for the doors of the main hall of the temple.

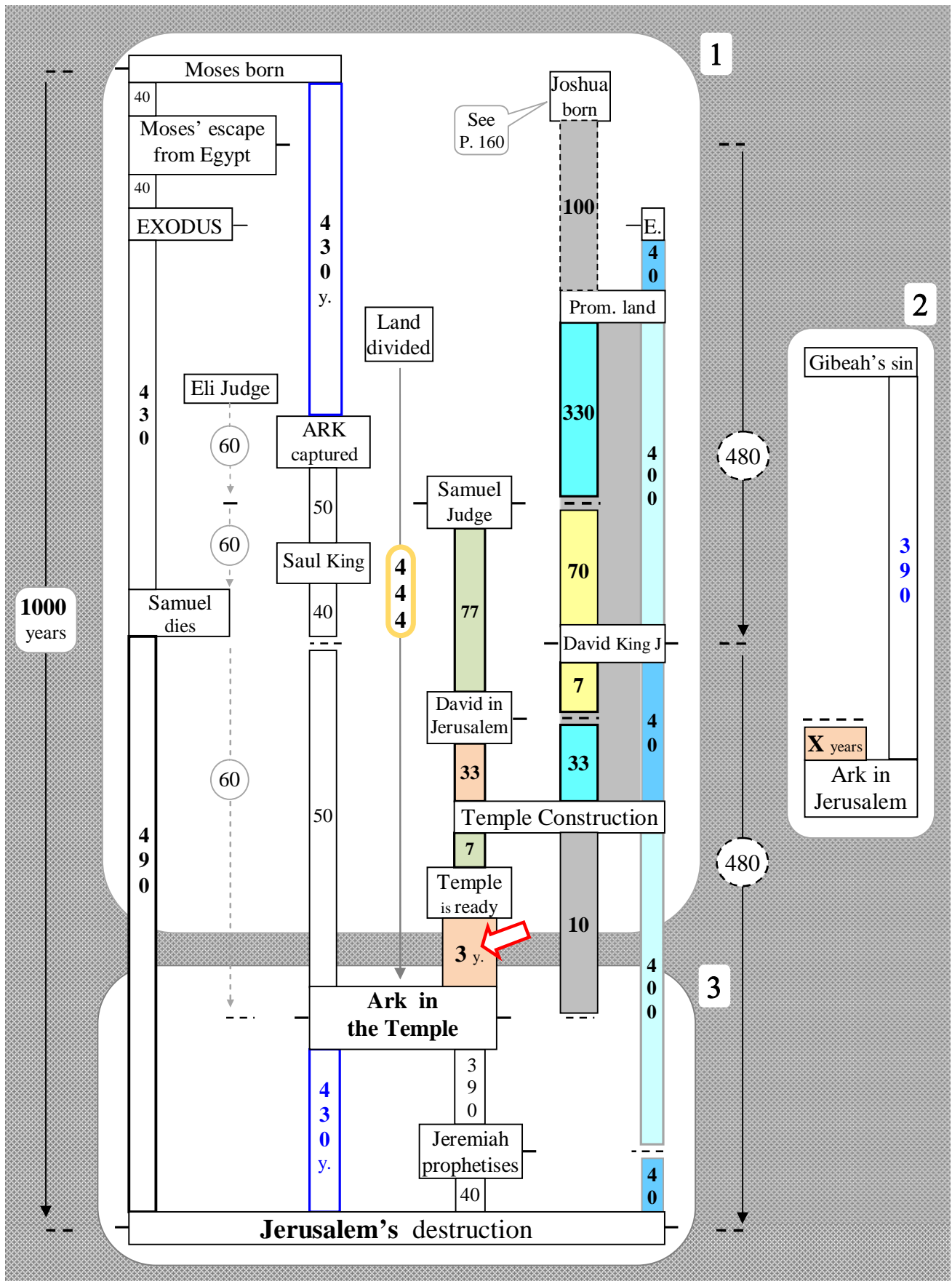

Figure 8. Blocks 1 and 3 reunited

On a chronological point of view, an extremely important piece of information is obtained from the previous figure. There were 490 years between Samuel's death and Jerusalem's end.

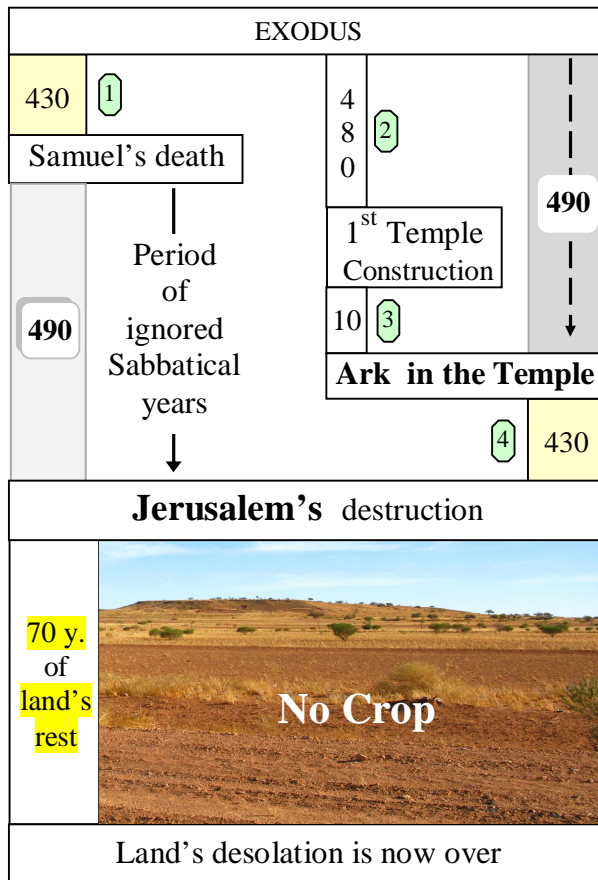

Figure 9. Samuel's death

... and the number of sabbatical years that were missing was 70. At a rate of one sabbatical year, every 7 years, the people had been disobeying the sabbatical law for 490 years. With the help of the previous figure, it is easy to see that going back 490 years from the 'Destruction of Jerusalem' we reach the time of Samuel's death. Should we be surprised? The people stopped keeping the sabbatical year as soon as Samuel, their last judge, died.

Going back to the earlier discussion of Ezekiel's 'bare arm' on page 58, we concluded that it portrayed the mighty hand of God that operated from 'EXODUS' to 'Samuel's death', a period of 430 years. We can now also say that the mighty hand of God operated from 'Exodus' to the time the Israelites started ignoring the sabbatical years.

By choosing to ignore⁵⁶ God's important warning the Israelites brought to an end the unmatched superiority they had over other people around:

- Deut 5:15 Remember that you were slaves in Egypt and that the LORD your God brought you out of there with a mighty hand and an outstretched arm. **Therefore the LORD your God has commanded you to observe the Sabbath day.**

⁵⁶ The sabbatical law didn't limit itself to the weekly cycle; there was also a counterpart that has to do with the 7 years cycle.

- ① The 430 years obtained from the 430 days of Ezekiel's bare arm.
- ② 1 Kings 6:1 In the 480th year after the Israelites had come out of Egypt, ... he began to build the temple of the LORD
- ③ This is deduced by earlier speculation when it was shown that the Ark was brought into the Temple 3 years after the structure was completed.
- ④ The 430 years portrayed by the total 430 days that Ezekiel had been lying on both sides. (Siege of the Ark)

Following the destruction of Jerusalem (and the Temple) we are told that the land was going to enjoy all the sabbatical rest it hadn't received in the past ...

- 2 Chron 36:21 The land enjoyed its Sabbath rests; all the time of its desolation it rested, until the **seventy years** were completed in fulfillment of the word of the LORD

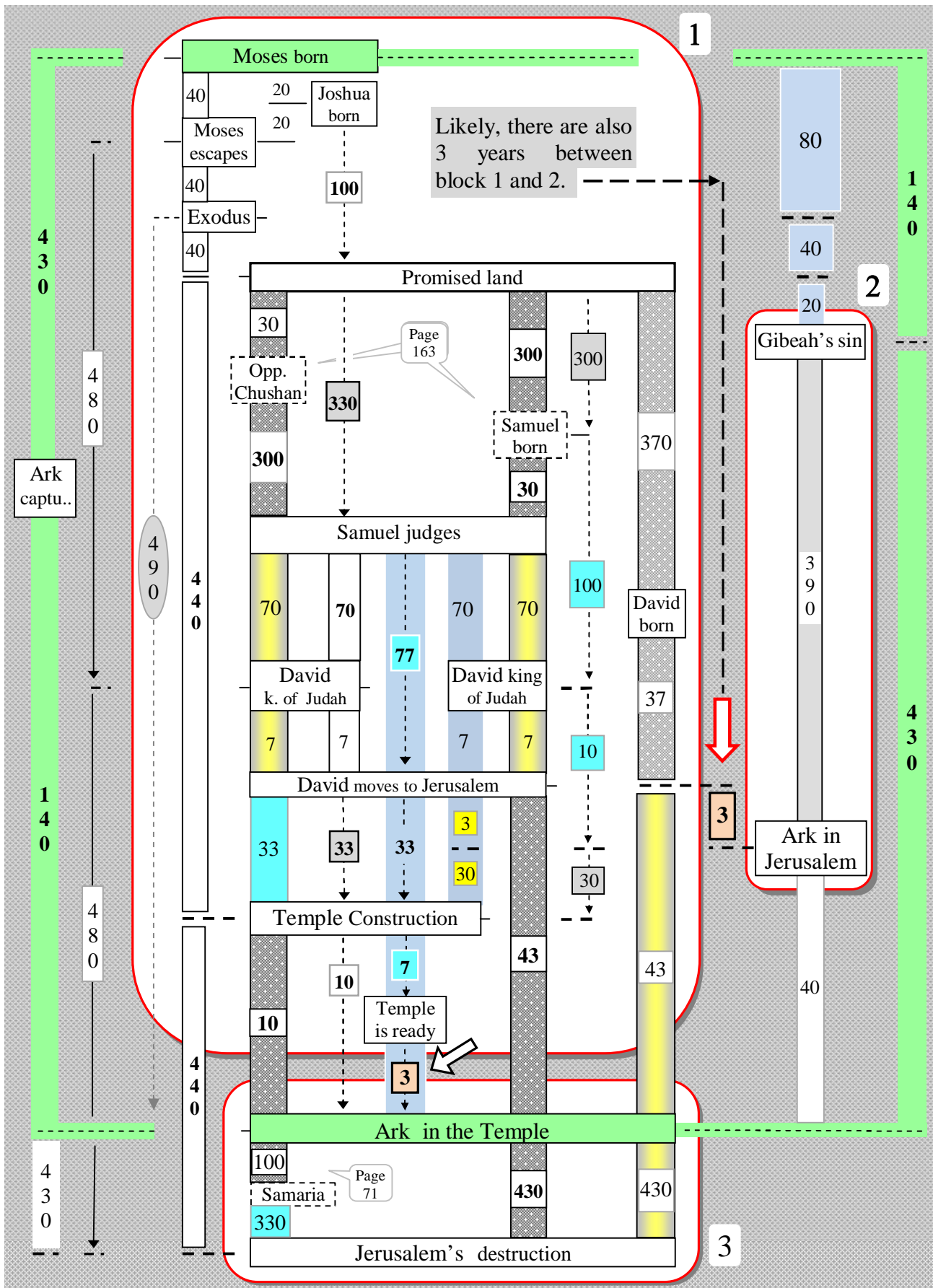

The ark was brought in Jerusalem 3 years after David settled in the city

Did David wait three years to bring the Ark in Jerusalem? It is quite conceivable if he was planning to bring it into the new palace that he was building during that time.

1 Chron 15:1 David built houses for himself in the City of David; and he prepared a place for the ark of God, and pitched a tent for it.

1 Chron 15:3 David assembled all Israel in Jerusalem to bring up the ark of the LORD to the place he had prepared for it.

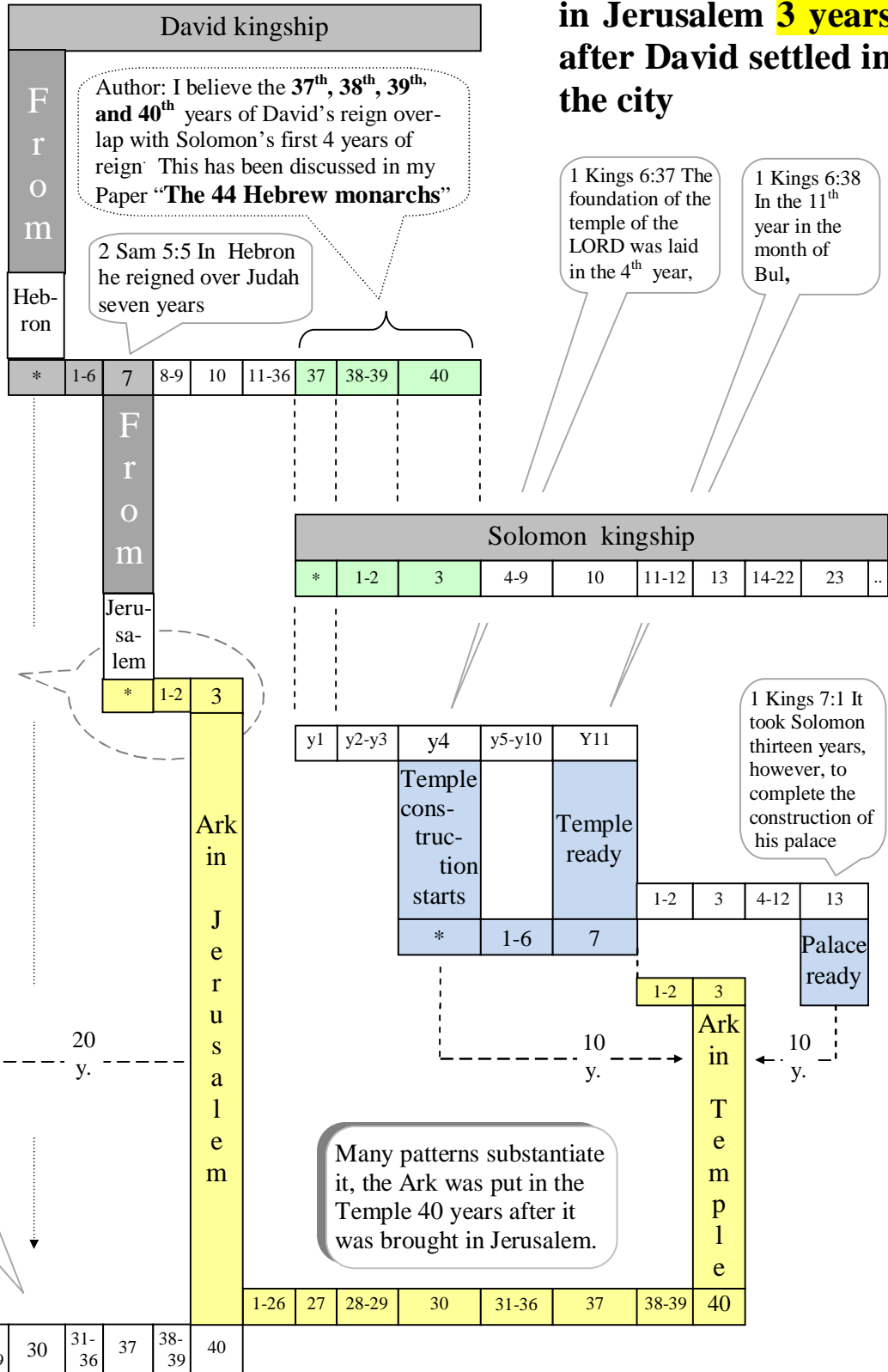

Ezekiel ate defiled food for 390 days

Among the numerous symbolic acts described in Ezekiel 4, there is the profanation of his food:

Ezek 4:12-15 ... and bake it using fuel of human waste in their sight." Then the LORD said, "So shall the children of Israel eat their defiled bread among the Gentiles, where I will drive them." Then he said unto me, Lo, I have given thee cow's dung for man's dung, KJV

Notice There is a direct correlation between the north side's animal Bull, associated with the House of Israel's 390 days, and the "cow's dung".



Ezekiel used cow's dung as fuel

Ezekiel was asked to cook and eat defiled food for 390 days. Obviously we have here another symbolical act that was meant to portray another 390 years period. Before paying attention to the events pictured by this act we will review in more details what was asked to Ezekiel and how he delivered it.

Human dung VS cow dung

God first asked Ezekiel to cook his food using human dung but consecutive to Ezekiel's objection that he had never defiled himself in the past, God proposed an abatement: Ezekiel was going to use cow dung to fuel the cooking fire.

Keeping in mind that Ezekiel had to eat defiled food in order to portray a situation where all the people were going to eat defiled food,

- Ezek 4:13 The LORD said, "In this way the people of Israel will eat defiled food among the nations where I will drive them." NIV

→ we can deduce this important point:

It didn't matter which one of the 'human dung' or 'cow dung' was to be used. In the end Ezekiel food **had to** be defiled to properly create the symbolical act.

When told to use human dung to fuel the fire, Ezekiel vehemently protested that he had never been defiled in the past.

- Ezek 4:14 Then said I, Ah Lord GOD! behold, my soul hath not been polluted: for from my youth up even till now have I not eaten of that which dieth of itself, or is torn in pieces; neither came there abominable flesh into my mouth. KJV

→ From this we can also deduce this point:

Using cow dung didn't defile Ezekiel, if it had, it would have defeated the purpose of the abatement.

Using cow dung as fuel defiled the food but not Ezekiel

| | Hunan waste as fuel | Cow dung as fuel |
|---------|---------------------|--------------------|
| Food | Defiled | Defiled |
| Ezekiel | Defiled | Not defiled |

But what is it with human waste that would have defiled Ezekiel? Could it be that human waste, contrary to cow dung, which can be found over the ground, had to be dug out from the ground? It seems that Ezekiel understood that if he had to dig out the human excrement he would have defiled himself and it was intolerable.---

Cooking every day while tied up

Did Ezekiel really cook his food every day over the 390 day period?

Most commentators don't hesitate to answer 'yes' to this question and then argue that the daily cooking (gathering dung, starting the fire, food preparation) is a confirmation that Ezekiel wasn't required to be on his side 24 hours a day.

The only problem is that the Bible's text is not **ambiguous, Ezekiel was going to be tied until the end of his siege and there is no mention of any relaxing.**

- Ezek 3:24 Go, **shut yourself inside your house**. NIV
- Ezek 3:25 And you, son of man, they will tie with ropes; you will be bound so that you cannot go out among the people. NIV
- Ezek 4:8 I will tie you up with ropes so that you cannot turn from one side to the other **until** you have finished the days of your siege. NIV

The full textual meaning of this is that Ezekiel was tied up and had to lie on his side **without interruption** for 430 days (390 + 40).

What about the daily cooking then? Well, there couldn't have been any daily cooking.

Have you notice that Ezekiel was told to cook his food **in the sight of the people**?

- Ezek 4:12 bake it in the sight of the people NIV

?

But he was also told **to shut himself in his house**

- Ezek 3:24 Go, shut yourself inside your house. NIV

The only way to reconcile this apparent contradiction is to have the cooking done just before Ezekiel went to his house for 430 days. What I suggest is that Ezekiel cooked all his food right in front of the people at the beginning of his ordeal and then brought the food inside the house. Keep in mind that what he baked were small flat barley cakes weighting 20 shekels and done with a mixture of grain that he had stored in a jar. Once baked, nothing could have prevented Ezekiel to bring the food inside and stacked it at arm's reach, while he was lying.

Did Ezekiel spend 430 without relieving himself? Could Ezekiel have survived 40 days without eating while reclining on the right side? Was the food protected from spoiling during the 390 days he was allowed to eat? I say 'YES' to all these questions. Ezekiel had been given a mandate from God. Anything outside the symbolical realm of that mandate should be view as irrelevant. If God could take care of more than a million peoples during Exodus we shouldn't doubt that He made sure Ezekiel would be able to do the task.

- Deut 8:4 Your garments did not wear out on you, nor did your foot swell these forty years. NKJV

Now let's look at the interpretation of this symbolical act.

We have to keep in mind three important elements when analyzing it:

1. It lasted 390 years:
Ezekiel was allowed to feed himself only during the first 390 days of his siege. Therefore, according to the rule that 'a day equals a year'⁵⁷, whatever was portrayed by the defiled food had to last **exactly 390 years**.
2. It applied to the 12 tribes:
Any symbolical act associated with the 390 days of Ezekiel has to do with the 12 Tribes. This point has already been shown several times in this paper.
3. It was going to involve other nations:
Part or the totality of the period will be spent in the midst of non-Israelite nations. Therefore the time in exile could be part of the 390 years.

In short, we are looking for a period of 390 years during which the people of Israel (12 tribes) supposedly ate defiled food among other nations. If we accept this most simplistic⁵⁸ interpretation, we will find only three possible starts for the period.

First Exile ? When Jacob goes to Egypt. Jacob's descendants left Egypt (Exodus) exactly 225 years later (See page 176). The period is too short to represent what we are looking for.

Second Exile ? When the 10 northern tribes were deported to Assyria at the end of King Hoshea's reign. Unfortunately they never came back to their land and they are still in exile to this day. (*there will be much more to say about that exile later in this book*). This period cannot be used either.

Third Exile ? When Judah went into Exile in Babylon. This exile lasted only 70 years and is therefore too short to be a valid start.

Obviously the 390-year period could not have started with any of the previous three exiles, on the other hand Ezek 4:13 does say that the Israelites shall eat their defiled food among the nations. It can hardly be more unambiguous: the Israelites had to be in exile to fulfill this description.

Now wouldn't it bring a whole new perspective to our interpretation if, instead of assuming that our 'period of defiled food' was initiated by the beginning of an EXILE we would postulate that it was rather concluded by the '**return from an exile**'? A quick review shows that the return from the first or second exile cannot be good candidates. Going backward 390 years from the coming out of Egypt (end of first exile) would bring us to a time when the 12 patriarchs were not even born. Neither can we use the end of the second exile given that this exile is not over yet (*author absolute belief*).

That leaves us with the return from the third Exile "i.e. at the end of **Judah' 70 years exile**" with the inference that the Israelites (southern kingdom) ate their defiled food among other

⁵⁷ Ezek 4:5 For I have laid on you the years of their iniquity, according to the number of the days NKJV
Note: People have been ill-advised to replace 'days' by 'years' every time they found it convenient in their research on chronology but to do it with Ezekiel 4 is quite appropriate.

⁵⁸ Remember that Ezekiel's symbolic acts are never what they appear to be.

nations only in the last 70 years⁵⁹ of the 390 years period of defiled food. It should be noted that Ezek 4:13 doesn't specifically say that they would be among⁶⁰ other nations for the whole 390 years. Besides that, we are about to discover that going backwards 390 years from the "return of Judah's exiles" brings us to the start of the most corrupted (defiled) period of Israel's history, a period also characterized by the introduction of the worship of Baal (a foreign nation's deity) by the Israelites. The foundation of Samaria.

Defiled food = False word

The Israelites were told that along with their bread they also needed to feed themselves with the 'word of God':

- Deut 8:3 He humbled you, causing you to hunger and then feeding you with manna, which neither you nor your fathers had known, to teach you that man does not live on bread alone but **on every word that comes from the mouth of the LORD.** NIV

Jeremiah and Ezekiel were fed the words of God before being sent to the people:

- Jer 15:16 When your words came, I ate them; they were my joy and my heart's delight, NIV
- Ezek 3:3 Then he said to me, "Son of man, eat this scroll I am giving you and fill your stomach with it." So I ate it, and it tasted as sweet as honey in my mouth. NIV

The role of the prophets was to feed the people with food for the mind⁶¹. Therefore, when the prophets were lying and gave words that did not come from God, **they were feeding the people with defiled food.** Ezekiel's unclean food symbolized the false words given to the people by most of the prophets after the foundation of the city of Samaria.

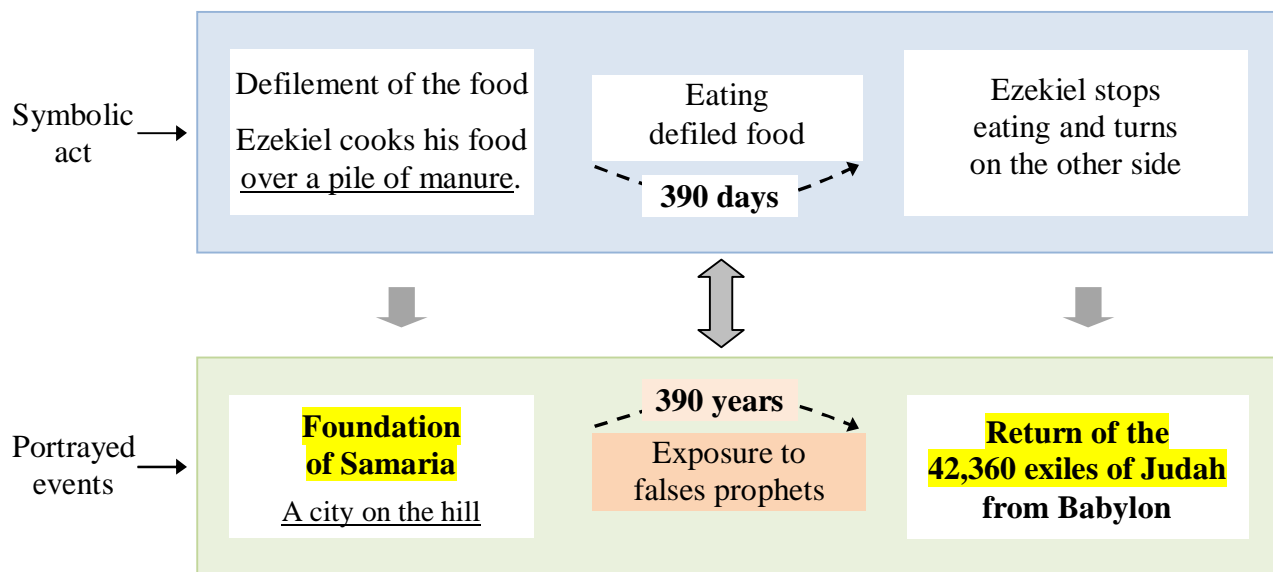

⁵⁹ 70 years is the duration of the Exile

⁶⁰ There is more to say about that aspect. See 'among other nations' on page 74.

⁶¹ Notice in the following verse from Amos that the 'absence of word' (from God) can be equated to a famine. [Amos 8:11 "Behold, the days are coming," says the Lord GOD, "That I will send a famine on the land, Not a famine of bread, Nor a thirst for water, But of hearing the words of the LORD. NKJV]

Was Samaria founded 390 years before the return of the 42,360 exiles from Babylon? Yes, and to corroborate this proposition, it can be quickly shown that King Omri, the one who founded Samaria, was the one reigning 390 years before the return of the exiles of Judah from Babylon.

✓ The return from the Babylonian exile happened **60 years** after the temple destruction:

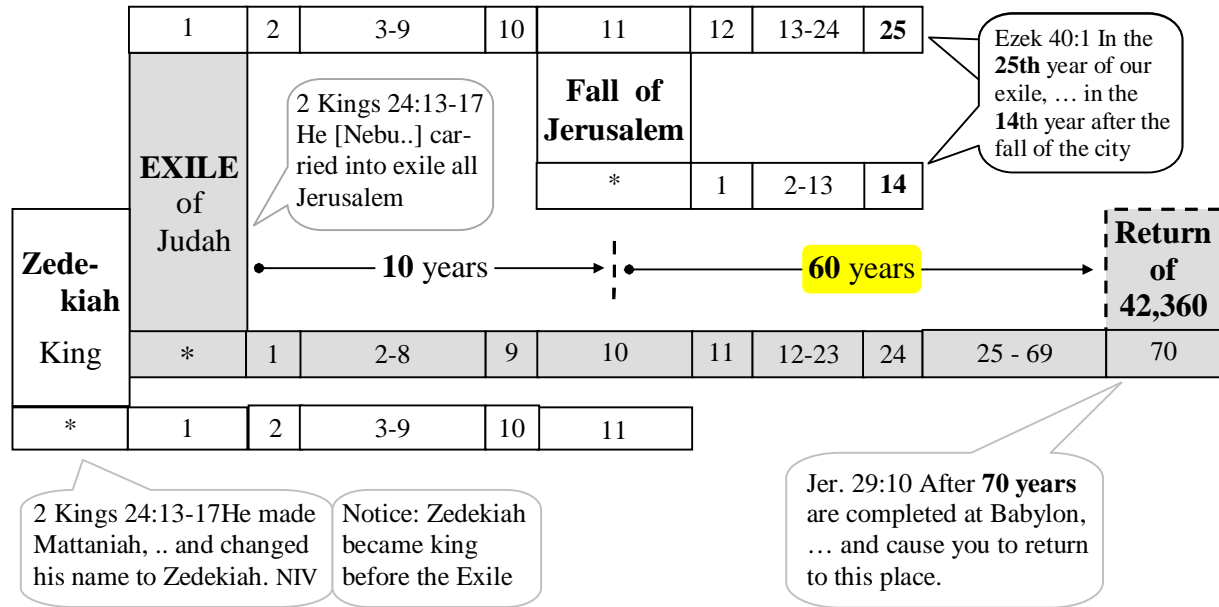

✓ Omri became king of Israel (and built Samaria) **100 years** after the Ark was brought in the Temple.

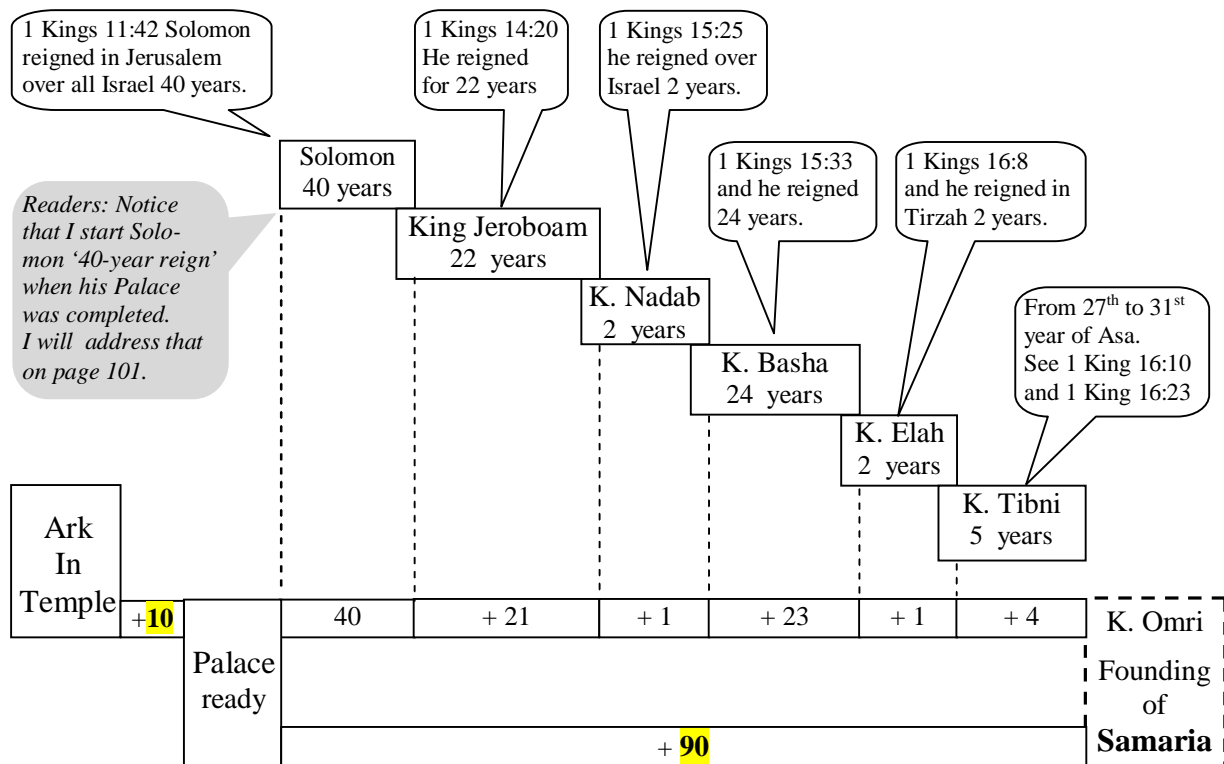

Using the information found up to now, we can deduce that there are 390 years between ‘the founding of Samaria’ and ‘the return of the exiles’. i.e. (430 + 60) - 100

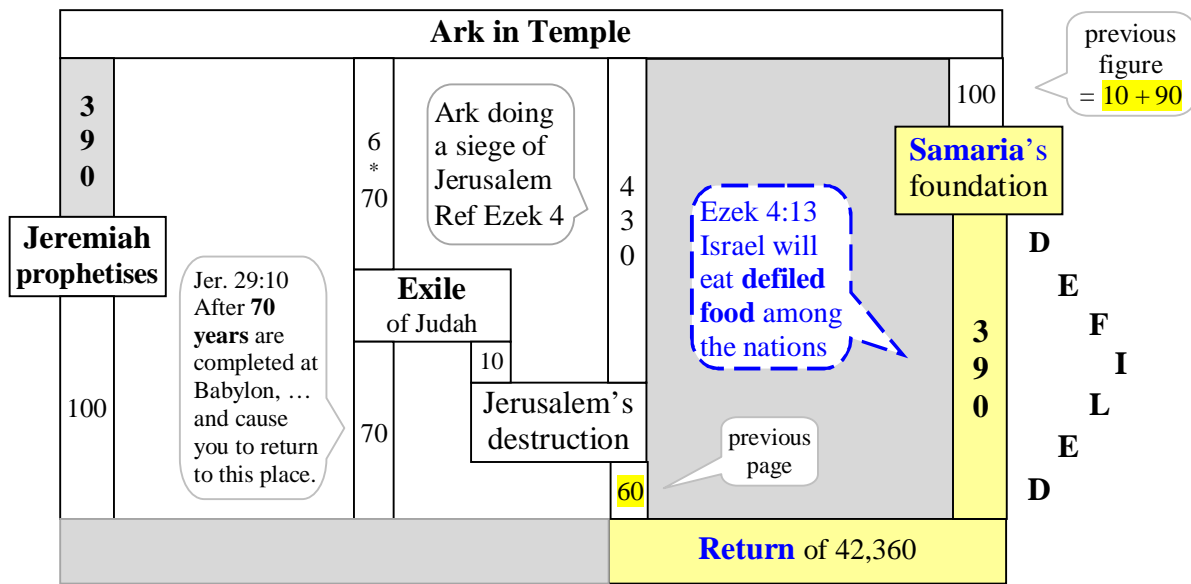

Figure 11. Defiled food

Initiating the period of 390 years with the foundation of Samaria is quite judicious. Samaria hadn't only become the capital⁶² of the northern kingdom it also became the seat of all the corruption that prevailed in Israel:

- Jer 23:13 "Among the prophets of Samaria I saw this repulsive thing: They prophesied by Baal and led my people Israel astray.

With the start of Samaria a new dynasty of kings (Omri, Ahab, Ahaziah, Jehoram [Joram]) began to reign over the people. They introduced changes that would have a profound effect on the people:

- 1 Kings 16:25 But Omri did evil in the eyes of the LORD and sinned more than all those before him.
- 1 Kings 16:30-32 Ahab son of Omri did more evil in the eyes of the LORD than any of those before him. He not only considered it trivial to commit the sins of Jeroboam son of Nebat, but he also married Jezebel daughter of Ethbaal king of the Sidonians, and began to serve Baal and worship him.
- 1 Kings 22:53 He [Ahaziah] served and worshiped Baal and provoked the LORD, the God of Israel, to anger, just as his father had done.
- 2 Kings 3:2 He [Joram son of Ahab] did evil in the eyes of the LORD,

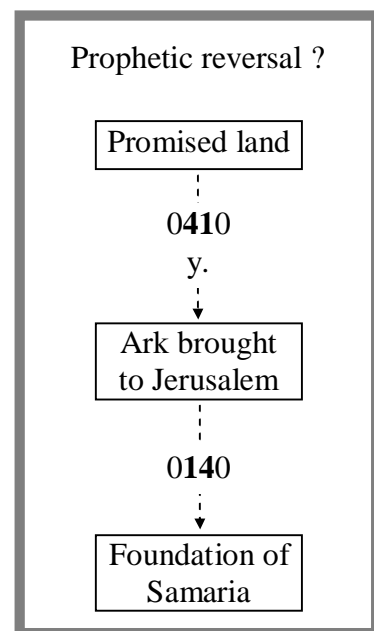

⁶² from then on Samaria would be the residence of all the kings of the northern kingdom until the Exile

Legacy of Omri's dynasty

New deity, New prophets, Corrupted shrines, A Temple of Baal in Samaria:

- Kings 18:18 "I have not made trouble for Israel," Elijah replied. "But you [Ahab] and your father's family [Omri] have. You have abandoned the LORD's commands and have followed the Baals.

Also Mic 6:16, Jer 3:6-7, 1 Kings 18:19, 2 Kings 17:29, 1 Kings 16:32

The corruption in Israel became so critical that it was almost impossible to hear the words of God anywhere in the whole territory. There came a time when there was only one prophet of God left:

- 1 Kings 18:22 Then Elijah said to them, "I am the only one of the Lord's prophets left,

Meanwhile Judah didn't do any better. Its land was also filled with corruption:

- 2 Kings 16:3 He [king Ahaz of Judah] walked in the ways of the kings of Israel and even sacrificed his son in the fire, NIV

Also 2 Kings 17:19, 21:3, Ezek 16:51, Jer 5:1, 11:13, 13:27, 32:34

Judah was also deceived by its prophets:

- Jer 4:10 "Ah, Sovereign LORD, how completely you have deceived this people and Jerusalem by saying, 'You will have peace,' when the sword is at our throats." NIV
- Ezek 22:26 Her priests have violated My law and profaned My holy things; they have not distinguished between the holy and unholy, nor have they made known the difference between the unclean and the clean; and they have hidden their eyes from My Sabbaths, so that I am profaned among them. NKJV

Also Jer 7:28, 8:10, 23:11, 23:21

The return of the exiles of Judah, whom had been away from their land for 70 years, brought an end to the 390 years of the 'defiled words'. The people were then offered a new start, their sins were forgiven and they received a new spirit:

- Jer 29:13-14 You will seek me and find me **when you seek me with all your heart**. I will be found by you," ... , "and will bring you back from captivity. NIV
- Ps 85:1-2 Lord, You have been favorable to Your land; You have brought back the captivity of Jacob. **You have forgiven the iniquity of Your people; You have covered all their sin.** NKJV
- Isa 45:8 "You heavens above, rain down righteousness; let the clouds shower it down. Let the earth open wide, let salvation spring up, **let righteousness grow with it;** NIV
- Ps 126:1-2 When the LORD brought back the captives to Zion, we were like men who dreamed. Our mouths were filled with laughter, **our tongues with songs of joy.** NIV

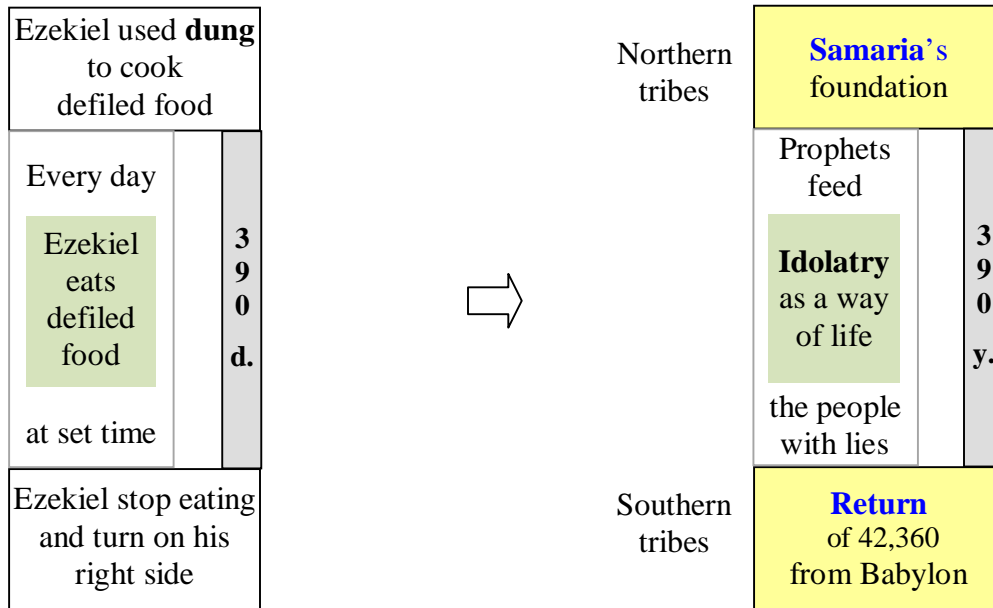

In Hebrew
Dung =
gelalim

Gelalim and **gullilum**
seems to share the
same hebrew origine

In Hebrew
Idols =
gullilum
(or gillulim)

The lower limit of the 390-year period of Ezekiel's defiled food is defined by the **founding of Samaria** (an event associated with the **northern tribes**) while the upper limit is defined by the **'return of the 42,360 exiles'** (an event exclusively associated with the **southern tribes**).

Some readers will object that we have failed to point to the right 390-year period given that the tribes involved at the start of this period are not the same tribes implicated at its end. Yet this argument doesn't invalidate our interpretation of Ezekiel 4:13. Symbolically, there has been people of the House of Israel (12 tribes) eating defiled food (hearing false word) during the whole period of 390 years.

A study of the 390 years, starting with the founding of **Samaria**, shows how some prophets introduced an evil system that spread from a single city and gradually reached all the land of two kingdoms (north and south). For hundreds of years, people of every tribes, showing an obvious lack of judgment, had been listening and believing false teaching, thus succeeding in alienating their one true God. Then they were sent into exile, one kingdom at the time. **The period of 390 years came to an end when the first exiles of one kingdom were allowed to return to their land and Jerusalem.**

The Israelites didn't need to go among other nations for the whole 390 years.

Some readers will also argue that Ezekiel 4:13 imply that the Israelites would have to eat their food (hearing lies) **among other nations for the whole 390-year period** and not, as I suggested, during only the 70-year portion of their Exile.

- Ezek 4:13 The LORD said, "In this way the people of Israel will eat defiled food among the nations where I will drive them." NIV

Although the objection is legitimate it cannot be retained for the following reason. When told about the way he should cook his food, Ezekiel protested vehemently and as a result, received 'partial' abatement for his assignment

- Ezek 4:15 "Very well," he said, "I will let you bake your bread over cow manure instead of human excrement." NIV

It is only logical that the events portrayed by this symbolical act should also reflect a convincing form of abatement. Thus, as we will see, the Israelites didn't need to go immediately abroad to eat the defiled food of other nations. For 320 years prior the 70-year exile, the other nations themselves came to Israel.

After the foundation of Samaria the Israelites were inclined to mix with other nations:

See 1 Kings 20:34

Hos 7:8-9 "Ephraim has mixed himself among the peoples; Ephraim is a cake unturned. Aliens have devoured his strength, But he does not know it; NKJV

Ahab's wife Jezebel, who was not an Israelite, brought with her the deity of her own nation and introduced the worship of Baal on a large scale in the northern kingdom. (It is quite conceivable that she brought also her own prophets with her when she came to Samaria.)

See 1 Kings 16:31

- 1 Kings 18:19 And bring the four hundred and fifty prophets of Baal and the four hundred prophets of Asherah, who eat at Jezebel's table."

See 2 Kings 10:32-33

- 2 Kings 15:29 In the time of Pekah king of Israel, Tiglath-Pileser king of Assyria came and ... NIV

Foreign armies also invaded Judah's territory and the people were subdued by those nations for years before being sent into captivity, thus sharing the same fate as their brothers from the northern kingdom. In the end, every Israelite, no matter which tribe, he belonged, was eating defiled bread on foreign soil:

- 2 Kings 16:7 Ahaz sent messengers to say to Tiglath-Pileser king of Assyria, "I am your servant and vassal.

See 2 Kings 23:33-34 & 2 King 24:1

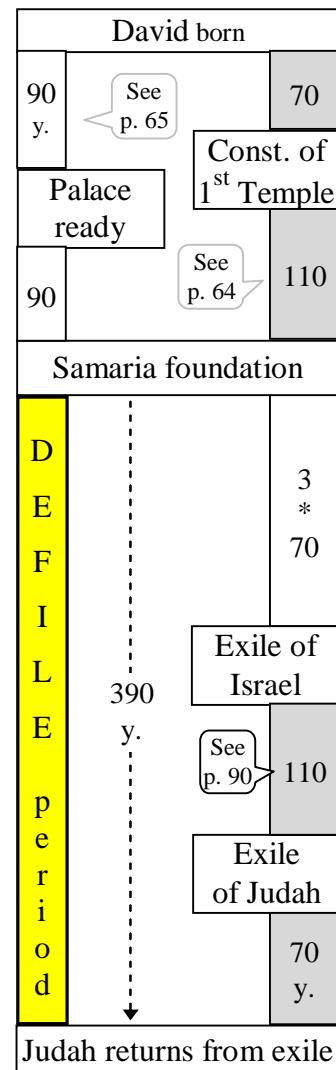

390 years of defiled food

(Ezekiel's symbolical act)

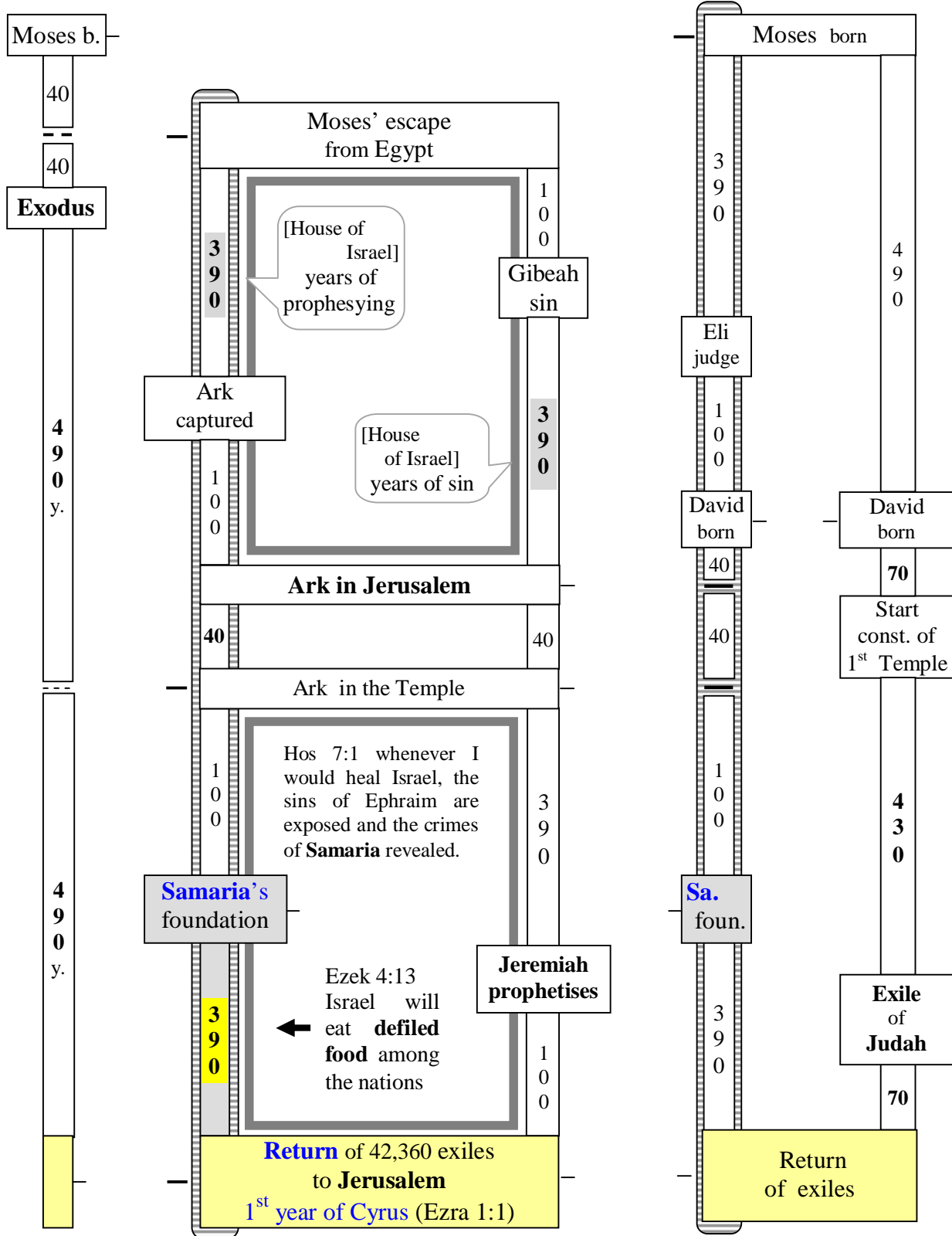

Figure 12. Ezekiel defiled food

The 430 years and 400 years countdown to Exodus

Anybody who has studied the Bible's chronology for some time will agree. There is only one way to obtain the date of the Exodus and it is by properly identifying the origin of the 430 years mentioned in Exodus 12:40 and in Galatians 3:17. These two verses are fundamental to the building of an elaborate and consistent chronology of the Bible.

- Ex 12:40-41 Now the sojourn of the children of Israel who lived in Egypt was four hundred and thirty years. ... all the armies of the LORD went out from the land of Egypt. NKJV
- Gal 3:17 What I mean is this: The law, introduced 430 years later, does not set aside the covenant previously established by God and thus do away with the promise NIV

In the following pages we will

1. identify the covenant alluded to in Galatians 3:17 **EVENT X**
2. determine the right date for the Exodus,
3. and finally find out what happened 400 years before the Exodus. **EVENT Y**
 - Gen 15:13 and they will be enslaved and mistreated four hundred years. NIV

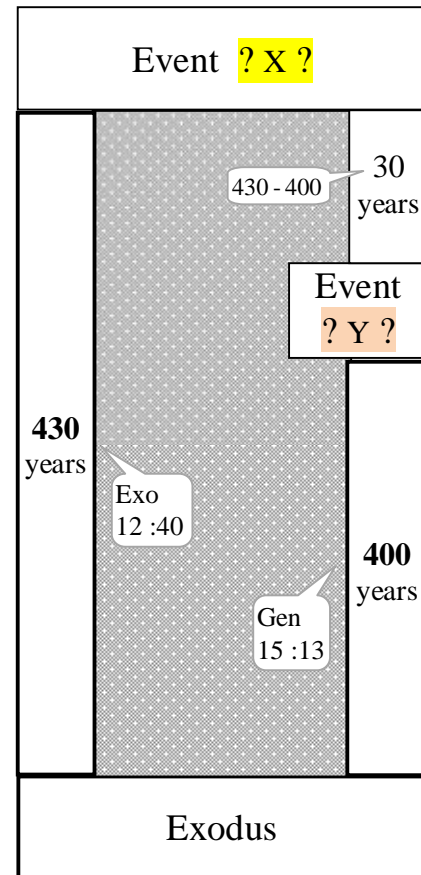

The Exodus started when the Israelites left Egypt and according to Exo 12:40 it was at the end of a period of 430 years⁶³. The verse doesn't say anything about the beginning of the period. Fortunately, we are not left without a clue as Galatians 3:17 supplies us with an important clarification: the 430-year period originated at the time of a covenant. In Galatians 3:16, one verse before, we learn that the covenant was known to Abraham, the first patriarch of Israel.

- Gal 3:16 Now to Abraham and his Seed were the promises made. NKJV

Our initial approach will be to build a timeline of the important events in Abraham's life. One of those events is more likely to have triggered the 430-year countdown to the Exodus. We have to keep in mind that we don't know yet if we are looking for a covenant that was enunciated, confirmed or activated.

⁶³ Here many people have been lured into thinking that the Israelites spent the whole 430 years in Egypt. Even though the verse seems to say so it wasn't the case and we will see later that there is an alternate way to understand Ex 12:40.

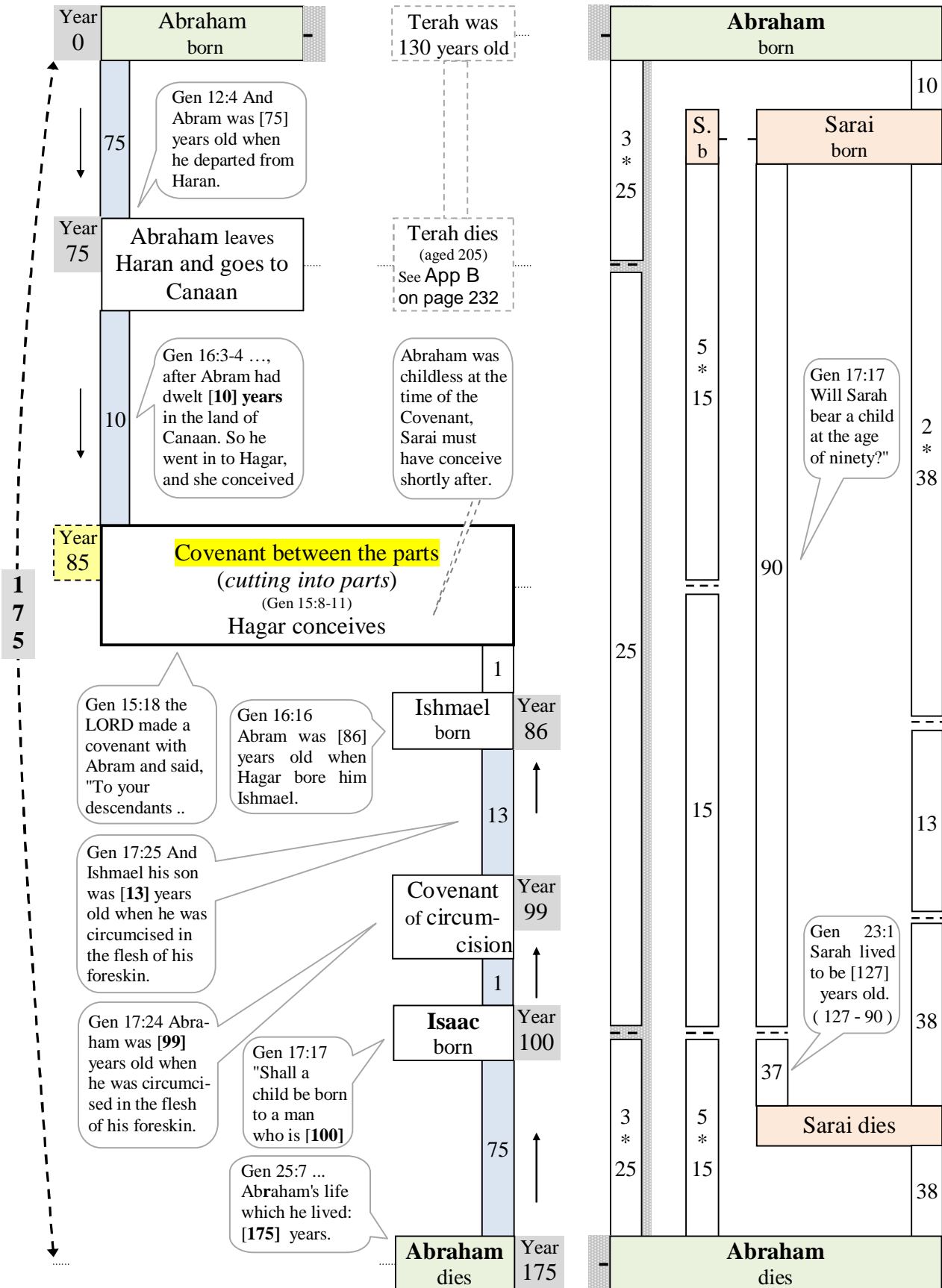
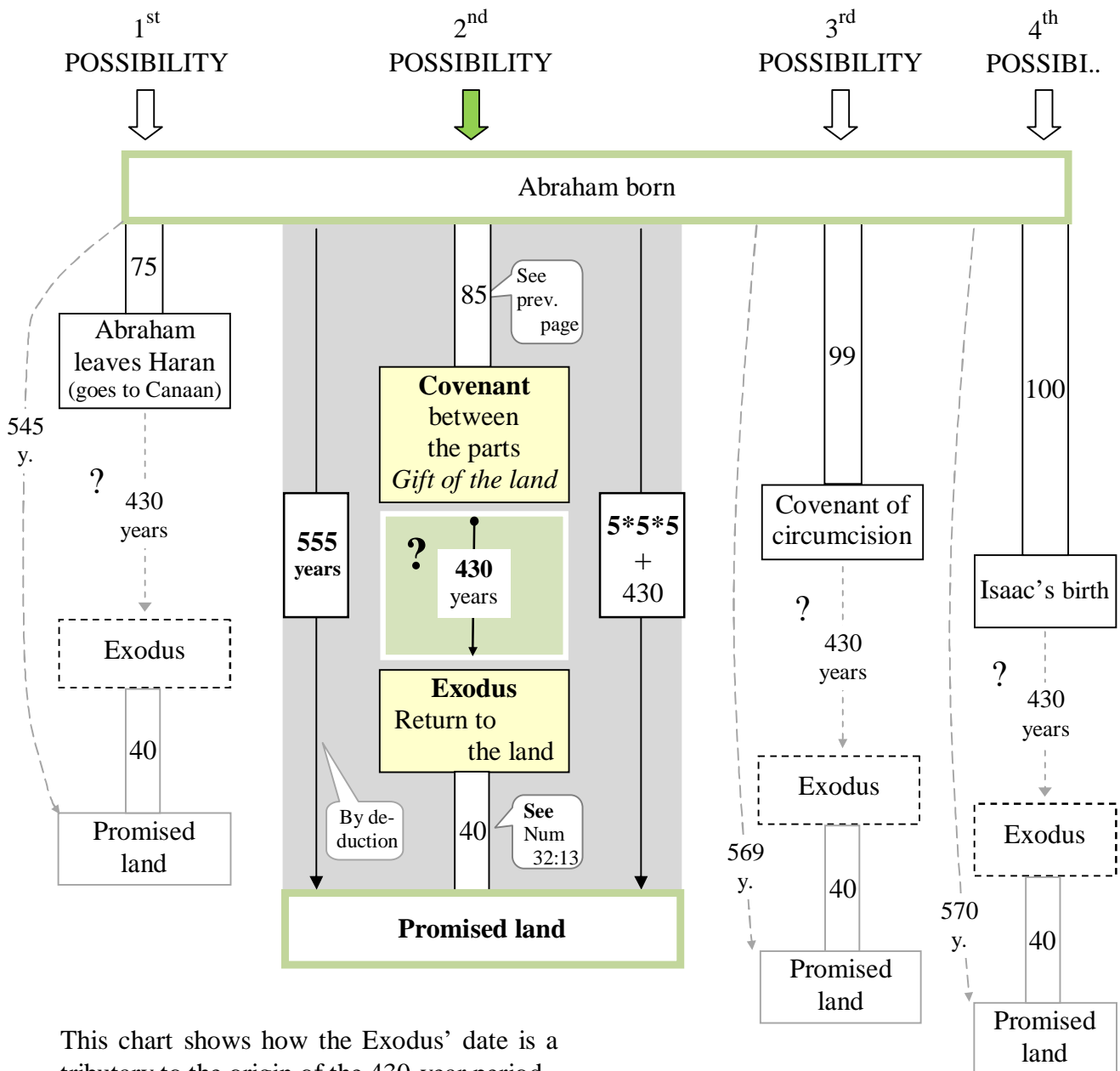

Figure 13 Abraham timeline

Should we start the 430 years ... (see the previous figure for references)

- ⇒ **When** Abraham left Haran at age 75? He was certainly obeying God in doing that.
- ⇒ **When** Abraham received the covenant between the parts (Land being given) at age 85? This is the first time a sign is introduced to confirm that the land will be given (the cutting into part, Gen 15:8-11).
- ⇒ **When** Abraham was circumcised at age 99? By marking his own flesh and the flesh of his people Abraham was ratifying a very special agreement with God.
- ⇒ **When** 100-year-old Abraham became the father of Isaac? This was the fulfillment of a promise received the previous year and the beginning of an important dynasty.

Only one possibility can be right, and one looks more promising already.



This chart shows how the Exodus' date is a tributary to the origin of the 430-year period.

Intuitively, it seems right to start the 430 years leading to the Exodus at the ‘Covenant between the parts’ when the land was given. One could say that the period started with God’s promise to give the land (and the covenant that goes with it), and ends 430 years later with the return of million of people to that land after escaping slavery in Egypt.

--- Unfortunately, that argument wouldn’t be strong enough to convince everyone that those events are absolutely complementary. But there is more...

Have you noticed that the strange ritual performed by Abraham when he learned of the covenant between the parts (cutting into parts), was echoed in several points at Exodus? Look at the following two events and compares **A & A’ B & B’ C & C’ D & D’**

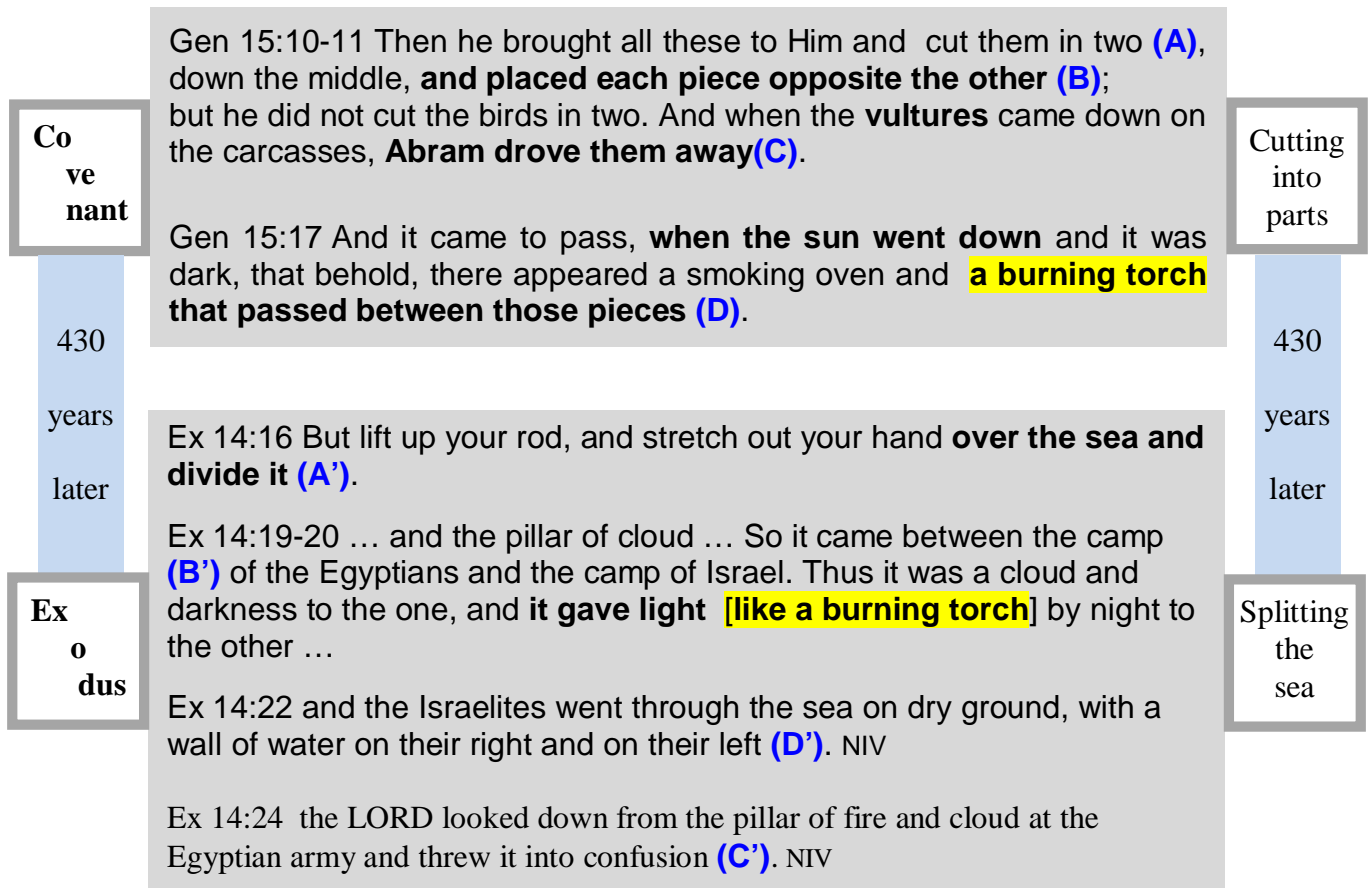

| Cutting into parts | | Exodus |
|--|---------------|--|
| Abraham cut the animals in two | A - A' | Moses splits the sea in two |
| Abraham placed the pieces opposite to each other | B - B' | the camp of Israel faced the camp of the Egyptians |
| Abraham drove away the vulture | C - C' | God threw the Egyptian army in confusion. |
| A burning torch passed between the pieces | D - D' | pillar of fire following the Israelite while they crossed the split sea. |

A journey that lasted 430 years (in 6 steps)
(Covenant between the parts to Exodus)

(1) For the first time Abraham received a covenant

- Gen 15:18 On the same day the LORD made a covenant with Abram, saying: "To your descendants I have given this land, from the river of Egypt to the great river

(2) that was accompanied by a **sign**

- Gen 15:9-10 So He said to him, "Bring Me a three-year-old heifer, a three-year-old female goat, a three-year-old ram, a turtledove, and a young pigeon." Then he brought all these to Him and cut them in two, down the middle, and placed each piece opposite the other; but he did not cut the birds in two. NKJV

(3) And in order to inaugurate (and seal) this covenant, **God blazing torch went through the animal parts.**

(4) **And 430 years went by**

- Ex 12:40-41 Now the sojourn of the children of Israel who lived in Egypt was four hundred and thirty years. ... all the armies of the LORD went out from the land of Egypt.

NOTE: Ex 12:40 seems to say that the children of Israel lived in Egypt for 430 years but with the proper punctuation the expression 'who lived in Egypt' become a distinctive mark that should be associated with the 'children of Israel' rather than the 'sojourn'.

➔ Now the sojourn of the children of Israel, who lived in Egypt, was 430 years...

Here the word used by the translators to describe what the children of Israel were doing for 430 years is 'sojourn' (or 'dwelling'). Wouldn't the text be better served with a word like 'journey'?

➔ Now the 'journey' of the children of Israel, who lived in Egypt, was 430 years...

(5) God remembered the covenant and was ready to give the Israelites their land:

- Ex 6:4-5 I have also established My covenant with them, to give them the land of Canaan, the land of their pilgrimage, in which they were strangers. And I have also heard the groaning of the children of Israel whom the Egyptians keep in bondage, and I have remembered My covenant. NKJV
- Ex 6:8 and I will give it to you as a heritage NKJV

(6) Prior receiving the object of the covenant⁶⁴ that was sealed when God went through the parts, the Israelites **went through the sea, which had been physically split**. (We have here a clear reminder of the true origin of this covenant.)

- Ex 14:16 But lift up your rod, and stretch out your hand over the sea and divide it. And the children of Israel shall go on dry ground through the midst of the sea. NKJV

⁶⁴ that is : the land

The Exodus also echoed another event that occurred during the very same year of the covenant between the parts.

The second event: Hagar's pregnancy

| | |
|-----------------------|--|
| H A G A R | <p>An (A) <u>Egyptian slave</u> was (B) <u>mistreated</u> by her (C) <u>Hebrew mistress</u>. She (D) <u>fled</u> into the (E) <u>desert</u> where she was met by an (F) <u>angel</u> while she rested near a (G) <u>spring</u> on the road to (H) <u>Shur</u> .</p> <ul style="list-style-type: none"> Gen 16:6-7 " Then Sarai mistreated Hagar; so she fled from her. The angel of the LORD found Hagar near a spring in the desert; it was the spring that is beside the road to Shur NIV |
|-----------------------|--|

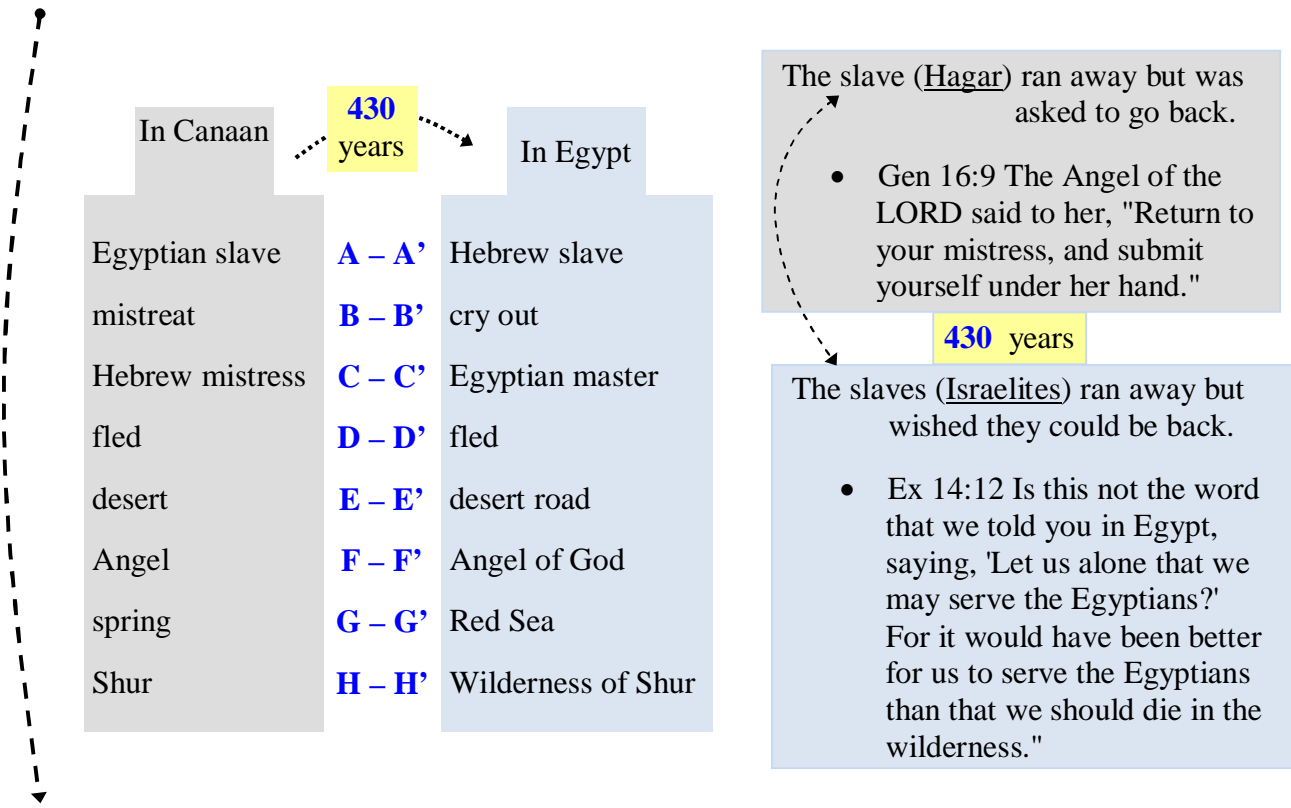

| | |
|----------------------------|--|
| E X O D U S | <ul style="list-style-type: none"> Ex 3:7 "I have indeed seen the misery of my people [A' <u>Hebrew slave</u>] in Egypt. I have heard them B' <u>crying out</u> because of their slave drivers [C' <u>Egyptian master</u>], and I am concerned about their suffering. Ex 13:18 So God led the people around by the E' <u>desert</u> road toward the <u>Red Sea</u>. Ex 14:5 When the king of Egypt was told that the people D' <u>had fled</u>, Ex 14:19 Then the F' <u>angel of God</u>, who had been traveling in front of Israel's army, withdrew and went behind them. Ex 15:22 So Moses brought Israel from the G' <u>Red Sea</u>; then they went out into the H' <u>Wilderness of Shur</u>. |
|----------------------------|--|

A subordinate journey that lasted 400 years

(From Akedah to Exodus)

With the link between ‘Covenant between the parts’ and ‘Exodus’ now established we are well positioned to determine with absolute certainty the origin of the 400 years of Gen 15:13.

- Gen 15:13 Then He said to Abram: "Know certainly that your descendants will be strangers in a land that is not theirs, and will serve them, and they will afflict them **four hundred years**. NKJV

Knowing that this period ended at the Exodus, it is a simple matter to go backwards 400 years and see where it brings us. From the previous material we deduce that Isaac was 15 at that time, which in itself is a non event and wouldn't qualify as a meaningful start for the 400 years. But suppose Isaac was 15 years old when he was sacrificed by Abraham! (The Jews refer to this event as ‘the binding of Isaac’ and call it by the Hebrew word ‘AKEDAH’)

The Bible doesn't give any direct chronological link to Isaac's binding. Isn't it surprising when we think about it? Isn't it quite inconceivable that the biggest act of obedience and faith ever described in the Bible, the most important symbolic act, an act that would be mirrored at Yeshua's death, wouldn't be accurately dated when more than 300 chronological references are available to chart all kinds of other events? Isn't it possible that the 400-year period had its origin in the year of Isaac's binding? Is there any other event that could be more meaningful to mark the beginning of this important period?

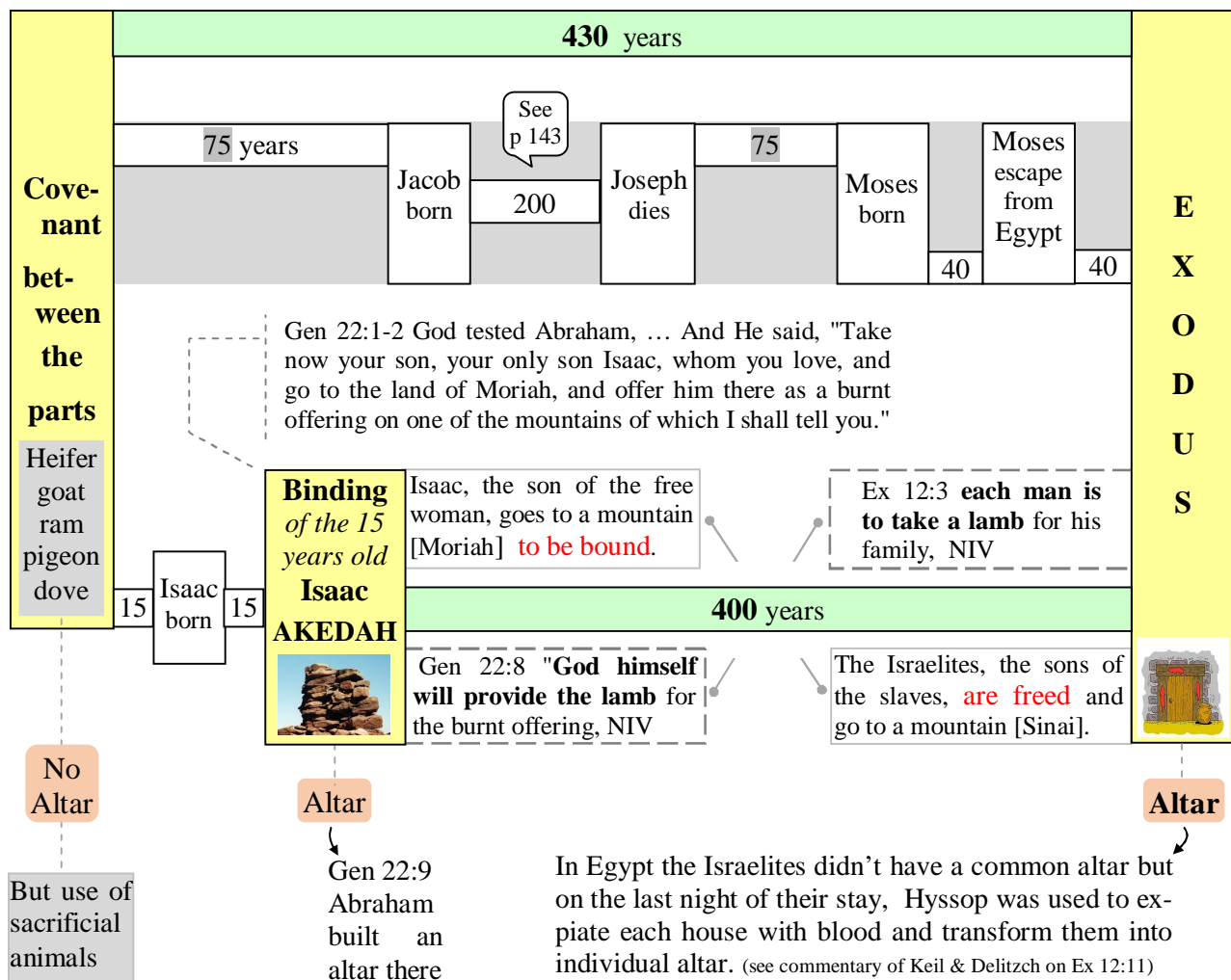

In Gen 15:13 we are told that the 400-year period has to do with the whereabouts of Abraham's descendant. It goes without saying that we should have argued that Isaac's birth, the first Abraham's legitimate son, was the rightful event to start the 400-year period. Unfortunately the preceding chart shows that it is not possible, Isaac was already 15 years old when the 400-year period started. This is why the 'binding' of Isaac is the next best choice if not in fact a better one? Here is why.

First a few facts to show that Isaac was neither an infant nor an adult at the time of the binding. One can say that at 15 years old, he was in the right age range.

Old enough to worship

- Gen 22:5 We will worship and then we will come back to you." NIV

Strong enough to hold all the wood

- Gen 22:6 Abraham took the wood for the burnt offering and placed it on his son Isaac, NIV

Still young enough to be called "boy"

- Gen 22:5 He said to his servants, "Stay here with the donkey while I and the boy go over there. NIV

NOTE: w^ahana`ar the Hebrew word translated here as "the boy" could describe Isaac any period from the age of infancy to adolescence.

We are told that God would establish a covenant with Isaac.

- Gen 17:19 I will establish My covenant with him [Isaac] for an everlasting covenant, and with his descendants after him. NKJV
- Gen 17:21 1 But My covenant I will establish with Isaac, NKJV

We are also told that Abraham and Isaac would be involved (together?) in a covenant and a promise.

- 1 Chron 16:16 The covenant which He made with Abraham, And His oath to Isaac, NKJV
- Ps 105:9 the covenant he made with Abraham, the oath he swore to Isaac. NIV

We know that a covenant was confirmed to Abraham at Akedah.

- Gen 22:15-17 The angel of the LORD called to Abraham from heaven a second time and said, "I swear by myself, declares the LORD, that because you have done this and have not withheld your son, your only son, I will surely bless you.. NIV

Could it be that Isaac was also chosen during Akedah?

Isaac's relationship with his father Abraham culminated at Akedah. The only bonding activity between them that was ever documented in the Bible was the three days' journey to Mt. Moriah. During this trip Abraham's sadness must have been almost unbearable. How could it have been different? He had just been asked to do the most difficult thing ever: to show his

unfaltering obedience to God by voluntarily killing the unexpected son of his old age, the only son he shared with Sarai, a son that he loved⁶⁵ very much. At age 15, Isaac was old enough to understand what was going on and if he had ever witnessed his father making a sacrifice to God in the past, he must have sensed that this time something was quite different.

- Gen 22:7 "The fire and wood are here," Isaac said, "but where is the lamb for the burnt offering?"

Whether he had known for some time or had only learned at the last minute that he would be the victim, it didn't make any difference. Isaac never offered any resistance and he followed his father unrestrained, to the top of the mountain where an altar would be built.

- Gen 22:5 Stay here with the donkey while I and the boy go over there.

Thirty years after the Covenant of the land Abraham was 115 years old (see Figure 13 Abraham timeline on page 77) and would never have been able to bind his 15 year old son if he had refused to cooperate. Isaac was a consenting victim who could have found many opportunities to run away, but he didn't. On the contrary, he even walked the last stretch to the altar by himself.

- Gen 22:9 He bound his son Isaac and laid him on the altar, on top of the wood.

The sacrifice of Isaac was a request so well chosen that it allowed Abraham and Isaac to independently prove their worth to God at the same time.

- ❖ Abraham proved himself by offering his son in sacrifice.
- ❖ Isaac proved himself by accepting to be the sacrifice.

At Akedah Isaac didn't object to his father's plan and he totally accepted that he would die. In fact, he came so close to death that one can say that symbolically he did die. But then, if there was a symbolic death, it had to be followed by a symbolic resurrection and the opportunity of a new beginning. That day Isaac inherited his father's covenant.

- Gen 15:13 Then He said to Abram: "Know certainly that your **descendants** will be **strangers** in a land that is not theirs, and will serve them, and they will afflict them **four hundred years**. NKJV

The only remaining question before one can fully accept that Akedah is at the origin of the 400-year period is the following. Did Isaac, the new born descendant, begin this new journey by being a stranger in a land that was not his? The answer is: Absolutely! Have you noticed that Isaac never returned home with his father?

- Gen 22:19 Then Abraham returned to his servants, and they set off together for Beersheba. And Abraham stayed in Beersheba. NIV

In fact it will take 25 years before we hear about Isaac again. Gen 24:62 tells us that he has been living in the Negev and he is about to meet his future wife.

⁶⁵ Gen 22:2 "Take your son, your only son, Isaac, whom you love,

Abraham leaves Haran and goes to Canaan

Abraham went for a 3 days journey to offer a sacrifice . Gen 21:4

The 400 years of Gen 15:13

40

Binding of Isaac

Instead of dying during the sacrifice, Isaac was saved at the last second. This symbolic **rebirth** is the most appropriate start for the **400 years** found in:

Heb 11:19 Abraham reasoned that God could raise the dead, and figuratively speaking, he did receive Isaac back from death.

Gen 15:13 "Know certainly that your **descendants** will be strangers in a land that is not theirs, and will serve them, and they will afflict them **400 years**."

Gen 28 :3 May God Almighty bless you and make you fruitful and increase your numbers **until** you **become** a **community of peoples**

To God, the **whole community of Israel** is viewed as a **firstborn** son: Ex 4:22-23 Israel is my firstborn son, and I told you, "Let my son go

400 y.

The **'rebirth'** of Isaac

leads to the

birth of Israel

The **'women giving birth'** symbol. On the night before they left Egypt, the Israelite's houses became like the womb of pregnant women ready to give birth after 40 weeks. (40 w. VS 400 y.)

While the first born of the Egyptian were dying, those of the **Israelites** were miraculously protected. Figuratively speaking and similar to Isaac, one can say that they were also received **back from the dead**.

1. Pharaoh had increased the people's labor. Ex 5:9
2. In Ex 3:10 Moses is told to bring them (i.e. Abraham's descendants, see Gen 15:13) out of Egypt || When water breaks, a woman knows the birth of her child is near.
3. Men waited with the loins girded (legs free) Ex 12:11
4. Eating in haste Ex 12:11, (impending event). Unleavened bread picturing the urgency of the situation and the lack of time for the leavening process.
5. Through Egypt **'wailing'** was heard Ex 11:6 || Period of active labor for a woman
6. Nobody would leave his house before the appointed time Ex 12:22 || delivery's time cannot be shorten
7. Early in the morning, people went out through a **bloody entrance**. Ex 12:7 || Birth of the child
8. That day God delivered the nation Ex 14:13 || The midwife helps the baby during the birth
9. Any meat left over had to be completely burned before the morning (Ex 12:10) . || Women's afterbirth need to be disposed of (buried or burned).
10. That morning the Egyptians gave the Israelites women pieces of clothing for their children. Ex 3:22
11. The day, similar to a child birthday, would be commemorated in the future Ex 13:3
12. For many years afterward, God took care of his children and feed them in the desert. Ex 8:16

Metaphor of a child delivery

- 1 Labor increase
- 2 Water breaks
- 3 free the legs
- 4 Impending event
- 5 Wailing
- 6 Appointed time
- 7 Bloody exit
- 8 Delivery
- 9 Disposal of afterbirth
- 10 Gift received
- 11 Day to remember
- 12 Nursing the baby

Exodus

40

Nation of Israel comes to the Promised Land

Moses requested an authorization to make a 3 days journeys to offer a sacrifice. Ex 3:18

The child delivery metaphor took place on the vey night every Egyptian first born died.

The 430 years and 400 years countdown from Exodus

Covenant between the parts
Gen 15:18 To your descendants I give this land



(Cutting Into 2- parts
Gen 15:10)



| | | |
|-------------------------------|-----------------------------------|-----------------------------------|
| A covenant involves 2 parties | God binding part of the covenant | A covenant involves pouring blood |
| | Abraham binding part of the cov.. | |

Blazing torch
Gen 15:17



Gen 22:10

Fire on the altar
Gen 22:9



Binding of Isaac 'Akedah'



430

Ex 12:40 Now the sojourn of the children of Israel who lived in Egypt was **430** years.

Gen 15:13 and they will be enslaved and **mistreated 400** years.

Isn't Isaac's **binding** the most obvious way to start this 400 years of 'mistreatment'?

Exo.14:16

Pillar of fire
Exo 14:24



EXODUS
(Cutting the sea in 2 parts)



on P. 181

60

60

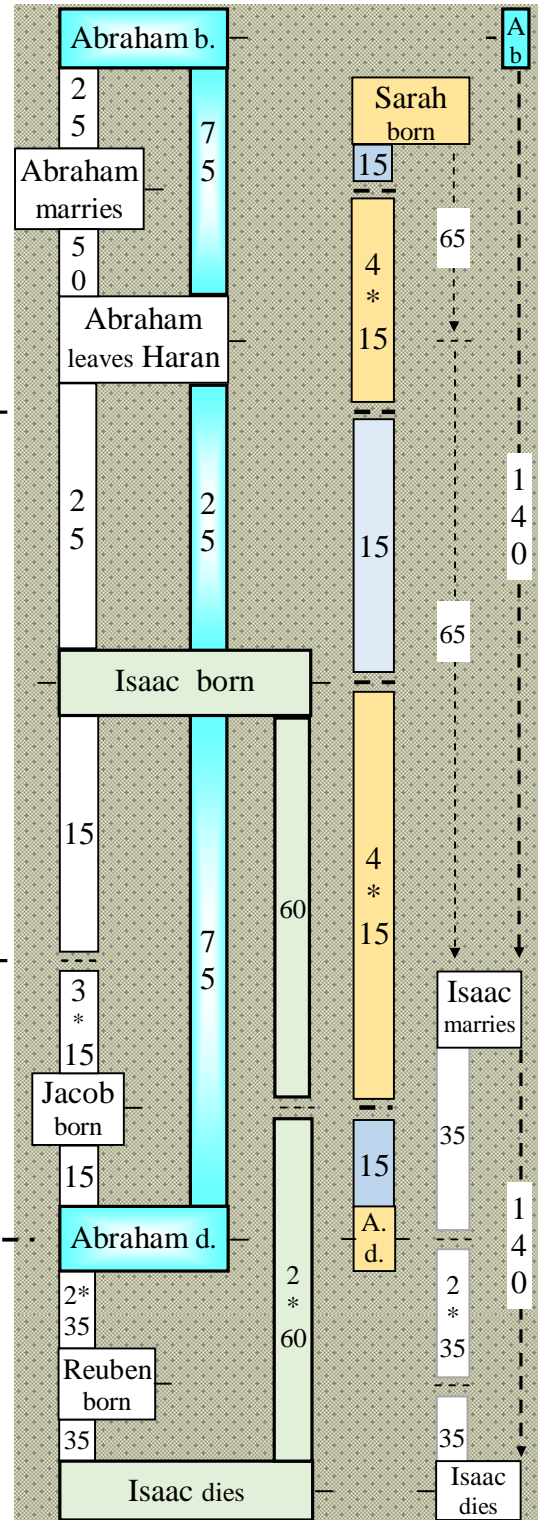

Rebirth of Isaac
Israel becomes God **firstborn**

Awesome complementarity
between 4 periods
portrayed by Ezekiel

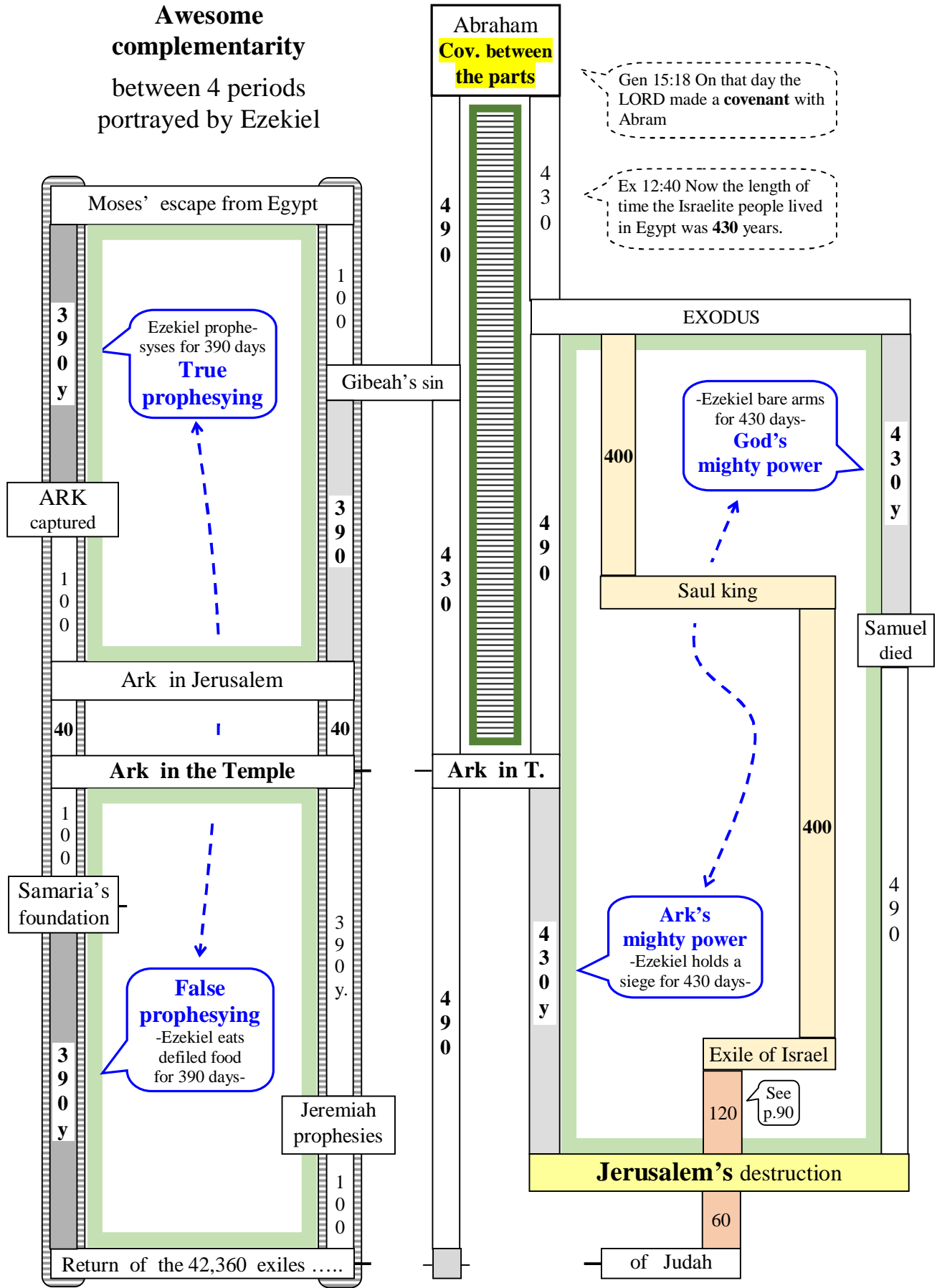

Figure 14. Covenant between the parts

Ezekiel shaves his hair

Ezek 5:1-3 "And you, son of man, take a sharp sword, take it as a barber's razor, and pass it over your head and your beard; then take balances to weigh and divide the hair. You shall burn with fire one-third in the midst of the city, when the days of the siege are finished; then you shall take one-third and strike around it with the sword, and one-third you shall scatter in the wind: I will draw out a sword after them. NKJV



We learn in Ezekiel 5:12 that everything that was done with the hair (i.e. Burn, Strike, Scatter) would also be done to the population of Jerusalem:

- Ezek 5:12 One-third of you shall die of the pestilence, and be consumed with famine in your midst; and one-third shall fall by the sword all around you; and I will scatter another third to all the winds, and I will draw out a sword after them. NKJV

The purpose of having Ezekiel shave his hair was to use the hair to show how the people of Jerusalem would be punished. The whole action could have been done without interruption right after Ezekiel's 430-day siege.

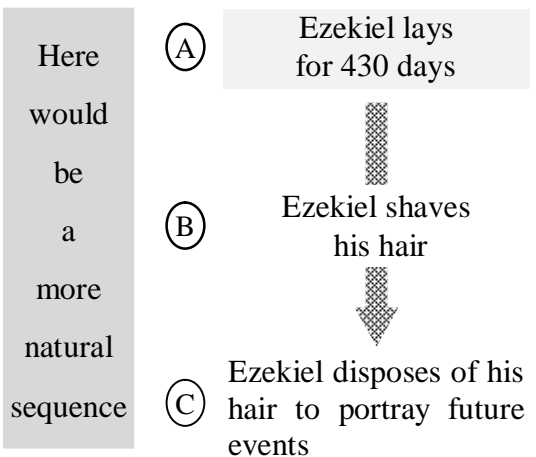

Unexpectedly it was done in a different way.

Ezekiel was told to shave all his hair and (see Ezek 5:2) wait until the end of his siege before using the hair to portray future events. Why can we be confident that it was done in that order? Because there wouldn't have been any point in telling him to wait until the end of his siege to burn the hair if that siege had already been mimicked.

Ezek 5:2 You shall burn with fire one-third in the midst of the city, **when the days of the siege are finished**; NKJV

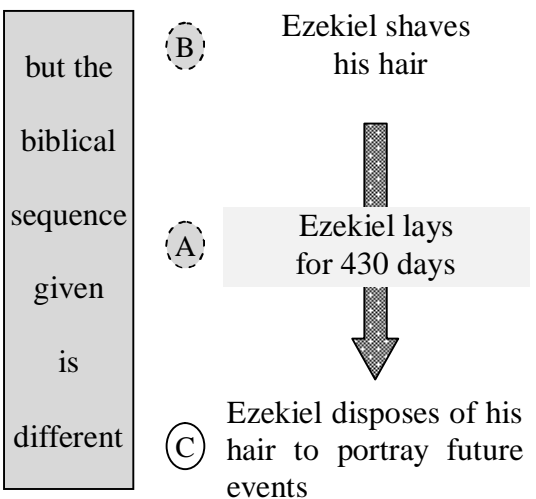

Why was a ‘delay of 430 days’ introduced between the shaving and the disposing of the hair? What could possibly justify that the shaving was done so early and the ‘disposing’ so later? In this paper, we have previously seen that many symbolic acts took place at the beginning of Ezekiel’s siege. Was there also a symbolic act associated with the ‘shaving’ itself? Yes.

In order to find out where the ‘shaving action’ is meant to lead us, we first need to understand how deeply humiliating the shaving of his head and beard must have been felt by Ezekiel:

- Lev 21:5-6 They shall not make any bald place on their heads, nor shall they shave the edges of their beards nor make any cuttings in their flesh. They shall be holy to their God NKJV
- 2 Sam 10:4-5 Therefore Hanun took David's servants, shaved off half of their beards, cut off their garments in the middle, at their buttocks, and sent them away. When they told David, he sent to meet them, because the men were greatly **ashamed**. And the king said, "Wait at Jericho until your beards have grown, and then return." NKJV

To have his beard and hair shaved was a **humiliating** experience for a priest and even though he was only performing a symbolic act there is no reason to believe that Ezekiel would have felt differently at the start of his 430-day siege. The keyword to understand this new symbolic act is ‘humiliation’. We have to find a period of 430 years, initiated by an event that turned out to be greatly humiliating for the whole House of Israel. This event can be found without too much difficulty for it had a tremendous effect on the Israelites:

It is the **capture of the Ark** by the Philistine (1 Sam 4:10-11):

- 1 Sam 4:13 And when the man came into the city and told it, all the city cried out.

What should have been a day of victory for the people of Israel turned out to be a day of great stupefaction, confusion and humiliation. This was prophesied earlier by Samuel:

- 1 Sam 3:11 Then the LORD said to Samuel: "Behold, I will do something in Israel at which both ears of everyone who hears it will tingle⁶⁶. NKJV



The daughter of Eli, who gave birth that day, named her child in relation to this event:

- 1 Sam 4:21 Then she named the child Ichabod, saying, "The glory has departed from Israel!" because the ark of God had been captured

Notice here the perfect relationship between

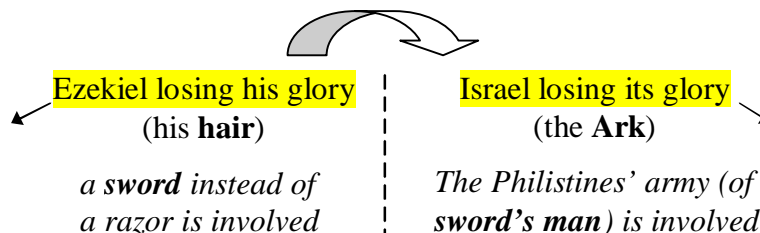

⁶⁶ According to Strong’s definition (6750) tingle carries the idea of ‘vibration’ of the ears in reddening with shame.

Searching for the end of the 430 years 'shaving act'

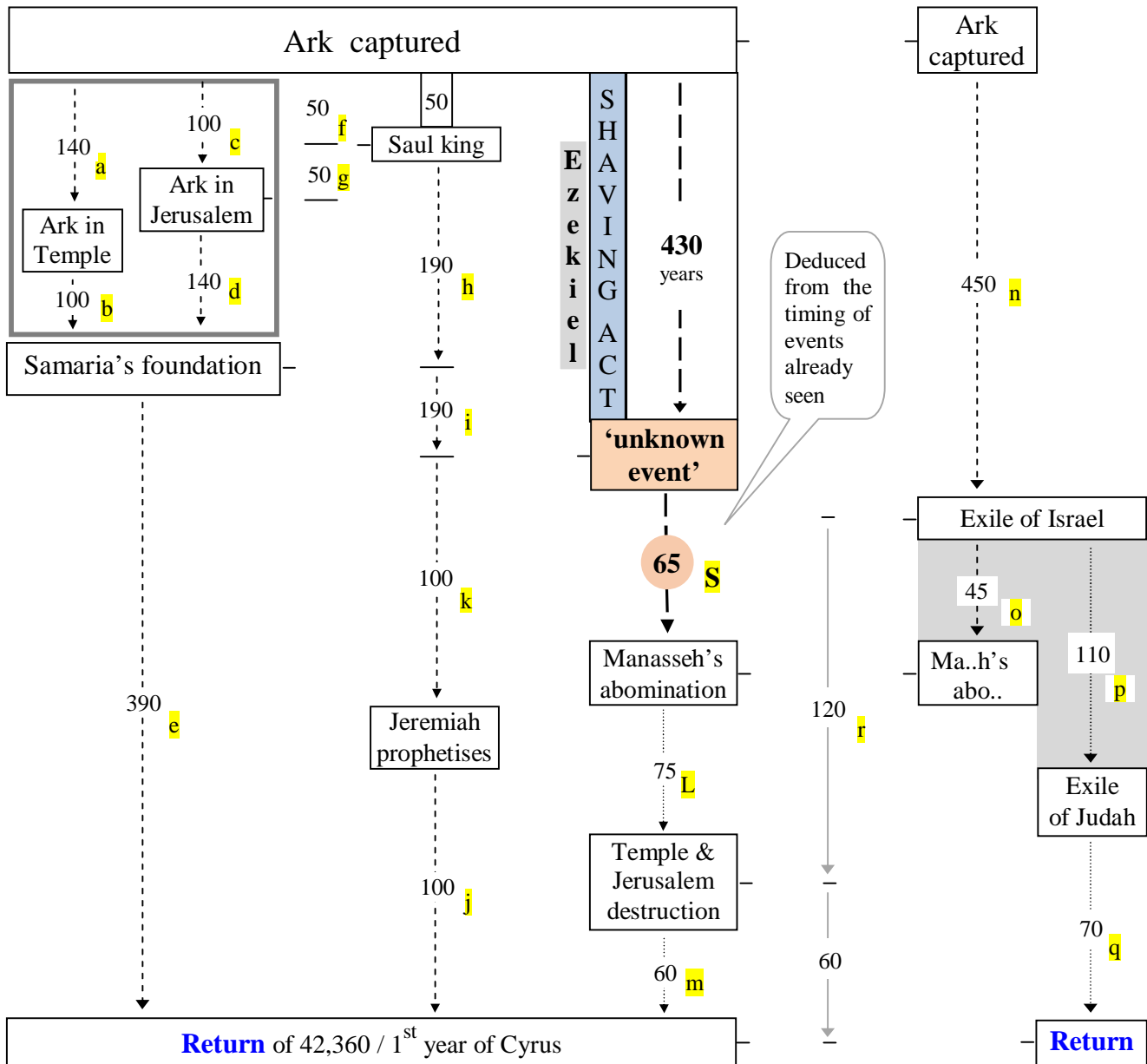

Figure 15. Shaving act

References:

- | | | | | | |
|----------|----------------------|----------|------------------------|----------|-----------------------|
| a | See on page 62 | i | 430 – f50 – h190 | o | see page 91 |
| b | See on page 64 | j | see page 71 | p | see page 91 |
| c | See on page 75 | k | e 390 – i 190 – j 100 | q | see page 70 |
| d | See on page 75 | L | see page 60 (40 + 35) | r | o45 + L75 |
| e | See on page 75 | M | see page 70 | S | a 140 + b 100 + e 390 |
| f | See on page 62 | n | see page 87 | | - 430 – L 75 – m 60 |
| g | C100 – f50 | | (100 + 40 + 430 – 120) | | |
| h | c 100 + d 140 – f 50 | | | | |

In the preceding figure we have established that the end of the '430-year period' symbolized by Ezekiel's shaving, happened 65 years before Manasseh's desecration of the Temple. This 65-year connection would be meaningless if there was not a possibility that it is the very same period referred by Isaiah in this important prophecy

Unknown event

65 y.

Manasseh's abomination

Isaiah's foretelling

65 y.

Ephraim shattered

- Isa 7:8-9 Within **sixty-five years** Ephraim will be too shattered to be a people. The head of Ephraim is Samaria, and the head of Samaria is only Remaliah's son. NIV

The following figure shows that Isaiah's prophecy (referred by me as Isaiah's foretelling) was told, very likely, 65 years before the Temple's desecration by Manasseh. The prophecy was told at the beginning of king Ahaz's kingship in answer to the threat represented by king Pekah.

- Isa 7:3-4 Then the LORD said to Isaiah, "Go out, you and your son Shear-Jashub, to meet Ahaz at the end of the aqueduct of the Upper Pool, on the road to the Washerman's Field. 4 Say to him, 'Be careful, keep calm and don't be afraid. NIV

And it could not have been told after the 20th year of Pekah given that this king reigned only 20 years.

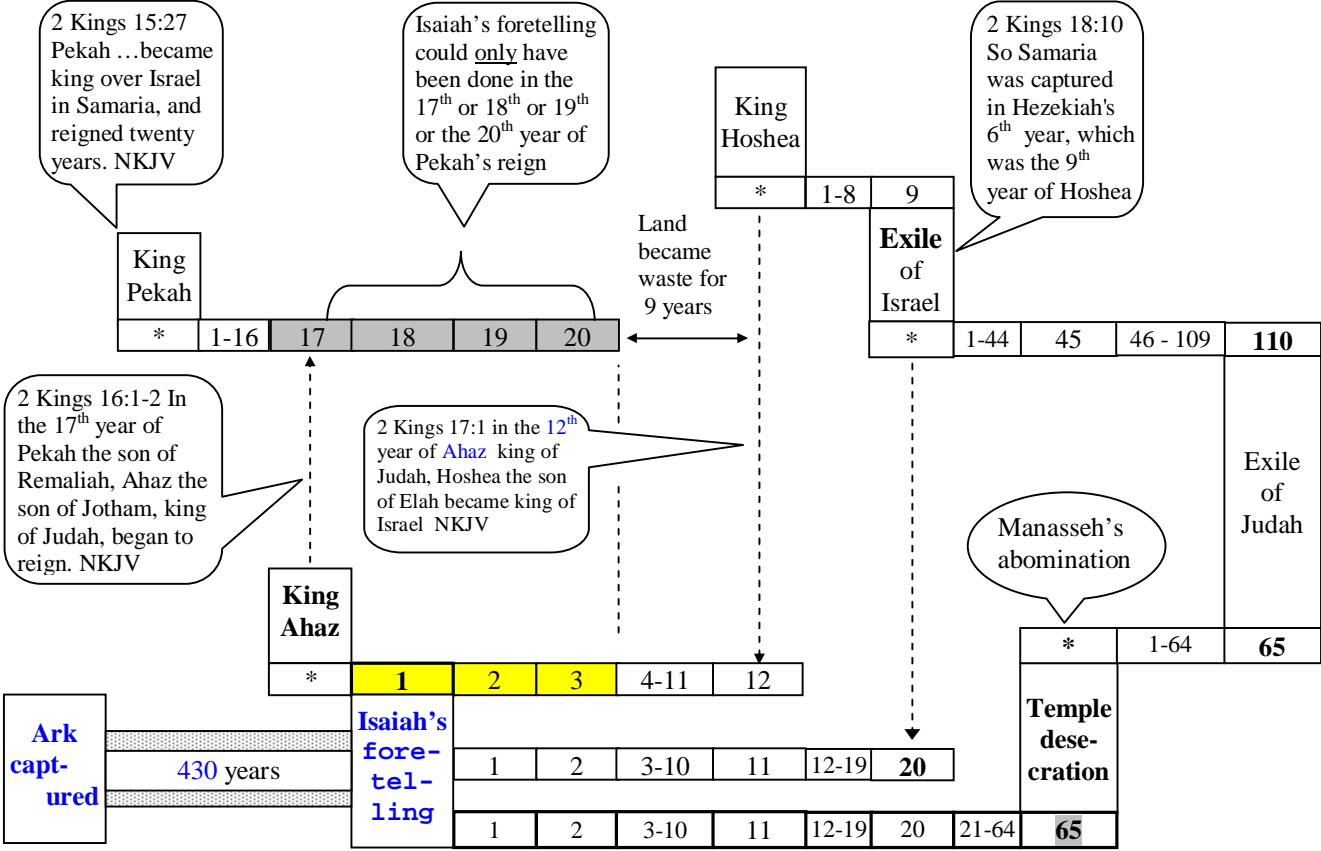

In the preceding figure, in spite of the fact that it could also have been told in the second or third year of Ahaz, it is 'postulated' that Isaiah's prophecy was delivered in the **first** year of King Ahaz. Note that Isa 7:16 implies that between the time the prophecy was delivered and the end of King Pekah's kingship, a boy would have matured enough to know right and wrong.

If the 'capture of the Ark' is an event that could match the humiliation suffered by Ezekiel when he had to shave, we haven't yet justified that 'Isaiah's foretelling' is the appropriate event to close the 430-year period. This is what we are going to do shortly.

When Isaiah told King Ahaz that within 65 years Israel (i.e. Kingdom of Israel) wouldn't be a 'people' anymore, he was certainly not referring to the time Israel would go in exile. If the reader looks at the preceding figure he will notice that Israel went into exile only 20 years after Isaiah's foretelling. The question that should be asked is: Why then did Isaiah allude to a time that was 45 years (65 – 20) after the Exile of Israel? The answer is that even though Israel was sent into Exile 20 years later (in the 9th year of Hosea) it is assumed that many people (from the northern tribes) had been left in the land and it would take another 45 years to remove their identity.

In 2 Chron 30:5-6 King Hezekiah of Judah, in preparation for a very special Passover (5 years after Israel went in captivity) is sending couriers all over Israel's territories to invite people to the feast in Jerusalem:

- 2 Chron 30:5-6 They decided to send a proclamation throughout Israel, from Beersheba to Dan, calling the people to come to Jerusalem and celebrate the Passover to the LORD, the God of Israel. It had not been celebrated in large numbers according to what was written. At the king's command, couriers went throughout Israel and Judah NIV

Two important facts have to be kept in mind:

1. Hezekiah wouldn't have dared to send couriers into the northern territories if King Hoshea had still been ruling over the land. Therefore, we can only conclude (without the need of any timeline) that the Exile had already taken place.
2. Hezekiah wouldn't have sent couriers if nobody had been living in these territories at that time. Therefore we can deduce that not all the northern Israelites were gone.

The Exile of Israel (northern ten tribes) that took place in the 9th year of Hoshea was not enough to completely eradicate the name of Ephraim's kingdom; many people (Israelites) were still living in the territory after that Exile. Isaiah was in fact predicting that it would take another 45 years after the Exile to fully erase the Northern Kingdom's identity once and for all. How did it happen? It is believed that at the time of Manasseh's captivity (following the desecration of the Temple):

- 2 Chron 33:10-11 The LORD spoke to Manasseh and his people, but they paid no attention. So the LORD brought against them the army commanders of the king of Assyria, who took Manasseh prisoner, put a hook in his nose, bound him with bronze shackles and took him to Babylon. NIV

the King of Assyria took that opportunity to resettle (exchange) people all over the territory:

- Ezra 4:2-3 they came [people living in the land at that time] to Zerubbabel ...and said, "Let us help you build because, like you, we seek your God and have been sacrificing to him **since the time of Esarhaddon king of Assyria, who brought us here.**" But Zerubbabel, Jeshua and the rest of the heads of the families of Israel answered, "**You have no part with us** in building a temple to our God. NIV

Now that the connection between Isaiah's foretelling and Manasseh's captivity is better understood, we can investigate why this 'foretelling' is the appropriate event to close the 430-year period (symbolized by the shaving of Ezekiel) initiated with the capture of the Ark.

The scattering of Ezekiel's hairs is matched by Isaiah's foretelling

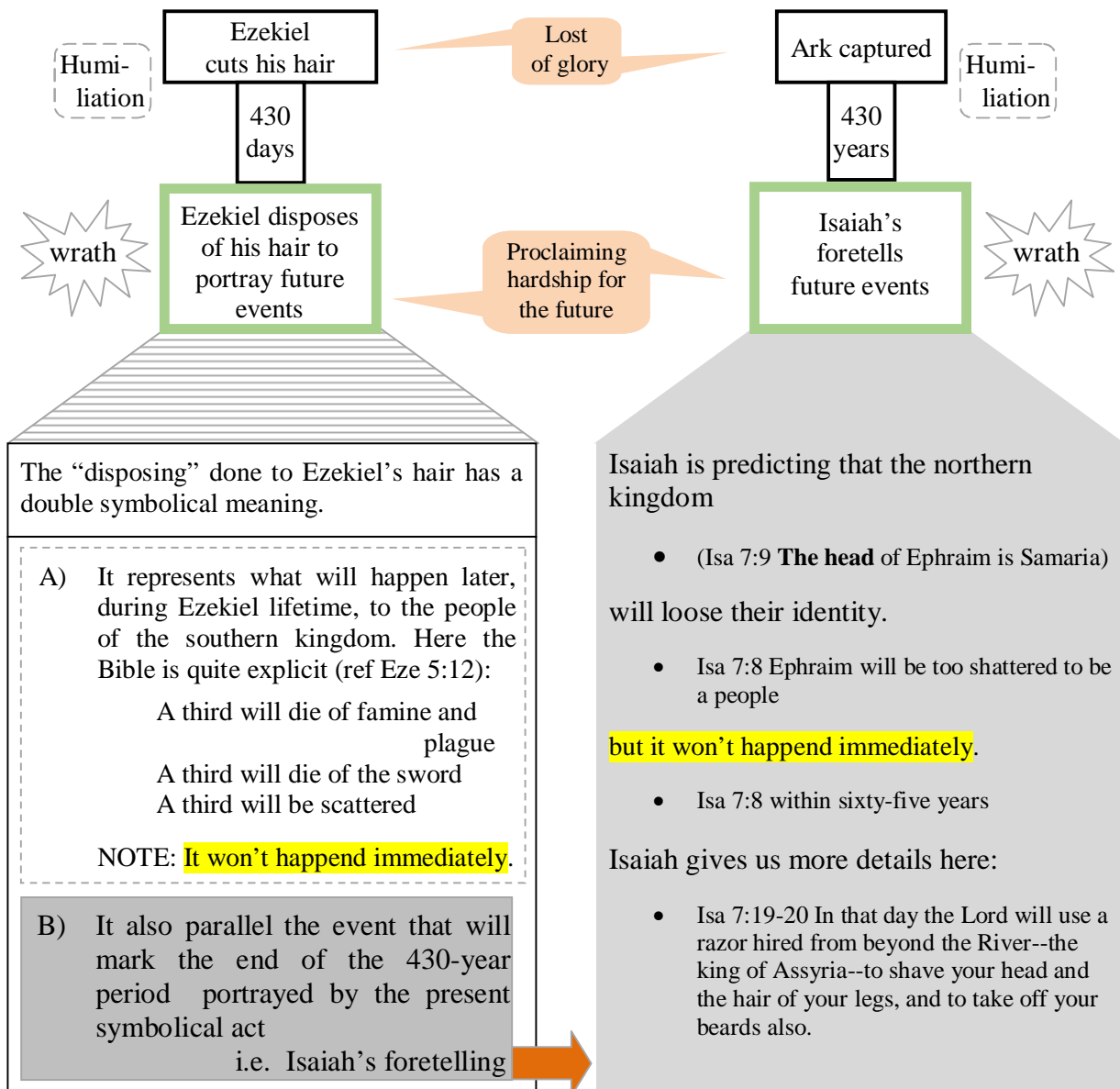

This is a clear parallel to the symbolic language used in Ezekiel. (Shave, razor, hair, beard).

If Jeremiah can equate ‘**scattering**’ (casting the hair) with ‘**rejecting Judah**’

- Jer 7:29 Cut off your hair and **throw it away** ... for the LORD **has rejected** and abandoned this generation.

then, when Isaiah tell us that God will **reject Israel**

- Israel won't be a people
- The King of Assyria will be a razor

we can picture him (Isaiah) **scattering** some hair too.

Contrary to the other symbolic acts of Ezekiel that we have seen in this paper, the **shaving** act (i.e. cutting & disposing of) was not continuously carried on over the whole period of time that Ezekiel lay on his side. Even though it is true that the two actions (cutting & disposing of) were separated by the 430 days of his siege⁶⁷, each action was fully completed on the day it was initiated. For instance, once he had cut off his hair (first part of the shaving act) it started growing again.

This is an important point to keep in mind while we are looking at the 430-year period following the capture of the Ark. The humiliation of Ezekiel (losing his hair) was never intended to become a permanent attribute⁶⁸ of the period he lay on his side. Therefore, there is no need to look for traces of ‘humiliation’ during the whole 430-year period that followed the capture of the Ark.

The second part of the shaving act (i.e. disposing of the hair to portray future events) and its counterpart, ‘Isaiah’s foretelling’, mirror each other adequately. When God asked Ezekiel to dispose of his hair He was sealing the fate of the people of Judah (southern kingdom). When Isaiah said that Israel would lose its identity within the next 65 years, God was also sealing the fate of the northern 10 tribes (Ephraim). Notice that in both cases there would be many years before the things announced came to pass.

Shaving act

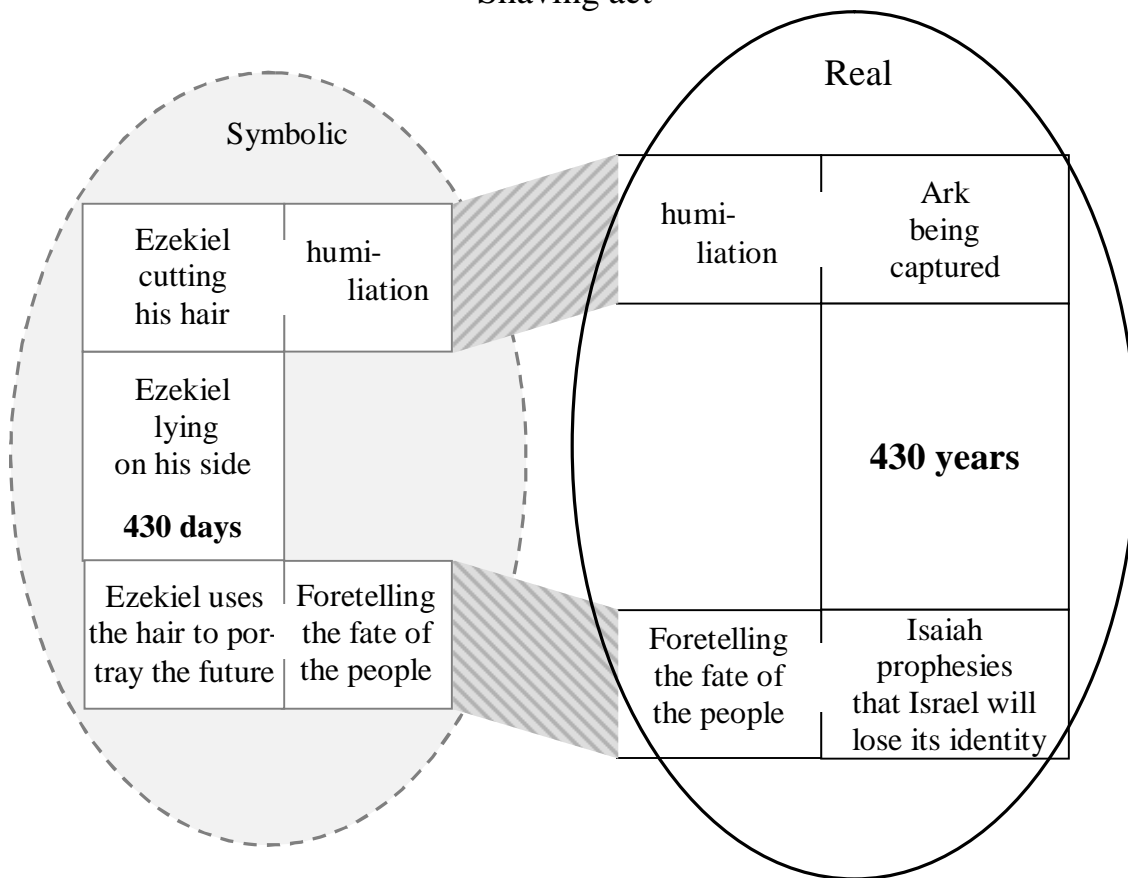

⁶⁷ Thus establishing the duration of this [‘430 days of shaving’] symbolic act.

⁶⁸ If it had been meant that way Ezekiel would have had to shave every few days during the next 430 days.

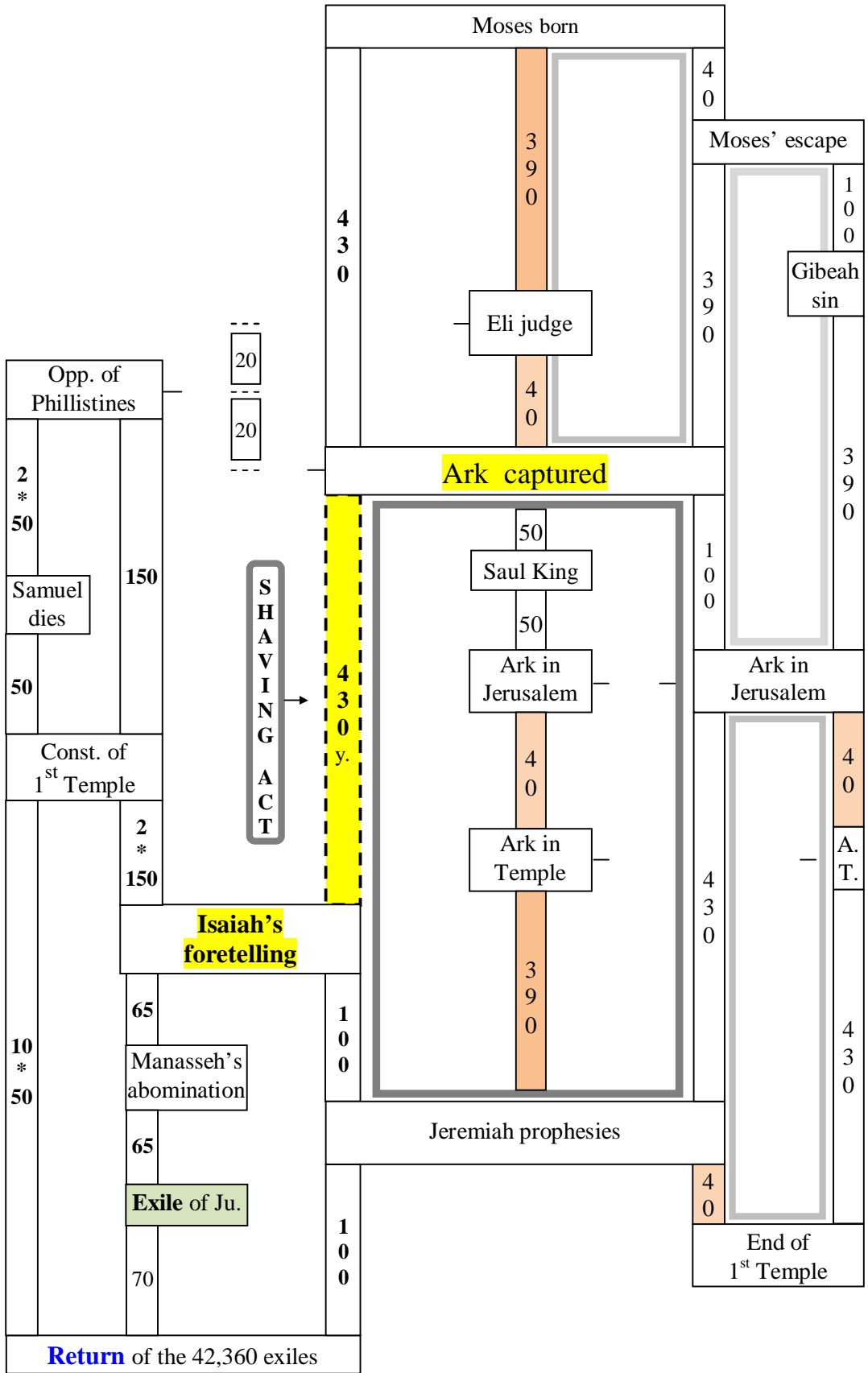

Ezekiel weighs and divides the hair

It is only when the shaving of his hair is understood as a symbolic act that we can grasp why Ezekiel had to do the ‘cutting of his hair’ at the beginning of the 430-day siege and then wait until the end of that siege before the hair is used to portray future events.

Unfortunately, this knowledge doesn’t explain why Ezekiel had to ‘weigh, and divide’ the hair immediately after the ‘cutting’ when it would seem much more natural if those two actions had been performed at the time of ‘disposal’.

Ezek 5:1 "And you, son of man, take a sharp sword, take it as a barber's razor, and pass it over your head and your beard; **then take balances to weigh and divide the hair.** NKJV

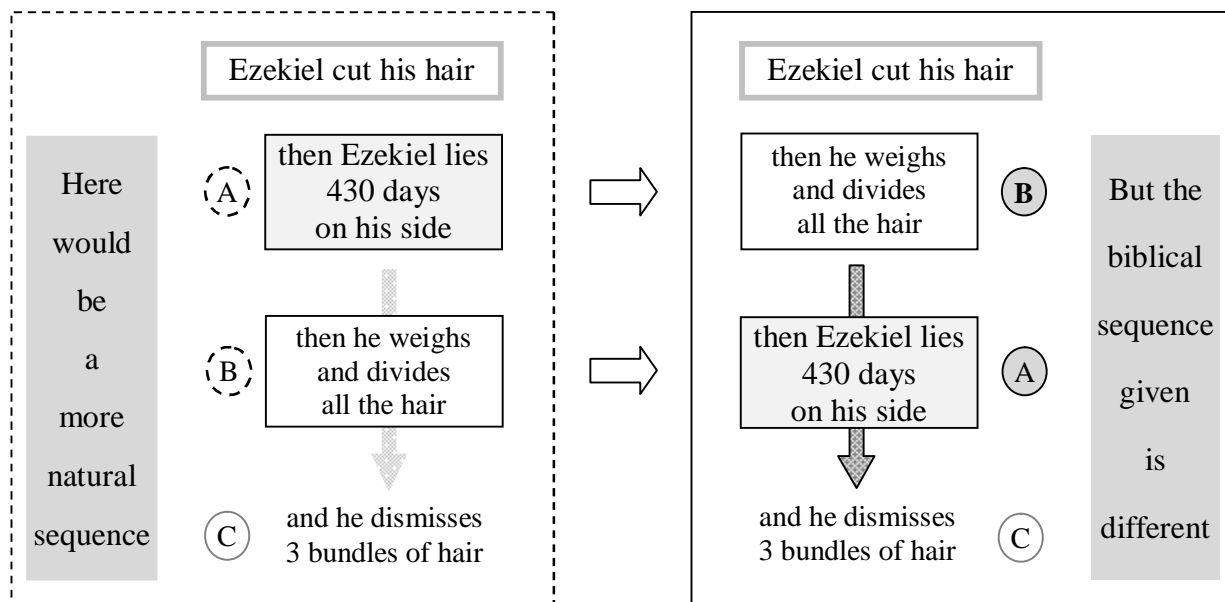

The shaving act was concluded by three different actions applied on three bundles of hair. Did it really matter if these three bundles of hair had been properly weighed or that each one had the right number of hairs? Was there anybody around Ezekiel that would have benefited from that information? We don’t know, of course, but we can speculate that this kind of accuracy had no direct impact on the way the real object of Ezekiel’s symbolic act needed to be portrayed.

Then why was Ezekiel asked to use a scale to weigh and divide the hair at the beginning of the shaving act if accuracy was not an immediate concern? And suppose accuracy after all was needed. Was it really obtained by using a scale? The question is pertinent. A scale can be very accurate when dividing by two, but does it maintain the same level of accuracy when dividing by three (three bundles)? And to add to the difficulty of obtaining the right measure, the material to weigh was human hair. Something seems to be out of place here!



As we can see, it is difficult to harmonize the ‘weigh and divide’ request asked of Ezekiel at one point with the three bundles of hair he was manipulating at another point. Therefore the solution is to stop assuming that the two sets of actions are directly related. Ezekiel was asked to weigh and divide his hair in some way at the start of the siege, but at the end of that siege, he gathered all the hair together and divided it into three bundles without the need of a scale.

Here is a proposal that reconciles all the elements:

- Ezekiel cuts his hair
- Using a scale he weighs and divides all the hair in two parts
- Ezekiel lies for 430 days on his side
- All the hair is gathered back to be separated into three bundles (no need of a scale)
- Ezekiel disposes of the three bundles

What we have here is very interesting. After dividing his hair with a scale in two quantities, Ezekiel kept them that way for 430 days. Doesn't it look like we have found another symbolic act that had nothing to do with the symbolic shaving act?

The extraordinary thing with this arrangement is that we can now distinguish the sequence of a new symbolic act (WEIGH & DIVIDE) embedded in the shaving one.

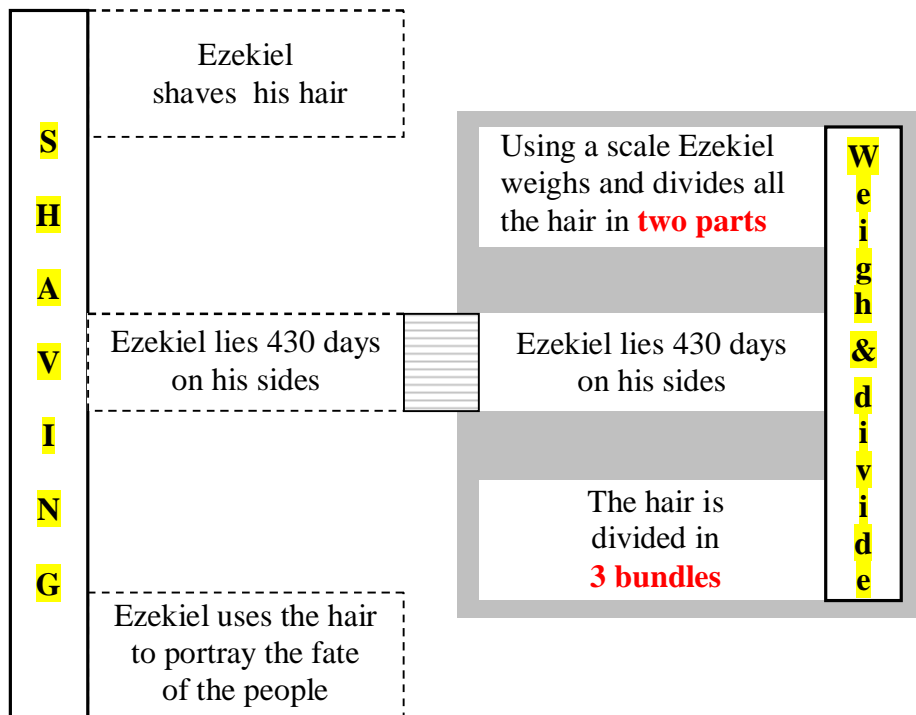

In the symbolism used by Ezekiel ‘hair’ represents ‘people’:

- Ezek 5:12 One-third of you shall ... ; and one-third shall ... ; and I will scatter another third NKJV

And ‘weighing’ could stand for ‘evaluating’:

- Prov 16:2 All the ways of a man are pure in his own eyes, But the LORD **weighs** the spirits. NKJV

We have enough here to discern the two events that perfectly match the start and the end of the new 'Weigh & Divide' symbolical act.

START: The division of Solomon's kingdom⁶⁹

Solomon had been judged (evaluated, weighed) and found guilty; he was then told that his kingdom wouldn't survive him:

- 1 Kings 11:10-11 Therefore the LORD said to Solomon, "Because you have done this, and have not kept My covenant and My statutes, which I have commanded you, I will surely tear the kingdom away from you and give it to your servant. NKJV
- 1 Kings 11:13 However I will not tear away the whole kingdom; I will give one tribe to your son for the sake of my servant David, NKJV
- 1 Kings 11:30-31 Then Ahijah took hold of the new garment that was on him, and tore it into twelve pieces. And he said to Jeroboam, "Take for yourself ten pieces, for thus says the LORD, the God of Israel: 'Behold, I will tear the kingdom out of the hand of Solomon and will give ten tribes to you NKJV

END: Fall of Babylon (End of the 70 years of Babylonian imperialism)

The 70 years of Babylon imperialism was the time allowed for the domination by Babylon over the surrounding nations:

Jer. 25:9-11 I will summon all the peoples of the north and my servant Nebuchadnezzar king of Babylon," declares the LORD, "and I will bring them against this land and its inhabitants and against all the surrounding nations. and these nations will serve the king of Babylon 70 years

The first ruler associated with the 70 years of Babylon is Nebuchadnezzar and it was prophesied that 3 generations of his own family would rule the nations:

- Jer 27:5-7 Now I will hand all your countries over to my servant Nebuchadnezzar king of Babylon; I will make even the wild animals subject to him. All nations will serve **him and his son and his grandson** until the time for his land comes; then many nations and great kings will subjugate him

First generation: Nebuchadnezzar (Represented by the 1st bundle of hair?)

- Dan 1:1 In the third year of the reign of Jehoiakim king of Judah, Nebuchadnezzar king of Babylon came to Jerusalem and besieged it.

Second generation: Evil-Merodach (Represented by the 2nd bundle of hair?)

- 2 Kings 25:27 In the thirty-seventh year of the exile of Jehoiachin king of Judah, in the year Evil-Merodach became king of Babylon

Third generation: Belshazzar (Represented by the 3rd bundle of hair?)

- Dan 7:1 In the first year of Belshazzar king of Babylon,

⁶⁹ also called the 'Kingdom's split' in this paper

Darius (the Mede) took over the **Babylonian kingdom** and put **three governors** over it.

- Dan 5:30-6:3 That very night Belshazzar, king of the Chaldeans, was slain. **And Darius the Mede received the kingdom**, being about sixty-two years old. It pleased Darius to set over the kingdom one hundred and twenty satraps, to be over the whole kingdom; and over these, **three governors**, of whom Daniel was one, that the satraps might give account to them, so that the king would suffer no loss. NKJV

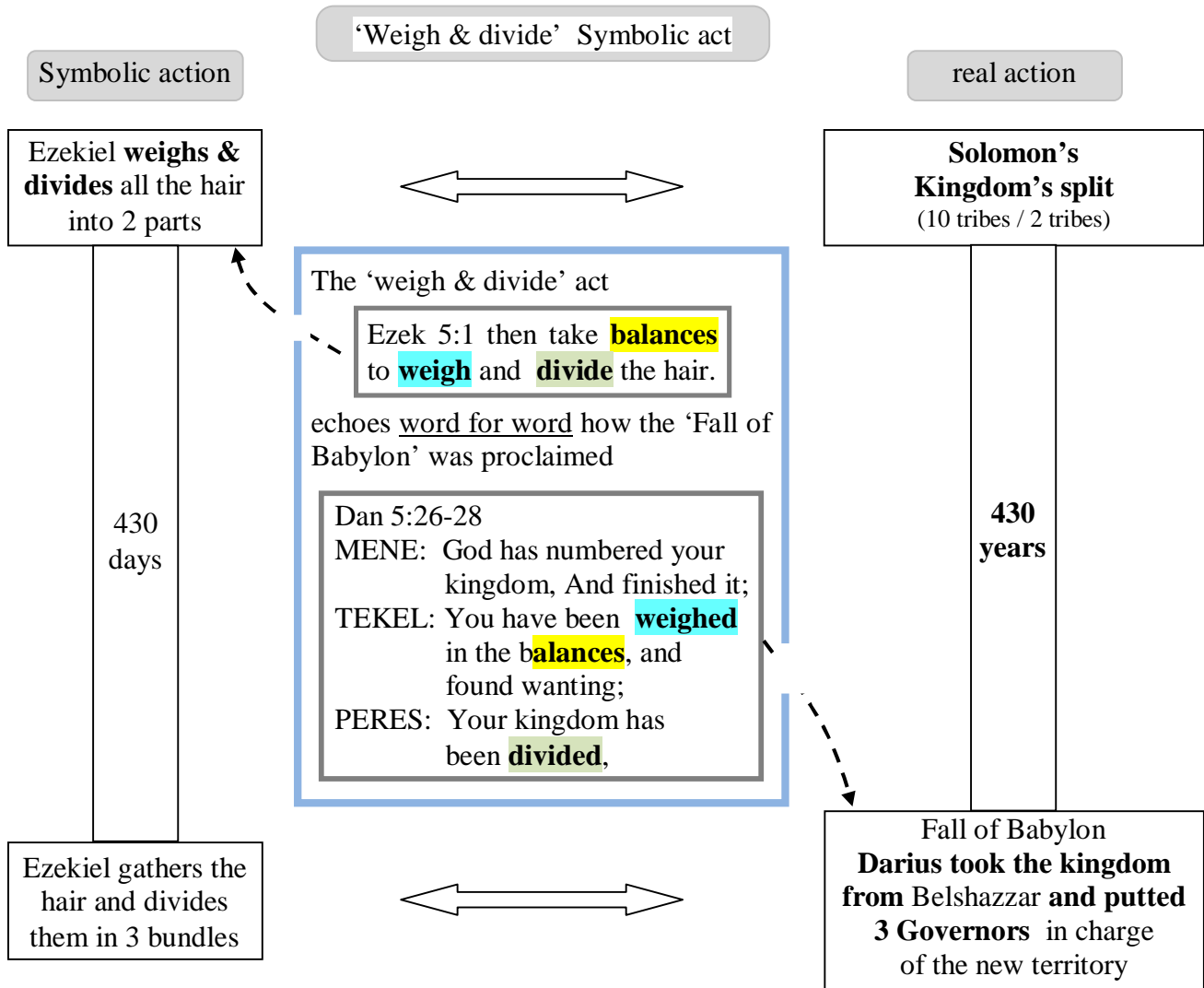

Solomon lost the whole kingdom because of his disobedience

- 1 Kings 11:10-11 Therefore the LORD said to Solomon, "**Because you have done this**, and have not kept My covenant and My statutes, which I have commanded you, **I will surely tear the kingdom** away from you and give it to your servant. NKJV

Belshazzar lost the kingdom because of his idolatry

- Dan 5:2-4 While he tasted the wine, Belshazzar gave the command to bring the gold and silver vessels which his father Nebuchadnezzar had taken from the temple which had been in Jerusalem, that the king and his lords, his wives, and his concubines might drink from them. ... They drank wine, and praised the gods of gold and silver, bronze and iron, wood and stone.

Figuring out when the Babylonian kingdom started will lead us to the time Solomon's kingdom was divided.

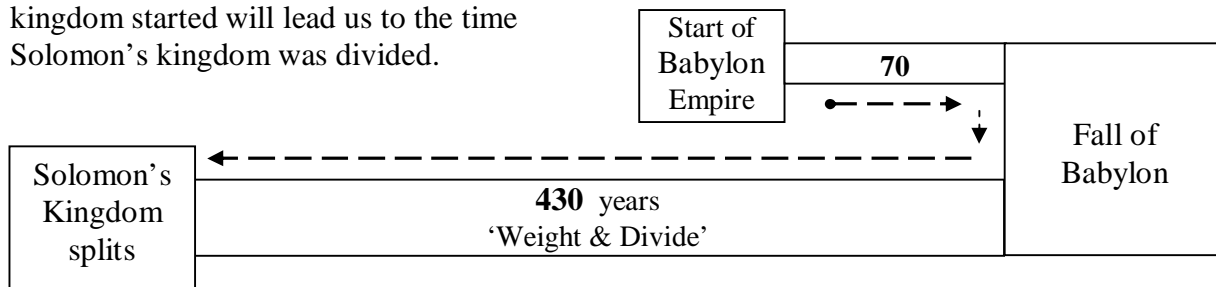

And figuring out the timing of Nebuchadnezzar will give us the information to point on the start of the Babylonian Kingdom.

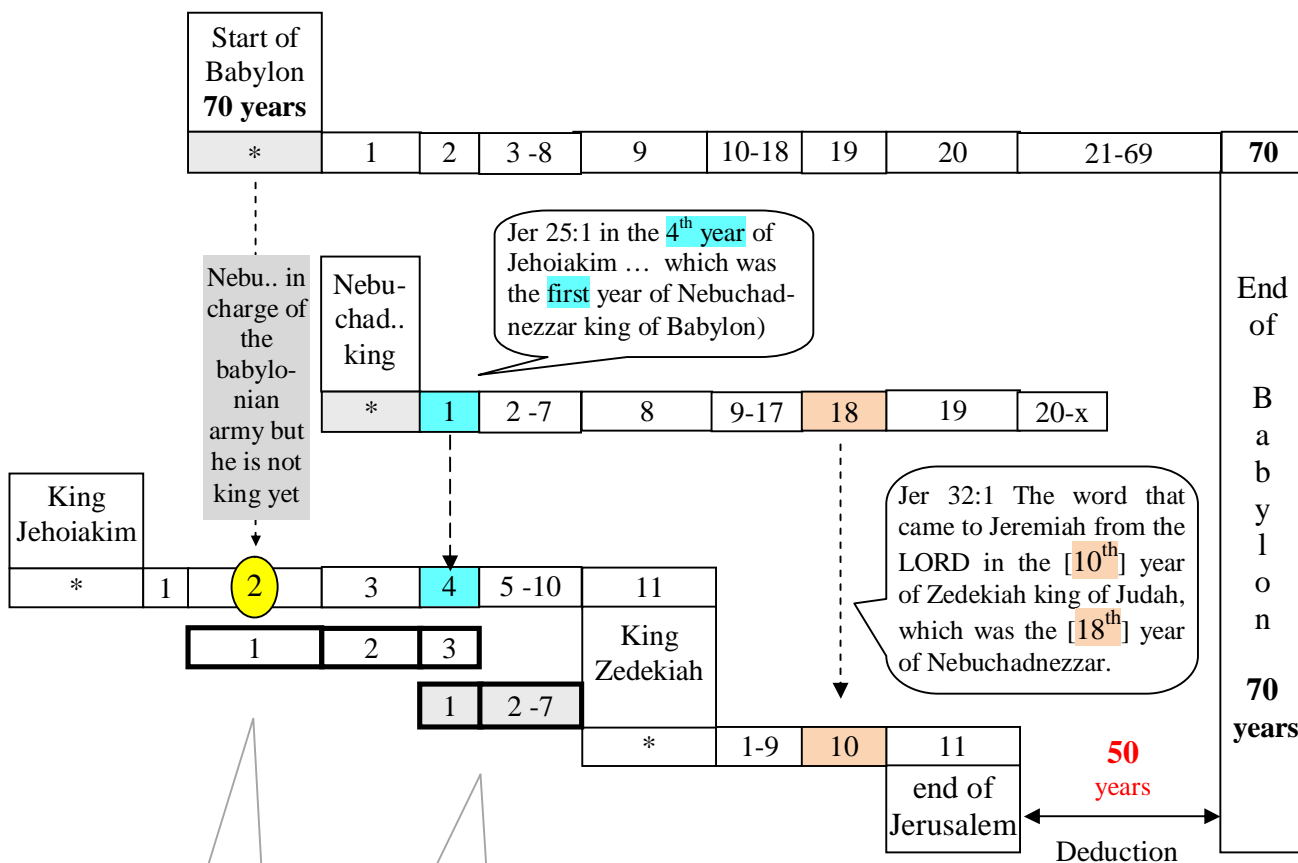

2 Kings 24:1 Nebuchadnezzar king of Babylon invaded the land, and Jehoiakim became his vassal for **three years**. But then he changed his mind and rebelled against Nebuchadnezzar. NIV

Dan 4:31-32 The words were still on his lips when a voice came from heaven, "This is what is decreed for you, King Nebuchadnezzar: Your royal authority has been taken from you. ... **Seven times** will pass by for you until .. NIV

Why did Jehoiakim rebel after 3 years? Could it be because Nebuchadnezzar became incapacitate (for 7 years) by God? If it is the case then, going backward, we can deduce that Nebuchadnezzar made a vassal of Jehoiakim one year before he became himself king. So let's start the Kingdom of Babylon at that time (i.e. Jehoiakim 2nd year)

We know now that the ‘end of the 70-year Babylonian imperialism’ happened **50** years after the ‘destruction of Jerusalem’ (by Nebuchadnezzar’s army), and we know that Solomon’s kingdom split happened 430 years before the Fall of Babylon, we have enough to show that Solomon spent as much as **40** years in his new Palace.

From ‘Ark in Temple’ to

① Jerusalem’s destruction
= 430 years see *page 29*

From ‘Jerusalem’s destruction’

② to ‘Fall of Babylon’
= 50 years see *previous page*

From ‘Ark in Temple’ to

③ ‘Solomon’s palace ready’
= 10 years -see *page 70*

From ‘kingdom’s split’ to

④ ‘Fall of Babylon’
= 430 years
-hair divided *symbolic act*

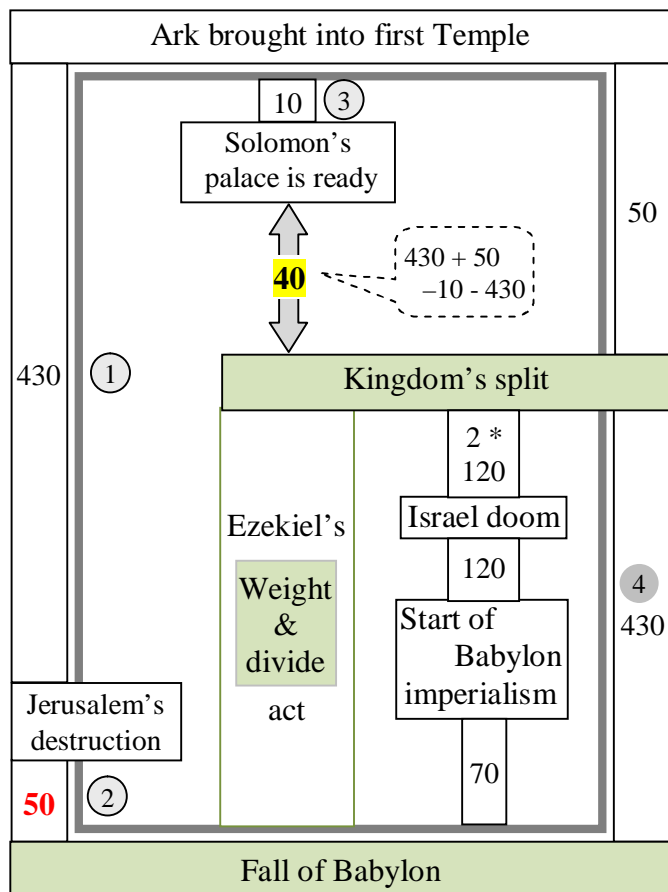

How long did Solomon reign?

Now that the ‘kingdom’s split’ has been accurately fixed we have enough to invalidate the widespread belief that Solomon’s kingship lasted only 40 years. We will see that in fact **Solomon had been king for 63 years.**

Solomon’s death occurred shortly before the ‘kingdom’s split’ and we have just learned in the previous figure that this ‘split’ occurred 40 years after Solomon’s palace became available. It ensures that Solomon’s reign had been longer than 40 years. Many readers would find it outrageous if they were asked to question the authenticity⁷⁰ of 1 Kings 11:42 where it is mentioned that Solomon reigned over Israel for a total of 40 years. Fortunately, they won’t be asked such a thing. According to the previous figure, from the completion of his palace to his death (shortly before the kingdom’s split) there is a period of 40 years. This **has to be** the same ‘40 years’ as the one mentioned in 1 Ki 11:42. But before accepting this convenient interpretation, one point needs to be clarified. Why would 1 Ki 11:42 emphasize only the last 40 years of Solomon’s reign and choose to ignore the first 23 years during which Solomon built the Temple and his Palace?

The answer is found in

- 1 Kings 3:14 So if you walk in My ways, to keep My statutes and My commandments, as your father David walked, **then I will lengthen your days.**" NKJV

⁷⁰ 1 Kings 11:42 And the period that Solomon reigned in Jerusalem over all Israel was forty years. NKJV

Among all the things God told Solomon He would give him, there is only one that came with a condition attached. Solomon would first have to walk in God's way before he received a long life. In other words, there would be a period of evaluation **before** the promise would be delivered. God appeared to Solomon right after the completion of the Palace. This would be 23 years after the beginning of Solomon's reign (see on page 65 or below).

- 2 Chron 7:11-12 ... and Solomon successfully accomplished all that came into his heart to make in the house of the LORD and in his own house. **Then the LORD appeared to Solomon by night, NKJV**

The Theophany of 2 Chron 7:12 is a proof that Solomon's reign had reached a **turning point**. Up to that time Solomon had been on 'probation' as he needed to demonstrate that he was a worthy king. By appearing to him a second time God was acknowledging that Solomon had done well and he would be allowed a long life. Isn't it quite revealing that all this happened at the very time the new Palace became available? As if, symbolically, Solomon's reign was given an official start at the very time he was going to occupy his newly built palace.

Solomon's kingship lasted 63 years

(Solomon and David reigned 100 years altogether)

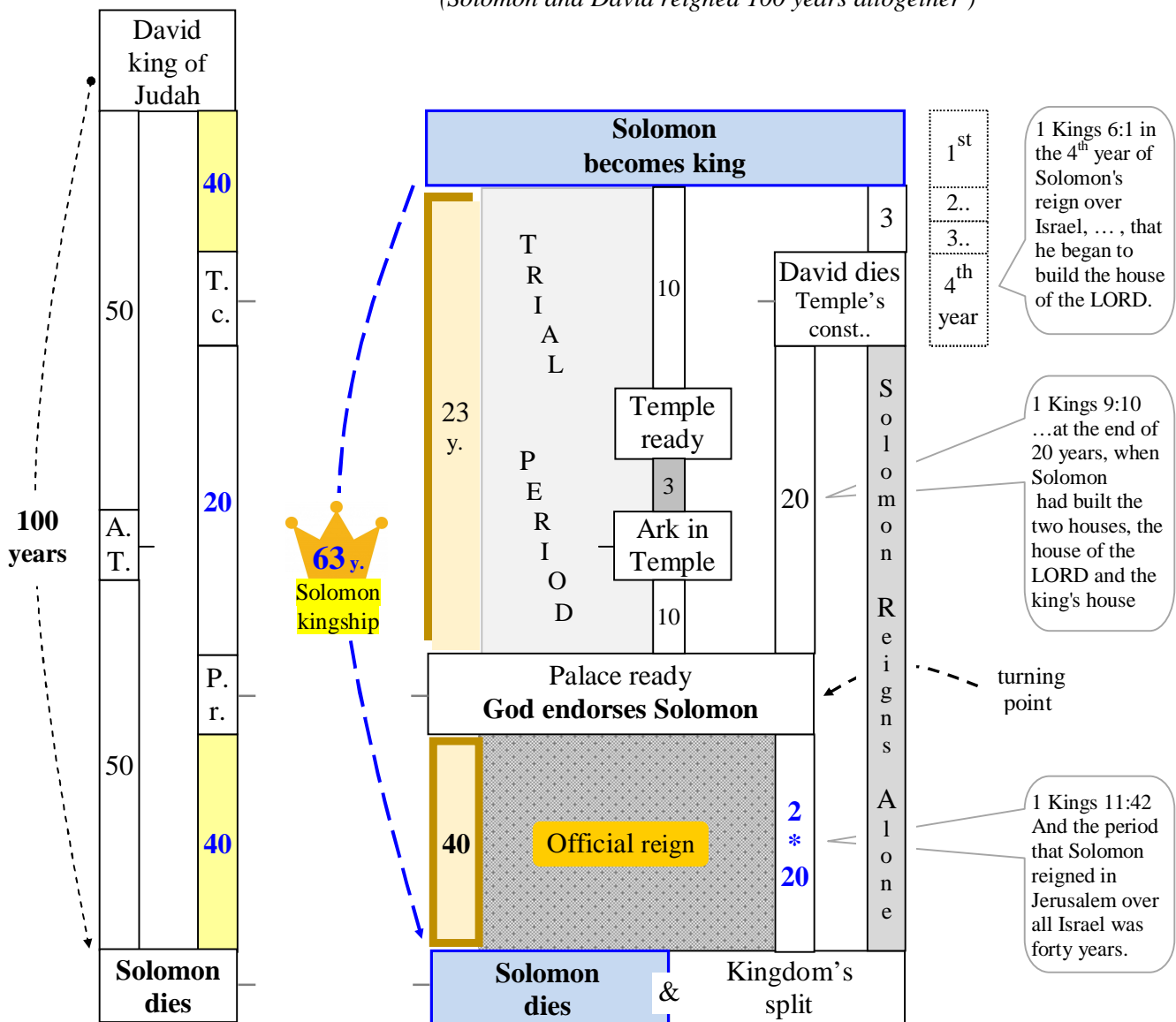

Ezekiel's hair growing again

Before directly addressing this new topic we first need to identify what happened at the end of Jerusalem's 70 years of desolation.

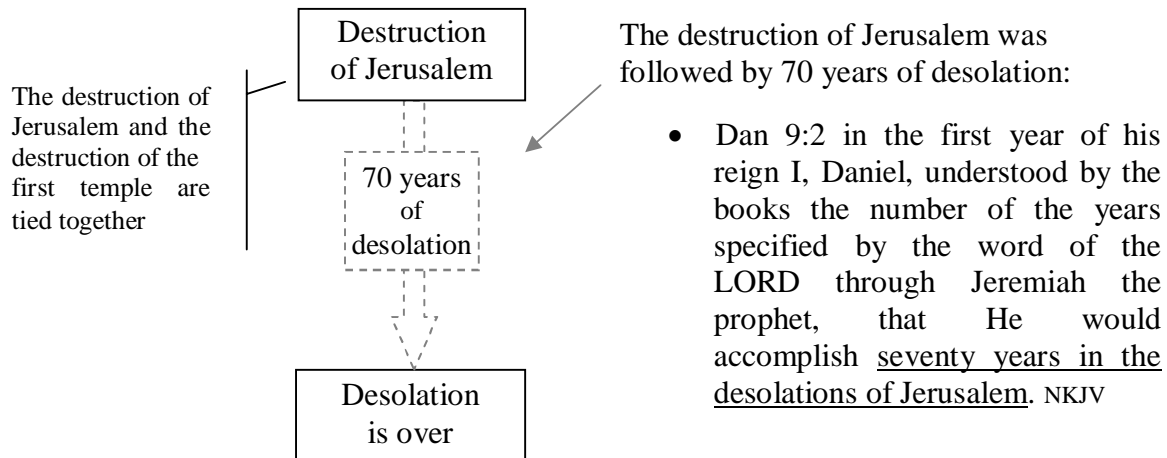

We learn from Chronicles that during the desolation (70 years) the land enjoyed its Sabbaths:

- 2 Chron 36:21 to fulfill the word of the LORD by the mouth of Jeremiah, until the land had enjoyed her Sabbaths. As long as she lay desolate she kept Sabbath, to fulfill seventy years. NKJV

And we also learn that the 70 years of desolation were equivalent to the 70 sabbatical years that had not been observed previously:

- Lev 26:35 As long as it lies desolate it shall rest--**for the time it did not rest on your Sabbaths when you dwelt in it.** NKJV

When the Israelites came into the Promised Land they had to follow a rule that allowed the land to rest for a full year every 7 years. That rule was known as the Sabbath law and it was enforced until the death of Samuel (see on page 63). After Samuel's death, during the next 490 years, the Israelites never let the land rest and by the time Jerusalem was destroyed a total of 70 years (one year for every 7 years) had been disregarded. The Israelites deliberately chose to ignore the divine law, unfortunately for them God did not forget it.

There is an important point to understand here. The 70 years of desolation that came after the destruction of Jerusalem were not years of 'punishment'⁷¹ against the Israelites, but rather years of 'restitution' to a land that had been denied some of its Sabbath rest.

⁷¹ In fact the punishment had been handled 10 years before when the Israelites (tribe of Judah) were sent into Exile.

IMPORTANT

The 70 years of exile and the 70 years of desolation are two different periods

We shouldn't be concerned if the land had been partly or fully inhabited during this last 10 years stretch of the desolation; what mattered was that the land was still resting and wouldn't produce any crops.

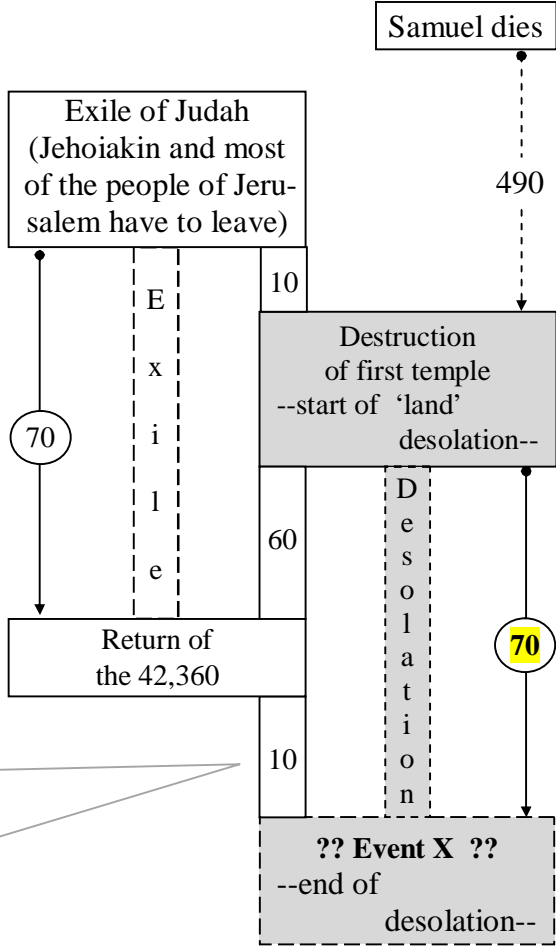

Period during which the sabbatical regulation was not re-enforced.

The land enjoys its 70 sabbatical years of rest.

We have two important clues to identify the event 'X' that marked the end of Jerusalem's desolation.

- #1. The return of the exiles⁷² (42,360) is not linked to the end of desolation.
- #2. Once the 70 years of rest were completed the land would give useful crop yields for the people again.

The timing of the event 'X' that we are looking for was clearly invoked by Haggai:

The land was going to produce again:

- Hag 2:18-19 Give careful thought: Is there yet any seed left in the barn? Until now, the vine and the fig tree, the pomegranate and the olive tree have not borne fruit. **"From this day on I will bless you."**

⁷² Ezra 2:1 Now these are the people of the province who came back from the captivity, of those who had been carried away, whom Nebuchadnezzar the king of Babylon had carried away to Babylon, and who returned to Jerusalem and Judah, everyone to his own city. NKJV

The event that would mark the end of the desolation of the land was the resuming of the construction of the second Temple:

- Hag 1:9-11 "Because of **my house, which remains a ruin**, while each of you is busy with his own house. Therefore, because of you **the heavens have withheld their dew and the earth its crops**. I called for a drought on the fields and the mountains, on the grain, the new wine, the oil and whatever the ground produces, on men and cattle, and on the labor of your hands."

Three important things to note from Hagai 1:9-11:

- #1. Haggai clearly identified a time when the Israelites were building their house⁷³ while the Temple lay in ruins.
- #2. The land was not producing any useful crops. (In fact the land had until then been enjoying its 70 sabbatical years of rest.)
- #3. Obtaining any crops of the land was directly related to the construction of the second Temple.

For Haggai to suggest the third point could only mean that the 70 years of desolation had just been reached. There was nothing preventing⁷⁴ the construction of the second Temple anymore.

- Hag 1:7-8 Go up into the mountains and bring down timber **and build the house**, so that I may take pleasure in it and be honored

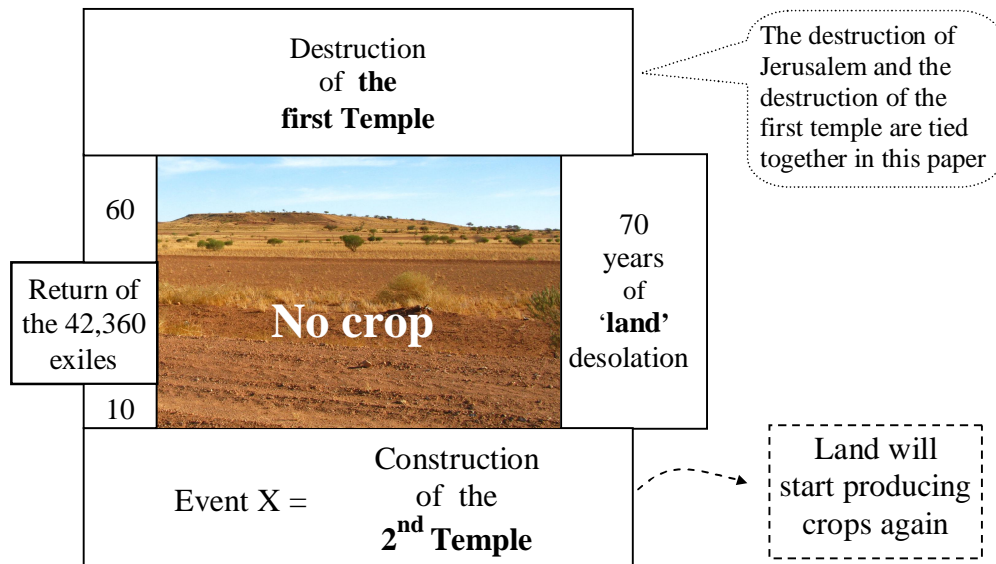

⁷³ This is not surprising given that according to our hypothesis the Israelites came back to the land 10 years before.

⁷⁴ A few years back the people (from the 42,360 who came back with Zerubbabel) had laid the foundation of the new Temple but they were not allowed to start any construction at that time.

Three distinct occurrences of a 70-year period
interact with 3 Ezekiel symbolical acts.

70 years
of Babylon
(Nations serve the
King of Babylon)

70 years
of exile
(People deported
from their land)

70 years
of desolation
(Land would enjoy
its sabbatical years)

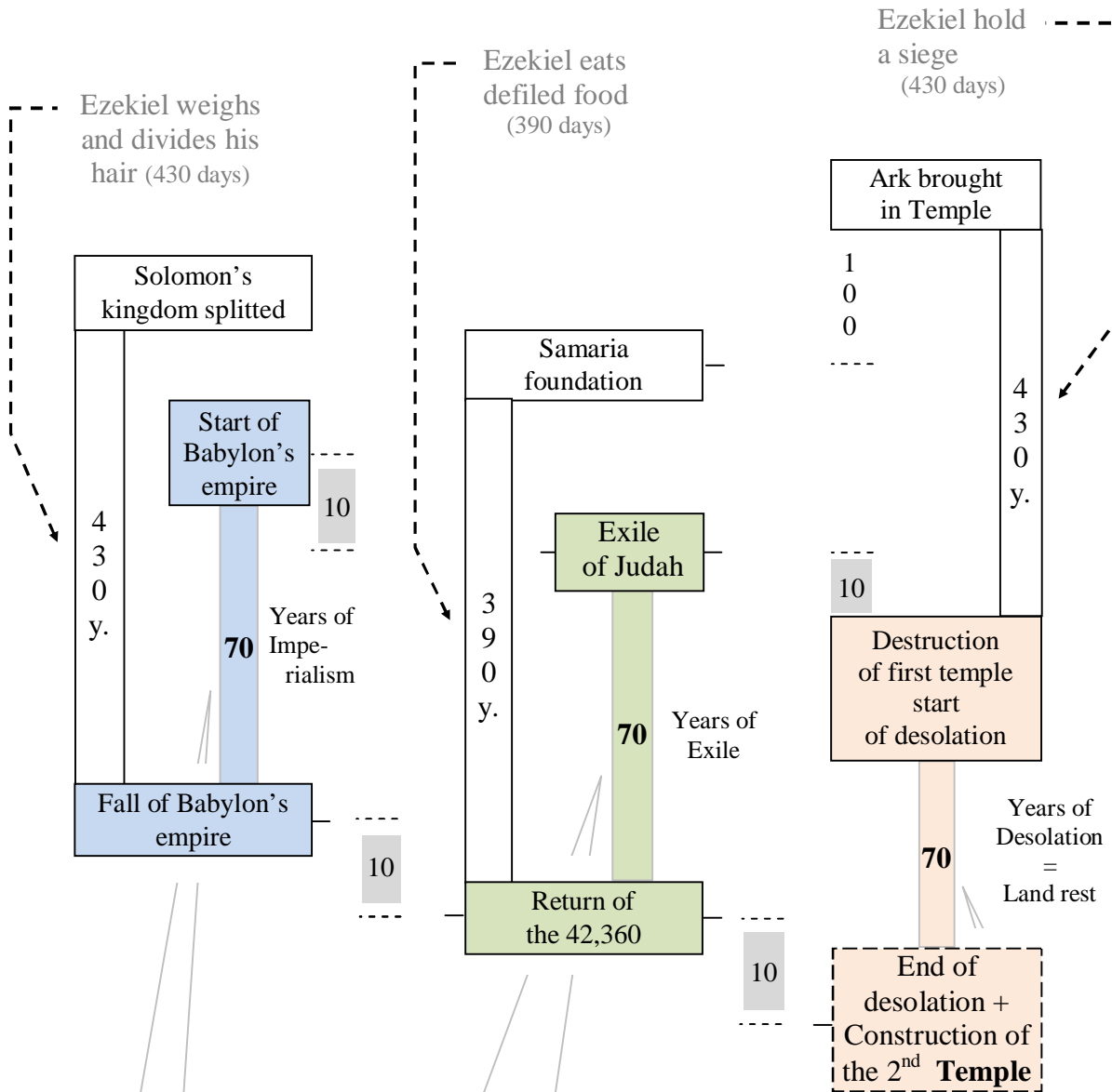

Jer 25:11 and these nations will serve the king of Babylon **seventy years**.

Jer 29:10 After **seventy years** are completed at Babylon, I will visit you and perform My good word toward you, and cause you to return to this place.

2 Chron 36:21 The land enjoyed its sab-bath rests; all the time of its desolation it rested, until the **seventy years** were completed

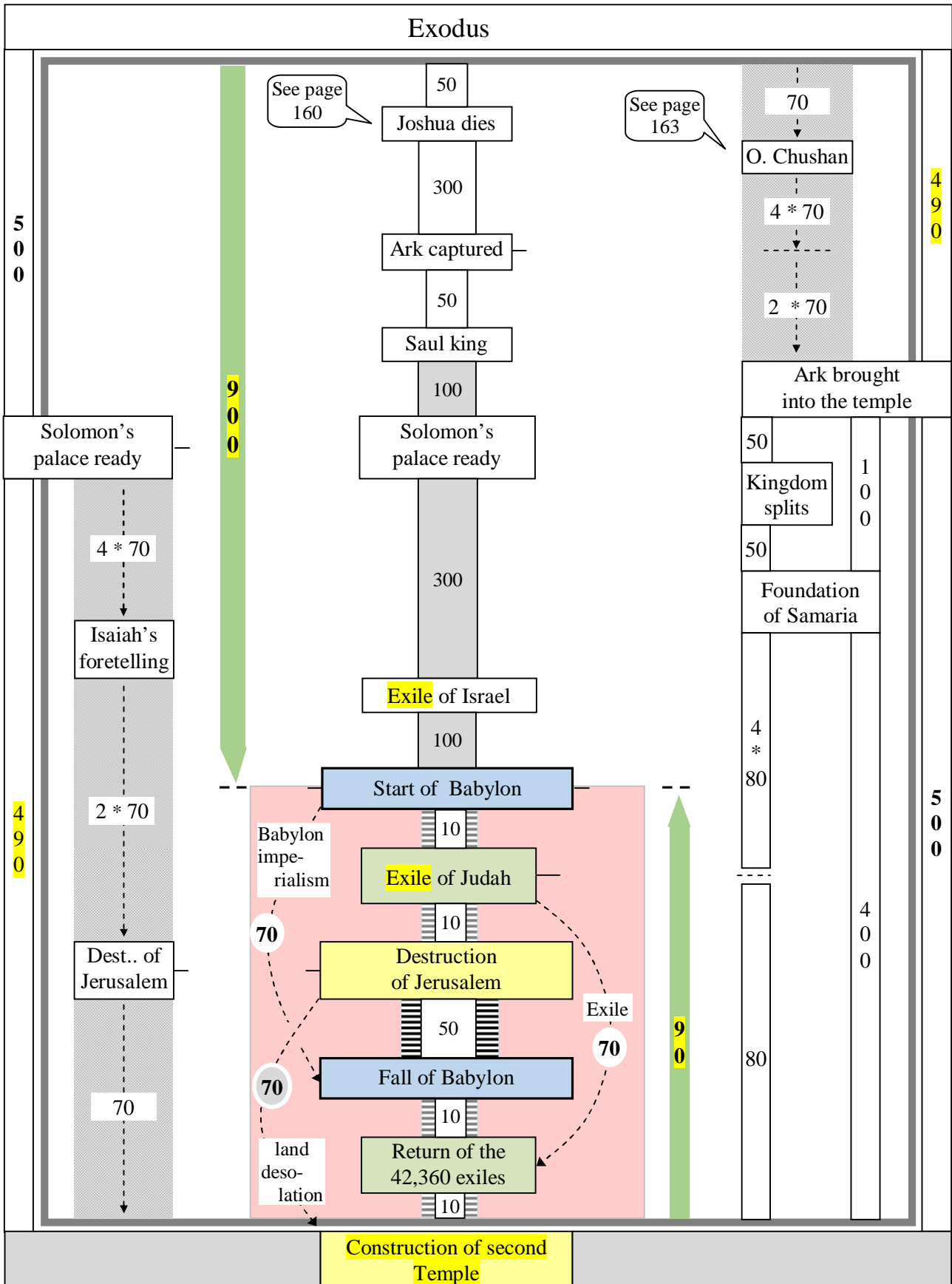

Figure 16. Construction of the second Temple

As mentioned earlier, Ezekiel had to shave his head and beard at the beginning of his siege. What is not emphasized, however, is the fact that his new baldness didn't last long.

In truth, his hair and beard started growing again immediately after the shaving. This may not have been apparent in the first few hours of Ezekiel's reenactment but let's not forget that he lay more than a year (430 days). We have here the first part of a new symbolic act.



This act is associated with no specific house⁷⁵ and it lasted the whole 430 days of Ezekiel's siege. Surprisingly the act was not concluded by Ezekiel shaving his head again⁷⁶. However, it is more than likely that the prophet rushed to make some proper hairdressing as soon as the siege was over and he was set free⁷⁷:

- Ezek 44:20 They [priest] shall neither shave their heads **nor let their hair grow long**; but **they shall keep their hair well trimmed**. NKJV

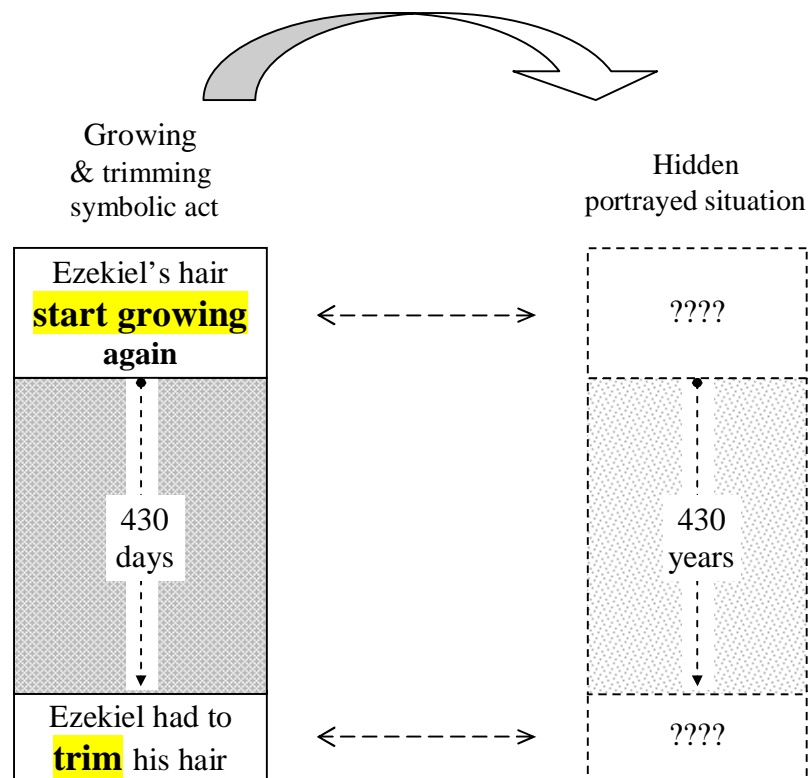

⁷⁵ The side on which Ezekiel was lying didn't alter the meaning of the act. Whatever side Ezekiel was lying on, his hair was growing independently of it.

⁷⁶ There is absolutely no indication that he would have done it any time during the siege. And it is quite unlikely that he would have gone through the humiliation (shaving his head) a second time after the siege.

⁷⁷ Ezekiel was tied during 430 days.

Ezekiel's "Growing and trimming" act

No matter how inadequate the following allegation will sound, I believe the event portrayed by Ezekiel's 'growing hair' is the '**construction of the second Temple**'. Notice that in each case ("hair starts growing" and "construction of the second Temple") a slow process is initiated and will eventually bring back something that had been 'dramatically' removed⁷⁸.

The construction of the second Temple took place at the end of a 70-year period during which the land was left completely desolated. We have already (on page 105) seen that 'the day' the Israelites returned to the construction of the (second) Temple the land started producing food again:

- Hag 1:7-8 Thus says the LORD of hosts: "Consider your ways! Go up to the mountains and bring wood **and build the temple, that I may take pleasure in it** and be glorified," says the LORD. NKJV
- Hag 2:19 Is the seed still in the barn? As yet the vine, the fig tree, the pomegranate, and the olive tree have not yielded fruit. **But from this day forward I will bless you.'**

Could it be more plain than that? The land started **growing food** the same day the construction⁷⁹ of the second temple began. We have here a direct connection with Ezekiel's '**growing hair**'.

It was inferred earlier that after his siege was over, Ezekiel needed to trim his hair. Wouldn't it be also expected that after 430 years the second Temple was in dire need of some major repairs? John 2:20 confirms that some major repairs were done to the 2nd Temple⁸⁰

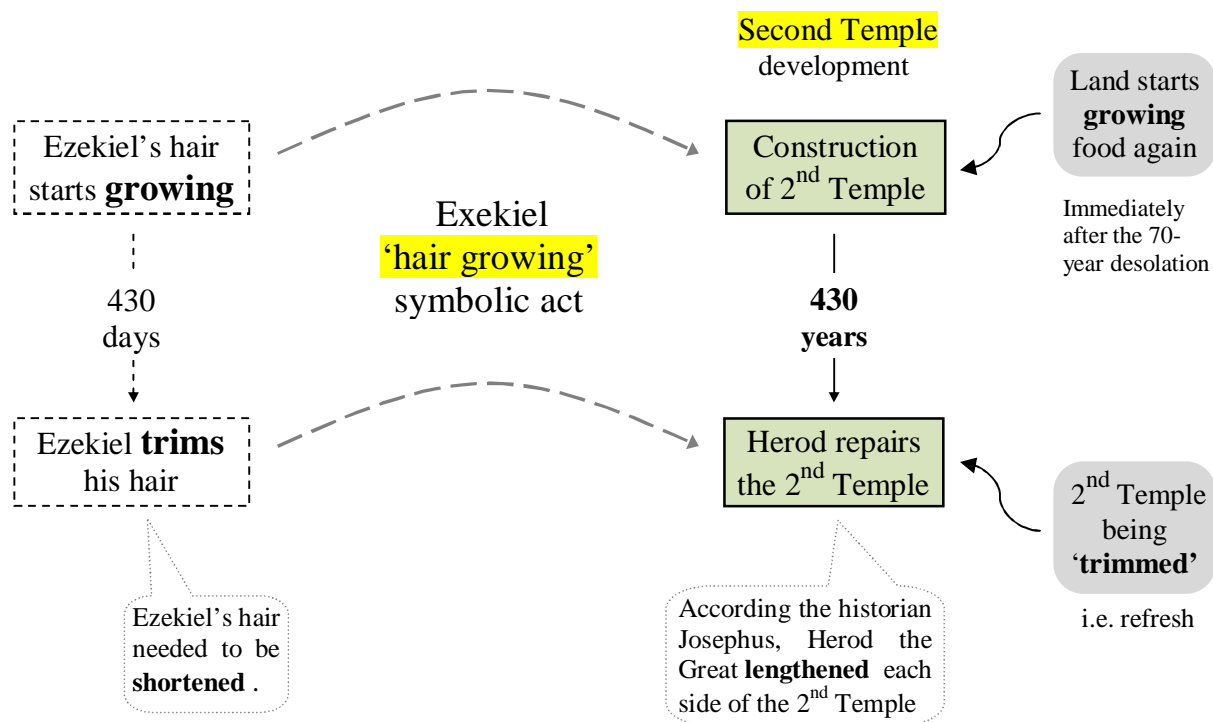

⁷⁸ Ezekiel felt humiliation at losing his hair; the Israelites felt despair at seeing their Temple destroyed.

⁷⁹ We will see in the coming pages of this book that the construction of the 2nd Temple happened 3 years after its foundation was layed out. It is important to keep in mind that these two events are not the same.

⁸⁰ John 2:20 The Jews replied, "It has taken **forty-six** years to build this temple, NIV

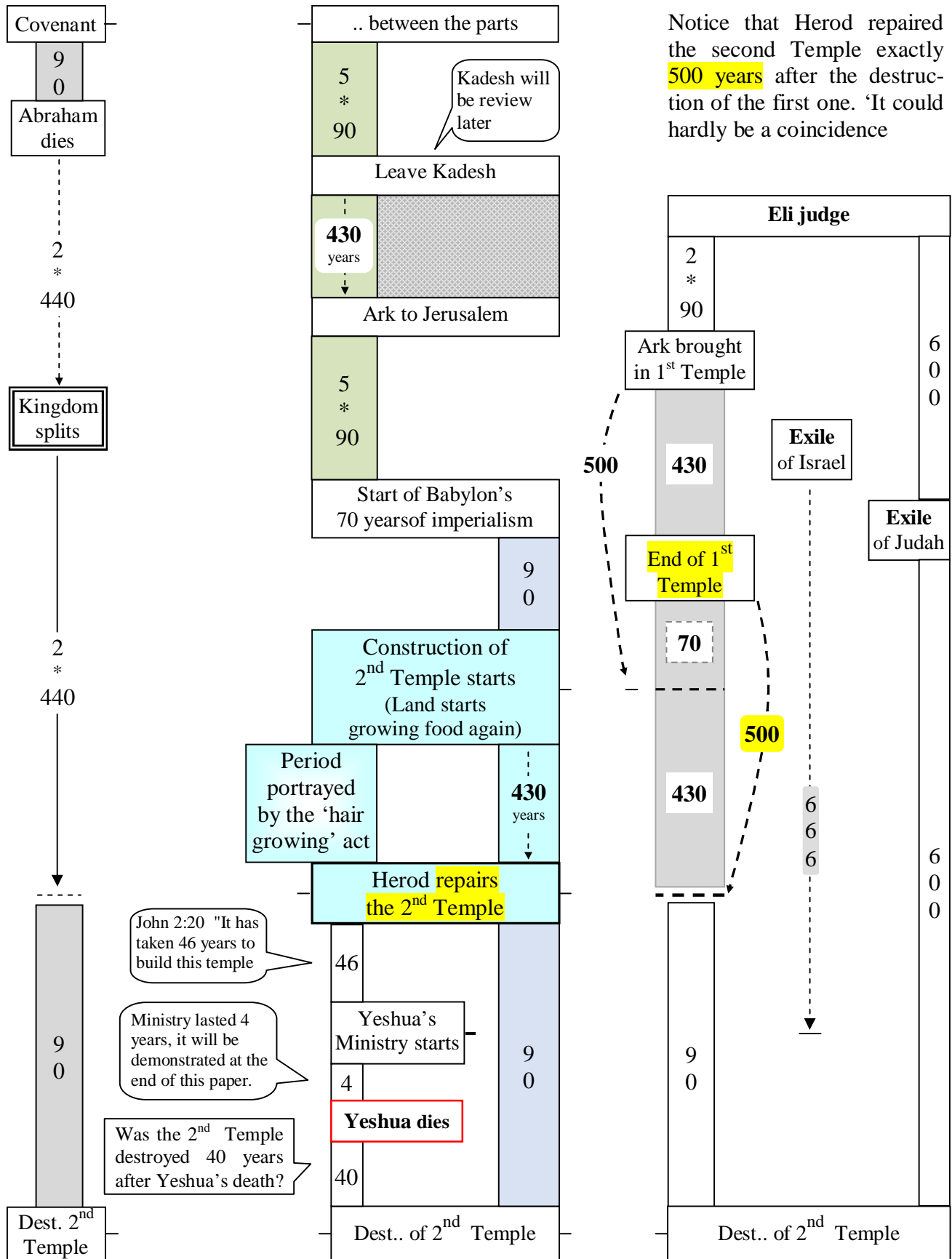
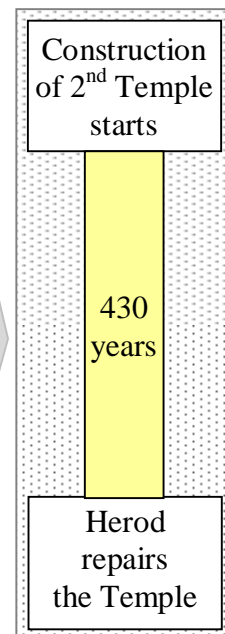
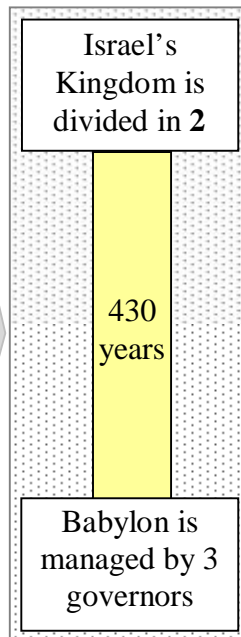
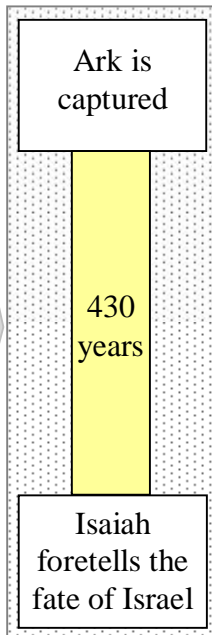
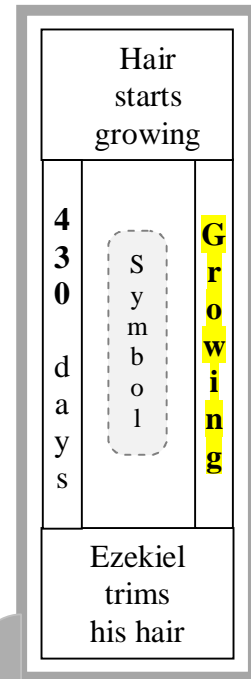
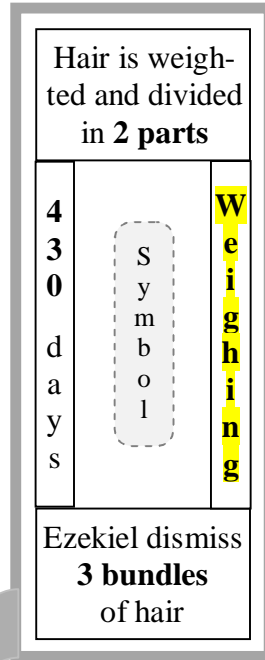
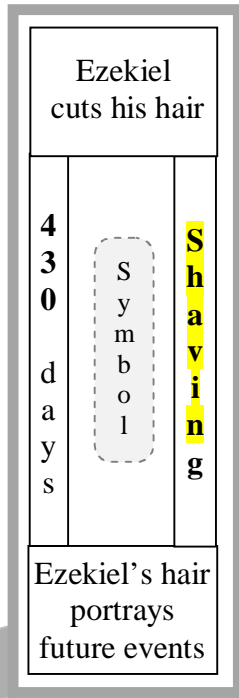

Figure 17. Hair growing act

The 3 symbolical acts associated with Ezekiel's hair



Real

Real

Real

Daniel 70-week & post exile chronology

Dan 9:24-27 24 "Seventy weeks of years are decreed concerning your people and your holy city, to finish the transgression, to put an end to sin, and to atone for iniquity, to bring in everlasting righteousness, to seal both vision and prophet, and to anoint a most holy place. 25 Know therefore and understand that from the **going forth of the word** to restore and build Jerusalem to the coming of an **anointed one, a prince**, (A) there shall be **seven weeks**. Then for (B) **sixty-two weeks** it shall be built again with squares and moat, but in a troubled time. 26 And after the sixty-two weeks, **an anointed one** shall be cut off, and shall have nothing; and the people of **the prince** who is to come shall destroy the city and the sanctuary. Its end shall come with a flood, and to the end there shall be war; desolations are decreed. 27 And he shall make a strong covenant with many for (C) **one week**; and for half of the week he shall cause sacrifice and offering to cease; and upon the wing of abominations shall come one who makes desolate, until the decreed end is poured out on the desolator." RSV

This prophecy covered a period of 490 years (70 weeks of 7 years each) separated into 3 parts (A, B, C). The prophecy is solely concerned by the years of these three specific periods as they are the one that will contribute an active role to bring an end to the transgression in the holy city of Jerusalem. The 3 divisions form a 'time allotment' and therefore don't need to be continuous. (*More on page 129*)

| Daniel's 70 weeks (70 weeks are 'set aside') | | | | | | | | |
|--|----------|---------------------------------------|----------------------|-------------------------|--|----------------------------------|--------|--|
| W O R D | 7 weeks | Event X ?Anointed one A prince? | 62 weeks | Anointed One Cut off | Irrelevant years Keep in mind The 70 weeks only involve Daniel's people and the holy city. Dan 9:24 Gap of ? years (to be reviewed) | A prince 'Who is to come' | 1 week | C O N C L U S I O N |
| | Part A | | Part B | | | | Part C | |
| | 49 years | 434 years | (3½ + 3½) 7 years | | | | | |
| | 483 | | | 7 | | | | |
| 483 + 7 = 490 years | | | | | | | | |

Any gap of years between part B and C should be viewed as irrelevant to the prophecy total count of years. It is therefore wrong to conclude that God has been stopping a so called clock in order to justify the gap. There is a gap because it covers a period of time that has nothing to do with any of the three **active** parts described in the prophecy. (We will see in **p. 129** why **part A & B** are continuous while **part C** stands apart.)

The first⁸¹ two periods (A & B), although described separately, are consecutive:

- Dan 9:25 there shall be seven weeks. Then for sixty-two weeks RSV

Daniel's prophecy starts with a 'word' to restore Jerusalem:

- Dan 9:25 Know therefore and understand that from **the going forth of the word** to restore and build Jerusalem RSV
 - Isa 44:28 ... **he will say of Jerusalem**, "Let it be rebuilt," and of the temple, "Let its foundations be laid." "

⁸¹ The last period (C) will be review in Appendix I on page 269.

While most chronologers take the position that the 70-week period started at the time when 'the word'⁸² was pronounced, which compel them (these chronologers) to search for the specific decree associated with that word, I have a very different approach.

It is obvious to me that the 'going forth of the word' (Dan 9:25) can only mean the time of the **EXECUTION** of that word, i.e. the start of the 70-week of Daniel has to coincide with the point in time when **the very first 'concrete' action to restore Jerusalem was laid down on the ground.**

In this paper there is no doubt that **laying the Foundation⁸³ of the 2nd Temple** was the first step to rebuild Jerusalem and therefore it coincided with the **start of Daniel's 70 weeks.**

Isa 44:28 he will say of Jerusalem, "Let it be rebuilt," and of the temple, "Let its foundations be laid." ' NIV

rebuilding Jerusalem = **laying the Temple's foundation**

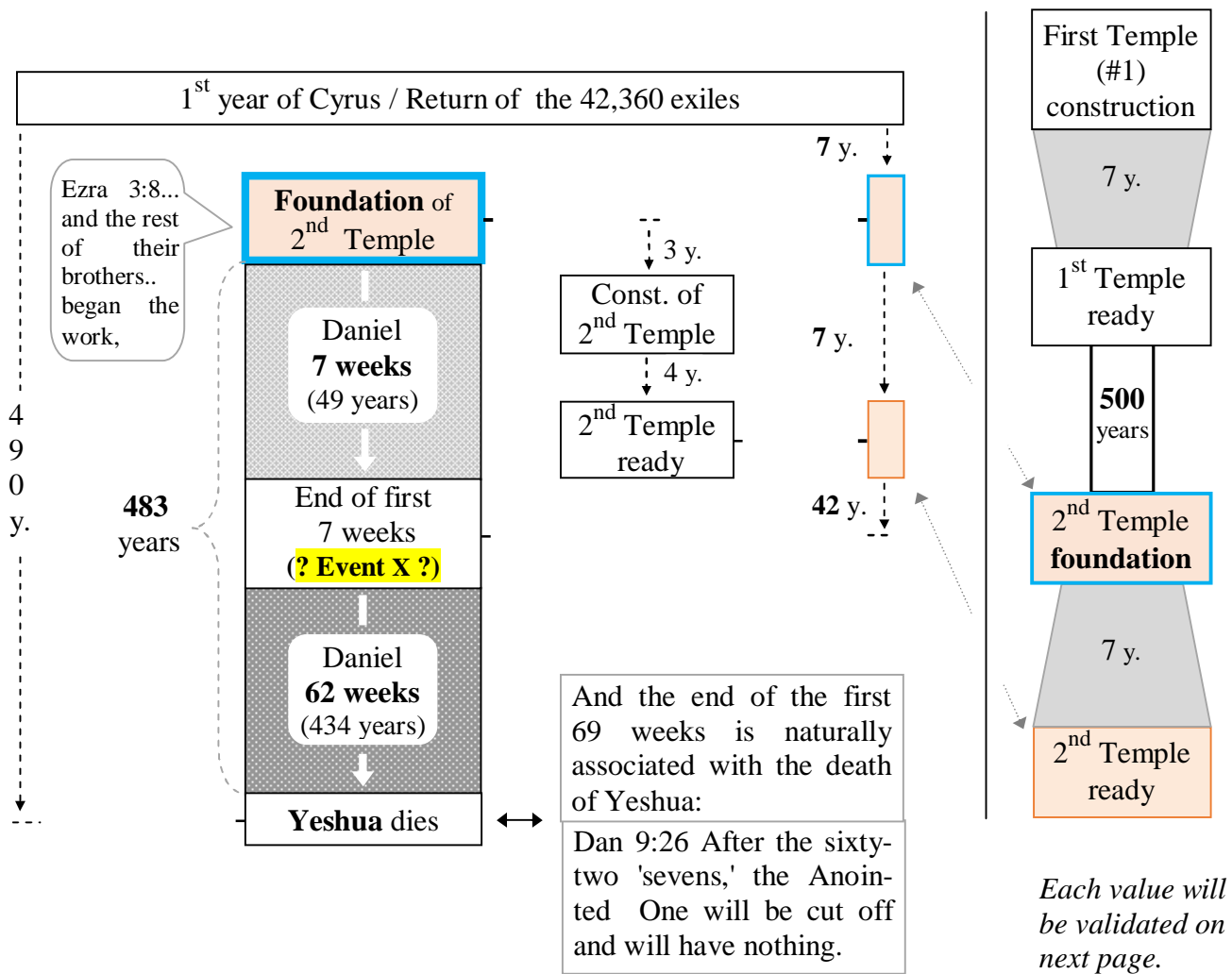
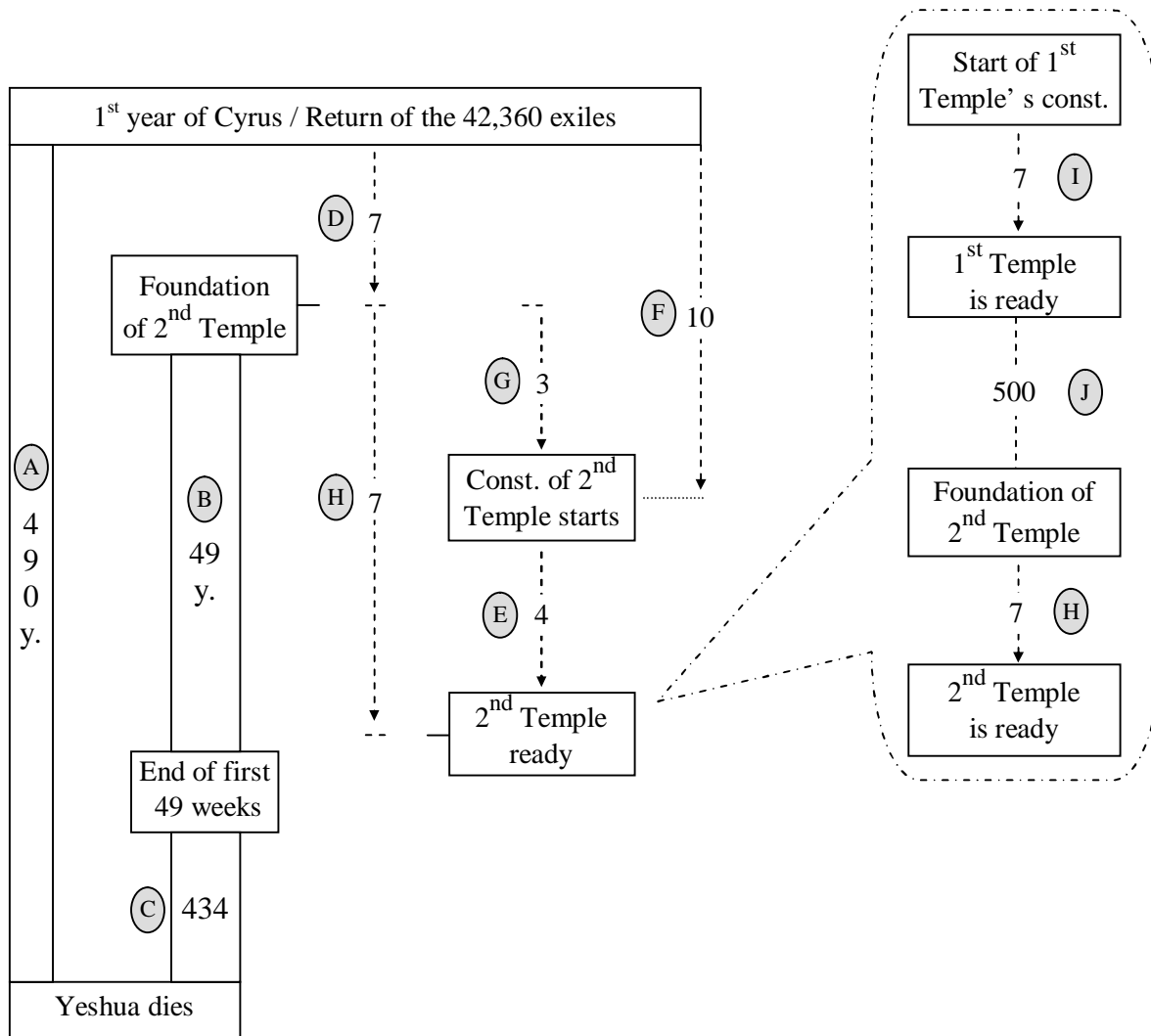

Figure 18. Second Temple period

⁸² Or 'going forth of the commandment' KJV (see Dan 9:25)

⁸³ This is the very first step toward the Temple's construction and thereby the first step to restoring and rebuilding Jerusalem. It doesn't matter that the Israelites had erected an altar in Jerusalem 6 or 7 months before given that it was made with earth or by piling a few stones one over the others. (see Ezra 3:1)

Some necessary clarifications about the timing of the events seen on the previous page:



- A: See Hair growing act on page 110
- B: First 7 weeks of Daniel's 70 weeks
- C: Next 62 weeks of Daniel's 70 weeks

- D: $A490 - C434 - B49 = 7$
- E: See Ezra 2:4 and Ezra 6:15
- F: See Figure 16. On page 107

- G: $F10 - D7 = 3$
- H: $G3 + E4 = 7$
- I: See page 54

- J: From Figure 8 on page 62
 'Temple ready' to 'Temple's dest..' = 433
 From Figure 11. On page 71
 'Temple's destruction .' to 'Return' = 60
 From $A490 - C434 - B49$
 'Return' to 'Foundation' = 7
 → $433 + 60 + 7 = 500$ years

From the previous page we know that the Foundation of the 2nd Temple occurred 3 years before the start of its construction

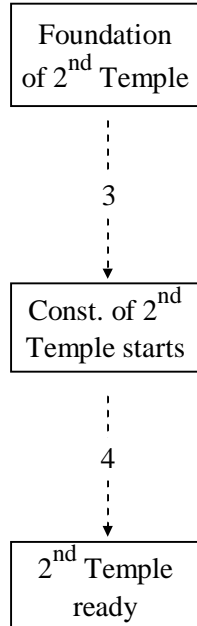

and Ezra tells us that Darius became king two years before the construction of the second Temple

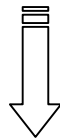
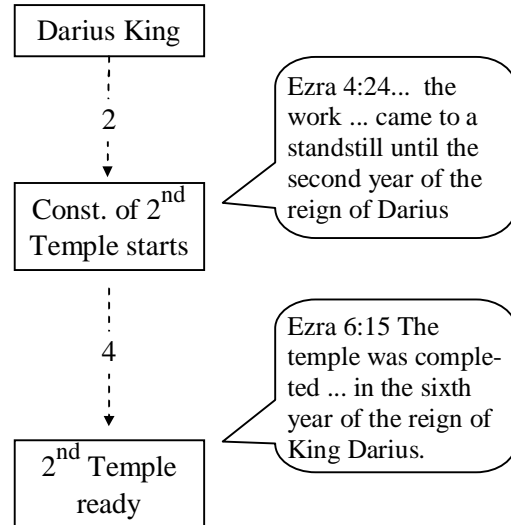

We put the information together

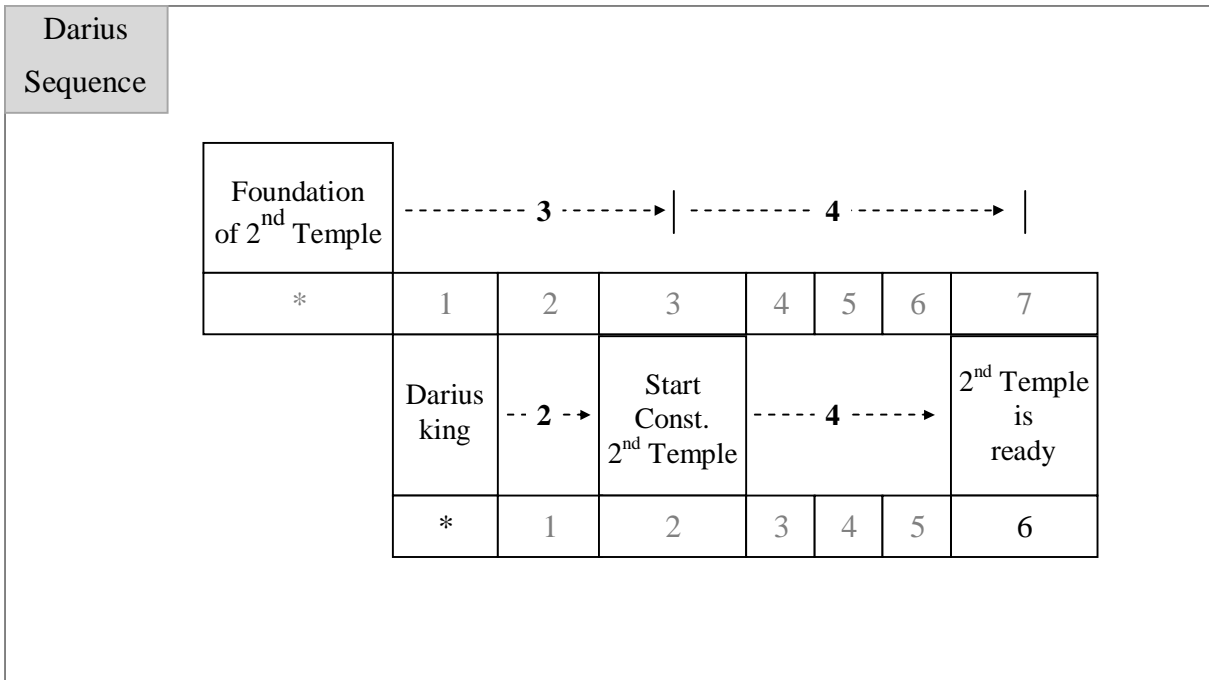

Now we will have a closer look at the period of Nehemiah:

Part 1 Connecting from an event Y

| | | |
|----------------|--|------------------|
| Event Y | | |
| * | 1-19 | 20 th |
| | Nehemiah receives some news from Jerusalem | |

Neh 1:1-2 The words of Nehemiah the son of Hachaliah. It came to pass in the month of Chislev, in 20th year, as I was in Shushan the citadel, that Hanani one of my brethren came with men from Judah; NKJV

Note: This happened in the month of **Chislev** and it was in the **20th year** of an event 'Y' that is not mentioned by name.

Note: The **unknown** event (Y) referred to by Nehemiah must have had great importance given that Nehemiah is still remembering it 20 years later.

Part 2 Connecting from king Artaxerxes

| | | | | |
|-----------------|------|--------------------|-------|------------------|
| King Artaxerxes | | Neh. meets K. Ar.. | | |
| * | 1-19 | 20 th | 21-31 | 32 th |
| | | Wall started | | Wall ended |

Nehemiah asks the King to be sent to Jerusalem

12 years to repair?

The wall was large (people walk on it), long (many huge gates), very high (to offer full protection). It had been unattended for almost 90 years beside being partly damaged or destroyed by Nebuchadnezzar's war. **Should we be surprised that it took 12 years to repair? NO**

Neh 2:1 And it came to pass in the month of **Nisan**, in the 20th year of King Artaxerxes, NKJV

Note: Here an event is connected with the **20th year of king Artaxerxes**, in the month of Nisan. Three months have gone since Neh 1:1 (Chislev – Tebeth – Adar – Nisan). Given that Nisan is the start of the new year (my working hypothesis in this book) we can rule out that this '20th year' (Neh 2:1) is the same '20th year' referred earlier in Neh 1:1.

Neh 5:14 from the time that I was appointed to be their governor in the land of Judah, from the 20th year until the 32th year of King Artaxerxes, twelve years, NKJV

Note 1: Nehemiah built Jerusalem's wall from the 20th to the 32th year of Artaxerxes.

Note 2: Neh 6:15 seems to suggest that the work on the

→ whole wall took only 52 days, it is not the case. In Neh 6:1 we are told that the wall is completed **but without the gates**. However, in Neh 6:3, the work is not stopped yet. (Why not? Because the people started to work on the gates). So, when Neh 6:3 claims that the work was completed in 52 days we need to understand that it took an additional 52 days to repair all the gates.

Merging Part 1 & 2

| | | | | | |
|---------|---|------|--|------------------|------------------|
| Event Y | | | | | |
| * | 1 | 2-19 | 20 th | | |
| | | | Nehemiah receives news 20 years after event Y | | |
| | | | Neh.. meets Art.. in the king's 20 th year, then goes to Jerusalem. | | |
| | * | 1-18 | 19 | 20 th | 32 th |
| | | | | Wall started | Wall ended |

3 months later

N E H E M I A H

's sequence



Neh 7:4 the city was large..
It took 12 years to repair the whole wall and its towers

When Nehemiah came to Jerusalem to “repair” the wall, the return of the 42,360 exiles and Jerubabel had already taken place. We deduce this from the presence of many people (priest, nobles, officials) in the city when Nehemiah inspected the wall three days after his arrival:



- Neh 2:12-13 I set out during the night with a few men. ... There were no mounts with me except the one I was riding on. ... By night I went out ... examining the walls of Jerusalem, which had been broken down, NIV
- Neh 2:16 And the officials did not know where I had gone or what I had done; I had not yet told the Jews, the priests, the nobles, the officials, or the others who did the work. NKJV

Also, when Nehemiah came to Jerusalem the 2nd Temple had already been rebuilt:

- Neh 6:10 ... and he said, "Let us meet together in the house of God, within the temple, and let us close the doors of the temple, NKJV

Nehemiah couldn't have met anybody at the Temple if it hadn't been already rebuilt. Also notice⁸⁴ that the sadness expressed in Neh 2:3 occurred just before Nehemiah came to Jerusalem. He was then overwhelmed by the knowledge that the city lay in ruins and its gates had not been repaired yet. There is no mention that Nehemiah grieved for the Temple; it can only be explained by the fact that the 2nd Temple had already been reconstructed.

Now, knowing how concerned Nehemiah was when he learned, from his brother, about the awfully neglected condition⁸⁵ of the city, also knowing that Nehemiah took upon himself to repair the wall around Jerusalem and once it was done, he took some measures to repopulate the city⁸⁶, knowing all that, wouldn't it make a lot of sense if the mysterious 'Event Y' (Neh 1:1) still remembered by Nehemiah 20 years later, happened to be the **'Foundation of the 2nd Temple'**?

The first 7 weeks of Daniel's 70-week prophecy are mostly concerned with the restoration of the city and we have already made the 'foundation of the Temple' the very beginning (see page 113) of those 7 weeks. Should we be surprised if Nehemiah the 'builder', who loved Jerusalem to the point of crying for it, had always **kept track of the years** since the 'foundation of the 2nd Temple' (rebirth of the city) and used them as the origin⁸⁷ of his personal timeline?

As we will see, this conclusion allows us to untangle the sequence of events that occurred during the first 7 weeks of Daniel's 70 weeks of prophecy.

⁸⁴ Neh 2:3 "May the king live forever! Why should my face not be sad, when the city, the place of my fathers' tombs, lies waste, and its gates are burned with fire? NKJV

⁸⁵ Neh 1:2-4 and I asked them concerning the Jews who had escaped, who had survived the captivity, and concerning Jerusalem. ... The wall of Jerusalem is also broken down, and its gates are burned with fire." So it was, when I heard these words, that I sat down and wept, and mourned NKJV

⁸⁶ Neh 11:1 ... the rest of the people cast lots to bring one out of ten to dwell in Jerusalem, the holy city, NKJV

⁸⁷ See Neh 1 :1-2

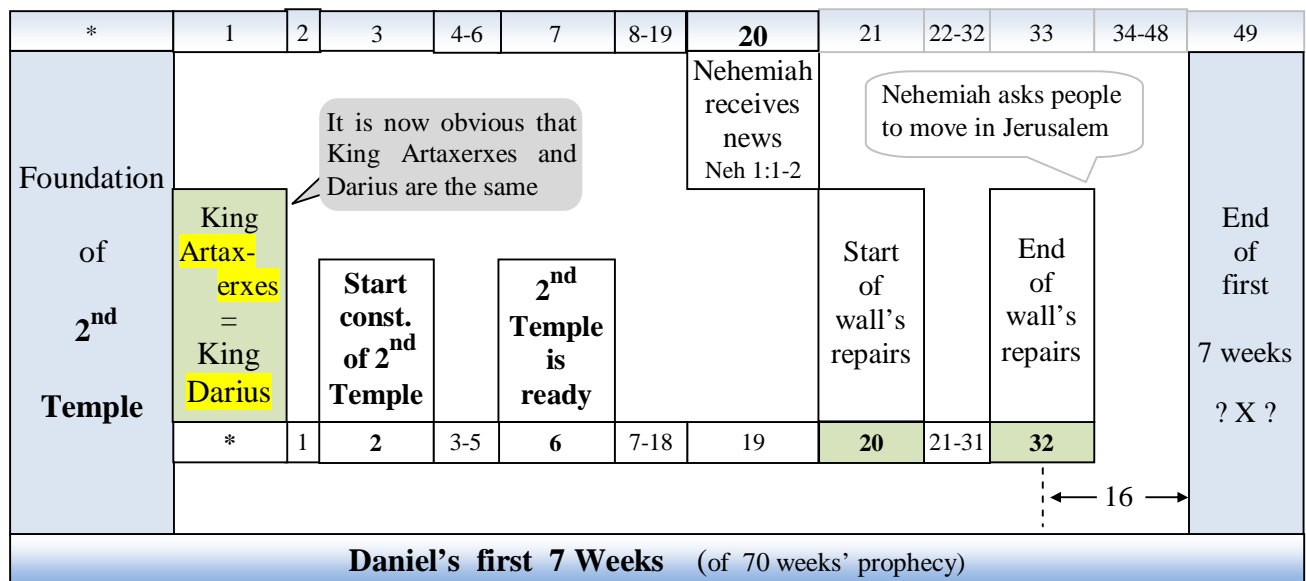
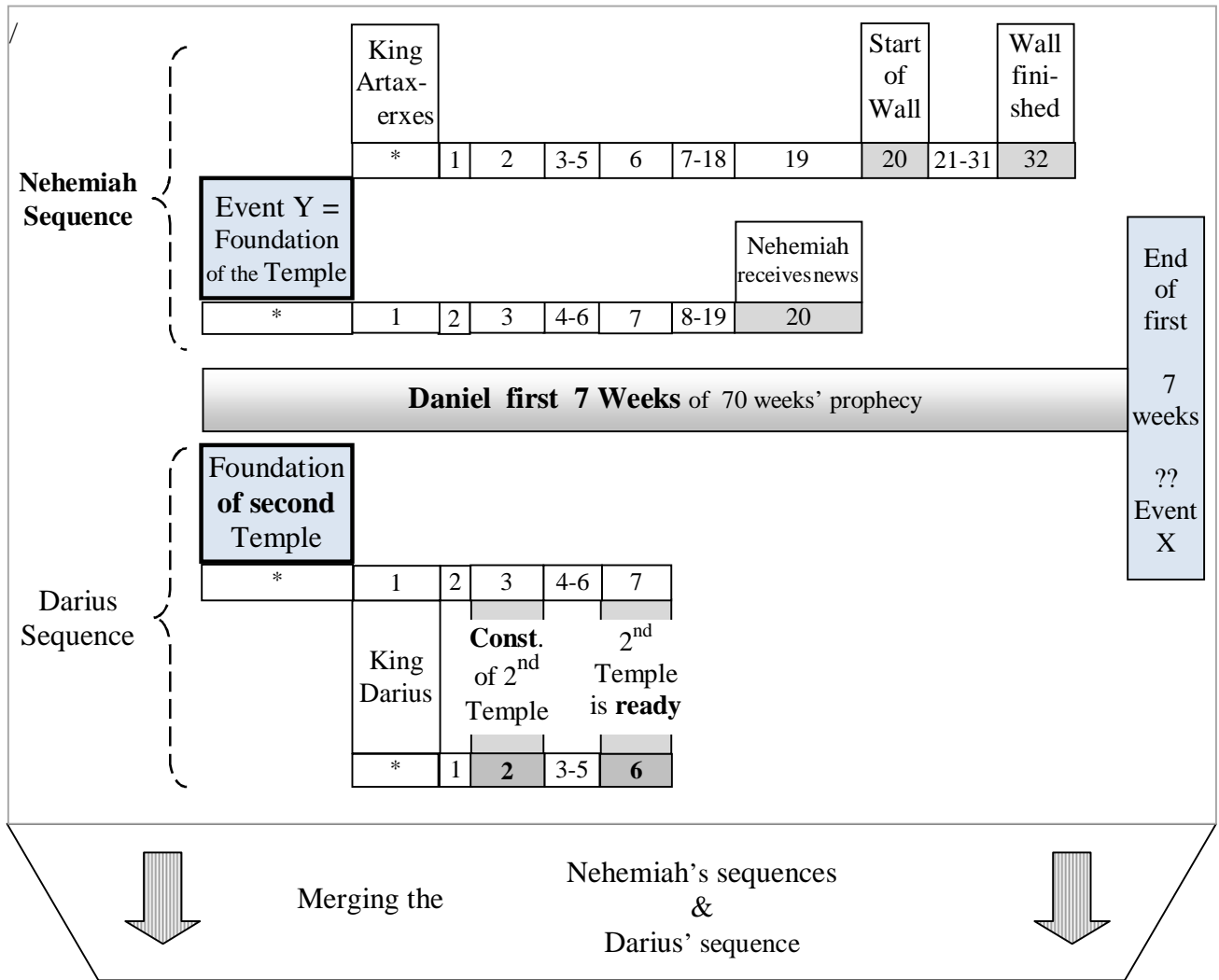
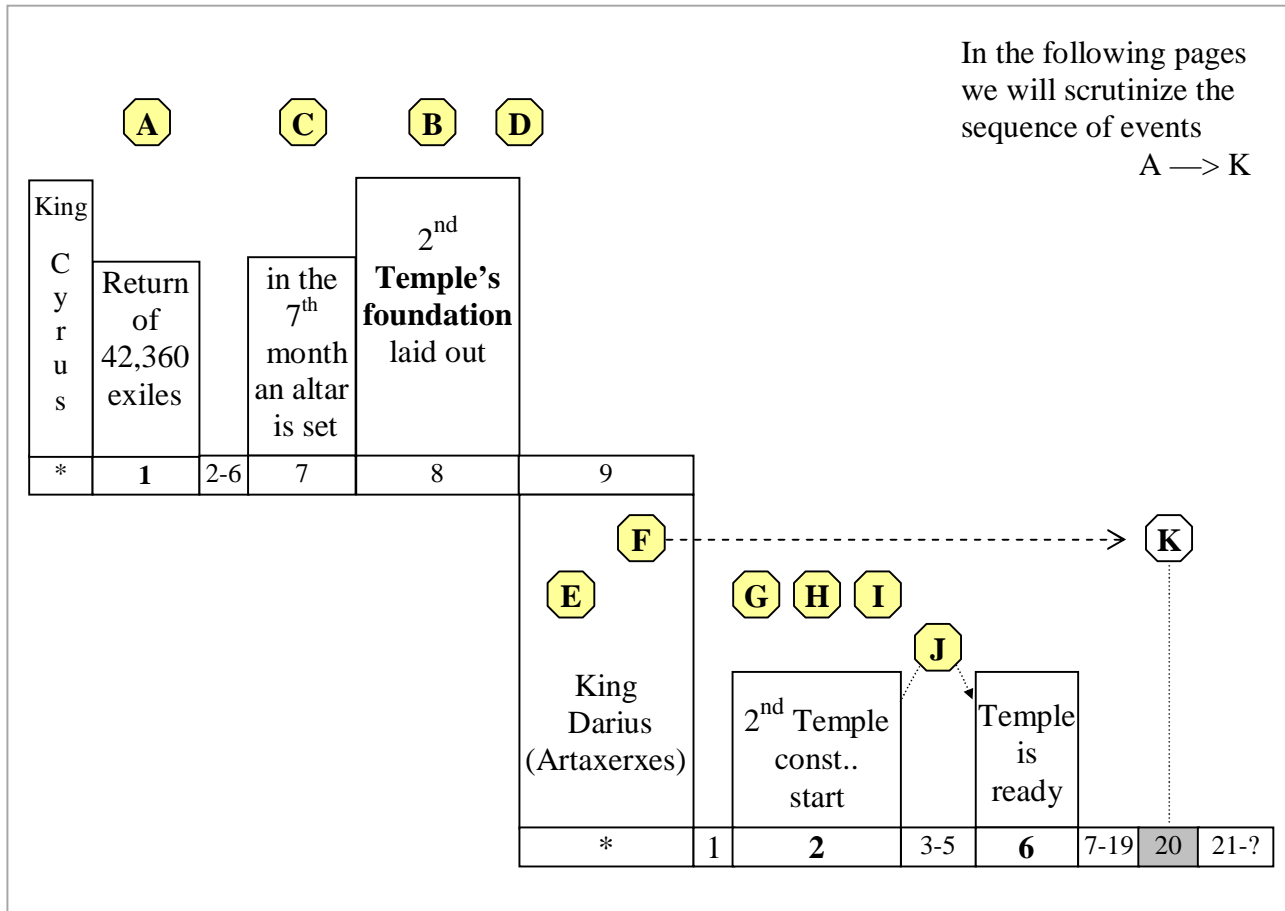

Figure 19 Post Foundation

What does Ezra have to say about the second Temple period?

Going through the book of Ezra for the first time could be a confusing experience. But, as we will see, once we have the proper sequence of events, Ezra becomes crystal clear.



A Cyrus, in the first year of his reign, allowed the exiles to return to Jerusalem and build their temple:

- Ezra 3:1 When the seventh month came, and the sons of Israel were in the towns, the people gathered as one man to Jerusalem. RSV

B According to Figure 18 on page 113 the foundation of the second Temple was laid 7 years after the ‘return of the exiles’.

C The people came to Jerusalem in the 7th month to erect an altar:

- Ezra 3:1 And when the seventh month had come, and the children of Israel were in the cities, the people gathered together as one man to Jerusalem. NKJV

This happened before the foundation of the Temple was laid

- Ezra 3:6 But the foundation of the temple of the LORD was not yet laid. KJV

In Ezra 3:8 we are told that the Israelites laid the foundation of the Temple (B) in the 2nd year of their coming to the house of God”

- Ezra 3:8 Now in the second month of the second year of their coming to the house of God at Jerusalem, NKJV

When was that? It couldn't be the second year since the exiles had return in the land, because we already know (see B) that 7 years had passed since then. To be consistent, we must conclude that they laid the foundation of the Temple the 2nd year after having erected the Altar. So, when Ezra 3:8 alludes to ‘coming to the House of God’, we have to understand that he is talking about the site where the Temple had stood before. Only ruins stood there now.

Could the Israelites have postponed coming to Jerusalem to erect an altar (and celebrate the Feast of Tabernacles as required) for 6 years? Yes. Have you notice that Ezra 3:1 does specify that the people came from their cities⁸⁸ implying that they had already settled down?

D Zerubbabel's plan was to construct the 2nd Temple right after the foundation had been laid, but then the enemies⁸⁹ of Judah came and discouraged the people, a situation that started during the time of Cyrus and prevailed until Darius (King of Persia):

- Ezra 4:4-5 Then the people of the land tried to discourage the people of Judah. They troubled them in building, and hired counselors against them to frustrate their purpose all the days of Cyrus king of Persia, even until the reign of Darius king of Persia. NKJV

Important: The enemies of Judah did their obstruction (and prevented the construction of the Temple) without involving King Cyrus. They (the enemies) knew very well that Cyrus was favorable⁹⁰ to the construction of the Temple and it would have been foolish to address him with any request to prohibit any work by the Israelites. This explains why Cyrus never received any letters of complaint from the enemies.

E It is only when Artaxerxes became king that the enemies wrote to the king. In their letter they complained to the new king that the people were rebuilding the city⁹¹ (meaning that some houses were being repaired by a few Israelites while they were waiting to work on the Temple):

- Ezra 4:6-7 At the beginning of the reign of Xerxes, they lodged an accusation against the people of Judah and Jerusalem. And in the days of Artaxerxes king of Persia, Bishlam, Mithredath, Tabeel and the rest of his associates wrote a letter to Artaxerxes.

Note: The ‘Xerxes’ of Ezra 4:6 is another name for Artaxerxes and should not be confused with the ‘Xerxes’ of the book of Esther.

⁸⁸ Given that it was 6 years after the return from exile, the people had had enough time to settle down in their ancestral cities.

⁸⁹ The enemies could be those ‘few’ who were already occupying the land when the exiles came back home.

⁹⁰ Ezra 1:2 Thus says Cyrus king of Persia: All the kingdoms of the earth the LORD God of heaven has given me. And He has commanded me to build Him a house at Jerusalem which is in Judah. NKJV

⁹¹ Because of the bad counselors, the re-construction of the 2nd Temple was still being delayed and some of the returned exiles had started working on their homes instead.

So at the beginning of his reign Artaxerxes received a letter⁹² informing him that the Jews were rebuilding the rebellious city of Jerusalem:

- Ezra 4:12 The king should know that the Jews who came up to us from you have gone to Jerusalem and are rebuilding that rebellious and wicked city. They are restoring the walls and repairing the foundations [of the city].

Upon receiving this letter King Artaxerxes had a search made in the royal archives and it was found that the city had indeed a long history of revolt:

- Ezra 4:19-20 and a search was made, and it was found that this city has a long history of revolt against kings and has been a place of rebellion and sedition.

F King Artaxerxes sent back a letter forbidding any rebuilding in Jerusalem (no houses, no wall):

- Ezra 4:21 Now issue an order to these men to stop work, so that this city will not be rebuilt until I so order.

Notice that Artaxerxes at this point was not aware that the previous king (Cyrus) had decreed the construction of the Temple. The only purpose for the search in the archives was to verify the allegation that the city had been rebellious in the past. Upon confirmation of it, Artaxerxes (Darius of Persia) ordered the returned exiles not to build anything in Jerusalem.

G In the second year of Darius (that is to say ‘Artaxerxes’) Haggai confronted the people of Judah and told them not to delay the construction of the Temple any more. As a result the people stopped building their houses⁹³, came back to Jerusalem and at long last started building the 2nd Temple:

- Hag 1:14-15 So the LORD stirred up the spirit of Zerubbabel son of Shealtiel, governor of Judah, and the spirit of Joshua son of Jehozadak, the high priest, and the spirit of the whole remnant of the people. They came and began to work on the house of the LORD Almighty, their God, on the twenty-fourth day of the sixth month in the second year of King Darius.

⁹² Ezra 4:8 Rehum the commanding officer and Shimshai the secretary wrote a letter against Jerusalem to Artaxerxes the king

⁹³ We have two strong indications that the people at that time were not building their houses inside the city of Jerusalem:

- 1) King Artaxerxes had forbidden any construction in the city. See **F**
- 2) More than 30 years later, after the completion of the wall we will see that there were still no houses in the city (Jerusalem) and Nehemiah had to take some measures to change this situation:
 - Neh 7:4 Now the city was large and spacious, but there were few people in it, and the houses had not yet been rebuilt.
 - Neh 11:1 Now the leaders of the people settled in Jerusalem, and the rest of the people cast lots to bring one out of every ten to live in Jerusalem, the holy city, while the remaining nine were to stay in their own towns.

H The enemies then sent a new letter to Darius (Artaxerxes) telling him the people had started the construction of their Temple:

- Ezra 5:7-8 The report they sent him read as follows: To King Darius: Cordial greetings. The king should know that we went to the district of Judah, to the temple of the great God. The people are building it

In this letter it was also mentioned that the people who were rebuilding the Temple, pretended that they had been authorized to do so by the late King Cyrus:

- Ezra 5:17 Now if it pleases the king, let a search be made in the royal archives of Babylon to see if King Cyrus did in fact issue a decree to rebuild this house of God in Jerusalem

I King Darius had a new search done in the archives, but this time it was to verify whether King Cyrus (the previous king) had ordered the construction of the Temple:

- Ezra 6:1-3 King Darius then issued an order, and they searched in the archives ...and this was written on it: In the first year of King Cyrus, the king issued a decree concerning the temple of God in Jerusalem:

Upon receiving the confirmation that Cyrus had previously authorized the work, Darius (Artaxerxes) issued a final edict that would quench all oppositions to the construction of the Temple once and for all.

- Ezra 6:7 Do not interfere with the work on this temple of God. Let the governor of the Jews and the Jewish elders rebuild this house of God on its site.

J The construction of the Temple lasted 4 years (from the second to the 6th year of Darius):

- Ezra 4:24 Thus the work of the house of God which is at Jerusalem ceased, and it was discontinued until the second year of the reign of Darius king of Persia. NKJV
- Ezra 6:15 Now the temple was finished on the third day of the month of Adar, which was in the sixth year of the reign of King Darius. NKJV

K Important: No matter that he allowed the Temple to be rebuilt, King Darius (aka Artaxerxes) didn't lift the interdiction (ref **F**) to construct any houses (or walls) in Jerusalem. However, it all changed in the king's 20th year when he changed his mind and granted Nehemiah the authorization to rebuild the wall. Subsequently Nehemiah asked the people to come and live in Jerusalem and build houses.

- Neh 7:4 Now the city was large and spacious, but the people in it were few, and the houses were not rebuilt.

Identifying the end of the first 7 weeks of Daniel's prophecy

The first 7 weeks (49 years) of Daniel were dedicated to the rebuilding of Jerusalem:

- Dan 9:25 It will be rebuilt with streets and a trench

Nevertheless, when Nehemiah finished the full restoration of the wall, 33 years after the beginning of Daniel first 7-week, not much had been done to reconstruct the city.

- Neh 7:4 Now the city was large and spacious, but there were few people in it, and the houses had not yet been rebuilt.

However, Nehemiah did something that would dramatically improve Jerusalem's situation by making sure that the city would become adequately populated:

- Neh 7:1 Then it was, when the wall was built and I had hung the doors,
- Neh 7:5 So my God put it into my heart to assemble the nobles, the officials and the common people for registration by families.
- Neh 11:1-2 Now the leaders of the people settled in Jerusalem, **and the rest of the people cast lots to bring one out of every ten to live in Jerusalem**, the holy city, while the remaining nine were to stay in their own towns. The people commended all the men who volunteered to live in Jerusalem.

In the previous figure (on page 118), the end of the first 7 weeks occurred 16 years after the completion of the wall. No doubt the new population of Jerusalem, introduced by Nehemiah when he finished the wall, had been quite busy during those 16 years. The rebuilding of the city could not have been completed without the repairing of the streets, construction of the houses and cleanup of the city⁹⁴.

How do we end the first 7 weeks?

Given that Daniel's first 69-week are separated into two periods (7 and 62 weeks) and the second period does end with the death of the anointed one, we are justified to seek a special event that would mark the end of the first period of 7 weeks. Are we supposed to assume that sometime during the 49th year (i.e. year ending the first 7 weeks of years) Jerusalem's last house was built and therefore this important division of Daniel's prophecy was over? Isn't there a stronger event that would justify in a more obvious way, why those first 7 weeks (of years) needed to be separated from the next 62 weeks (of years)?

- Dan 9:25 there will be **seven 'sevens,'** and sixty-two 'sevens.'

There is an important aspect of the '7 weeks' that has been neglected so far:

- Dan 9:25 It will be rebuilt with streets and a trench, **but in times of trouble.**

⁹⁴ Let's keep in mind that when Nehemiah finished the wall, Jerusalem had been almost continually deserted for 100 years.



Nobody ever paid attention to this very important clue: DAN 9:25 plainly says that the period covering the reconstruction of Jerusalem would be a period of **fear, violence and intimidation** against the Jews.



Notice what was going on during the construction of the second Temple:

- Ezra 4:4 Then the peoples around them set out to discourage the people of Judah and make them afraid to go on building.
- Ezra 4:6 At the beginning of the reign of Xerxes, they lodged an accusation against the people of Judah and Jerusalem
- Ezra 4:23 they went immediately to the Jews in Jerusalem and compelled them by force to stop.

And notice how things hadn't changed by the time they rebuilt the wall:

- Neh 4:1 When Sanballat heard that we were rebuilding the wall, he became angry and was greatly incensed. He ridiculed the Jews,
- Neh 4:8 They all plotted together to come and fight against Jerusalem and stir up trouble against it.
- Neh 4:12 "Wherever you turn, they will attack us."
- Neh 4:16 From that day on, half of my men did the work, while the other half were equipped with spears, shields, bows and armor.
- Neh 6:2 But they were scheming to harm me;
- Neh 6:14 remember also the prophetess Noadiah and the rest of the prophets who have been trying to intimidate me.

Since the whole of the first 7 weeks was going to be marked by anguish, we can deduce that something of major importance must have happened to end these 7 weeks and make the violence stop. If this had not been the case, the word '**trouble**' wouldn't have been singled out as the **major** characteristic of those first 7 weeks.

There is an event in the chronology of the post-exile that fits like a glove. This event is described in the book of Esther.

In the 12th year of King Xerxes (King Ahasuerus) the Jews from all the provinces of the Persian Empire (that would have included Jerusalem and the region around) were going to be annihilated according a king's decree obtained by the evil Haman (see Est 4:13-14).

Est 3:8-9 it is not in the king's best interest to tolerate them. If it pleases the king, let a decree be issued **to destroy them**,

Est 9:24 For Haman son of Hammedatha, the Agagite, the enemy of all the Jews, had plotted against the Jews to destroy them and had cast the pur (that is, the lot) **for their ruin and destruction.** NIV

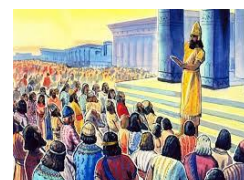

For many months afterwards it had been known that on the 13th day of the 12th month (month of Adar) people would be encouraged to kill all the Jews they could:

- Est 3:13 Dispatches were sent by couriers to all the king's provinces with the order to destroy, kill and annihilate all the Jews-young and old, women and little children-on a single day, the thirteenth day of the twelfth month, the month of Adar, and to plunder their goods.

Notice that Haman didn't contend with the immediate execution of the genocide, he rather made it known, months ahead, what was going to happen in order to better terrorize his future victims. This psychological warfare fits perfectly well with the spirit of Daniel first 7-week. Fortunately, due to a miraculous reversal of the original plan, the massacre didn't happen. King Xerxes authorized all the Jews of his kingdom to get organized and to destroy all their enemies. That day (which has been known ever since as the **Day of Purim** and has been celebrated by the Jews from all around the world), the 13th of Adar, and the next one, more than 75,000 enemies of the Jews were killed:

- Est 9:1 On the thirteenth day of the twelfth month, the month of Adar, the edict commanded by the king was to be carried out. On this day the enemies of the Jews had hoped to overpower them, but now the tables were turned and the Jews got the upper hand over those who hated them
- Est 9:16 Meanwhile, the remainder of the Jews who were in the king's provinces also assembled to protect themselves and get relief from their enemies. They killed seventy-five thousand of them but did not lay their hands on the plunder

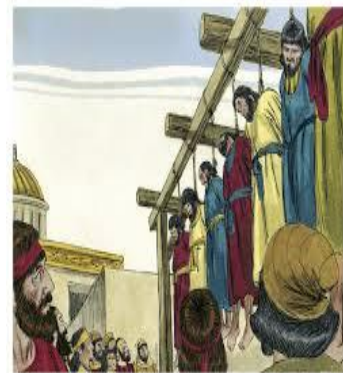

Hanging of Haman's sons
Est 9:7-10

Could there be a better event to mark the end of the first 7 weeks of Daniel? – seven weeks (49 years) that had been characterized by troubles (against the Jews) right from the start?

Let's see how we can integrate this new information with our timeline and learn even more.

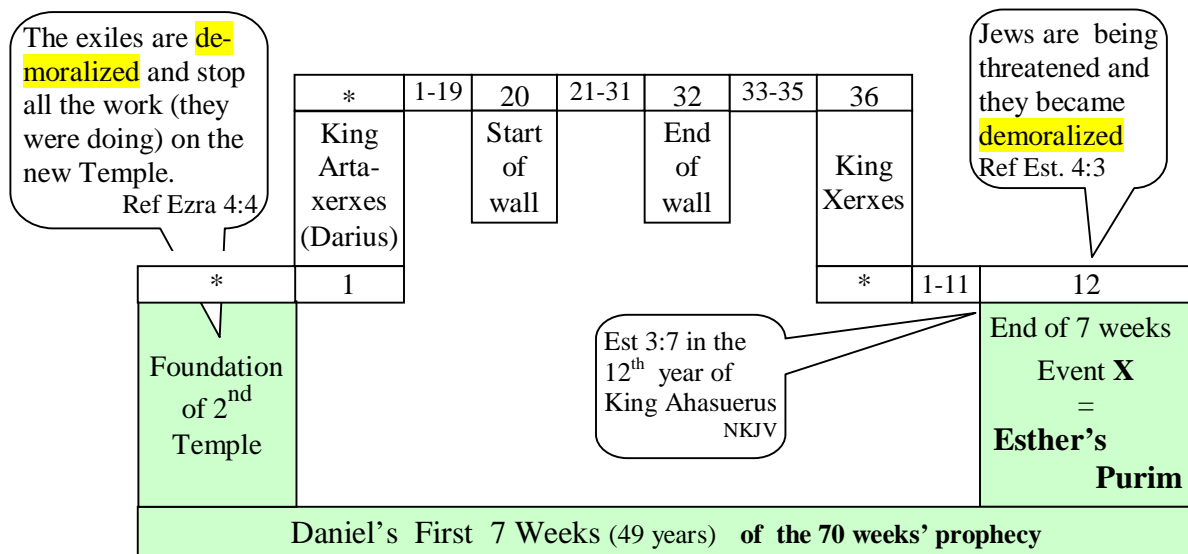

Post Exile chronology

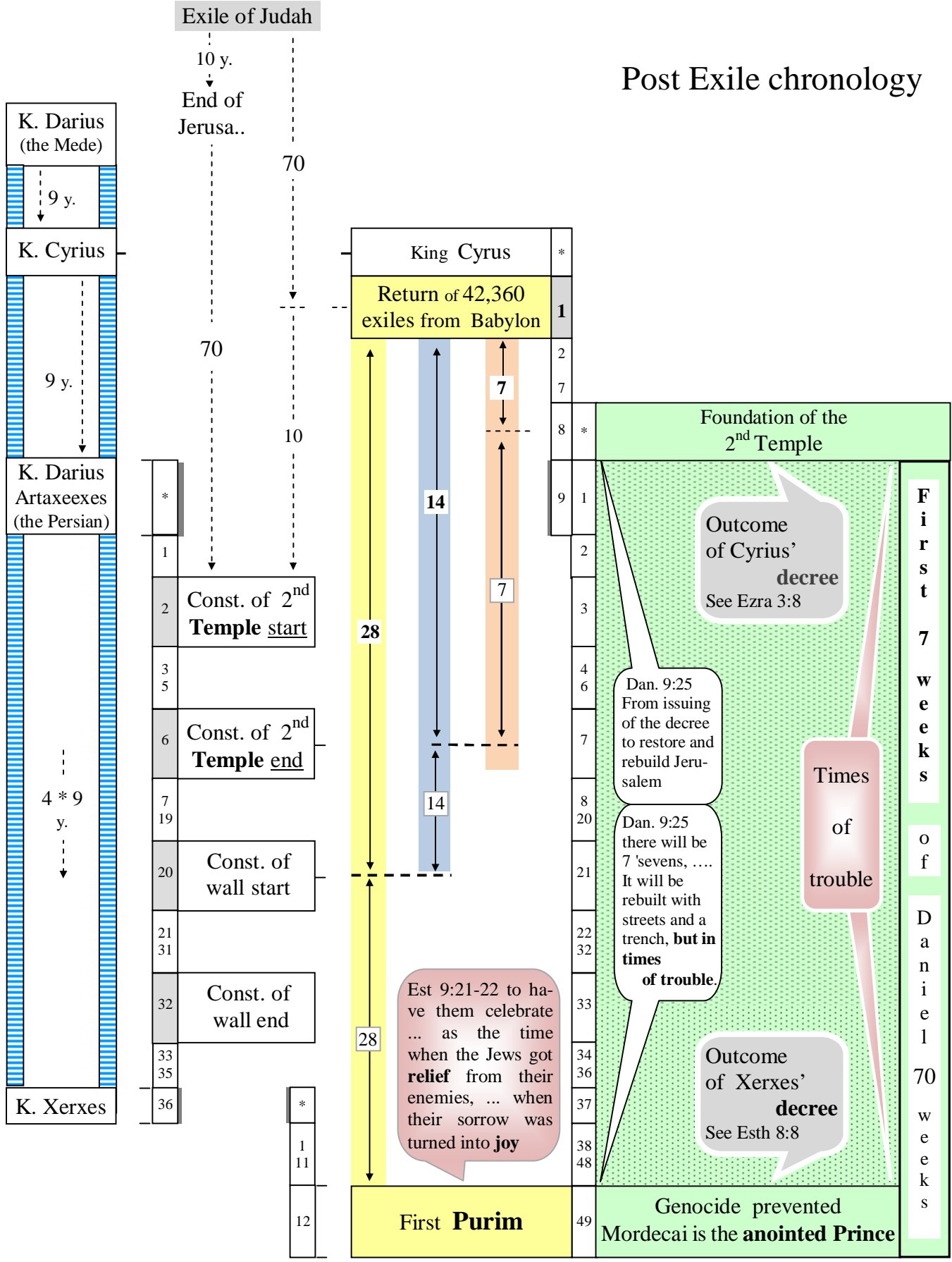

Figure 20 Post Exile chronology

Let's revisit Daniel 9:25-26.

No linguist will contest this: to really understand the structure of Daniel 9 one have to be fluent in Hebrew. Unfortunately I don't have any rudiment of this language. However I do have an invaluable tool that compensate this shortcoming: a solid post exile chronology.

A few facts to keep in mind

Dan 9:25 Know therefore and understand that from the going forth of the word to **restore and build Jerusalem** to the coming of an anointed one, a prince, there shall be seven weeks. Then for sixty-two weeks it shall be built again with squares and moat, but in a troubled time. ²⁶And after the sixty-two weeks, an anointed one shall be cut off, and shall have nothing; and the people of the prince who is to come shall destroy the city and the sanctuary. Its end shall come with a flood, and to the end there shall be war; desolations are decreed. (RSV translation)

1. This establishes that the 7 weeks and the 62 weeks follow each other without any intervening gap.
2. the coming of an anointed one, a prince is associated with the end of the first 7 weeks.
3. Contrary to what is said in the RSV translation we have seen earlier that 'the time of trouble' fits perfectly well with the first 7 weeks. Therefore we can doubt that it has anything to do with the 62 weeks period.
4. An individual is associated with each period

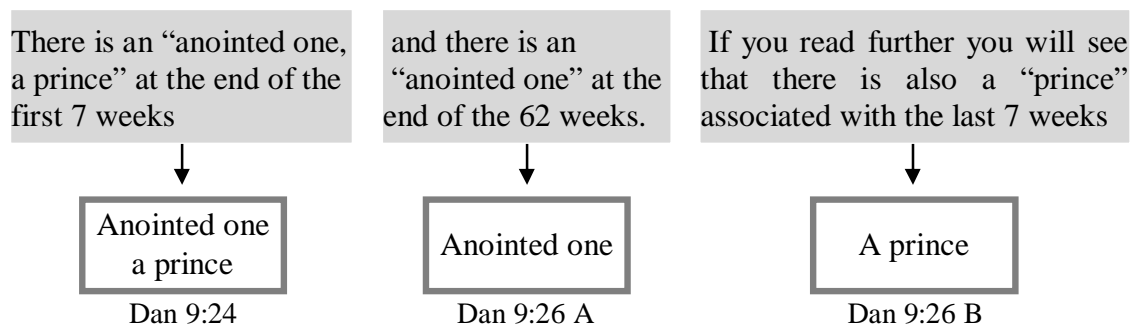

In the previous page we have associated the end of the first 7 weeks of Daniel with the establishment of Purim. We can now point to the real identity of the 'Anointed one, the Prince' mentioned in Daniel 9:24. Without doubts it can be no one else than **Mordecai** (Queen Esther's uncle).

- Est 8:15 Mordecai left the king's presence **wearing royal garments of blue and white, a large crown of gold** and a purple robe of fine linen. NIV
- Est 9:4 Mordecai was prominent in the palace; his reputation spread throughout the provinces, and he became more and more powerful. NIV
- Est 10:3 **Mordecai the Jew was second in rank to King Xerxes**

Daniel 62 weeks

At the time of First Purim
Anointed one a prince = **Mordecai**

← 434 years →

At the time of crucifixion
Anointed one Cutt off = **Yeshua**

The king honored Mordecai
by giving him a royal treatment

Est 6:11 So Haman took the robe and the horse, arrayed Mordecai and led him on **horseback** through the city square, and proclaimed before him, "Thus shall it be done to the man whom the king **delights to honor!**" NKJV



The crowd welcomed Yeshua
with a royal treatment

On the day the Passover lamb were selected, Yeshua, sitting on a **colt**, make a grand entry in Jerusalem under the praise of the crowd. Luke 19:38 " **'Blessed is the King** who comes in the name of the LORD!' Peace in heaven and glory in the highest!" NKJV

Mordecai wore royal clothes

Est 8:15 So Mordecai went out from the presence of the king in royal apparel of blue and white, with a great crown of gold and a garment of fine linen and purple NKJV



Yeshua is dressed up as a king

Mark 15:17 And they clothed Him with purple; and they twisted a crown of thorns, put it on His head, NKJV

Because of one man (Mordecai)
they plotted to kill all the Jews

Est 9:24 Haman, the son of Hammedatha the Agagite, the enemy of all the Jews, had plotted against the Jews to annihilate them, NKJV



To save all the Jews they plotted to kill
one man (Yeshua)

John 11:50-51 Nor consider that it is expedient for us, that one man should die for the people, and that the whole nation perish not. And this spake he not of himself: but being high priest that year, he prophesied that Jesus should die for that nation; KJV

All the Jews defended themselves

Est 9:5 Thus the Jews defeated all their enemies with the stroke of the sword, with slaughter and destruction, and did what they pleased with those who hated them. NKJV



Yeshua was slaughtered

Isa 53:6-7 And the LORD has laid on Him the iniquity of us all. He was oppressed and He was afflicted, ... He was led as a lamb to the slaughter, NKJV

Mark 15:20 and led Him out to crucify Him.

Daniel 62 weeks

Daniel's 70 Weeks: A time allotment directly related to the 2nd and 3rd Temple

In this book you have learned that the first 7-week starts with the 'Foundation' of the second Temple. We already know that the 62 weeks ends with Yeshua's death. Less obvious is the fact that the end of those 62-week coincides also with the SYMBOLICAL end of the second Temple? Here is how:

| | | |
|-------------------------|--|--|
| At Yeshua's death | a Temple of God was also destroyed the 2 nd Temple lost its legitimacy | <div style="border: 1px solid gray; padding: 5px; margin-bottom: 5px;"> John 2:19 Jesus answered them, "Destroy this temple, and I will raise it again in three days." NIV </div> <div style="border: 1px solid gray; padding: 5px; margin-bottom: 5px;"> John 2:21 But the temple he had spoken of was his body. </div> <div style="border: 1px solid gray; padding: 5px; margin-bottom: 5px;"> Matt 27:51-52 At that moment the curtain of the temple was torn in two from top to bottom </div> <div style="border: 1px solid gray; padding: 5px;"> Several supernatural acts took place in the Temple for the next 40 years (see box on page 155). Each one indicating that the Temple was doomed. </div> |
|-------------------------|--|--|

And the 70th week of Daniel will overlap a third Temple period in Jerusalem.

Given that the end of the 70th week of Daniel will come like a flood (Dan 9:26) it cannot coincide with the physical destruction of the 2nd Temple around 70 AD. Why? Because a war had been going on for three years before the destruction of the 2nd Temple, this was far from the context of a **flood suddenness**. In fact the context of the 70th week points to an end time 7 years during which a third Temple will stand. Notice the need for this third Temple in

Dan 9:27 He will confirm a covenant with many for one 'seven.' In the middle of the 'seven' he will put an end to sacrifice and offering. And on a wing [of the temple] "

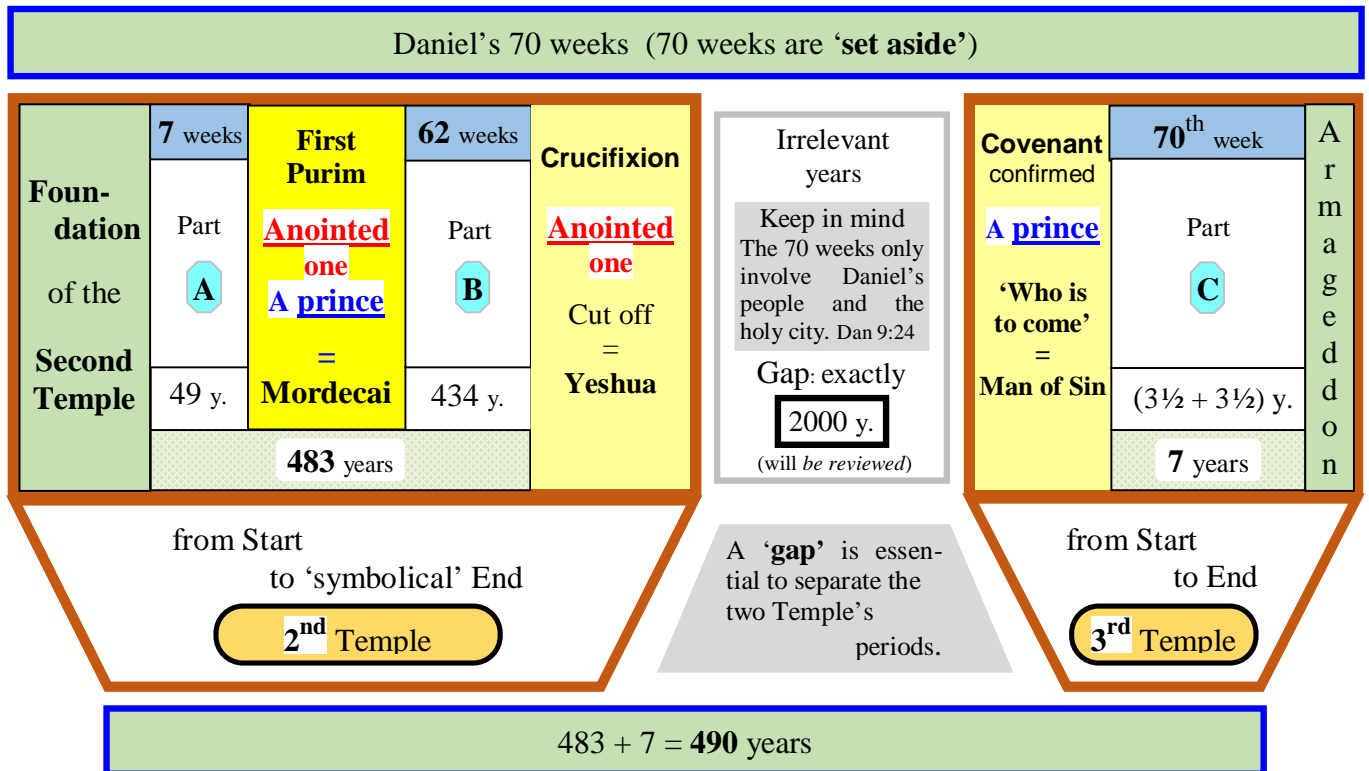

Remarkable The first 69 weeks are related to the second Temple while the 70th week points to the third Temple era. Don't we have here a proof that the gap is totally legitimate? Never before the 70 weeks of Daniel have been associated to the Temples.

There is another good reason to insert a gap between the first 69 weeks and the 70th. We are told in Dan 9:24 that 70 weeks are necessary to accomplish the following 6 major goals:

- Dan 9:24 Seventy weeks are determined upon thy people and upon thy holy city, (1) **to finish the transgression**, and (2) **to make an end of sins**, and (3) **to make reconciliation for iniquity**, and (4) **to bring in everlasting righteousness**, and (5) **to seal up the vision and prophecy**, and (6) **to anoint the most Holy**.

The first three goals were completed during Yeshua's first coming (i.e. at Yeshua's death when He was cut off at the end of the first 69 weeks.)

| # | Goal | Ref | |
|---|---|---|---------------------|
| 1 | To finish the transgression | Isa 53:5 But he was pierced for our transgressions, NIV Isa 53:8 for the transgression of my people he was stricken. NIV | Yeshua first coming |
| 2 | To make an end of sins | 1 John 2:1-2 we have one who speaks to the Father in our defense-Jesus Christ, the Righteous One. He is the atoning sacrifice for our sins, and not only for ours but also for the sins of the whole world. NIV Heb 9:26 But as it is, he has appeared once for all at the end of the age to put away sin by the sacrifice of himself. RSV | |
| 3 | To make reconciliation for iniquity (“to make atonement or expiation”) | Isa 53:5 he was crushed for our iniquities; Isa 53:6 and the LORD has laid on him the iniquity of us all. NIV Rom 3:25 God presented him as a sacrifice of atonement, NIV | |

But the last 3 goals can only be achieved during the second coming

| # | Goal | Ref | |
|---|---------------------------------------|--|----------------------|
| 4 | To bring in everlasting righteousness | See below for an extract of the article THE SEVENTY SEVENS OF DANIEL by Dr. Arnold G. Fruchtenbaum of Ariel ministry | Yeshua second coming |
| 5 | To seal up the vision and prophecy | | |
| 6 | To anoint the most Holy | | |

#4 To Bring in an Age of Righteousness

“to bring in an age of righteousness.” This is the real meaning of the Hebrew word for everlasting. This age of righteousness is called the Messianic Kingdom or the Millennium. This is the same point made by Isaiah 1:26; 11:2-5; 32:17; Jeremiah 23:5-6; and 33:15-18. (Dr. Arnold G. Fruchtenbaum)

#5 To Cause a Cessation of Prophecy

“to bring completely to fulfillment.” The word *vision* refers to oral prophecy such as the prophecies of Elijah and Elisha. The word *prophecy* refers to prophecy found in written form in the writing prophets such as Isaiah, Jeremiah, Ezekiel, and in the twelve Minor Prophets. The fifth purpose of the Seventy Sevens is to cause a cessation of both oral and written prophecy, because the program of the Seventy Sevens will contain the final fulfillment of all prophecies. (Dr. Arnold G. Fruchtenbaum)

#6 To Anoint the Most Holy Place

From the Hebrew, it should actually read “to anoint a most holy place.” It is not a most holy person, but a most holy place that is to be anointed. The most holy place is the Temple. (Dr. Arnold G. Fruchtenbaum)

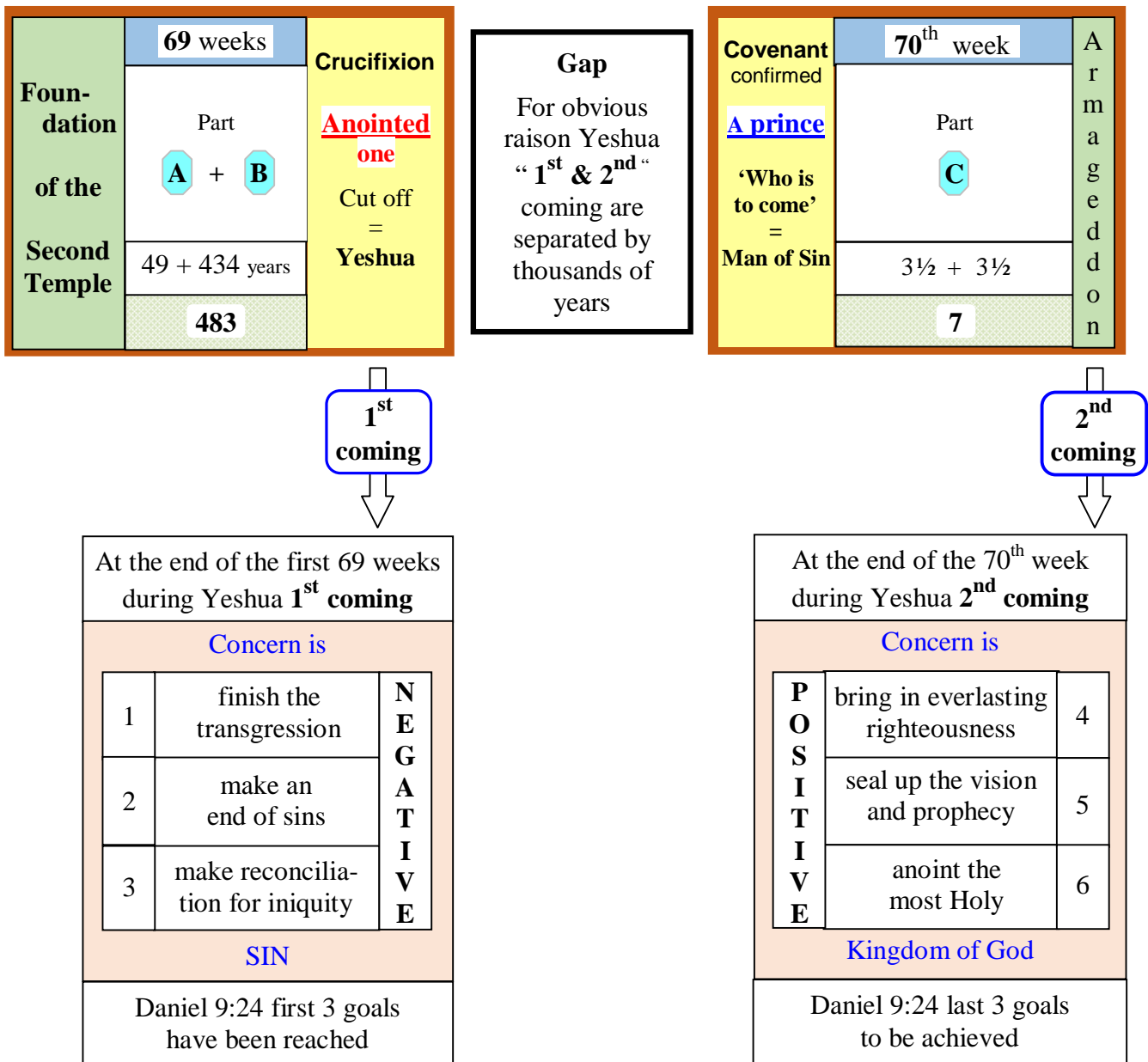

Ezekiel fasts during 40 days

(this symbolical act is the counterpart to 'Ezekiel ate defiled food for 390 days' on page 66)

God originally intended to have Ezekiel cook his food over human excrement. However, this ordeal was lightened following Ezekiel's objection that he had never defiled himself in the past.

- Ezek 4:14 So I said, "Ah, Lord GOD! Indeed I have never defiled myself from my youth till now; I have never eaten what died of itself or was torn by beasts, nor has abominable flesh ever come into my mouth."

Ezekiel's food was cooked over cow manure, an acceptable compromise to the prophet.

- Ezek 4:15 Then He said to me, "See, I am giving you cow dung instead of human waste, and you shall prepare your bread over it."

Apparently Ezekiel's food was still symbolically defiled, no matter how it was cooked.

- Ezek 4:13 "So shall the children of Israel eat their defiled bread among the Gentiles,

So, after 390 days of eating defiled food, Ezekiel turned over and fasted⁹⁵ for a period of 40 days. We saw earlier (see page 66) that the prophet eating defiled food was a symbolical act portraying a period during which Israel would only hear lies instead of the true words of God. In a way Israel was given poisonous food for the mind. What then should we think of the prophet fasting during 40 days? There is such a powerful contrast between Ezekiel two successive actions (eating defiled food – fasting) that we should also find a similar contrast between the two periods portrayed by them.

Symbolically, Ezekiel's 40 days fast (while lying on his right side) was like cleansing 'purging' his body. This is the characteristic that we will use to identify the intended period associated with the house of Judah. Indeed, at one point the people of Judah must have gone through a radical change that literally initiated what would become a '40 years cleansing period'. And, to mark the end of that 40 year period, we should also find the occurrence of another event that will 'metaphorically' denote how Judah's cleansing ended and how the people were reintroduced to a proper food for the mind.

The period portrayed by the symbolical act "**Ezekiel fasts during 40 days**" will have to meet the following criteria:

- Should start with an important change: (lies and idolatry ceased)
We are contrasting 'Ezekiel feeding from defiled food during 390 days'
with 'Ezekiel fasting during 40 days'.
- Absence of any 'indoctrination' during 40 years. (portrayed by Ezekiel's fasting)
- Should end with an important change: (adequate learning was provided again)
Keep in mind that after his 40 days fast, Ezekiel started feeding himself again.

⁹⁵ This is implied by the absence of food during the time Ezekiel lied on his right side.

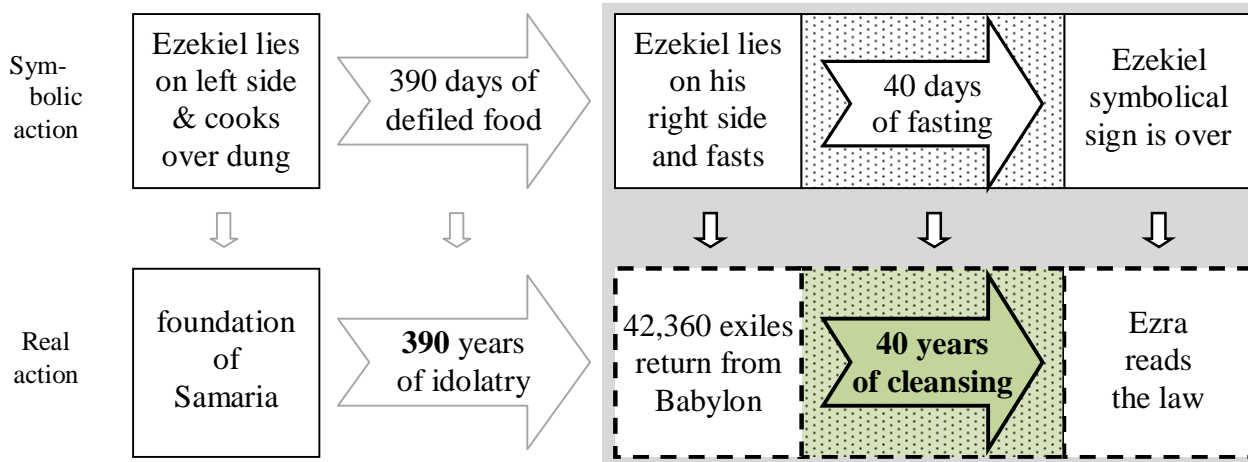

The ‘return of the 42,360 exiles’ points to the time when Judah (under the leadership of Zerubbabel) came back from the Babylonian captivity. This event is the perfect candidate to mark the start of the 40 years cleansing period we are looking for. Indeed, as illustrated in the next figure, the return of the exiles marked the end of a 390 year period characterized by the proliferation of false prophets and the spreading of idolatry. The people of Judah spent the last 70 years of this 390 year period in Babylon, an environment associated with paganism.

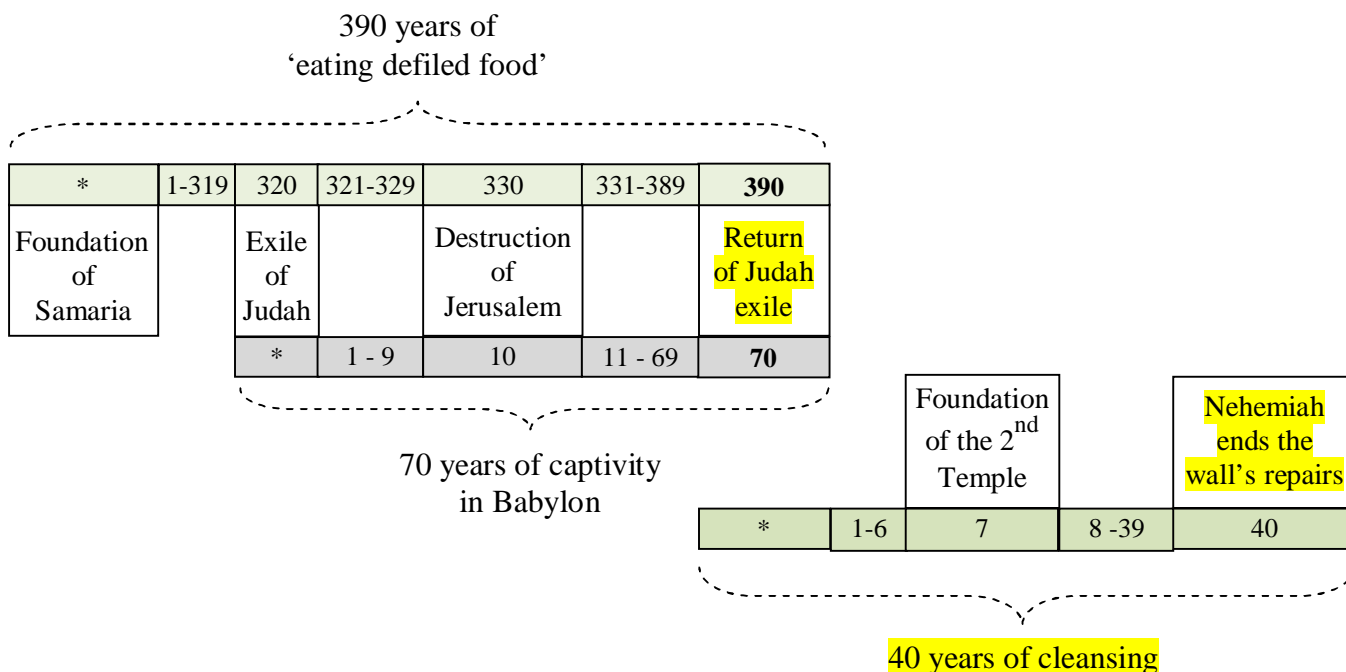

When they came back from captivity, the 42,360 exiles of Judah didn’t receive any teaching of the law of God for a very long time (40 years). What preoccupied them at the time was rebuilding the country, the cities, the houses, the Temple, and to repair the wall of Jerusalem that Nebuchadnezzar’s army had left in ruin 60 years before. This 40 years without exposure to idolatry and hearing any law of God can be viewed as a 40 years of cleansing.

The restoration of the wall surrounding Jerusalem was completed 40 years after the Return of the Exiles (see figure page 126)

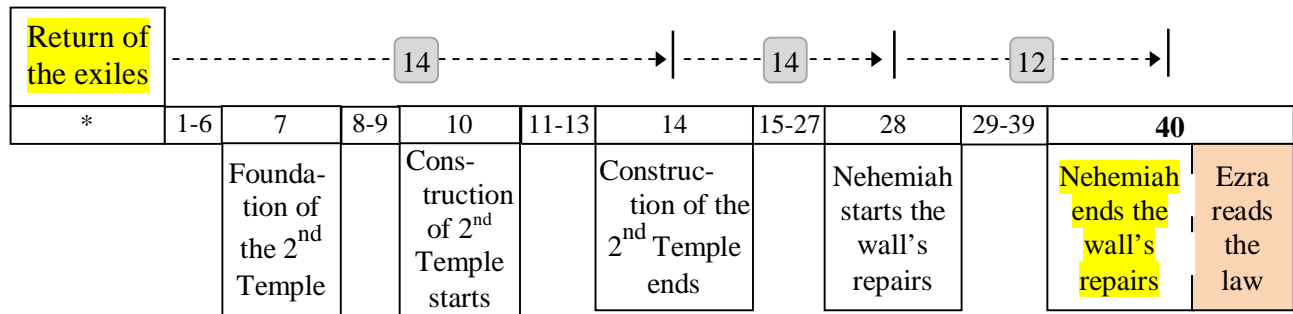

A very short time after the wall was fully repaired, the law of God was read by Ezra. It was the first time in centuries that the people of Judah heard it.

- Neh 6:15 So the wall was completed on the twenty-fifth of Elul, in fifty-two days. NIV (i.e. 12 years to repair the wall, 52 days to repair the gates)
- Neh 7:11 After the wall had been rebuilt and I had set the doors in place NIV
- Neh 7:73-8:1 When the seventh month came and the Israelites had settled in their towns, all the people assembled as one man in the square before the Water Gate. **They told Ezra the scribe to bring out the Book of the Law of Moses**, which the LORD had commanded for Israel. NIV

The reading of the law (about 6 days after Nehemiah completed the repairs on the wall) marks the end of the 40 years of cleansing that the people of Judah went through after the return from Exile. Notice how Ezekiel two consecutive symbolical acts (eating defiled food during 390 days, fasting during 40 days) portray two successive periods.

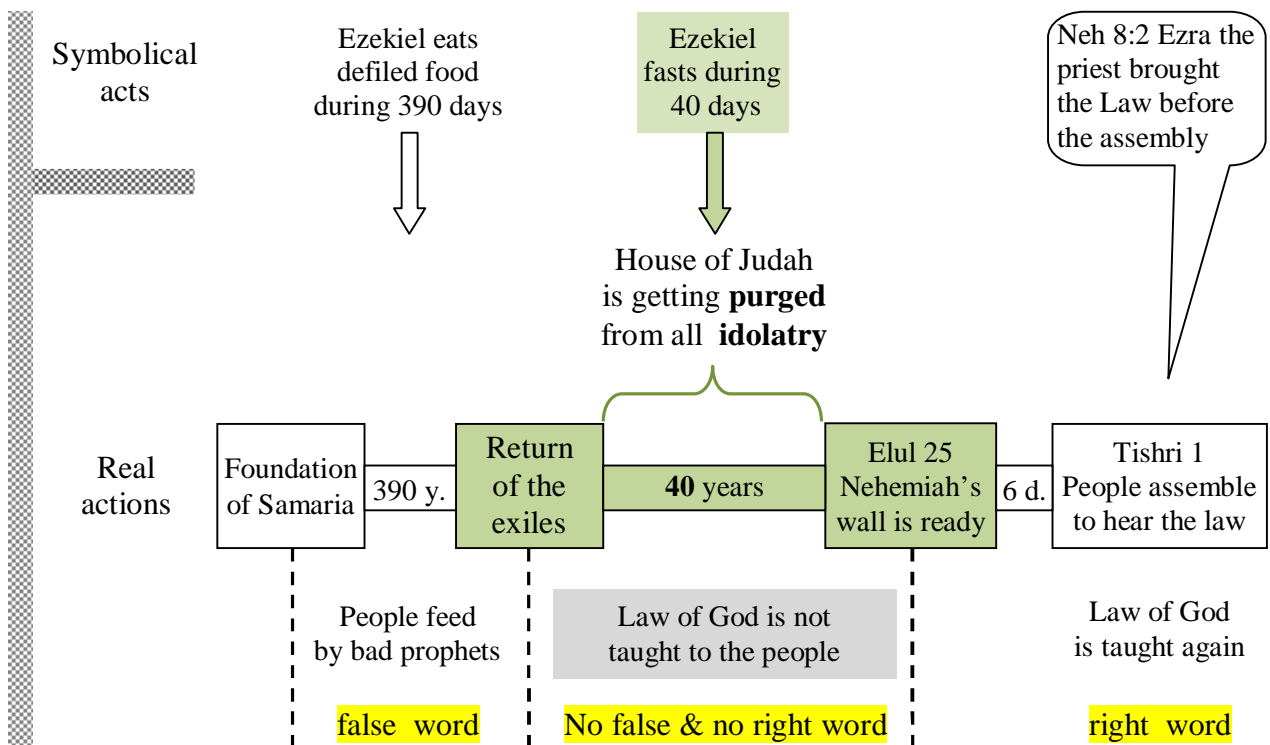

Ezekiel's famine of words

Right from the beginning of his call Ezekiel was given an absolutely clear mandate. He would be sent among his brothers Israelites as a prophet and would have to tell them that their ways were doomed:

- Ezek 2:4 and you shall **say** to them, 'Thus says the Lord GOD.' NKJV
- Ezek 2:7 You shall **speak** My words to them NKJV
- Ezek 3:1 and go, **speak** to the house of Israel. NKJV
- Ezek 3:4 "Son of man, go to the house of Israel and **speak** with My words to them.
- Ezek 3:11 ... and **speak** to them and tell them, 'Thus **says** the Lord GOD NKJV
- Ezek 3:18 When I say to the wicked, 'You shall surely die,' **and you give him no warning, nor speak** to warn the wicked from his wicked way, NKJV

Ezekiel was not allowed to refuse God's call. No matter what, he would be accountable should he fail to relay the appropriate warning to the wicked:

- Ezek 3:20 because you did not give him warning, he shall die in his sin, and his righteousness which he has done shall not be remembered; but his blood I will require at your hand. NKJV

As we can see from the previous references, Ezekiel was reminded again and again that he would have to talk to his people. But then, just when Ezekiel should have started to fill his assignment, **the most unexpected thing happened.** Ezekiel was asked to go and shut himself in his house (Ezek 3:24). And the Spirit deliberately stuck Ezekiel's tongue to the roof of his mouth to incapacitate the prophet in such a way that **it became impossible for him to orally communicate with others:**

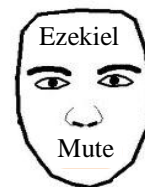

- Ezek 3:26 I will make your tongue cling to the roof of your mouth, so that you shall be mute and not be one to rebuke them

From then on Ezekiel would be allowed to talk only after being spoken to by the spirit:

- Ezek 3:27 But when I speak to you, I will open your mouth and you shall say to them,

Notice that Ezekiel was sent to his home as soon as he became mute. Given that the Spirit didn't speak to him again until (see Ezek 8:1) the 5th day of the 6th month of the 6th year, we can rightly deduce that Ezekiel didn't talk to anybody during the time he was lying on his sides:

- Ezek 8:1 And it came to pass in the sixth year, in the sixth month, on the fifth day of the month, as I sat in my house with the elders of Judah sitting before me, NKJV
- Ezek 8:5 Then He said to me, NKJV

So to stress what is now obvious: Ezekiel, the prophet, specially commissioned to talk to his brothers the Israelites, spent 430 days lying on his side, being unable to speak. During these 430 days, Ezekiel didn't receive and didn't deliver any word from God. Doesn't this strange situation make a lot more sense if we recognize that Ezekiel's period of silence was yet another symbolic act? Ezekiel's 430 days of silence are screaming to draw our attention to a **famine of words** that was going to prevail for some 430 years.

- Amos 8:11-12 "Behold, the days are coming," says the Lord GOD, "That I will send a famine on the land, Not a famine of bread, Nor a thirst for water, **But of hearing the words of the LORD.** They shall wander from sea to sea, And from north to east; They shall run to and fro, seeking the word of the LORD, But shall not find it. NKJV

Now, starting at the time of the ‘Covenant between the parts’ and moving forward, using some of the indicators previously seen in this paper, can we pinpoint a 430-year period during which there was, in all likelihood, no communication from God? Yes, and it can be done without any difficulty. The following timeline shows six successive periods obtained by the use of 7 events already seen in this paper. The easiest way to isolate the period of silence we are looking for is to disqualify each period during which God maintained some form of communication with the Israelites. Inevitably⁹⁶ only the right period will remain.

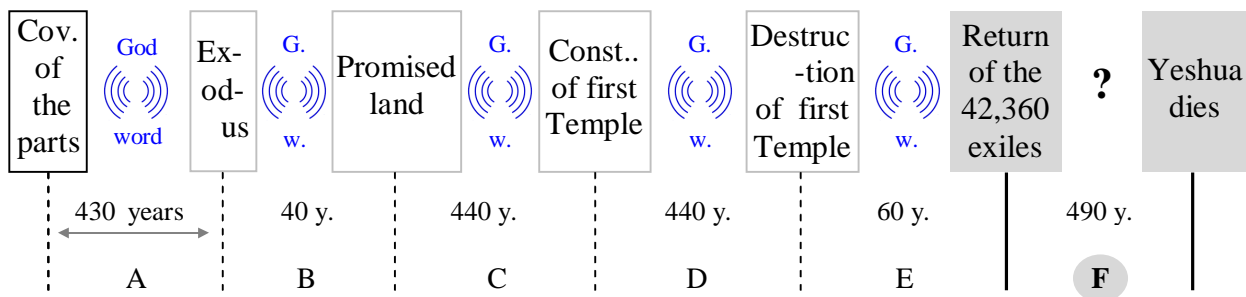

References to each period:

- A : Figure 14. Covenant between the parts on page 87
- B : Figure 2. Land divided on page 18
- C : Figure 8. Blocks 1 and 3 reunited on page 62
- D : Figure 8. Blocks 1 and 3 reunited on page 62
- E : Figure 15. Shaving act on page 90
- F : Figure 17. Hair growing act on page 110

From what we know, there was communication from God or His prophets during period (A,B,C,D,E). This leave period ‘F’ as the only period worthy of investigation. Was there a 430-year ‘Famine of the words’ sometime during this 490-year period F? I believe so.

We saw earlier (on page 126) that 56 years after the return of the exiles one reaches Esther’s first Purim⁹⁷. In the book of Esther⁹⁸ an amazing sequence of coincidences conspire to save the Jews from annihilation. It is obvious to the readers of the Book of Esther that God was behind the scene to help his people right from the start.

The day after they had killed all their enemies, the Jews of the Persian empire had an opportunity to collectively thanks God and to exalt His name. Unfortunately none of this happened. Instead, Esther and Mordecai, two of the four⁹⁹ story’s characters, institutionalised a new feast to mark the time of the Jewish’s salvation from Haman national holocaust. They called that feast ‘**PURIM**’, a name that commemorates “LOT” (or cast lot) **the exact opposite of acknowledging God’s genuine involvement.** Since then, each year, the Jews acknowledge the good fortune they had by exchanging gifts between themselves and by remembering what Mordecai and Esther had done for them (as oppose to what God had done for them).

⁹⁶ We rule out that there was more than one ‘famine of words’ that could have lasted 430 years.

⁹⁷ I seems an appropriate name for the very first occurrence of that feast

⁹⁸ Trivialized by everybody, there is a shocking absence in the book of Esther: **the name of God is never mentioned.** It is *the only book of the Hebrew Bible that doesn’t mention God.* According to *the Jewish sages there is a play of words using the name Esther in Hebrew that could mean ‘hiding of the face’.*

⁹⁹ King Xerxes, Haman the Agagite, Mordecai the Jew and his niece Esther.

Doesn't this situation remind us of a similar circumstance when the Israelites had rejected God and asked to have a king (Saul) to be chosen among them? They did obtain their king at that time but at this terrible price: "30 years later they lost the divine protection they had enjoyed during the previous **430 years** (see p.58-59)". Again, with this new Purim feast, the Jews overlooked what God had done for them and choose to honor their new hero Mordecai, the one **who had spoken** for their welfare.

Reminiscent of the Saul's episode, Mordecai was exalted to a royal position in the eyes of the Jews (Note: Saul and Mordecai were both descendant of Kish, a Benjamite)

- Est 8:15 So Mordecai went out from the presence of the king in royal apparel of blue and white, with a great crown of gold and a garment of fine linen and purple; NKJV

Clearly, God was again inflicted a major affront from his chosen people and apparently, in spite of having saved every Jew from death, He didn't **spoke loud enough**. Did God react to this new contempt? How about ignoring them and keeping **silent** (hidden) for the next **430 years**?

Noise & Silence

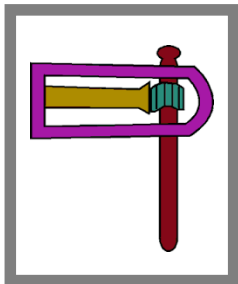

One tradition, still in force nowadays, when listening to the book of Esther being read, is to **drown out** the name of Haman whenever it is heard with **noise and "booming"**.

Deut 32:20 "I will hide my face from them"

According to the Jewish belief, after the Megillat Esther there were no more prophets, no more miracles, no more communication from God. **"only silence"**

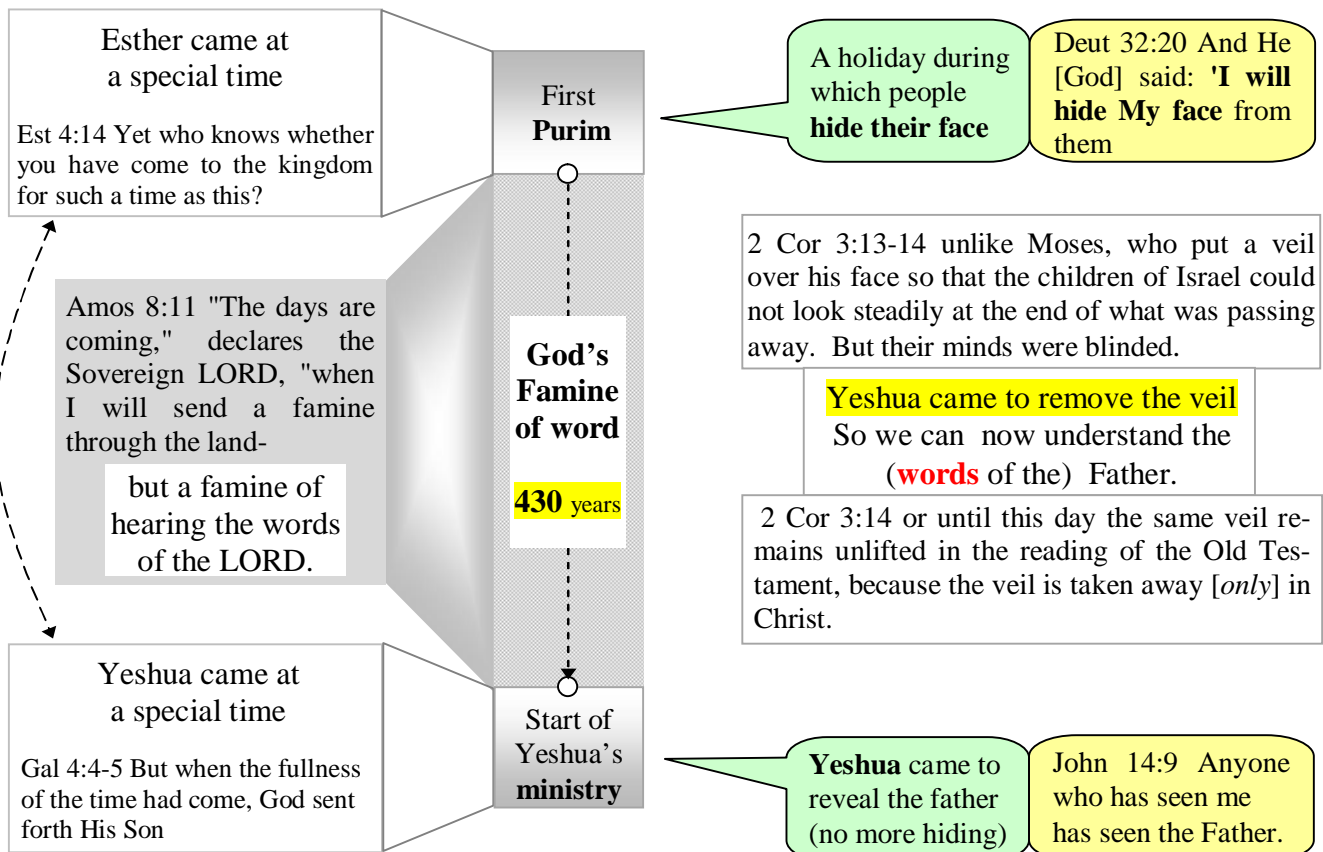

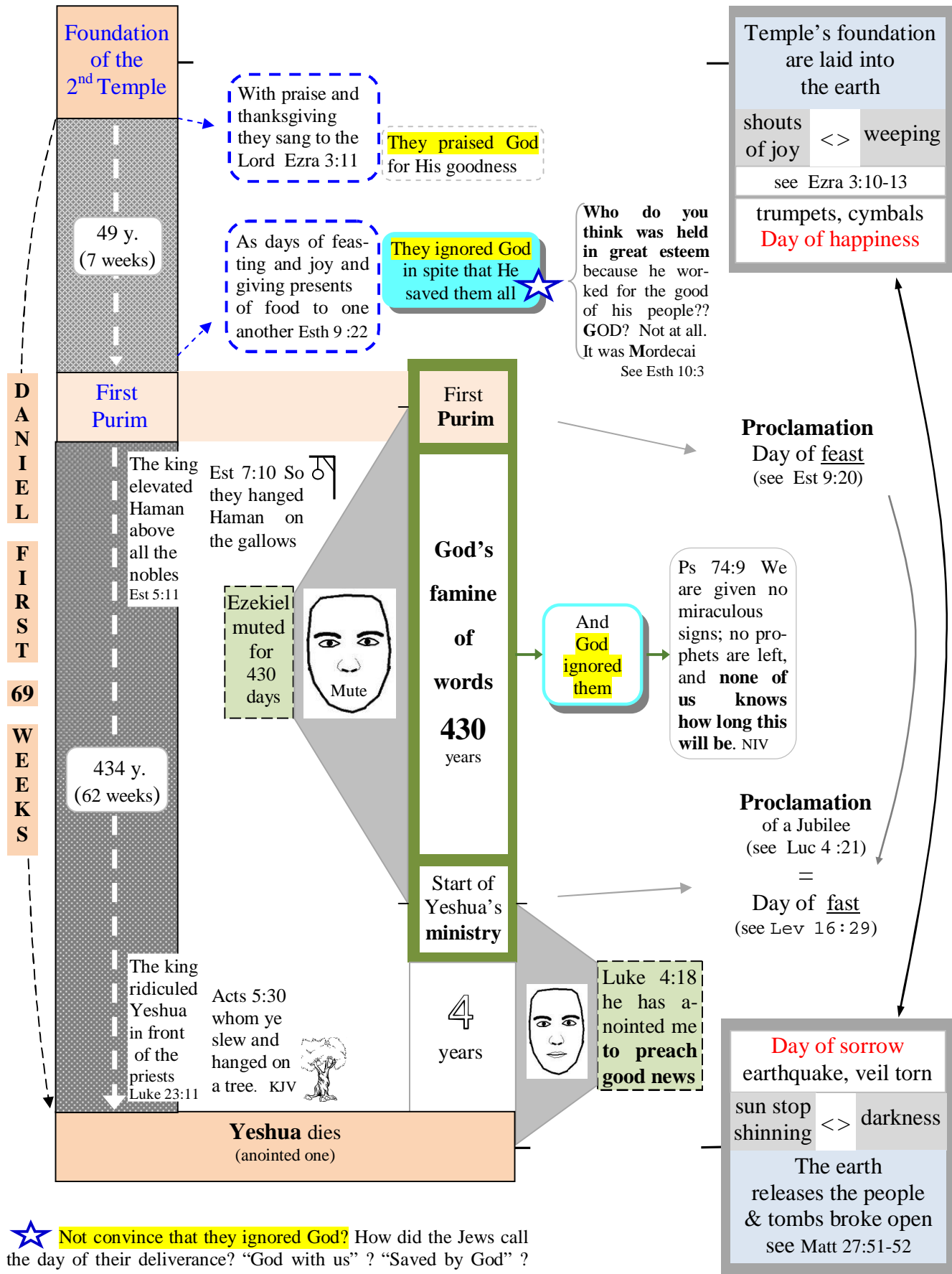

★ **Not convince that they ignored God?** How did the Jews call the day of their deliverance? "God with us" ? "Saved by God" ? Nope. They called it Purim from the Hebrew word "PUR" meaning LOTS. Is there a concept more alien from God that LOTS?

Purim

Est 8:11 By these **letters the king permitted the Jews** who were in every city to gather together and protect their lives--to destroy, kill, and annihilate all the forces of any people or province that would assault them, both little children and women, and to plunder their possessions, NKJV
Est 8:14 The couriers who rode on royal horses went out, hastened and pressed on by the king's command. [**to proclaim the good news**] NKJV

430 years

Yeshua's Ministry

Luke 4:17-21 He found the place where it was written: "The Spirit of the LORD is upon Me, Because He has anointed Me To preach the gospel to the poor; **He has sent Me to heal the brokenhearted, To proclaim liberty to the captives** And recovery of sight to the blind, **To set at liberty those who are oppressed;** To proclaim the acceptable year of the LORD." Then He closed the book, and gave it back to the attendant and sat down. And the eyes of all who were in the synagogue were fixed on Him. And He began to say to them, "**Today this Scripture is fulfilled in your hearing.**" NKJV

Did the start of Yeshua's ministry¹⁰⁰ bring back the prophets, miracles, and some communication from God? Yes it did and here are a few references of the change that happened:

- Luke 4:24 Then He [Yeshua talking about himself] said, "Assuredly, I say to you, no **prophet** is accepted in his own country. NKJV
- Luke 4:39 So He stood over her and **rebuked [one of Yeshua's miracle] the fever,** and it left her. And immediately she arose and served them. NKJV
- Luke 3:22-23 And the Holy Spirit descended in bodily form like a dove upon Him, **and a voice came from heaven** which said, "You are My beloved Son; in You I am well pleased." Now Jesus Himself began His ministry at about thirty years of age..

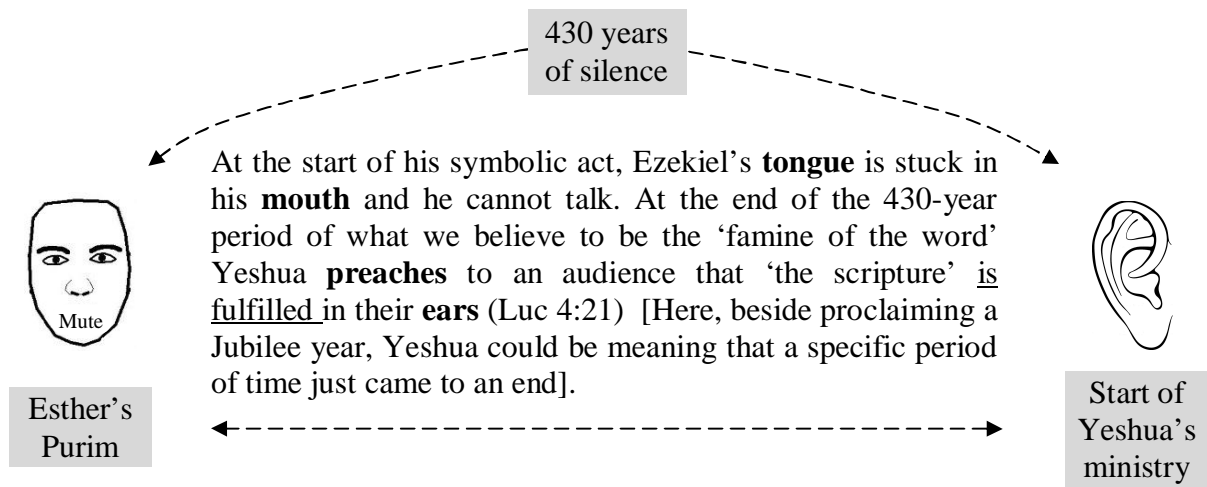

¹⁰⁰ It will be demonstrated later on that the first year of Yeshua's ministry marked the beginning of a Jubilee.

CONCLUSION (of first part)

The first part of this paper has convincingly (my wish anyway) demonstrated that Ezek 4-5 was symbolically taking place in the Temple.

Should we be surprised that the very first verse of Ezekiel (Ezek 1:1) ties in the prophet's 'personal calling' to the exact year that the Temple was cleansed by King Josiah?

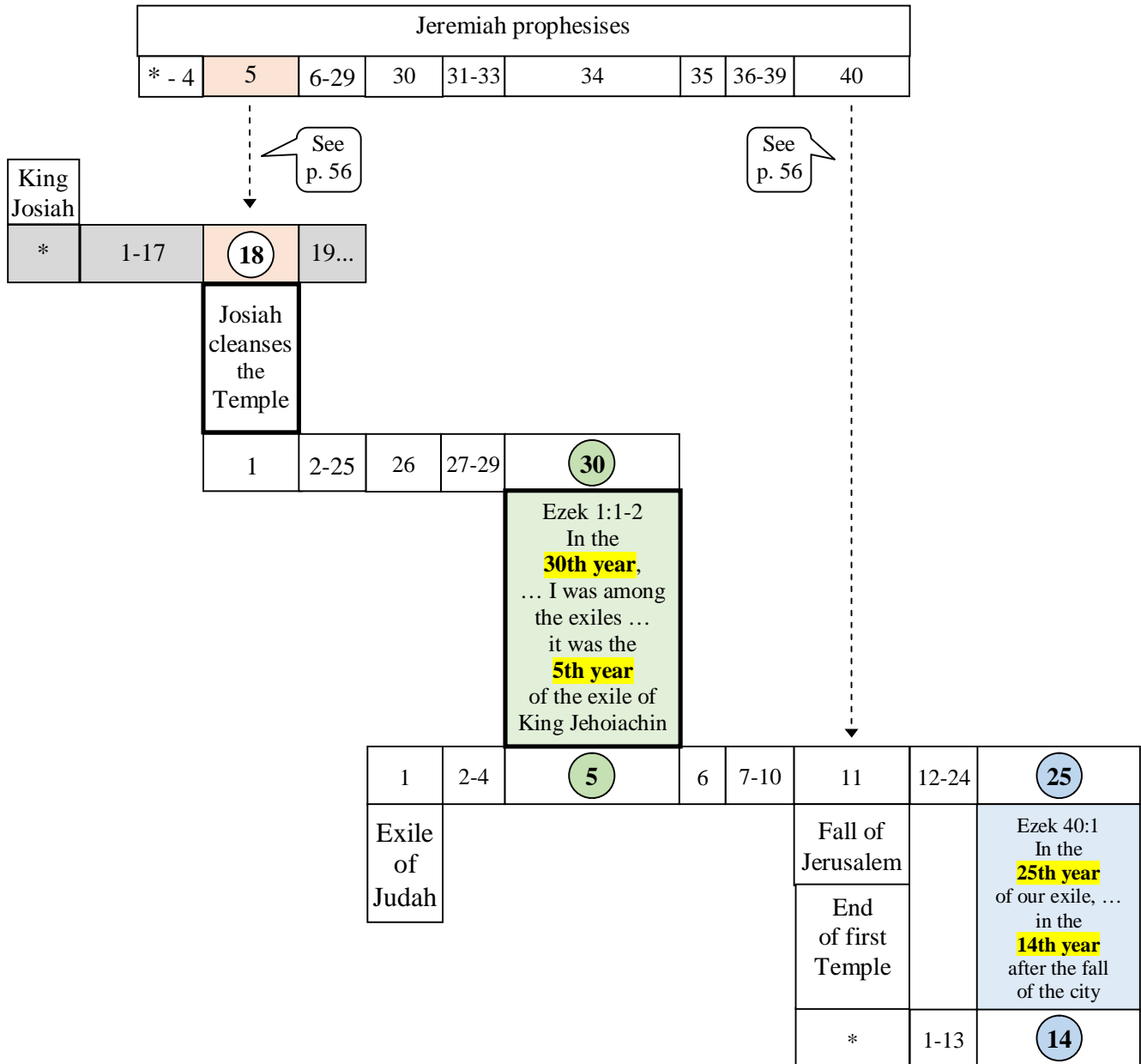

Second part

➔ Setting a true chronology of the Bible

I believe, like many other who study the Bible's chronology, that God has allowed humankind to evolve according to a 7,000-year Master Plan. In all likelihood this **Master Plan** is mirrored in the creation week. If this interpretation is right, we haven't reached year 6,000 AM yet, otherwise we would be living now during the millennial rest, which is not the case..

In the following pages I am going to associate a 'date' to each important event of the Bible, this will bring the discovery of some stunning patterns never exposed until now.

| | | | | | |
|----------------------|-------|---|-------------|-----------------|---|
| Creation week | Day 1 | = | 2,000 years | No Torah | Talmudic Tradition The Jews abandoned this view and failed to recognize Yeshua as the Messiah they were expecting |
| | Day 2 | | | | |
| | Day 3 | = | 2,000 years | Torah | |
| | Day 4 | | | | |
| | Day 5 | = | 2,000 years | Mes-sianic | |
| | Day 6 | | | | |
| | Day 7 | = | 1,000 years | Millennial rest | |

Ps 90:4 For a thousand years in your sight are like a day that has just gone by

The AM mode of dating

This chronology uses the AM mode of dating instead of our more familiar Gregorian calendar. In the **AM** system (**Anno Mundi**) year '0' coincides with the creation of the world and the new year's day occurs around the time of each new spring equinox. (See Ex 12:1-3).

Using Abraham year of birth '2008 AM' (see Appendix A on page 227) as a starting point you can figure out the date of each event displayed on the left side of the next figure. This is done by going backward or forward a specific number of years (obtained from the Bible) from a known date (2008 AM). This process consolidates a new date at each step.

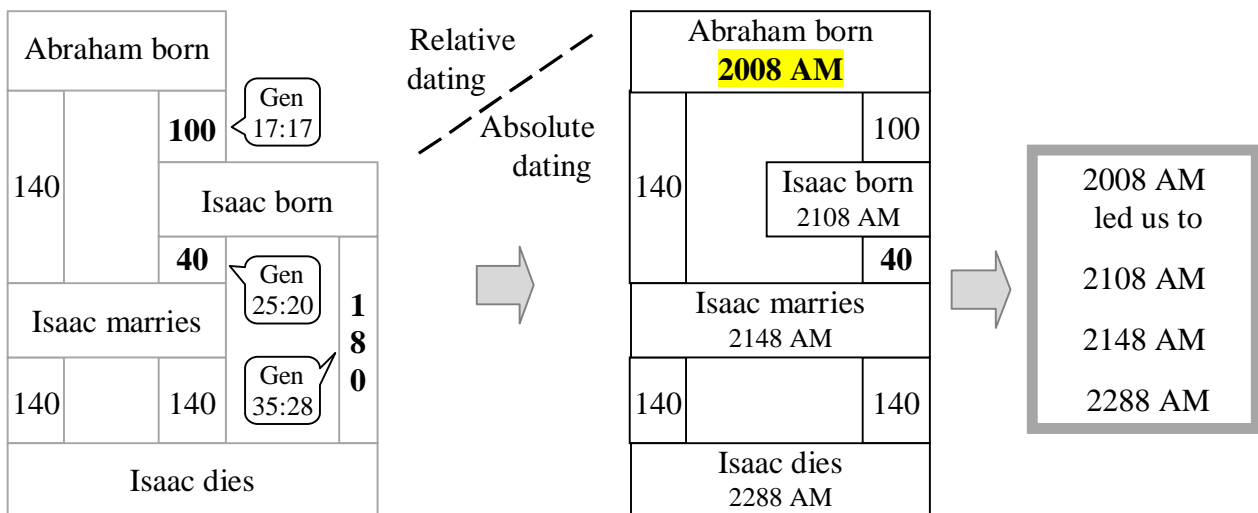

(This method was used to revisit every figure previously displayed in this work. As expected, each time a figure was reviewed, several new dates became available to help assess the timing of the reminding events. See the full result in Appendix E on page 255)

→ The timeline of Joseph

For an easier understanding follow the path in the numerical order. 1,2,3,..., 25 ★

| Stepping stones path | Operation | Reference |
|----------------------|---------------------------------------|------------------------|
| 1 | | Appendix A |
| 3 | 2108 - 90 | Gen 17:17 |
| 4 | 2008 + 85 | See page 76 |
| 2 | 2008 + 100 | Gen 17:17 |
| 6 | 2018 + 127 | Gen 23:1 |
| 7 | 2108 + 40 | Gen 25:20 |
| 8 | 2108 + 60 | Gen 25:26 |
| 9 | 2008 + 175 | Gen 25:7 |
| 21 | 2265 - 20 | Gen 31:41 |
| 22 | 2245 + 7 | Gen 29:20 |
| 23 | 2252 + 1 | Gen 29:31-32 |
| 16 | 2288 - 30 | Gen 41:46 |
| 19 | 2258 + 1 | Gen 30:25 |
| 20 | 2259 + 6 | Gen 31:41 |
| 24 | | Next pages |
| 17 | 2258 + 17 | Gen 37:2 |
| 15 | 2288 - 2 | Gen 41:1 |
| 14 | 2108 + 180 2289 - 1 | Gen 35:28 Gen 41:25 |
| 13 | 2296 - 7 | Gen 41:53 |
| 12 | 2298 - 2 | Gen 45:6 |
| 11 | 2168 + 130 2315 - 17 | Gen 49:9 Gen 47:28 |
| 10 | 2168 + 147 | Gen 47:28 |
| 18 | 2258 + 110 | Gen 50:26 |
| 25 | 2093 + 40 – 123 From end of Exodus | Num 33:38 |
| 5 | 2093 + 430 | Ex 12:40 |

| Years | Event |
|----------------|--|
| 2008 AM | Abram born |
| 2018 AM | Sarah born |
| 2093 AM | Covenant between the parts |
| 2108 AM | Isaac born |
| 2145 AM | Saraï dies |
| 2148 AM | Isaac marries |
| 2168 AM | Jacob born |
| 2183 AM | Abraham dies |
| 2245 AM | Jacob hired by Laban |
| 2252 AM | Jacob marries |
| 2253 AM | Reuben born |
| 2258 AM | Joseph born |
| 2259 AM | Jacob completes 14 years of work for Laban |
| 2265 AM | Jacob leaves Laban |
| 2268 AM | Benjamin born |
| 2275 AM | Joseph in Egypt |
| 2286 AM | Joseph helps the baker |
| 2288 AM | Isaac dies/ Joseph meets Pharaoh |
| 2289 AM | Start of 7 years of plenty |
| 2296 AM | Start of 7 years of famine |
| 2298 AM | Jacob meets Pharaoh |
| 2315 AM | Jacob dies |
| 2368 AM | Joseph dies |
| 2440 AM | Aaron born |
| 2523 AM | Exodus |

There is nothing in the Bible to pinpoint the exact date of the following four events:

- Benjamin born
- Joseph sent to prison
- Manasseh birth
- Ephraim birth

Benjamin was born some years after Jacob left Laban in 2265 AM and before Joseph was sold and sent to Egypt in 2275 AM. See Gen 34-35.

In Gen 39 we learn that Joseph became the intendant of Potiphar in Egypt. No doubt it took many years before Potiphar would entrust everything he owned in the hands of Joseph. Therefore we can rightly deduce that Joseph was sent to prison (by Potiphar) at least several years after his arrival in Egypt.

From Gen 41:50 we learn that Manasseh and Ephraim were born during the 7 years of plenty.

In the following pages we will see why, in all likelihood, these 4 events can be con-nected to the following dates

| | |
|-----------------------|---------|
| Benjamin born | 2268 AM |
| Joseph sent to prison | 2285 AM |
| Manasseh birth | 2291 AM |
| Ephraim birth | 2295 AM |

Reuben born
2253 AM



Isaac dies
2288 AM



Jacob dies
2315 AM



Joseph dies
2368 AM



Aaron born
2440 AM

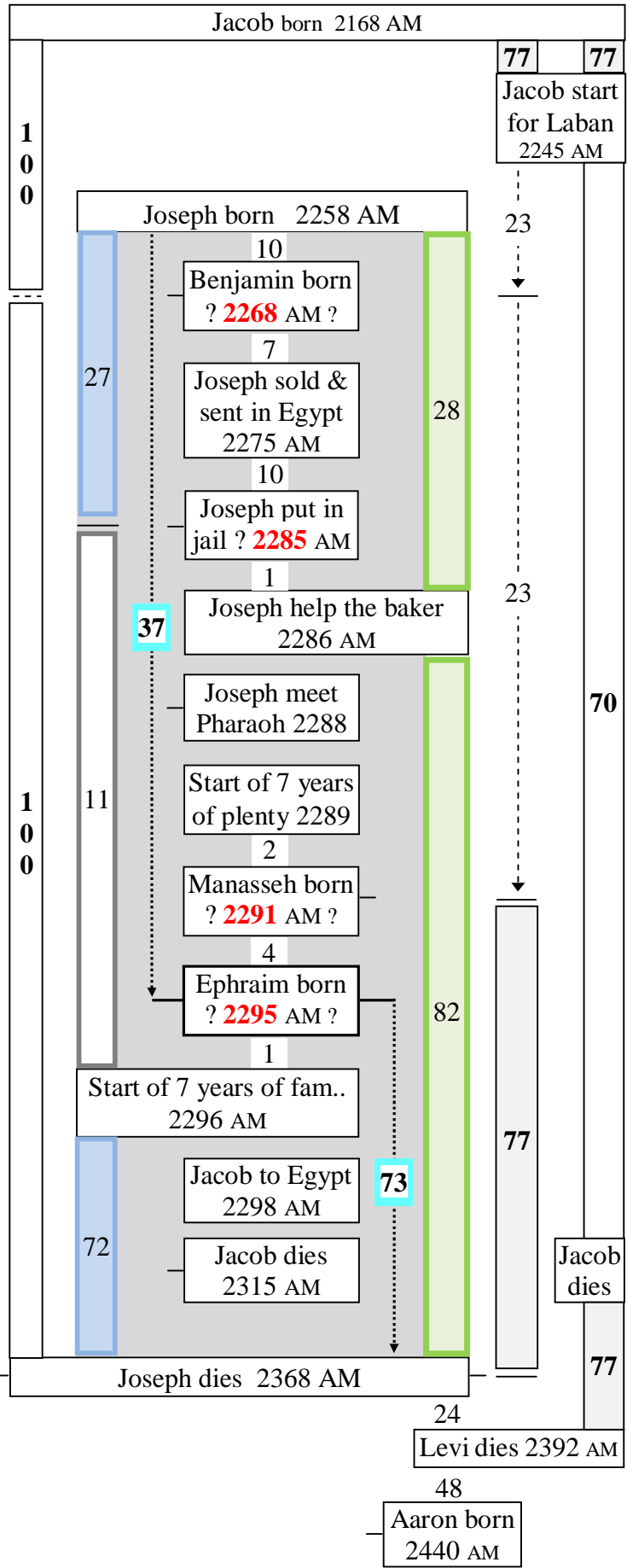

Rachel's sons

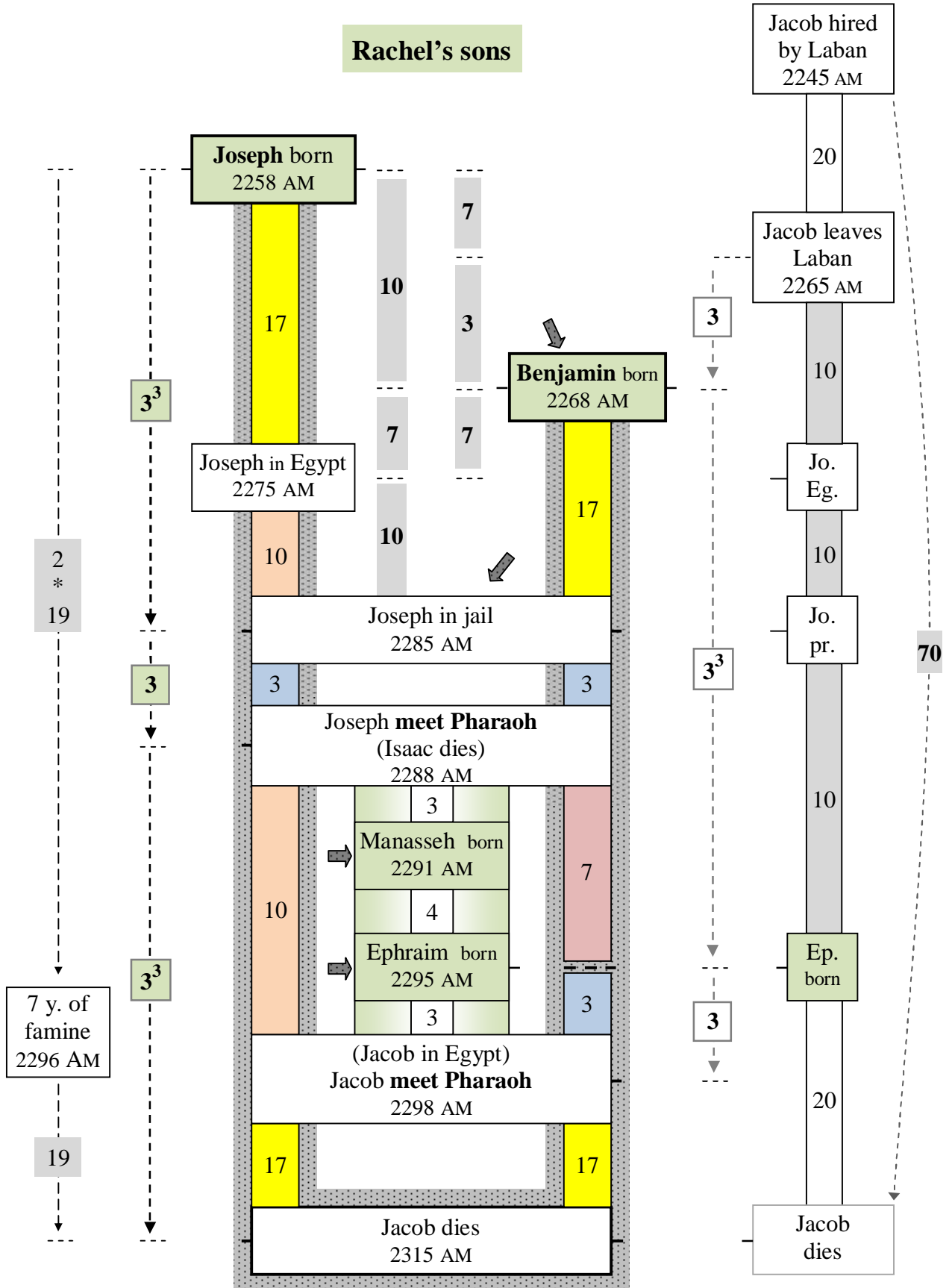

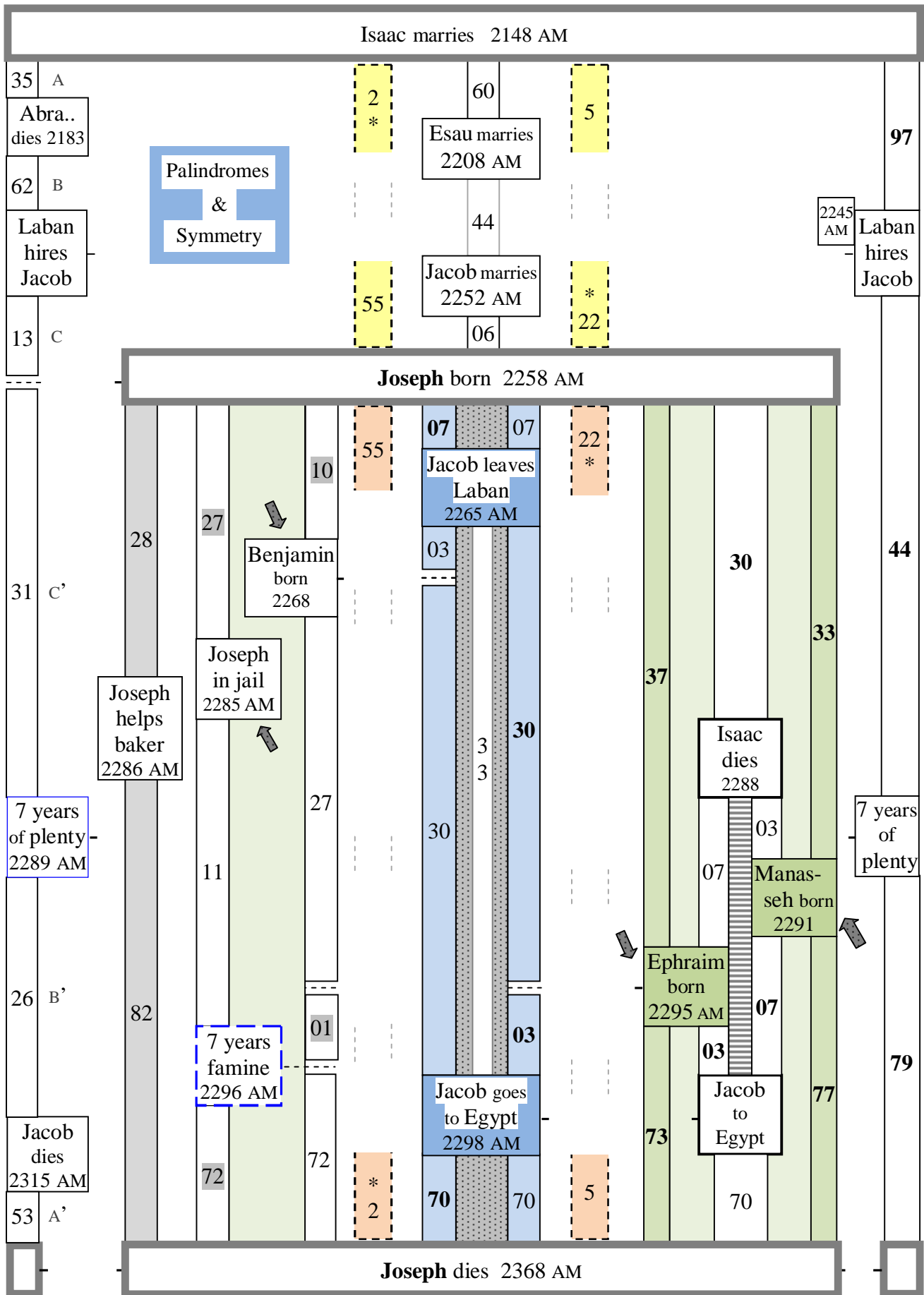

→ Was Yeshua's ministry first year (3989 AM) a jubilee year?

To answer this question we first need to examine how the sabbatical cycle is integrated in the chronology.

After the Israelites came to the Promised Land (2563 AM) they went to war against all the kings of the land to conquer their territories. It took six years (see Land divided on page 18) before Joshua could divide the land between the tribes. This was done in year 2569 AM (2563 + 6) and in that year the Israelites started farming their new land. As we should know, the primary benefit of the sabbatical cycle¹⁰¹ was to allow the land to rest for one year in every 7 years, therefore it is only logical to have the first sabbatical cycle to coincide with the time that the land was exploited for the first time (2569 AM) by the Israelites.

| 'Conquest of the land' under the command of Joshua | | | | | | First sabbatical cycle | | | | | | |
|--|-------|-------|-------|-------|-------|------------------------|-----------------|-----------------|-----------------|-----------------|-----------------|-----------------------|
| | | | | | | Land divided | | | | | | First sabbatical year |
| 2563 AM | 25 64 | 25 65 | 25 66 | 25 67 | 25 68 | 2569 AM | 2570 AM | 2571 AM | 2572 AM | 2573 AM | 2574 AM | 2575 AM |
| Promised land | | | | | | 1 st year | 2 nd | 3 rd | 4 th | 5 th | 6 th | 7 th |

So the first sabbatical year was 2575 AM and up to the time of Daniel's death a new one was observed every 7 years. Having God's 7,000 years Master Plan in mind, it is interesting to note that if we count the number of sabbatical cycles that was originally intended, that is to say if they hadn't been interrupted at Daniel's death in 2953 AM, we obtain a total of exactly 490 (or $7 * 70$) sabbatical years before the start of the 7th millennium.

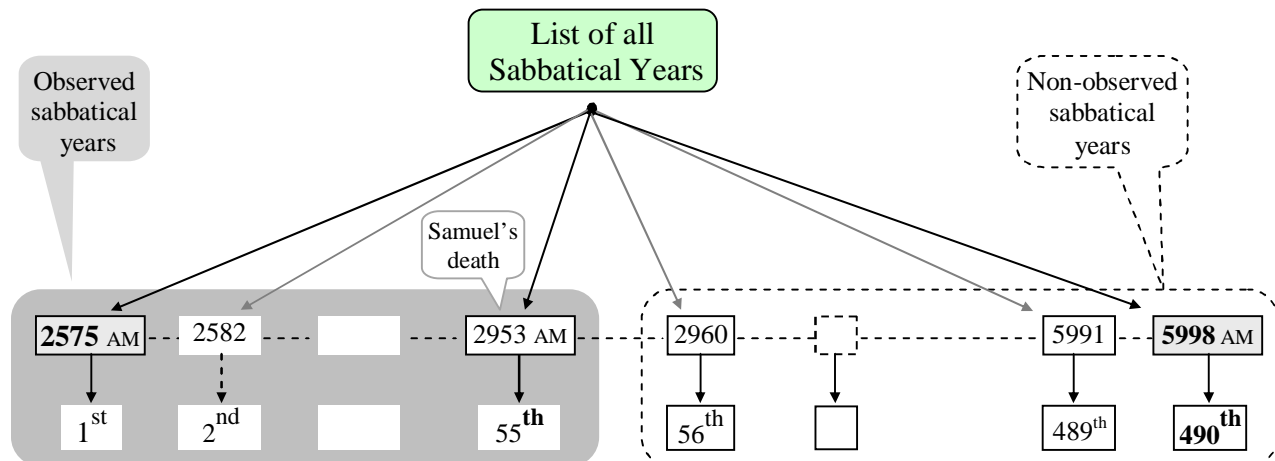

At the time they started counting for the first sabbatical cycle the Israelites also began counting for the occurrence of a jubilee year¹⁰².

¹⁰¹ Ex 23:10-11 "Six years you shall sow your land and gather in its produce, 11 but the seventh year you shall let it rest NKJV

¹⁰² This is the most logical time to start counting the Jubilee years. Both concepts are closely related.

The JUBILEE

Lev 25:8-10 And you shall count seven Sabbaths of years for yourself, seven times seven years; and the time of the seven Sabbaths of years shall be to you forty-nine years. Then you shall cause the trumpet of the Jubilee to sound on the tenth day of the seventh month; on the Day of Atonement you shall make the trumpet to sound throughout all your land. And you shall consecrate the fiftieth year,

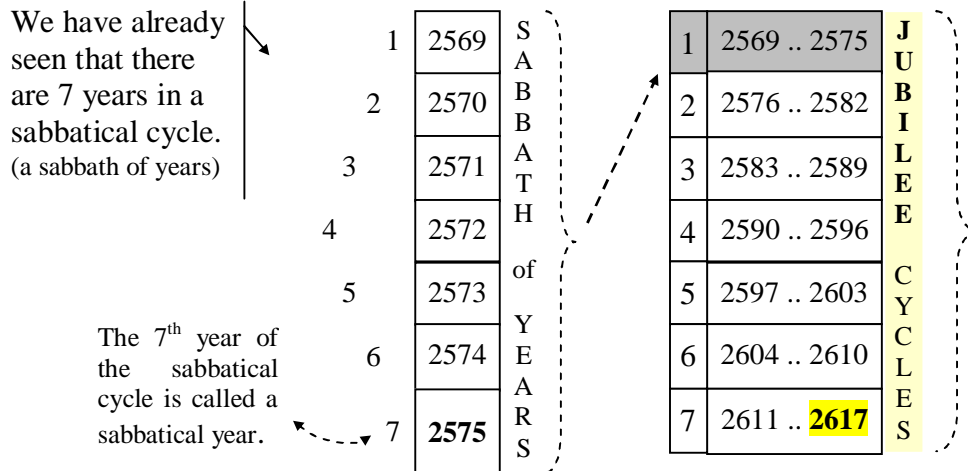

| Layout of the very first jubilee cycle | | | | | | | | | | | |
|--|--------------|--------------|--------------|--------------|--------------|-----------------|--|--|--|--|--|
| Sab. Cy.. #1 | Sab. Cy.. #2 | Sab. Cy.. #3 | Sab. Cy.. #4 | Sab. Cy.. #5 | Sab. Cy.. #6 | Sab. Cy.. #7 | | | | | |
| Y1 2569 AM | Y8 2576 | Y15 2583 | Y22 2590 | Y29 2597 | Y36 2604 | Y43 2611 | | | | | |
| Y2 2570 | Y9 2577 | Y16 2584 | Y23 2591 | Y30 2598 | Y37 2605 | Y44 2612 | | | | | |
| Y3 2571 | Y10 2578 | Y17 2585 | Y24 2592 | Y31 2599 | Y38 2606 | Y45 2613 | | | | | |
| Y4 2572 | Y11 2579 | Y18 2586 | Y25 2593 | Y32 2600 | Y39 2607 | Y46 2614 | | | | | |
| Y5 2573 | Y12 2580 | Y19 2587 | Y26 2594 | Y33 2601 | Y40 2608 | Y47 2615 | | | | | |
| Y6 2574 | Y13 2581 | Y20 2588 | Y27 2595 | Y34 2602 | Y41 2609 | Y48 2616 | | | | | |
| Y7 2575 | Y14 2582 | Y21 2589 | Y28 2596 | Y35 2603 | Y42 2610 | Y49 2617 | | | | | |

When do we start the Jubilee year?

On the 10th day of the 7th month of the 49th year of the Jubilee cycle (Lev 25:8-10), the jubilee year would be consecrated. It means that the Jubilee year doesn't start at the very beginning of the 49th years of the Jubilee cycle. The 'jubilee year' starts only when the 7th month of the 49th year of the jubilee cycle is reached and ended on the 7th month of the next year (which is part of the next jubilee cycle).

| First Jubilee | | | | | | | Second Jubilee | | | | | Third Jubilee | | |
|---------------|------|------|---|------|------|-------------|----------------|------|---|------|------|---------------|------|---|
| 2569 | 2570 | 2571 | - | 2615 | 2616 | 2617 | 2618 | 2619 | - | 2665 | 2666 | 2667 | 2668 | - |
| 1 | 2 | 3 | - | 47 | 48 | 49 | 1 | 2 | - | 48 | 49 | 1 | 2 | - |

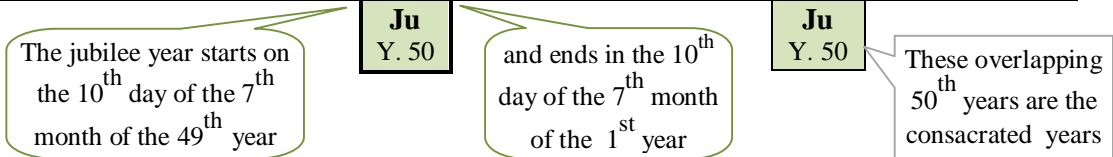

| | | | | | | | | |
|--------------------------|------|------|--------------------------|------|---|------|-------------|------|
| --- 69 th Ju. | | | 70 th Jubilee | | | | | |
| - | 5948 | 5949 | 5950 | 5951 | - | 5997 | 5998 | 5999 |
| - | 48 | 49 | 1 | 2 | - | 48 | 49 | |
| | | | Ju Y. 50 | | | | Ju Y. 50 | |

7th
Millen
-nium

The Jubilee year is also known as the **YOVEL** year. The name comes from the fact that on Yom Kippur of the fiftieth year, a yovel (ram's horn) is blown throughout the land to dedica-
this new jubilee year.



List of the 70 **J**ubilee years that will occur up to the Day of the Lord

| | | | | |
|-----------------------|-----------------|------------------------|-----------------|------------------------|
| Ju 1 2617-2618 | Ju 15 3303-3304 | Ju 29 3989-3990 | Ju 43 4675-4676 | Ju 57 5361-5362 |
| Ju 2 2666-2667 | Ju 16 3352-3353 | Ju 30 4038-4039 | Ju 44 4724-4725 | Ju 58 5410-5411 |
| Ju 3 2715-2716 | Ju 17 3401-3402 | Ju 31 4087-4088 | Ju 45 4773-4774 | Ju 59 5459-5460 |
| Ju 4 2764-2765 | Ju 18 3450-3451 | Ju 32 4136-4137 | Ju 46 4822-4823 | Ju 60 5508-5509 |
| Ju 5 2813-2814 | Ju 19 3499-3500 | Ju 33 4185-4186 | Ju 47 4871-4872 | Ju 61 5557-5558 |
| Ju 6 2862-2863 | Ju 20 3548-3549 | Ju 34 4234-4235 | Ju 48 4920-4921 | Ju 62 5606-5607 |
| Ju 7 2911-2912 | Ju 21 3597-3598 | Ju 35 4283-4284 | Ju 49 4969-4970 | Ju 63 5655-5656 |
| Ju 8 2960-2961 | Ju 22 3646-3647 | Ju 36 4332-4333 | Ju 50 5018-5019 | Ju 64 5704-5705 |
| Ju 9 3009-3010 | Ju 23 3695-3696 | Ju 37 4381-4382 | Ju 51 5067-5068 | Ju 65 5753-5754 |
| Ju 10 3058-3059 | Ju 24 3744-3745 | Ju 38 4430-4431 | Ju 52 5116-5117 | Ju 66 5802-5803 |
| Ju 11 3107-3108 | Ju 25 3793-3794 | Ju 39 4479-4480 | Ju 53 5165-5166 | Ju 67 5851-5852 |
| Ju 12 3156-3157 | Ju 26 3842-3843 | Ju 40 4528-4529 | Ju 54 5214-5215 | Ju 68 5900-5901 |
| Ju 13 3205-3206 | Ju 27 3891-3892 | Ju 41 4577-4578 | Ju 55 5263-5264 | Ju 69 5949-5950 |
| Ju 14 3254-3255 | Ju 28 3940-3941 | Ju 42 4626-4627 | Ju 56 5312-5313 | Ju 70 5998-5999 |

NOTICE: Yeshua died in 3993 AM at age 33 (born in 3960 AM), therefore he was 29 years old when he announced the 29th jubilee in the 7th month of 3989 AM. See next few pages for a convincing proof that Yeshua's ministry lasted 4 years.

→ Did Yeshua's ministry last 4 years?

In the absence of any explicit Bible's references to confirm a 4-year ministry we could try to build a limited timeline that would include each action performed by Yeshua and his apostles and see how things add up. However, it is quite possible that this information has already been supplied but in a symbolic way. Here are **7 points** directly and indirectly related to Yeshua in which the number '4' is linked to a notion of 'duration'.

1st clue 4 days in the Temple

At age 12 Yeshua spent 4 days in the Temple:

- Luke 2:44 Thinking he was in their company, they traveled on for a day.
- Luke 2:46 After three days they found him in the temple courts

The 4 days in the Temple could mirror a future 4-year ministry.

2nd clue wait four years for the fruit

- Luke 13:6-9 "A man had a fig tree, planted in his vineyard, and he went to look for fruit on it, but did not find any. So he said to the man who took care of the vineyard, **'For three years** now I've been coming to look for fruit on this fig tree and haven't found any. Cut it down! Why should it use up the soil?' "'Sir,' the man replied, 'leave it alone **for one more year**, and I'll dig around it and fertilize it. If it bears fruit next year, fine! If not, then cut it down.'"

The man who took care of the vineyard was allowed a total of 4 years. Wasn't Yeshua taking care of Israel during his ministry? Could he have been given a fourth year too?

3rd clue Passover lamb chosen 4 days before

Yeshua's crucifixion can be equated to the killing of the Passover lamb.

Yeshua was described as a lamb:

- John 1:29 The next day John saw Jesus coming toward him, and said, "Behold! The Lamb of God who takes away the sin of the world! NKJV
- Isa 53:7 He was oppressed and He was afflicted, Yet He opened not His mouth; He was led as a lamb to the slaughter, And as a sheep before its shearers is silent, So He opened not His mouth. NKJV

The Passover lamb had to be without a fault:

- Ex 12:5 Your lamb shall be without blemish NKJV

Yeshua was also without a fault:

- Luke 23:4 So Pilate said to the chief priests and the crowd, "I find no fault in this Man." NKJV

- 1 Peter 1:19 but with the precious blood of Christ, as of a lamb without blemish and without spot. NKJV
- 2 Cor 5:21 For He made Him who knew no sin to be sin for us, NKJV
- John 8:46 Which of you convicts Me of sin? And if I tell the truth, why do you not believe Me? NKJV

The Passover lamb was **chosen** 4 days before being killed:

- Ex 12:3 'On the tenth day of this month every man shall take for himself a lamb,
- Ex 12:6 Now you shall keep it until the fourteenth day of the same month. Then the whole assembly of the congregation of Israel shall kill it at twilight. NKJV

Could a four-year ministry parallel the last four days of the Passover lamb?

If Yeshua's ministry lasted four years, it would perfectly match the four days during which the blemishless lamb had been known and expressly kept to become the Passover lamb.

4th clue

Timing of the of the jubilee year

At the beginning of his ministry, Yeshua

- was baptized
- spent 40 days in the desert
- spent some time teaching in the various synagogues around.

And then Yeshua announced the jubilee:

- Luke 4:18-21 "The Spirit of the Lord is on me, because he has anointed me to preach good news to the poor. He has sent me to proclaim freedom for the prisoners and recovery of sight for the blind, to release the oppressed, to proclaim the year of the Lord's favor." Then he rolled up the scroll, gave it back to the attendant and sat down. The eyes of everyone in the synagogue were fastened on him, and he began by saying to them, "**Today** this scripture is fulfilled in your hearing."

The text that Yeshua read in the synagogue was a description of **a jubilee year** and at the end of his reading, he told everybody **that what he had just read was happening on that very day**. We even know the date of that day:

- Lev 25:9-10 Then have the trumpet sounded everywhere on the tenth day of the seventh month; on the Day of Atonement sound the trumpet throughout your land. Consecrate the fiftieth year and proclaim liberty throughout the land to all its inhabitants.

At no other time would it have been more appropriate to announce a jubilee than at the start of a ministry that would bring the same kind of relief as was expected during a jubilee year. See the following report that was transmitted to John the Baptist later on:

- Matt 11:4-6 Jesus answered and said to them, "Go and tell John the things which you hear and see: The blind see and the lame walk; the lepers are cleansed and the deaf hear; the dead are raised up and the poor have the gospel preached to them. NKJV

According to the timeline given in Appendix E on page 255, Yeshua died in 3993 AM. If the ministry lasted four years, as we are trying to demonstrate, it had to start at 3989 AM. Was 3989 AM a jubilee year? Absolutely. See list of jubilee years on page 148.

There was a jubilee year starting in the 7th month of 3989 AM.

| | | | | | |
|--|-------|--------|--------------------------------------|-------|--------|
| 3989 AM | | | 3990 AM | | |
| M1 | M7D10 | M12 13 | M1 | M7D10 | M12 13 |
| | | | | | |
| 49 th year of a 49-year cycle | | | First year of the next 49-year cycle | | |
| <div style="border: 1px dashed black; padding: 5px; background-color: #f0f0f0; display: inline-block;"> <p>Jubilee year #29 It is also called the fiftieth year in Lev 25:8-10</p> </div> | | | | | |

It is quite possible that, contrary to the popular belief, the very start of Yeshua's ministry coincides with the proclamation of the Jubilee year.

M = month
D = day

We saw earlier that a jubilee starts in the 7th month of the 7th year of the 7th sabbatical cycle and terminates in the 7th month of the first year of the next cycle. (See page 148)

5th clue Four months before the harvest

- John 4:35 Do you not say, '**Four months more and then the harvest**'? I tell you, open your eyes and look at the fields! **They are ripe for harvest.**

A careful review of John indicates that the timing of John 4:35 could be a few weeks after the first Passover of Yeshua's ministry which was held in the first month (M1) of **3990 AM**:

- John 2:13 When it was almost time for the Jewish Passover, Jesus went up to Jerusalem.

There were four Passovers (**P1, P2, P3, P4**) during Yeshua's ministry (if it lasted 4 years as assumed by the author).

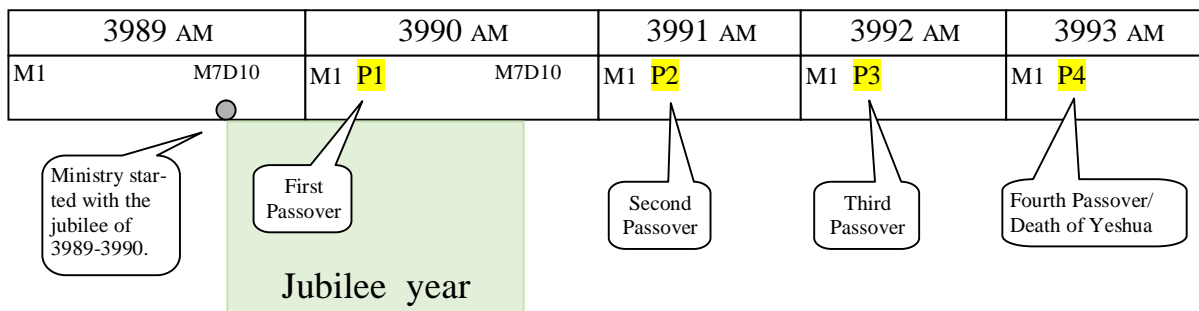

In John 4:35-38 Yeshua is telling his disciples that the fields are ready to be harvested (spring harvest) but people say “**four months more and then the harvest**”.

Why would the people wait 4 months if those fields were ready to be harvested? Why would it be a saying? Four months after the spring brings us into the fall, the fact that it was a saying could only mean that those circumstances had been encountered in the past and they would happen again in the future.

There is only one possible explanation here. At the time Yeshua was talking, during the spring of 3990 AM, there was still 4 months to wait for the end of the current jubilee year and this is why the people were not harvesting even though the crop was ready. (It would have been unlawful to do so.)

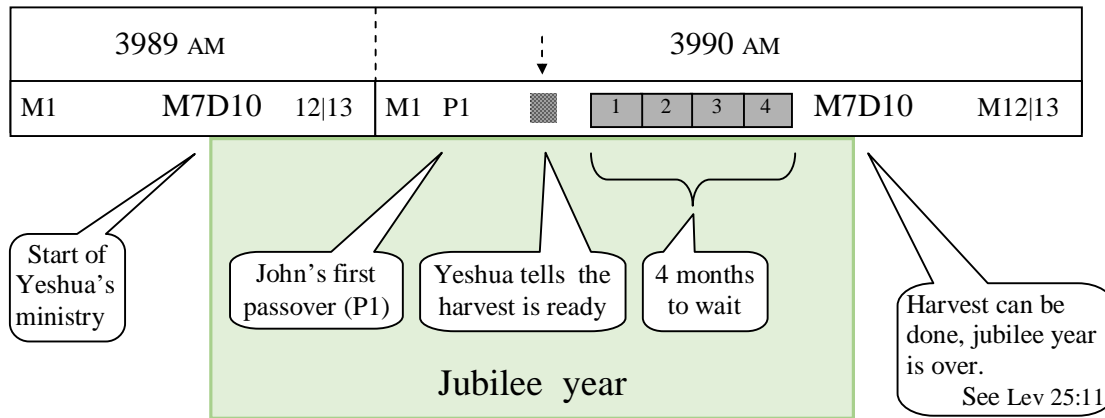

6th clue Queen Esther wait four days before going to the king uninvited

There are strong similarities between Yeshua's ministry and what can be seen to some extent as Queen Esther's 4-day ministry.

Here I specifically point to the 4-day period during which Queen Ester held a three days' fast with all the Jews of Susa and then presented herself, uninvited, to the King and ended-up by pleading for her own safety. Note that by imploring the king to save the only life he cared for, the life of his queen, Esther brilliantly fought for the fate of all the Jews.

Queen Esther
4-day ministry

- Est 4:16 Go, gather all the Jews who are present in Shushan, and fast for me; neither eat nor drink for **three days**, night or day.
- Est 5:2 So it was, when the king saw Queen Esther standing in the court, that she found favor in his sight, and the king held out to Esther the golden scepter that was in his hand.
- Est 5:8 then let the king and Haman come to the banquet which I will prepare for them, and **tomorrow** I will do as the king has said."
- Est 7:2 And on the second day, at the banquet of wine, the king again said to Esther, "What is your petition, Queen Esther?"
- Est 7:3 O king, and if it pleases the king, let my life be given me at my petition, and my people at my request.

The parallel between Yeshua's ministry and Esther's ministry come in several levels.

Both individuals face violent death twice.

(In each case a king was involved)

Esther could have died when she presented herself to the King uninvited.

- Est 4:11 All the king's servants and the people of the king's provinces know that any man or woman who goes into the inner court to the king, who has not been called, he has but one law: put all to death,

As a Jewish she was also targeted by Haman's planned genocide.

- Est 3:8-9 Then Haman said to King Ahasuerus, "There is a certain people scattered and dispersed among the people in all the provinces of your kingdom; ... If it pleases the king, let a decree be written that they be destroyed,

Note: The date of the genocide was obtained **by casting lots.**

Yeshua was directly targeted when Herod had all the children under two killed.

- Matt 2:13 Now when they had departed, behold, an angel of the Lord appeared to Joseph in a dream, saying, "Arise, take the young Child and His mother, flee to Egypt, and stay there until I bring you word; for Herod will seek the young Child to destroy Him.

Yeshua was crucified.

- Mark 15:22-24 And they brought Him to the place Golgotha, And when they crucified Him,

Note: The distribution of Yeshua's garments was decided **by casting lots**
(Ref Mark 15:24)

Both started their ministry with an unusual fast.

Esther unexpectedly fasted during three days before meeting the King. Notice that by doing so, her appearance was likely to repel the King when he saw her.

- Est 4:16 Go, gather all the Jews who are present in Shushan, and fast for me; neither eat nor drink for three days, night or day. My maids and I will fast likewise.

Yeshua when 40 days in the desert

- Matt 4:1-2 Then Jesus was led up by the Spirit into the wilderness to be tempted by the devil. And when He had fasted forty days and forty nights, afterward He was hungry.

Both offer their lives to save a multitude

- Est 4:8-9 that he [the king's eunuchs] might command her [Esther] to go in to the king to make supplication to him and plead before him for her people.
- John 10:11 I am the good shepherd. The good shepherd gives His life for the sheep.

Each ministry happens to be the most critical period of the life of its author.

- ⇒ Esther's 4-day period is unquestionably the turning point of her story, up to that point she saw the rise of Haman and the introduction of a decree to annihilate most of the Jews, but after that she saw Haman lose everything, including his life, and the Jews were saved.
- ⇒ The purpose of Yeshua's ministry was to reveal the good news of the Kingdom of God. No other prophets had ever delivered a more important message.

7th clue

The last four years of Absalom

The last 4 years of Absalom are a TYPE of Yeshua's ministry

In the case of Absalom the four years started when he received the authorization from his father (King David) to leave his own house in Jerusalem and circulate in the city:

- 2 Sam 14:33 Then the king summoned Absalom, and he came in and bowed down with his face to the ground before the king. And the king kissed Absalom. NIV

And it ended when Absalom tried to usurp the crown and replace his father on the throne:

- 2 Sam 15:7 At the end of four years, Absalom said to the king, NIV

Here are 7 points showing that a parallel can be established between Absalom and Yeshua.

- ▶ P1 ◀ The last 4 years in each man's life started with freedom.
Absalom: At first Absalom was confined¹⁰³ to his own house and was not allowed to see his father: See 2 Sam 14:24
Then he recovered his freedom and was allowed to see his father during the last 4 years of his life. See 2 Sam 15:7
Yeshua: At the start of his 4 year ministry Yeshua **declared a jubilee year** (freedom) : See Luke 4:16-18
- ▶ P2 ◀ Each man had an opposite way to resolve conflicts.
Absalom was seeking justice: See 2 Sam 15:4
Yeshua was promoting 'forgiveness' See Luke 6:37
- ▶ P3 ◀ The king's son and God's son were both impaled by the spear of a soldier while hanging on a tree.
Absalom was impaled by Joab. See 2 Sam 18:14
Note Joab was a soldier: 1 Chron 27:34
Yeshua was impaled by a soldier. See John 19:34
Note: There are many facts that tend to prove that Yeshua was crucified on a tree.
- ▶ P4 ◀ The king's son and God's son died with a crown on the head.
Absalom See 2 Sam 18:9
Yeshua See Matt 27:29

¹⁰³ The fact that Absalom was confined to his own house is not in doubt. It was in response to a specific order [let him return to his own house] from the king. Also notice that Absalom sent his servant twice to ask Joab to come to see him. Why didn't Absalom go to see Joab himself given that they were close neighbors:

2 Sam 14:29 And when he sent again the second time, he would not come. NKJV

2 Sam 14:30 So he said to his servants, "See, Joab's field is near mine, NKJV

And how can we explain that Absalom would have been better if he had stayed in Geshur unless he was free to move around in Geshur:

2 Sam 14:32 "Why have I come from Geshur? It would be better for me to be there still." NKJV

► P5 ◀ Each man's death was followed by a loud sound.

Absalom See 2 Sam 18:16
Yeshua See Mark 15:38-39, Matt 27:51

► P6 ◀ The king's son and God's son were buried beneath a rock.

Absalom See 2 Sam 18:17
Yeshua See Matt 27:59-60

► P7 ◀ Following each death the people hurried home.

After Absalom's death See 2 Sam 18:17
After Yeshua's death See Luke 23:54,56

The previous 7 clues strongly suggest that Yeshua's ministry lasted 4 years.

Can we connect the death of Yeshua and the destruction of the second Temple?

Yeshua predicted that soon the Temple would not be needed to worship the Father

- John 4:21 Jesus declared, "Believe me, woman, a time is coming when you will worship the Father neither on this mountain nor in Jerusalem.

Yeshua associate his death with the end of something. Notice that the Temple's veil was torn in two at the time of his death.

- John 19:30 Jesus said, "It is finished." With that, he bowed his head and gave up his spirit.
- Matt 27:51 At that moment the curtain of the temple was torn in two from top to bottom. The earth shook and the rocks split.

The Jewish Talmud says that 40 years before the Temple was destroyed the gates of the temple opened by themselves, until Rabbi Yohanan B. Zakkai rebuked them (i.e., the gates) saying, "Hekel, Hekel, why do you alarm us? We know that you are destined to be destroyed" (Yoma 39b).

- Zech 11:1 Open your doors, O Lebanon, so that fire may devour your cedars!

Josephus - Moreover, the eastern gate of the inner, [court of the temple,] which was of brass, and vastly heavy, and had been with difficulty shut by twenty men, and rested upon a basis armed with iron, and had bolts fastened very deep into the firm floor, which was there made of one entire stone, was seen to be opened of its own accord about the sixth hour of the night. (Josephus, *The Wars of the Jews*, IV: iv, 3)

This
happened
every
day
for
40 years

Both the tearing of the veil and the opening of the gates symbolize the same fact: the Temple had become **redundant**. Therefore it is logical to deduce that both events happened the same year, i.e. the year of Yeshua's death. **The '40 years' supplied by the Talmud represents the period between the death of Yeshua and the physical destruction of the second Temple.** (the Temple was burned down by the Romans)

Can there be any doubts left?



| Year | Yeshua's ministry started in the 7 th month of 3389 AM and ended in the 1 st month of 3993 AM. The ministry lasted exactly 44 months. | | | | # of months | Total # of months |
|---------|---|-----------|------------|------------|-------------|-------------------|
| 3989 AM | M1- | M2- | M3- | M4- | 6 | 44 Months |
| | M5- | M6- | M7-Thisri | M8-Mach.. | | |
| | M9-Kislev | M10-Tevet | M11-Shevav | M12-Adar I | | |
| | M13-Adar2 | | | | | |
| 3990 AM | M1-Nissan | M2-Lyar | M3-Sivan | M4-Tammuz | 12 | |
| | M5-Mena | M6-Elul | M7-Thisri | M8-Mach.. | | |
| | M9-Kislev | M10-Tevet | M11-Shevav | M12-Adar I | | |
| 3991 AM | M1-Nissan | M2-Lyar | M3-Sivan | M4-Tammuz | 13 | |
| | M5-Mena | M6-Elul | M7-Thisri | M8-Mach.. | | |
| | M9-Kislev | M10-Tevet | M11-Shevav | M12-Adar I | | |
| | M13-Adar2 | | | | | |
| 3992 AM | M1-Nissan | M2-Lyar | M3-Sivan | M4-Tammuz | 12 | |
| | M5-Mena | M6-Elul | M7-Thisri | M8-Mach.. | | |
| | M9-Kislev | M10-Tevet | M11-Shevav | M12-Adar I | | |
| 3993 AM | M1-Nissan | | | | 1 | |



Ex 12:3 on the tenth day of this month each man is to take a lamb for his family

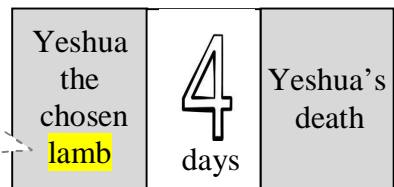

46 John 2:20 Then the Jews said, "It has taken 46 years to build this temple

According Luc 3:23 Yeshua was about 30 years old at the start of his ministry.

(The pattern on this page infer that He was 29 years old and born in 3960 AM.)

29

Less than **30 days** before the Passover festival people begin concentrating on their *pesach* offering.

Ref : footnote 20, *The ArtScroll Series* Babylonian Talmud (Shekalim 20a), Mesorah Publications, Ltd

And the lamb was closely observed during **4 days** before the slaughtering. -- Ex 12:3-7

Yeshua was chosen by God when he was less than **30 years old**; and God observed Him during His **4 year**-ministry

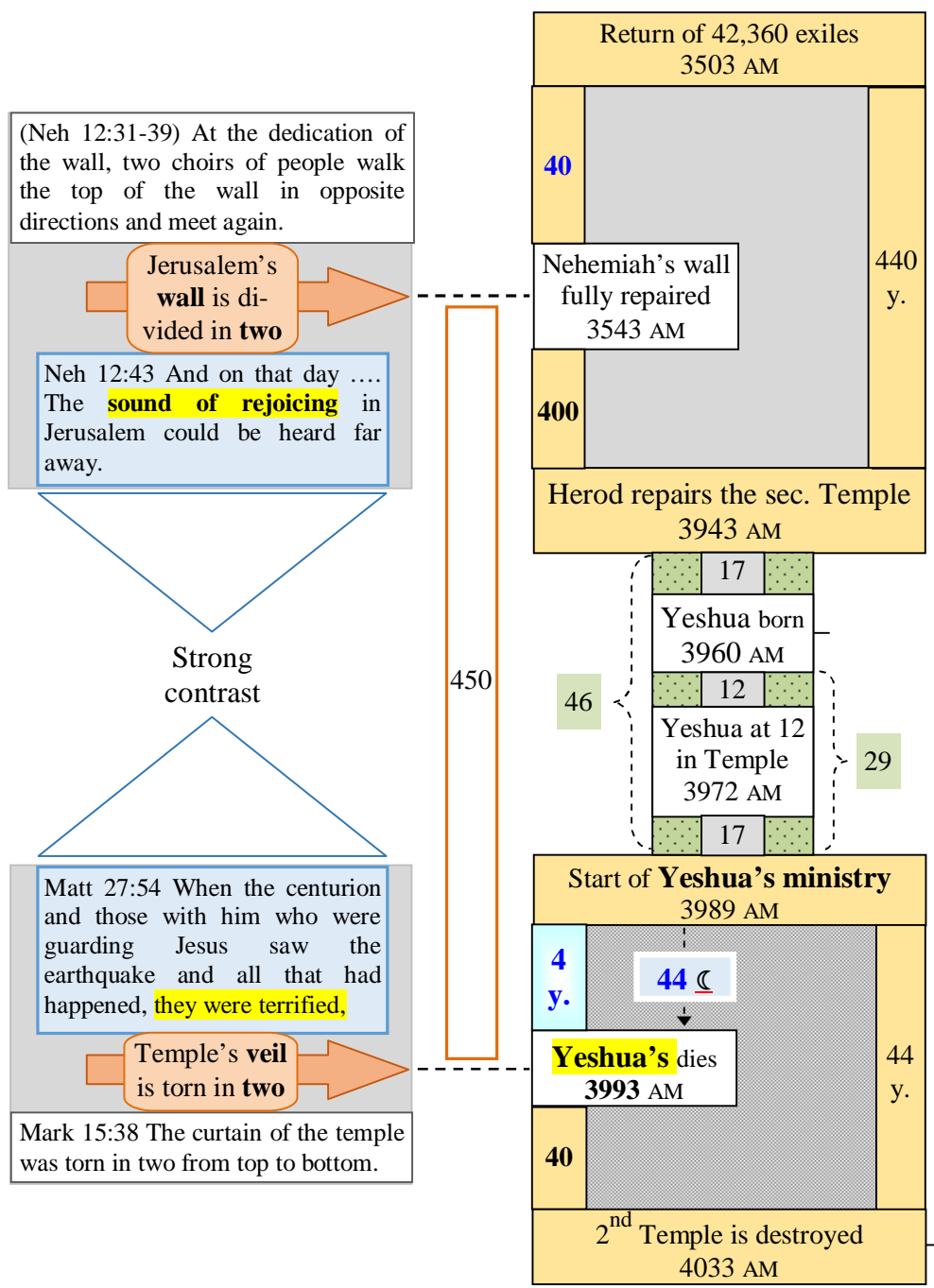
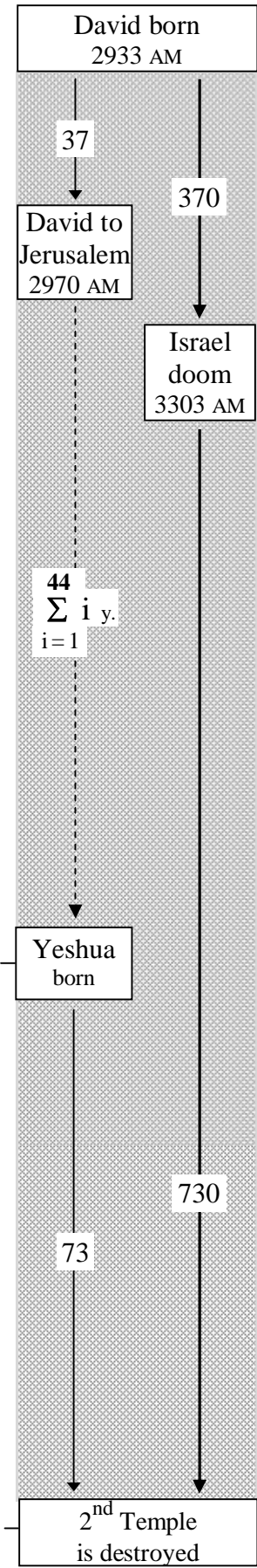

(Neh 12:31-39) At the dedication of the wall, two choirs of people walk the top of the wall in opposite directions and meet again.

Jerusalem's wall is divided in two

Neh 12:43 And on that day ... The **sound of rejoicing** in Jerusalem could be heard far away.

Strong contrast

Matt 27:54 When the centurion and those with him who were guarding Jesus saw the earthquake and all that had happened, **they were terrified,**

Temple's veil is torn in two

Mark 15:38 The curtain of the temple was torn in two from top to bottom.

→ Where does Joshua fit into this chronology?

The following reference will lead us to the answer:

- Acts 13:17-20 The God of the people of Israel **chose our fathers**; he made the people prosper during their stay in Egypt, ... he overthrew seven nations in Canaan and gave their land to his people as their inheritance. All this took about 450 years.
"After this, God gave them judges until the time of Samuel the prophet. NIV

Here Paul singles out '[God] chose our fathers'¹⁰⁴ as the event that starts his 450-year time span. And even though he doesn't tell us what event brought the period to a close he informs us that it happened shortly before the beginning of the Judges' period. But what does it mean 'to choose the fathers'? Were those fathers chosen together and who were they? According to Act 13:16 the fathers were chosen before the Israelites went to Egypt. This brings us back to the time of the three patriarchs: Abraham, Isaac and Jacob.

Let's suppose that Paul implied that the fathers were chosen as the result¹⁰⁵ of an action they had performed. Already, from that premise, we can exclude Jacob from any group chosen. Elsewhere it is clearly written that Jacob's destiny was settled even before he was born:

- Gen 25:23 And the LORD said to her: "Two nations are in your womb, Two peoples shall be separated from your body; One people shall be stronger than the other, And the older shall serve the younger." NKJV

This leaves only Abraham and Isaac in the role of the chosen fathers.

Our fathers were chosen¹⁰⁶ at the sacrifice (Akedah) of Isaac!

Nothing more difficult to accept could have been asked to Abraham but he didn't hesitate:

- Gen 22:2 Take your son, your only son, Isaac, whom you love,
- Gen 22:3 Early the next morning Abraham got up and saddled his donkey.

Isaac offered no resistance and it should be credited as faith.

Isaac learned at the last minute he would be the sacrifice and he hardly had any time to meditate on the situation. Thus, his reaction had to come from an inner conviction that whatever his father requested from him was the right thing to do.

- Gen 22:7 "The fire and wood are here," Isaac said, "but where is the lamb for the burnt offering?"

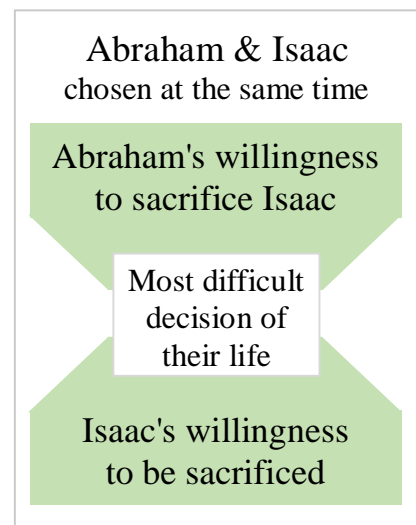

¹⁰⁴ Plural form, more than one father was chosen.

¹⁰⁵ If it were not the case why would they have been chosen in the first place?

¹⁰⁶ The expression 'The God of the people of Israel chose our fathers' does convey the idea that the 'choosing' was done following some actions of the 'fathers'. Also, given that Paul used this 'choosing' as the start of the 450 years we can deduce that the fathers' actions were done at the same time.

Isaac was not under restraint from anybody; he was alone with his father:

- Gen 22:5 Stay here with the donkey while I and the boy go over there.

The full consent of Isaac was mandatory. Abraham at 115 years old (2123 AM – 2008 AM) would never have been able to bind his 15 year-old son (2123 AM – 2108 AM) if this one had refused to fully cooperate. Isaac was a consenting victim here; he could have found an opportunity to run away but he didn't. On the contrary, he walked by himself to the altar:

- Gen 22:9 He bound his son Isaac and laid him on the altar, on top of the wood.

⇒ As a result God did **choose our fathers:**

- Gen 22:16-18 and said, "I swear by myself, declares the LORD, that because you have done this and have not withheld your son, your only son, I will surely bless you and make your descendants as numerous as the stars in the sky and as the sand on the seashore. Your descendants will take possession of the cities of their enemies, **and through your offspring all nations on earth will be blessed, because you have obeyed me.**"

Important: After this event neither Abraham nor Isaac were ever asked to prove their obedience again. No doubt the binding episode should be viewed as the most important event in both men's lives.

With the near certainty that the 450 year period of Act 13:20 started with the "binding of Isaac" in 2123 AM we can conclude that it ended at 2573 AM. This is 4 years after the land was divided by Joshua in 2569 AM and 10 years before the Gibeah event.

What happened in 2573 AM that could logically mark the end of the 450 year period?

According to Acts 13:16-20, at the end of the 450 years, the seven nations of Canaan had been conquered and the era of the Judges was soon to follow.

Joshua was chosen to lead the people to their inheritance:

- Josh 1:6-7 "Be strong and courageous, because you will lead these people to inherit the land I swore to their forefathers to give them.
- Josh 23:4-5 Remember how I have allotted as an inheritance for your tribes all the land of the nations that remain-the nations I conquered-between the Jordan and the Great Sea in the west.

The whole of the Exodus period is under the leadership of two individuals, Moses at **the beginning** and Joshua at **the end**. Therefore, it is quite reasonable to terminate the 450-year period with the death of Joshua (in 2573 AM).

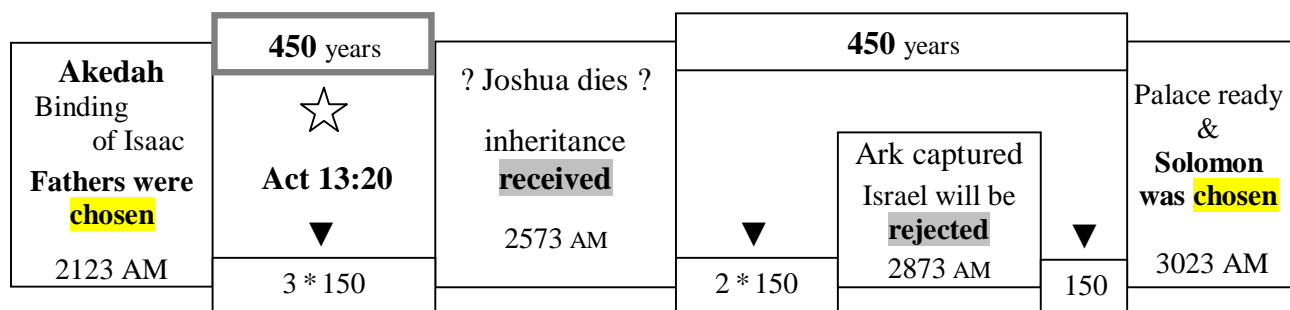

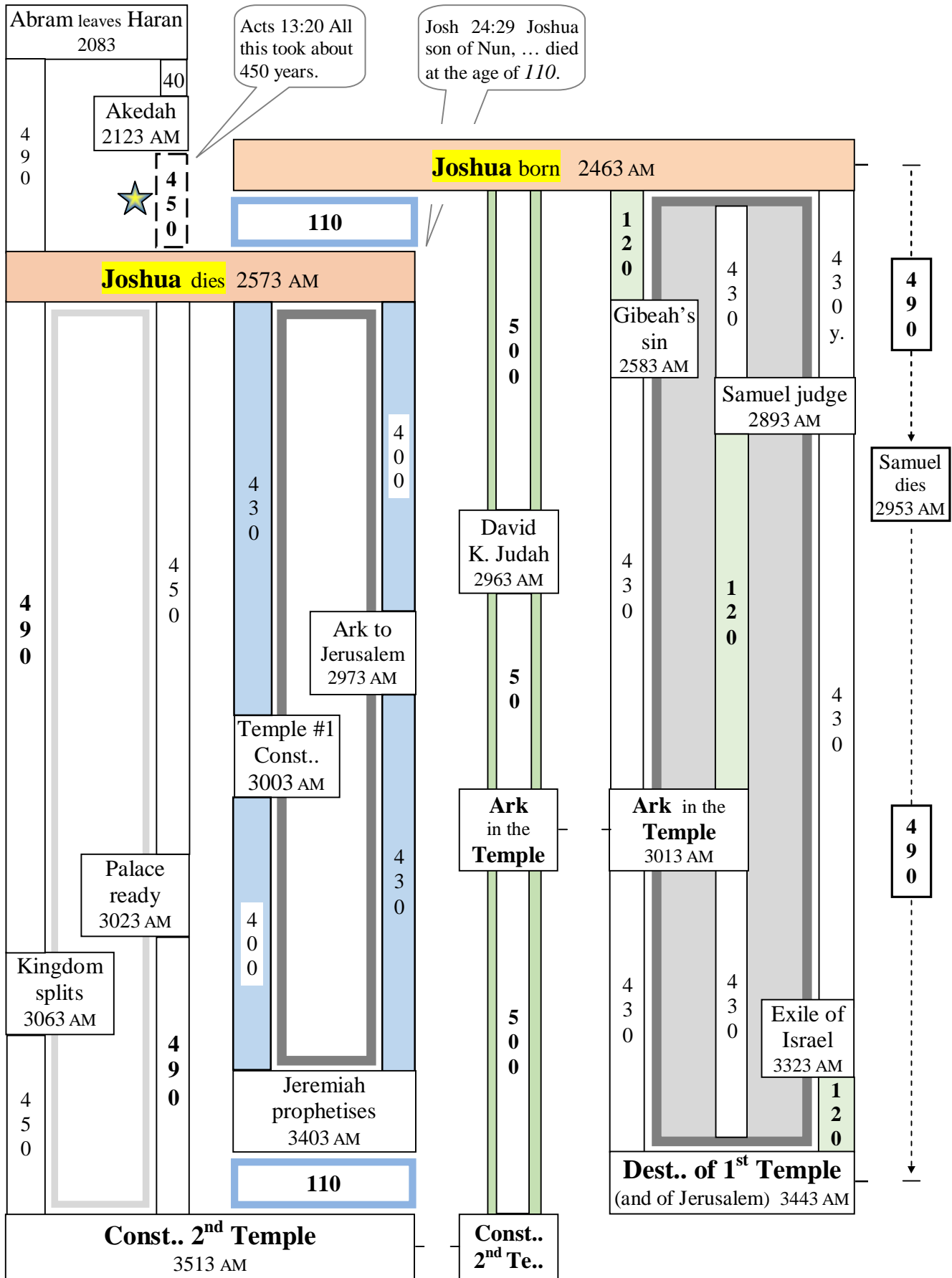

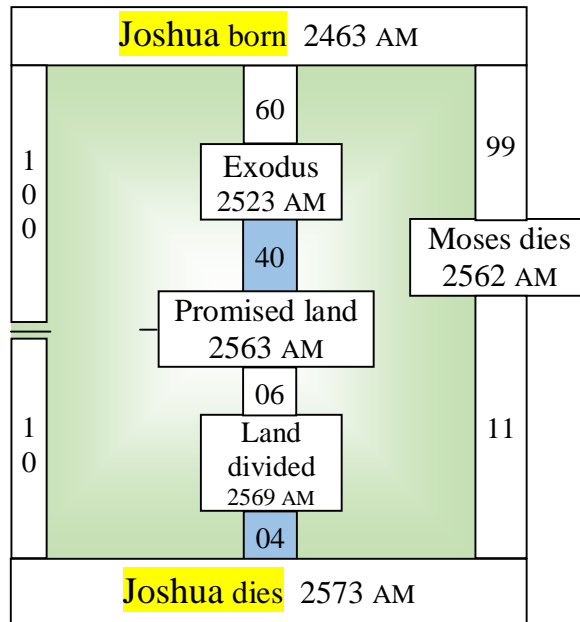

→ Figuring the chronology of the ‘oppressions and judges’ period

The first part of the ‘judges’ period’ includes all the oppressions and all the judges from Cushan up to the end of the Philistine oppression¹⁰⁷. This period cannot have started before the death of Joshua in 2573 AM and neither can it have ended after the start of Samuel’s judgeship. The

maximum time span available to fit in all the judges (but Samuel) and oppressions is therefore 320 years (2573 to 2893 AM).

Before figuring out the chronology of this period we have to find out if the sequence of judges and oppressions could have overlapped somehow.

The following table shows, in sequence, each judge and each oppressor with the number of years they apparently lasted. The total obtained this way is **390** years.

| Judge’s period (sequential layout) | | | |
|------------------------------------|------------------|----|---------------|
| | Oppression | | Judge |
| Judge 3:8 | Opp. Cushan | 8 | |
| Judge 3:11 | | | Ju Othniel 40 |
| Judge 3:14 | Opp. Eglon | 18 | |
| Judge 3:30 | | | Ju Ehud 80 |
| Judge 4:3 | Opp. Jabin | 20 | |
| Judge 5:31 | | | Ju Deborah 40 |
| Judge 6:1 | Opp. Median | 7 | |
| Judge 8:28 | | | Ju Gideon 40 |
| Judge 9:22 | Opp. Abimelech | 3 | |
| Judge 10:2 | | | Ju Tola 23 |
| Judge 10:3 | | | Ju Jair 22 |
| Judge 10:8 | Opp. Ammon | 18 | |
| Judge 12:7 | | | Ju Jephthah 6 |
| Judge 12:9 | | | Ju Ibzan 7 |
| Judge 12:11 | | | Ju Elon 10 |
| Judge 12:14 | | | Ju Abdon 8 |
| Judge 13:1 | Opp. Philistines | 40 | |

114 + 276

We will see next page that this number is too high

Total years = 390

¹⁰⁷ Samuel’s judgeship started at the end of the Philistines’ 40 years of oppressions.

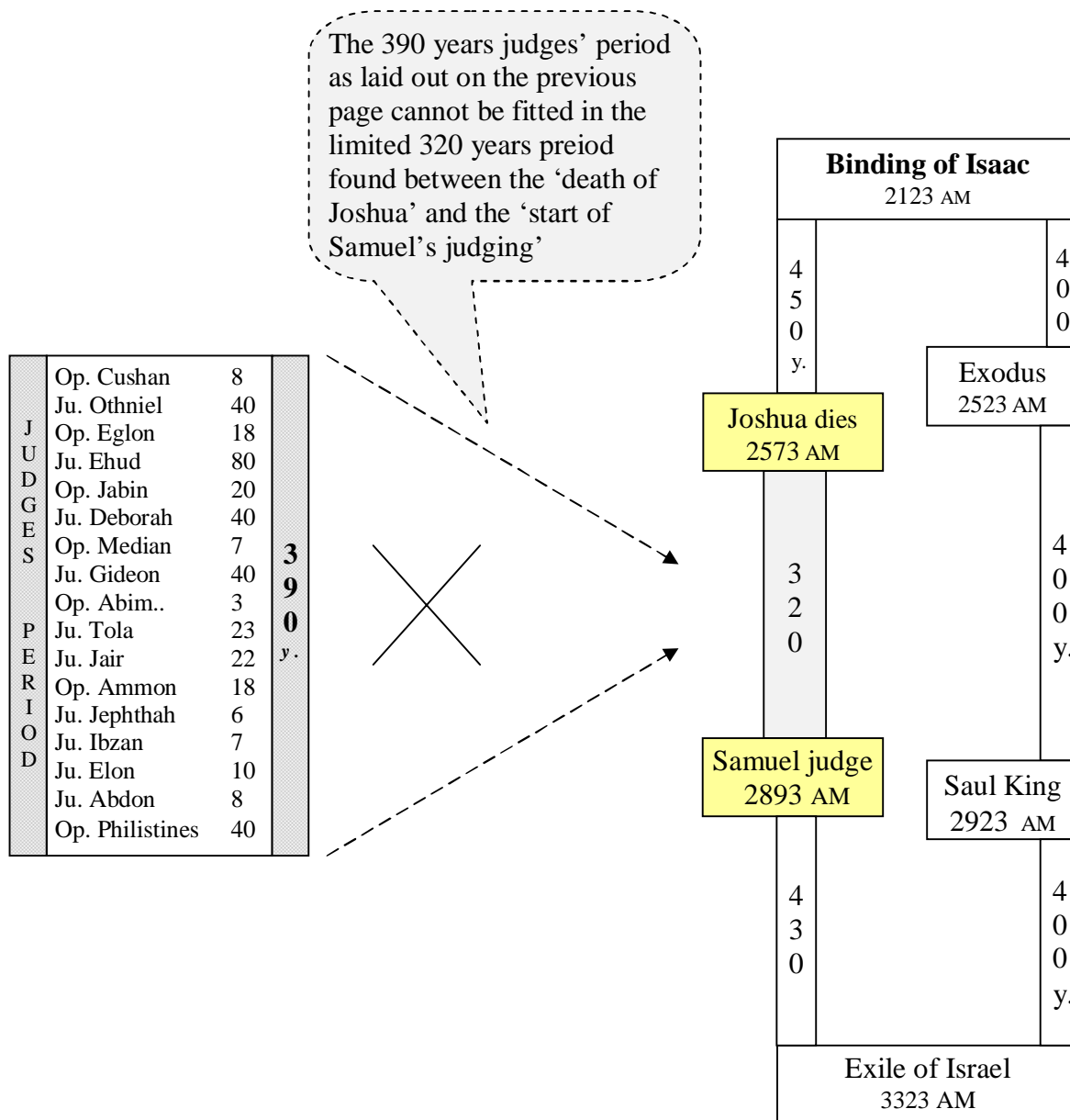

As it is clearly shown in the above figure, even if we start the oppression of Cushan the same year that Joshua died, there wouldn't be enough time to fit all the judges and all the oppressions before the start of Samuel's judgeship.

The 320 years between Joshua's death and the start of Samuel's judgeship cannot be increased. Therefore **the only way out** is to reduce the 390 year period previously obtained for the judges and oppressions. That can only be done by **overlapping** some and reducing the value of others. It may seem an impossible challenge given all the possibilities, but fortunately, as we will see, most of the judges and oppressions clearly didn't overlapped¹⁰⁸. Our first step to resolve this difficult puzzle is to find out when the Oppression of Cushan started. The following figure gives us a very strong indication that it was at 2593 AM.

¹⁰⁸ «it is decidedly contrary to the meaning of the book, to represent any two of the judges as ruling in different parts at the same time. At the commencement of each new section, it is always the nation collectively which is spoken of» Ref : John Kitto (1804-1854) *The Pictorial Bible*

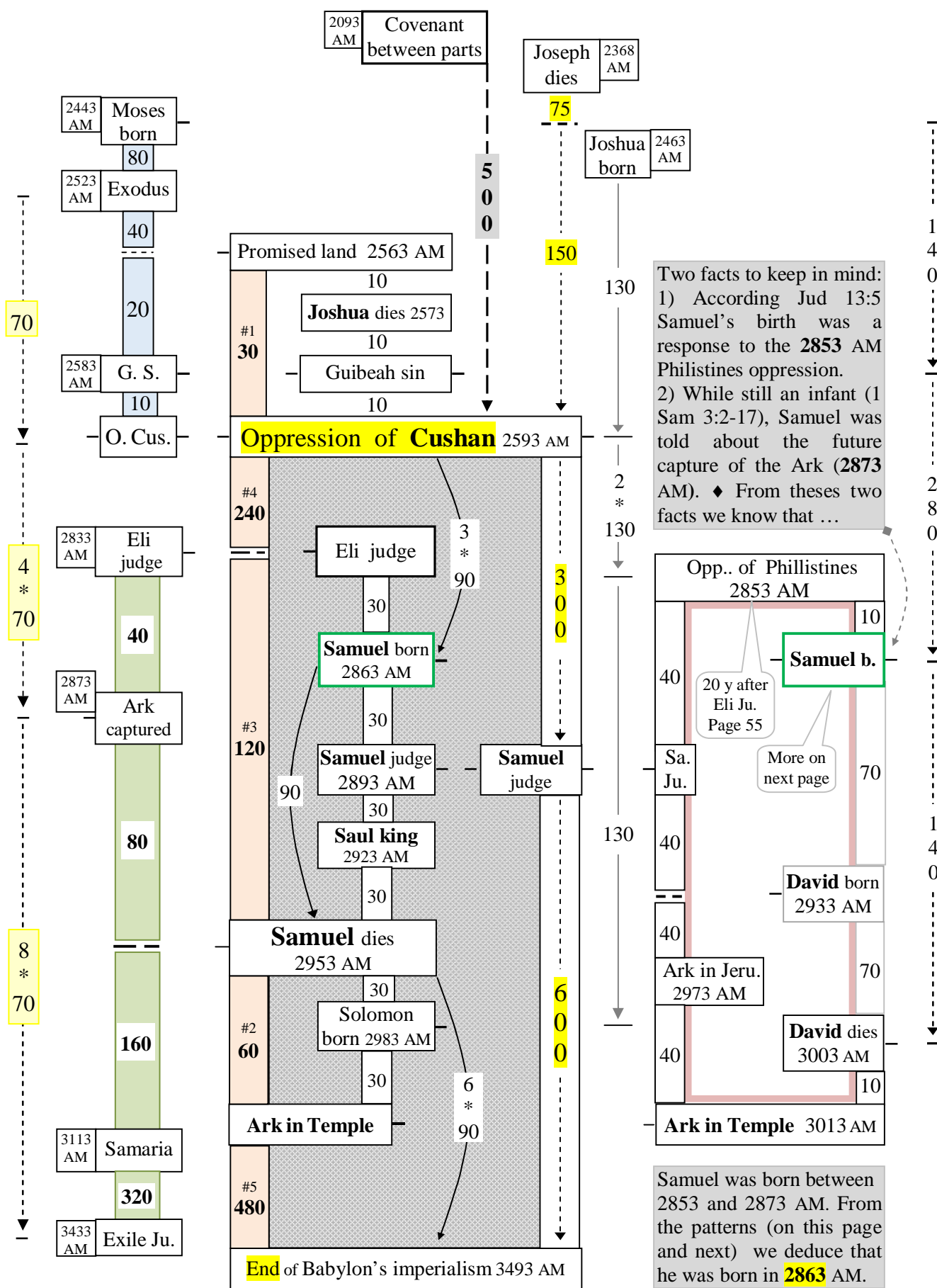

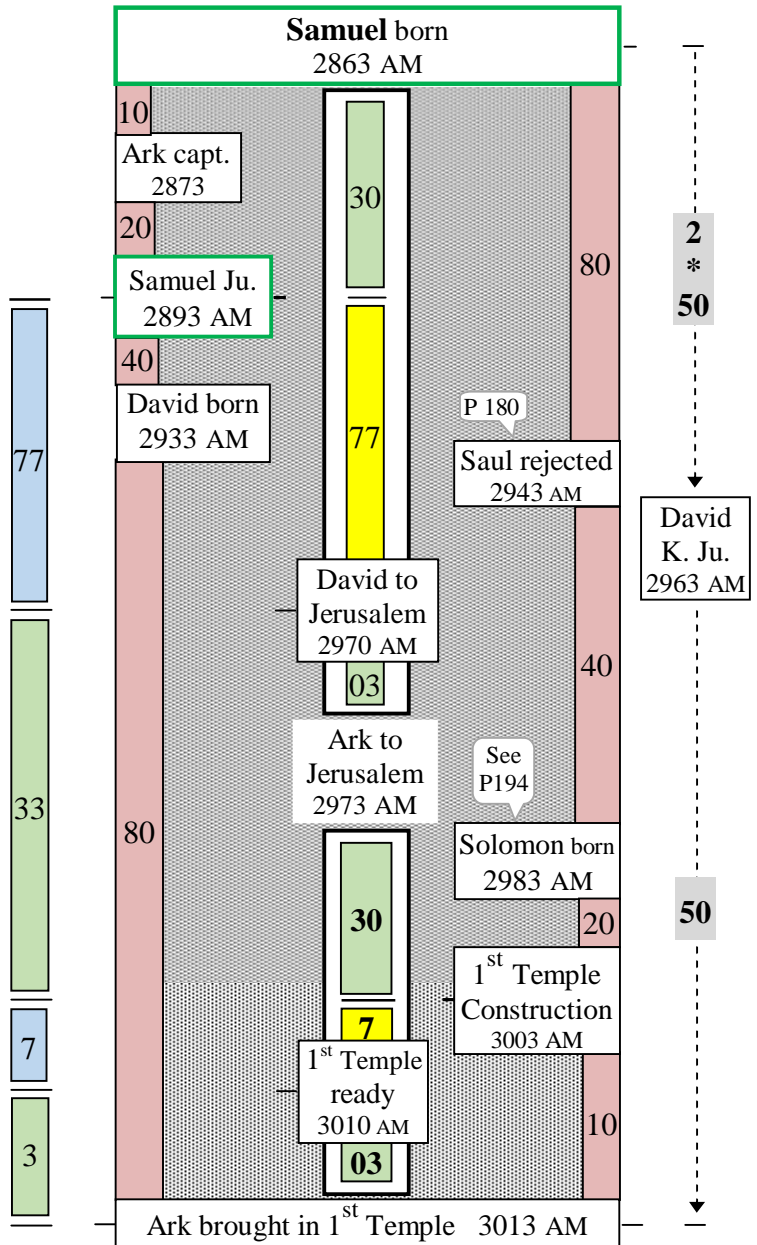
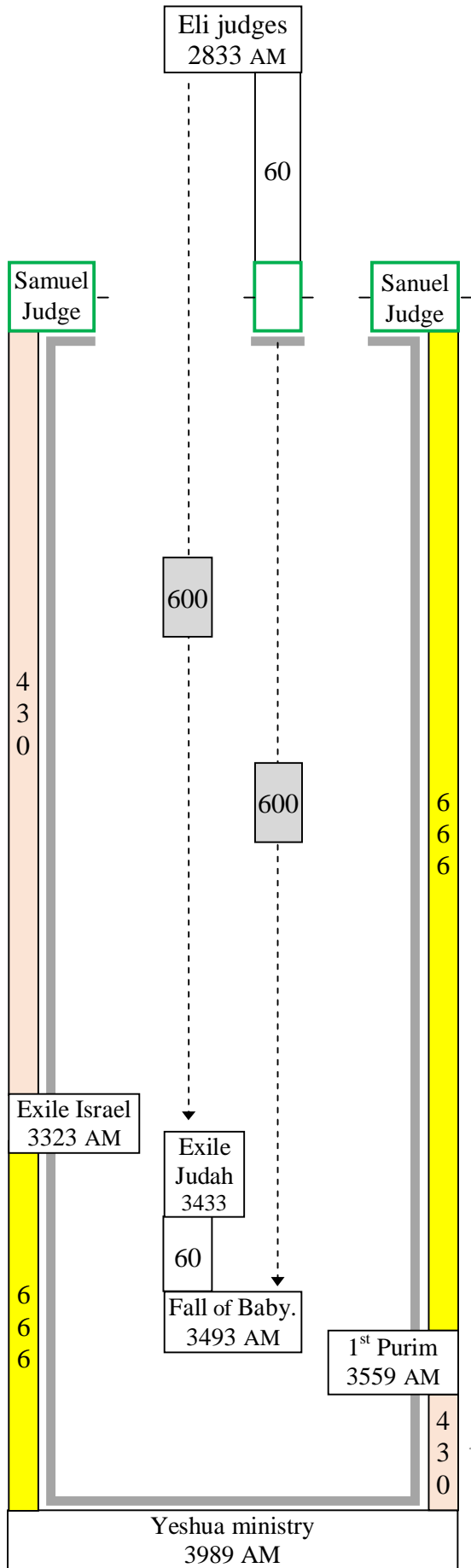

☆ More amazing patterns involving Samuel on page 220

The date of Jephthah's judgeship can be fixed.

After 18 years of oppression, Ammon claimed a part of Israel's territory pretending that it belonged to the Ammonites. Jephthah, a warrior, answered back that this territory had been under the control of Israel for the last 300 years:

- Judg 11:25-26 For **300 years** Israel occupied Heshbon, Aroer, the surrounding settlements and all the towns along the Arnon. Why didn't you retake them during that time?

If we can find out the origin of these 300 years we will be able to figure out the year that Jephthah became Judge.

The Bible tells us that the year Moses died (2562 AM), the territory around the Arnon was captured and given to the tribe of Reuben:

- Num 21:24 Israel, however, put him to the sword and took over his land from the Arnon to the Jabbok,
- Deut 2:36 From Aroer on the rim of the Arnon Gorge, and from the town in the gorge, even as far as Gilead, not one town was too strong for us. The LORD our God gave us all of them.
- Deut 3:16-17 But to the Reubenites and the Gadites I gave the territory extending from Gilead down to the Arnon Gorge (the middle of the gorge being the border) and out to the Jabbok River, which is the border of the Ammonites.

This territory of Reuben's is the same land that would be claimed by Ammon 300 years later, thus making Jephthah's judgeship start in 2862 AM (2562 + 300).

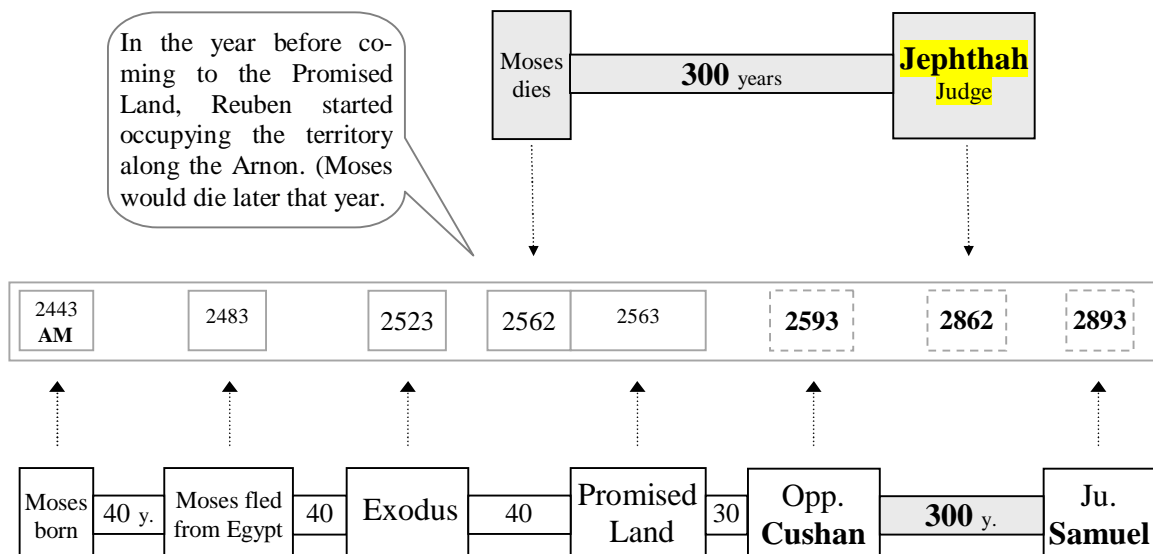

We now have three important dates to help us chart the chronology of the period of Oppressions and Judges. From those dates (2593, 2862, 2893) we are going to move forwards and backwards and lay down as many events as possible.

Judges conflicting chronology

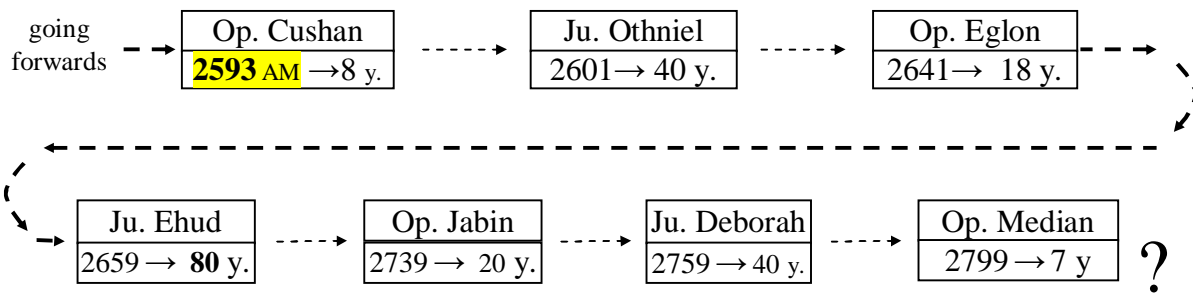

Problem :

The progression of the sequence of events at the top of this page, which goes forward from the Opp of Chushan, sets the

Opp of Median in 2799 AM

Median
in
2799 AM

؟

Median
in
2749 AM

but then

it creates an obvious conflict with the sequence of events found at the bottom of this page which goes backwards from Samuel and sets the

Opp of Median in 2749 AM.

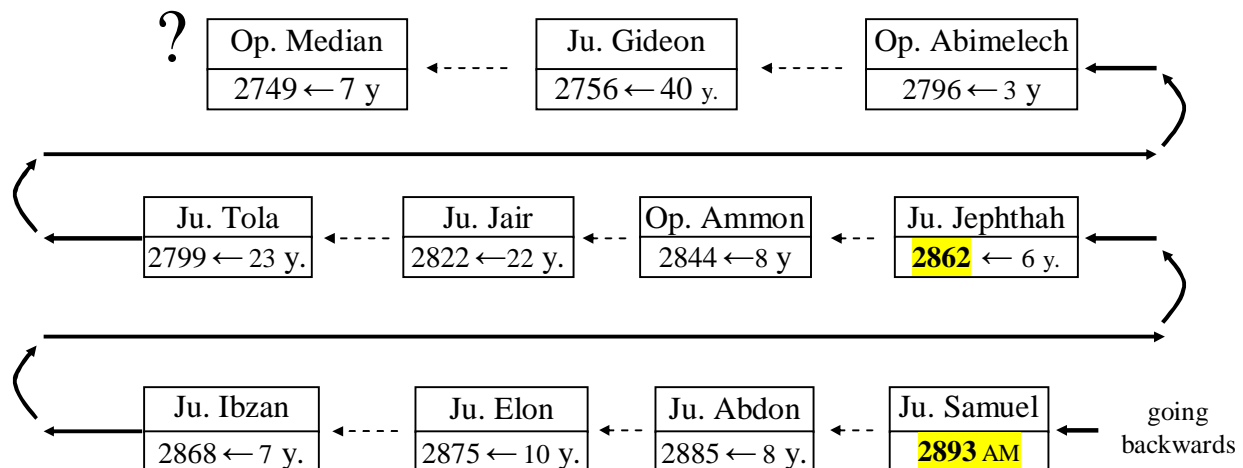

Judges **right** chronology

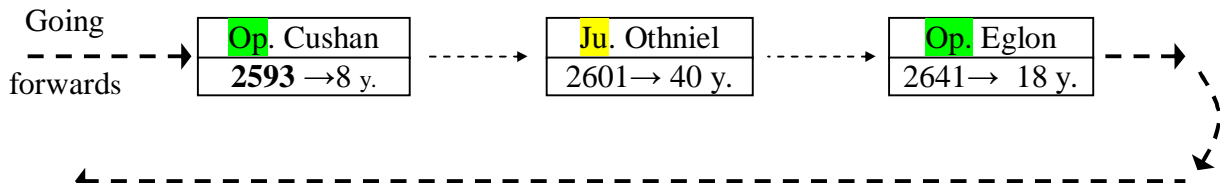

Solution : rejecting the unlikely 80 years of Ehud

The solution to harmonise the 'forwards' and the 'backwards' sequence is to recognize that the 80 years of Ehud is highly suspicious and could have been inflated as the result of a scribal error. (Notice that this number, 80, is twice the highest value, 40, reached by three other Judges). The suggested solution will reduce that value from 80 to 18 and will introduce a gap of 12 years at the end of Deborah's 40-year judgeship.

It is worth noting that we could have tried to overlap the 80 years of Ehud with the judgeship of other Judges but this possibility has been rejected on the grounds that the Bible's text doesn't suggest any overlapping before the introduction of the double oppressions of Ammon and the Philistines.

- Judg 10:7 and He sold them into the hands of the Philistines and into the hands of the people of Ammon.

This solution may seem innocuous but, as you will discover in the following pages, it is going to transform the Judge's period **inconsequential** sequence of numbers into a stunning series of pattern, imprinted by the Divine Finger.

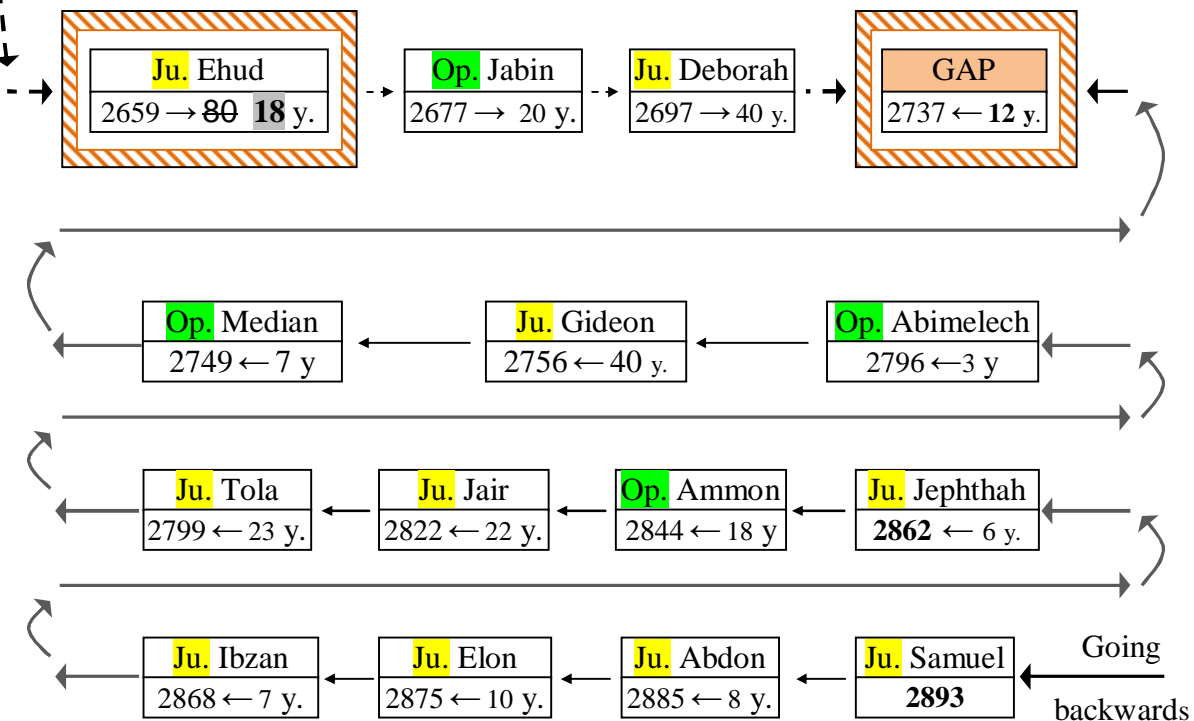

Judges' period

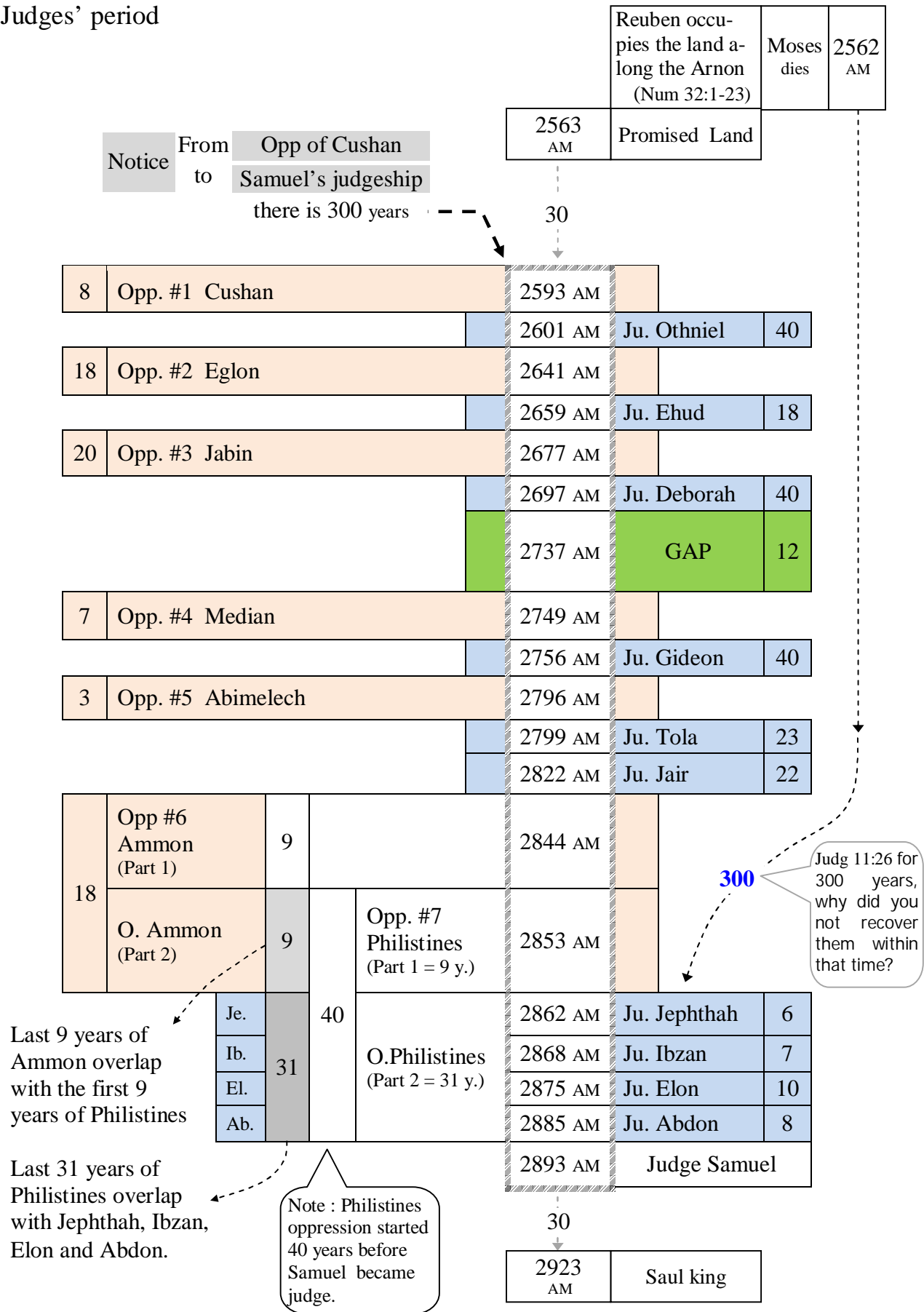

Judges's period (perfect setting & emergence of amazing patterns)

| | | | | | | | | | | | | | |
|----|-------------------|--------------------|-------------------------|----|---------|--------------|----|----|---|--|--|--|-----------------|
| 8 | Opp. #1 Cushan | 2593 AM | | | 48 | 48 | | | | | | | |
| | | 2601 AM | Ju. Othniel | 40 | | | | | | | | | |
| 18 | Opp. #2 Eglon | 2641 AM | | | | | | | 1 | | | | |
| | | 2659 AM | Ju. Ehud | 18 | 47 | 2 | * | | 4 | | | | 12 ² |
| | | | | | + | | | | | | | | |
| 20 | Opp. #3 Jabin | 2677 AM | | | 49 | 48 | | | | | | | |
| | | 2697 AM | Ju. Deborah | 40 | | | | | | | | | |
| | | 2737 AM | GAP | | 12 | X | | | | | | | 12 |
| 7 | Opp. #4 Median | 2749 AM | | | 47 | | | | | | | | |
| | | 2756 AM | Ju. Gideon | 40 | | | | | | | | | |
| 3 | Opp. #5 Abimelech | 2796 AM | | | | | | | | | | | |
| | | 2799 AM | Ju. Tola | 23 | 48 | | | | | | | | |
| | | 2822 AM | Ju. Jair | 22 | | | | | | | | | |
| | 9 | Opp. #6 Ammon (P1) | | | | | | | | | | | |
| | | 2844 AM | | | | | | | | | | | |
| 18 | 9 | O. Ammon (P2) | Opp #7 Philistines (P1) | 9 | | | | | | | | | |
| | | | | | 2853 AM | | | | | | | | |
| | | | | 6 | 2862 AM | Ju. Jephthah | 6 | 49 | | | | | |
| | | | | 7 | 2868 AM | Ju. Ibzan | 7 | | | | | | |
| | | | | 10 | 2875 AM | Ju. Elon | 10 | | | | | | |
| | | | | 8 | 2885 AM | Ju. Abdon | 8 | | | | | | |
| | | | | | 2893 AM | Judge Samuel | | | | | | | |

See how this 40 years of Philistines is perfectly mapped by the sequence 6,7,8,9,10.

300

In the previous figure we can see how the ‘assumed’ 12-year gap, introduced before the 7-year oppression of Median, is dividing the whole 300-year period of the judges into three strongly related parts (12² , 12, 12²). This strategic positioning of the gap may seem conveniently opportunistic, but it is not. In fact, there are only a limited number of locations where such a gap could have been introduced without violating the Bible’s record. The gap couldn’t have come after any oppression or between two successive judges. A careful reading of the Book of Judges will show that the judges were introduced either immediately at the end of an oppression (in these cases the judge was himself responsible for ending the current oppression) or shortly following another Judge (like Tola, Ibzan, Elon, Abdon).

In the end there is only four locations where an ‘undocumented’ gap of years could have possibly taken place during the sequence of judges and oppressions. These locations are before the oppression of Eglon, Jabin, Median and Ammon. Notice that in each case the Book of Judges introduces the coming oppression with ‘Once again the Israelites did evil in the eyes of the LORD’ (Judg 3:12, Judg 4:1, Judg 6:1, Judg 10:6). Technically, a delay could have took place before any of these oppressions. Because of all the patterns that suddenly emerge with this choice, I settled for a single gap before the oppression of Median.

One more layer of “stunning” patterns from the Judge’s timeline.

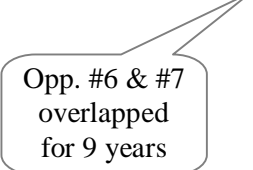
| | | | | | | | | | | | |
|---|--------|----|--------|--------|---|---|---|----|-----------------------------|----|----|
| Opp. #1 Cushan | 8 | | | | | | | | | | |
| Ju. Othniel | 40 | | | | | | | 48 | | | |
| Opp. #2 Eglon | | 18 | | | | | | | | | |
| Ju. Ehud | | 18 | | | | | | 56 | | | |
| Opp. #3 Jabin | | 20 | | | | | | | Sequence of 5 numbers | | |
| Ju. Deborah | 40 | | | | | | | 52 | | | |
| Gap | 12 | | | | | | | | 48 | | |
| Opp. #4 Median | | 7 | | | | | | | 50 | | |
| Ju. Gideon | | 40 | | | | | | 50 | 52 | | |
| Opp. #5 Abimelech | | 3 | | | | | | | 54 | | |
| Ju. Tola | 23 | | | | | | | | | | |
| Ju. Jair | 22 | | | | | | | 54 | | | |
| Opp. #6 Ammon 18 years | Part 1 | 9 | | | | | | | | | |
| | Part 2 | 9 | Part 1 | | | | | | Sequence of 5 numbers | | |
|  | | | | | | | | | | | |
| | | | 31 | Part 2 | | | | | | | |
| Opp #7 Philistines 40 years | | | | | | | | | | | |
| | | | | | | | | | | | |
| | | | | | | | | | | | |
| | | | | | | 2 | | | | | |
| | | | | | 2 | + | * | | Ju. Jephthah | 6 | |
| | | | | | * | | 8 | | Ju. Ibzan | | 7 |
| | | | | | 8 | | | | Ju. Elon | 10 | |
| | | | | | | | 8 | | Ju. Abdon | | 8 |
| | | | | | | | | | | | 10 |

In the next pattern the timeline values are separated in 5 distinct groups (G1, G2, G3, G4, G5)

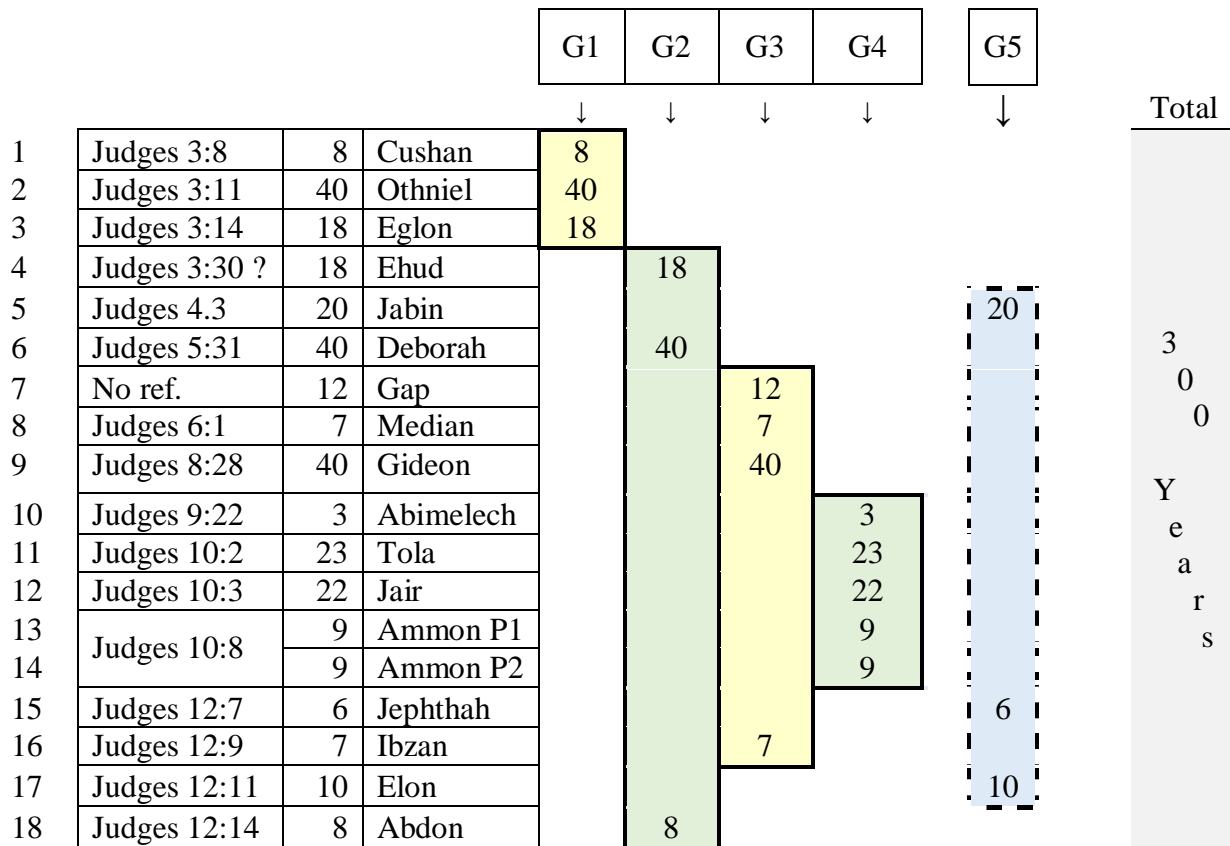

In each of the first four groups (G1, G2, G2, G4) the values add up to 66.

$$\begin{aligned}
 G1 &= 8 + 40 + 18 &= 66 \\
 G2 &= 18 + 40 + 8 &= 66 \\
 G3 &= 12 + 7 + 40 + 7 &= 66 \\
 G4 &= 3 + 23 + 22 + 9 + 9 &= 66 \\
 G5 &= 20 + 6 + 10 &= 36
 \end{aligned}$$

Notice that each one of the 18 values has been used one time only.

Unexpectedly, the values in Group G5 add up to 36 (instead of 66). Does this invalidate the pattern? Not at all, we can preserve the integrity of this pattern by representing the value 36 by its factors: $6 * 6$.

| | | |
|----------------------------|---|---------|
| $G1 = 8 + 40 + 18$ | = | 66 |
| $G2 = 18 + 40 + 8$ | = | 66 |
| $G3 = 12 + 7 + 40 + 7$ | = | 66 |
| $G4 = 3 + 23 + 22 + 9 + 9$ | = | 66 |
| $G5 = 20 + 6 + 10$ | = | $6 * 6$ |

Could such a thing be possible without God's involvement?

NO

If any of the Judges or Oppressions had lasted a single year longer or ended a single year earlier, none of the previous amazing patterns would have been possible.

Here is another way to express the singularity of each individual period of time imputed to the Judges and their oppressors. We can group all the value found **before** and including the 12 years gap (i.e. 8,40,18,18,20,40 - **12**)

in 3 fully reflective arrangements of numbers and then do the same with all the values found **after** and including the 12 years gap (i.e. **12** - 7,40,3,23,22,9,9,6,7,10,8).

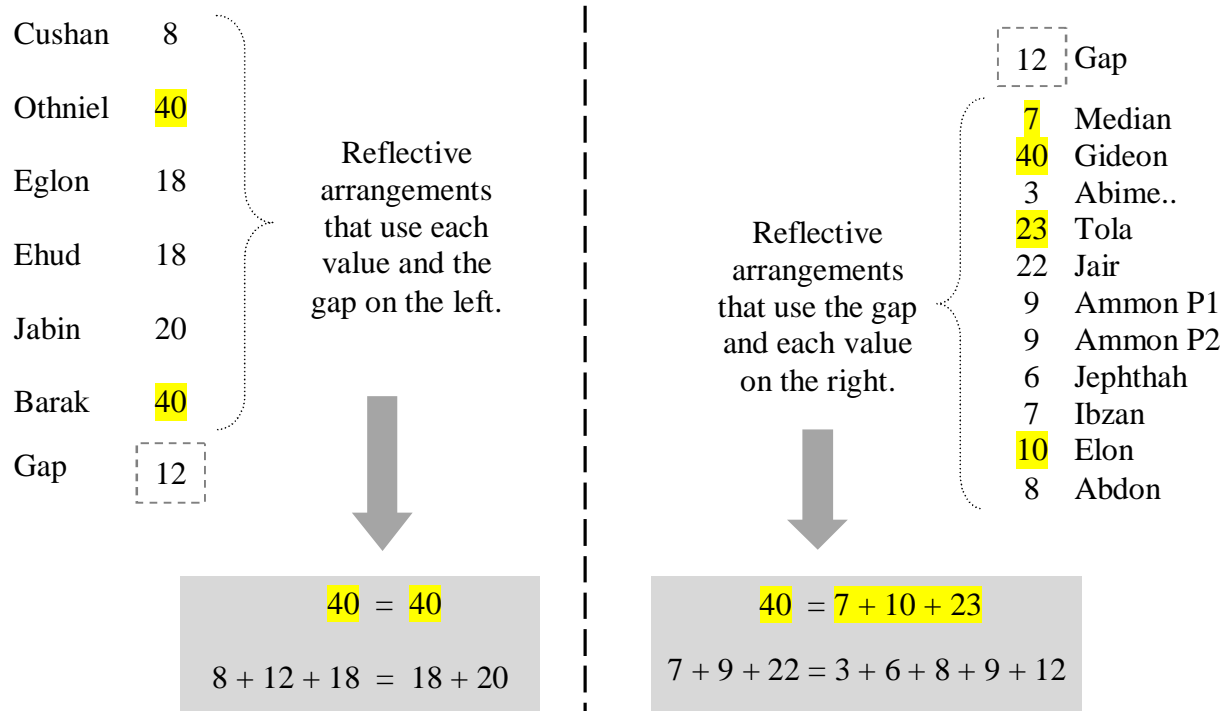

Note: Most of the patterns in the last few pages couldn't have been found without reducing Ehud's 80 years to 18. I am well aware that invoking a scribal error to invalidate a value found in the biblical text is a serious matter and shouldn't be done without serious consideration. Below is a Hebrew representation of both numbers 80 and 18. Reading from right to left, we can see that the first 4 letters in each box are almost identical, however the writing of 80 involves only one word (eight in its plural form) while the writing of 18 is done with two words ('eight' in its singular form followed by ten).



The partial similarity of the two numbers doesn't prove that a scribe, a long time ago, wrongly transcribed 80 instead of 18 on his manuscript while copying Judge 3:30. It does however show that it is not absolutely unthinkable. In the light of the previous few charts and the fact that Ehud could have hardly judged for 80 years, '18' is therefore a very appealing solution.

→ Did the Israelites wait 19 years in Kadesh Barnea? Yes

After leaving Egypt the Israelites went to Kadesh Barnea where God told them to take possession of the land. But because they were afraid of the inhabitants of the land they sent 12 spies to explore the region and report back what they saw. Unfortunately 10 of the 12 spies brought negative reports and discouraged the whole assembly. (See Deut 1:28-31) Because of this lack of faith in God's protection they had to wander in the desert for 38 years.

Deut 2:14 And the time we took to come from Kadesh Barnea until we crossed over the Valley of the Zered was '38' years,

Interestingly they didn't leave Kadesh immediately after the return of the spies and here is what the Bible has to say about it:

Deut 1:46 So you remained in Kadesh many days, according to the days that you spent there.

Isn't it a very cryptic way to say that they spent some more time in Kadesh before turning their back to the land?

The highly esteemed medieval French rabbi known as Rashi thought that the clause 'according to the days that you spent there' meant that they spent **as much time in Kadesh Barnea as the amount of time spent in all the other locations visited.**

Therefore out of their 38 years wandering in the desert, nineteen years would have been spent in Kadesh. Not all the Jewish sage believe the interpretation of Rashi but I found many strong patterns to vindicate his theory.

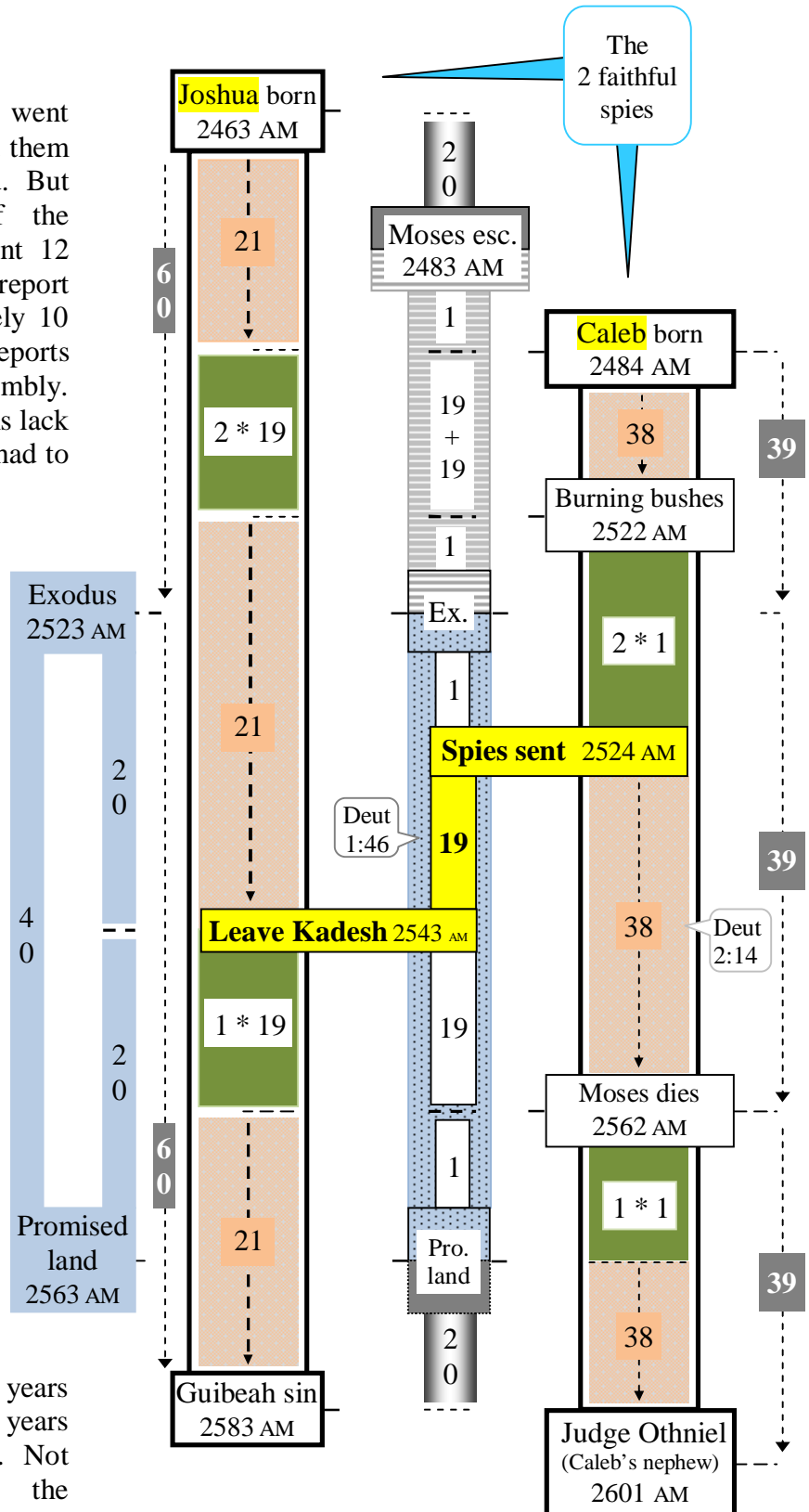

★ Caleb was 40 : Spies sent
 Joshua was 80 : Leaves Kadesh

Sequence starts with a **spying event**



Joshua send spies
2524 AM

Sojourn in Kadesh Barnea

Joshua born
2463 AM

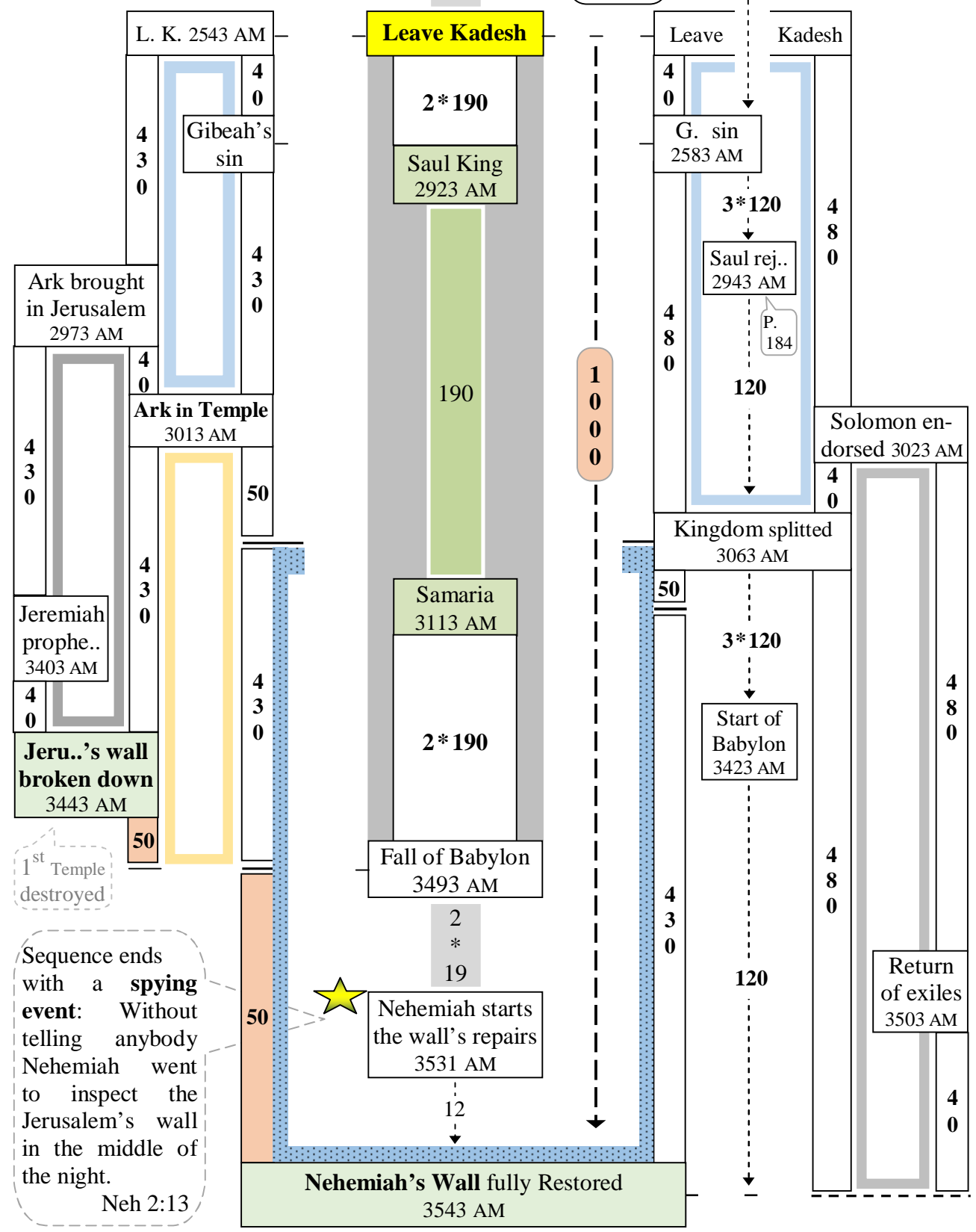

1st Temple destroyed

Sequence ends with a **spying event**: Without telling anybody Nehemiah went to inspect the Jerusalem's wall in the middle of the night.
Neh 2:13

→ Pilgrimage of fathers and sons

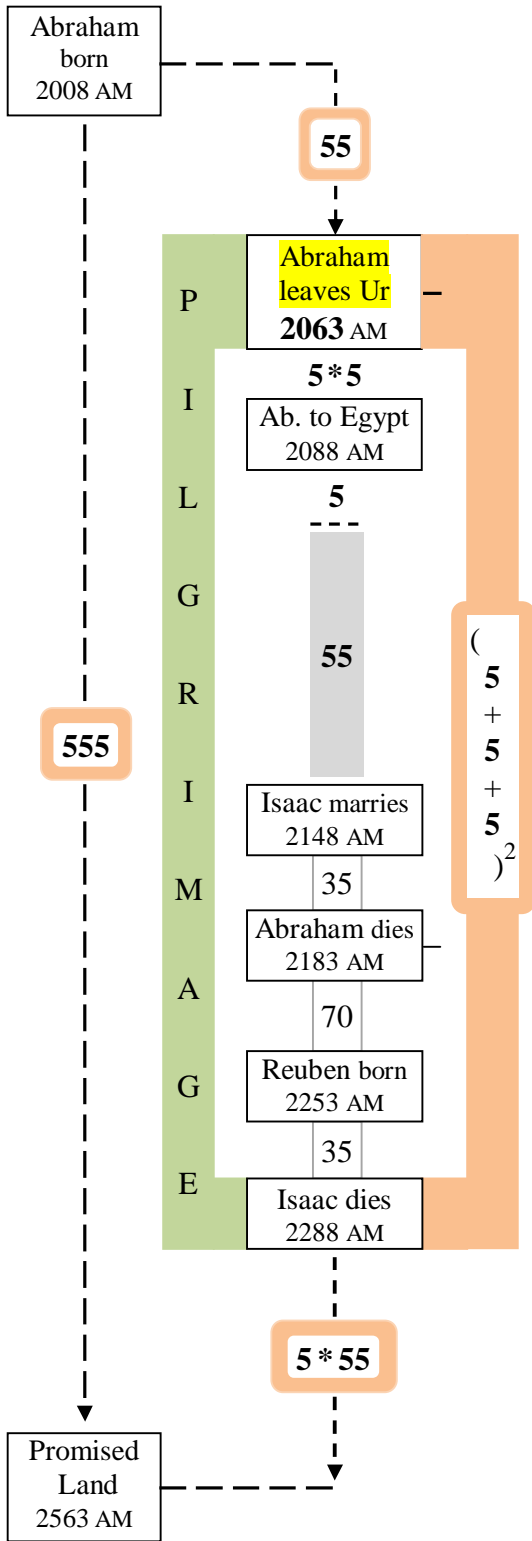

There is no specific statement in the Bible to help us figure out when Abraham left Ur and started his pilgrimage ...

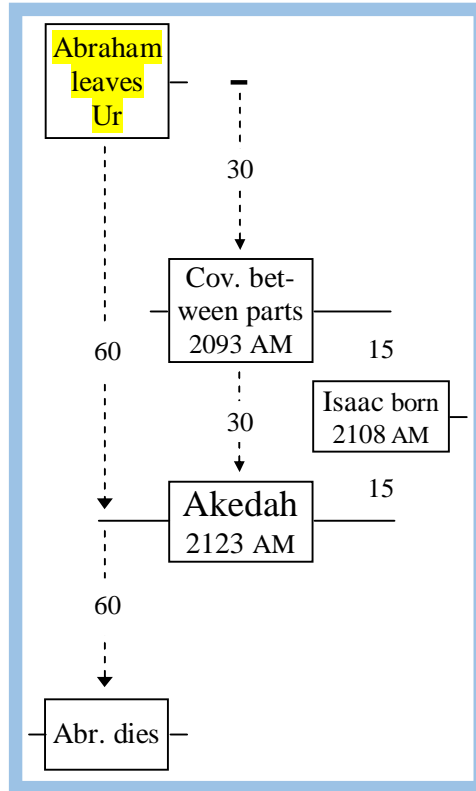

... However we can speculate that it happened in 2063 AM as it is strongly suggested by this figure. This new date (2063 AM) will lead us to some surprising discovery.

For instance, we saw earlier that the northern tribes of Israel went into Exile in 3323 AM. This is exactly 20 * 63 years after Abraham own Exile from Ur in 2063 AM.

Abra. Leaves Ur 2063 AM

20 * 63

Exile of Israel 3323 AM

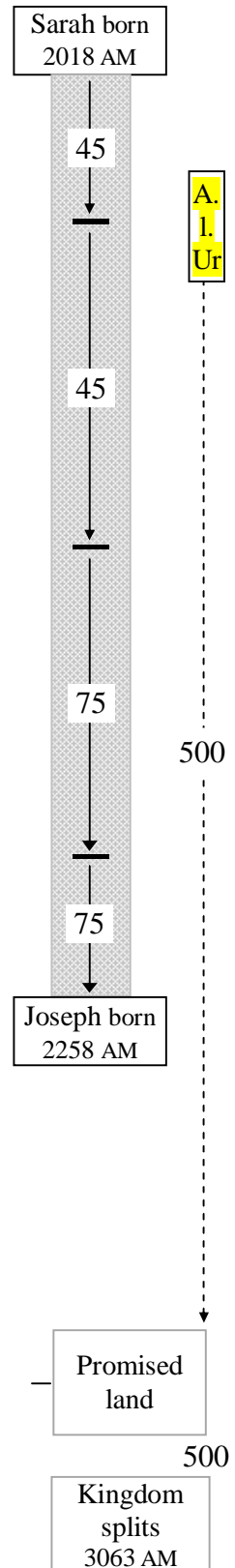

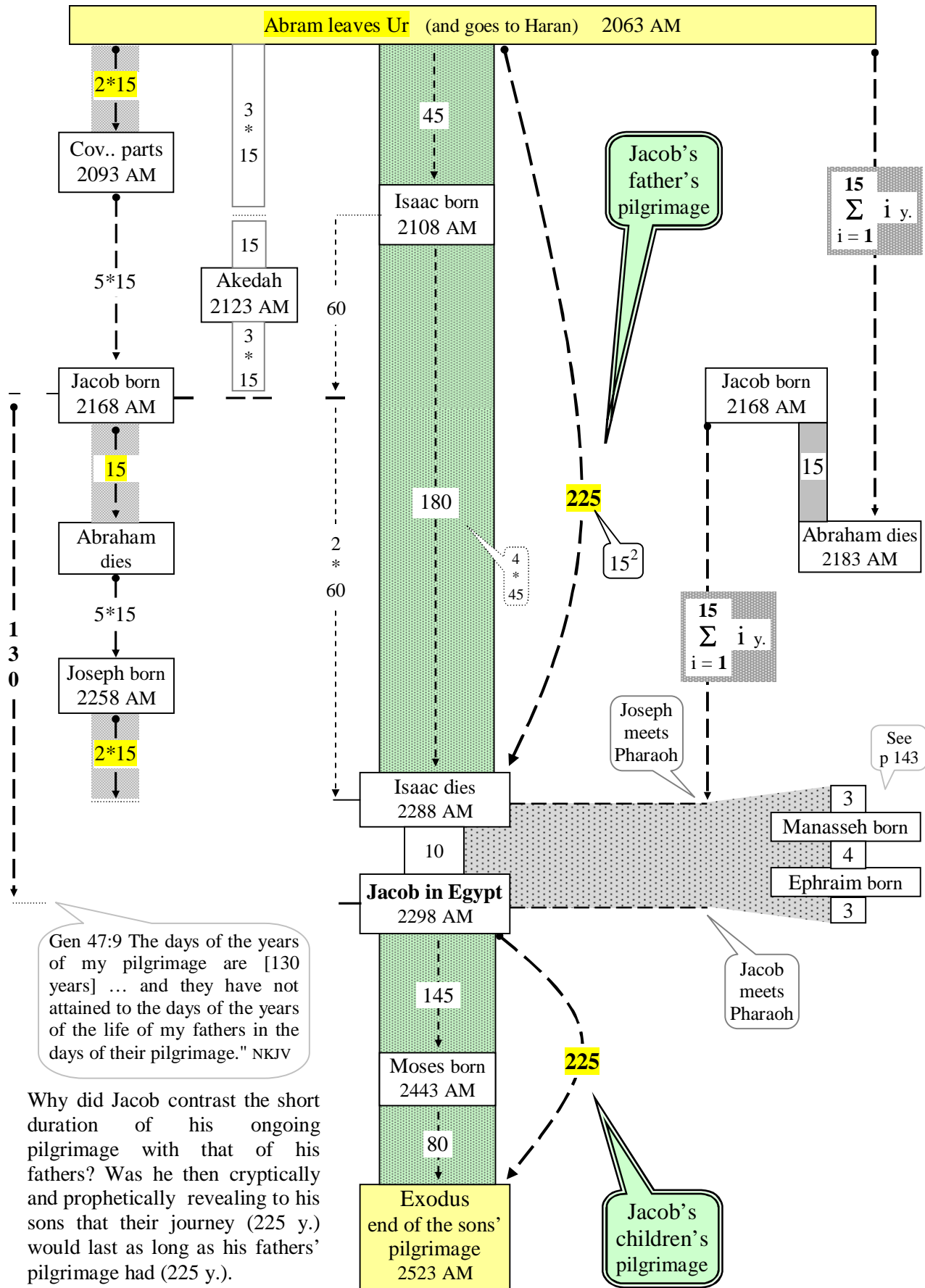

→ When did Abraham marry?

Establishing which year Abraham got married to Sarah is a very speculative task, there is absolutely no direct information to clarify the point. However, we have seen in this chronology that each biblical event always fits in a strong network of patterns and by finding many of these around the year 2033 (wedding year?) should be a clue in itself. You decide.

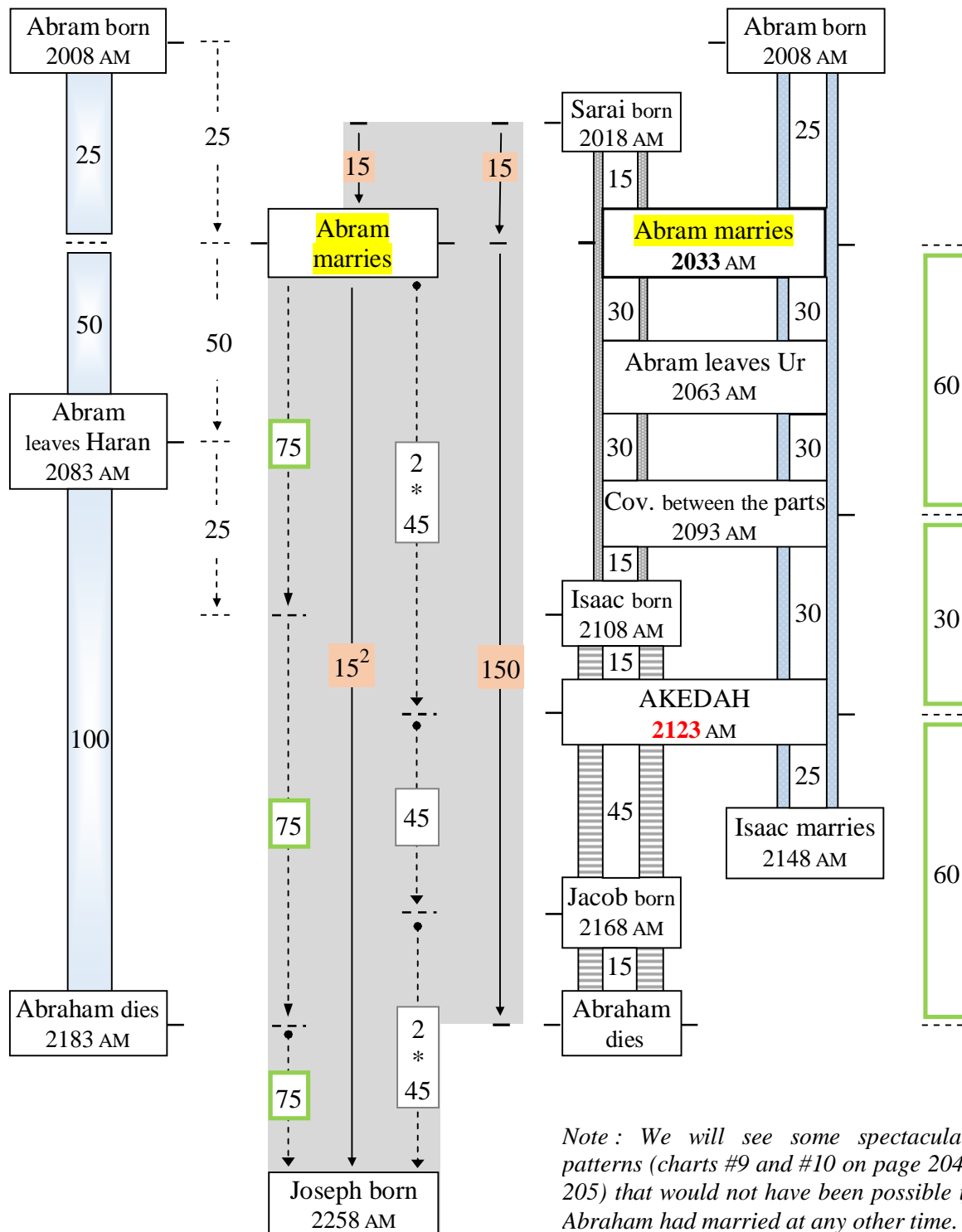

Note : We will see some spectacular patterns (charts #9 and #10 on page 204-205) that would not have been possible if Abraham had married at any other time.

➔ Understanding Judah & Israel EXILE

❖ About Judah's Exile

Contrary to some commentator's belief, Ezekiel portraying of Judah 40 years of sin was not a way to erase their fault. God had clearly told Judah (collective name for the two tribes of Benjamin and Judah) that **she** wouldn't be spare for her sins.

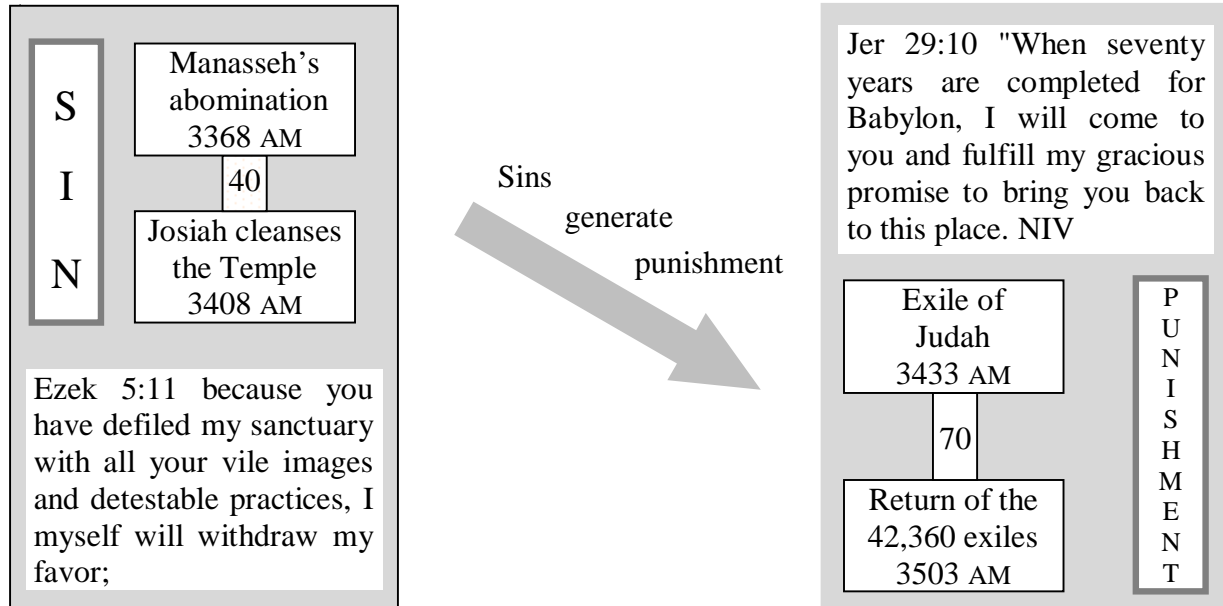

Problem: But according Isaiah 40:2 the 'penalty time' generated by the 40 years of sin should have been twice that time (i.e. **80** years instead of 70 years)

- Isa 40:2 proclaim to her that her hard service has been completed, that her sin has been paid for, that she has received from the LORD's hand **double** for all her sins. NIV

Are we missing something?

If you look carefully at the next chart you will see that Judah's suffering was not over at the end of the 70-year captivity (exile). When the people came back from exile in 3503 AM, they had to go through 10 years (3503-3513 AM) of privation because the land was then in the 60th year of her 70-year rest (desolation of the land) . (In others words even if the people were back to a land that had flowed with milk and honey in the past, they were not going to see any crop in the fields for the next 10 years)

Understand the following two very important points:

1. The 70-year of Exile (3433-3503 AM) and the 70-year of land desolation (3443-3513 AM) are two different period that partially overlap.
2. During the 70-year desolation, the land was not producing any crop. This inactivity was a compensation for the previous 490 years of 'non stop' exploitation..

Therefore the people of Judah were punished during 80 years and it came in two parts: 70 years of exile (from 3433-3503 AM) followed by 10 years of privation after they came back from exile (3503-3513 AM).

| | |
|--|--|
| <p>Judah received DOUBLE (i.e. 80 years) for her 40 years of sin</p> | <p>Jer 16:18 I will repay them <u>double</u> for their wickedness and their sin, because they have defiled my land with ... and have filled my inheritance with their detestable idols."</p> |
|--|--|

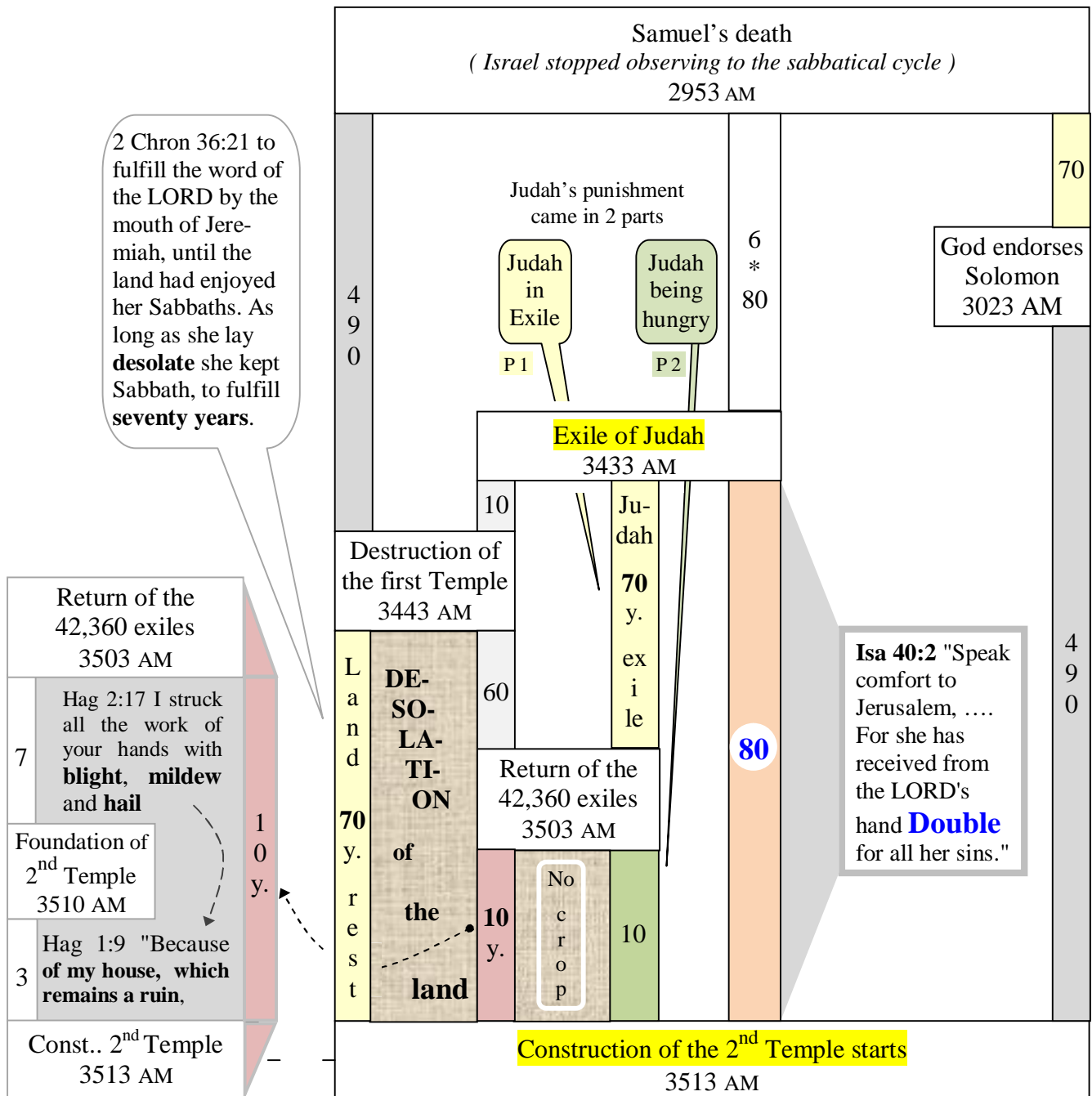

❖ About Israel's Exile and its disappearance

Much has been said about the fact that Israel (northern 10 tribes) was punished '7 times over' for its evil behaviour. It is doubtful anybody ever understood it correctly.

- Lev 26:18 If after all this you will not listen to me, I will punish you for your sins seven times over.

When Lev. 26:18 uses '7 times over' we should ask ourselves '7 times over' what? And the obvious answer that should come to mind is: '7 times over' the previous period of time during which ISRAEL HAD ALREADY been PUNISHED. We need to understand that the full punishment is given in two parts. There was to be a punishment during an initial period of time and, if it didn't work (they still didn't return to YHVH), then, the people would be punished again but this time **the** 'penalty time' would be increased 7 times over.

I am going to speculate that King Saul was rejected at the exact midpoint –**2943 AM**– of his 40-year reign (2923-2963 AM). This event had initiated a **380 year** period of punishment whose end (3323 AM) should have brought some forgiveness from God but instead was marked by the northern tribes going into exile. Did those Israelites from the northern tribes ever come back from their exile? If you are among those who believe, as I do, that these northern Israelites are still in exile, and that they should be distinguished from the 'exiles' of Judah who came back with Zerubbabel in 3503 AM (page 178), then, ask yourself the following question: **Why haven't they come back yet to reclaim their¹⁰⁹ land?** I suggest that God had prevented them to do so because they never repented during the initial '380-year' phase (2943 AM - 3323 AM) of the punishment (see Amos 4:6-12). They are now serving the second phase of that punishment and they won't be back until the whole '7 times over' had elapsed.

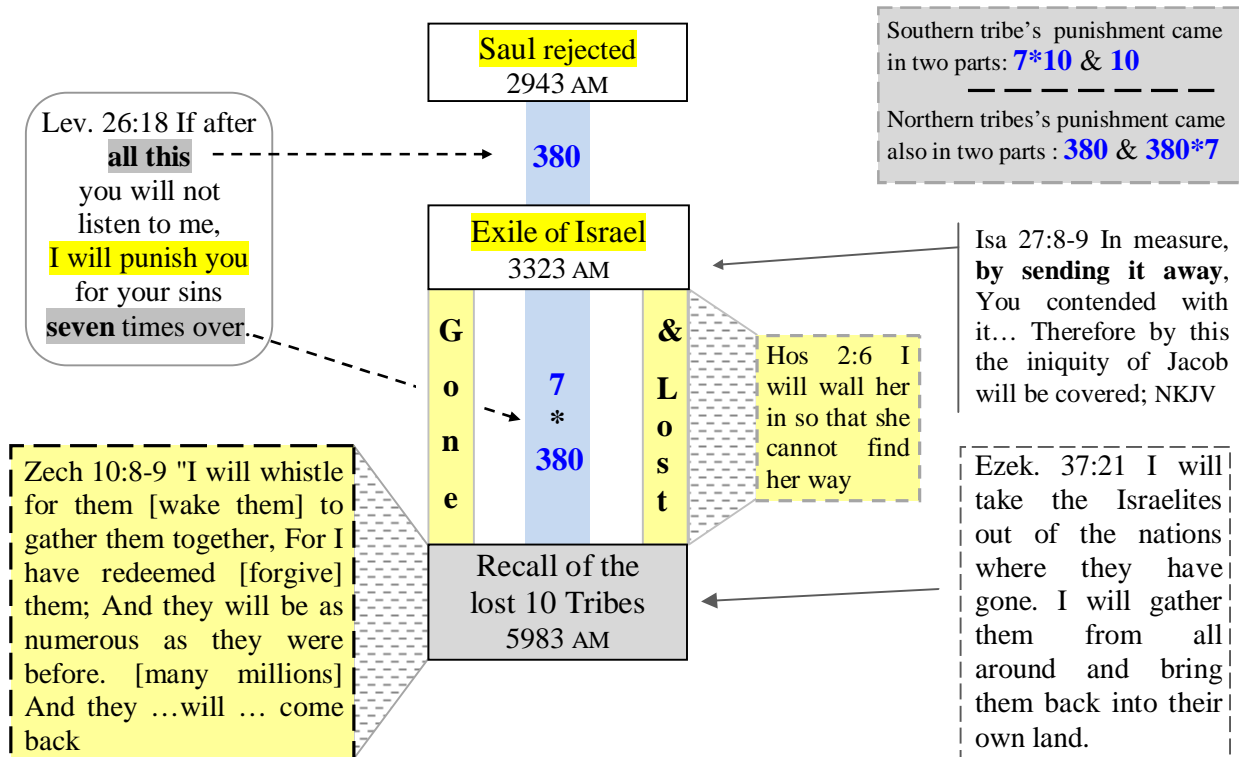

¹⁰⁹ Gen 17:8 Also I give to you [Abraham] and your descendants [**southern and northern tribes**] after you the land in which you are a stranger, all the land of Canaan, as an everlasting possession; and I will be their God."

By postulating that Saul was rejected in 2943 AM we come across many patterns.

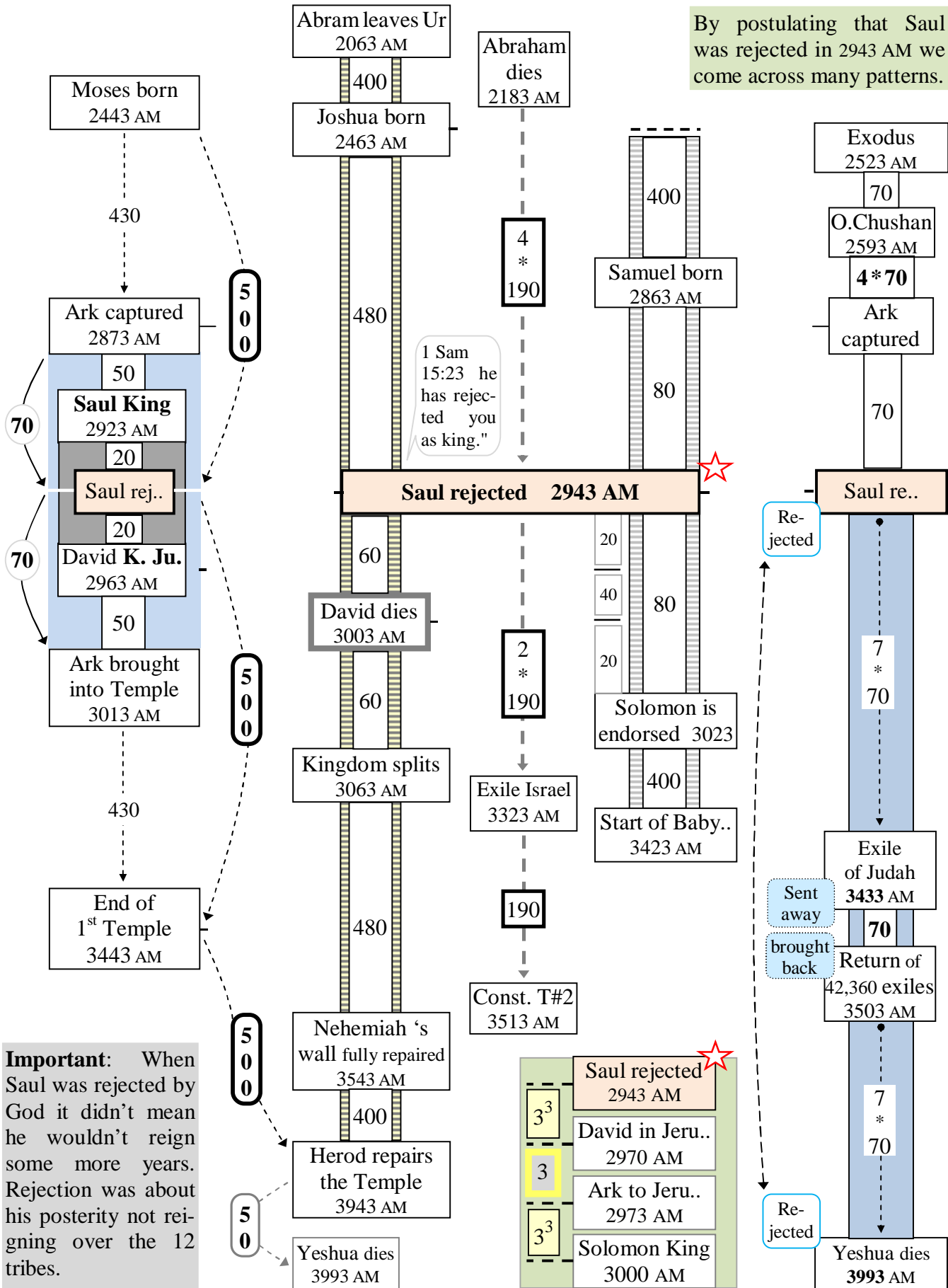

Important: When Saul was rejected by God it didn't mean he wouldn't reign some more years. Rejection was about his posterity not reigning over the 12 tribes.

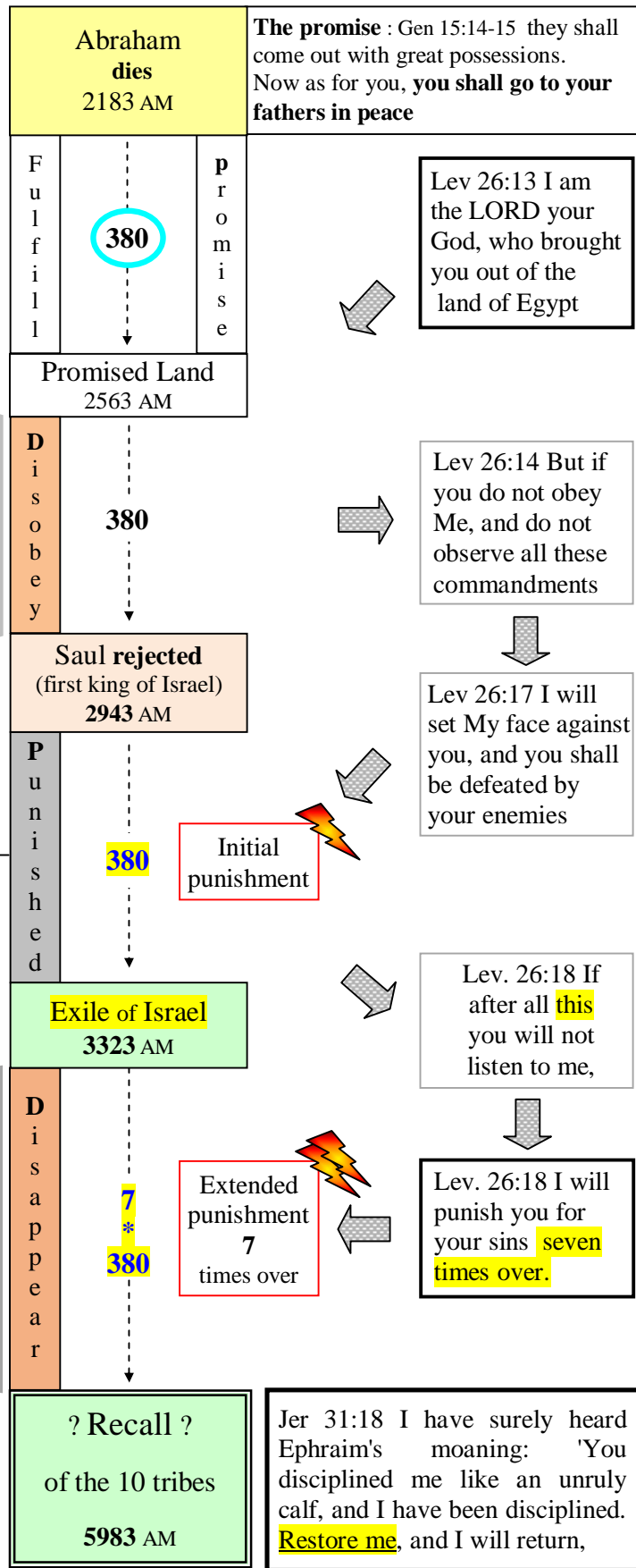

Ps 78:56-58 But they put God to the test and rebelled against the Most High; they did not keep his statutes. Like their fathers they were disloyal and faithless

7 oppressions
Cushan, Eglon, Jabin, Median, Abimelech., Ammon, Philistines.
and no matter what, they still rejected God

And the northern kingdom became lost (10 tribes), **they even forgot their own identity**

Hos 7:13 I long to redeem them but they speak lies against me.

Hos 12:14 But Ephraim has bitterly provoked him to anger; ... and [the Lord] will repay him for his contempt

And God rejected them

Hos 1:10 'You are not my people,'

Hos 6:2 After two days he will revive us; on the third day he will restore us.

if day = 1000 years, on the 3rd day could be after **2660 years**

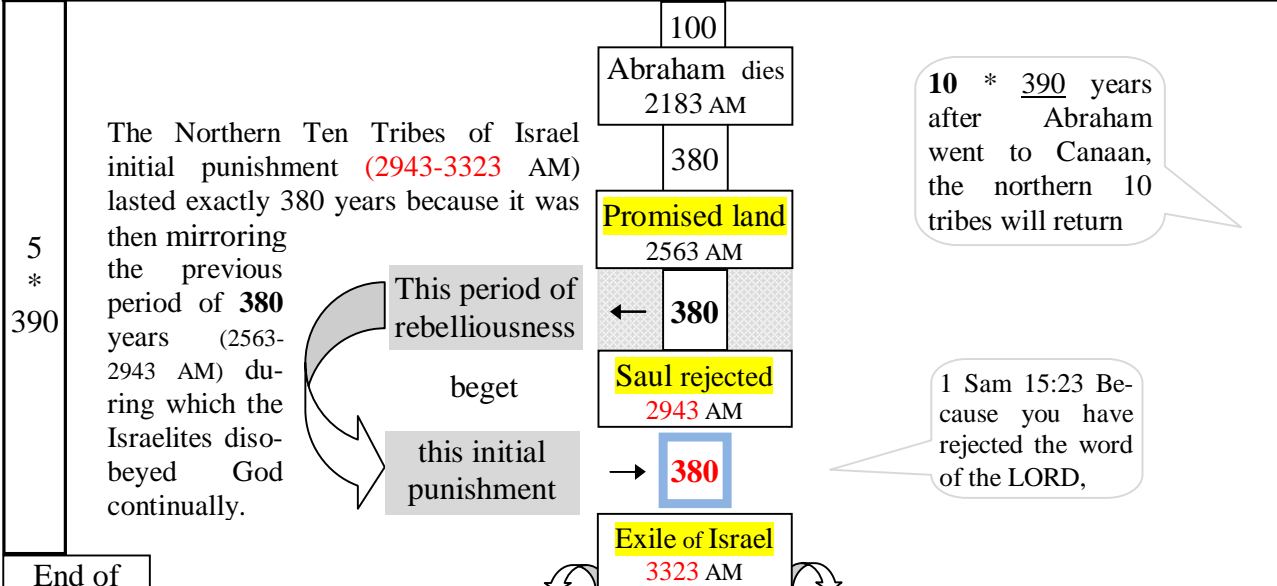

End of 2nd Temple 4033

Can we reasonably believe that the northern exiles will ever be back?

The people of the northern kingdom of Israel were carried away by Assyrians. The people of the southern kingdom of Judah were carried away by Babylonians.

God promised that He would gather His people

Paid special attention to Jeremiah: 23:3 I myself will gather the remnant of my flock out of all the countries where I have driven them. 23:4 **'none would be missing'**.

We know that the tribes of Judah & Benjamin came back from Babylon after their 70-year exile (see p 182).

But the Northern 10 tribes never came back from the Assyrians' captivity. It is even believed that in due course they were scattered into many nations.

Nevertheless God said **'none would be missing'**

N.B. This 'exile' will end only when the people will collectively 'and miraculously' learn who they really are.

Rom 11:25 that **blindness in part is happened to Israel, until the fullness of the Gentiles be come in.**

Where are the wandering children (Lost tribes) of the northern 10 tribes today?

While there is no definite consensus some researchers point to England, USA, Canada, France, Netherlands, Scandinavia, Finland, Ireland, Switzerland, Belgium, Australia, New Zealand. (Of course not all the people of these countries would be descendants of Israelites.).

The Hebrew word 'Brit-Am' means "Covenant of the people" (Isa 42:6). Is it why the British got the name Great-Britain? Notice that they also call themselves **Anglo-Saxons**. Are the 'Saxons' from 'Isaac's sons'?

Are names like Denmark, London, Danube, Dardanelles, Edinburgh, the Don's river in Scotland and so many others, a testimony for the tribe of Dan as it was leaving his trail across Europe?

Gen 49:17 Dan will be a serpent by the roadside



For more on the subject:
-Judah's Sceptre and Joseph's birthright by J. H. Allen.
-Yair Davidy's research

5 * 390

7 * 380

10 * 390

The repetitive usage of the number '38' between the 'Covenant of Circumcision' and the 'Recall of the Lost Tribes' is a powerful argument that add credibility to the following chronological structure.

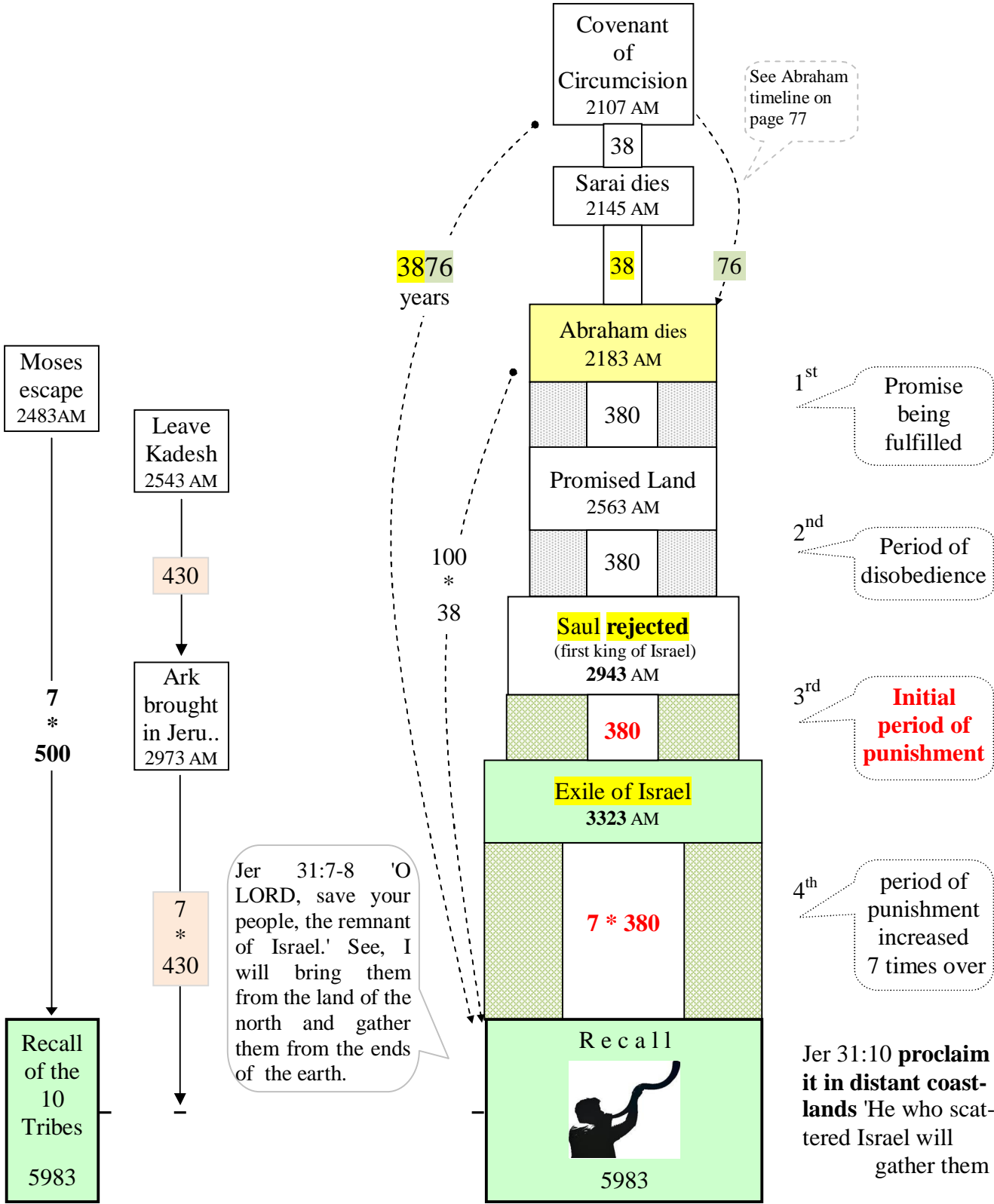

A very attractive supposition
 Part 1: When did Abraham go to Egypt?

Abraham left Haran to go in Canaan in 2083 AM and he ratified the Covenant of the parts in 2093 AM. Sometime between 2083 AM and 2093 AM Abraham went to Egypt for a while.

- Gen 12:10 Now there was a famine in the land, and Abram went down to Egypt to live there for a while

Suppose Abraham went to Egypt in **2088 AM**
 (the following patterns are very meaningful)

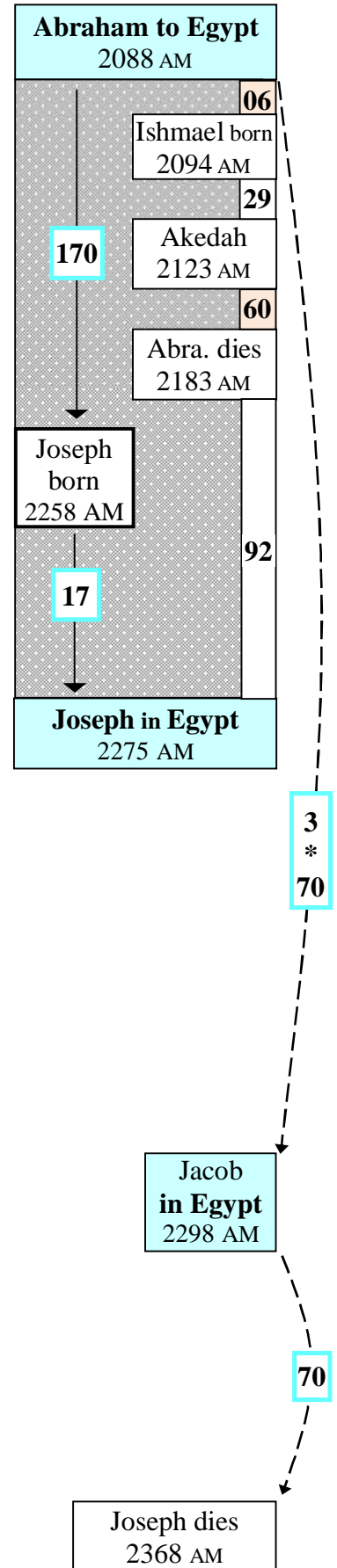
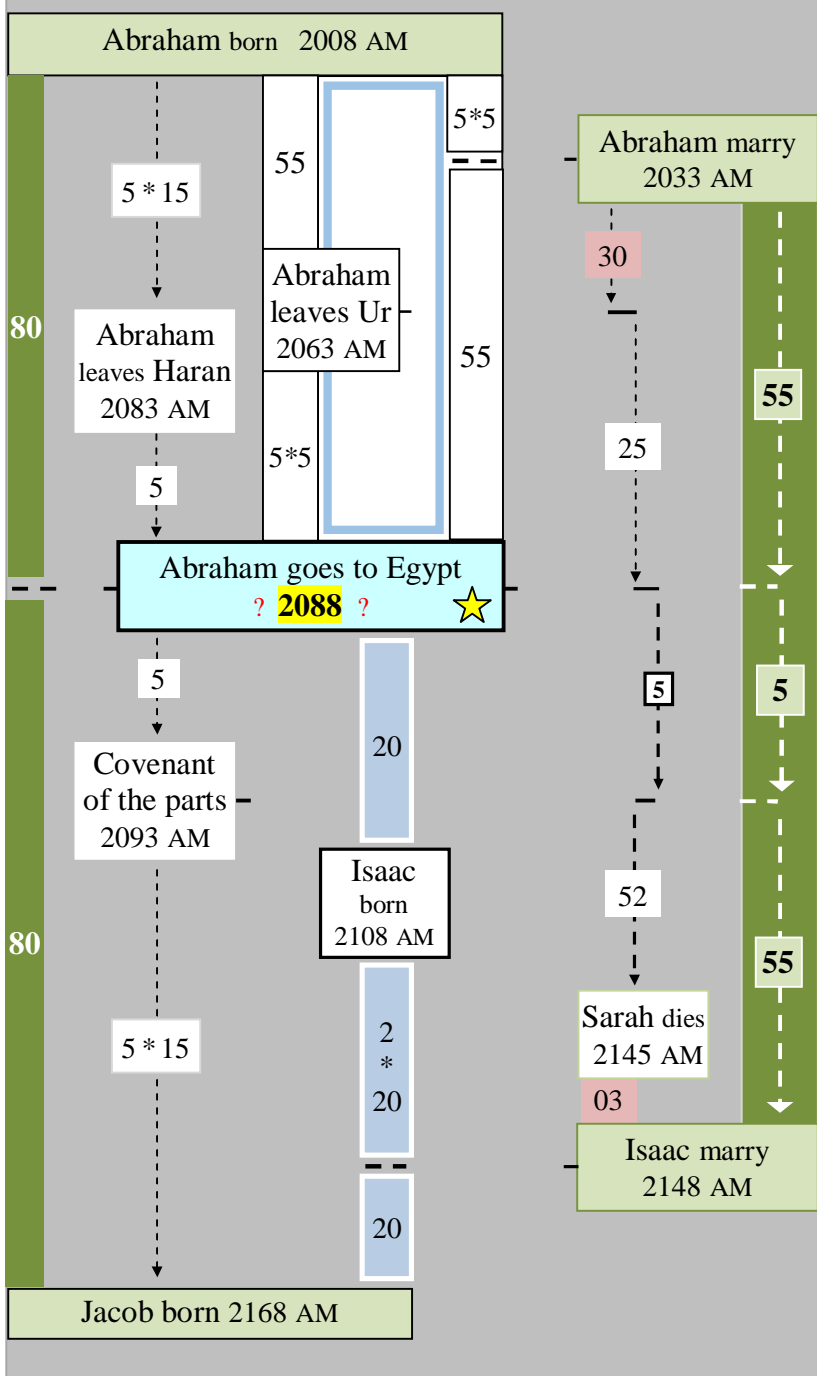

If, as suggested, Abraham really went to Egypt in **2088 AM**, then one can say that the Israelites will symbolically come out of it 3895 years later (2088-5983).

Notice how you can reverse **3895** and obtain **5983**, the year of this recall.

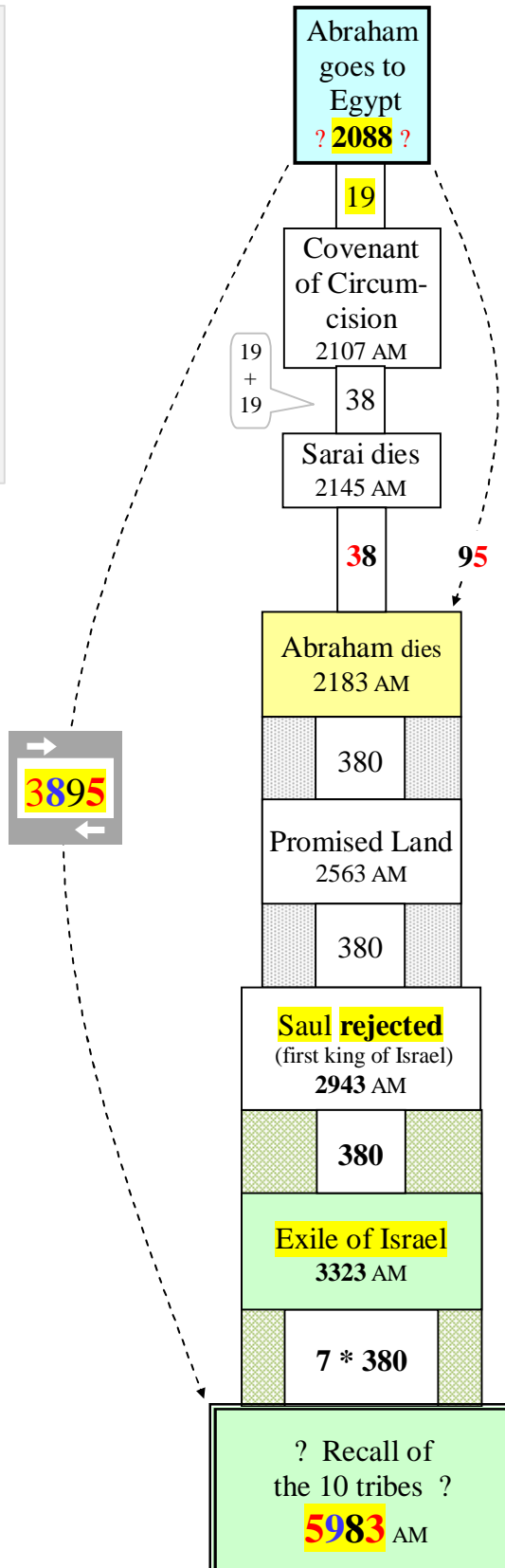

A very attractive supposition

Part 2: Figuring out Babel's timing

To the previous sequence of events associated with the Sin of Israel, let's graft a **second 95 years** segment by postulating that the scattering at Babel took place in 1993 AM.

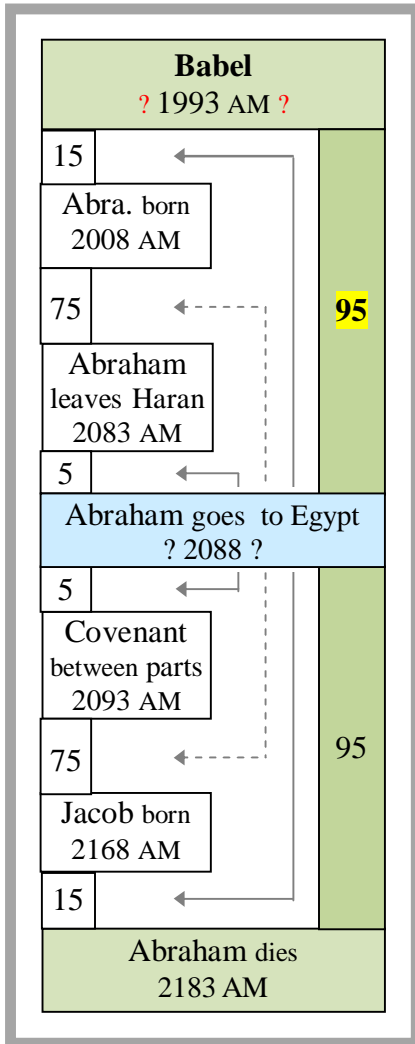

On the right side there are 7 events separated in time by either 380 years, one of its multiples (7*380) or one of its divisors (95). Notice that the sequence starts when God sent the people **all over the earth** (at Babel) and ends when He will recall the 10 tribes of Israel to bring them back from their **all over the earth** exile.

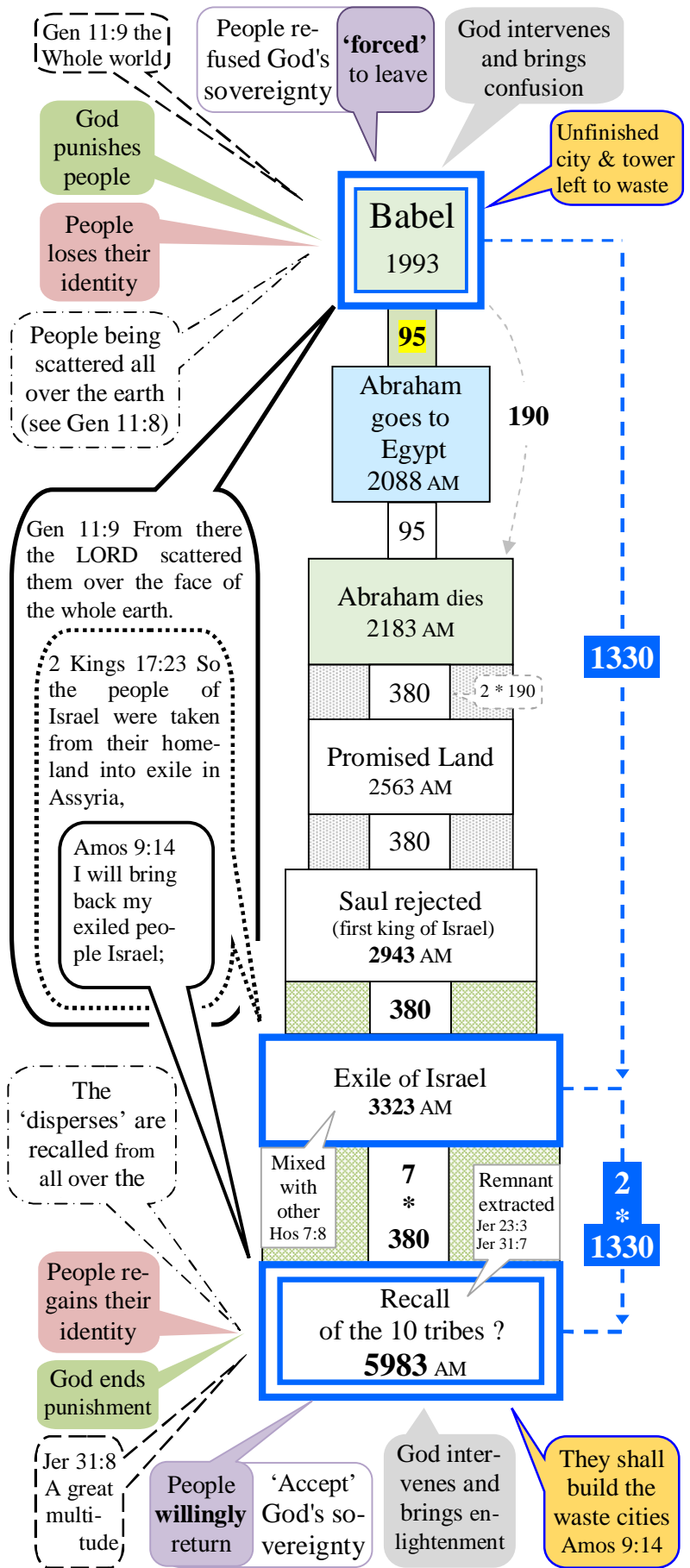

➔ From Babel to Daniel's 70th week

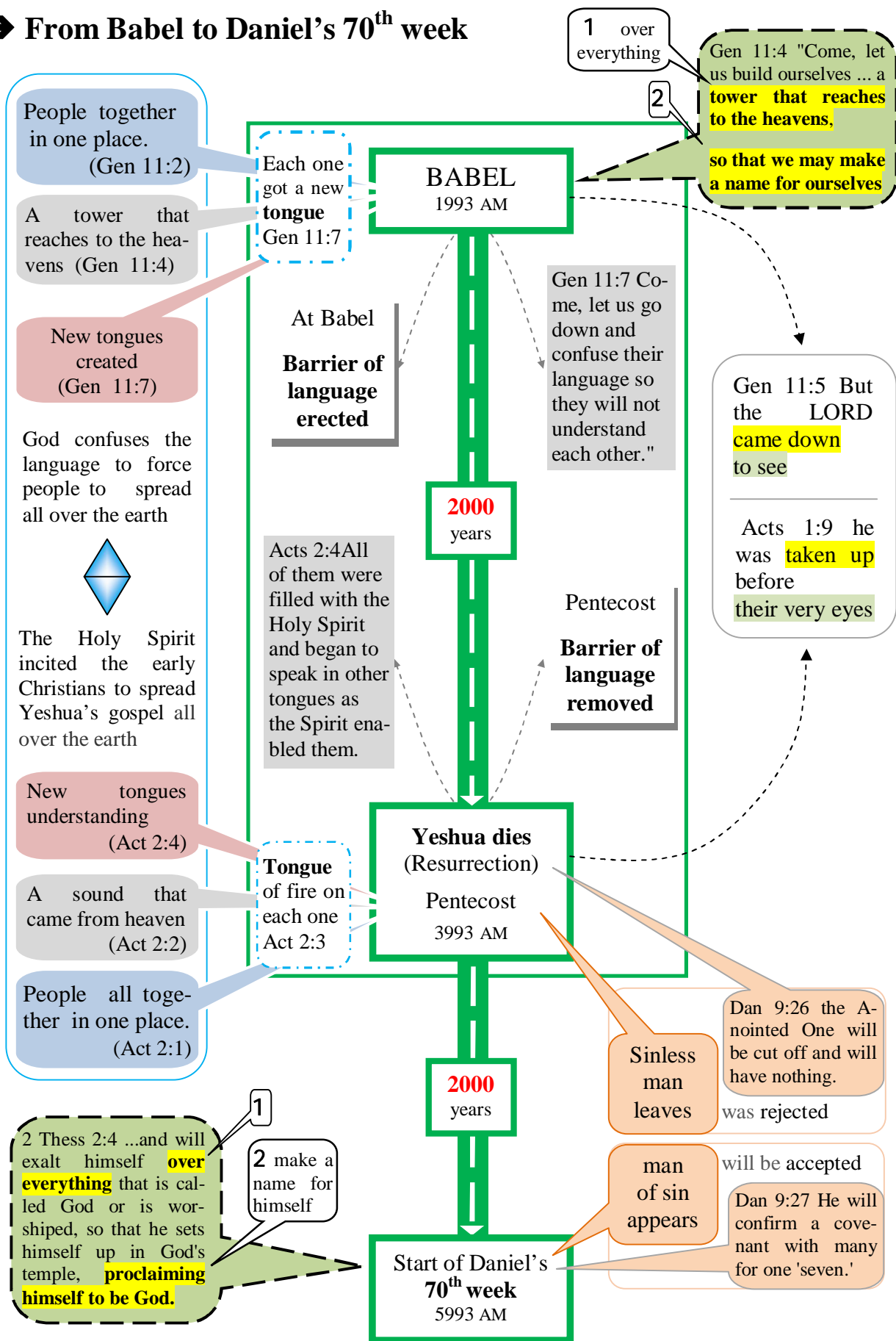

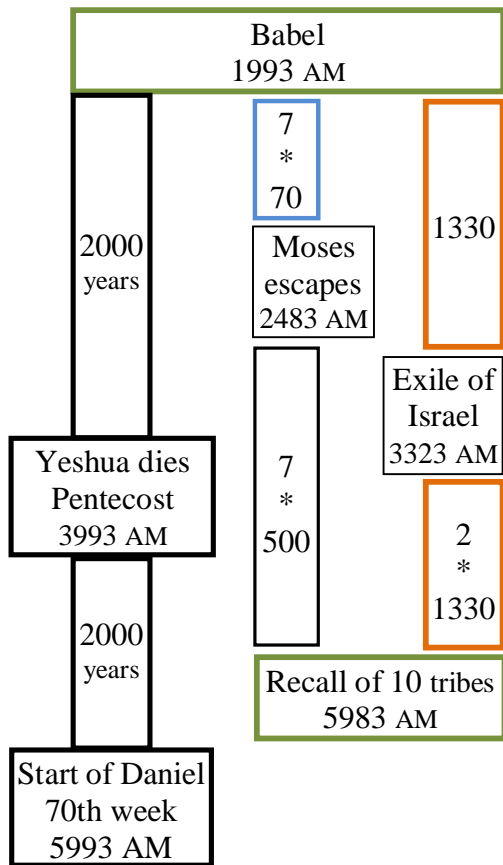

Here is some information kindly supplied by my very knowledgeable friend Noel Rude on the connection between Babel, the exile of Israel, and Pentecost

The rabbis noticed a play on words (with the Hebrew בָּלַל *bālal*) connecting the confusion at Babel with the mingling of Ephraim (and his fellows) with the nations.

✓ Genesis 11:9 Therefore is the name of it called Babel; because the LORD did there confound [בלל/συνέχεεν] the language of all the earth: and from thence did the LORD scatter them abroad upon the face of all the earth.

✓ Hosea 7:8 Ephraim, he hath mixed himself [יִתְבּוֹלֵל] among the people; Ephraim is a cake not turned.

The miracle of Pentecost (3993 AM) **exactly 2000 years** later is linked by verb (συνέχεεν) from the Septuagint:

✓ Acts 2:6 Now when this was noised abroad, the multitude came together, and were confounded [συνεχύθη], because that every man heard them speak in his own language.

Noel Rude also drew to my attention 1Kings 11:31 which connects ten men (ten tribes?) and “all the languages of the nations”:

✓ Zechariah 8:23 Thus saith the LORD of hosts; In those days *it shall come to pass*, that ten men shall take hold out of all languages of the nations, even shall take hold of the skirt of him that is a Jew, saying, We will go with you: for we have heard *that God is with you*.

This latter connection could well mean that the Lost Sheep of Israel, (ten tribes from ten men) after mingling among the nations for more than two thousand years, will come out of them with the knowledge of every language of the world. This would be a remarkable denouement, even if it was only meant to be taken at a symbolic level, of a drama that happened well before Israel was even born. At Babel, God gave to men the seed of every language and send them away from him to discover the world. At the ‘recall’, those of the ten tribes, no matter what language they will individually understand, will hear God’s call and will come back to renew the close relationship that men could have had from the very beginning.

BABEL

People wanted to make a name for themselves. God confused their language. And God scattered them over the world.

This ended up in an exile involving the whole world.



RECALL of the Northern Ten Tribes

The Lost tribes have become many nations speaking many languages. God will remove the confusion about their identity. And God will gather them from all around. Eze 37:21

The whole world will witness the lost tribes being recall from exile.

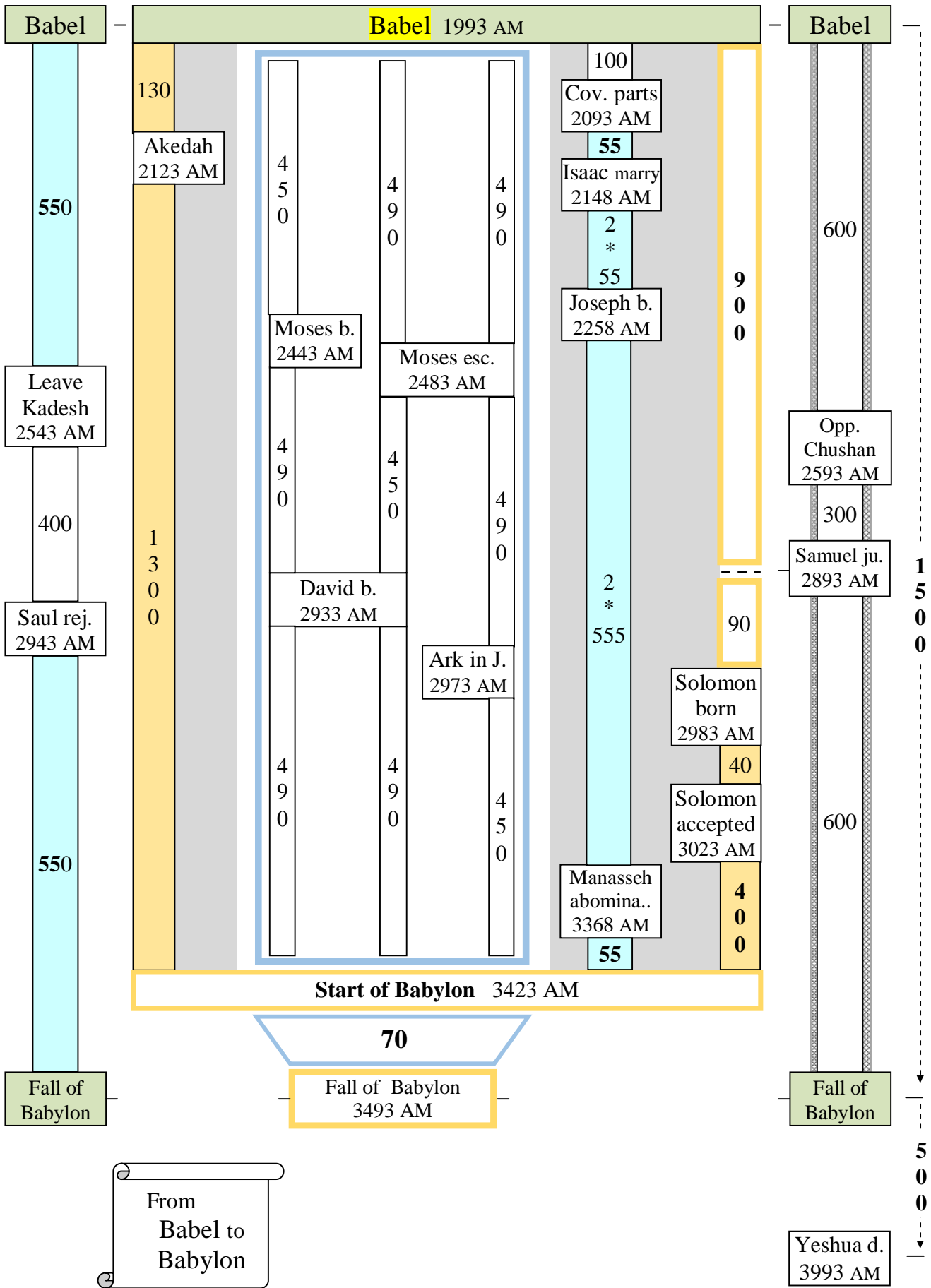

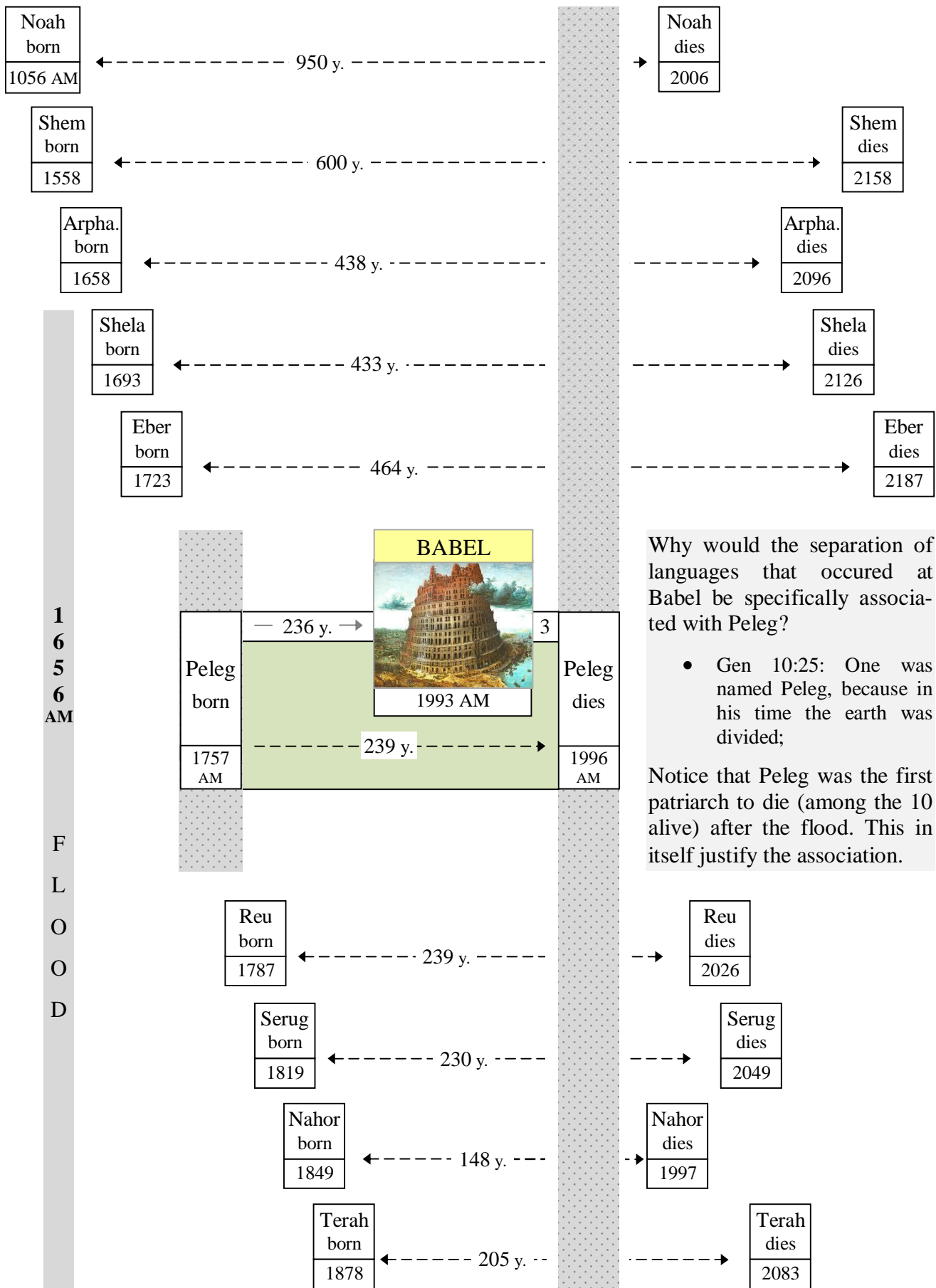

Why would the separation of languages that occurred at Babel be specifically associated with Peleg?

- Gen 10:25: One was named Peleg, because in his time the earth was divided;

Notice that Peleg was the first patriarch to die (among the 10 alive) after the flood. This in itself justifies the association.

→ What is the timeline of Samson?

Cov. between parts
2093 AM

The following chart shows how Samson whole life was encapsulated in the period of the Philistines Oppression.

Judg 13:5 ... set apart to God from birth, and he will begin the deliverance of Israel from the hands of the Philistines. NIV

| | |
|--|---------|
| Start of Phil. opp.. to Samson dies | = 37 y. |
| Samson born to Phil opp. end | = 37 y. |

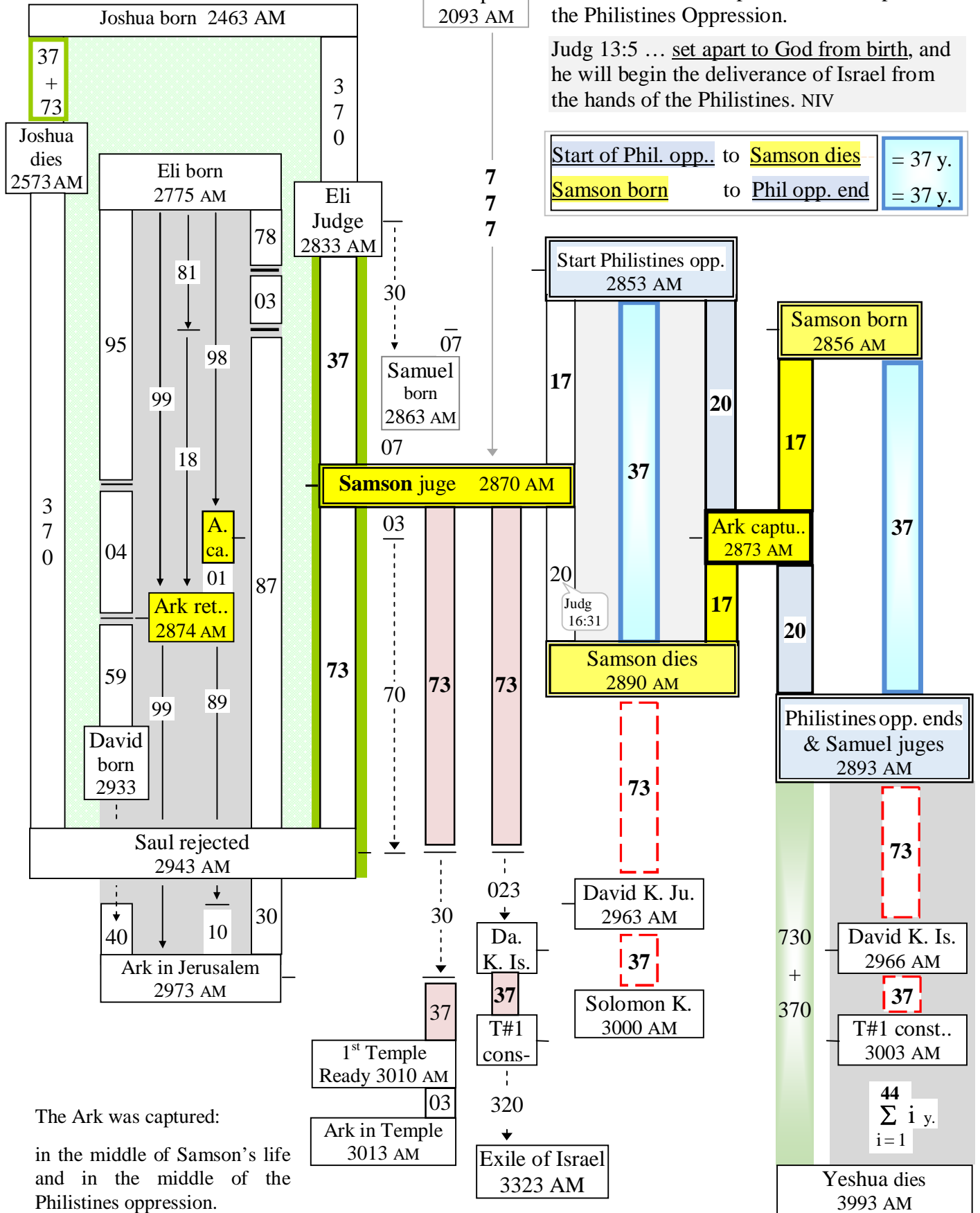

The Ark was captured:

in the middle of Samson's life and in the middle of the Philistines oppression.

Notices how
Samson's birth
 is indirectly related to
David king of Israel
 with a sequence of palindromic numbers 34-03-30-43

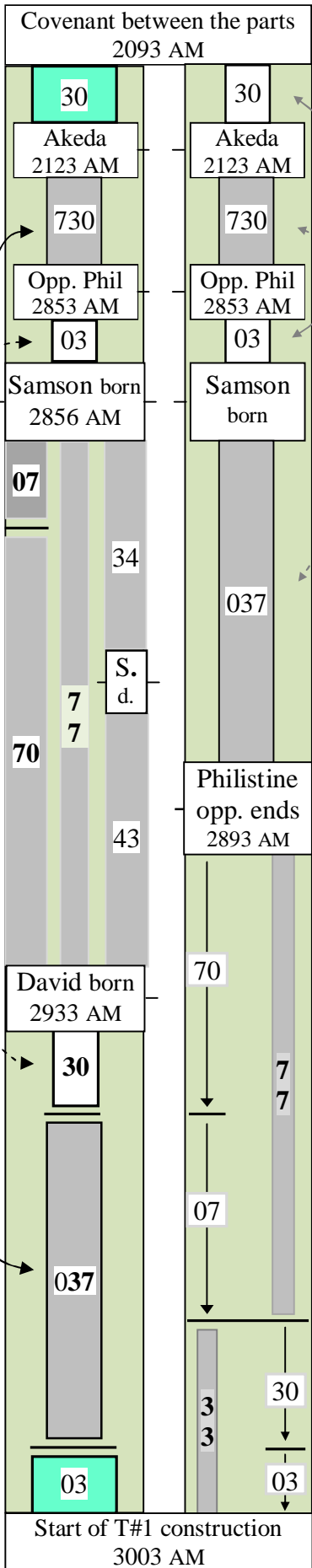
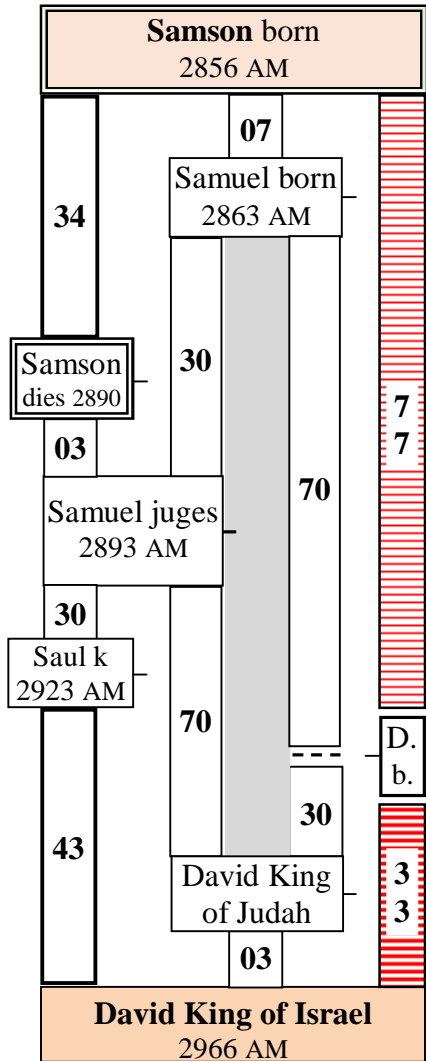

and notices how
Samson's death ★
 is indirectly related to
Solomon king of Israel
 with the same but re-versed sequence of palindromic numbers
 43-30-03-34

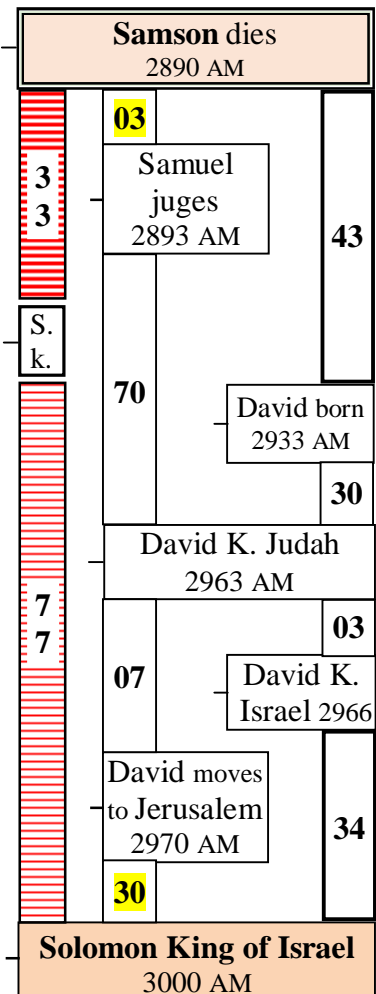

→ Was Solomon 17 years old when he became king? Yes.

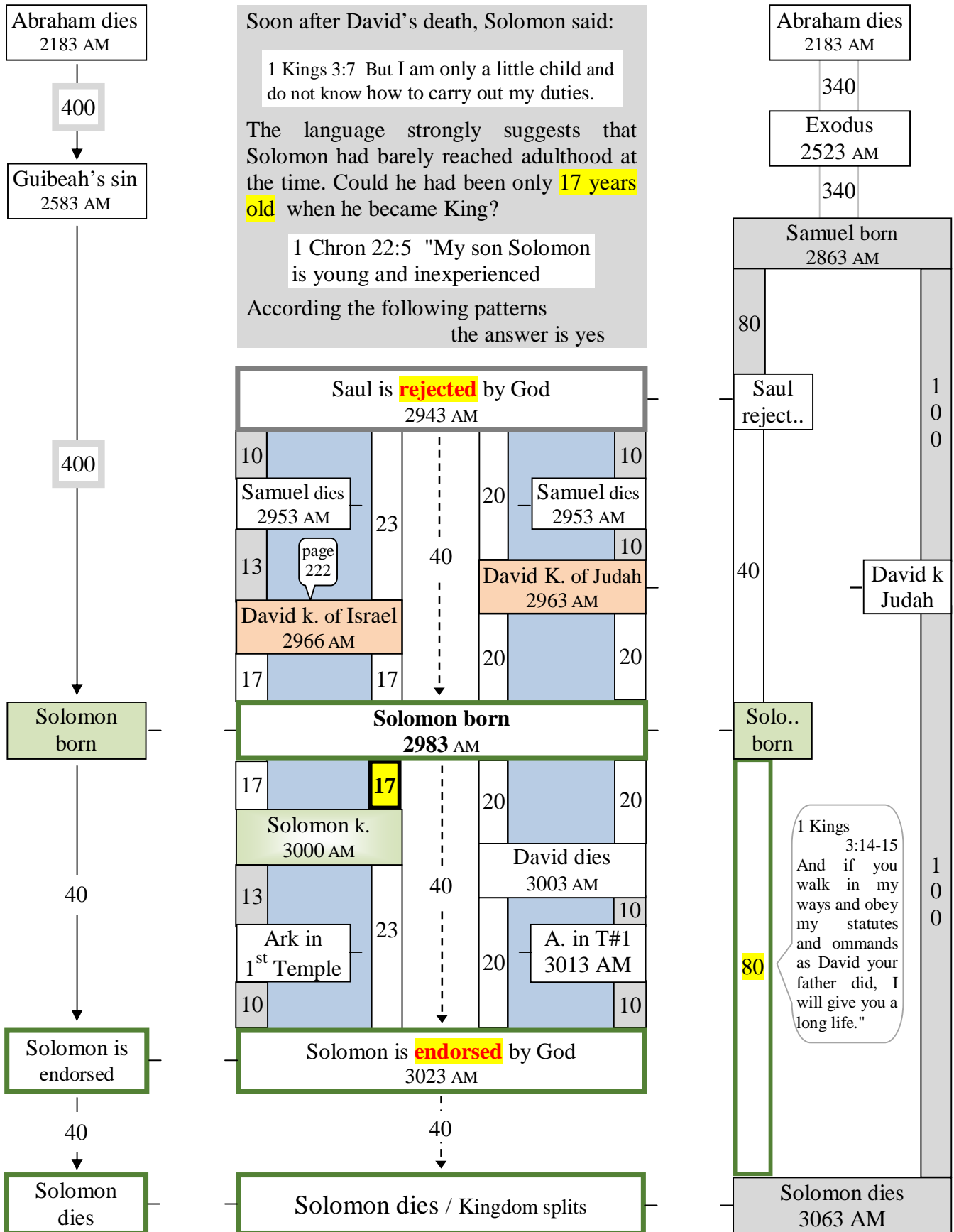

The Bible timeline unsealed in 28 charts

The following set of charts will highlight the extreme variety of patterns obtained when the chronology of the biblical events is rightly under-

stood. It will become quite obvious after seeing the first few charts that most of the events are not restricted to the



design of a single pattern but are often part of an elaborate network of them.

No human architect could have conceived a system with such complexity while integrating more than one hundreds events whose occurrence spanned a period of six thousand years.

The open mind christians will need to assess what make more sense:

All the following wonderfull patterns either originated from 'hasard' and inexplicable coincidences or they are the miraculous fruits of a Divine Creator.

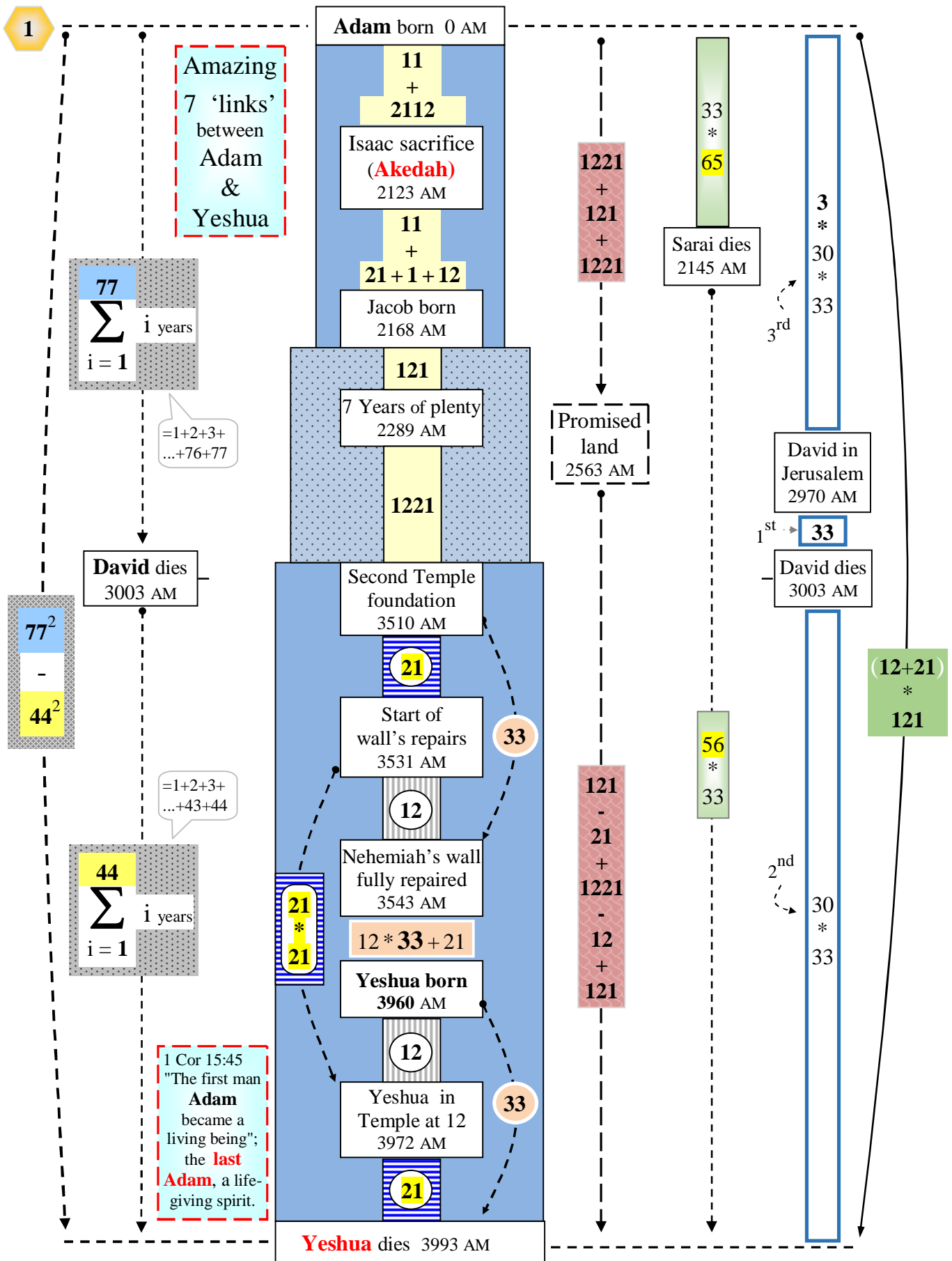

2

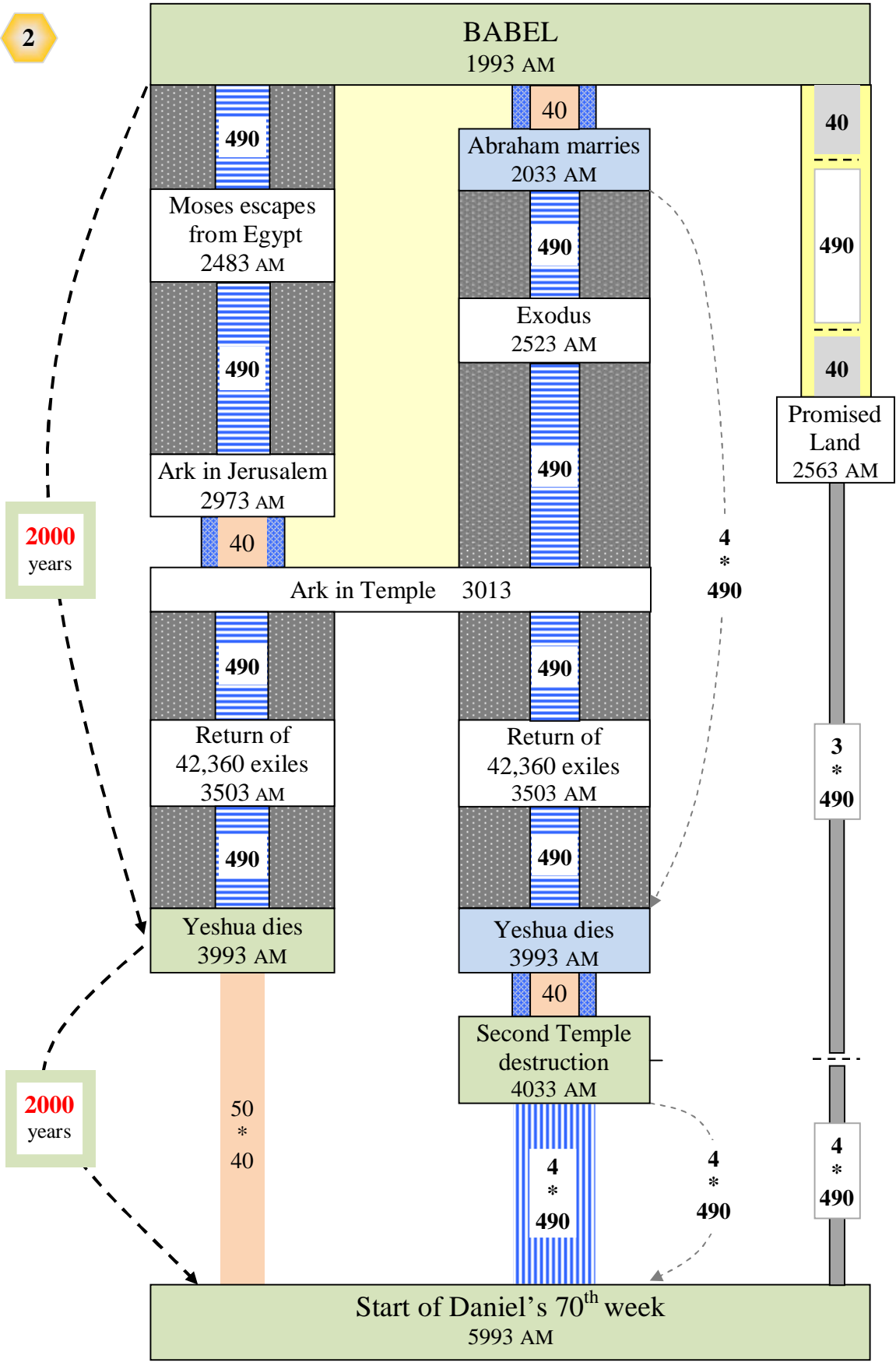

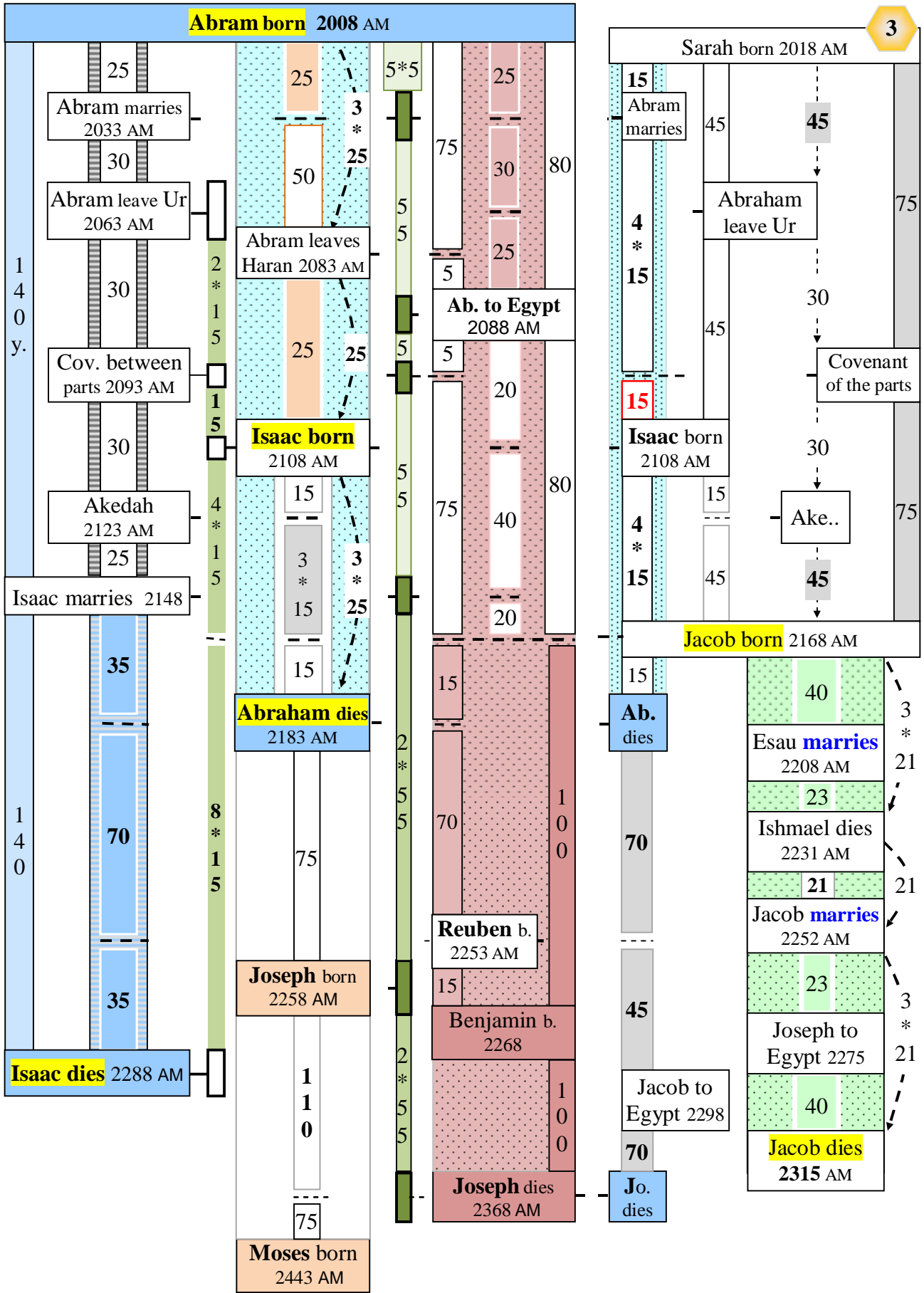

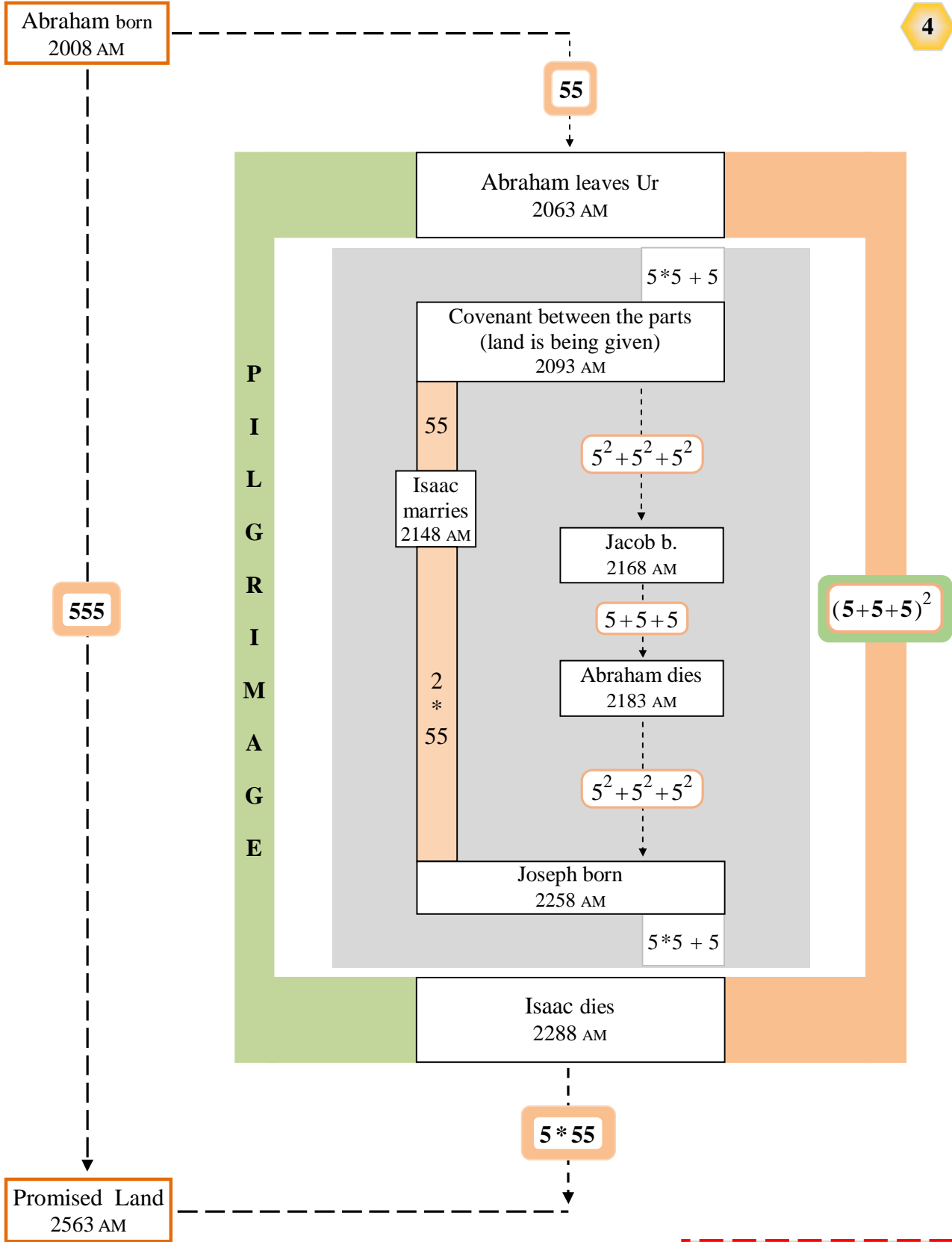

- Amazing -
Here is a very unique
and surprising pattern.

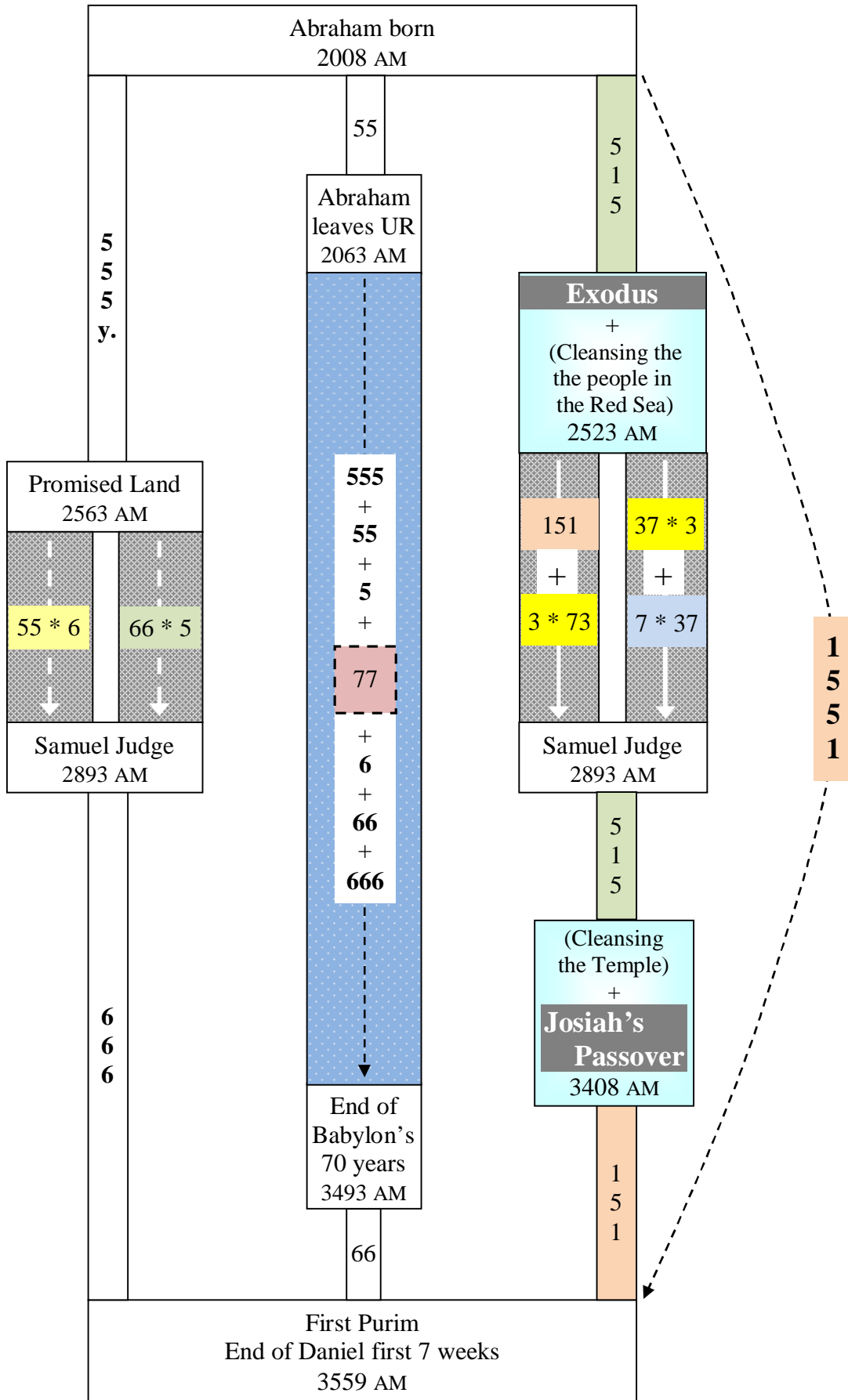

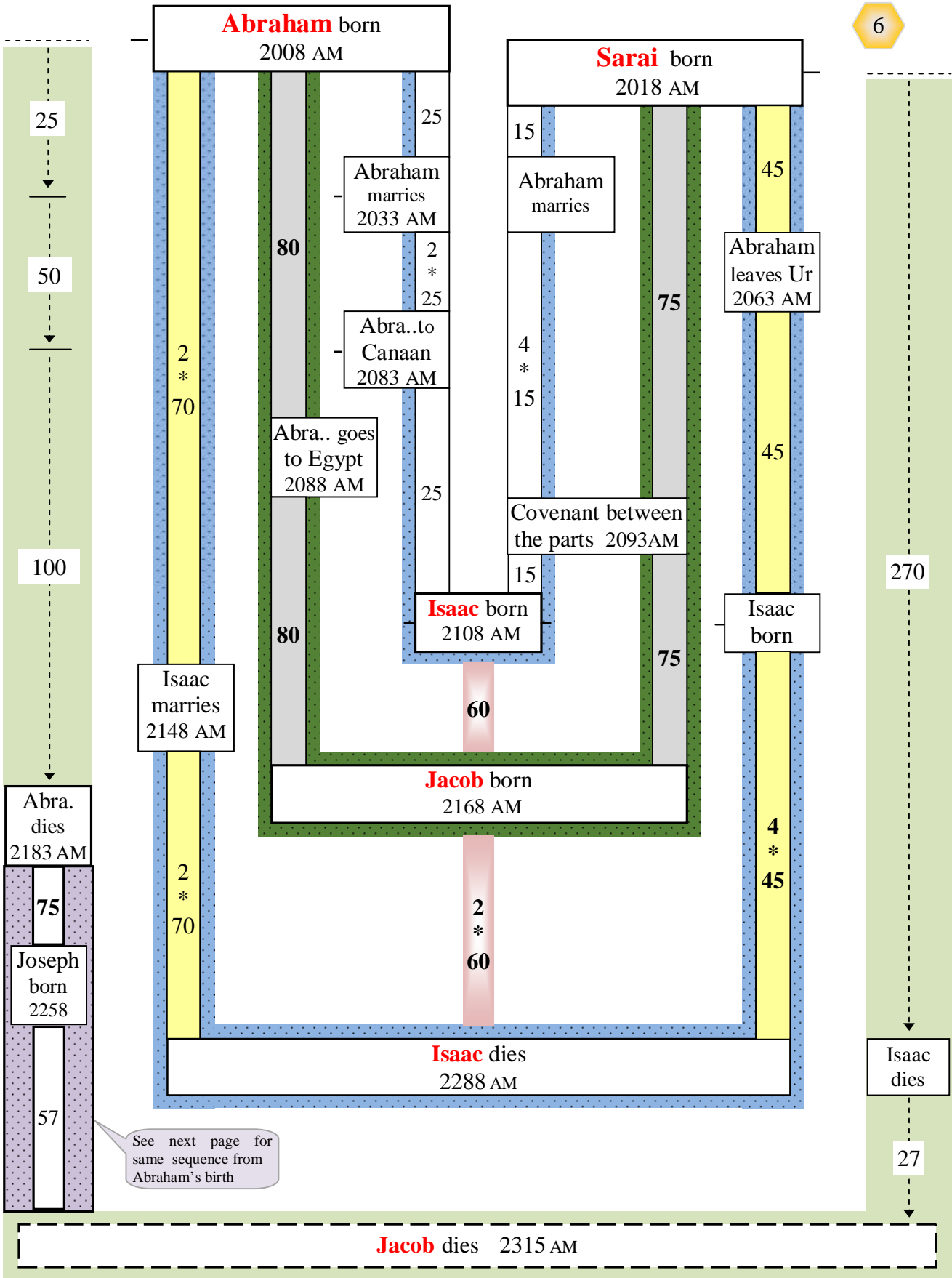

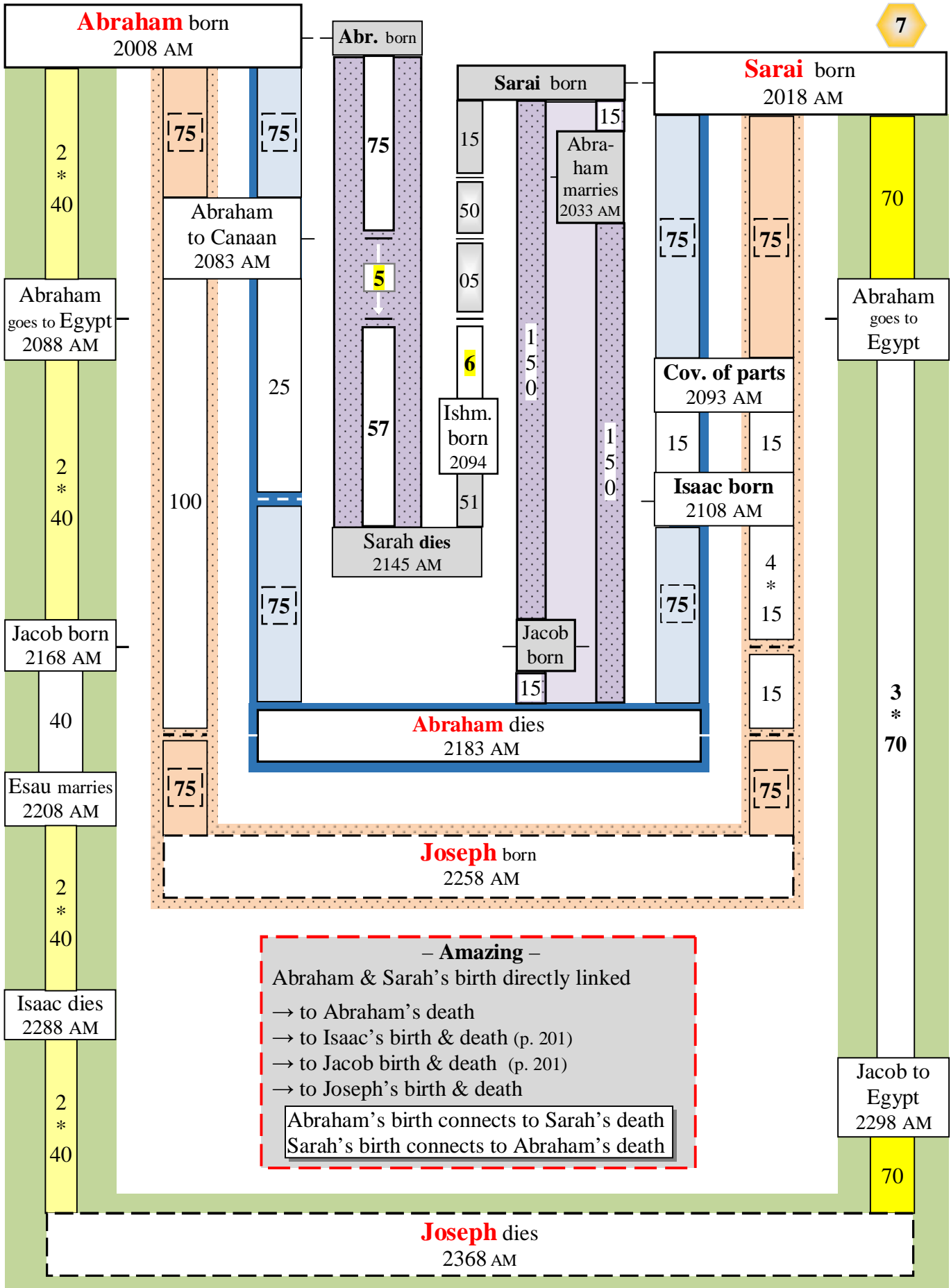

| | | | | | |
|----------------------|-----------------------|---------|---------|----------|----------------------|
| Abram born | Abraham's life | | | | Abram dies |
| * | A m 25 | I.b 100 | I.m 140 | Ja.b 160 | 175 |

8

| | | | | |
|-----------------------|----------------------|--------|--------|-----------------------|
| Joseph born | Joseph's life | | | Joseph dies |
| * | B.b 10 | I.d 30 | J.d 57 | 110 |

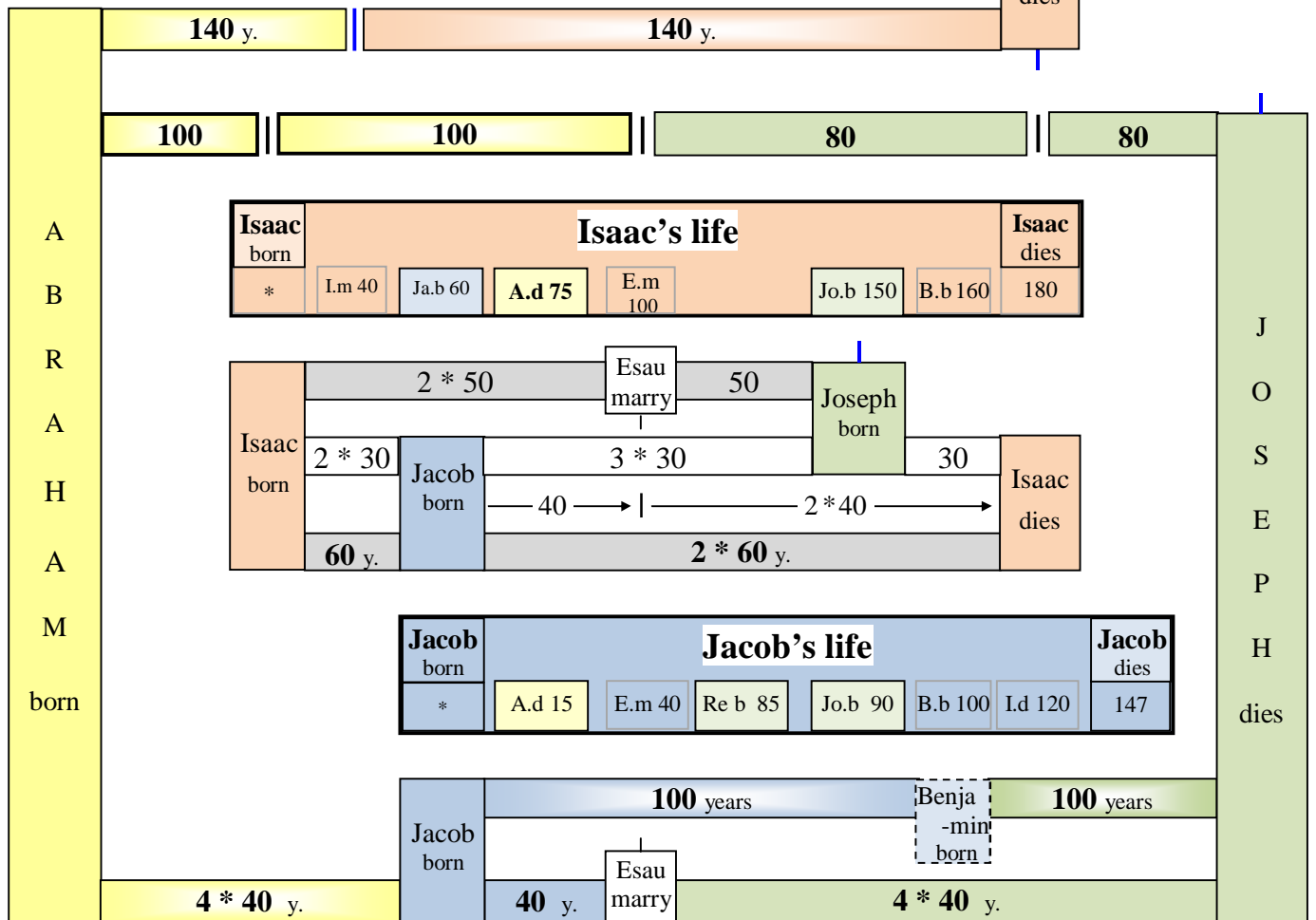
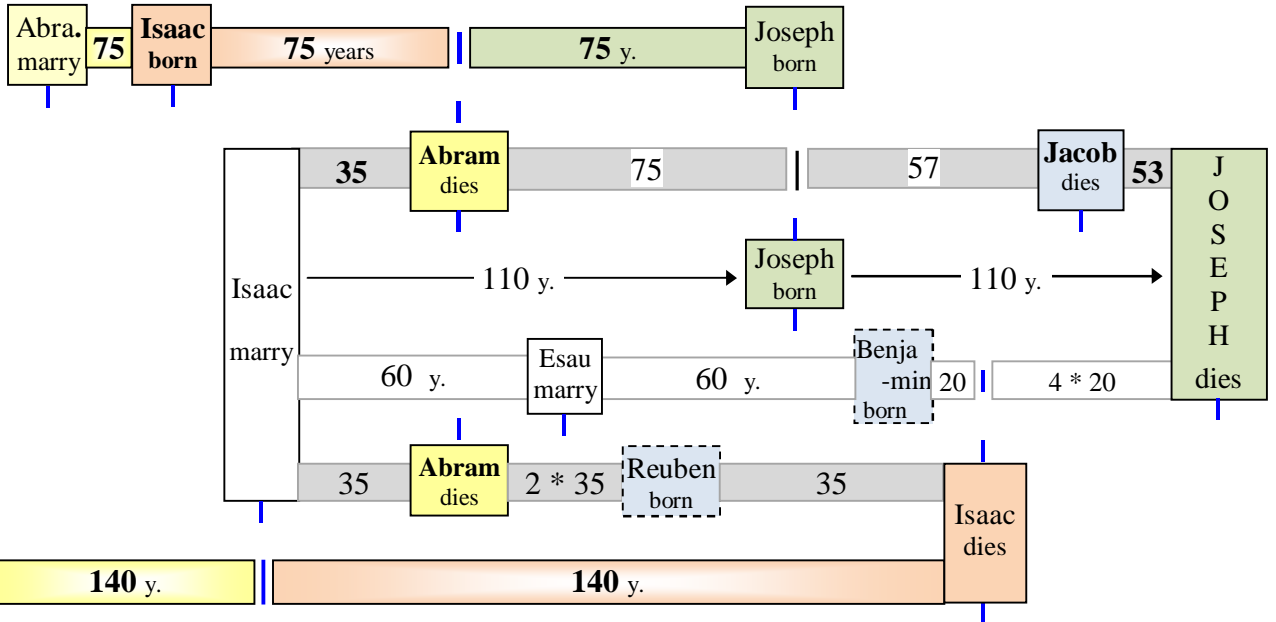

| | | | | | | | | | | | | |
|---------|------|------|------|------|------|------|------|------|------|------|------|------|
| 2008 AM | 2033 | 2108 | 2148 | 2168 | 2183 | 2208 | 2253 | 2258 | 2268 | 2288 | 2315 | 2368 |
|---------|------|------|------|------|------|------|------|------|------|------|------|------|

Abram marries

2033 AM

9

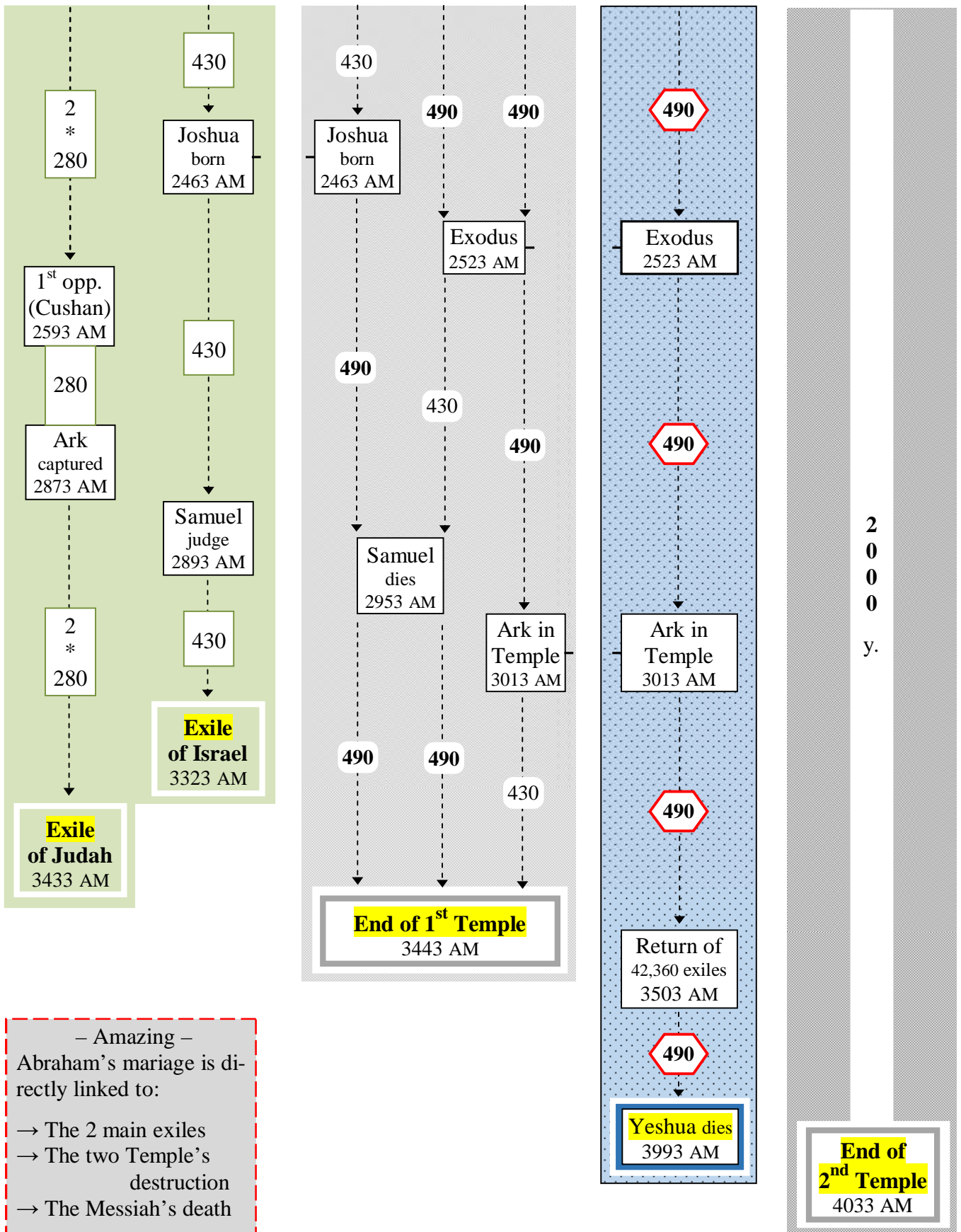

- Amazing -
Abraham's marriage is directly linked to:

- The 2 main exiles
- The two Temple's destruction
- The Messiah's death

10

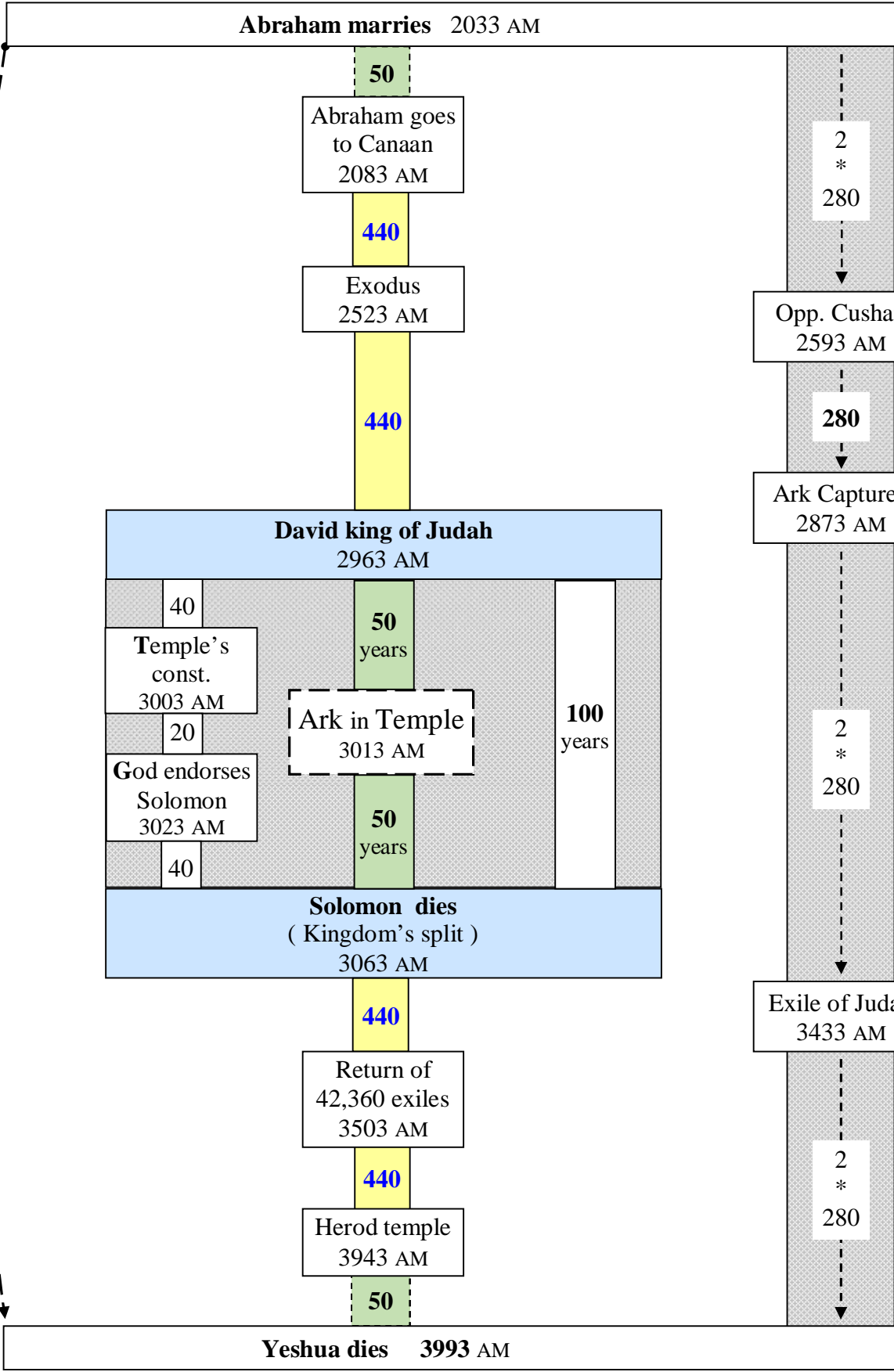

7 * 280

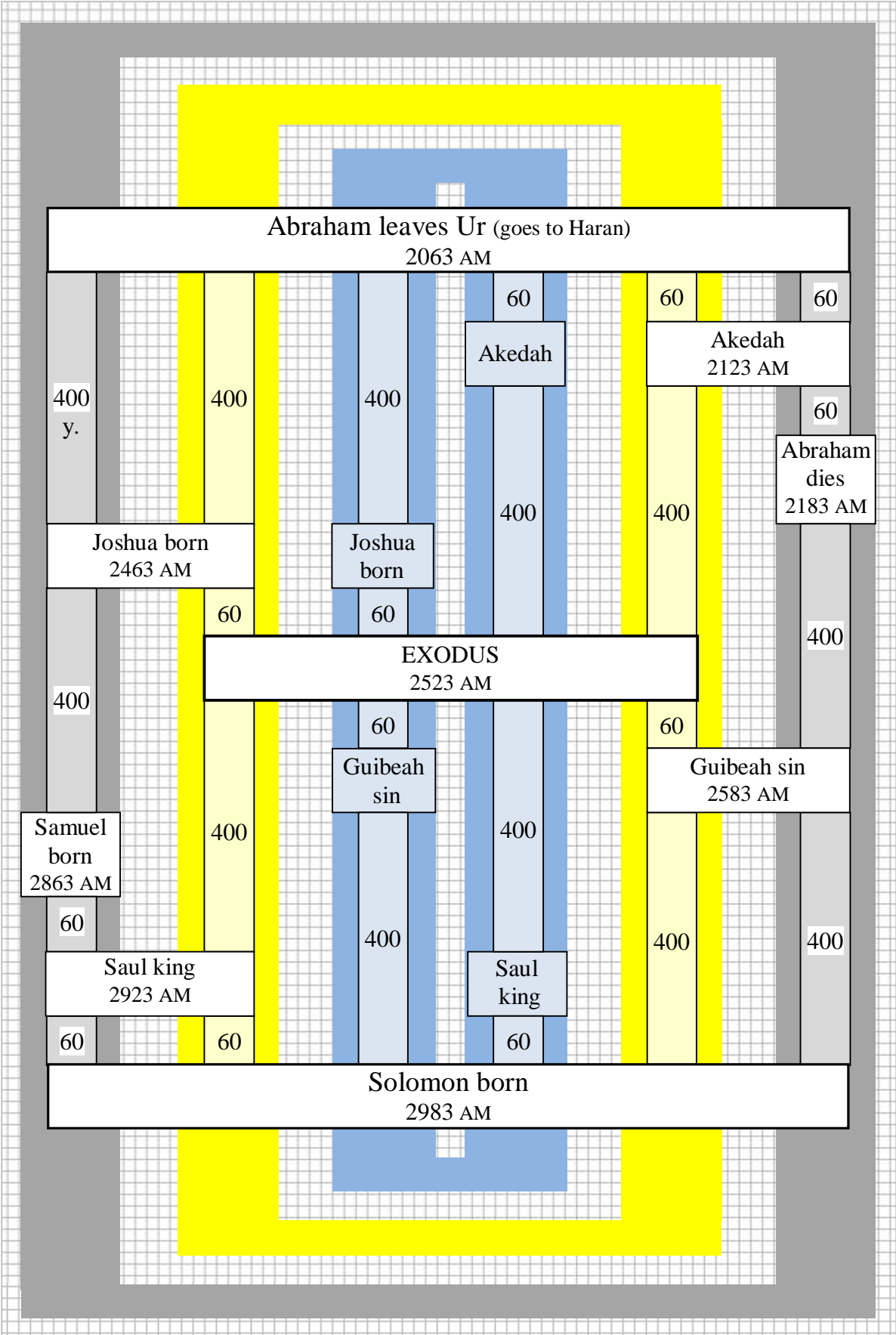

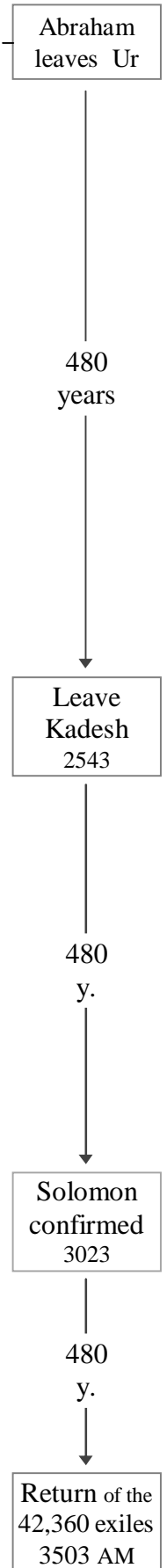
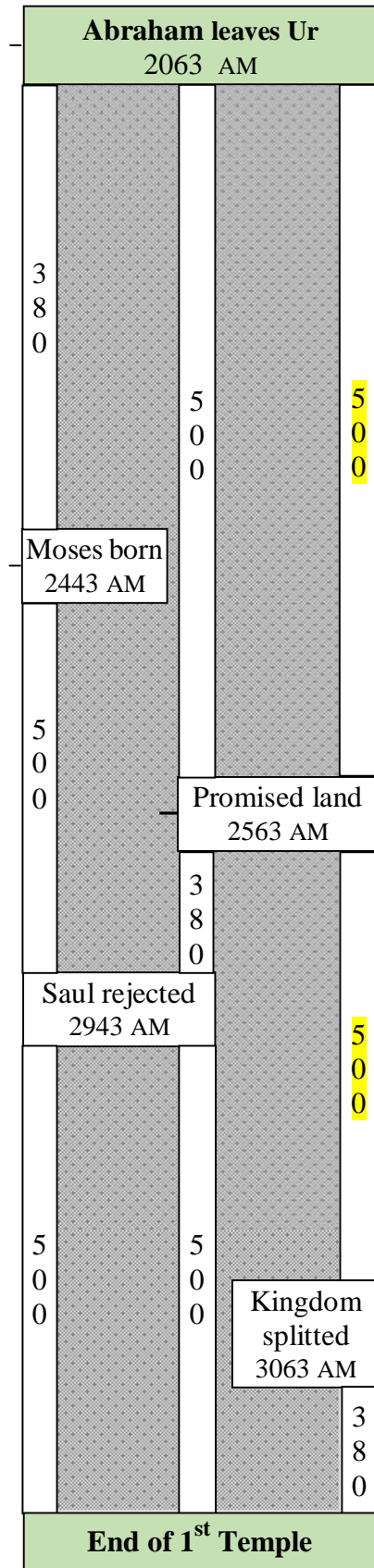
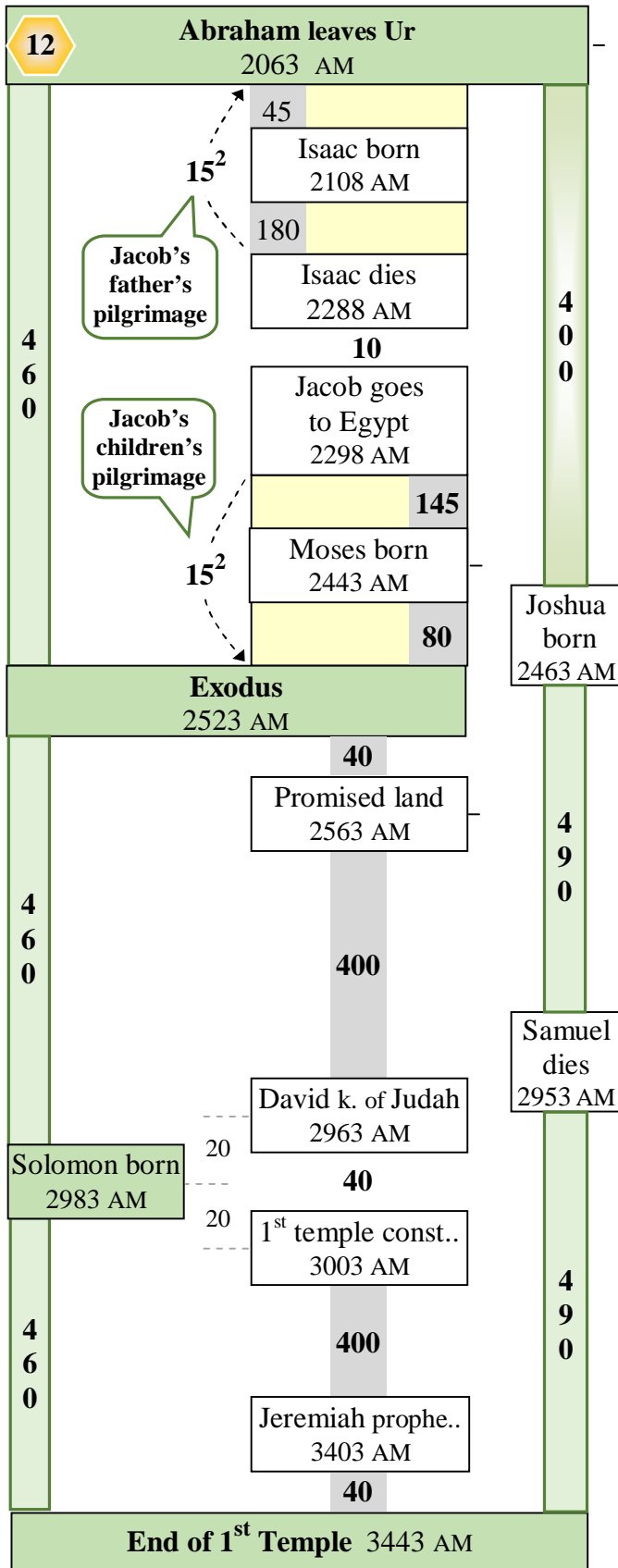

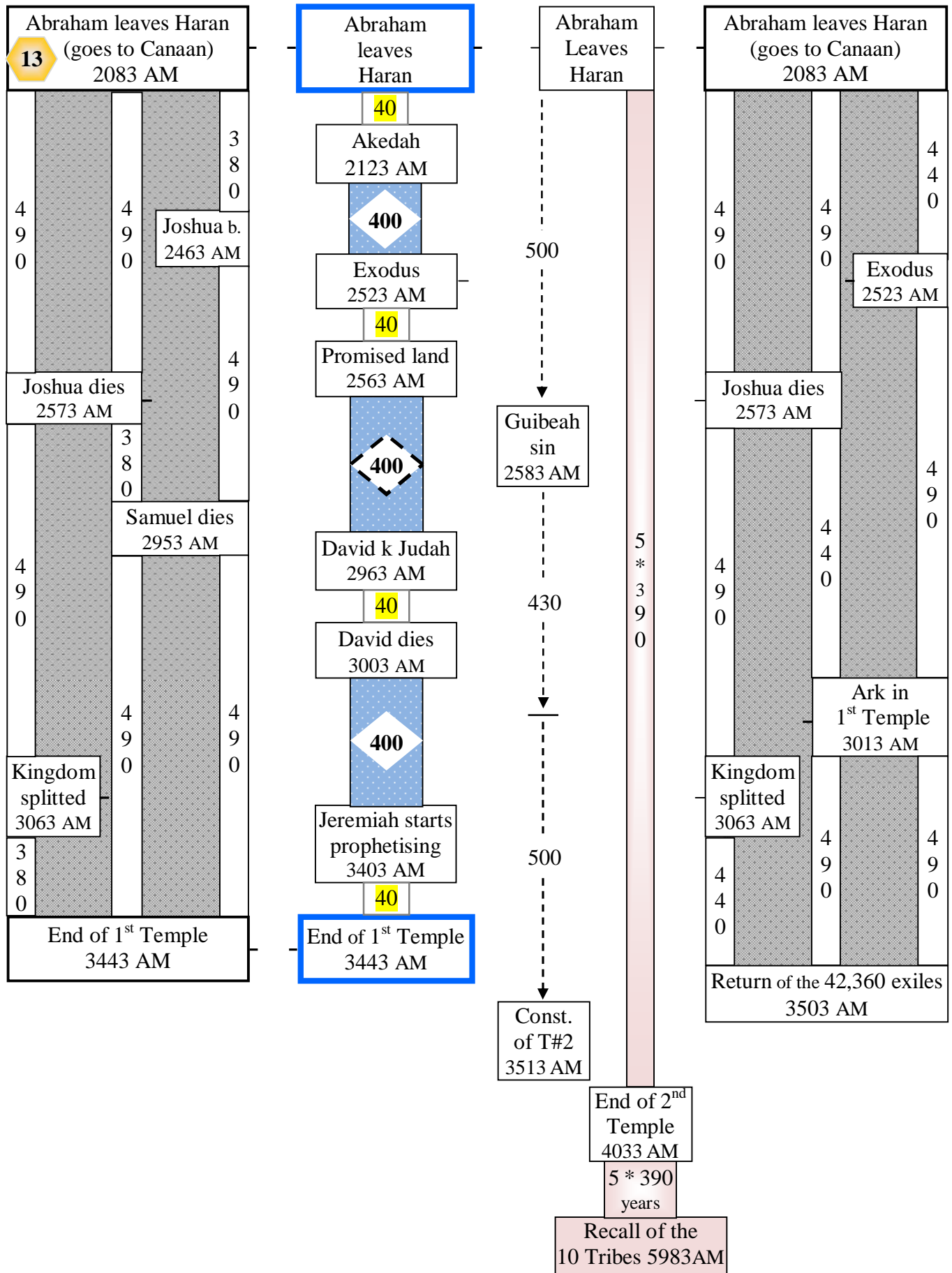

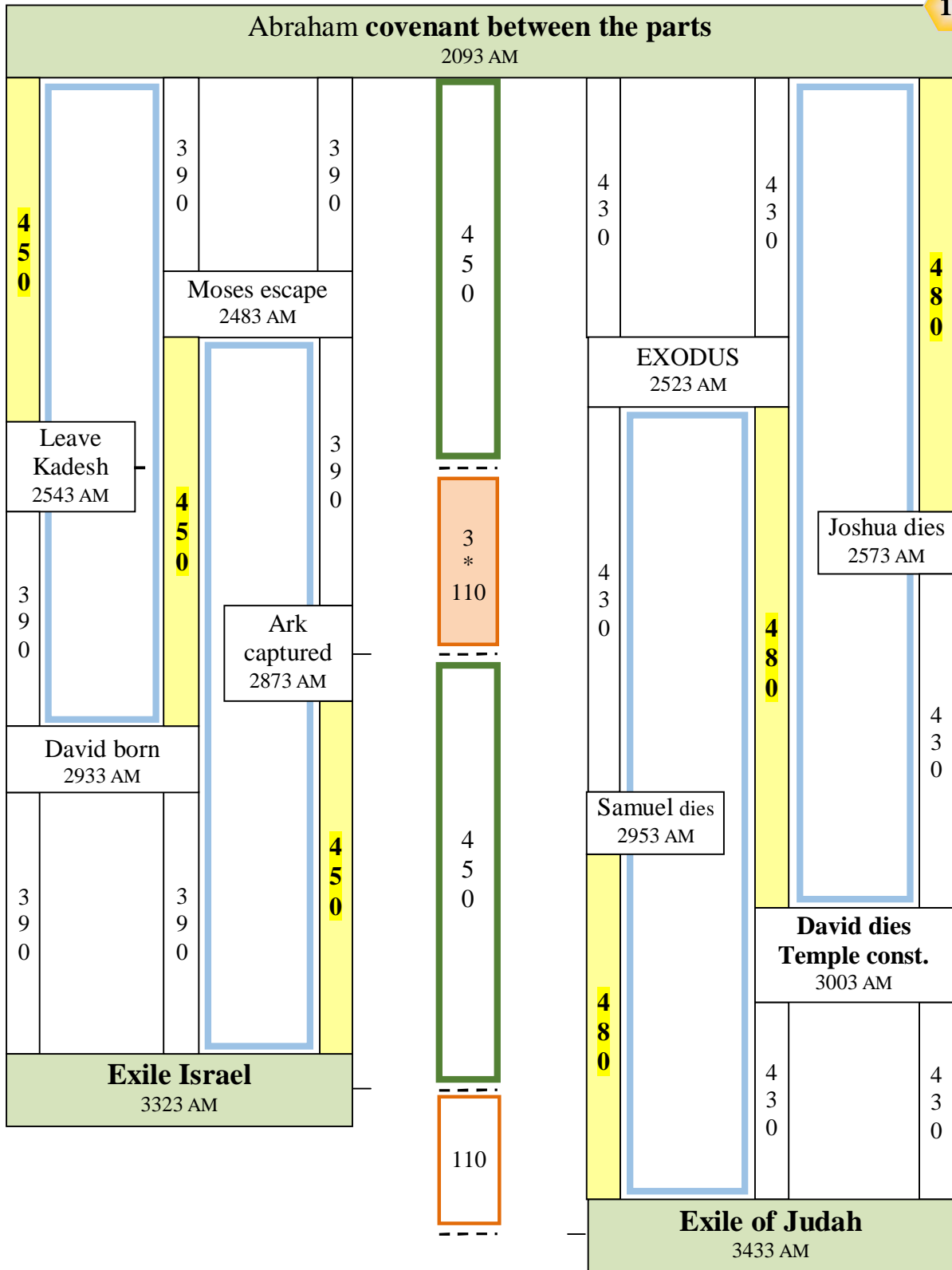

Covenant between the parts

2093 AM

15

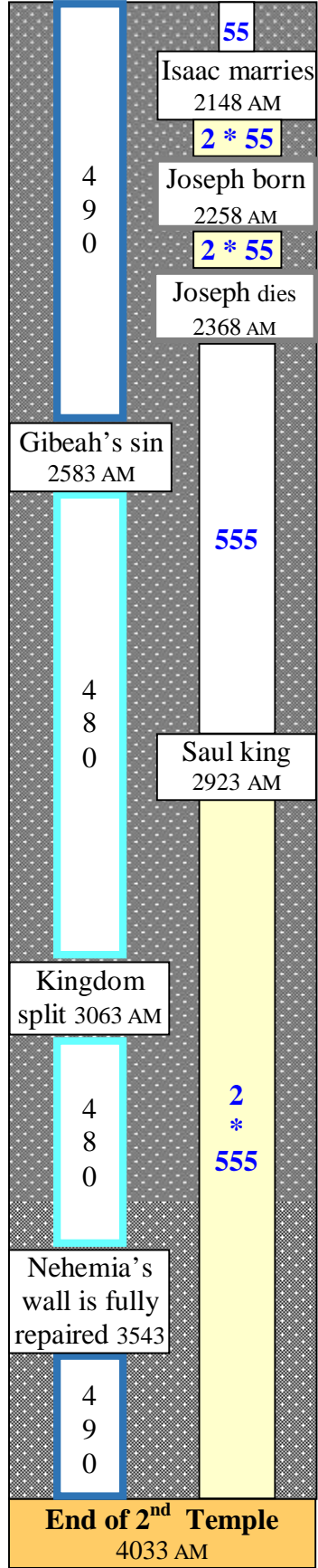
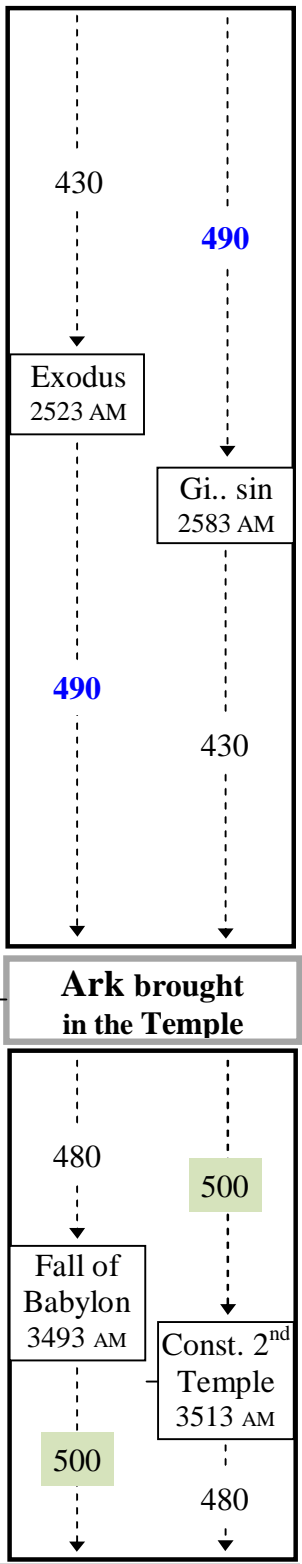
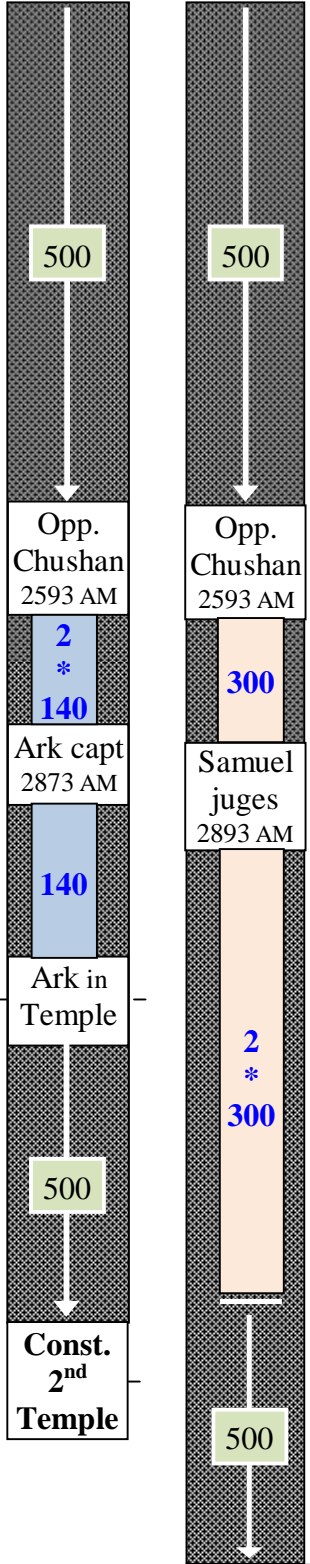
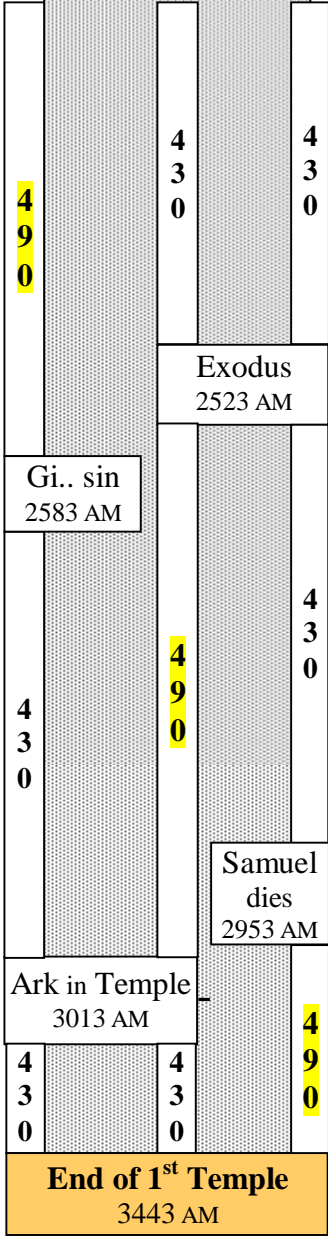

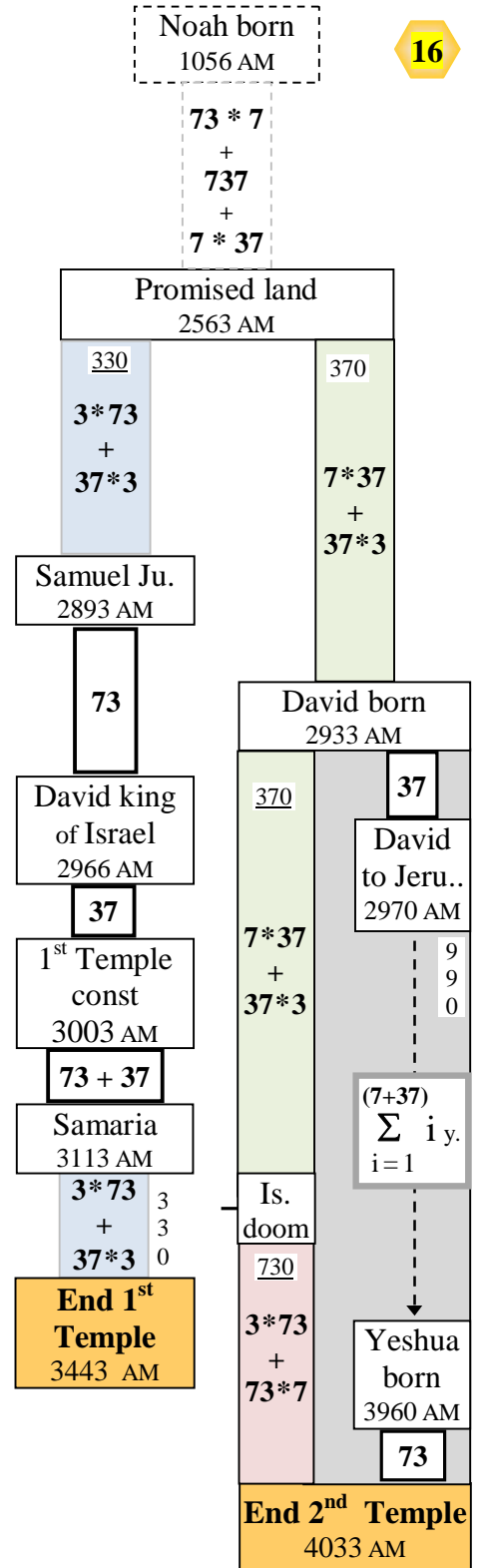
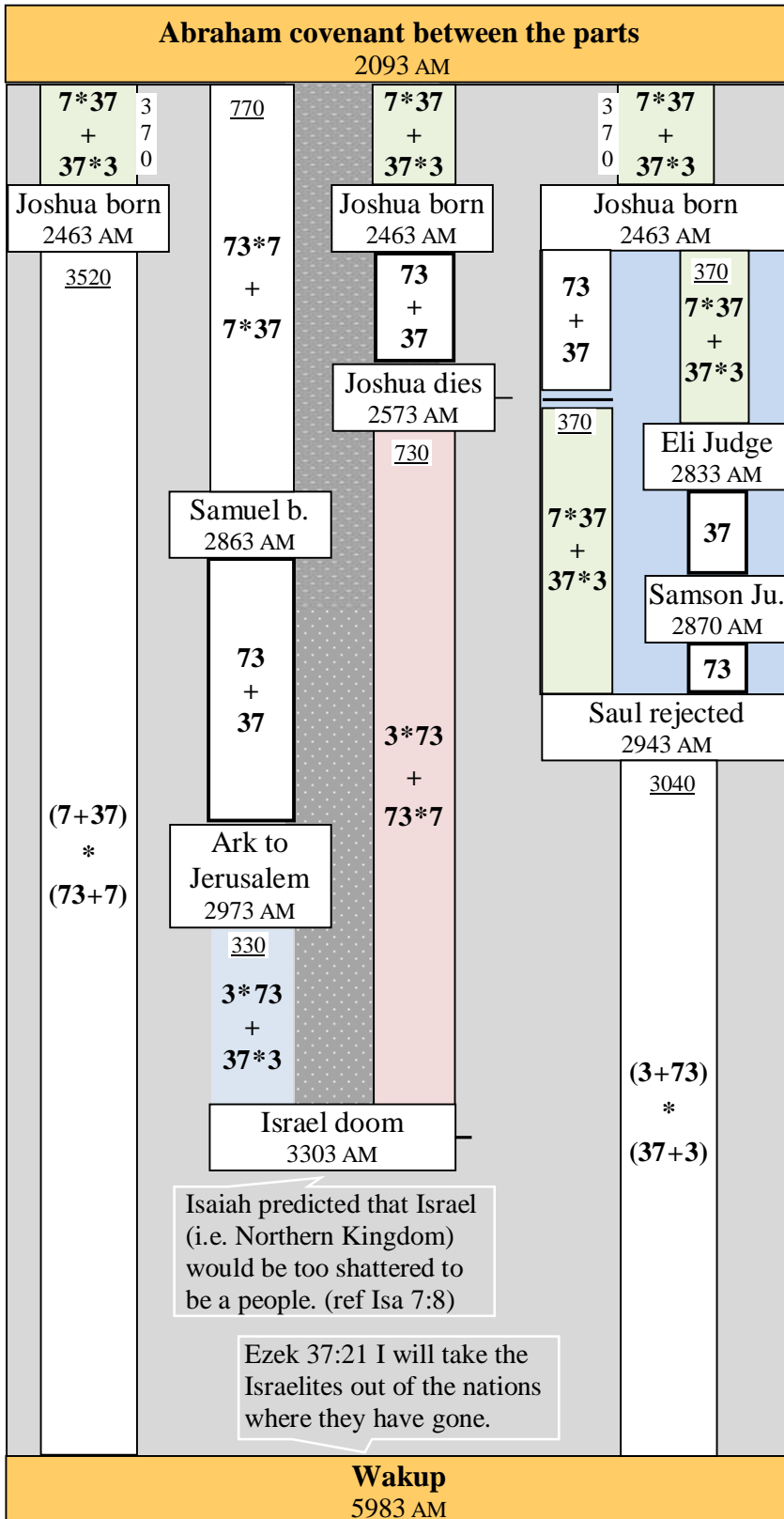

| | |
|---|---|
| <p style="text-align: center;">– Amazing –</p> <p>Abraham's Covenant of the parts linked to 10 majors events:</p> | <p>→ The 2 exiles (p. 209) █ 1st Temple const. (p. 193) █ 2nd Temple const. (p.210)</p> <p>→ The Ark brought in Jerusalem (p. 212) █ the Ark brought in the Temple (p.212)</p> <p>→ The two Temple's destructions (p. 210) █ the Messiah's death (p. 210)</p> <p>→ the wakup 'recall' of the 10 Lost Tribes</p> |
|---|---|

Covenant between the parts 2093 AM

17

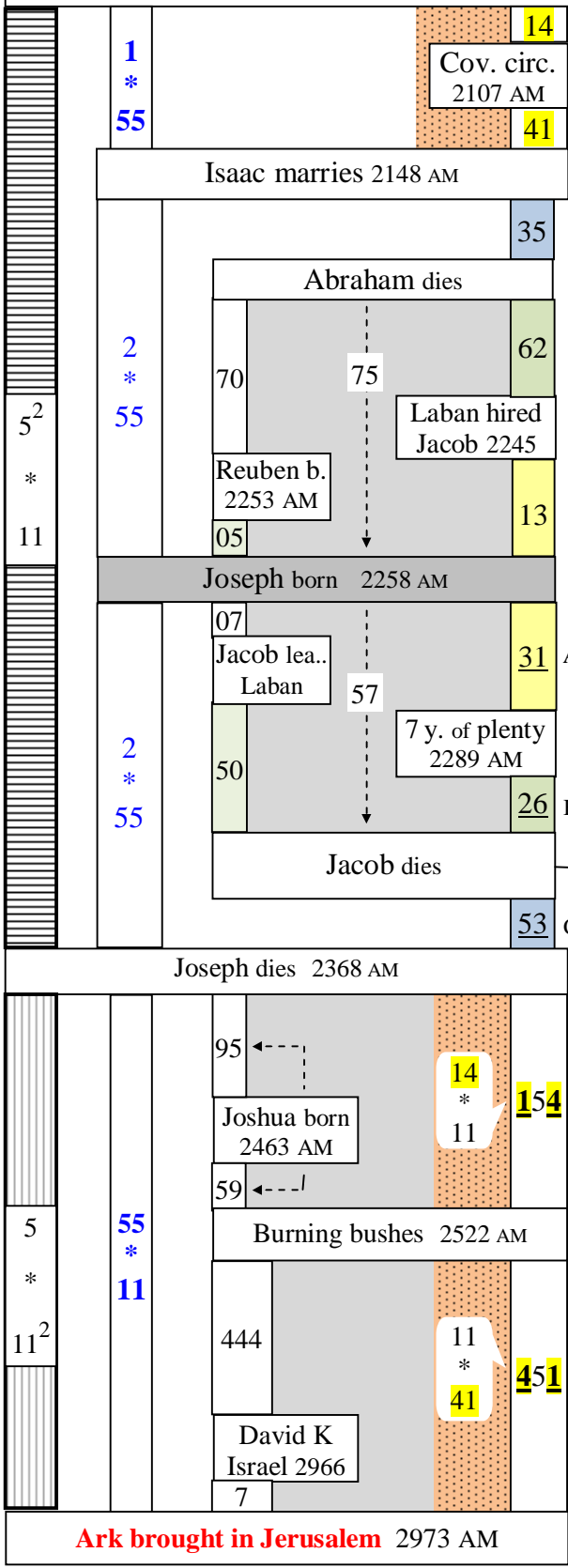

Amazing PALINDROMES

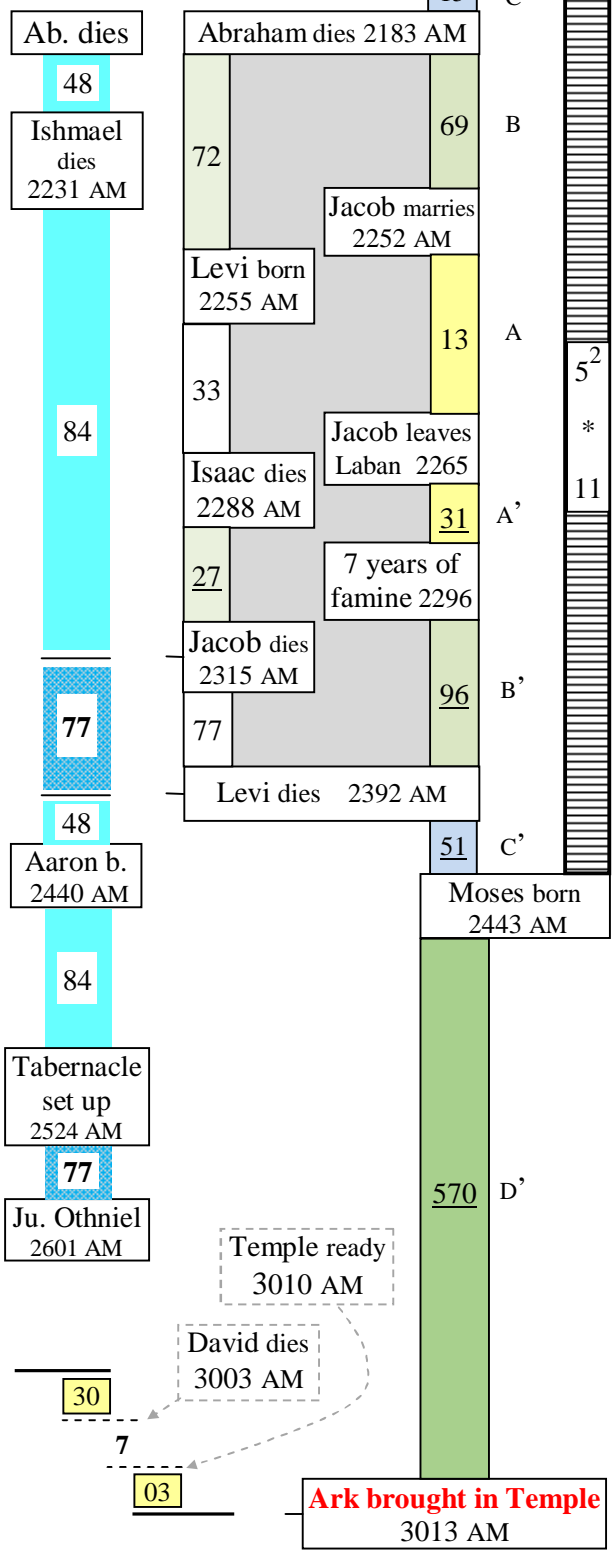

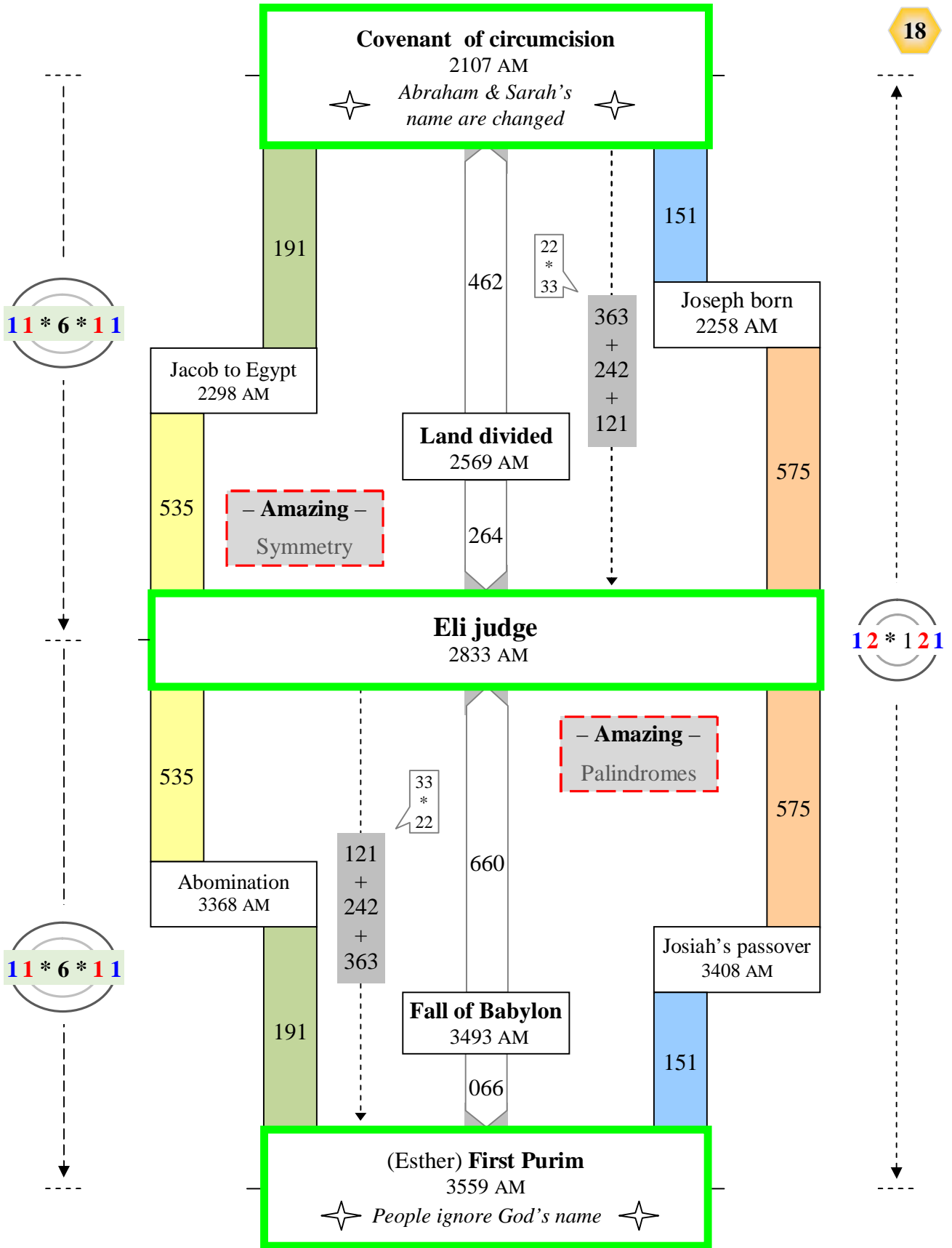

Binding of Isaac (AKEDAH)

2123 AM

19

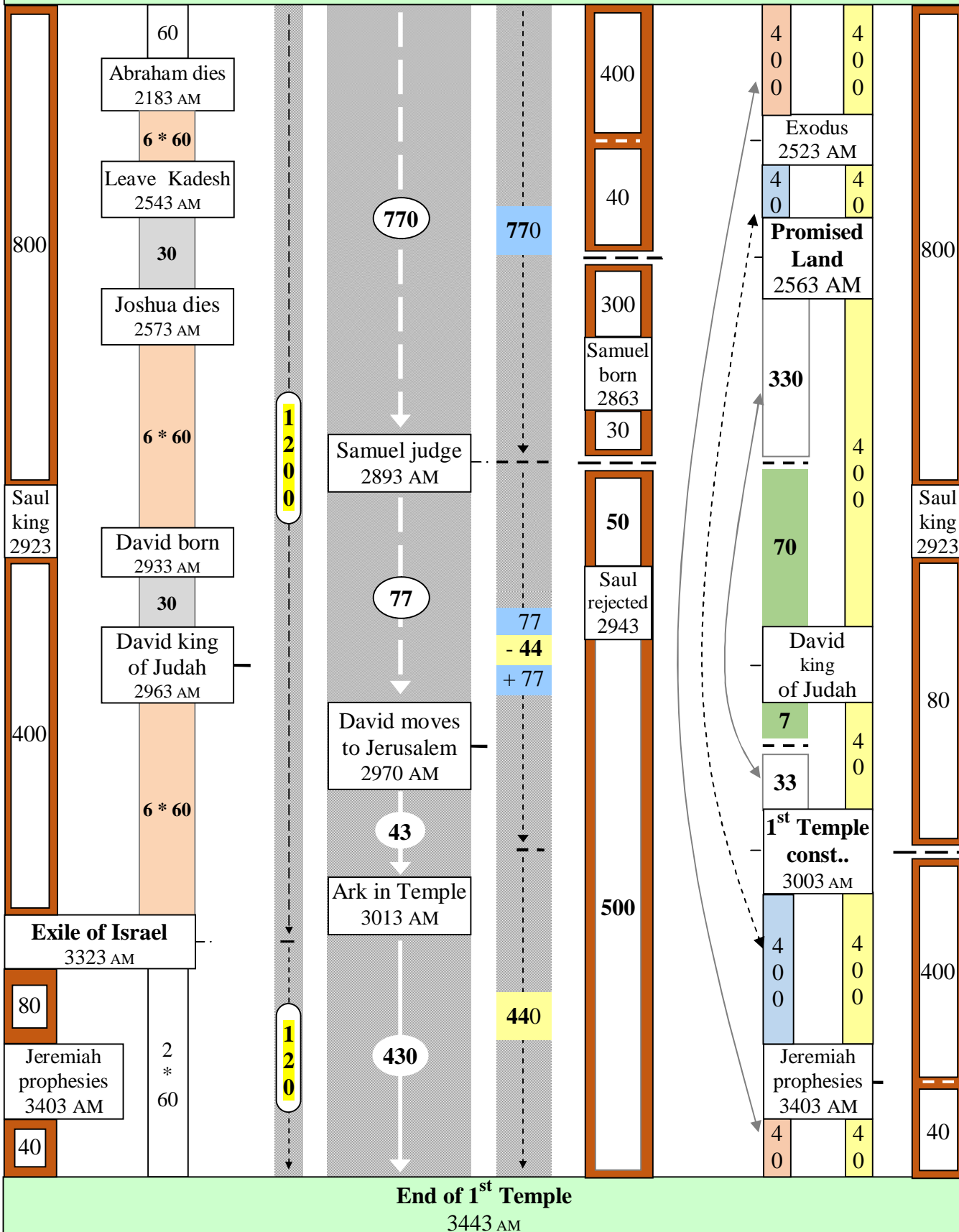

20 AKEDAH: Binding of Isaac 2123 AM
 (a RAM, "with head in a thicket of thorns", replaced Isaac)

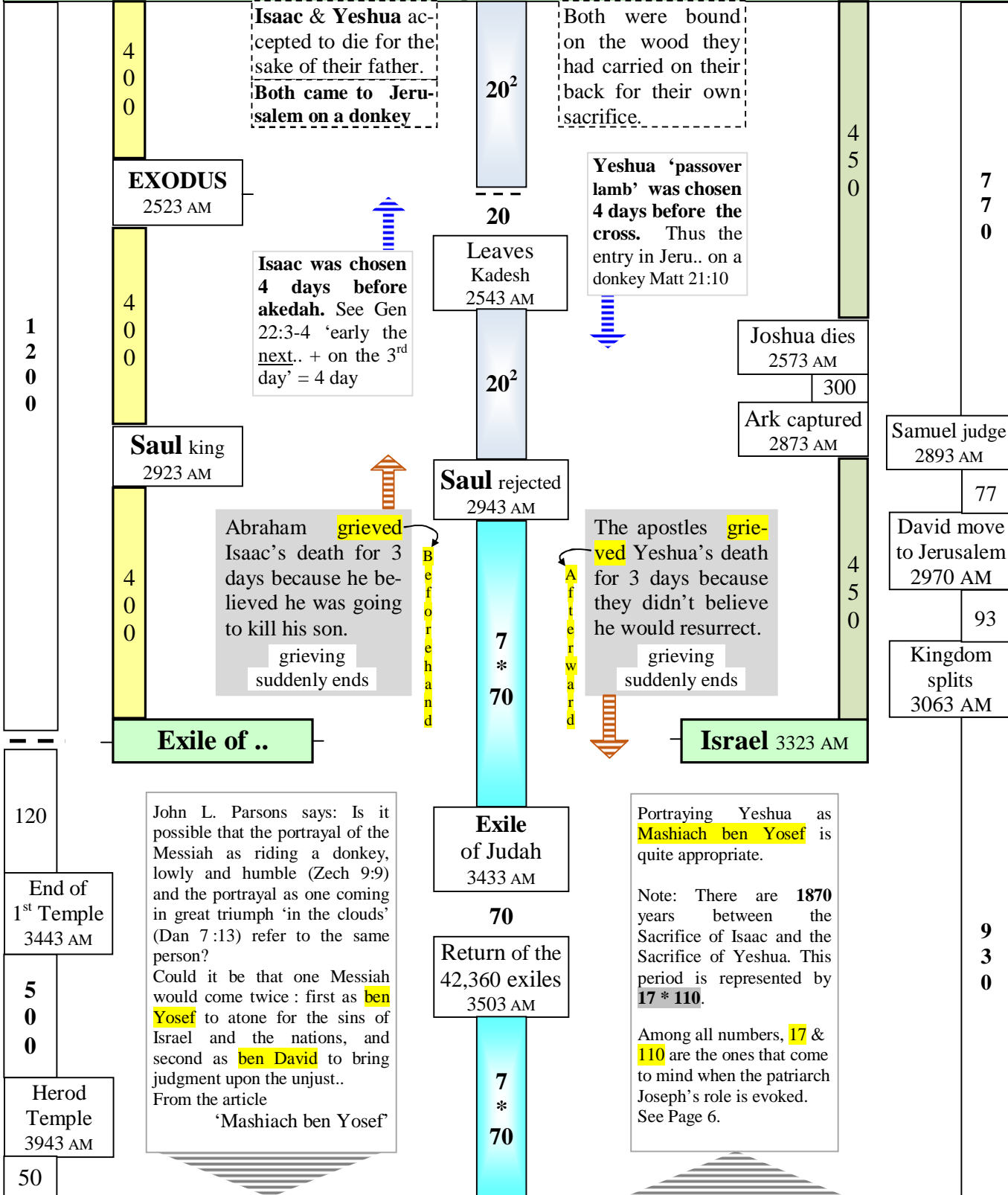

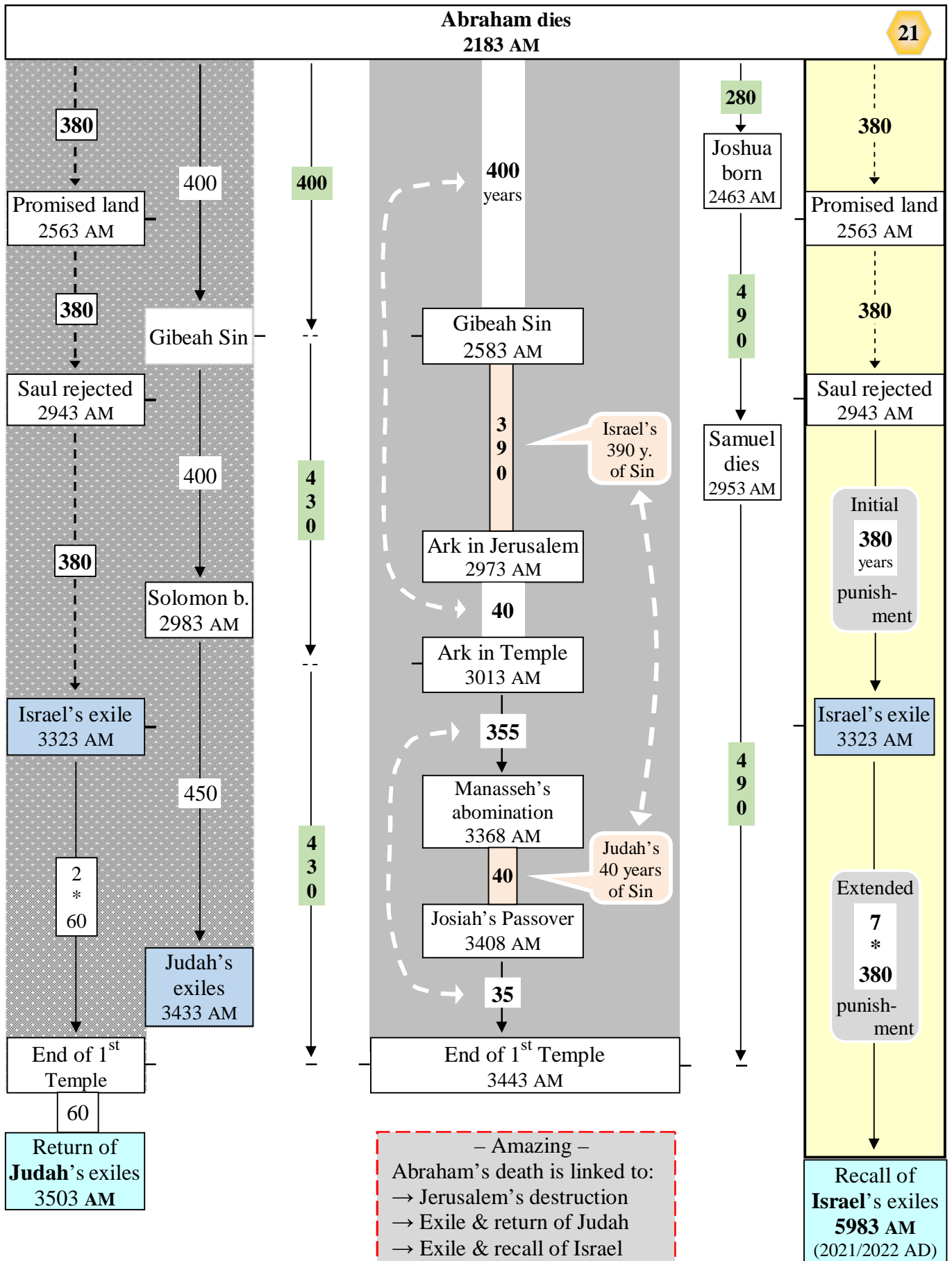

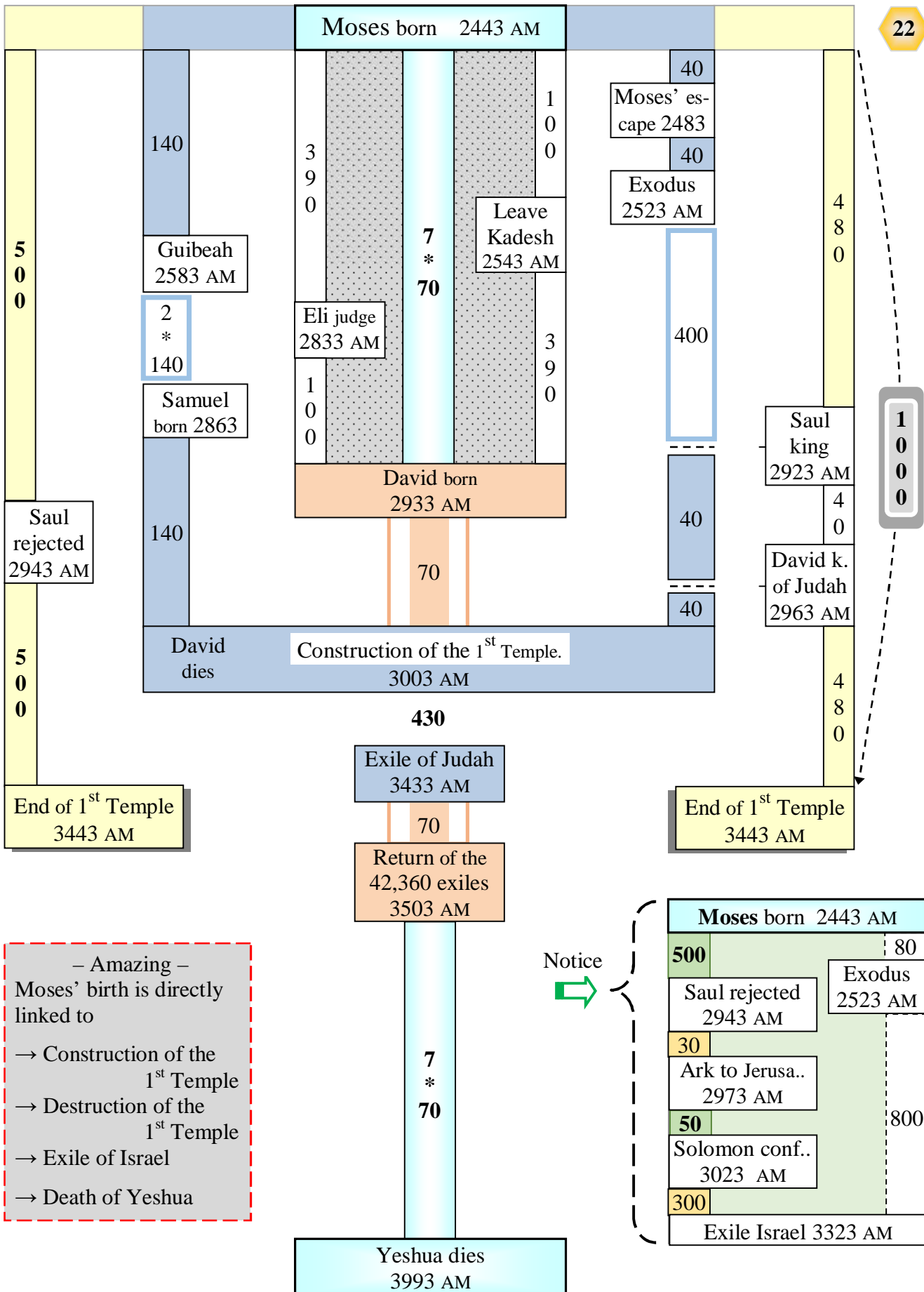

– Amazing –
 Moses' birth is directly linked to

- Construction of the 1st Temple
- Destruction of the 1st Temple
- Exile of Israel
- Death of Yeshua

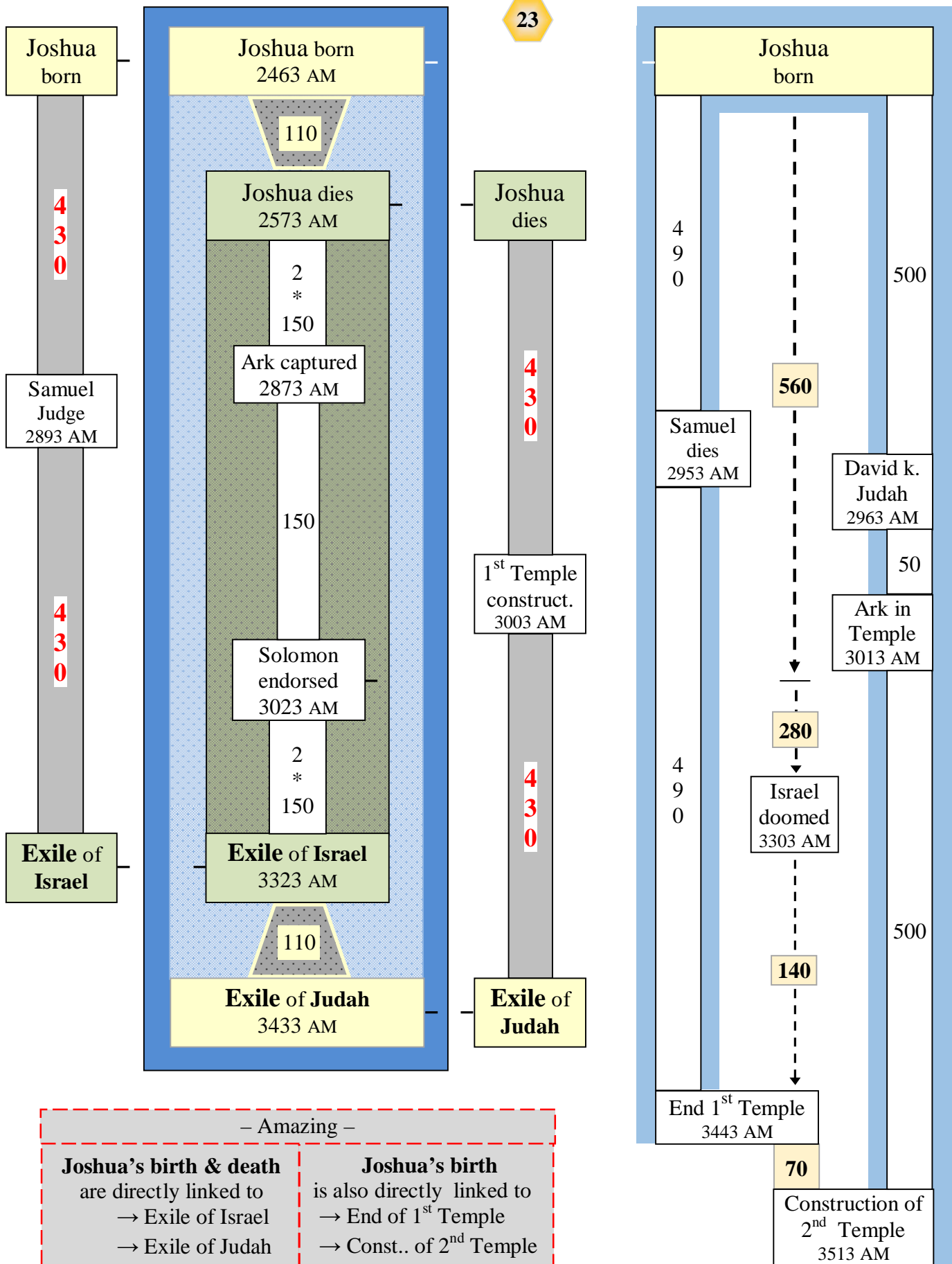

– Amazing –

Joshua's birth & death
are directly linked to
→ Exile of Israel
→ Exile of Judah

Joshua's birth
is also directly linked to
→ End of 1st Temple
→ Const.. of 2nd Temple

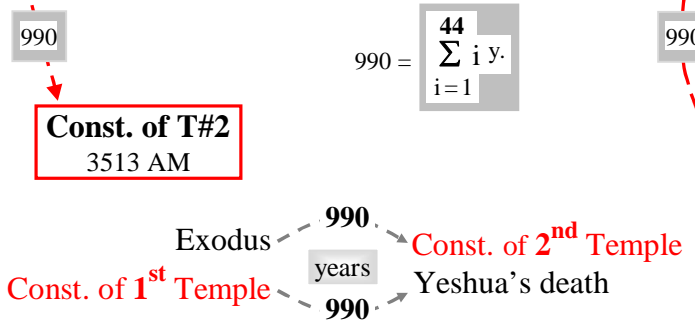
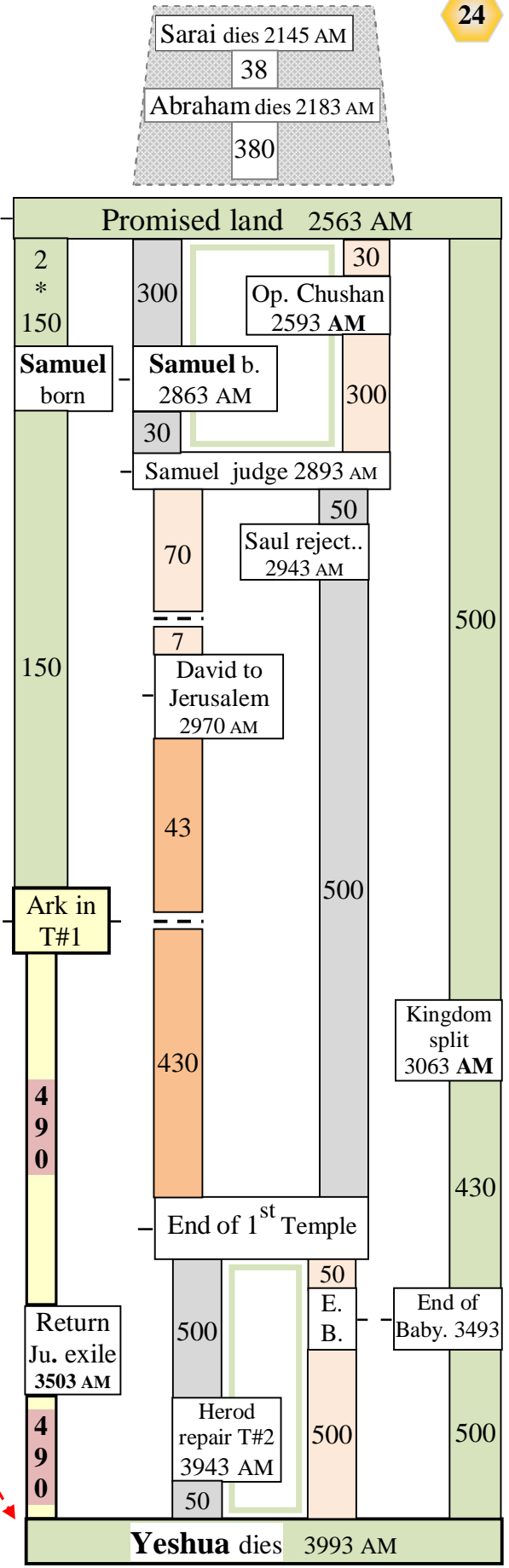
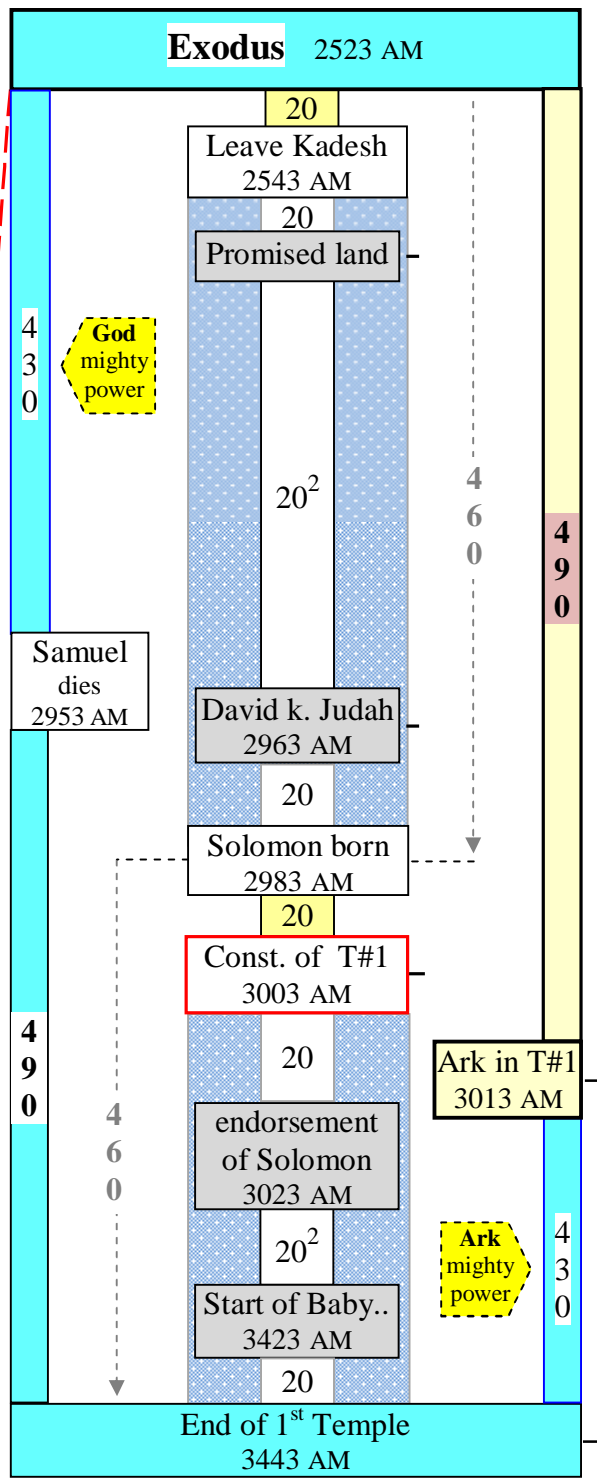

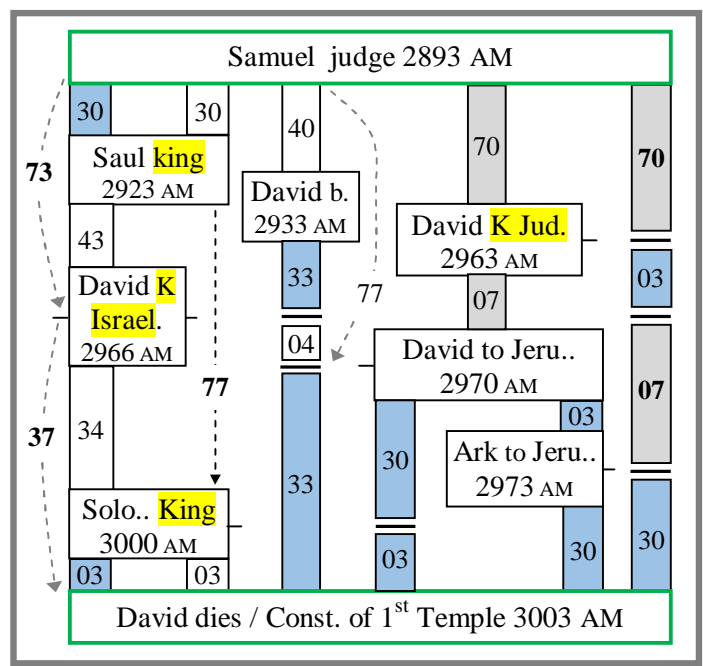
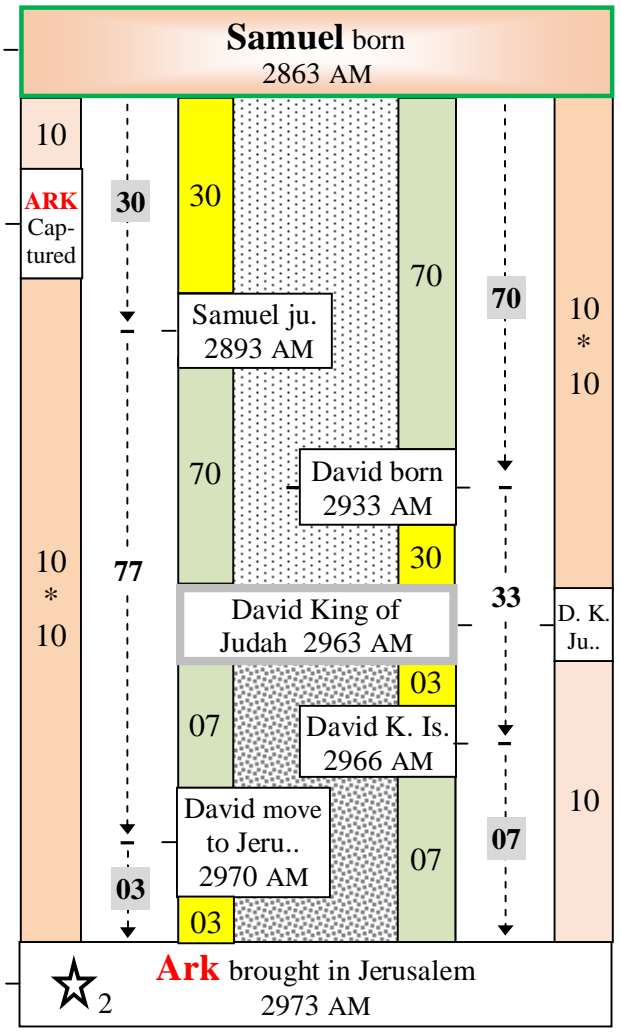
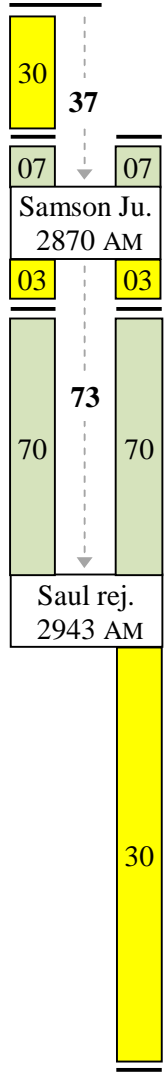
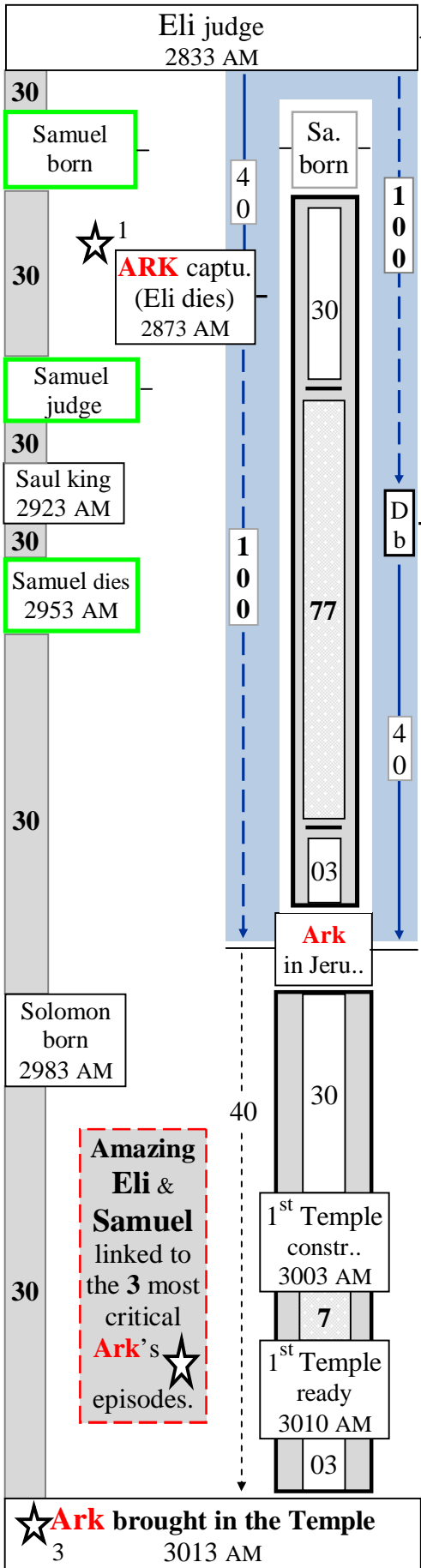

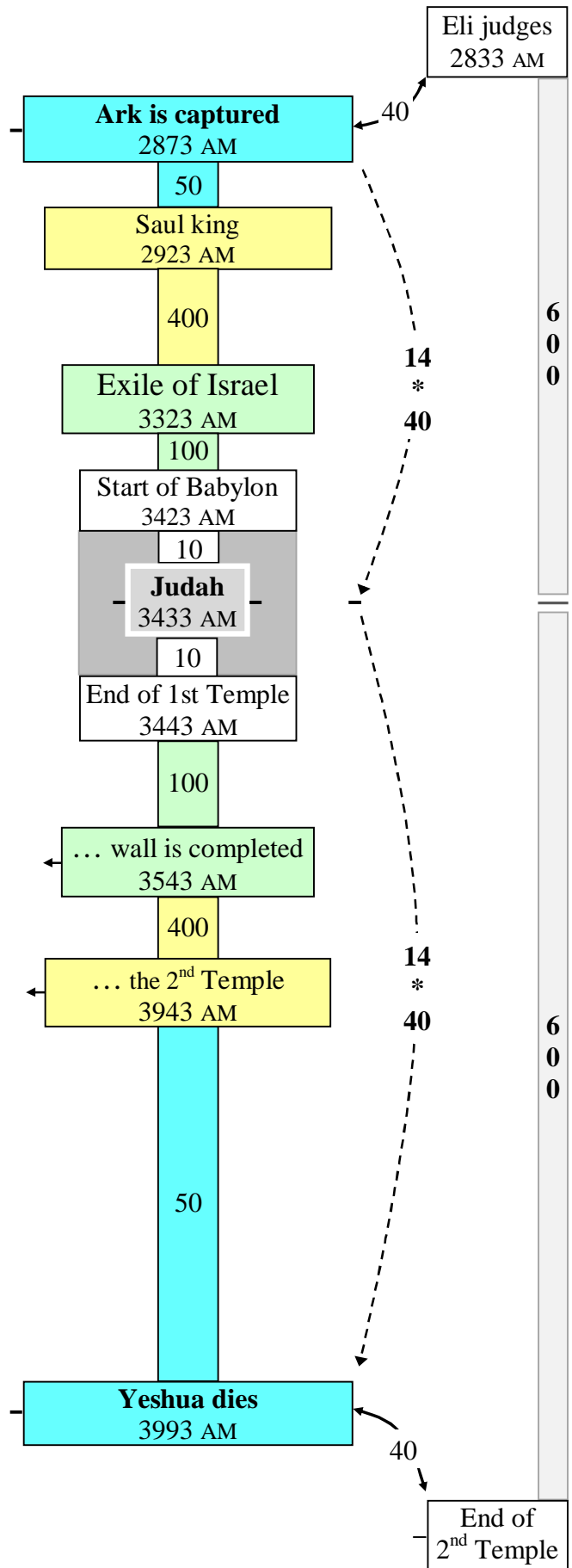
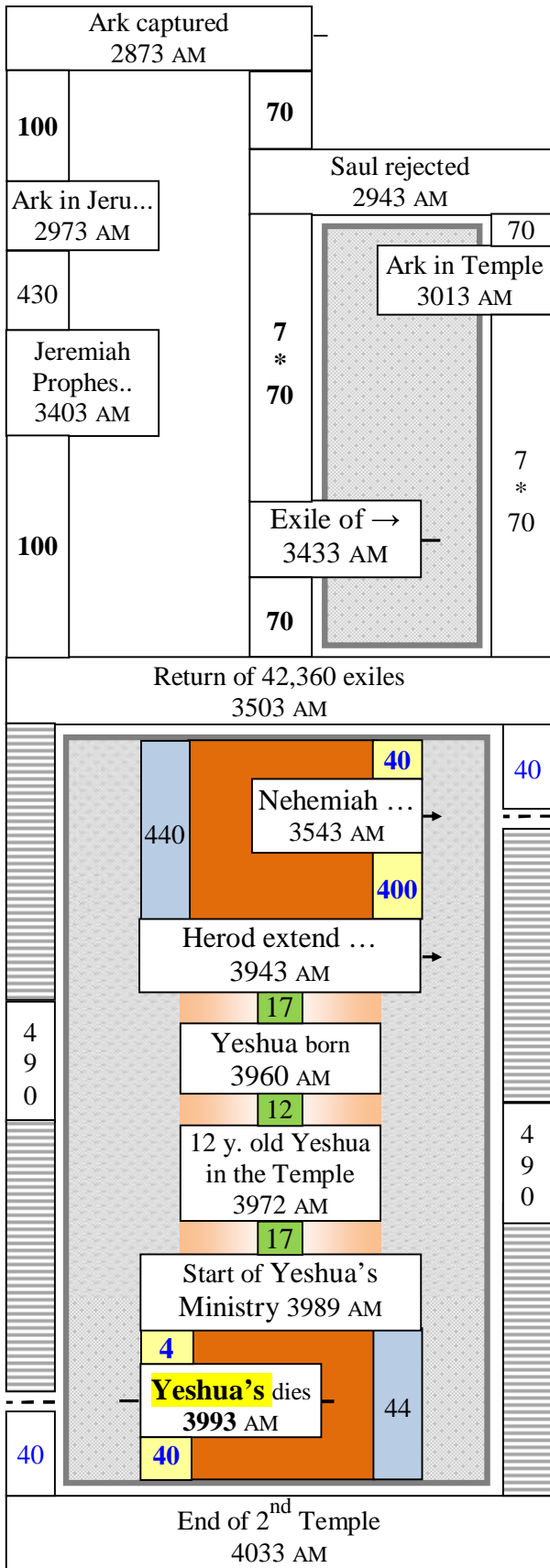

27

Ish-Bosheth King of Israel 2963
 2 y.
 Ish-Bo.. dies 2965

2 Sam. 2:10 Ish-Bosheth ..., and he reigned two years.

1 Chron. 29:27 He ruled over Israel **forty years**-seven in Hebron and thirty-three in Jerusalem.

- **Amazing** -
 Each event of David's life is part of a network of patterns

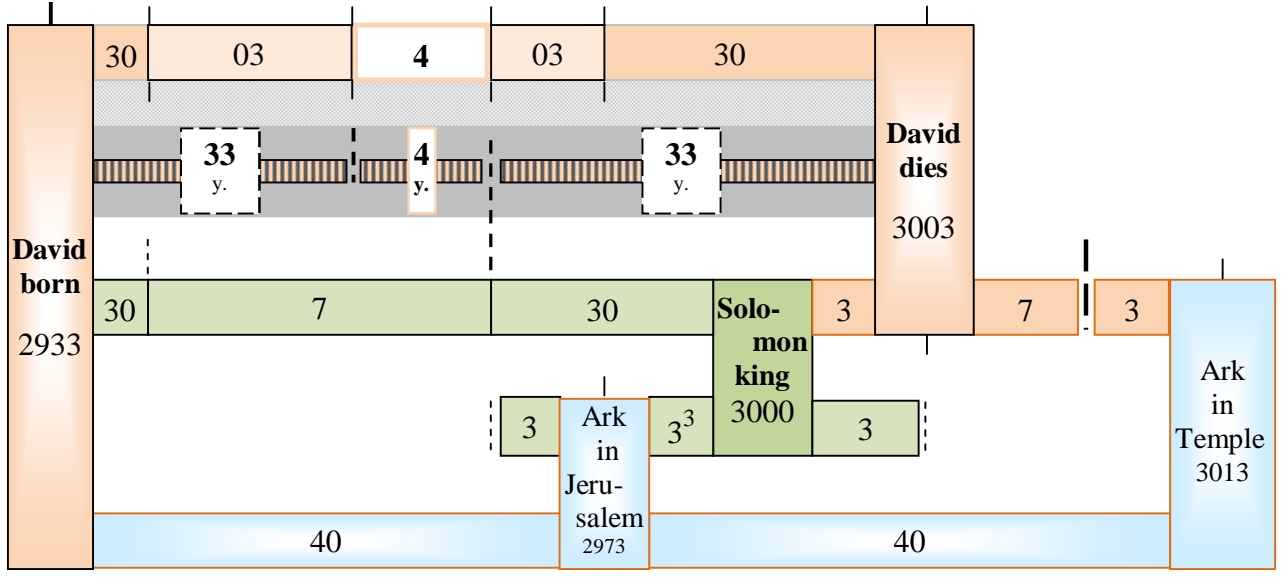
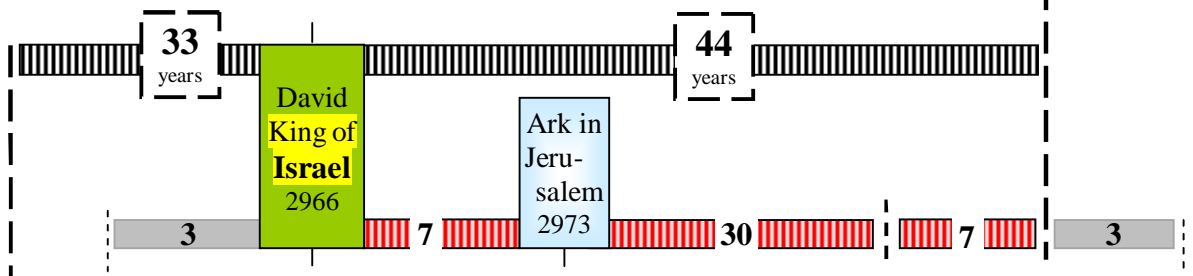
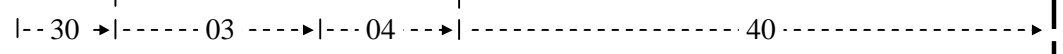
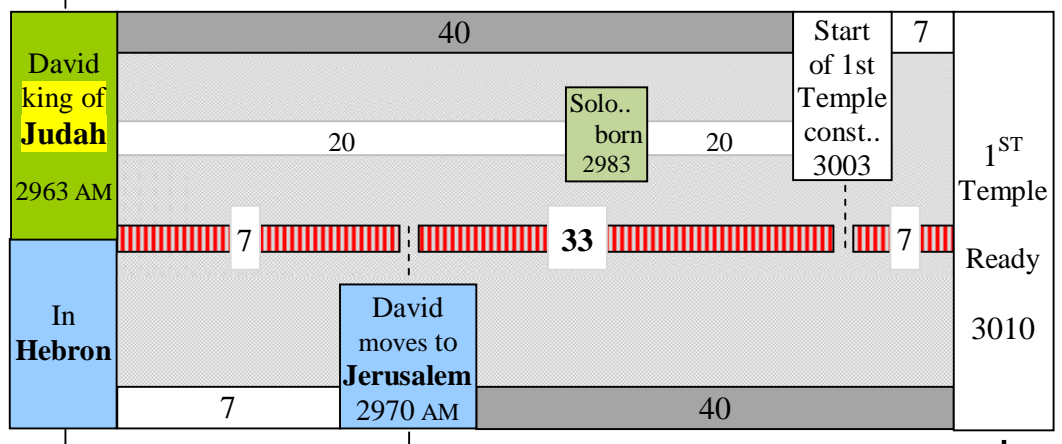

It is often assumed that David become **king of Israel** at the time he moved to Jerusalem in 2970 AM. This is unlikely. In the second year of Ish-Bosheth all Israel were eager to become David's subjects (2 Sam 3:17-18). Eventhough it could have been slightly delayed by the murders of Abner (2 Sam 3:27) and Ish-Bosheth (2 Sam 4:7) we read nothing that could have justify an additional five years wait (2965-2970).

| | | |
|-----------------------|--|--|
| 1st | 1 st Temple const.. 3003AM | T e m p l e |
| | 7 y. | |
| | First Temple ready 3010 AM | |

– **Amazing** –
 Perfect integration
 of Daniel’s
70 weeks

500

Foundation of the 2nd Temple
3510 AM

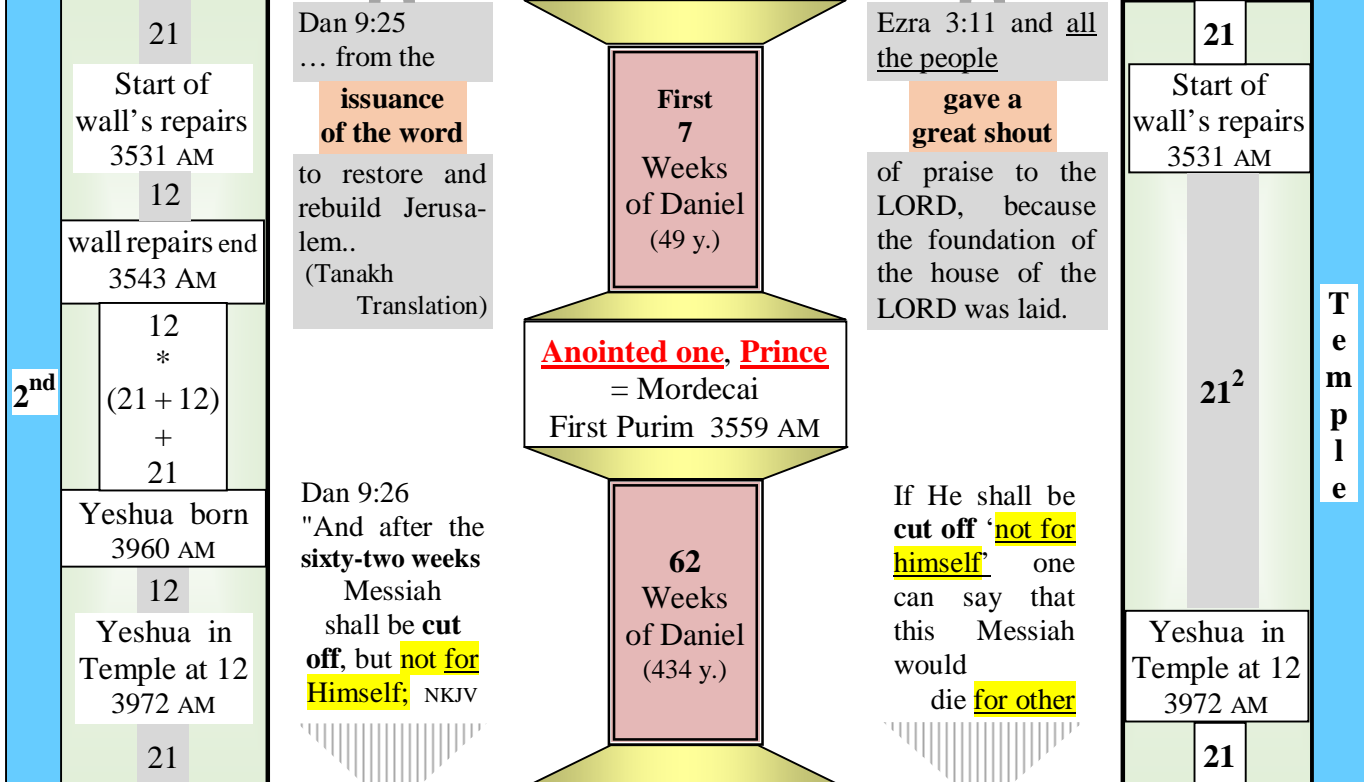

Anointed one cut off (Yeshua dies)
The 2nd Temple loses its legitimacy
 3993 AM

4 * 500

Isa 53:8 ... for he was **cut off** out of the land of the living KJV

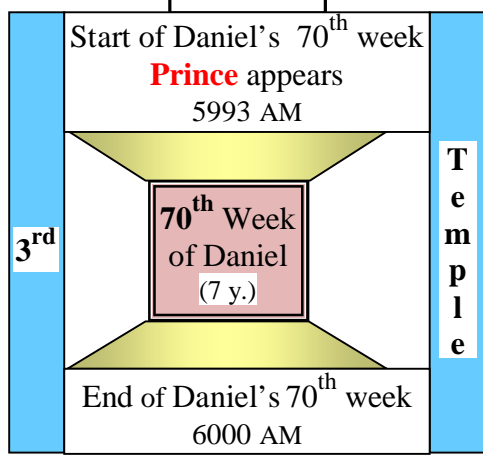

| | |
|--|--|
| John 11:51-52 Jesus would die for the Jewish nation, and not only for that nation but also for the scattered children of God | 1 John 2:2 He is the atoning sacrifice for our sins, and not only for ours but also for the sins of the whole world. |
|--|--|

Conclusion

Could anyone still doubt the Bible's numeric information after having seen how it can be organized and presented in such a spectacular manner? In the light of all the patterns shown in this book we can deduce with some confidence that for almost 6000 years now, YHVH, the great architect of our universe, the God venerated by Abraham, Isaac, and Jacob, has patiently and subtly stirred mankind's progression across time, allowing some selected events to become special markers in His grand design.

In the present book Ezekiel 4-5 has been used to unlock the Bible's chronology in so many ways that we have now the proper date of more than 190 different events. Yet, during the reading of this book did you notice that a few events became much more highlighted than the others? They are **Abraham's covenant**, Akedah, Exodus, both exiles, events related to 1st and 2nd Temple and **Yeshua's death**. Isn't it surprising and quite revealing to have Yeshua's death among such a limited group? Who could deny that Yeshua's death occupies a major place in history when so many patterns exalt it? Among other thing this book has shown that his death stands on a direct numeric path with Adam and David.

Did you also notice that while Yeshua's death (and resurrection) was emphasized several times, his birth appeared to have been downplayed and kept out from most of the patterns? That was not a deliberate ploy from the author to minimize its weight. All the information related to Yeshua's birth was used in the best possible way, unfortunately in the end, oddly enough, there was very little to present. Is YHVH's chronology showing us, in a subtle way, that Yeshua's birth, by itself, was not that important? If that is the case, and the previous pages seem to claim it, then many people who believe in Yeshua's pre-existence or in his supposedly **innate** 'divinity' should see it as a clue that something doesn't add up. Why wouldn't a major event, like the '**incarnation**' of God among us, generates some of the strongest, most captivating and relevant connections whereas his death does just that?

Isa 43:10 Before me no god was formed, nor will there be one after me.

Deut 4:35-36 the LORD is God; besides him there is no other.

Trinity is irrational & unbiblical.
To say it is a mystery is to admit that the church's fathers, who formulated it more than 300 years after Yeshua's death, didn't understand it either.

1 Cor 8:4-5 We know that ... and that there is no God but one.

1 ≠ **③**

Deut 6:4 Hear, O Israel: The LORD our God, the LORD is one.

At most, trinity is speculative and a superfluous addition to the fundamental characteristic of the Supreme Being known as the God of Abraham, Isaac, Jacob, Ezekiel, Yeshua...

Gal 3:20 but God is one.

James 2:19 You believe that there is one God. Good! Even the demons believe that-and shudder.

In a paper called 'Unweaving The Trinity'¹¹⁰, Noel Rude said: 'The mother of all Christological heresy, let me suggest, was the Virgin Birth – If it falls this does not take away from what is **central** to the New Testament, namely the **resurrection**.'

The plain truth is that Yeshua was born 'a son of man' and became 'the first son of God' at the **resurrection**. ⇨

Why are there so many people who have it backwards and persist in believing that Yeshua was first 'a son of God' and became 'a son of man' at his birth?

Paul said (Act 13:33) that when He **raised** Yeshua [from the dead] God **fulfilled** the promise written in the Psalms:

You are my son
Today I have become your father Ps 2:3

The following verse, also from Paul, says it in no uncertain terms:

Rom 1:3-4 concerning His Son Jesus Christ our Lord, who was born of the seed of David according to the flesh, and declared to be the Son of God with power according to the Spirit of holiness, **by the resurrection** from the dead.

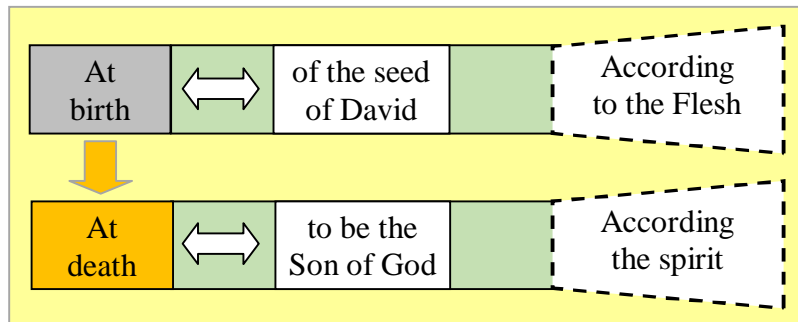

No matter that Yeshua's birth was foretold, that he was continuously filled with the spirit of God (John 3:34), that he manifested a perfect knowledge and observance of the Law, he couldn't have assumed the role of Messiah Ben Joseph if he hadn't carried the seed of Abraham. Let's remember that 'seed' is transmitted from father to son during human conception. It is clear that a virgin birth¹¹¹ would have broken the chain and disqualified Yeshua.

- Gal 3:16 Now to Abraham and his Seed were the promises made. He does not say, "And to seeds," as of many, but as of one, "And to your Seed," who is Christ. NKJV

To those who recognize the importance of the seed, but argue that God could have miraculously planted the seed (or an embryo) in Mary's womb, it should be asked: What was then achieved with that pregnancy? Was there any need for it given that the unique characteristics of a human conception were all bypassed? YHVH created Adam from the dust of the earth; He could have as easily created the last Adam the same way:

- Matt 3:9 For I say to you that God is able to raise up children to Abraham from these stones. NKJV

Noel Rude asks: 'Why would the Bible preserve father to son genealogies from Adam to Joseph only to have Jesus adopted into this genealogy?' And he adds: '**The Virgin Birth doesn't square with the Torah and the Prophets**, but fits perfectly with the paganism of the period.'

The only scenario who could truly justify a virgin birth would be the one that would allow a celestial entity (God or whoever else) to transit from the spirit world to our physical one. But if you believe that this is what happened and that Yeshua was the personification of one of

¹¹⁰ <http://www.hebdomad.com/article/list>

¹¹¹ For more on "rejecting" the Virgin birth googles 'The Fiction of the Virgin Birth Wayne Simpson' .

these spiritual being you need to explain, in a convincing way, the following: Why did Yeshua had to go through a testing phase after his baptism.

- Mark 1:12-13 At once the Spirit sent him out into the desert, and he was in the desert forty days, being tempted by Satan.

It is obvious that this sojourn in the desert was to test his character. Three times he was pressured (Matt 4:3, 4:6,4:8) and had he indulged himself he would have been disqualified as our future savior. Notice that just before he was sent into the desert to be tempted the voice of God was heard (Mark 1:11). A similar thing happened about 1900 years before when Abraham heard God and was then challenged to offer Isaac as a sacrifice.

But contrary to Abraham, if Yeshua was the incarnation of God or some other pure and irreproachable spirit worthy to become our Savior, there was no need to test him. How could he had failed with his pre-existing background? When you think about it **the testing in the desert makes sense only if Yeshua was a simple mortal who was not immune against failure.** In this context the virgin birth was useless and could only have become part of the canon as the result of some well planned alteration of the text.

About the 6000 years. Nobody can deny that science is very good at refuting the timeline proposed in the Bible. To the creationists' 6000 years, science counters with an astronomically proven 14 billion year-old expanding universe. Science by definition extrapolates from what can be seen and what can be formulated. There is no room for faith in any of its equations. If it cannot be confirmed experimentally it cannot be.

That being said, Genesis never proclaimed that the Universe was created in its early stage. Was Adam created as an infant? Certainly not and any scholar who would have met Adam during the 6th day of the creation, would have concluded, from his own observation, that Adam had a mature physical body fully formed and therefore was in his adulthood, much older than the few hours that he really was. The point here is that both the Universe and men were created the way, and at the stage the creator wanted them to be.

If you believe the Bible, but nevertheless choose to confine the Genesis account to the domain of mythology (and many brilliant people do) how do you address the following few issues:

- ⇒ Without the creation week Adam has no special origin and Yeshua's genealogy is meaningless.
- ⇒ If God never rested on the seventh day what was the purpose of asking the Israelites to keep The Sabbath? (see Exodus 20:11)
- ⇒ Without the sin introduced in Eden what was the purpose of Yeshua's death?
- ⇒ If Cain & Abel story is a myth, why did Yeshua believed it? (Luke 11:51)
- ⇒ If the Flood never happened why were Matthew, Luke and Peter referring to it? (Ref Matt 24:38, Luke 6:48, 1 Peter 4:4).
- ⇒ If you believe that the Flood was only local, why did God tell Noah that never again a flood would destroy the earth? (Gen 9:11) Don't you know that local floods occur on a regular basis.
- ⇒ If the numbers mentioned in Genesis are meaningless where do we start accepting those we read at their face value? In Exodus? In Kings? In Ezekiel?

If you don't accept the straightforward reading of Genesis then you must be relating to science to explain our origin. Have you ever wonder what could have initiated the big bang? Do you really believe it is possible to have an 'effect' without a primary 'cause'? Yves Pélouquin

Appendix A From Adam to Abraham (the basic timeline)

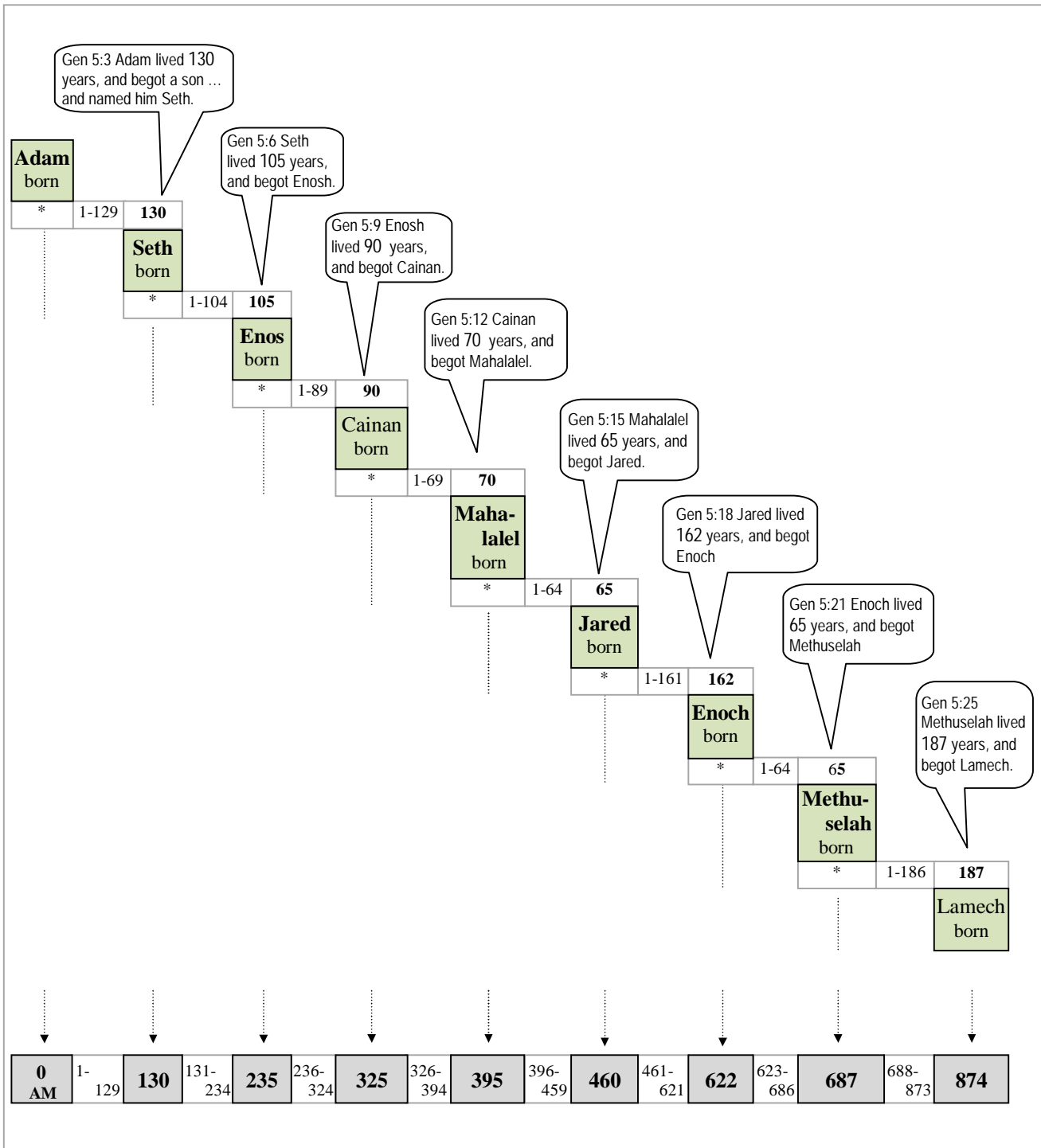

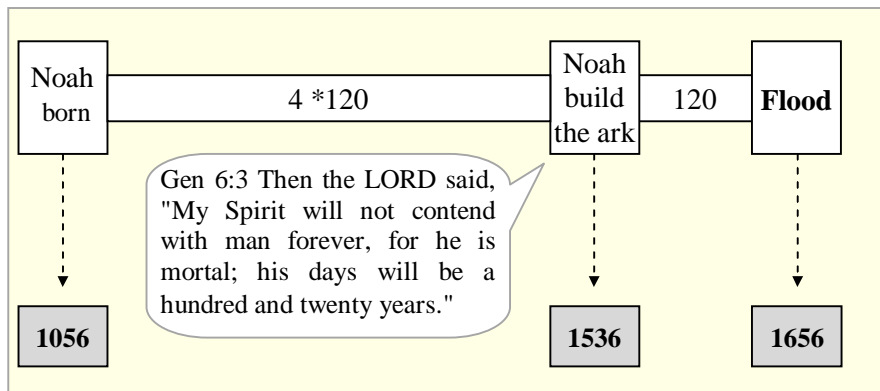
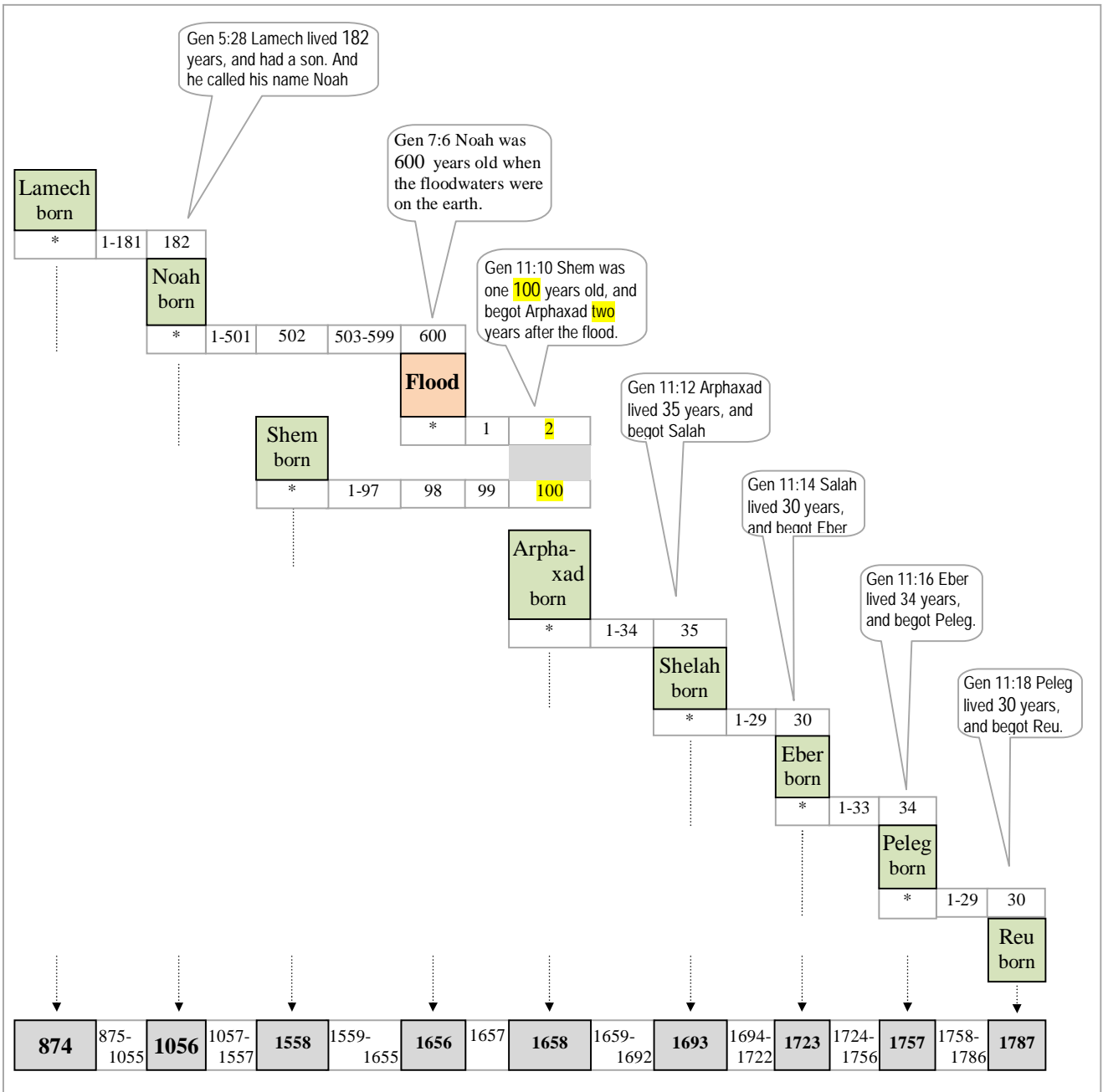

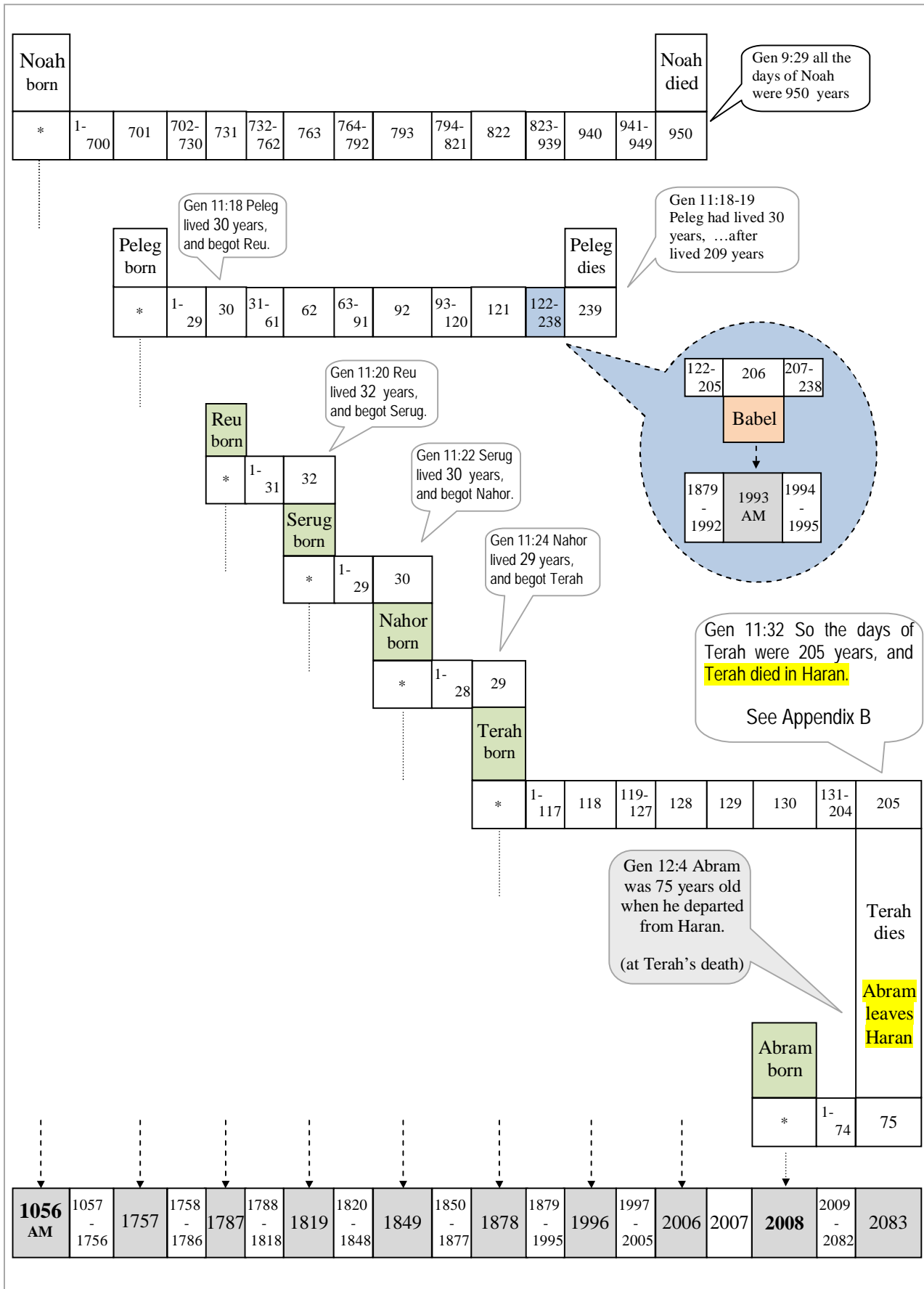

Appendix B Abraham's family tree

When was Abraham born?

- Gen 11:32 Terah lived 205 years, and he died in Haran.
- Gen 12:4 So Abram left, as the LORD had told him; and Lot went with him. Abram was seventy-five years old when he set out from Haran.

According the previous two verses Abraham was 75 years old when he left Haran “at his father’s death”.

First conclusion : Abraham was born when Terah was 130 years old (205 – 75).

However, according to the next verse, Abraham was born when Terah was 70 years old.

- **Gen 11:26** After Terah had lived 70 years, he became the father of Abram, Nahor and Haran.

Sec. conclusion : Abraham could have been born when Terah got 70 years old.

Given these two conclusions cannot be right at the same time there must be a way to reconcile Gen 11:32, 12:4 and 11:26?

First, unless Terah was the father of triplet, and it is very unlikely given the absence of any Bible’s comment on such an extraordinary fact, you have to admit that **Gen 11:26** only say that Terah got his first son when he was 70, the other two sons came to him in the latter years. But, if this is the case, wouldn’t it mean that Abraham, the first name to be listed, was born when Terah was 70? No. Being the first in the list doesn’t mean that he was the first born. There is a precedent worth to be examined.

From the following two verses you could be inclined to think that **Shem** was Noah first son, after all he is listed first¹¹² in both cases.

- Gen 5:32 After Noah was 500 years old, he became the father of **Shem**, **Ham** and **Japheth**.
- Gen 10:1 This is the account of Shem, Ham and Japheth, Noah's sons, NIV

However, here it is clearly said that **Japheth**, not **Shem**, was the oldest son of Noah.

- Gen 10:21 Sons were also born to Shem, whose older brother was **Japheth**;

Back to Abraham. The readers would correctly point to the fact that Gen 11:32,12:4 don’t especially say that Abraham left Haran at the death of Terah. I agree with the reader, Gen 12:4 doesn’t say it, but, **Stephen, under inspiration did.**

- Acts 6:5 They chose Stephen, a man full of faith and of the Holy Spirit;
- Acts 7:4 "So he left the land of the Chaldeans and settled in Haran. **After the death of his father**, God sent him to this land where you are now living.

In 2008 AM, the 130 years old Terah (born in 1878 AM), got his son Abram.

¹¹² Could have been done as a sign of the future prominence of the individual.

Terah had 3 children: Abam, Nahor, Haran

- Gen 11:26 After Terah had lived 70 years, he became the father of **Abram**, **Nahor** and **Haran**.

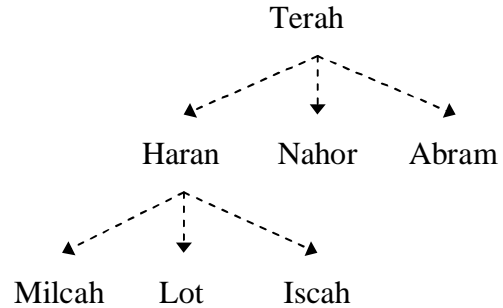

Haran, Abram's brothers, had also three children: Lot, Milcah and Iscah

- Gen 11:27 And Haran became the father of Lot.
- Gen 11:29 ... Haran, the father of both Milcah and Iscah.

It is believe among jewish sages that **Iscah is none other than Sarai**¹¹³ (the girl who would become Abraham's wife). Both names, **Iscah and Sarai**, means "princess". Sarai is therefore the sister of Milcah and the niece¹¹⁴ of Abram.

Immediately **after mentionning Haran's death** the Bible tell us that Abram took a wife called Sarai and Nahor took also a wife called Milcah.

- Gen 11:28-29 And Haran died before his father Terah in the land of his nativity, in Ur of the Chaldees. And Abram and Nahor took them wives: the name of Abram's wife was Sarai; and the name of Nahor's wife, Milcah, the daughter of Haran, the father of Milcah, and the father of Iscah.

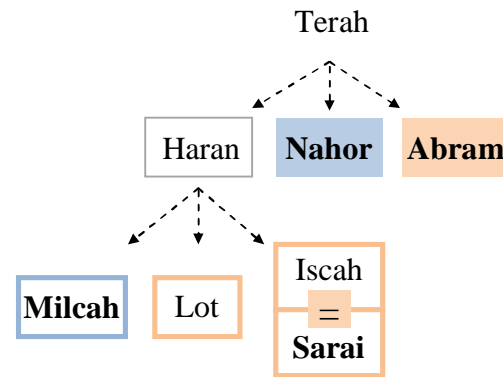

Beside this strange situation (two brothers marrying their nieces), we also learn that Abraham developed a father-son relationship with his nephew Lot.

- Gen 12:5 He took his wife Sarai, his nephew Lot,
- Gen 13:1 So Abram went up from Egypt to the Negev, with his wife and everything he had, and Lot went with him.

It is clear here that, after their father's death, the three children of Haran became the responsibility of their two uncles Abram and Nahor. But why?

Now wouldn't it shed more light on the whole situation if Haran had been the eldest son of Terah, the one born when he was 70 years old? If it was the case we could argue that the two youngest brothers (Nahor and Abraham) assumes the 'unwritten moral obligation' to provide for their oldest brother's posterity.

¹¹³ The structure of Gen 11:29 also imply that Iscah and Sarai are the same one.

¹¹⁴ Doesn't it contradict Gen 20:12 where Abram says that Sarai was his half sister?

- Gen 20:12 And yet indeed she is my sister; she is the daughter of my father, but not the daughter of my mother; and she became my wife. KJV

I asked the opinion of Rabbi David Foreman about this question and here is his answer:

<< its a euphemism of niece; i.e. she is his "sister" in the sense that she is the daughter of his brother. You find a similar expression with Lot, when Abraham says "anashim achim anachnu" we are brothers. It doesn't mean literally brothers, it means we have a "brother like" relationship, in the sense that you are the son of my brother >>

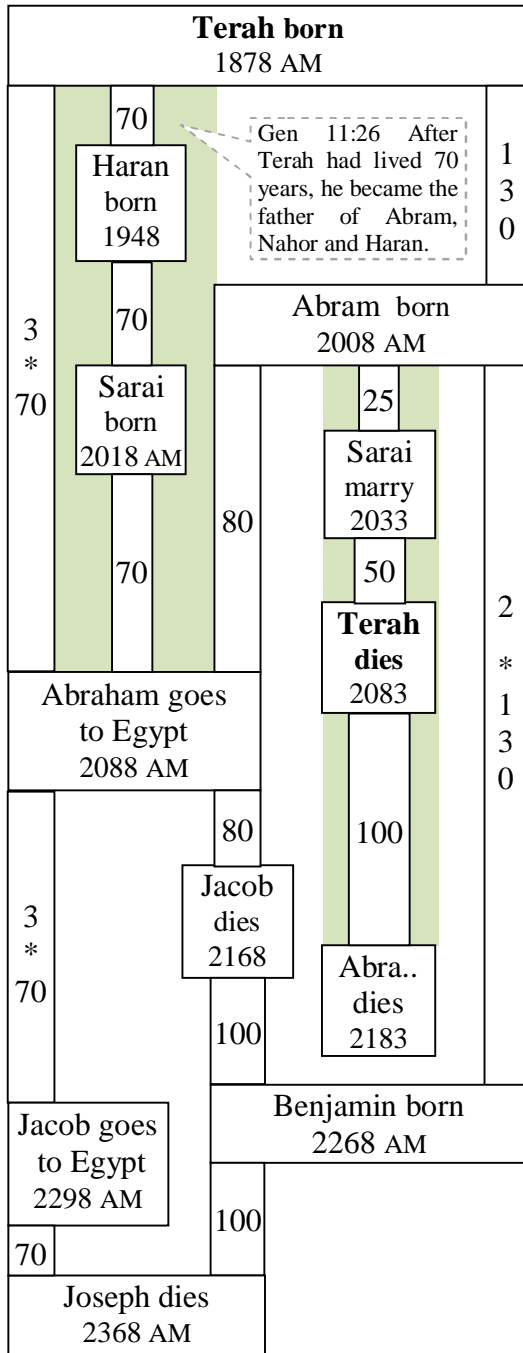
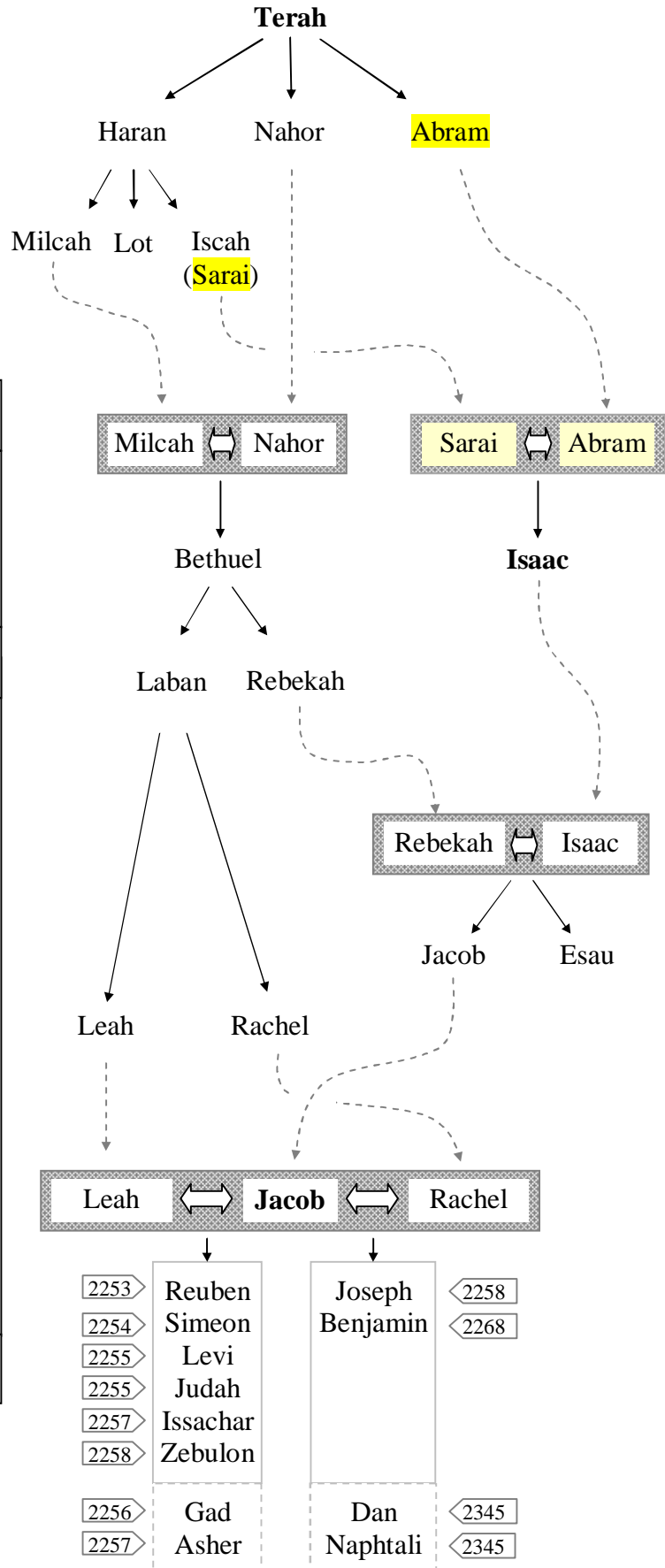

Appendix C Akedah Exodus Crucifixion

We are so familiar with the story of Abraham going to Moriah to ‘bind’ and sacrifice his son Isaac (the Jews call this ‘binding’ AKEDAH), that we never pause to question the incongruity and meaning of some details in the narrative.

- Gen 22:2-4 Then God said, "Take your son, your only son, Isaac, whom you love, and go to the region of Moriah. Sacrifice him there as a burnt offering on one of the mountains I will tell you about." **Early the next morning** Abraham got up and **saddled his donkey**. He took with him two of his servants and his son Isaac. When **he had cut enough wood** for the burnt offering, he set out for the place God had told him about. On the third day Abraham looked up and saw the place in the distance. NIV

→ Why is-it said that Abraham started ‘early’ the next morning?

I read somewhere that “Abraham eagerly awake the next morning anxious to embark on his religious mission”. Really? I think that only a sociopath would have been ‘eager’ to get up that first morning. Was it more pleasing to God that Abraham **express zeal** and show no concern for Isaac instead of some hesitation and perceptible reluctance to start such dreadful and excruciating pilgrimage?

→ Why did Abraham cut the wood 3 days ahead of time?

It doesn’t make sense when you think about it. Why did he bother to bring this heavy and cumbersome payload with him when he knew that on the mountain he was going to, as on any other mountain for that matter, he could have found plenty of wood to feed the fire of the burn offering.

- Gen 22:2 ... and go to the region of Moriah. ... on one of the mountains I will tell you about." NIV

→ Why did Abraham saddle the donkey himself?

Wasn’t it the task of a servant¹¹⁵ to saddle his master’s donkey? Why did Abraham took care of such a meaningless task on one of the worse day of his life? Beside that, isn’t it a little peculiar that the author of Genesis thought it was an essential fact to transmit to us while he kept so much more information under silence?

- Gen 22:3 ... Abraham got up and saddled his donkey. NIV

→ Why did Abraham use only one donkey for an expedition of four people?

- Gen 22:5 "Stay here with the donkey while I and the boy go over there.

¹¹⁵ All the more so since two servants were going to be part of the journey

Abraham had been blessed with a great wealth. He could have provide an animal for everybody.

- Gen 12:16 and Abram acquired sheep and cattle, male and female donkeys, menservants and maidservants, and camels. NIV

The journey between Beersheba and Jerusalem (Mont Moriah) had to cover about 74 km (46 miles). Abraham must have had a very serious raison to decide that most of them would walk the whole distance. Was anybody going to ride the ass? The 115 years old Abraham maybe? Or the young 15 years old Isaac? Probably not one of the servants but then it could have been used to carry the heavy payload of wood, the water, the food, some kind of shelter for the nights. Nobody make a 6 days round trip without the proper supplies. Isn't it a fact that a small caravan of 5 or 6 camels would have been justified to make this journey? Yet Abraham judged otherwise and brought no more than one donkey.



As I have pointed out several elements of the story look peculiar. It would be easy to ignore these oddities if each one was isolated in the text but here they are so closely related that one keep wondering if the text is not trying to tell us something more, something that would be hidden.

Here are the basic facts that don't make sense in the Akedah's story

- Eagerness to start the journey
- Chopping the wood on the first morning and carrying it all the way to Moriah.
- Not asking a servant to saddle the donkey.
- Selecting only one donkey when several would have been handy.

I have given much thought to these discrepancies and I would like to propose the following interpretation which has the merit to clarify and integrate all the facts. **Unfortunately this will also add a new layer of horror to a story that is already awful.**

Let's suppose that after he had putted the saddle on the ass, Abraham took the pieces of wood that he had cut and he attached them on each side of it then asked Isaac to sit and travel on the animal. You are probably thinking that there is nothing unusual at all here. Wasn't it a good way to resolve two problems? Carrying the heavy load of the 'important' wood and pampering his young son for the next three days! This is probably how it happened but if so, Abraham must have been continually miserable. Imagines that you are the old Abraham slowly walking behind the ass, what do you see in front of you if not a constant reminder of the purpose of the whole journey. Indeed, **each time Abraham lifted his eyes** it was not to watch a nice scenery in which the son of his old age was riding on an ass, unfortunately what he saw in front of him was a **moving altar with his son** sitting directly over a pile of burn offering wood. Keep in mind that Abraham was carrying the firestone and the knife generally use to perform an animal sacrifice, and that the goal of the expedition was to sacrifice his only

son on a somewhat similar altar. Abraham had to ‘look up’ each time to see his son on the donkey, a subtle reminder that he had been asked to bring Isaac on the top of a mountain¹¹⁶. Could the scene have been more explicit? It must have drove Abraham constantly mad with grief. The three days journey was never meant to alleviate Abraham distress before the sacrifice took place, on the contrary, every thing was designed to accentuate his mental suffering and test, to the limit, his resolve.

Doesn't it explain, in an obvious way, why three of the elements we found so strange in the story had to be handled the way they were?

- ✓ Abraham cut the wood at the beginning of the journey because it was needed immediately to transform the saddle into an altar.
- ✓ When Abraham lifted the saddle on the donkey at the start of the journey he was then erecting the symbolical altar. No servant could have done that chore for him given its symbolical nature. God had asked Abraham to do the sacrifice, therefore it would have been inappropriate to let anybody else build the altar no matter it was only a type of the real one.
- ✓ Only one animal was part of the voyage because once the ‘symbolical’ altar was erected on it, that animal would become, for the next three days, the focal point of every one following on foot behind it.

Have you notice how the ‘wood’ play such an important role in the whole Akedah story?

1. Abraham cut the wood,
2. Isaac sit over the wood,
3. Abraham place the wood on Isaac,
4. Isaac carry the wood
5. Isaac lay down on the wood.
6. A lamb get caught by the horn in the wood
7. The lamb took the place of Isaac on the wood, and the wood is lighten.

It is the wood of the burn offering, placed on each side of the saddle that creates the mental association with an altar. Of course other elements of the story are needed to accentuate this association. For instance, having Isaac, the future victim, sitting on that saddle, following the animal while carrying the knife and the fire, having the people lift their eyes to see an ‘elevated’ Isaac. And what about the sadness and the silence of Abraham? Don't they bring solemnity to the scene, the way it should be around an altar when a sacrifice is about to be performed?



¹¹⁶ Gen 22:2 sacrifice him there as a burnt offering on one of the mountains NIV

Abraham suffered in silence¹¹⁷ while going through his ordeal. He never complained or lamented to God as he understood that his character was being tested one more time.

- Gen 22:18 and through your offspring all nations on earth will be blessed, because you have obeyed me." NIV

It is true that Abraham could have decide to spare his son at any time and return home immediately. If he had done so, God master plan would have been applied through somebody else¹¹⁸. But Abraham overcame the distress felt during the last three days and he went up the mountain to bound Isaac. This moment marks a turning point in Abraham's determination. If he had not fully intend to sacrifice Isaac, he would never have let Isaac become aware of that goal. As for Isaac, who was never ambushed by his father in any ways, and whose collaboration was essential¹¹⁹, the bounding became a turning point for him too. It doesn't matter how long Isaac took to really make up his mind. It is at the time of the binding, when he offered no resistance, that he fully committed himself to the will of his father¹²⁰.

At the ultimate instant God prevented the killing, He never needed a human sacrifice, it was a test to validate that they both really fear Him.

- Gen 22:1 Some time later God tested Abraham. NIV
- Gen 22:12 Now I know that you fear God, NIV

Let's explain why Abraham got up and left so 'early' that first morning. Instead of associating Abraham's behavior to some eagerness to please God (dismissing his own pain in the process) I propose a more rational interpretation. What would make someone start a journey early if not to make sure that this journey would be completed in a specific period of time?

Abraham had to cover about 46 miles by foot and offer a sacrifice. Suppose it was important that the journey was done in three days¹²¹, no less and no more. The only way to accomplish that was to leave early every morning. This explanation leads to a more interesting question, why three days? And the answer is because the binding of Isaac was a type whose echo would resonate 1870 years later during the crucifixion week.

Many parallels connect the 'binding of Isaac' and the 'crucifixion of Yeshua'.

- Both accepted to die for the sake of their father.
- Both came to Jerusalem (or the vicinity) on a donkey

¹¹⁷ Isaac didn't have any clue of what was going on until he and his father left the two servants behind

¹¹⁸ Est 4:14 relief and deliverance for the Jews will arise from another place, but you and your father's family will perish. NIV

¹¹⁹ A 115 years old Abraham wouldn't have been able to bind a resisting 15 years old Isaac.

¹²⁰ Because Isaac, at that instant, submitted to his father's will he would receive all the blessing (notice that a ram took Isaac's place on the **altar**). Jacob however, got all Isaac's blessing by resisting his father's will. (notice how Jacob took Esau's place at Isaac's **couch**. Ref Gen 27:19 please **sit up**..).

¹²¹ Gen 22:4 On the third day Abraham looked up and saw the place in the distance. NIV

- Two servants shared the first part of Isaac's journey, two robbers shared the last part of Yeshua journey. (Gen 21:3, Luke 23:32)
- Both carried the wood for the sacrifice on their back. (Gen 21:6, John 19:17)
- Both were bound and lead to a specific location.
Isaac (Gen 22:9) / Yeshua (John 18:12)
- At the last instant, the angel call out from heaven, "**Abraham, Abraham**" (Gen 22:11). At the last instant, Yeshua cried out to heaven, "**My God, my God**" (Mark 15:34)
- Abraham grieve for three days in anticipation of sacrificing Isaac. (He must have thought that he was going to do it all the time)
The apostles grieved for three days following the sacrifice of Yeshua. (They didn't believe that he would resurrect)
- Both grieving ended unexpectedly when an unanticipated resurrection (symbolical for Isaac, real in Yeshua's case) took place.
- A ram, whose head was caught 'IE *surrounded*' in a ticket of thorns, replaced Isaac; Yeshua, with a crown of thorns around his head, became the Passover's Lamb
- Both were sacrificed on an altar.
 - Abraham built an altar 'of stones' for Isaac (Gen 22:9)
 - During 3 hours, Yeshua was stoned almost to death while nailed to the tree. The accumulation of small pebble at the foot of the tree symbolically transformed the site into an altar.

The last parallel could be surprising and very shocking to most people therefore I will digress to explain a little more about that.

Was Yeshua nailed to a tree?

- Acts 5:30 The God of our fathers raised Jesus from the dead-whom you had killed by hanging him on a tree. NIV
- Acts 10:39 They killed him by hanging him on a tree, NIV
- 1 Peter 2:24 He himself bore our sins in his body on the tree, NIV
- Gal 3:13-14 Christ redeemed us from the curse of the law by becoming a curse for us, for it is written: "Cursed is everyone who is hung on a tree."

In his book 'Secrets of Golgotha' Ernest L. Martin argue that Yeshua and the two robbers were not only crucified on a tree, they were crucified on the same tree¹²².

¹²² If one robber was crucified on a separate cross on Jesus' left side, and the other robber on another cross on his right (so there were three crosses placed side by side with one another with Jesus situated in the middle), we then have a major problem with the death of the two robbers. This is because the soldiers killed first the two robbers and last of all they came to Jesus in the middle to slay him. Being in the middle should have made Jesus the second to be killed. There is no reason to assume that it was more convenient to go from the first 'cross' to the third one and then come back to the one in the middle. However if the three prisoners were around a common tree then the soldiers acted in a natural way.

In her amazing book¹²³ 'A Book of Evidence: The Trials and Execution of Jesus' Nancy L. Kuehl argues that the yoke carried by Simon of Cyrene (Mark 15:21) was not a Roman cross neither the cross beam of a cross. It was a piece of wood that could be fitted around a neck like the yoke of an ox. Yeshua's hands were later nailed to that yoke before it was lifted and fixed to a living tree. According Mrs. Kuehl Yeshua's feet were not nailed to anything and this is why in John 20:20 Yeshua identified himself by showing only the holes in his hands and his side. The words 'and feet' in Luke 20:40 don't appear in the early Greek manuscript as they are late addition to conform to a crucifixion on a Roman cross.

Was Yeshua really stoned?

Look at some of the facts. *He predicted that he would be stoned (Matt 23:37, Luc 13:34) and on several occasion the people tried to do it without success (John 8:59, 10:31, 11:8). It could only mean that the prediction was fulfilled at his death.* Keep in mind that Yeshua was living in a Jewish culture at a time when Caiaphas (the high priest) and his father in law Annas (see John 18:13) were very powerful in Jerusalem (a very corrupted priesthood). They had Yeshua brought in front of the Sanhedrin (Jewish criminal court) with a charge of blasphemy. According to the law someone guilty of blasphemy should be stoned to death. (*Lev 24:16 "And he that BLASPHEMES the name of the LORD, he shall surely be put to death, and all the congregation shall certainly STONE HIM*). Pilate didn't want to condemn Yeshua as he found no fault in him¹²⁴ but under pressure he had to surrender him to the accusers. (Luke 22:24, John 19:6). Yeshua was condemned under the Jewish law.

Many who came near the cross still remembered what he had said in the past (*Matt 27:39-40 Those who passed by hurled insults at him, shaking their heads and saying, ..., save yourself! Come down from the cross, if you are the Son of God!" NIV*)

There are documented cases of people who survived a full week on the cross. Why did Yeshua die after 6 hours but not the two thieves that were crucified with him? (John 19:32-33) Pilate was so surprised when he learned that He was already dead that he sent a centurion to verify the fact. (see Mark 16:44-45.) The stoning more than anything else would explain Yeshua's quick death.

Nancy Kuehl has the following comment about Ps 22:16-17

- Ps 22:16-17 Dogs have surrounded me; a band of evil men has encircled me, they have pierced my hands and my feet. I can count all my bones; NIV

“the only manner in which a man's bones might view him is if they were no longer enclosed in flesh --- **the word 'pierced' doesn't mean 'pierce through'** The Hebrew word here is 'aryeh' ... and it means 'to pluck away skin' ... a stone, especially if sharp, would have the same effect.”

John 19:32-33 Then came the soldiers, and brake the legs of the first, and of the other which was crucified with him. But when they came to Jesus, and saw that he was dead already, they brake not his legs: KJV

¹²³ If I had to recommend a single book about the crucifixion that would be the one

¹²⁴ Matt 27:24 he took water and washed his hands in front of the crowd. "I am innocent of this man's blood," he said. "It is your responsibility!" NIV

Luke 23:20 Wanting to release Jesus, Pilate appealed to them again. NIV

And what about the appearance of Yeshua after the resurrection, doesn't it conform to a man that have been stoned?

- Isa 52:14 Just as there were many who were appalled at him-- his appearance was so **disfigured** beyond that of any man and **his form marred beyond human likeness**-- NIV

Wouldn't the 'stoning' explain more than anything else why his followers or apostles weren't able to recognize him?

- John 20:14 At this, she turned around and saw Jesus standing there, but she did not realize that it was Jesus. NIV
- John 20:27 Then he said to Thomas, "Put your finger here; see my hands. Reach out your hand and put it into my side. Stop doubting and believe." NIV

Isn't it peculiar that the land became dark at the exact midpoint of the 6 hours that Yeshua was nailed to the tree (Mark 15:25,33-34)? Why didn't God sent this unnatural darkness right at the start of the crucifixion (09h00 AM) or at the very end of it (03h00 PM) when Yeshua died? In both cases the emphasis would have been more 'dramatic', don't you think? Could the removal of the light at that specific time of the day be justified? I believe the purpose of sending the darkness was to make the stoning of His 'beloved son' impossible to be carried on and force the abusers to **retreat in fear**.

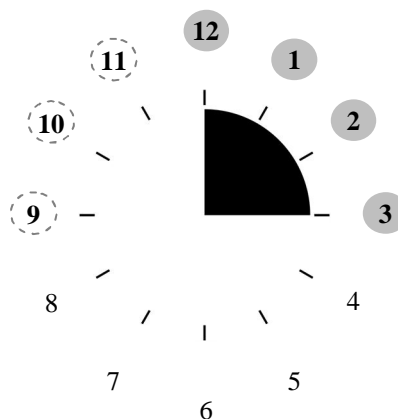

Notice the following two interesting parallels:

- ✓ In the garden of Eden, the first thing Adam and Eve did after the original sin was to **hide in fear**¹²⁵. And 3993 years later, if I am right, just before Yeshua gave his life for that very same 'original sin' people were also **retreating in fear**.
- ✓ Let's start with Melito of Sardis very appropriate quote¹²⁶ :
'Just as from a tree came sin, so also from a TREE came salvation' (New Fragment, III. 4)

In Eden, **the snake** incited Adam and Eve to eat a fruit from the tree and to sin against God. And who was behind the scene and condemned Yeshua to be hanged on the tree? The Pharisees¹²⁷ (and the Sadducee) whom Yeshua had associated earlier in his ministry to a bunch of vipers (**Snake**) belonging to Satan¹²⁸

¹²⁵ Gen 3:8-10 ... and they hid from the LORD God among the trees of the garden.

¹²⁶ I learn about this quote in the article "The Messiah's Crucifixion Tree" of John D. Keyser

¹²⁷ Matt 3:7 But when he saw many of the Pharisees and Sadducees coming to where he was baptizing, he said to them: "You brood of vipers! Who warned you to flee from the coming wrath? NIV

¹²⁸ John 8:44 You belong to your father, the devil, and you want to carry out your father's desire. He was a murderer from the beginning, not holding to the truth, for there is no truth in him. NIV

Exodus.

The Bible is clear, the killing of the Passover lamb, was to be done on the 14th day of the first month. (Ex 12:6, Lev 23:5¹²⁹, Num 9:3¹³⁰, Josh 5:10¹³¹, 2 Chr 35:1¹³²). What is less obvious is to establish when the Passover lamb was to be killed during that day: a little time after sunset at the start of the day or some time before sunset at the end of the day?

The Bible's day, as we all know, starts at Sun Set and ends at the next Sunset.

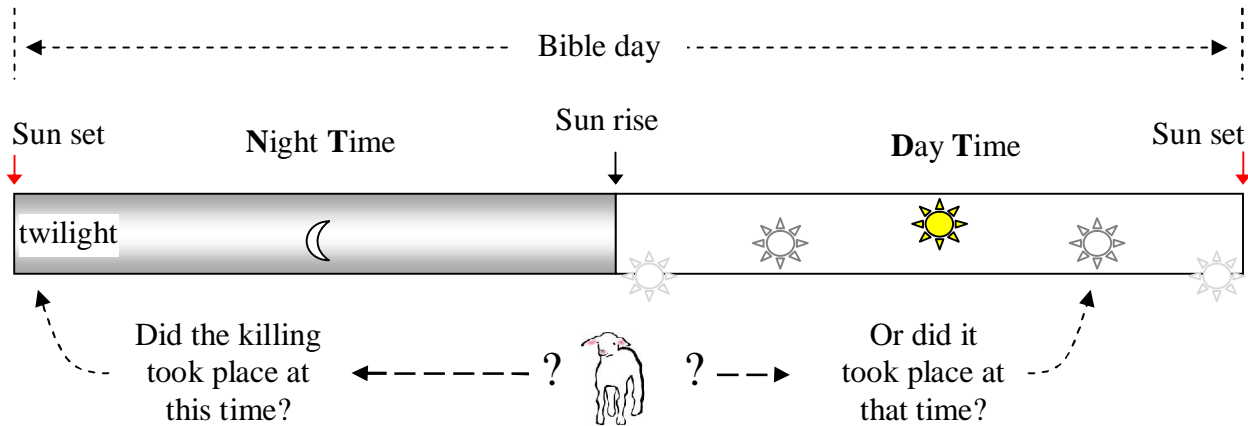

Ex 12:6 And ye shall keep it [*the lamb*] up until the fourteenth day of the same month: and the whole assembly of the congregation of Israel shall kill it **in the evening**. KJV

It is said here that the lamb must be killed on the 14th day in the ?evening?. The Hebrew for the words "in the evening" is **beeyn haa'arbaayim** which literally translate **between the two evenings** (B2E).

There are two schools of thought for the exact meaning of 'between the two evenings'

First solution: Most of today scholars (and late Samaritans) believe this *idiom* means the time between sunset and complete darkness (about 45-minute) at the very beginning of the Jewish day.

Second solution: According to modern Jewish rabbis, the Talmud and the late Pharisees, B2E target the period when the sun begin to decline 'noon' until sunset. (3 o'clock would be right in the middle of the period).

From a Bible point of view, only one understanding can be right..

¹²⁹ Lev 23:5 The LORD's Passover begins at twilight on the fourteenth day of the first month. NIV

¹³⁰ Num 9:3 Celebrate it at the appointed time, at twilight on the fourteenth day of this month NIV

¹³¹ Josh 5:10 On the evening of the fourteenth day of the month, while camped at Gilgal on the plains of Jericho, the Israelites celebrated the Passover. NIV

¹³² 2 Chron 35:1 Josiah celebrated the Passover to the LORD in Jerusalem, and the Passover lamb was slaughtered on the fourteenth day of the first month. NIV

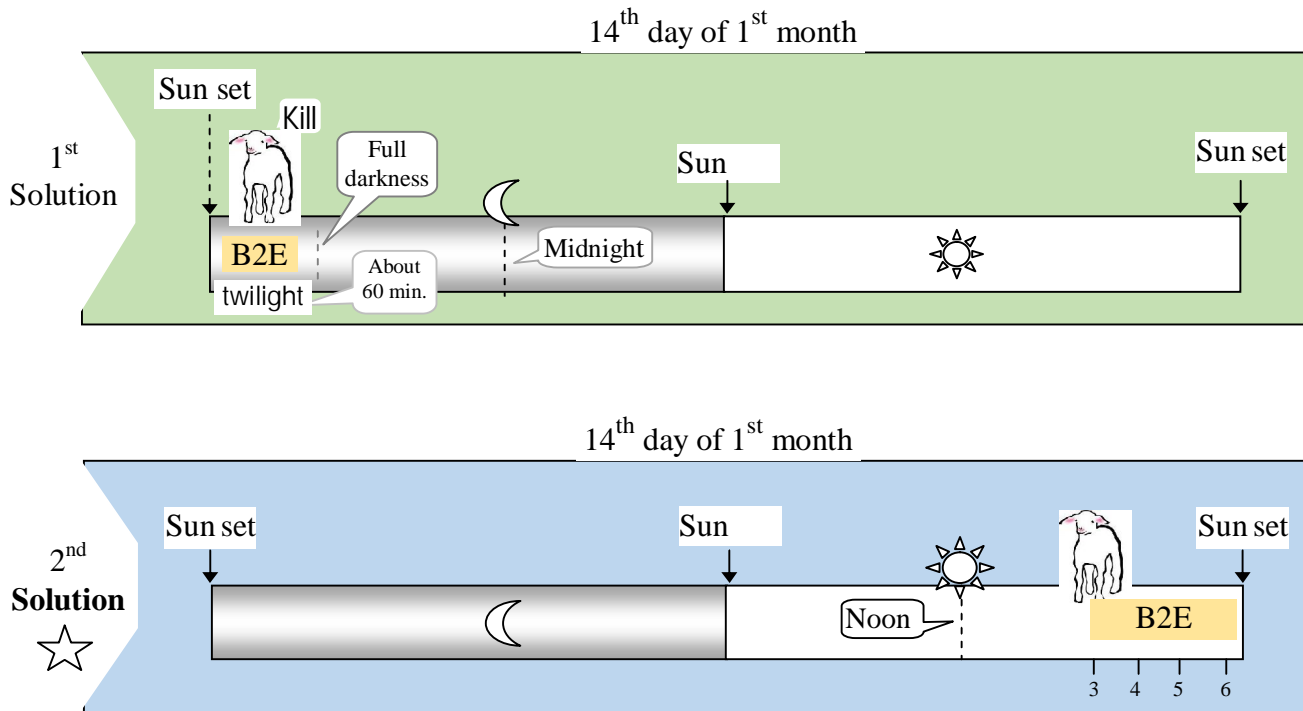

The following three cases will show us that there is only one good way to understand the timing meant by the expression between the two evenings 'B2E' and it is the one presented in solution #2 (in afternoon, before Sunset).

First case: In the book of Numbers the Bible give instructions to sacrifice two lambs every day.

- Num 28:3-4 And thou shalt say unto them, This is the offering made by fire which ye shall offer unto the LORD; two lambs of the first year without spot day by day, for a continual burnt offering. The one lamb shalt thou offer in the morning, and the other lamb shalt thou offer at even; KJV

Note: 'even' is translated from the Hebrew "haa`arbaayim" which means 'between the two evenings'

The first lamb was to be sacrificed in the morning. The second lamb would be sacrificed 'between the evening'. In order to have both lambs sacrificed the same day, the second lamb had to be sacrificed **before** the next sunset. If the expression 'between the two evenings' had meant after sunset then the second lamb would have been sacrificed in the part of the day that belong to the next one. (Remember in the Bible each new day starts at Sunset). Of course I grant you that in the end two lambs are sacrificed every day. But if you give any importance to the sequence used in the Bible's text, it clearly say two lambs every day, with the first one in the morning. Whatever the expression used, the second one had to be before next sunset.

Second case: Here Flavius Josephus describe that hundreds of thousands of lambs were slaughtered before sunset (Solution 2).

"So these high priests, upon the coming of their feast which is called the Passover, when they slay their sacrifices, from the ninth hour to the eleventh, but so that a company of not less than ten belong to every sacrifice, (for it is not lawful for them to feast singly by themselves,) and many of us are twenty in a company, found the number of sacrifices was two hundred and fifty six thousand five hundred;" (The Complete Works of Josephus,

Flavius Josephus, translated by Whiston, *La Sor, Wars of the Jews, Chapter 9 part 3, page 588*)

Clarification: Counting from 6 o'clock in the morning, the 9th hour to the 11th should be understood as from **3 o'clock to 5 o'clock in the afternoon**.

Third case: The following verses tell us that Elijah wait for the time **of the Evening sacrifice** before he intervene at Mount Carmel. As you will see, the ‘evening sacrifice’ couldn’t have refer to the period after Sunset.

- 1 Kings 18:29-30 Midday passed, and they continued their frantic prophesying until the time for the evening sacrifice. But there was no response, no one answered, no one paid attention. Then Elijah said to all the people, "Come here to me."

Now notice what took place once the time of the ‘evening sacrifice’ was reached and while there was still light to see around:

1. Repaired Yahweh’s altar 1 King 18:30-32
2. Dug a trench around the altar 1 king 18:32
3. Laid wood on the altar 1 King 18:33
4. Cut up the bull and laid it on the wood 1 King 18:33
5. Had several jars filled of water three time and emptied on the altar
6. Prayer to Yahweh 1 King 18:36
7. Elijah had the 450 prophets captured and brought down from Mount Carmel to the Kishon Valley where they were killed. 1 King 18:40
8. Send Ahab away 1 King 18:41
9. Go back to Mount Carmel from the Kishon valley 1 King 18:42
10. Send the servant 7 times to **SEE** if the rain was coming 1 King 18:43-44

Now, could have all these actions took place in the short 45 to 75 minutes between Sunset and total darkness? In the end, would it have been possible to Elijah’s servant to distinguish (in an almost dark sky) a cloud not bigger than an hand (1 King 18:44)? However, if the time of the ‘evening sacrifice’ was meant to be in the afternoon, similar to the expression ‘between the two evenings’, there would have been plenty of time to accomplish the previous 10 actions and see a small cloud in a bright late afternoon sky.

Let’s build a timeline

- Ex 12:3 Tell the whole community of Israel that on the tenth day of this month each man is to take a lamb for his family, one for each household.

| | | | | |
|-----------------|----------|----------|----------|--------------------------------|
| Nisan 10 | Nisan 11 | Nisan 12 | Nisan 13 | Nisan 14 |
| Choose the lamb | | | | Kill the lamb in the afternoon |

Ex 12:6 take care of them until the fourteenth day

The day after the killing of the lamb was the first day of unleavened bread.

- Num 28:16-19 On the fifteenth day of this month there is to be a festival; for seven days eat bread made without yeast. On the first day hold a sacred assembly and do no regular work. NIV
- Lev 23:6-7 On the fifteenth day of that month the LORD's Feast of Unleavened Bread begins; for seven days you must eat bread made without yeast. NIV

Here we learn that the Unleavened bread would start on the 15 for 7 consecutive days.



| 7 days festival of the unleavened bread | | | | | | | | | | | |
|---|----|----|----|--------------------------------|-------------------------------|----|----|----|----|----|------------------------------|
| Nisan 10 | 11 | 12 | 13 | Nisan 14 | Nisan 15 | 16 | 17 | 18 | 19 | 20 | Nisan 21 |
| Chose the lamb | | | | Kill the lamb in the afternoon | First day of Unleavened bread | | | | | | Last day of Unleavened bread |

Let's look at another verse:

- Ex 12:18-19 In the first month you are to eat bread made without yeast, from the evening of the fourteenth day until the evening of the twenty-first day. For seven days no yeast is to be found in your houses.

It is quite confusing, now the unleavened bread should start on the evening of the 14, which logically points to the beginning of the 14 (remember that a day starts at sunset, therefore darkness comes before the daylight's part of the day). But Ex 12:18 doesn't really say 'on the evening of the 14th day' it says 'at even on the 14th day'. Is it possible that 'at even' here simply means toward the end of the afternoon? If it is the case Ex 12:18-19 is only telling the Israelites to stop eating bread with yeast a little time before the end of the day in anticipation of the start of the Festival of the unleavened bread. As expected, the Bible doesn't contradict itself.

Nisan 14 & 15

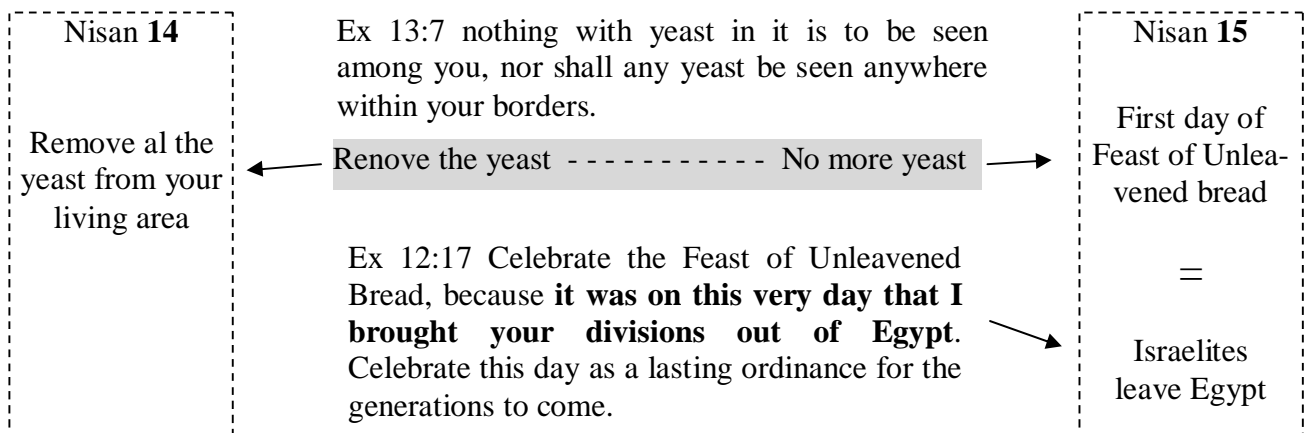

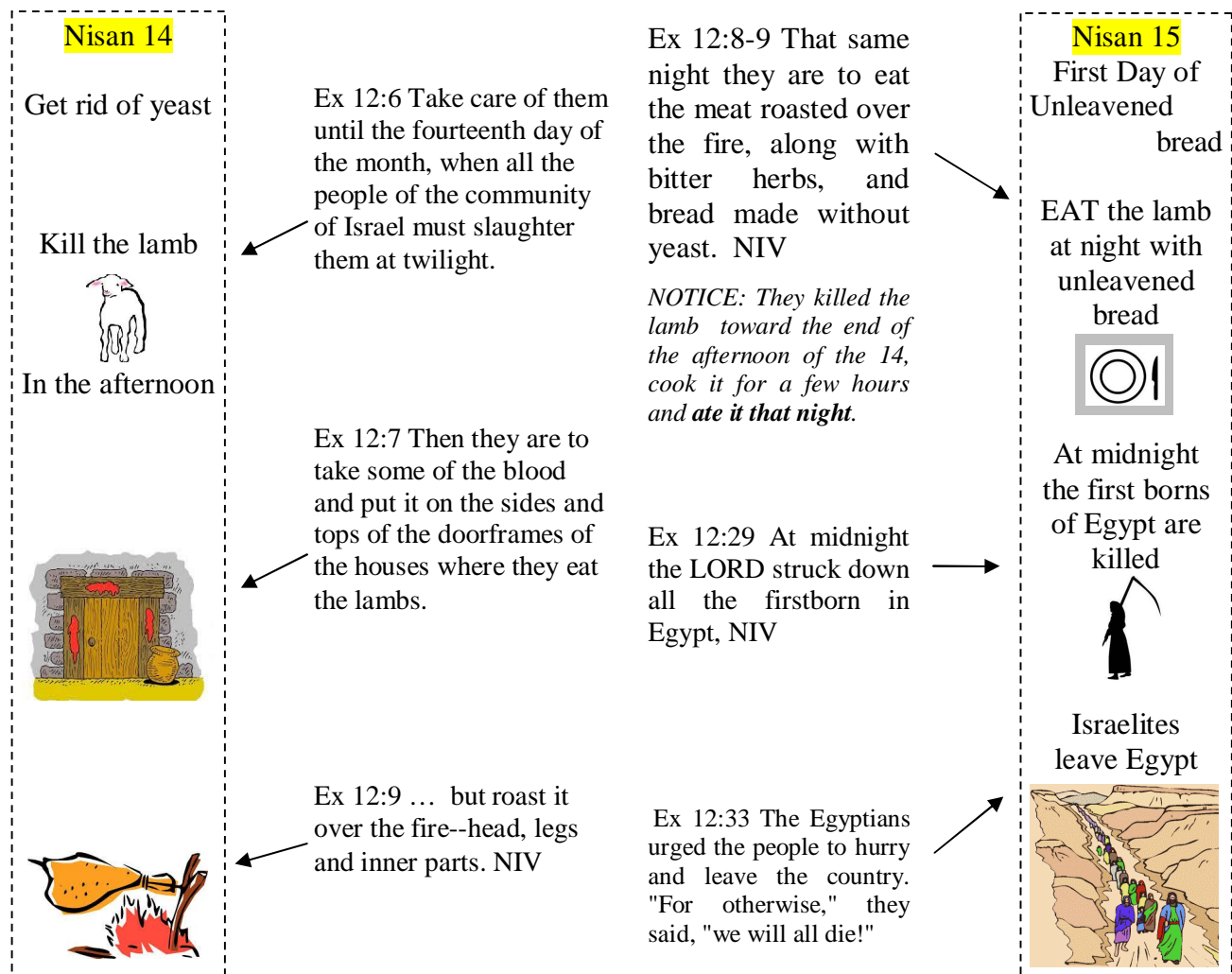

Notice this important point:

The Israelite were told to eat the passover lamb with bread without yeast (Ex 12:8). For obvious reason that meal was taken in the early hours on the night of the 15, ie a few hours after the killing of the lamb in the afternoon of the 14. It would be quite peculiar and incoherent if the passover meal, whose lack of yeast is among the important feature, would have been taken just before the start of a 7-day feast whose main characteristic was a total absence of leavened bread.

- Lev 23:6 On the fifteenth day of that month the LORD's Feast of Unleavened Bread begins; for seven days you must eat bread made without yeast.

The Passover, the phantom day of the Bible.

Any study of the Passover must start with this important distinction of the following 3 elements.

- #1. **The original 'Pass over' meal.** A few hour before¹³³ the first born were killed, and on the same day (Nisan 15), the Israelites ate a special meal (meat of a lamb roasted over fire, bitter herbs, bread without yeast, sandal on the feet, staff in the hand. See Gen

¹³³ Ex 12:8 That same night they are to eat the meat roasted over the fire, along with bitter herbs, and bread made without yeast. NIV

12:8,11). They ate that meal while they were secluded in their house. The blood of the Lamb they ate had been used to seal the door of that house.

- #2. **The 'passing over' in Egypt** that occurred around midnight on the 15 of Nisan;
- Ex 12:12-13 "On that same night [night of Nisan 15 at midnight¹³⁴] I will pass through Egypt and strike down every firstborn--both men and animals--and I will bring judgment on all the gods of Egypt. I am the LORD. The blood will be a sign for you on the houses where you are; and when I see the blood, I will **pass over** you. No destructive plague will touch you when I strike Egypt. NIV
- #3. **The 'future' observance** to commemorate the 'passing over' in Egypt. They would have to kill a lamb (that was done until the end of the second Temple) in the afternoon of the 14, have a meal early in the evening of the 15. The meal would consist of the Lamb, bitter herbs, bread without yeast. The people would do it to remember¹³⁵ that God had 'pass over' and spared their house while He stroke down the Egyptian.

NOTE: The killing of the lamb was done in the afternoon of the 14. The original 'pass over' meal took place in the early evening of the 15. The killing of the first born happened at midnight on the 15. The thing to remember is that the OBSERVANCE (memorial) for the 'pass over' has two parts: The killing of the lamb on the afternoon of the 14 and the meal in the early evening of the 15.

If you paid enough attention when reading every verse that mention the word 'Passover' you will discover something quite surprising. The Bible talk about the Passover's sacrifice¹³⁶, feast¹³⁷, offering¹³⁸. But most of the time, even though the Hebrew Bible uses the word 'Passover' alone it does imply one of these: lamb¹³⁹, meal¹⁴⁰, sacrifice¹⁴¹ or both¹⁴² (lamb and sacrifice). **The Bible never uses the expression 'Passover day'**. Then why do everybody assume that 'Passover' designs the whole day of 14 of Nisan? The answer is probably because the following misunderstood three verses :

Numbers 28:16 Numbers 33:3 Ezek 45:21

¹³⁴ Ex 12:29 At midnight the LORD struck down all the firstborn in Egypt, NIV

¹³⁵ Ex 12:26-27 And when your children ask you, 'What does this ceremony mean to you?' 27 then tell them, 'It is the Passover sacrifice to the LORD, who passed over the houses of the Israelites in Egypt and spared our homes when he struck down the Egyptians.'" NIV

¹³⁶ Ex 12:26-27 'What does this ceremony mean to you?' 27 then tell them, 'It is the Passover sacrifice to the LORD, NIV

Deut 16:2 And you shall offer the passover sacrifice to the LORD your God, from the flock or the herd, RSV

¹³⁷ Ex 34:25 and do not let any of the sacrifice from the Passover Feast remain until morning. NIV

¹³⁸ 2 Chron 35:9 the leaders of the Levites, provided five thousand Passover offerings NIV

¹³⁹ Ex 12:21 Then Moses called for all the elders of Israel, and said unto them, Draw out and take you a lamb according to your families, and kill the passover [LAMB]. KJV

Deut 16:5 You must not sacrifice the Passover [LAMB] in any town the LORD your God gives you NIV

2 Chron 30:15 Then they killed the passover [LAMB] on the fourteenth day of the second month: KJV

¹⁴⁰ Ex 12:43 And the LORD said unto Moses and Aaron, This is the ordinance of the passover[MEAL] : There shall no stranger eat thereof: KJV

¹⁴¹ Ex 34:25 Thou shalt not offer the blood of my sacrifice with leaven; neither shall the sacrifice of the feast of the passover[SACRIFICE] be left unto the morning. KJV

¹⁴² Num 9:12 They must not leave any of it [LAMB] till morning or break any of its [LAMB] bones. When they celebrate the Passover[sacrifice] , they must follow all the regulations. NIV

Num 28:16 "On the fourteenth day of the first month the LORD's Passover is to be held. NIV
 Now let me prove¹⁴³ to you that Num 28:16 is saying without any doubts that:
 "On the 14th day ... the Lord's Passover **Lamb** is to be offered."

| Notice first that in Num 28:1-2, God tells Moses what food should be offered over fire; Then let's review the content of Num 28:3-35 | | |
|---|--------------------------------------|--|
| Numbers | The offering | |
| 28:3-8 | Continual burnt offerings | 2 lambs daily |
| 28:9-10 | Sabbaths | 2 lambs |
| 28:11-15 | New moons | 2 bullocks, 1 ram, 7 lambs, 1 goat |
| 28:16 | The fourteenth day | the Passover |
| 28:17-25 | Feast of Unleavened Bread (each day) | 2 bullocks, 1 ram, 7 lambs, 1 goat |
| 28:26-31 | First Fruits | 2 bullocks, 1 ram, 7 lambs, 1 goat |
| 29:1-6 | Feast of Trumpets | 1 bullock, 1 ram, 7 lambs, 1 goat |
| 29:7-11 | Day of Atonement | 1 bullock, 1 ram, 7 lambs, 1 goat |
| 29:12-34 | Feast of Tabernacles (each day) | 13 bullocks (number decreases by 1 each day of the feast), 2 rams, 14 lambs, 1 goat |
| 29:35 | Last great day | 1 bullock, 1 ram, 7 lambs, 1 goat |
| Isn't it obvious, that when Num 28:16 says: 'The 14 th day – the Passover' it could only mean that on the 14 th day the Israelites had to sacrifice a Lamb (call here the 'Passover'). The verse has nothing to do with a so called Passover day on Nissan 14. | | |

Num 33:3 The Israelites set out from Rameses on the fifteenth day of the first month, the day after the Passover. NIV

"And they journey from Rameses in the first month, on the fifteenth day of the first month, on the morrow of the Passover have the sons of Israel gone out with a high hand, before the eyes of all the Egyptians" (Num 33:3, Young's Literal Translation)

When it is understood that the word 'Passover' is here a reference to the real event 'the passing over' in Egypt, which happened at midnight on the night of the 15th day of Nissan, the morrow can only be a few hours later, on the morning of the same day (15 of Nissan).

Ezek 45:21 "In the first month on the fourteenth day you are to observe the Passover, a feast lasting seven days, during which you shall eat bread made without yeast. NIV

But see here how the Tanak translate the same verse in two parts:

"On the fourteenth day of the first month you shall have the Passover sacrifice;
 and during a festival of seven days unleavened bread shall be eaten." (Eze 45:21, Tanakh)

None of the last three verses can be used to prove that Nissan 14 is the 'Passover day',

The Passover could be many things depending of the context where is mentioned but it has never been meant to point to a whole day.

¹⁴³ It is very confusing to try to understand how the Bible uses the word 'Passover'. I learn a great deal reading Ray Foucher very useful e-book 'Is Nissan 14 the Feast of Passover?' The e-book give an exhaustive list of every occurrence of the word 'Passover' and explains how to understand each one of them. His explanation on Num 28:16 and reproduced on this page, is ome more proof that the Bible is full of surprise for those who study it.

Back to Abraham.

I gave earlier a list of many parallels (page 236) that connect the ‘binding of Isaac’ and the ‘crucifixion of Yeshua’. I would like to elaborate on the parallel of the ‘three days’, I believe we have here nothing less than the key to understand the timing between the crucifixion and the resurrection of Yeshua.

Here are a sequence of events that occurred over several days:

- Abraham is told to go to the region of Moriah
- The following day the expedition start
- On the third day Moriah is reached and the sacrifice take place

Does this
? sequence spread
over 3 or 4 days

Did the words ‘on the third day’ refer back to the day of departure or to the day Abraham was asked to go to Moriah? If the ‘third day’ include the day Abraham was asked to go to Moriah then it would mean that the travelling took place in only two days!

| First day | Second day | Third day |
|---|-----------------------------------|---|
| Abraham is asked to go to Moriah | Araham and others leave Beersheba | Moriah is reached Sacrifice take place |
| Did Abraham walked 46 miles in two days ? | | |

The sequence on the left is impossible.
Abraham couldn't have walk 46 miles and still have time to go up the mountain, build an altar and offer the Ram in sacrifice

On the other hand the ‘third day’ could still refer back to the day Abraham was asked to go to Moriah but with the understanding that the preposition ‘after’ is inferred from the text.

On the day before he left, Abraham was told to go to Moriah. The following days (day #1, #2, #3) he traveled the distance. On the third day (IE day #3) ‘after he was asked to go to Moriah’, his son was symbolically resurrected.

| | | First day <i>day #1</i> | | Second day <i>day #2</i> | | Third day <i>day #3</i> | |
|--|----|----------------------------|--------------------|-----------------------------|--------------------|---|--------------------|
| N. | D. | Nighttime | Daylight | N. | D. | Nighttime | Daylight |
| Sometime during the day Abraham is asked to go to Moriah | | | Leave early & Walk | | Leave early & Walk | | Leave early & walk |
| | | | | | | <div style="border: 1px solid black; padding: 2px; display: inline-block;">Sacrifice on the altar late that day</div> | |
| Three days journey (they had to cover 46 miles) | | | | | | | |

Yeshua was put on the cross (tree) during the day of preparation and he died later in the afternoon.

- John 19:31 Now it was the day of Preparation, and the next day was to be a special Sabbath. Because the Jews did not want the bodies left on the crosses during the Sabbath, they asked Pilate to have the legs broken and the bodies taken down. NIV

What was the ‘special Sabbath’ mentioned in John 19:31? During Exodus Moses had instructed the Israelites about 7 special ‘holy’ convocations (high Sabbath).

| Spring Feasts | |
|-------------------------------|-----------|
| First day of unleavened bread | Lev 23:6 |
| Last day of unleavened bread | Lev 23:8 |
| Feast of weeks (Harvest) | Lev 23:21 |

| Fall Feasts | |
|----------------------------|-----------|
| Feast of Trumpet | Lev 21:24 |
| Day of atonement | Lev 21:27 |
| First day of Tabernacles | Lev 21:35 |
| Heighth day of Tabernacles | Lev 21:36 |

The preparation day was the day before the ‘first day of unleavened bread’. It was called ‘preparation’ because during that day the Israelites would search for any trace of ‘yeast’ (see Ex 13:7) in the house and make sure it was removed before the start of the first day of unleavened bread.

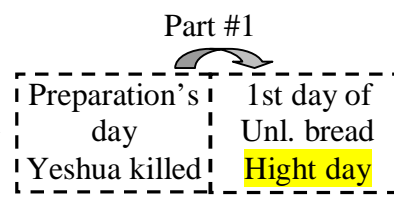

Yeshua was resurrected on the first day of the week.

- Matt 28:1 28:1 After the Sabbath, at dawn on the first day of the week, Mary Magdalene and the other Mary went to look at the tomb.

which is to say that the day before was the weekly Sabbath.

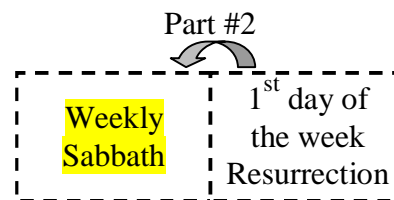

The preceding two partial timelines (#1 & #2) allows us to elaborate the next three timelines scenarios of what could have happened between the crucifixion and the resurrection. (To make it easier I will transpose our traditional days of the week naming convention (Sunday ...) into these timelines. Keep in mind that a day in the Rabbinic Hebrew calendar runs from sunset to sunset. In each scenario the first day of the week is Sunday, therefore we can go backward and name each preceding days, we also know that the ‘preparation day’ was Nissan 14, thus we can move forward and put a date on each succeeding day)

Scenario 1 1st day of Unleavened bread and Weekly Sabbath coincide

| | | | | | |
|------------------------------------|---------|--|---------|--|---------|
| Friday Nissan 14 | | Saturday Nissan 15 | | Sunday Nissan 16 | |
| Nighttime | Daytime | Nighttime | Daytime | Nighttime | Daytime |
| Preparation's day Yeshua killed | | 1st day of unl.. bread High day + Weekly Sabbath | | 1 st day of the week Resurrection | |

This scenario won't be retained. It fails to provide **3 periods of daytime & 3 period of nighttime** as required by

Matt 12:40 so the Son of Man will be three days and three nights in the heart of the earth.

Scenario 2 One day is added between ‘First day of Unleavened bread’ and ‘Weekly Sabbath’.

| | | | | |
|------------------------------------|---|----------------------------------|-----------------------|---|
| Wednesday Nissan 14 | Thursday Nissan 15 | Friday Nissan 16 | Saturday Nissan 17 | Sunday Nissan 18 |
| Preparation's day Yeshua killed | 1st day of Unleavened bread High day | <i>Ordinary work day</i> | Weekly Sabbath | 1 st day of the week Resurrection |

Although there are three full days between the Crucifixion and the Resurrection I won't retain this scenario for the following two reasons.

- A) According Mark 16:1¹⁴⁴ some women came to the tomb on Sunday morning with spices to anoint Yeshua. They were prevented to do it after the crucifixion on this ‘hypothetical’ Wednesday because they didn't have enough time to perform the task before the start of the ‘High Sabbath’. Here is the problem. Nothing could justify that they didn't do it on the following Friday. Many would argue that they spent the whole day (Friday) to buy and prepare the spices. This argument has little weight considering that Nicodemus managed¹⁴⁵ to find 75 pound of a mixture of myrrh and aloes and apply then on Yeshua body in the few hour before sunset at the end of Wednesday.
- B) To subscribe to this scenario we have also to believe that the women (previous point) came to the tomb to anoint someone that had been dead for four days. Who could see any relevance in such a futile action? A few weeks before, Martha had warned¹⁴⁶ Yeshua against coming near Lazarus' tomb because he had been dead for four days and the smell was strong.

Scenario 3 The 1st of Unleavened bread and the Weekly Sabbath are two successive days.

| | | | |
|--|---|-----------------------|--------------------------------------|
| Thursday Nissan 14 | Friday Nissan 15 | Saturday Nissan 16 | Sunday Nissan 17 |
| Preparation's day Yeshua killed Spices brought & prepared | 1st day of Unleavened bread High day (Sabbath) | Weekly Sabbath | 1 st day of the week |
| | | | Nighttime Re-sur- rec- tion |
| <p>Luke 23:56 Then they went home and prepared spices and perfumes. But they rested on the Sabbath in obedience to the commandment</p> <p>Luke 24:1 On the first day of the week, very early in the morning, the women took the spices they had prepared and went to the tomb.</p> | | | |

Matt 28:1 After the Sabbath..
In the Greek manuscript the word ‘Sabbath’ is in its plural form. This would be logical (in the context of this scenario) given that **two successive Sabbaths had just took place.**

¹⁴⁴ Mark 16:1-3 When the Sabbath was over, Mary Magdalene, Mary the mother of James, and Salome bought spices so that they might go to anoint Jesus' body. 2 Very early on the first day of the week, just after sunrise, they were on their way to the tomb NIV

¹⁴⁵ John 19:39-40 Nicodemus brought a mixture of myrrh and aloes, about seventy-five pounds. 40 Taking Jesus' body, the two of them wrapped it, with the spices, in strips of linen. This was in accordance with Jewish burial customs. NIV

¹⁴⁶ John 11:39 "Take away the stone," he said. "But, Lord," said Martha, the sister of the dead man, "by this time there is a bad odor, for he has been there four days." NIV

Yeshua was killed in the afternoon of the preparation day. The following days (day #1, #2, #3) he was in the tomb. And on the third¹⁴⁷ day (i.e. Day #3) he was resurrected.

Using scenario #3
This solution is retained because it is the only one that generates the **same 3 days pattern** that we have seen at Akeda on page 258.

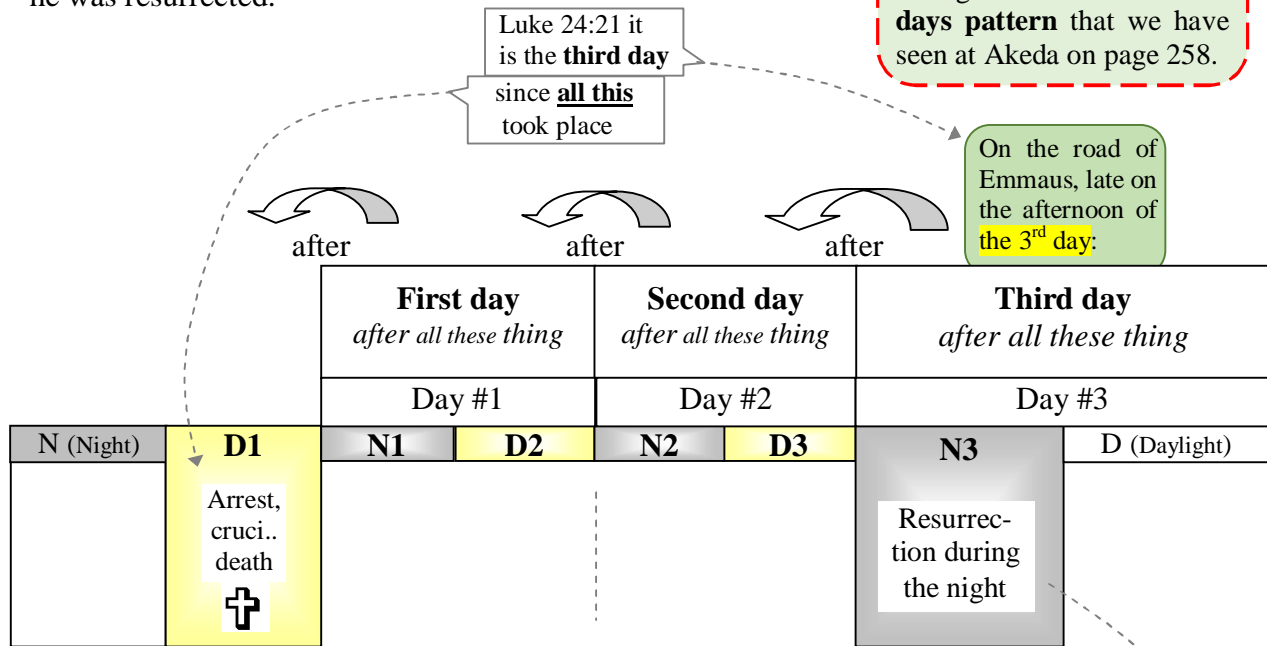

Matt 12:40 so the Son of Man will be three days and three nights in the heart of the earth. D1, D2, D3 & N1, N2, N3

Luke 24:46 He told them, "This is what is written: The Christ will suffer and rise from the dead on the third day, NIV

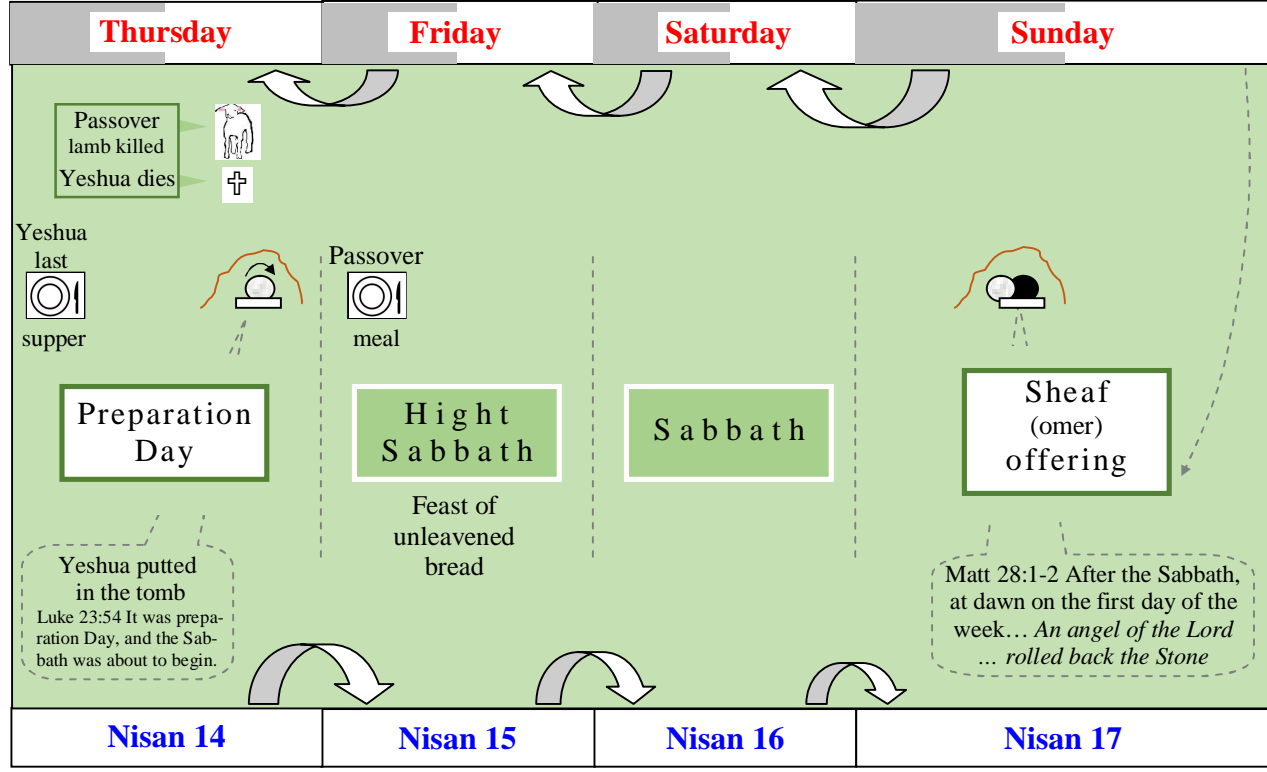

¹⁴⁷ Luke 24:21 it is the third day since all this took place. NIV

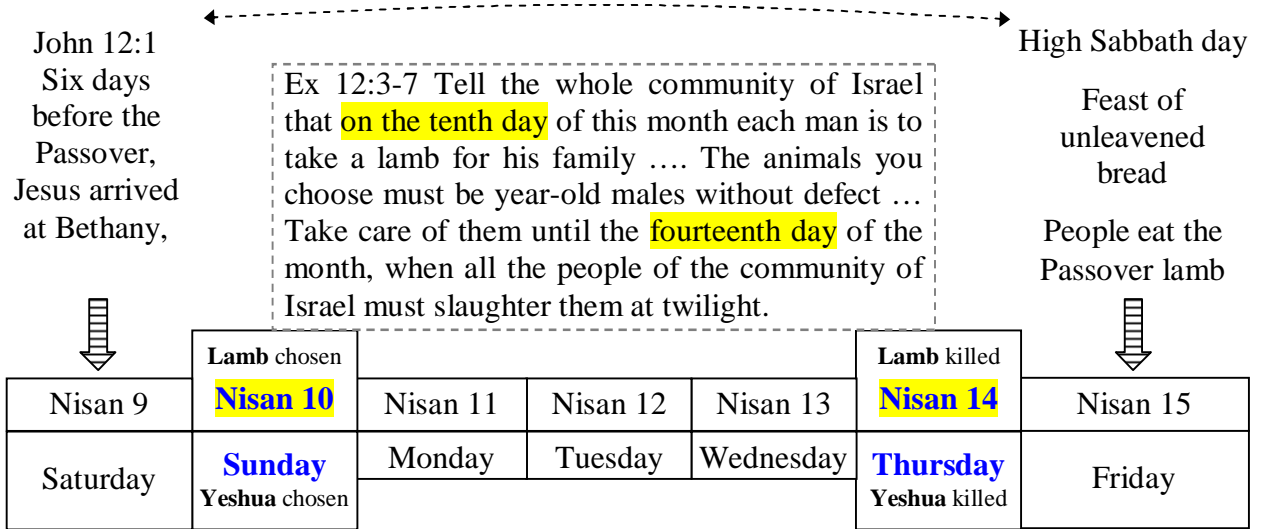

Four days before the crucifixion, Yeshua, the lamb of God, was chosen by the people of Jerusalem.

John 12:12-13 The next day the great crowd that had come for the Feast heard that Jesus was on his way to Jerusalem. They took palm branches and went out to meet him, shouting, "Hosanna!" "Blessed is he who comes in the name of the Lord!"

Yeshua's birth. According to Micah 5:2, Matt 2:1, Luke 2:4, John 7:41, Yeshua (the bread of life, John 6:35) was born in Bethlehem (house of bread). But where¹⁴⁸ exactly in Bethlehem? Few people are aware of the following possibility. According Micah 8:2¹⁴⁹ the 'Messiah' would be born at the watch tower of the flock (known as **Migdal Eder** in Hebrew). This is the tower where Rachel¹⁵⁰ died while giving birth to Jacob's youngest son, Benjamin (see Gen 35:21). A passage of the Talmud¹⁵¹ associates the tower 'Migdal Eder' with the lambs that were needed for the sacrifices at the Temple¹⁵². While the flocks were kept in the fields year around, the ewes were brought to the lower portion of the tower when it was time for birthing.

Once birthed, the priestly shepherds would routinely place the lambs in the hewn depression of a limestone rock known as "the **manger**" and "wrap the newborn lambs in **swaddling clothes**," preventing them from thrashing about and harming themselves "until they had calmed down" so they could be inspected for the quality of being "without spot or blemish" (the Jewish oral tradition)

The night Yeshua was born, there was shepherds (see Luke 2:8-16) living out in the fields at Bethlehem and keeping watch over their flocks. Suddenly the glory of the Lord shone around them and the shepherds were told by an angel that a 'Messiah' had just been born. **And they were given this sign: you will find the baby wrapped in 'swaddling clothes' and lying in a manger**. How could these shepherds have known where to go to find the newly born baby? Here is a fascinating theory¹⁵³. They knew exactly where to go because, as the priestly shepherds of the Migdal Eder, they were familiar with Micah 4:8 prophecy. **The sign** would have been useless to help anybody else but to them it could only mean one place, their tower. (Also see Cooper P Abrams¹⁵⁴ very good article)

¹⁴⁸ Around year 330 AD, Helena, mother of Emperor Constantine, identified a cave and had a church built over it. This church was destroyed in the 6th century and the Basilica of Nativity was rebuilt over it.

¹⁴⁹ Mic 4:8 As for you, O watchtower of the flock, O stronghold of the Daughter of Zion, the former dominion will be restored to you; kingship will come to the Daughter of Jerusalem." NIV

¹⁵⁰ OT:7353 **Rachel** (raw-kale'); from an unused root meaning to journey; a ewe [the females being the predominant element of a flock] (as a good traveller): KJV - **ewe, sheep**.

¹⁵¹ Babylonian Talmud Book 2 Tract Shekalim chapt VII

¹⁵² Each year the Temple's rituals and the Passover required thousands of perfect animals.

¹⁵³ I learned all about this from Ray Foucher (<http://www.jesus-resurrection.info>)

¹⁵⁴ 'Where was the birth place of the Lord Jesus'

A surprising deduction about the last supper.

The last supper could not have been a Passover meal knowing that Yeshua died at 03h00 in the afternoon of the 14 of Nissan. At the very same time thousands of Passover lambs were killed for the Passover meal that would take place a few hours later during the feast of unleavened bread (Nissan 15).

At first glance the following verse convey the idea that Yeshua sent some of his disciples to prepare the Passover meal at the start of Nisan 15 (i.e. at the start of the feast of Unleavened Bread).

- Matt 26:17 "Now the **first day** of the **feast** of unleavened bread, the disciples came to Jesus, saying unto Him, Where will You that we prepare for You to eat the Passover?"

But remove these important keywords (day, feast) added by the translator¹⁵⁵ and consider an alternative choice to the word 'first' and the verse don't point to the start of Nisan 15 anymore.

- Matt 26:17 "Now before the unleavened bread, the disciples came to Jesus, saying unto Him, Where will You that we prepare for You to eat the Passover?"

There are no doubt that the disciples went to make some preparation because of the coming Passover meal but it had nothing to do with preparing the Passover meal itself. Remember what was said about the day of preparation on page 243. It was the custom during the day of preparation, i.e. Nissan 14, to remove¹⁵⁶ any trace of yeast from the room or house where the Passover meal would be consume the following day. Yeshua didn't own a house but nevertheless he made some arrangement to have a guess room available for the purpose of having a Passover meal the next day. Given that the disciple were sent to remove the yeast in that guess room, we know it must have been the start of the preparation day and therefore the start of Nissan 14.

Keep in mind this sequence of event.

- At the beginning of the Preparation day (Nisan 14) Yeshua sent some disciples to prepare a guess room for the Passover meal that would take place 24 hours later on Nissan 15.
- Some time later during the dame evening (14th of Nisan.), the disciples assemble together with Yeshua for a meal that would be remembered as the last meal
- After the meal they went to the garden of Gethsemane and Yeshua was arrested later on during the evening.
- During the night and early in the morning Yeshua was judged and condemned. (Nisan 14)
- At 09h00 in the morning (still Nisan 14) Yeshua is hanged on the tree. (Nissan 14)
- At 03h00 in the afternoon He died (at the same time that the lamb were killed).
- Early in the evening of the new day (Nissan 15) the people ate the Passover meal.

| Nissan 14 | Nissan 15 |
|-----------|-----------|
| A | |
| <u>B</u> | <u>G</u> |
| C | |
| D | |
| E | |
| | F |

¹⁵⁵ These words don't appears in the original text as they were added by the translators for better readability in the English. The problem with that practice is that the translator could have misunderstood the original sense of a verse and oriented his translation accordingly.

¹⁵⁶ Ex 12:15 on the first day **remove the yeast from your houses**, for whoever eats anything with yeast in it from the first day through the seventh must be cut off from Israel. NIV

Three hints that the last supper was not a Passover meal:

1. During the meal they ate leaven bread and we know that the Passover meal was eaten with unleavened bread.
 - Matt 26:26 While they were eating, Jesus took bread¹⁵⁷, gave thanks and broke it, and gave it to his disciples, saying, "Take and eat; this is my body." NIV
2. During that last supper Yeshua told Judas to do what he had to do quickly, hearing this some of the apostles thought that He was sending Judas to buy what was missing for the Feast. (See John 13:27-30) The deduction of these apostles make sense only in a context where they were not already participating in a Passover meal. It would have been strange and inappropriate to send Judas buy some things for the most important meal of the year if that meal was almost already over.
3. Yeshua said that he wouldn't share the Passover meal with them.
 - Luke 22:15-16 And he said to them, "I have eagerly desired to eat this Passover with you before I suffer. For I tell you, I will not eat it **again**¹⁵⁸ until it finds fulfillment in the kingdom of God." NIV

Once the word 'again' is removed from the verse the meaning become quite different. Let's me paraphrase: Yeshua told the disciple that He would have like to share the Passover meal of the next day but now He knew that it wouldn't be possible.

And here is something that nobody realize before: Because the guess room had been ridden of any trace of yeast by the disciples sent by Yeshua, and because leaven bread was eaten¹⁵⁹ during the last meal, we have the certitude that **THE LAST MEAL WAS NOT TAKEN IN THAT GUESS ROOM**. It is inconceivable that they would have polluted that room with leaven bread before the feast of unleavened bread was over 8 days later.

We could still argue: Why did Yeshua send John and Peter to prepare a room for a meal that wouldn't take place? And my answer would be: Ignorance. Although He knew that His death would happened real soon, Yeshua must have believe that he would be allowed to take part of the next Passover meal. (maybe He thought that His death had to coincide with the time when the first born were killed in Egypt, i.e. after the Passover meal at midnight on the 15 of Nisan). I believe the timing of his death was only reveal¹⁶⁰ to Him sometime during 'the last supper'.

- John 13:21 After he had said this, Jesus was troubled in spirit and testified, "I tell you the truth, one of you is going to betray me." NIV

Interesting isn't? Right after He was troubled in spirit He told the others about Judas betrayal. Wouldn't we be troubled in spirit too if we suddenly had a vision of our imminent death? Make me think that Isaac also learned at the last minute that he would be sacrificed, no matter that his father had known for the last three days.

¹⁵⁷ the Greek word (*artos*) refers to an ordinary loaf—not to the *unleavened* flat bread or *matzos* that Jews eat with their Passover meals. From James Tabor 'Jesus Died on a Thursday not on Friday' on the 'Tabor blog'

¹⁵⁸ A later copyist of the manuscript inserted the word "again" to make it say "I won't eat it again," since the tradition had developed that Jesus did observe Passover that night and changed its observance to the Christian Eucharist or Mass. (From James Tabor 'Jesus Died on a Thursday not on Friday' on the 'Tabor blog' .)

¹⁵⁹ Eating unleavened bread before Nisan 15 would have trivialize the Unleavened bread festival

¹⁶⁰ We always assume that Yeshua knew everything a long time in advance, but what if it was not the case? I don't believe in his pre-existence or any form of incarnation. Yeshua was a mortal until his death.

Appendix D

Synchronizing the Hebrew and the Gregorian calendar

It is only once the whole internal Bible's chronology has been figured out, when each event is properly positioned on the timeline 0 to 6,000 AM, that an external Gregorian date is needed but for the sole purpose of synchronizing both the 'AM' and the 'Gregorian' calendars. We saw on page 157 that Yeshua was born in 3960 AM of the Hebrew calendar. According to a research of Ernest Martin¹⁶¹, based on the apparent motion of several celestial bodies (Sun, Moon, Jupiter, Venus, Mercury, Mars, Regulus) Yeshua was born in 3/2 BC on the Gregorian calendar. Using it (**3960 AM = 3/2 BC**) as an anchoring point, we can, without difficulties, figure out the Gregorian date of every event addressed in the present book.

$$\begin{aligned}
 \text{If } 3960 \text{ AM} &= 3 \text{ BC} \\
 3960 &= -3 \\
 3960 - 3960 &= -3 - 3960 \\
 0 &= -3963 \\
 0 \text{ AM} &= 3963 \text{ BC}
 \end{aligned}$$

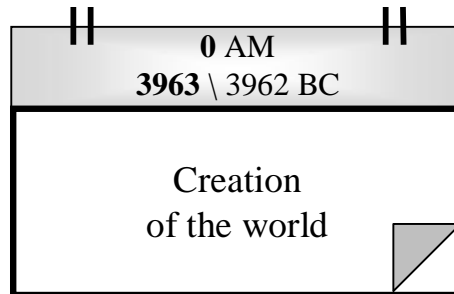

The following facts show that '3963'¹⁶² is not a meaningless value:

Is it a coincidence that the earth's radius at the equator is **3963** miles?
(same as year of creation)



Is-it also a coincidence that the highest peak in Israel, Mount Meron in the upper Galilee, is **3,963** feet high.



By rotating the two middle digits of **3963** we still obtain 3963.

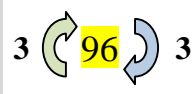

On his webpage, Tony Badillo makes a convincing case that Jachin and Boaz, the two pillars of the Temple (1 King 7:21) represent David and Solomon. As shown here, these two kings have also a role of pillar in the present chronology.

| | | |
|----------------|------------------------|----------------------|
| 2963 AM | David King of Judah | 1000 / 999 BC |
| 3000 AM | Solomon King of Israel | 963 / 962 BC |

¹⁶¹ The birth of Christ recalculated by Ernest Martin.

¹⁶² German protestant mathematician and historian 'Philip Melanchthon' came to the same conclusion in his Chronicle: "The world was created in **3963** B.C." - **Philip Melanchthon 1497-1560**

Appendix E

The Bible's timeline

| AM | Gregorian Calendar BC/AD | EVENT | Bible Ref. | More details |
|------|-----------------------------|------------------------------|------------------------|-----------------|
| 0 | 3963/3962 BC | Adam born | | |
| 130 | 3833/3832 BC | Seth born | Gen 5:3 | |
| 235 | 3728/3727 BC | Enosh born | Gen 5:6 | |
| 325 | 3638/3637 BC | Kenan born | Gen 5:9 | |
| 395 | 3568/3567 BC | Mahalalel born | Gen 5:12 | |
| 460 | 3503/3502 BC | Jared born | Gen 5:15 | |
| 622 | 3341/3340 BC | Enoch born | Gen 5:18 | |
| 687 | 3276/3275 BC | Methuselah born | Gen 5:21 | |
| 874 | 3089/3088 BC | Lamech born | Gen 5:25 | |
| 930 | 3033/3032 BC | Adam dies | Gen 5:5 | |
| 987 | 2976/2975 BC | Enoch dies | Gen 5:23 | |
| 1042 | 2921/2920 BC | Seth dies | Gen 5:8 | |
| 1056 | 2907/2906 BC | Noah born | Gen 5:28 | |
| 1140 | 2823/2822 BC | Enosh dies | Gen 5:11 | |
| 1235 | 2728/2727 BC | Kenan dies | Gen 5:14 | |
| 1290 | 2673/2672 BC | Mahalalel dies | Gen 5:17 | |
| 1422 | 2541/2540 BC | Jared dies | Gen 5:20 | |
| 1536 | 2427/2426 BC | Noah starts building the Ark | Gen 6:3 (1656 -120) | |
| 1558 | 2405/2404 BC | Shem born | Gen 11:10 | |
| 1651 | 2312/2311 BC | Lamech dies | Gen 5:31 | |
| 1656 | 2307/2306 BC | Methuselah dies Flood | Gen 5:27 Gen 7:6 | |
| 1658 | 2305/2304 BC | Arphaxad born | Gen 11:10 | |
| 1693 | 2270/2269 BC | Shelah born | Gen 11:12 | |
| 1723 | 2240/2239 BC | Eber born | Gen 11:14 | |
| 1757 | 2206/2205 BC | Peleg born | Gen 11:16 | |
| 1787 | 2176/2175 BC | Reu born | Gen 11:18 | |
| 1819 | 2144/2143 BC | Serug born | Gen 11:20 | |

| AM | Gregorian Calendar BC/AD | EVENT | Bible Ref. | More details | |
|-------------|-----------------------------|---|-----------------------------|-----------------|--------|
| 1849 | 2114/2113 BC | Nahor born | Gen 11:22 | | |
| 1878 | 2085/2084 BC | Terah born | Gen 11:24 | | |
| 1948 | 2015/2014 BC | Haran born | This work | | P. 242 |
| 1993 | 1970/1969 BC | Babel | Inference | | P. 197 |
| 1996 | 1967/1966 BC | Peleg dies | Gen 11:19 | | |
| 1997 | 1966/1965 BC | Nahor dies | Gen 11:25 | | |
| 2006 | 1957/1956 BC | Noah dies | Gen 9:29 | | |
| 2008 | 1955/1954 BC | Abram born | Gen 12:4 | | P. 141 |
| 2018 | 1945/1944 BC | Sarai born | Gen 17:17 2108 - 90 | | P. 142 |
| 2026 | 1937/1936 BC | Reu dies | Gen 11:21 | | |
| 2033 | 1930/1929 BC | Abram marries | Inference | | P. 177 |
| 2049 | 1914/1913 BC | Serug dies | Gen 11:23 | | |
| 2063 | 1900/1899 BC | Abram leaves Ur (goes to Haran) | Inference | | P. 175 |
| 2083 | 1880/1879 BC | Terah dies / Abram leaves Haran and goes to Canaan | Gen 11:32/12:4 2008 + 75 | | |
| 2088 | 1875/1874 BC | Abraham goes to Egypt | Inference | | P. 196 |
| 2093 | 1870/1869 BC | Pregnant Hagar ran away Covenant between the parts | Gen 16:3-4 2083 +10 | P. 77 | |
| 2094 | 1869/1868 BC | Ishmael born | This work | P. 77 | |
| 2096 | 1867/1866 BC | Arphaxad dies | Gen 11:13 | | |
| 2107 | 1856/1855 BC | Covenant of circumcision | Gen 17:24 2008 + 99 | P. 77 | |
| 2108 | 1855/1854 BC | Isaac born | Gen 17:17 (2008 + 100) | P. 142 | |
| 2123 | 1840/1839 BC | Binding of Isaac (AKEDAH) | 2523 - 400 | P. 82 | |
| 2126 | 1837/1836 BC | Shelah dies | Gen 11:15 | | |
| 2145 | 1818/1817 BC | Sarai dies | Gen 23:1 2018 + 127 | | |
| 2148 | 1815/1814 BC | Isaac marries | Gen 25:20 2108 + 40 | P. 177 | |
| 2158 | 1805/1804 BC | Shem dies | Gen 11:11 | | |

| AM | Gregorian Calendar BC/AD | EVENT | Bible Ref. | More details |
|------|-----------------------------|------------------------------------|--|-----------------|
| 2168 | 1795/1794 BC | Jacob/Esau born | Gen 25:26 2108 + 60 | P. 202 |
| 2183 | 1780/1779 BC | Abraham dies | Gen 25:7 2008 + 175 | P. 77 |
| 2187 | 1776/1775 BC | Eber dies | Gen 11:17 | |
| 2208 | 1755/1754 BC | Esau marries | Gen 26:34 2168 + 40 | |
| 2231 | 1732/1731 BC | Ishmael dies | Gen 25:17 2094 + 137 | |
| 2245 | 1718/1717 BC | Jacob hired by Laban | Gen 31:41 2265 - 14 - 6 | P. 144 |
| 2252 | 1711/1710 BC | Jacob marries Leah and Rachel | Gen 29:20 2245 + 7 | |
| 2253 | 1710/1709 BC | Reuben born | Gen 29:31 2252 + 1 | P. 198 |
| 2255 | 1708/1707 BC | Levi born | (third son) 2253 + 2 | |
| 2258 | 1705/1704 BC | Joseph born | Gen 41:46 2288 - 30 | P. 176 |
| 2259 | 1704/1703 BC | End of first 14 years | Gen 30:25 2258 + 1 | |
| 2265 | 1698/1697 BC | Jacob leaves Laban | Gen 31:41 2245+7+7+6 | P. 164 |
| 2268 | 1695/1694 BC | Benjamin born | Inference | P. 142 |
| 2275 | 1688/1687 BC | Joseph goes to Egypt | Gen 37:2 2258 + 17 | P. 142 |
| 2285 | 1678/1677 BC | Joseph sent to jail | Inference | P. 142 |
| 2286 | 1677/1676 BC | Joseph helps the chief baker | Gen 41:1 2288 - 2 | P. 1444 |
| 2288 | 1675/1674 BC | Isaac dies Joseph meets Pharaoh | Gen 35:28 2108 + 180 Gen 41:25 2289 - 1 | P. 176 |
| 2289 | 1674/1673 BC | Start of 7 years of plenty | Gen 41:53 2296 - 7 | P. 142 |
| 2291 | 1672/1671 BC | Manasseh born | Inference | P. 142 |

| AM | Gregorian Calendar BC/AD | EVENT | Bible Ref. | More details |
|-------------|-----------------------------|---|--|-----------------|
| 2295 | 1668/1667 BC | Ephraim born | Inference | P. 142 |
| 2296 | 1667/1666 BC | Start of 7 years of famine | Gen 45:10 2298 - 2 | P. 142 |
| 2298 | 1665/1664 BC | Jacob in Egypt | Gen 47:28 2315 - 17 | P. 144 |
| 2315 | 1648/1647 BC | Jacob dies | Gen 47:28 2168 + 147 | P. 198 |
| 2368 | 1595/1594 BC | Joseph dies | Gen 50:26 2258 + 110 | P. 142 |
| 2392 | 1571/1570 BC | Levi dies | Exo 6:16 2255 + 137 | |
| 2440 | 1523/1522 BC | Aaron born | Ex 7:7 2443 - 3 | |
| 2443 | 1520/1519 BC | Moses born | Deut 34:7 2562 – 120 Inclusive years | P. 180 |
| 2463 | 1500/1499 BC | Joshua born | Josh 24:29 2573 - 110 | P. 169 |
| 2483 | 1480/1479 BC | Moses escape from Egypt | Act 7:23 2443 + 40 | P. 54 |
| 2484 | 1479/1478 BC | Caleb born | Josh 14:7 2524 - 40 | P. 18 |
| 2522 | 1441/1440 BC | Burning bushes | 2523 - 1 | P. 173 |
| 2523 | 1440/1439 BC | EXODUS | 2093 + 430 | P. 82 |
| 2524 | 1439/1438 BC | Tabernacle set up Leaves Sinai Land spied | Ex 40-17 2523 + 1 | P. 173 |
| 2543 | 1420/1419 BC | Leaves Kadesh Barnea | Inference | P. 173 |
| 2562 | 1401/1400 BC | Aaron & Moses die | 2563 – 1 | P. 18 |
| 2563 | 1400/1399 BC | Promised Land | Num 14:33-34 2523 + 40 | P. 18 |
| 2569 | 1394/1393 BC | Land divided | Josh 14:10 2484 + 85 | P. 18 |
| 2573 | 1390/1389 BC | Joshua dies | Act 13:16-20 2123 + 450 | P. 169 |
| 2583 | 1380/1379 BC | Gibeah Sin | 2973 - 390 | P. 64 |
| 2593 | 1370/1369 BC | #1 Opp. Cushan | Inference | P. 163 |

| AM | Gregorian Calendar BC/AD | EVENT | Bible Ref. | More details |
|------|-----------------------------|---|-------------------------|-----------------|
| 2601 | 1362/1361 BC | Judge Othniel | Judg 3: 8 2593 + 8 | P. 168 |
| 2641 | 1322/1321 BC | #1 Opp. Eglon | Judg 3:11 2601 + 40 | P. 168 |
| 2659 | 1304/1303 BC | Judge Ehud | Judg 3:14 2641 + 18 | P. 168 |
| 2677 | 1286/1285 BC | #3 Opp. Jabin | 2659 + 18 | P. 168 |
| 2697 | 1266/1265 BC | Judge Barak | Judge 4:3 2677 + 20 | P. 168 |
| 2737 | 1226/1225 BC | 12 years Gap no judges, no oppressions | Inference | P. 167 |
| 2749 | 1214/1213 BC | #4 Opp. Median | Judg 6:1 2756 - 7 | P. 168 |
| 2756 | 1207/1206 BC | Judge Gideon | Judg 8:28 2796 - 40 | P. 168 |
| 2775 | 1188/1187 BC | Eli born | 1 Sam 4:15 2873 - 98 | |
| 2796 | 1167/1166 BC | #5 Opp. Abimelec | Judg 8:22 2799 - 3 | P. 168 |
| 2799 | 1164/1163 BC | Judge Tola | Judg 10:2 2822 - 23 | P. 168 |
| 2822 | 1141/1140 BC | Judge Jair | Judg 10:3 2844 - 22 | P. 168 |
| 2833 | 1130/1129 BC | Eli judge | 1 Sam 4:18 2873 - 40 | P. 54 |
| 2844 | 1119/1118 BC | #6 Opp. Ammon | Judg 10:8 2862 - 18 | P. 168 |
| 2853 | 1110/1109 BC | #7 Opp. Philistines | Judg 13:1 2893 - 40 | P. 168 |
| 2856 | 1107/1106 BC | Samson born | | P. 194 |
| 2862 | 1101/1100 BC | Judge Jephtah | Jug 12:7 2868 - 6 | P. 168 |
| 2863 | 1100/1099 BC | Samuel birth | Inference | P. 163 |
| 2868 | 1095/1094 BC | Judge Ibzan | Judg 12:9 2275 - 7 | P. 168 |
| 2870 | 1093/1092 BC | Judge Samson | | P. 194 |

| AM | Gregorian Calendar BC/AD | EVENT | Bible Ref. | More details |
|------|-----------------------------|--|--|-----------------|
| 2873 | 1090/1089 BC | Ark is captured | 2483 + 390 | P. 55 |
| 2874 | 1089/1088 BC | Ark is returned | 1 Sam 6:1 2873 + 7 mo. | |
| 2875 | 1088/1087 BC | Judge Elon | Judg 12:11 2885 - 10 | P. 168 |
| 2885 | 1078/1077 BC | Judge Abdon | Judg 12:14 2893 - 8 | P. 168 |
| 2890 | 1073/1072 BC | Samson dies | Jud 16:31 2870 + 20 | P. 194 |
| 2893 | 1070/1069 BC | Samuel judges | 1 Sam 7:2 2873 + 20 | P. 54 |
| 2923 | 1040/1039 BC | King Saul (40 y.) | Act 13:21 2963 - 40 | P. 54 |
| 2933 | 1030/1029 BC | David born | 2 Sam 5:4-5 2963 - 30 | P. 54 |
| 2943 | 1020/1019 BC | Saul rejected ???? | Inference | P. 181 |
| 2953 | 1010/1009 BC | Samuel dies | 2523 + 430 | P. 63 |
| 2963 | 1000/999 BC | King David (over Judah) Ish-Bosheth king over Israel | 1 Chron 29:27 3003 - 40 | P. 222 |
| 2965 | 998/997 BC | King Ish-Bosheth dies | 2 Sam 2:10 | P. 222 |
| 2966 | 997/996 BC | David king Israel | This work | P. 222 |
| 2970 | 993/992 BC | David moves to Jerusalem | 2 Sam 5:4-5 2963 + 7 | P. 54 |
| 2973 | 990/989 BC | Ark brought in Jerusalem | 1 Chron 15:1 2970 + 3 | P. 64 |
| 2983 | 980/979 BC | Solomon born | Inference | P. 194 |
| 3000 | 963/962 BC | King Solomon (17 years old) (will reign 63 years) | 1 Kings 6:1 3003 - 4 th year | P. 194 |
| 3003 | 960/959 BC | Start of first Temple const. | 2 Sam 5:4-5 2523 + 480 | P. 54 |
| 3010 | 953/952 BC | 1 st Temple is ready | 1 Kings 7:38 3003 + 7 | P. 54 |
| 3013 | 950/949 BC | Ark brought to Temple | 3010 + 3 | P. 64 |
| 3023 | 940/939 BC | Solomon is endorsed by God Palace is ready | 1 Kings 7:1 3010 + 13 | P. 102 |
| 3063 | 900/899 BC | Solomon dies/Kingdom split K Rehoboam South Kingdom #1 K Jeroboam North Kingdom #1 | 1 Kings 11:42 3023 + 4 0 | P. 102 |

| AM | Gregorian Calendar BC/AD | EVENT | | More details |
|------|-----------------------------|---|------------------------|-------------------------|
| 3080 | 883/882 BC | K Abijah SK2 | | A.O.W |
| 3082 | 881/880 BC | K Asa SK3 | | A.O.W |
| 3084 | 879/878 BC | K Nadab NK2 | | A.O.W |
| 3085 | 878/877 BC | K Baasha NK3 | | A.O.W |
| 3108 | 855/854 BC | K Elah NK4 | | A.O.W |
| 3109 | 854/853 BC | K Zimri NK5 K Tibni NK6 K Omri NK7 | | A.O.W A.O.W A.O.W |
| 3113 | 850/849 BC | Foundation of Samaria | 3503 - 390 | P. 71 |
| 3120 | 843/842 BC | K Ahab NK8 | | A.O.W |
| 3123 | 840/839 BC | K Jehoshaphat SK4 | | A.O.W |
| 3140 | 823/822 BC | K Jehoram SK5 K Ahaziah NK9 | | A.O.W |
| 3141 | 822/821 BC | K Joram NK10 | | A.O.W |
| 3151 | 812/811 BC | K Ahaziah SK6 | | A.O.W |
| 3152 | 811/810 BC | Q Athaliah SK7 K Jehu NK11 K Joash SK8 | | A.O.W A.O.W A.O.W |
| 3175 | 788/787 BC | K Jehoahaz NK12 | | A.O.W |
| 3189 | 774/773 BC | K Jehoash NK13 | | A.O.W |
| 3191 | 772/771 BC | K Amaziah SK9 | | A.O.W |
| 3206 | 857/856 BC | K Jeroboam II NK14 | | A.O.W |
| 3233 | 830/829 BC | K Uzzia SK10 | | A.O.W |
| 3271 | 692/691 BC | K Zecharia NK15 | | A.O.W |
| 3272 | 691/690 BC | K Shallum NK16 K Menahem NK17 | | A.O.W |
| 3283 | 680/679 BC | K Pekahiah NK18 | | A.O.W |
| 3285 | 678/677 BC | K Pekah NK19 K Jotham SK11 | | A.O.W |
| 3302 | 661/660 BC | K Ahaz SK12 | | A.O.W |
| 3303 | 660/659 BC | ISAIAH foretells that Ephraim will be broken (Israel doom) | Isa 7:8-9 3368 - 65 | P. 95 |
| 3314 | 649/648 BC | K Hoshea NK20 | | A.O.W |

| AM | Gregorian Calendar BC/AD | EVENT | | More details |
|-------------|-----------------------------|--|----------------------------|-----------------|
| 3317 | 646/645 BC | K Hezekiah SK13 | A.O.W | A.O.W |
| 3323 | 640/639 BC | EXILE of Israel | 2 Kings 18:10 3314 + 9 | P. 91 |
| 3328 | 635/634 BC | Hezekiah's Passover | 3368 - 40 | A.O.W |
| 3333 | 630/629 BC | K Manasseh SK14 | 3443 - 110 | P. 15 |
| 3368 | 595/594 BC | Manasseh sets an ABOMINATION in the Temple | 3333 + 35 | P. 15 |
| 3388 | 575/574 BC | K Amon SK15 | 2 kings 21:19 3390 - 2 | P. 15 |
| 3390 | 573/572 BC | K Josiah SK16 | 2 kings 22:1 3421 - 31 | P. 15 |
| 3403 | 560/559 BC | Jeremiah prophesies | Jer 25:1-3 3390 + 13 | P. 56 |
| 3408 | 555/554 BC | Josiah's Passover | 2 Kings 23:23 3390 + 18 | P. 56 |
| 3421 | 542/541 BC | K Jeohaz SK17 K Jehoiakim SK18 | 2 Kings 23:36 3432 - 11 | P. 15 |
| 3423 | 540/539 BC | Start of Babylon 70 years | Jer 25:11 3493 - 70 | P. 100 |
| 3424 | 539/538 BC | King Nebuchadnezzar | | P. 100 |
| 3432 | 531/530 BC | K Jehoiachin SK19 K Zedekiah SK20 | 2 Chron 36:11 3443 - 11 | P. 56 |
| 3433 | 530/529 BC | EXILE of Judah | 2 King 24 :13-17 | P. 71 |
| 3443 | 520/519 BC | <u>End of first Temple</u> (start of 70 years of desolation) | 3013 + 430 | P. 62 |
| 3493 | 470/469 BC | Fall of Babylon's empire King Darius (the mede) | 3063 + 430 | P. 101 |
| 3502 | 461/460 BC | King Cyrus | 3503 - 1 | P. 132 |
| 3503 | 460/459 BC | Return of the 42,360 exiles (end of Judah's exile) | Jer 29:10 3433 + 70 | P. 71 |
| 3509 | 454/453 BC | Exiles set an Altar | 3503 + 6 | P. 119 |
| 3510 | 453/452 BC | <u>Foundation of 2nd Temple</u> (start of Daniel's 70 weeks) | 3503 + 7 | P. 132 |
| 3511 | 452/451 BC | King Darius (Artaxerxes) | 3502 + 9 | P. 119 |

| AM | Gregorian Calendar BC/AD | EVENT | Bible Ref. | More details |
|-------------|-----------------------------|--|----------------------------|-----------------|
| 3513 | 450/449 BC | Construction of 2 nd Temple starts | 3511 + 2 | P. 126 |
| 3517 | 446/445 BC | 2 nd Temple is ready | Ezra 4:24,6:15 3513 + 4 | P. 119 |
| 3531 | 432/431 BC | Start of Nehemiah's wall's repairs | Neh 2:1 3511 + 20 | P. 118 |
| 3543 | 420/419 BC | Nehemiah's wall fully repaired | Neh 5:14 3531 + 12 | P. 118 |
| 3547 | 416/415 BC | King Xerxes (Book of Esther) | Est 3:7 3559 -12 | P. 126 |
| 3559 | 404/403 BC | First Purim (end of Daniel first 7 weeks) | Dan 9:25 3510 + 49 | P. 126 |
| 3943 | 20/19 BC | Herod repairs the Temple | 3513 + 430 | P. 110 |
| 3960 | 3/2 BC | Yeshua born | Inference | P. 157 |
| 3972 | 10/11 AD | Yeshua in Temple at 12 years old | Luc 2:42 3960 + 12 | P. 157 |
| 3989 | 27/28 AD | Start of Yeshua's ministry | 3559 + 430 | P. 138 |
| 3993 | 31/32 AD | Yeshua dies (end of Daniel first 69 weeks) | Dan 9:25 3510 + 483 | P. 113 |
| 4033 | ?? 71/72 AD ?? | End of 2 nd Temple | Inference | P. 157 |
| 5983 | 2021/2022 AD | Recall of the northern lost tribes? --WAKUP-- | Inference | P. 180 |
| 5993 | 2031/2032 AD | Start of Daniel's 70 th week | 6000 - 7 | P. 223 |

Notice that contrary to the popular belief, I have the destruction of the 2nd Temple in **71 AD**. Have I been careless somehow in my chronology? Do you know that the Jewish sage cannot make their mind if the Temple came down in 69 or 70 AD? In fact the Talmud says that the Temple stood 420 years and the Jewish sage debate if it means that it was destroyed in its 420th year, or after it had been standing up for a full 420 years. According my chronology the Temple came down 520 years after the start of its construction. (Observe how my 520 years value is strangely similar to the Talmud 420 years. Have the earliest Talmudic writers wrongly recorded 420 years instead of 520? I believe so).

To the Jews our Gregorian year 2000 AD was equivalent to their year 5760 AM. They really seem to be offset about 200 years¹⁶³. Unfortunately they won't be aware of their mistake as long as they will persist denying that Yeshua was the Messiah they had been waiting for.

¹⁶³ R' Azariah dei Rossi, in *Me'or Einayim* (c. 1573), was likely the first Jewish authority to claim that the traditional Hebrew dating is not historically precise regarding the years before the Second Temple.

Appendix F Hidden link between 3443 and 3993

Palindromic connections that highlight the complementarity between the numbers 3443 and 3993

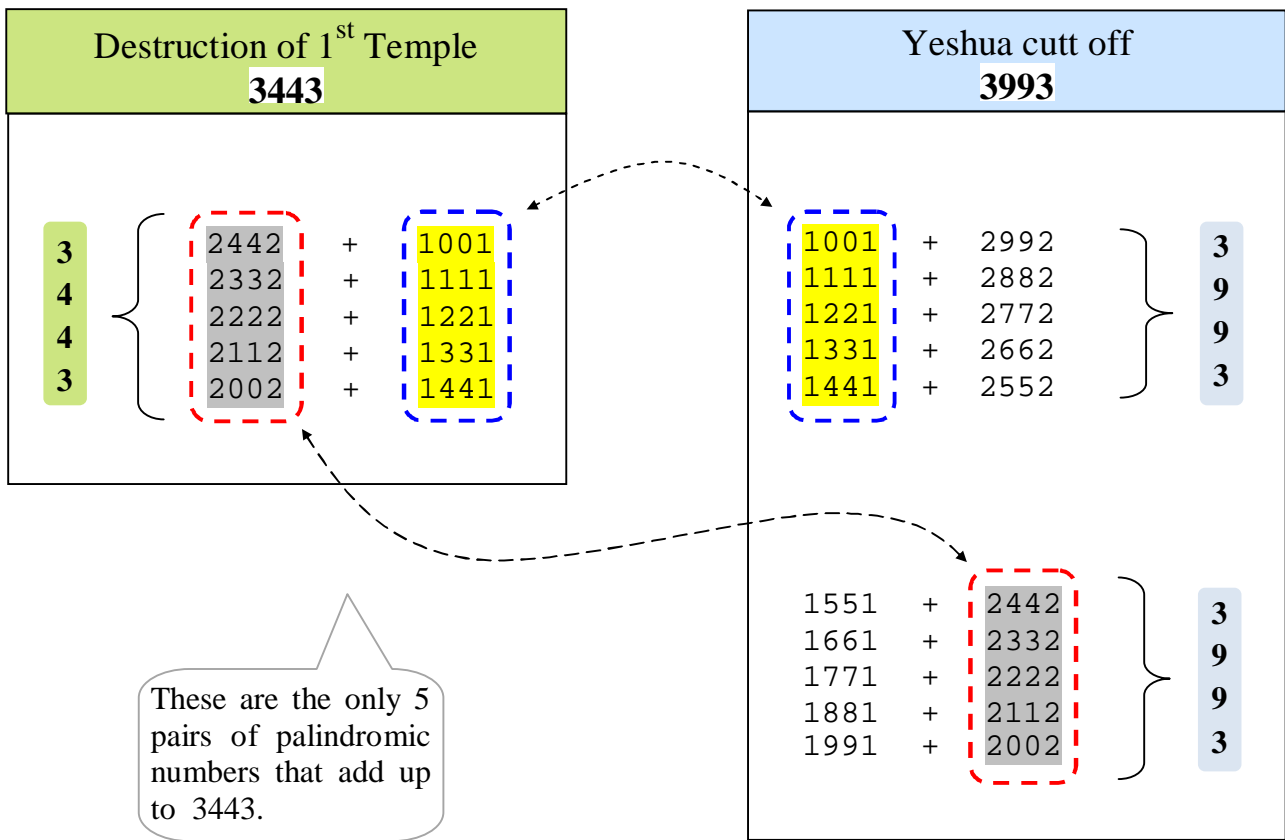

Appendix G Daniel 8:14 ‘2300 evenings and mornings’

The following figure give an overview of some past, present and future kingdom as described in visions in the books of Daniel and Revelation.

| | | | | |
|--|---|-------------------------------|--|---|
| | | | | Rev 17 7 heads |
| | Daniel 2 Male image | Daniel 7 4 beasts | Daniel 8 Ram & Goat | 1 Egypt c. 3150 BC |
| | | | | 2 Assyria c. 2500-606 BC |
|  | Head of gold | 1 Lion | | 3 Babylon c. 626-539 BC |
| | Breast & arms of silver | 2 Bear | Ram 2 horns Mede/Persia | 4 Persia c. 539-332 BC |
| | Belly & thighs of Brass | 3 Leopard (4 heads) | Goat single horn Greece Alexander kingdom Would later split in 4 1 Selucid (north) Mesopotamia and Central Asia 2 Attalid Anatolia 3 Antigonid Macedon 4 Ptolemaic (south) Egypt | 5 Greece c. 332 – 63 BC |
| | Legs of iron Rome kingdom had split in 2: Eastern - Western Rome – Constantinople | 4 Powerful beast | | 6 One is Rome c. 63 BC – 476 AD |
| | | | | 7 One is to come Ottoman c. 1300–1922 AD |

Figure 21 Beast vision¹⁶⁴

¹⁶⁴ This is an extract from ‘Is WWII on the Horizon?’ from pastor Tony Bosserman

Daniel Chapter 8 describes a vision in which a Goat with a single horn quickly and furiously attacks a two horns Ram. The bible tells us that the Ram and the Goat represent respectively the Persian and the Grecian empire.

It is a know fact that the three defeats of the Persian King, Darius III (**battles of Granicus in 334 BC**, Issus in 333 BC and Gaugamela in 331 BC), against the army of Alexander the great marked the end of the Persian empire and the consolidation of the Grecian empire.

The collapse of the Persian empire brought to an end the peaceful control they had over Jerusalem. (In the past, the Persian had facilitated the return of Judah exiles, contributed to the erection of the second Temple and allowed the rebuilding of the city.) When they invaded Asia for the first time (battle of Granicus 334 BC) the Greeks began an hostile period of domination over Jerusalem and all the other Persian's territories.

A few years ago, in a book called 'Restoring Abrahamic Faith' by James Tabor, I read about a prediction done in 1825 AD by Adam Clarke. According Mr. Clarke, the 2300 'evenings and mornings' period mentioned in Dan 8:14, should be counted from the time of the Battle of Granicus in 334 BC. Unaware of it, Mr. Clarke had just linked, a century before it happens, the 1967 Israel 6-day war and the beginning of the Greek's domination over Jerusalem. During the 6-day war the Jew regained for the first time in the last 2300 years full sovereignty over Jerusalem old city and the Temple mount¹⁶⁵.

In spite of this outstanding coincidence I was never completely convinced that the 2300 evenings and mornings of Daniel 8:14 should be interpreted as 2300 years. Unlike many others I don't believe that there is a systematic 'Day for Year' principle in Bible prophecy¹⁶⁶. What make me fully accept that the 2300 evenings and mornings of Daniel 8:14 was meant to be interpreted as years is a suggestion found in an article of Dan Bruce¹⁶⁷. According Mr. Bruce the key to understand the somewhat cryptic usage of 'evenings and mornings' in Daniel's propcey can be found in Exodus 12:6-10 . And more specifically in

- Ex 12:6 And ye shall keep it up until the fourteenth day of the same month: and the whole assembly of the congregation of Israel shall kill it in the evening¹⁶⁸ KJV
- Ex 12:10 And ye shall let nothing of it remain until the morning; and that which remaineth of it until the morning ye shall burn with fire. KJV

Daniel 'evenings and mornings' (a forgotten idiom ??) don't represent, strictly speaking, a unit of time. It rather refer to the sacrifice of the Passover which occurs 'between the two evening' of the 14th and had to be ended by early morning of the 15th day of the first month of the Hebrew calendar. Incidentally 2300 'evening and morning' (2300 Passover's sacrifices) do represent a period of time that covers 2300 years.

¹⁶⁵ *We have returned to all that is holy in our land. We have returned never to be parted from it again.* -Defense Minister Moshe Dayan, upon reaching the Western Wall

¹⁶⁶ Indeed Ezekiel 4 uses the day = year principle but this is explicitely requested in Ezek 4:5; During Exodus God kept the Israelites 40 years in the desert because of the outcome of the 40-day spy mission. Here too the day = years is justified, see Num 14:34; In Daniel 9 we read about the 70 weeks prophecy. It should be noted here that the original expression is 70 '7' without specifying if 'days' 'months' or 'years' are intended.

¹⁶⁷ 'Want proof of God? Check this out' Ban Bruce

¹⁶⁸ **Evening** (from "haa`arbaayim" IE. Between the two evenings = middle of the afternoon)

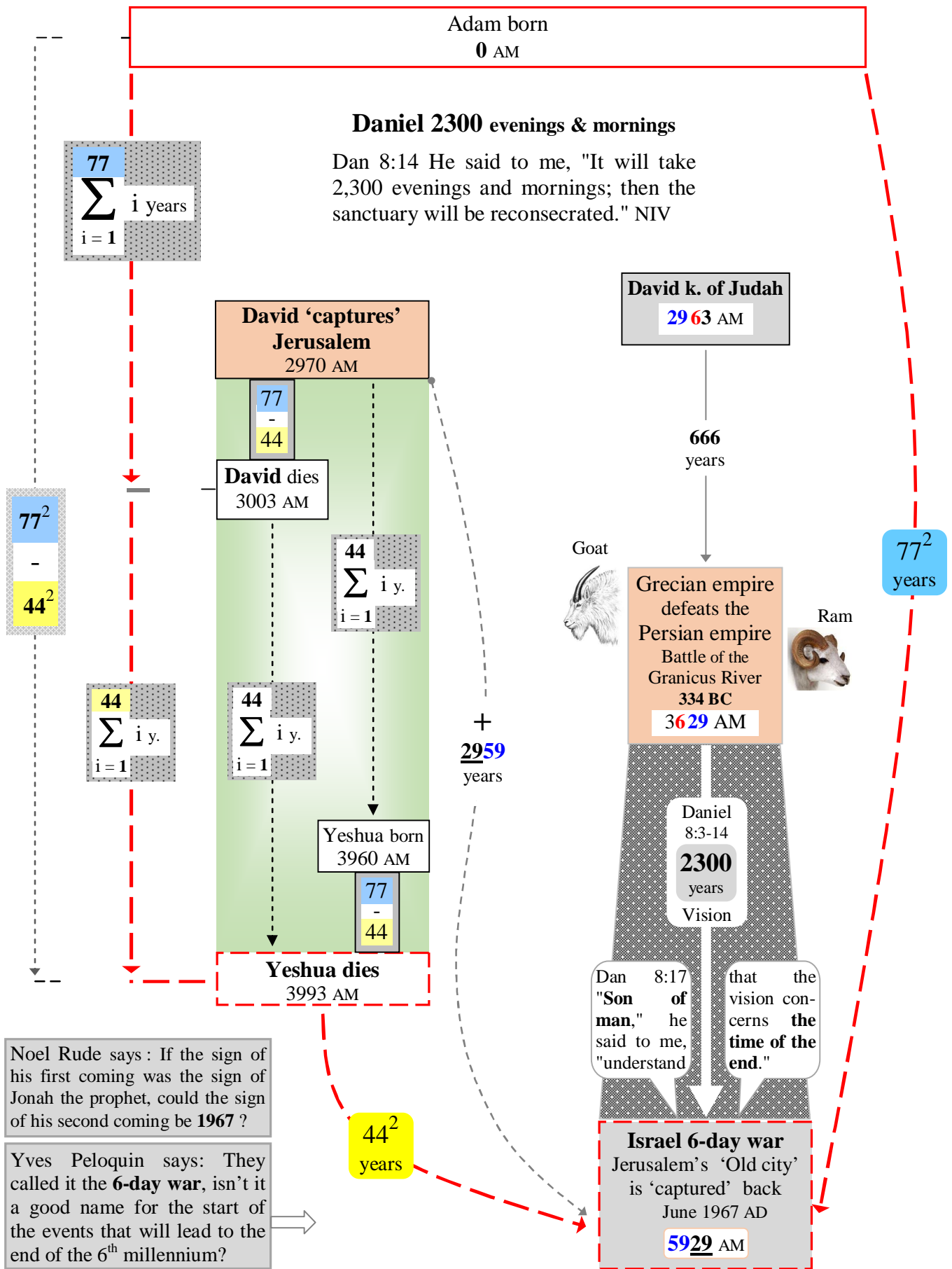

Noel Rude says : If the sign of his first coming was the sign of Jonah the prophet, could the sign of his second coming be 1967 ?

Yves Peloquin says: They called it the **6-day war**, isn't it a good name for the start of the events that will lead to the end of the 6th millennium?

Appendix H Daniel 12:11-12

'1290 days & 1335 days'

(This topic is speculative in spite of two meaningful markers)

Dan 12:11-12 "From the time that the daily sacrifice is abolished and the abomination that causes desolation is set up, there will be **1,290** days. ...

... Blessed is the one who waits for and reaches the end of the **1,335** days. NIV

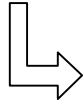

Lets rephrase

From 'the set up of the abomination that causes desolation'
 To 'the **abolition of the daily sacrifice**'
 there will be **1,290** days

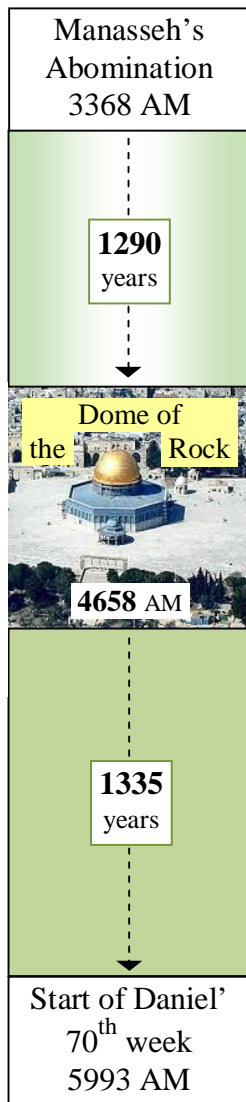

Jer 7:30 For the children of Judah have done evil in my sight, saith the LORD: they have set their abominations in the house which is called by my name, to pollute it. KJV
 2 Chron 33:7 And he [*Manasseh*] set a carved image, the idol which he had made, in the house of God, KJV



What could have happened in years 4658 AM (696/697 AD) that could convince us that the **daily sacrifice** had really been interrupted at that time? Do you know that the **Dome of the Rock**, occupying the central point of the Temple Mount in Jerusalem, was **supposedly** completed in **691 AD** under the order of Umayyad Caliph Abd al-Malik. What if the historical date of 691 AD is 5 years offset and the Dome of the Rock **was in fact inaugurated in 696 AD (4658 AM)**! Could the presence of that Islamic shrine on the Temple Mount, have lead to the interruption (or nullify) any daily sacrifice performed by the Jews? I would think so.
 NOTE: It is erroneously believed that the 'Dome of the Rock' occupies the exact location where the two Jewish Temples were previously built. In fact the two Temples were outside and south of the present Temple Mount.
 See Ernest Martin book 'The Temples That Jerusalem Forgot'



According Daniel 12:9 the meaning of the 1290 and 1335 years will be understood only at the time of the end. —?→ Why would it matter that the prophecy be understood only **at the time of the end**, unless the period (1290 + 1335 years) ends at that very time?
 Dan 12:12 Blessed is the one who waits for and reaches the end of the **1,335** days. —?→ What could be the blessing at the end of the combined period of 1290 & 1335 years? Notice that the period started with the desecration of the Temple (thus an interruption of the sacrifice). Could the blessing be related to the construction of the third Temple **and the resuming of the Sacrifice**? It would make a lot of sense!

Appendix I Daniel's 70th week

Earlier in this book we have looked at the chronology of the first 69 weeks of Daniel 70 week prophecy (see page 116 & chart 26 on page 225), we will now look at the 70th week.

- Dan 9:27 He will confirm a covenant with many for one 'seven.' In the middle of the 'seven' he will put an end to sacrifice and offering. And on a wing [of the temple] he will set up an abomination that causes desolation, until the end that is decreed is poured out on him." NIV

Note: sacrifice and offering are the Temple daily ritual

Here are some interesting facts related to the 70th week:

- The ruler will confirm a 7 years' covenant at the beginning of the 70th week
- The ruler will break the covenant in the middle of that week. (i.e. after 3.5 years)
- The ruler will put an end to the sacrifice in the middle of the week
- we can deduce that the **Sacrifice started** at the beginning of that week (year 5993 AM)

Note: Isn't it what we concluded in the preceding page?

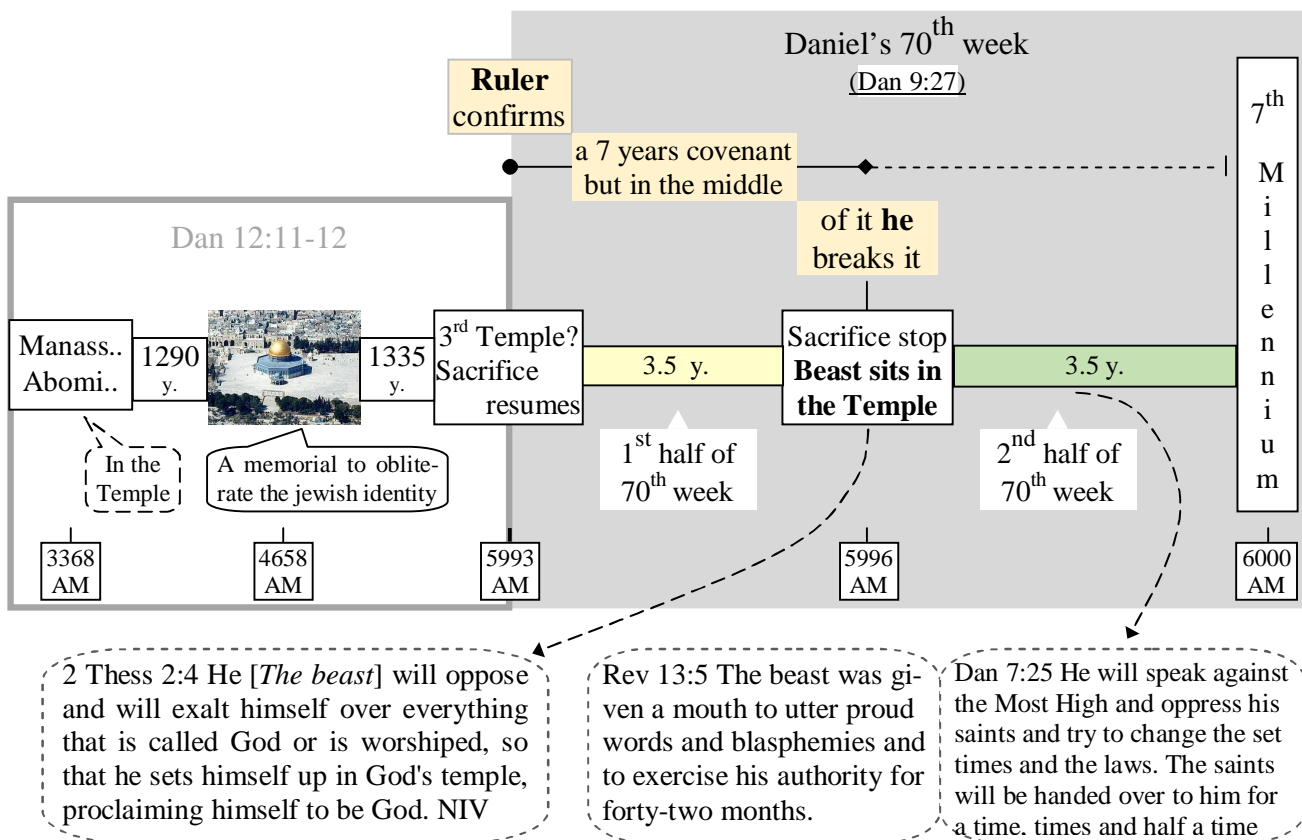

Matt 24:3 As Jesus was sitting on the Mount of Olives, the disciples came to him privately. "Tell us," they said, "when will this happen, and what will be the sign of your coming and of the end of the age?"

Because the question of the disciples is specific to the end time period, the answer given in Matt 24:4-32 can be interpreted in the context of Daniel 70th week. In the previous chart, Daniel's 70th week is divided in two periods, we will see that Yeshua's answer also describes two distinctive periods.

The first period is called the Birth pain

- Matt 24:4-8 "Watch out that no one deceives you. For many will come in my name, claiming, 'I am the Christ,' and will deceive many. You will hear of wars and rumors of wars, but see to it that you are not alarmed. Such things must happen, but the end is still to come. Nation will rise against nation, and kingdom against kingdom. There will be famines and earthquakes in various places. All these are the beginning of birth pains. NIV

The second period is associated with the 'ruling' of the beast (antichrist) . The period starts in the middle of Daniel's 70th week, when the beast pretends to be God and sits in the Temple, and the period ends with the 'day of the Lord'.

| | | |
|-------|---|-----|
| Start | Matt 24:15 "So when you see standing in the holy place 'the abomination that causes desolation, NIV | |
| | Rev 13:5 The beast was given a mouth to utter proud words and blasphemies and to exercise his authority for forty-two months. NIV | End |

Note: Going backward 42 months from the beginning of the new millennium i.e. years 6000 AM (after the End time events are completed) bring us back in the middle of 5996 AM, i.e. in the middle of the 70th week of Daniel (beginning of the second period).

The day of the Lord represents the sum of events that will occur during the apocalyptic time of God's wrath. This final period will come just before the start of the 7th millennium, it will be introduced during the opening of the 7th seal and will conclude with the battle of ARMAGEDDON.

- Rev 8:1-6 When he opened the seventh seal, there was silence in heaven for about half an hour. And I saw the seven angels who stand before God, and to them were given seven trumpets. ... Then the angel took the censer, filled it with fire from the altar, and hurled it on the earth; and there came peals of thunder, rumblings, flashes of lightning and an earthquake. Then the seven angels who had the seven trumpets prepared to sound them.

Note The beast will become the supreme ruler of the world once he has broken the covenant in the middle of the 70th week. He will keep his authority until he is captured at the battle of Armageddon.

- Rev 19:19-20 Then I saw the beast and the kings of the earth and their armies gathered together to make war against the rider on the horse and his army. But the beast was captured, and with him the false prophet who had performed the miraculous signs on his behalf. NIV

Given that the beast will rule for 42 months (Rev 13:5) we can deduce that the Battle of Armageddon will occur at the very end of Daniel's 70th week.

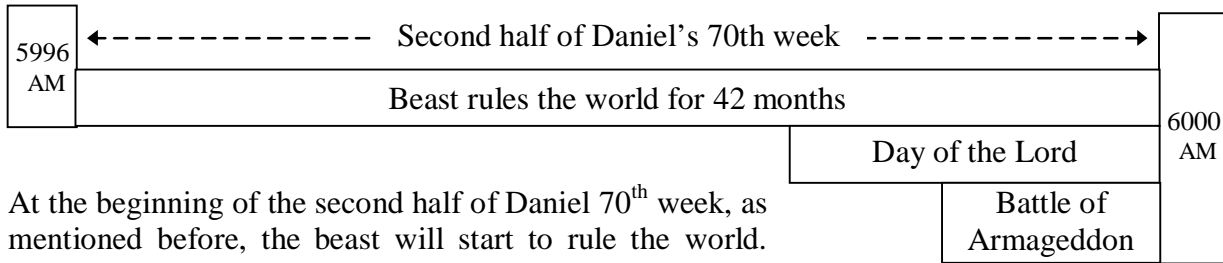

At the beginning of the second half of Daniel 70th week, as mentioned before, the beast will start to rule the world. Here is his the first major outcome of this domination.

- Matt 24:9 "Then you will be handed over to be persecuted and put to death, and you will be hated by all nations because of me. NIV
- Rev 13:7-8 He was given power to make war against the saints and to conquer them. And he was given authority over every tribe, people, language and nation. NIV

Understand here that only a specific group of people will be persecuted¹⁶⁹, put to death, and hated by the whole world. The bible refer to this event as the **Great tribulation**.

- Matt 24:21 For then shall be great **tribulation**, such as was not since the beginning of the world to this time, no, nor ever shall be. KJV
- Matt 24:10-12 At that time many will turn away from the faith and will betray and hate each other, and many false prophets will appear and deceive many people.

Notice also that this persecution will be cut short

The next chart shows that the Great tribulation doesn't occupy the whole 3.5 years of the second half of the 70th week. If it was the case it would contradict Matt 24:22 who says that the tribulation was cut short.

- Matt 24:22 If those days had not been cut short, no one would survive, but for the sake of the elect those days will be shortened. NIV

And what more logical way to cut short the tribulation than having the 'day of the Lord' start immediately after?

- Rev 8:1-2 When he opened the seventh seal, ... And I saw the seven angels who stand before God, and to them were given seven trumpets. NIV

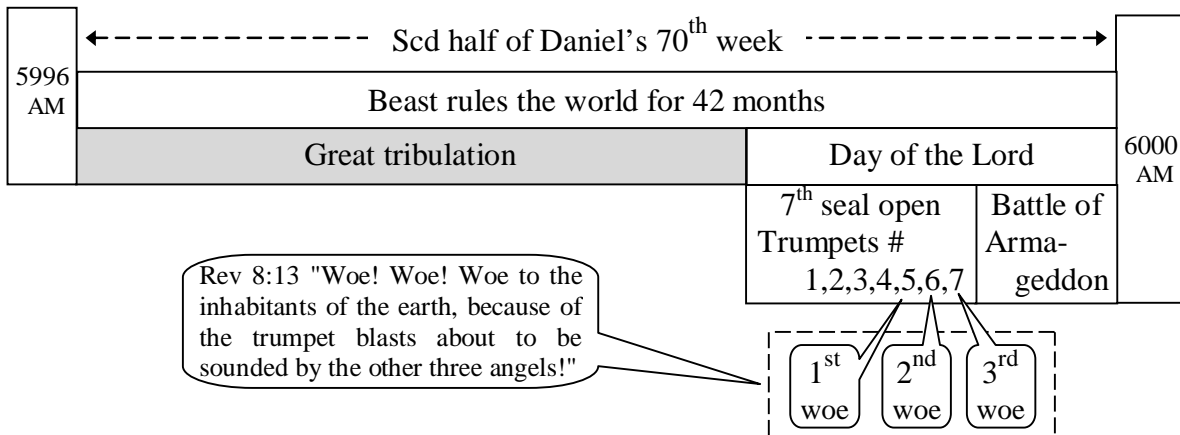

¹⁶⁹ As opposed to the first period (the birth pain) when no individual would be specifically targeted. Wars and rumor of war affect people indiscriminately.

Who will be the persecuted people of the Great Tribulation? Notice that Matt 24:9-14 was given as a private answer to the disciples and it was done in a way that could have made them expect the worse for their own life in the coming years. We know now that the first century's disciples didn't have to endure any apocalyptic tribulation. Why then, did Yeshua intimate that they would?

Could it be that Yeshua's words were pointing at his own disciples because, by formulating them that way, He knew that centuries later the right group of people would understand that the words were for them? It seems to be the proper way to analyze the facts and therefore we should find out who was truly addressed in Yeshua's answer by responding to this simple question. What is the main characteristic one needs to have to be a true 'disciple' of Yeshua? Isn't it to believe the words given by Yeshua and become faithful to Him?

Therefore one can say that by extension the group of people who will be persecuted in Yeshua's answer will be those who believe in him during the second part of the 70th week of Daniel. Don't make the mistake to identify the victims of this tribulation with the Jews. The Jews don't and won't believe in Yeshua until his second coming. And don't think either that the Antichrist, the ruler of the end time, will persecute the multitude who 'will accept' his message. On the contrary those who will submit to the beast will receive a mark and will be under his protection.

- Rev 13:16-17 He also forced everyone, small and great, rich and poor, free and slave, to receive a mark on his right hand or on his forehead, so that no one could buy or sell unless he had the mark, which is the name of the beast or the number of his name. NIV

Thus, the victims of the great tribulation will be the Christians who will refuse to worship the beast. (those who will remain faithful to Yeshua).

- Rev 13:7-8 He [*the beast*] was given power to make war **against the saints** and to conquer them. And he was given authority over every tribe, people, language and nation. All inhabitants of the earth will worship the beast—all whose names have not been written in the book of life belonging to the Lamb NIV

In the previous chart the Tribulation is followed by the Day of the Lord. Now if 'the days of the tribulation' are cut short **to prevent the dramatic consequence of an ongoing persecution** and if the Day of the Lord's purpose is to punish everybody alive at the time then there must be something between these two periods that will protect the elects from having to suffer twice. If it was not the case, the following would be highly misleading

- Matt 24:13 but he who stands firm to the end will be saved. NIV
- Matt 24:31 1 And he will send his angels with a loud trumpet call, and they will gather his elect from the four winds, from one end of the heavens to the other. NIV

When Yeshua will return at the beginning of the 'Day of the Lord', his first action¹⁷⁰ will be to **'rapture'** those alive (i.e. the Christians who won't wear the mark of the beast) and those who died for his name.

¹⁷⁰ 2 Thess 2:1 1 Concerning the coming of our Lord Jesus Christ and our being gathered to him, NIV

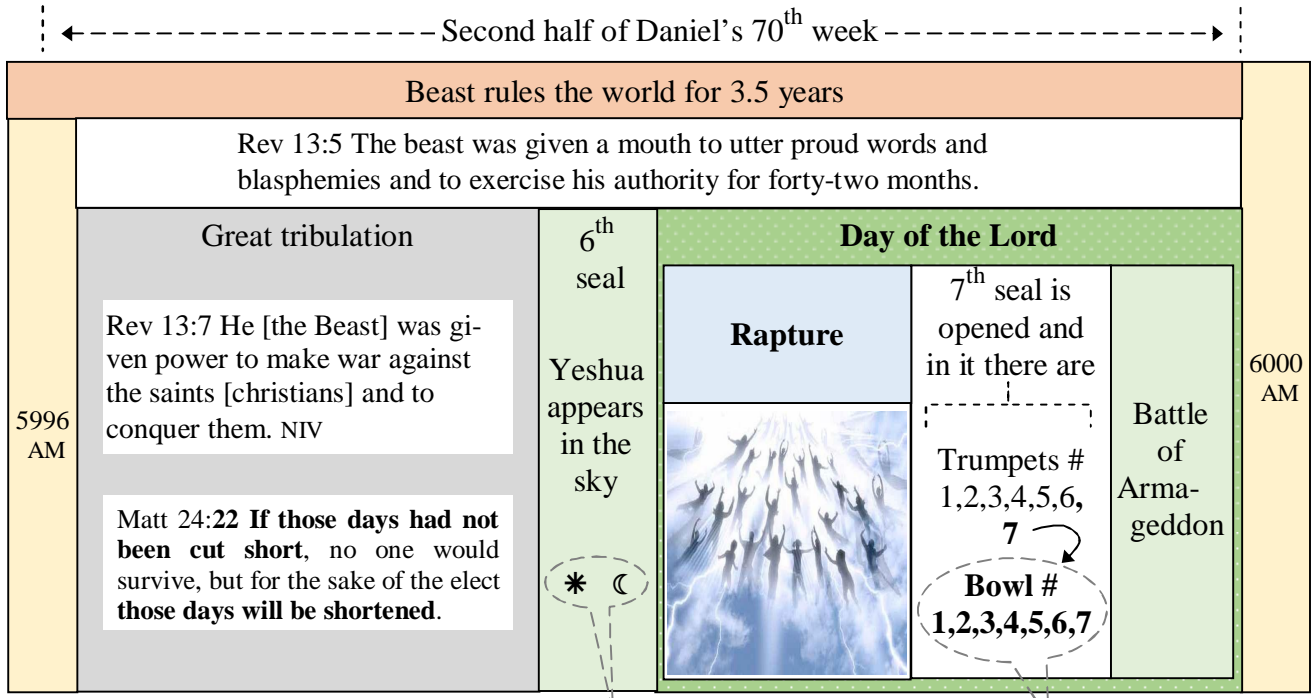

-Joel 2:31 The sun * will be turned to darkness and the moon ☾ to blood before the coming of the great and dreadful day of the LORD.

-Acts 2:20 the sun * will be turned to darkness and the moon ☾ to blood before the coming of the great and glorious day of the Lord.

-Matt 24:29-30 "Immediately after the distress of those days "the sun * will be darkened, and the moon ☾ will not give its light; the stars will fall from the sky, and the heavenly bodies will be shaken.' "At that time the sign of the Son of Man will appear in the sky

-Rev 6:12 I watched as he opened the sixth seal. There was a great earthquake. The sun * turned black like sackcloth made of goat hair, the whole moon ☾ turned blood red

Rev 15:1 seven angels with the seven last plagues- last, because with them God's wrath is completed. NIV

Rev 16:1 saying to the seven angels, "Go, pour out the seven bowls of God's wrath on the earth." NIV

Although it was cut short, we can assume that the Great tribulation will last longer than the other events of the 2nd half of Daniel 70th week. That being said we shouldn't limit the duration of the Day of the Lord to a single 24 hours day. The 5th trumpet alone will last 5 month.

- Rev 9:1,10 he fifth angel sounded his trumpet ... They had tails and stings like scorpions, and in their tails they had power to torment people for **five months**.

The two witnesses

The two witnesses are two prophets that will come to Jerusalem during the end time.

- Rev 11:3 and I will give power to my two witnesses, and they will prophesy for 1,260 days, clothed in sackcloth." NIV

I won't add to the speculation about the identity of these two men, finding the timing of their arrival is much more interesting. I don't think they will be present during the second half of Daniel 70 weeks and here are three raisons why.

A. They will be extremely powerful and nobody will be able to harm them

- Rev 11:5 If anyone tries to harm them, fire comes from their mouths and devours their enemies. This is how anyone who wants to harm them must die. NIV

But the same has been told about the beast who is going to reign in the second half of Daniel's 70 weeks.

- Rev 13:7 and he was given authority over every tribe, people, language and nation.

How could the Beast dominate the whole world and not be able to prevent the two witnesses' ministry?

B. The two witnesses will be able to **spit fire** and **prevent rain from the sky**

- Rev 11:5-6 fire comes from their mouths and devours their enemies. This is how anyone who wants to harm them must die. 6 These men have power to shut up the sky so that it will not rain during the time they are prophesying NIV

The beast will be backed by two other entities. One will spew **water from his mouth** and the other will have **fire coming from the sky** (*interesting: reversal of action VS the two witnesses*)

The dragon whose mouth had spewed water like a river

- Rev 12:15 Then from his mouth the serpent spewed water like a river, to overtake the woman and sweep her away with the torrent. NIV

A second beast who exercise authority on behalf of the first beast (rev 13:12) like having fire come down from heaven.

- Rev 13:13-14 even causing fire to come down from heaven to earth in full view of men. 14 Because of the signs he was given power to do on behalf of the first beast, he deceived the inhabitants of the earth. NIV

We can imagine how counter productive it would be to have the two witnesses, two beasts & dragon operate during the same period. Nobody would know who is responsible of what.

C. At the death of the 2 witnesses the whole world will celebrate for 3 and half a day.

- Rev 11:9-10 For three and a half days men from every people, tribe, language and nation will gaze on their bodies and refuse them burial. The inhabitants of the earth will gloat over them and will celebrate

Impossible to imagine that such a worldwide celebration could occur at the very same time of the wrap of God.

Truly, the time of the two witnesses cannot overlap the second half of Daniel 70th week.

Now lets suppose the beast first act, when he emerge in the middle of Daniel 70th week, was to get rid of the two witnesses. Wouldn't he receive every body esteem for having kill the two who had affiged them with all kind of plagues (Rev 11:6) during the previous 3.5 years? I can imagine the whole world proudly acclaiming him (the beast) while he enter the Temple pretending that he is 'god' and that he had just get rid of the beast & the false prophet mentioned in the Bible. *Unfortunately for us this master deception will occur, see Matt 24:15.*

Can we pinpoint the time of the rapture?

We have to be cautious here, trying to predict the timing of a future biblical event is dangerous. No matter how prudent one can be, there is no guaranty that all the biblical facts are known when the prediction is formulated.

I have two propositions for the timing of the Rapture. The extraordinary thing is that they are only 9 days apart.

— Feast of Trumpets on Tishri 1, 5998 AM

In their book 'The Last Shofar', Joseph Lenard & Donald Zoller develops the possibility that the rapture will happen on the Feast of Trumpets.

- 1 Cor 15:52 in a flash, in the twinkling of an eye, at the last trumpet. For the trumpet will sound, the dead will be raised im perishable, and we will be changed.

The 'last trumpet' mentioned here is not related to the 7 trumpets that will be sounded by the seven angels. In ancient Israel, many trumpets were blasted during the Feast of Trumpets 'Rosh Hashanah' (*Jewish civil new year*) and the last one was known as the 'last trumpet'.

– Start of the jubilee year on Tishri 10, 5998 AM (I would rather go with this one)

If you refer to my table on page 148 you will notice that the 70th Jubilee will start on the 10th day of the 7th month of the year 5998 AM. Why would the Jubilee fell so short of year 2000 AM, it seems somehow incomplete. But then, if the announce of this very last Jubilee was the signal for the Rapture it would make perfect sense to have this timing.

- 1 Cor 15:52 in a flash, in the twinkling of an eye, at the last trumpet. For the trumpet will sound, the dead will be raised im perishable, and we will be changed.

No other event in the history could match with the freedom that the Rapture will bring. On the same day people will be rescue from torture, persecution, slavery and from death itself. Could there be a more meaningfull Jubilee then that?

Here are the terms of a Jubilee

Lev 25:9-10 Then **have the trumpet sounded** everywhere on the tenth day of the seventh month; on the Day of Atonement sound the trumpet throughout your land. Consecrate the fiftieth year and **proclaim liberty throughout the land** to all its inhabitants. It shall be a jubilee for you; NIV

Lev 25:13 "In this Year of Jubilee **everyone is to return** to his own property. NIV

Lev 25:54-55 "Even if he is not redeemed in any of these ways, **he and his children are to be released** in the Year of Jubilee, 55 for **the Israelites belong to me as servants**. They are my servants, whom I brought out of Egypt. I am the LORD your God. NIV

What could be more fitting to match with Yeshua's first coming ministry starting in a Jubilee day, than to have Yeshua's second coming first action, the rapture, happening on the very day of the last Jubilee?

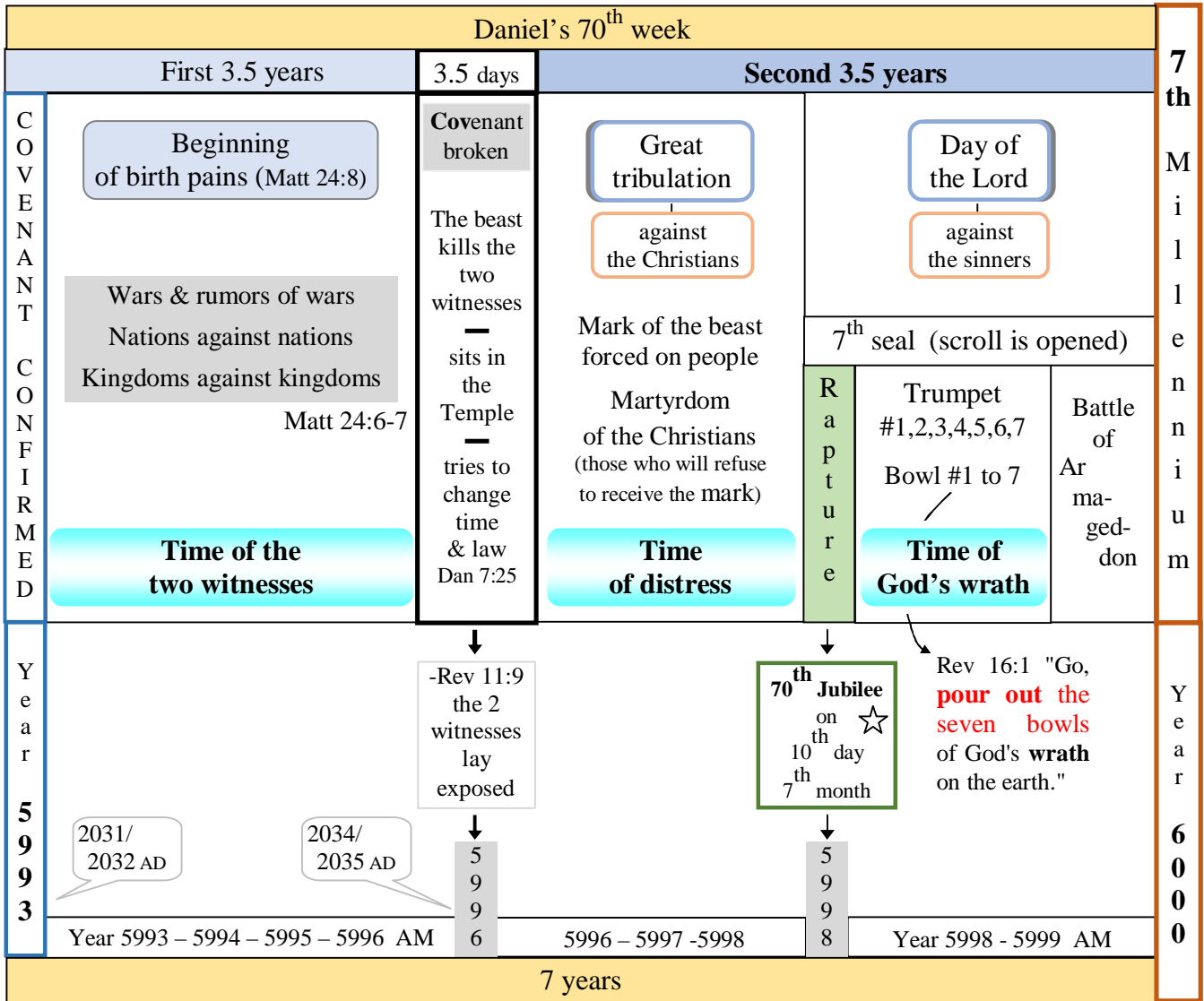

- About the Rapture -

Dan 12:1 There will be a **time of distress** such as has not happened from the beginning of nations until then. But at that time **your people ... will be delivered.**

Matt 24:31 And he will send his angels with a loud trumpet call, and they will gather his elect from the four winds, from one end of the heavens to the other.

1 Thess 4:16-17 6 For the Lord himself will come down from heaven, with a loud command, with the voice of the archangel **and with the trumpet call of God**, and the dead in Christ will rise first.

Rapture on the Jubilee day ☆
 1 Cor 15:52 in a flash, in the twinkling of an eye, at the last trumpet. For the trumpet will sound, the dead will be raised imperishable, and we will be changed.



Note: The 'last trumpet' mentioned here is not related to the 7 trumpets that will be sounded by the seven angels. In ancient Israel, on the day of the Jubilee (which occurs every 49 years on the day of Yom Kippur) a trumpet was blasted throughout the land

To the readers: The notions of Pre-Wrath (Tribulation → Rapture → Day of the Lord) is better explained by ALAN E. KURSCHNER in his very good book Antichrist Before the Day of the Lord: What Every Christian Needs to Know about the Return of Christ

Appendix J
The Kings

Access

| | | |
|---------|------------|----------------|
| 2923 AM | K. Saul | |
| 2963 AM | K. David | K. Ish-Bosheth |
| 3000 AM | K. Solomon | |

Non Access

N. K.
10 dynasties
(5+5)

| | | | | | | |
|------|-------------------------------------|------|------|------|-------------------|-----|
| SK1 | K. Rehoboam 17 | 3063 | 3063 | NK1 | K. Jeroboam 22 | D1 |
| SK2 | K. Abijah 3 | 3080 | | | | |
| SK3 | K. Asa 41 | 3082 | | | | |
| | | | 3084 | NK2 | K. Nadab 2 | D2 |
| | | | 3085 | NK3 | K. Baasha 24 | |
| | | | 3108 | NK4 | K. Elah 2 | D3 |
| | | | 3109 | NK5 | K. Zimri 7d | D4 |
| | | | | NK6 | K. Tibni 5 | |
| | | | 3120 | NK7 | K. Omri 12 | D5 |
| SK4 | K. Jehoshaphat 25 | 3123 | | NK8 | K. Ahab 22 | |
| | | | 3140 | NK9 | K. Ahaziah 2 | |
| SK5 | K. Jehoram 8 | 3145 | | NK10 | K. Joram 12 | |
| SK6 | K. Ahaziah 1 | 3151 | | | | |
| | | | | | | |
| | | | | | | |
| SK7 | Q. Athaliah 6 | 3152 | 3152 | NK11 | K. Jehu 28 | D6 |
| SK8 | K. Joash 40 (counting from 3152) | 3159 | | NK12 | K. Jehoahaz 17 | |
| | | | 3175 | NK13 | K. Jehoash 16 | |
| SK9 | K. Amaziah 29 | 3191 | | | | D7 |
| | | | 3206 | NK14 | K. Jeroboam II 41 | |
| SK10 | K. Uzzia 52 | 3233 | | NK15 | K. Zecharia 6m | D8 |
| | | | 3271 | NK16 | K. Shallum 1m | |
| | | | 3272 | NK17 | K. Menahem 10 | D9 |
| SK11 | K. Jotham 16 | 3285 | 3285 | NK18 | K. Pekahiah 2 | |
| SK12 | K. Ahaz 16 | 3302 | | NK19 | K. Pekah 20 | D10 |
| | | | 3314 | NK20 | K. Hoshea 9 | |
| SK13 | K. Hezekiah 39 | 3317 | | | | |
| SK14 | K. Manasseh 55 | 3333 | | | | |
| SK15 | K. Amon 2 | 3388 | | | | |
| SK16 | K. Josiah 31 | 3390 | | | | |
| SK17 | K. Jehoahaz 3m | 3421 | | | | |
| SK18 | K. Jehoiakim 11 | | | | | |
| SK19 | K. Jehoiachin 3m | 3432 | | | | |
| SK20 | K. Zedekiah 11 | | | | | |

Access

NOTE: This table give the the first year of each southern (SK) and northern (NK) kings of Israel. It also indicates which king was using the 'accession' or 'non-accession' year dating.
Ex: In the access mode $3063 + 17 = 3080$
In non-access mode $3063 + 22 = 3084$
See my book: **The 44 Hebrew monarchs**
(A Chronology of two kingdoms)

Appendix K 77 People of authority (11 + 22 + 44)

| 11 Judges | | 22 Patriarchs | | 44 Monarchs | | | |
|------------|------|---------------|------|---------------|------|---------------|------|
| 1 Othniel | 2601 | 1 Adam | 0 AM | Over Israel | | Over Judah | |
| 2 Ehud | 2659 | 2 Seth | 130 | 1 Saul | 2923 | 1 David | 2963 |
| 3 Deborah | 2697 | 3 Enosh | 235 | 2 Ish-Bosheth | 2963 | 2 Solomon | 3000 |
| 4 Gideon | 2756 | 4 Kenan | 325 | 3 Jeroboam | 3063 | 3 Rehoboam | 3063 |
| 5 Tola | 2799 | 5 Mahalalel | 395 | 4 Nadab | 3084 | 4 Abijah | 3080 |
| 6 Jair | 2822 | 6 Jared | 460 | 5 Baasha | 3085 | 5 Asa | 3082 |
| 7 Jephthah | 2862 | 7 Enoch | 622 | 6 Elah | 3108 | 6 Jehoshaphat | 3123 |
| 8 Ibzan | 2868 | 8 Methuselah | 687 | 7 Zimri | 3109 | 7 Jehoram | 3145 |
| 9 Elon | 2875 | 9 Lamech | 874 | 8 Tibni | 3109 | 8 Ahaziah | 3151 |
| 10 Abdon | 2885 | 10 Noah | 1056 | 9 Omri | 3109 | 9 Athaliah | 3152 |
| 11 Samuel | 2895 | 11 Shem | 1558 | 10 Ahab | 3120 | 10 Joash | 3159 |
| | | -- FLOOD -- | 1656 | 11 Ahaziah | 3140 | 11 Amaziah | 3191 |
| | | 1 Arphaxad | 1658 | 12 Joram | 3141 | 12 Uzzia | 3233 |
| | | 2 Shelah | 1693 | 13 Jehu | 3152 | 13 Jotham | 3285 |
| | | 3 Eber | 1723 | 14 Jehoahaz | 3175 | 14 Ahaz | 3302 |
| | | 4 Peleg | 1757 | 15 Jehoash | 3189 | 15 Hezekiah | 3317 |
| | | 5 Reu | 1787 | 16 Jeroboam | 3206 | 16 Manasseh | 3333 |
| | | 6 Serug | 1819 | 17 Zecharia | 3271 | 17 Amon | 3388 |
| | | 7 Nahor | 1849 | 18 Shallum | 3272 | 18 Josiah | 3390 |
| | | 8 Terah | 1878 | 19 Menahem | 3272 | 19 Jehoahaz | 3421 |
| | | 9 Abraham | 2008 | 20 Pekahiah | 3283 | 20 Jehoiakim | 3421 |
| | | 10 Isaac | 2108 | 21 Pekah | 3285 | 21 Jehoiachin | 3432 |
| | | 11 Jacob | 2168 | 22 Hoshea | 3314 | 22 Zedekiah | 3432 |

NOTE :

See judges chronology on page 168

See patriarchs chronology in Appendix A on page 227

See kings chronology in my paper

“The 44 Hebrew Monarchs”

Appendix L The 12 Symbolical acts found in Ezekiel 4-5

| LYING ON LEFT SIDE (390 days) = 390 years | | E Z E K I E L T U R N O V E R | LYING ON RIGHT SIDE (40 days) = 40 years | |
|--|--|---|--|---|
| L1 | Ezekiel prophesies 390 days Moses' escape from Egypt (2483 AM) → Ark captured (2873 AM) | | R1 | Ezekiel prophesies 40 days Jeremiah starts prophesying (3403 AM) → Temple destruction (3443 AM) |
| L2 | Ezekiel bears Israel's sins 390 days Gibeah's sin (2583 AM) → Ark brought in Jerusalem -2973 | | R2 | Ezekiel bears Judah's sins 40 days Manasseh's Abomination (3368 AM) → Josiah's Passover (3408 AM) |
| L3 | Ezekiel eats defiled food 390 days Foundation of Samaria (3113 AM) → Return of the 42,360 exiles -3503 | | R3 | Ezekiel fasts 40 days Judah returns from Exile-3503 AM → Nehemiah completes the wall-3543 |
| <p>Combined SIDES 390 + 40 days) = 430 years</p> <p>(The following symbolical acts were not interrupted when Ezekiel changed side)</p> | | | | |
| Ezekiel lies bare arm for 430 days | Exodus 2523 AM) | C1 → | Samuel's death 2953 AM | |
| Ezekiel shaves his hair 430 days | Ark captured 2873 AM | C2 → | Isaiah's foretelling 3303 AM | |
| Ezekiel holds a siege for 430 days | Ark brought in the first Temple 3013 AM | C3 → | Destruction of Jerusalem 3443 AM | |
| Ezekiel weighs and divides his hair 430 days | Kingdom's split 3063 | C4 → | Fall of Babylon 3493 AM | |
| Ezekiel hair growing for 430 days | Construction of 2 nd Temple 3513 AM | C5 → | Herod repairs the Temple 3943 AM | |
| Ezekiel is mute for 430 days | First Purim 3559 AM | C6 → | Start of Yeshua's ministry 3989 AM | |

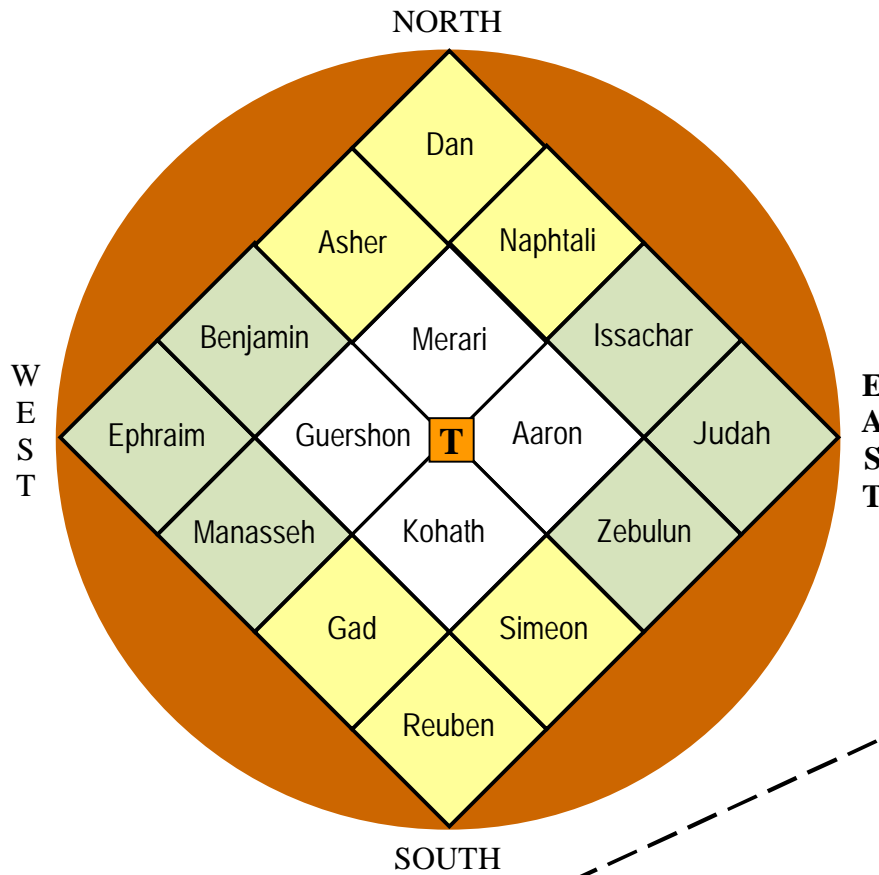

Wilderness Encampment

According
Vernon Jenkins

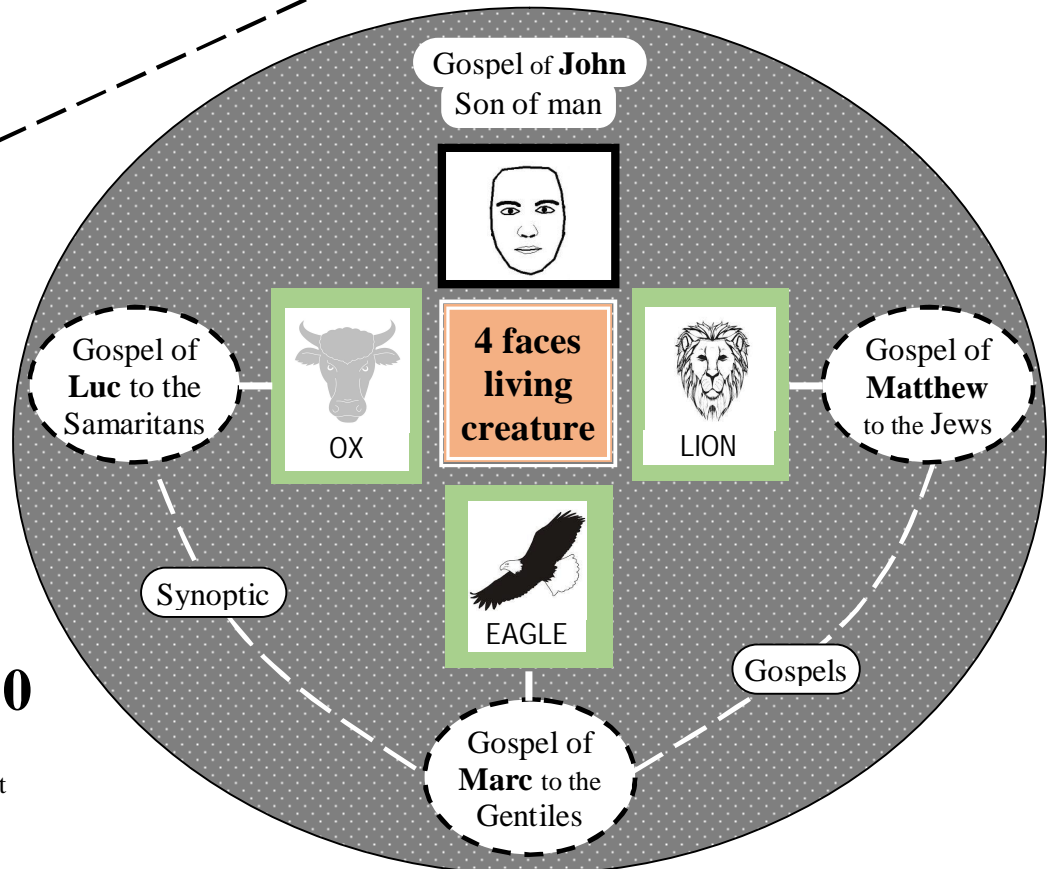
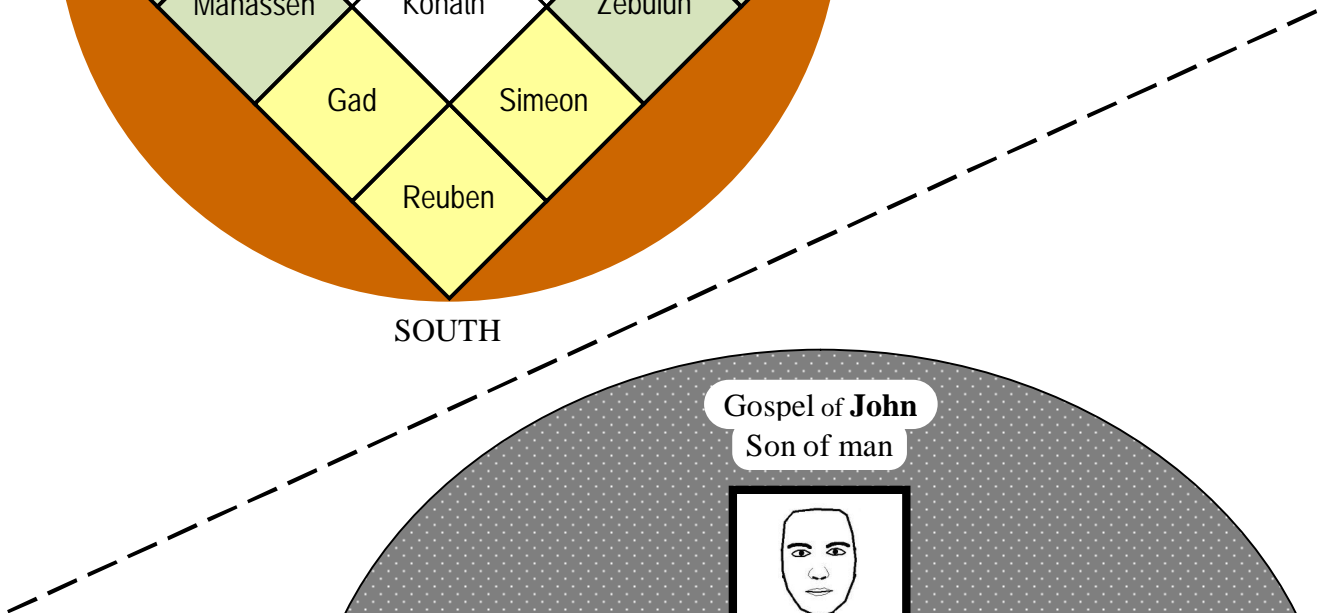

4 faces of Ezekiel 1:10

According
Darek Barefoot

Copyright©2015 by Yves Peloquin
ALL RIGHTS RESERVED

No part of this publication may be used for commercial purposes. The readers are allowed to save, print or send this PDF to whoever they want as far as they don't alter its content.