

24 BAKER ST., P.O. BOX 100, HASTINGS ON KOL. - 1YO
705-696-2385, 1-800-465-3433, FAX: 705-696-1922

14'X31' R.H. HIGHLANDER

QTY.	LENGTH	RADIUS	TYPE
1	8'0"	7'0"	PLAIN
1	8'0"	7'0"	RETURN
1	6'0"	7'0"	PLAIN
1	6'0"	8'0"	PLAIN
1	6'0"	8'0"	REVERSE
4	3'2"	4'0"	CORNER
1	8'0"	NA	PLAIN
1	8'0"	NA	SKIMMER
1	6'0"	NA	RETURN
1	6'0"	NA	PLAIN
1	5'0"	NA	PLAIN
12	-	NA	A-FRAME
1	-	NA	N&B PKG
			S.A. 403 sq.ft.
			PER: 79'6"
143IHLC			DATE: 01-13-03

STAKE OUT			
A-C	6'	B-C	11'8"
A-D	10'	B-D	6'3-7/8"
A-E	13'8-3/4"	B-E	4'9-1/4"
A-F	20'	B-F	22'4-1/4"
A-G	23'10-1/4"	B-G	20'2-3/4"
A-H	25'3-1/2"	B-H	19'4"
A-I	26'7-7/8"	B-I	18'9-1/4"
A-J	24'4-5/8"	B-J	15'3-1/2"
A-K	19'3-1/8"	B-K	9'7-1/2"
A-L		B-L	
A-M		B-M	

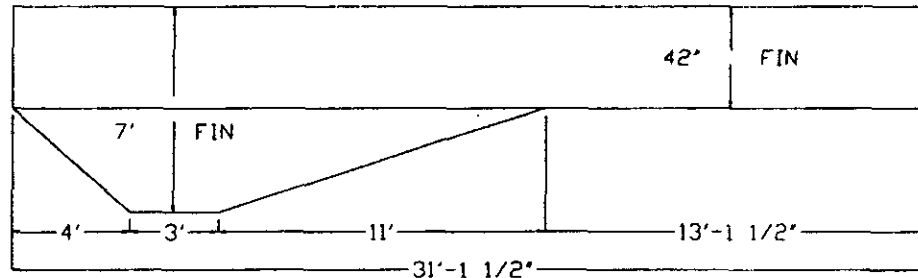
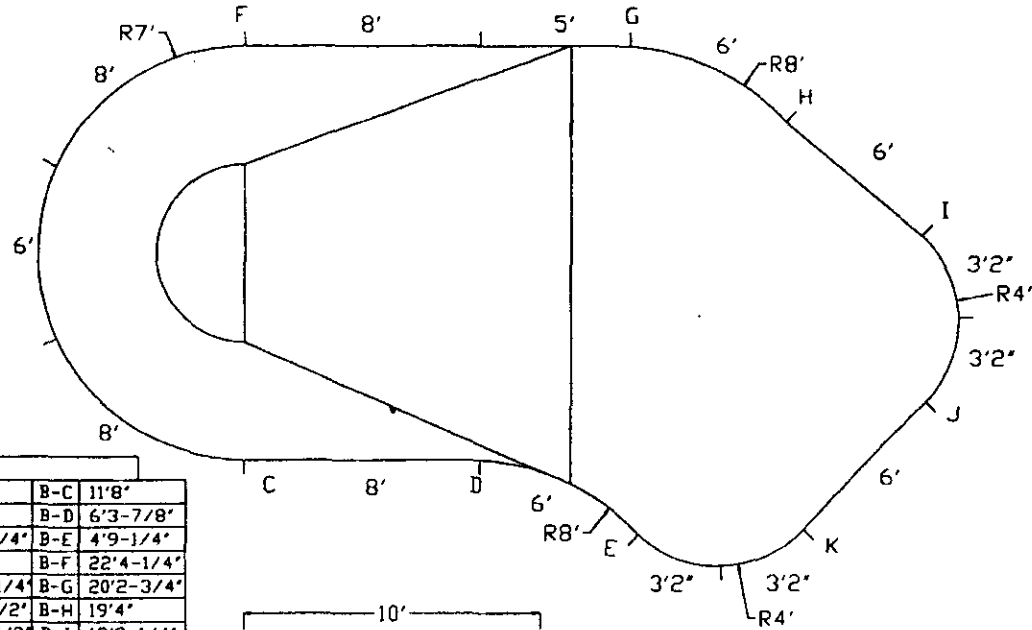

REVISED 2003

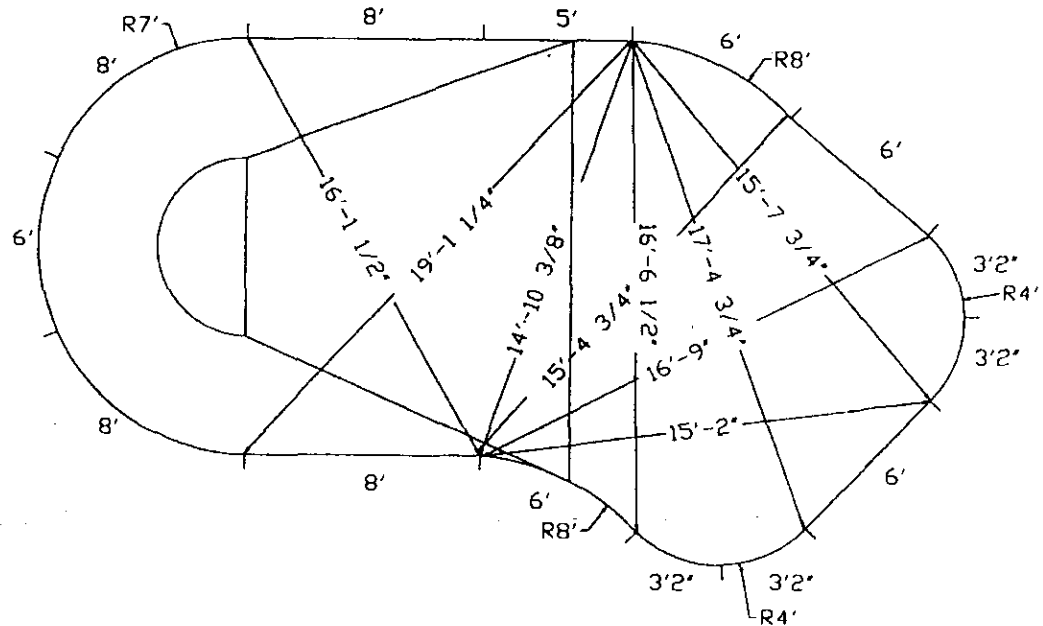
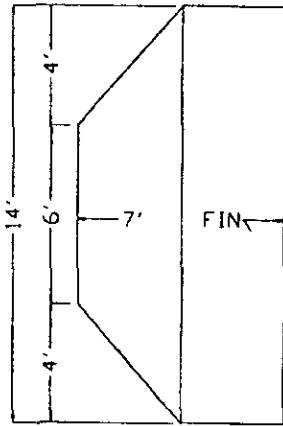

24 BAKER ST, P.O. BOX 100, HASTINGS ON KOL - 1Y0
 705-696-2385, 1-800-465-3433, FAX: 705-696-1922

14'X31' R.H. HIGHLANDER

QTY.	LENGTH	RADIUS	TYPE
1	8'0"	7'0"	PLAIN
1	8'0"	7'0"	RETURN
1	6'0"	7'0"	PLAIN
1	6'0"	8'0"	PLAIN
1	6'0"	8'0"	REVERSE
4	3'2"	4'0"	CORNER
1	8'0"	NA	PLAIN
1	8'0"	NA	SKIMMER
1	6'0"	NA	RETURN
1	6'0"	NA	PLAIN
1	5'0"	NA	PLAIN
12	-	NA	A-FRAME
1	-	NA	N&B PKG
			S.A.: 403 sq.ft.
			PER: 79'6"
143IHILC			DATE: 01-15-03

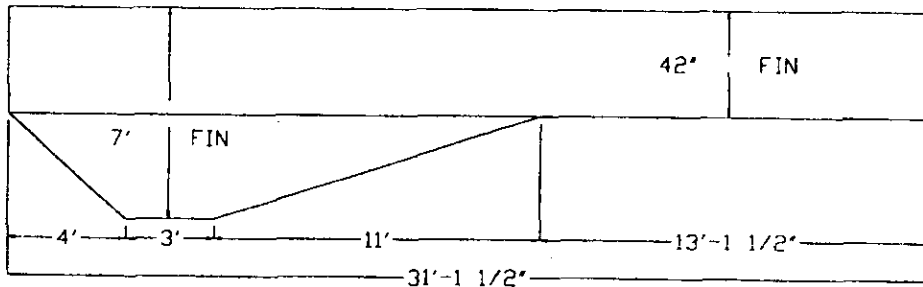

REVISED 2003

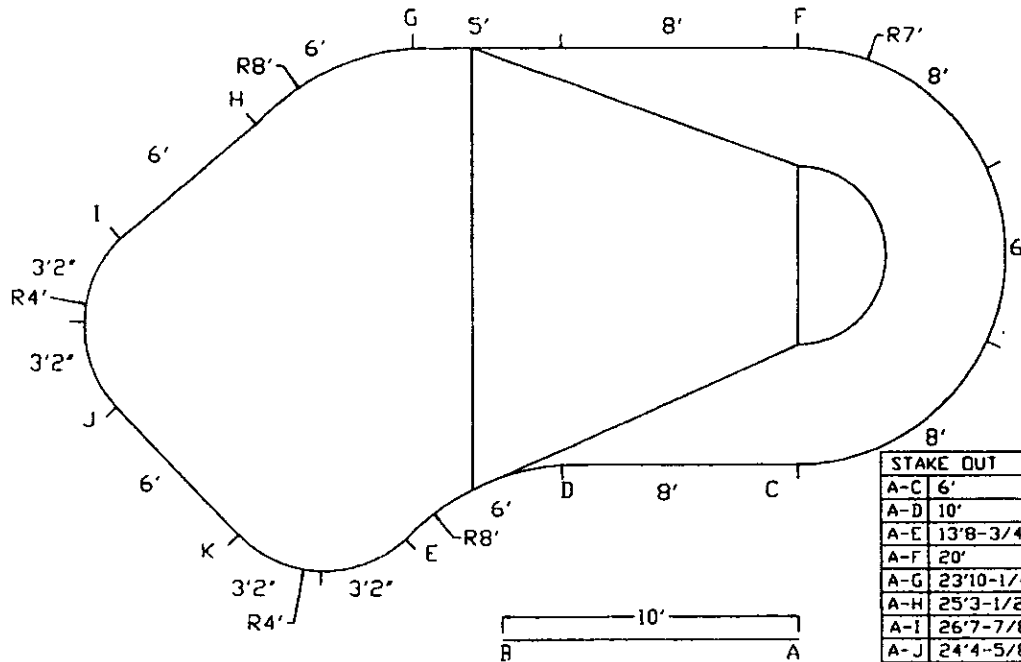

STAKE OUT			
A-C	6'	B-C	11'8"
A-D	10'	B-D	6'3-7/8"
A-E	13'8-3/4"	B-E	4'9-1/4"
A-F	20'	B-F	22'4-1/4"
A-G	23'10-1/4"	B-G	20'2-3/4"
A-H	25'3-1/2"	B-H	19'4"
A-I	26'7-7/8"	B-I	18'9-1/4"
A-J	24'4-5/8"	B-J	15'3-1/2"
A-K	19'3-1/8"	B-K	9'7-1/2"
A-L		B-L	
A-M		B-M	

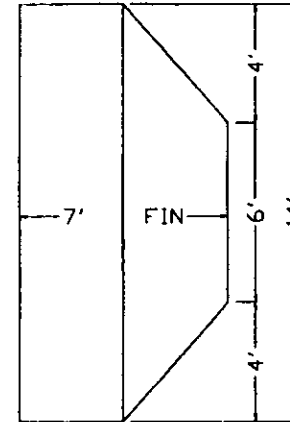

24 BAKER ST., P.O. BOX 100, HASTINGS ON KOL. - IYO
705-696-2385, 1-800-465-3433, FAX: 705-696-1922

14'X31' L.H. HIGHLANDER

QTY.	LENGTH	RADIUS	TYPE
1	8'0"	7'0"	PLAIN
1	8'0"	7'0"	RETURN
1	6'0"	7'0"	PLAIN
1	6'0"	8'0"	PLAIN
1	6'0"	8'0"	REVERSE
4	3'2"	4'0"	CORNER
1	8'0"	NA	PLAIN
1	8'0"	NA	SKIMMER
1	6'0"	NA	RETURN
1	6'0"	NA	PLAIN
1	5'0"	NA	PLAIN
12	-	NA	A-FRAME
1	-	NA	N&B PKG
			S.A.: 403 sq.ft.
			PER: 79'6"
1431HILC			DATE: 01-15-03

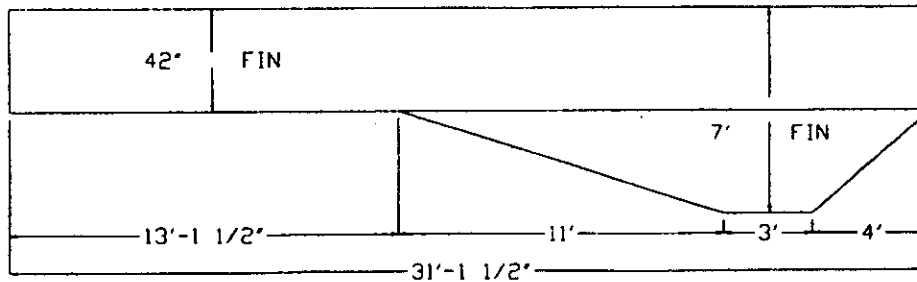

REVISED 2003

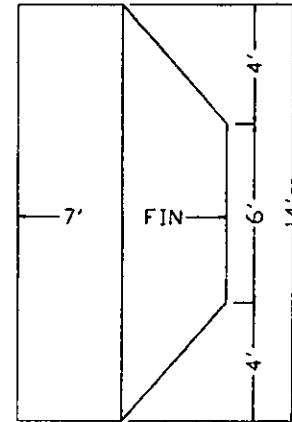
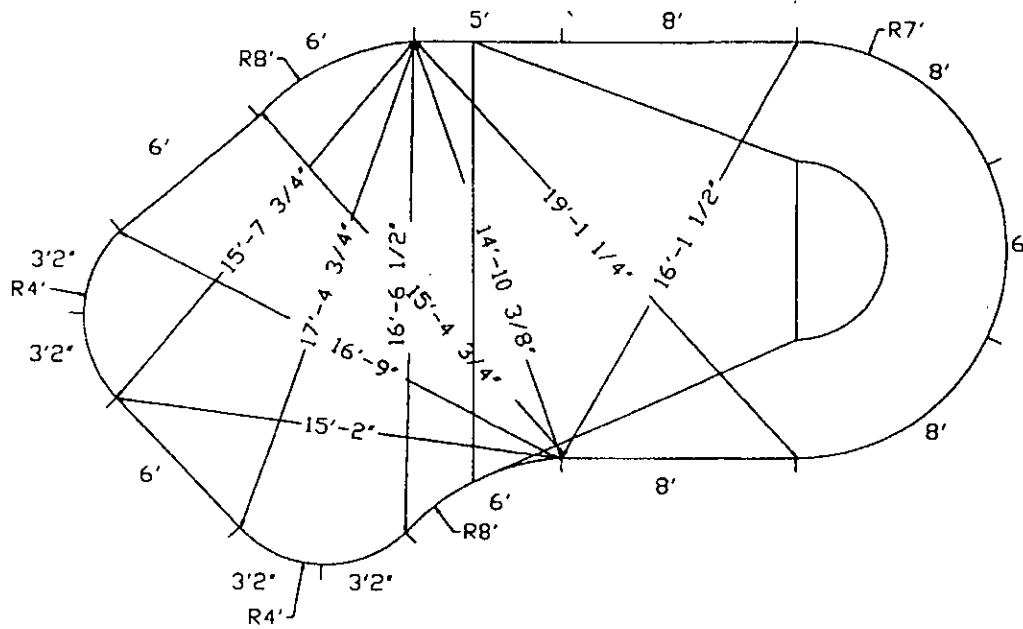

24 BAKER ST. P.O. BOX 100, HASTINGS ON KOL-1YO
705-696-2385, 1-800-465-3433, FAX: 705-696-1922

14'X31' L.H. HIGHLANDER

QTY.	LENGTH	RADIUS	TYPE
1	8'0"	7'0"	PLAIN
1	8'0"	7'0"	RETURN
1	6'0"	7'0"	PLAIN
1	6'0"	8'0"	PLAIN
1	6'0"	8'0"	REVERSE
4	3'2"	4'0"	CORNER
1	8'0"	NA	PLAIN
1	8'0"	NA	SKIMMER
1	6'0"	NA	RETURN
1	6'0"	NA	PLAIN
1	5'0"	NA	PLAIN
12	-	NA	A-FRAME
1	-	NA	N&B PKG

S.A: 403 sq.ft.

PER: 79'6"

143110LC

DATE: 01 15-03

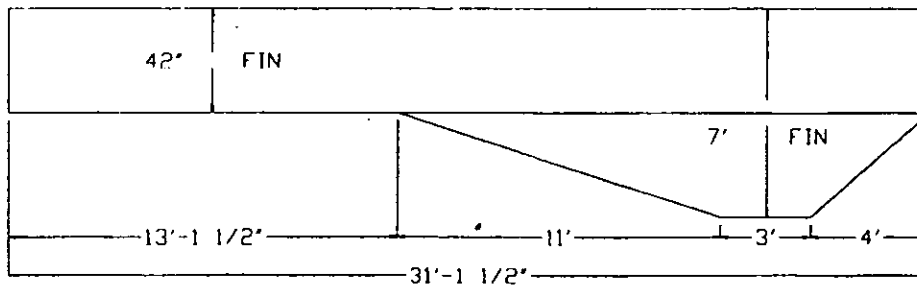

REVISED 2003

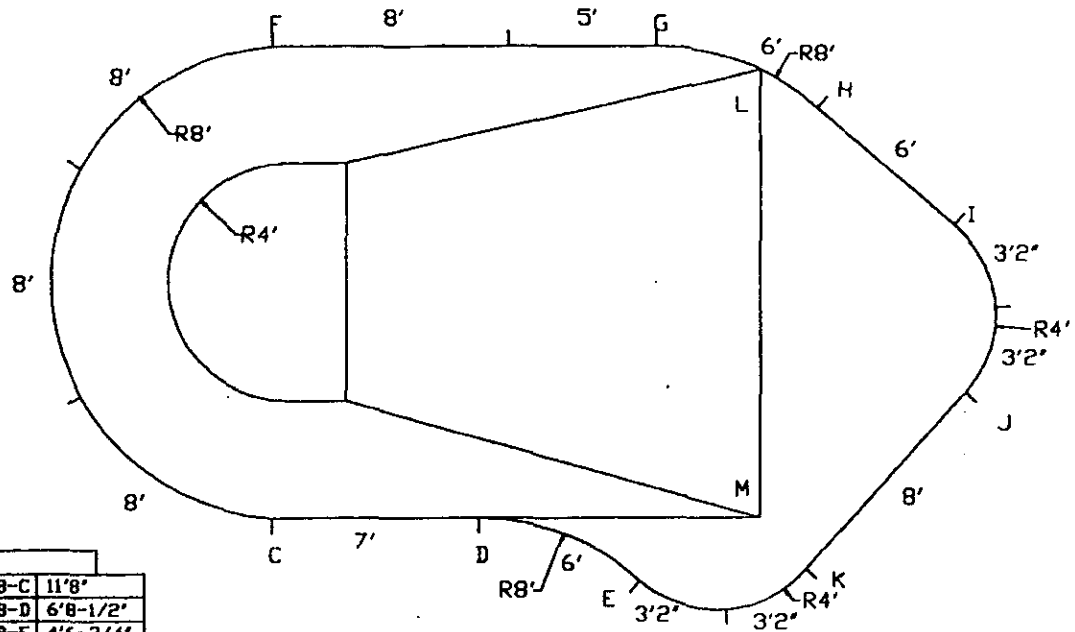
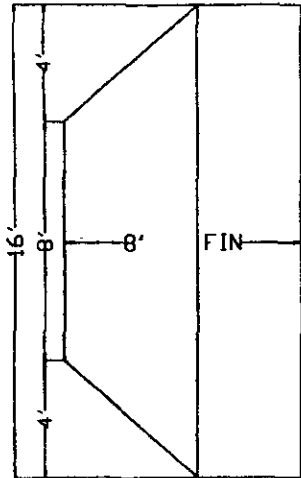

STAKE OUT			
A-C	6'	B-C	11'8"
A-D	9'2-5/8"	B-D	6'8-1/2"
A-E	13'-1/2"	B-E	4'6-3/4"
A-F	22'	B-F	24'2"
A-G	25'6-5/8"	B-G	22'2-1/2"
A-H	27'1-1/4"	B-H	21'7"
A-I	27'11-3/8"	B-I	20'6-1/4"
A-J	25'6-1/4"	B-J	16'10"
A-K	18'7"	B-K	9'1-5/8"
A-L	26'10-1/4"	B-L	22'2"
A-M	17'6-3/4"	B-M	8'10"

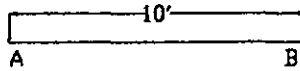

24 BAKER ST., P.O. BOX 100, HASTINGS ON KOL - 1Y0
 705-696-2385, 1-800-465-3433, FAX 705-696-1922

16'X32' R.H. HIGHLANDER

QTY.	LENGTH	RADIUS	TYPE
2	8'0"	8'0"	PLAIN
1	8'0"	8'0"	RETURN
1	6'0"	8'0"	PLAIN
1	6'0"	8'0"	REVERSE
4	3'2"	4'0"	CORNER
1	8'0"	NA	RETURN
1	8'0"	NA	SKIMMER
1	7'0"	NA	PLAIN
1	6'0"	NA	PLAIN
1	5'0"	NA	PLAIN
12	-	NA	A-FRAME
1	-	NA	N&B PKG
			S.A. 457 sq.ft.
			PER. 82'8"

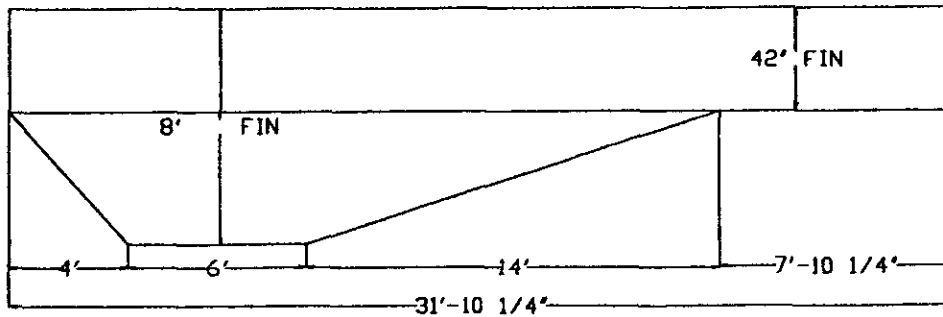

1632HILC

DATE: 09-11-00

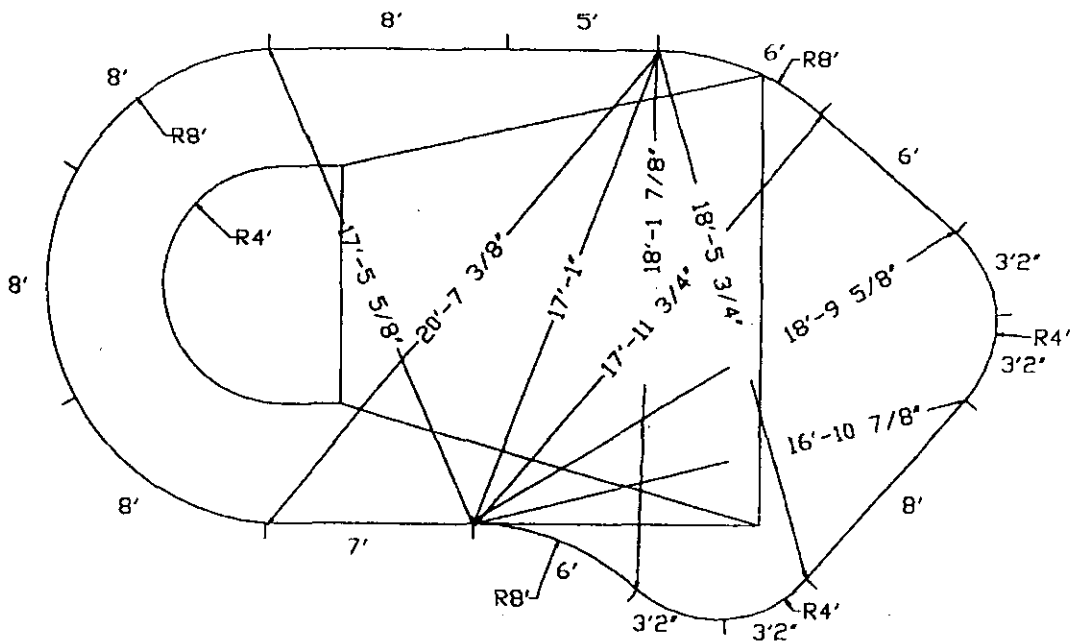
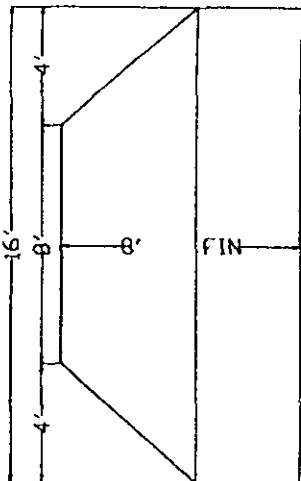

24 BAKER ST. P.O. BOX 100, HASTINGS DN. KOL-1Y0
 705-696-2385, 1-800-465-3433, FAX: 705-696-1922

16'X32' R.H. HIGHLANDER

QTY.	LENGTH	RADIUS	TYPE
2	8'0"	8'0"	PLAIN
1	8'0"	8'0"	RETURN
1	6'0"	8'0"	PLAIN
1	6'0"	8'0"	REVERSE
4	3'2"	4'0"	CORNER
1	8'0"	NA	RETURN
1	8'0"	NA	SKINNER
1	7'0"	NA	PLAIN
1	6'0"	NA	PLAIN
1	5'0"	NA	PLAIN
12	-	NA	A-FRAME
1	-	NA	N&B PKG
			S.A.: 457 sq.ft.
			PER: 82'8"
1632HILC			DATE: 09-11-00

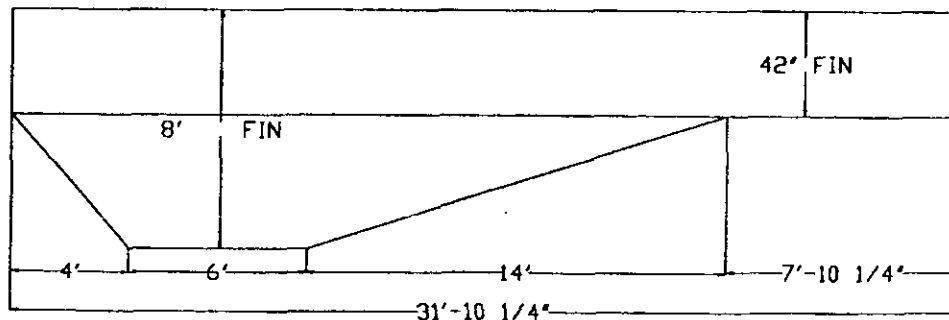

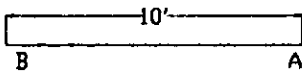
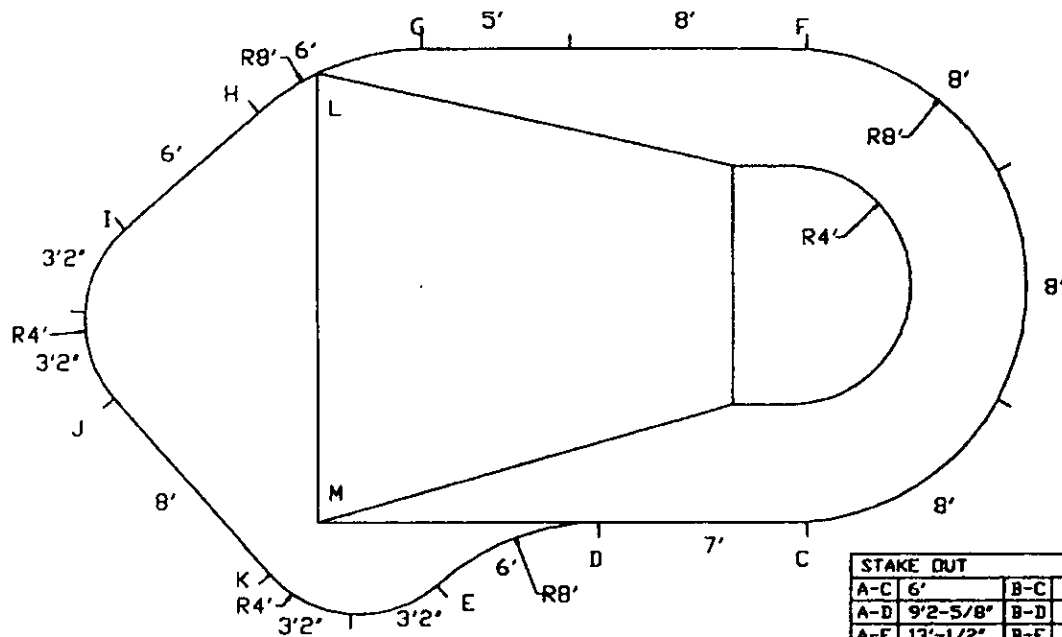

STAKE OUT			
A-C	6'	B-C	11'8"
A-D	9'2-5/8"	B-D	6'8-1/2"
A-E	13'-1/2"	B-E	4'6-3/4"
A-F	22'	B-F	24'2"
A-G	25'6-5/8"	B-G	22'2-1/2"
A-H	27'1-1/4"	B-H	21'7"
A-I	27'11-3/8"	B-I	20'6-1/4"
A-J	25'6-1/4"	B-J	16'10"
A-K	18'7"	B-K	9'1-5/8"
A-L	26'10-1/4"	B-L	22'2"
A-M	17'6-3/4"	B-M	8'10"

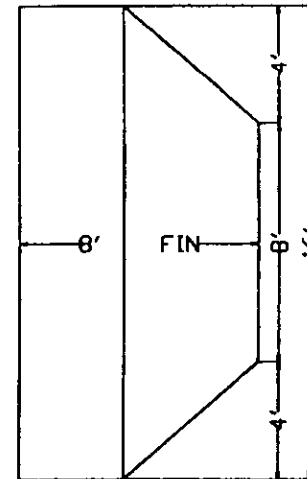

24 BAKER ST. P.O. BOX 100 HASTINGS ON KOL-1YO
705-696-2385 J-800-465-3433 FAX: 705-696-1922

16'X32' L.H. HIGHLANDER

QTY.	LENGTH	RADIUS	TYPE
2	8'0"	8'0"	PLAIN
1	8'0"	8'0"	RETURN
1	6'0"	8'0"	PLAIN
1	6'0"	8'0"	REVERSE
4	3'2"	4'0"	CORNER
1	8'0"	NA	RETURN
1	8'0"	NA	SKIMMER
1	7'0"	NA	PLAIN
1	6'0"	NA	PLAIN
1	5'0"	NA	PLAIN
12	-	NA	A-FRAME
1	-	NA	N&B PKG
			SA: 457 sq.ft.
			PER: 82'8"
1632HILC			DATE: 09-11-00

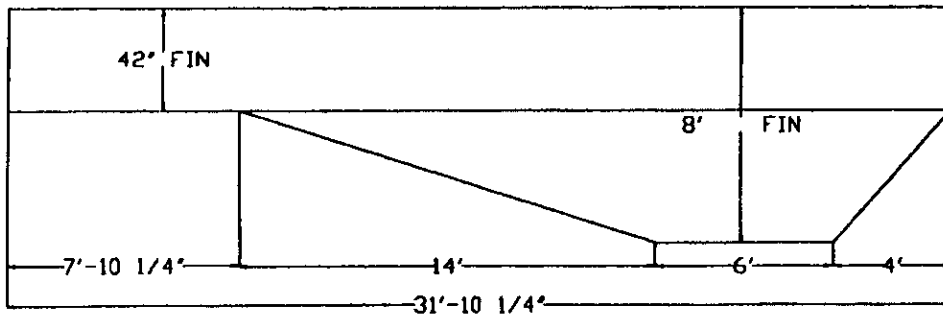

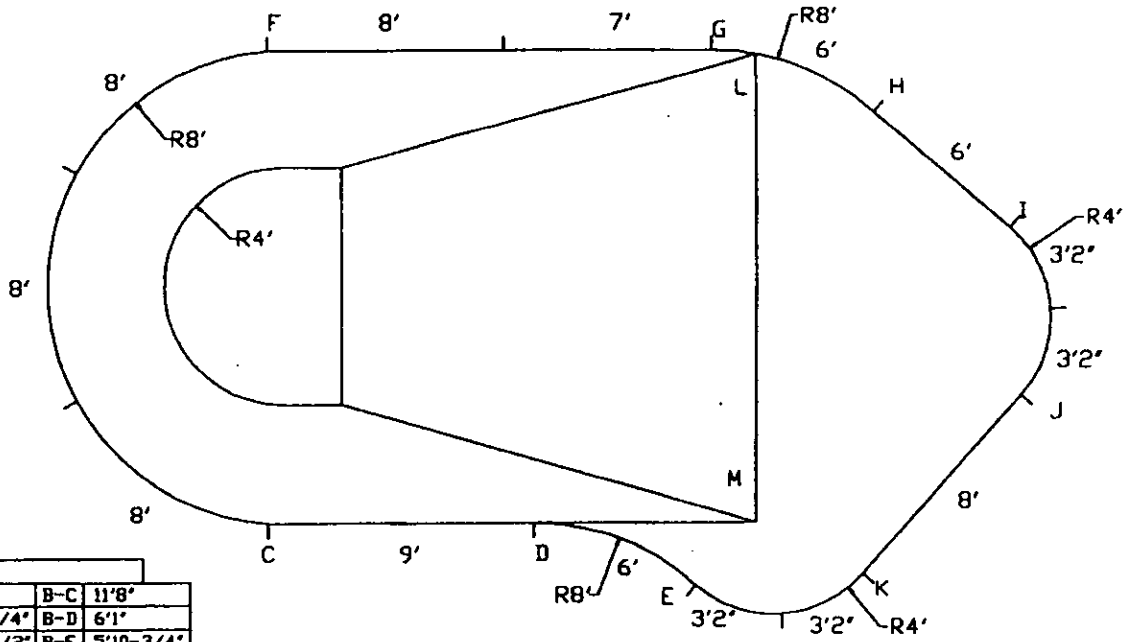
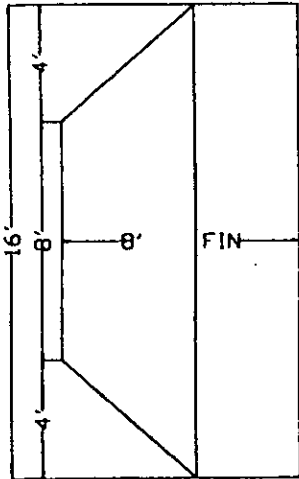

STAKE OUT	
A-C 6'	B-C 11'8"
A-D 10'9-3/4"	B-D 6'1"
A-E 14'11-1/2"	B-E 5'10-3/4"
A-F 22'	B-F 24'2"
A-G 26'7-1/2"	B-G 22'6-3/4"
A-H 28'6"	B-H 22'5-1/4"
A-I 29'7-1/4"	B-I 21'10-1/4"
A-J 27'4-1/4"	B-J 18'5-3/4"
A-K 20'6-1/2"	B-K 10'11-3/8"
A-L 27'4-5/8"	B-L 22'9-5/8"
A-M 17'6-3/4"	B-M 8'10"

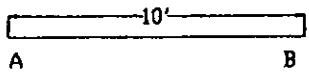

24 BAKER ST. P.O. BOX 100, HASTINGS ON KOL. 1Y0
 705-696-2385, 1-800-465-3433, FAX: 705-696-1922

16'X34' R.H. HIGHLANDER

QTY.	LENGTH	RADIUS	TYPE
2	8'0"	8'0"	PLAIN
1	8'0"	8'0"	RETURN
1	6'0"	8'0"	PLAIN
1	6'0"	8'0"	REVERSE
4	3'2"	4'0"	CORNER
1	9'0"	NA	PLAIN
1	8'0"	NA	RETURN
1	8'0"	NA	SKIMMER
1	7'0"	NA	PLAIN
1	6'0"	NA	PLAIN
12	-	NA	A-FRAME
1	-	NA	N&B PKG
			S.A. 489 sq.ft.
			PER: 86'8"
1634HILC			DATE: 09-11-00

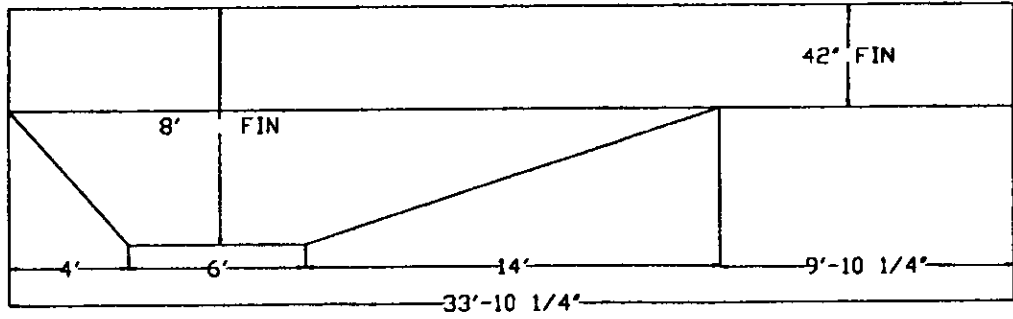

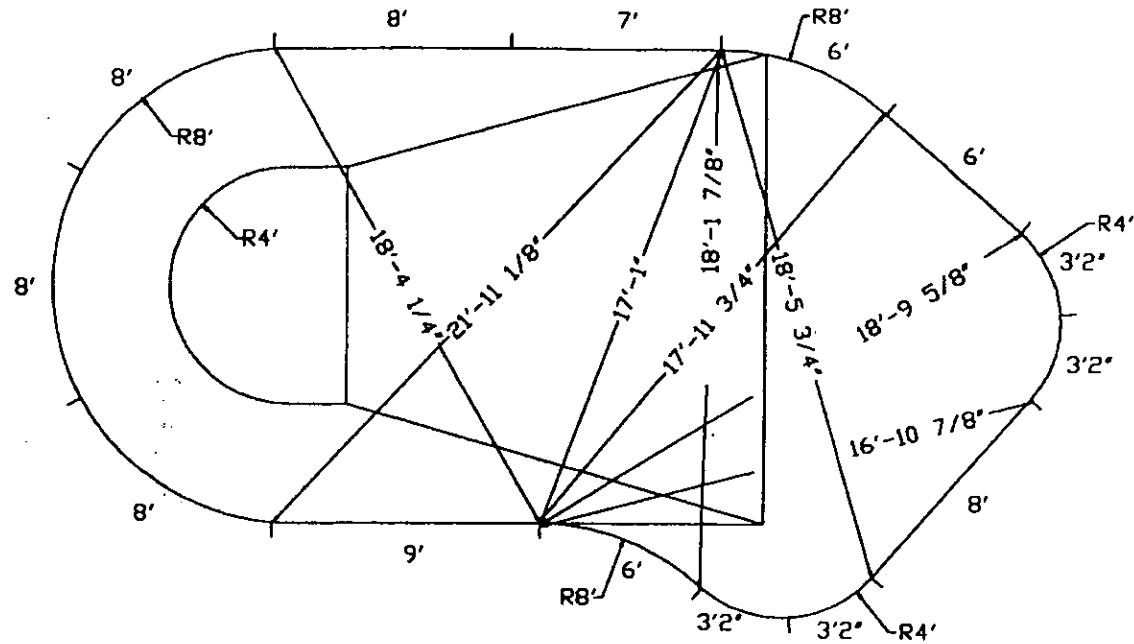
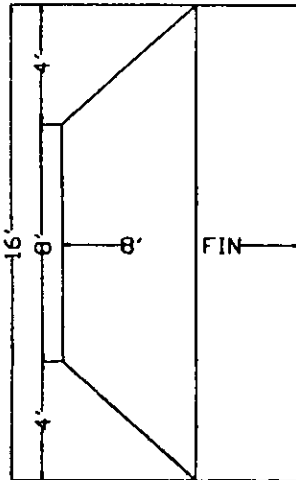

24 BAKER ST. P.O. BOX 100, HASTINGS ON KOL-1Y0
 705-696-2385, 1-800-465-3433, FAX 705-696-1922

16'X34' R.H. HIGHLANDER

QTY.	LENGTH	RADIUS	TYPE
2	8'0"	8'0"	PLAIN
1	8'0"	8'0"	RETURN
1	6'0"	8'0"	PLAIN
1	6'0"	8'0"	REVERSE
4	3'2"	4'0"	CORNER
1	9'0"	NA	PLAIN
1	8'0"	NA	RETURN
1	8'0"	NA	SKIMMER
1	7'0"	NA	PLAIN
1	6'0"	NA	PLAIN

12	-	NA	A-FRAME
1	-	NA	N&B PKG
			S.A. 489 sq.ft.
			PER. 86'8'
1634HILC			DATE: 09-11-00

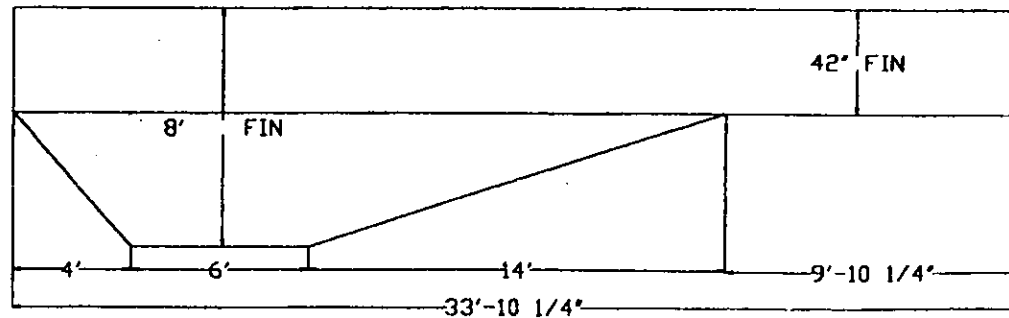

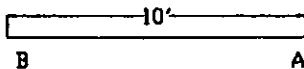
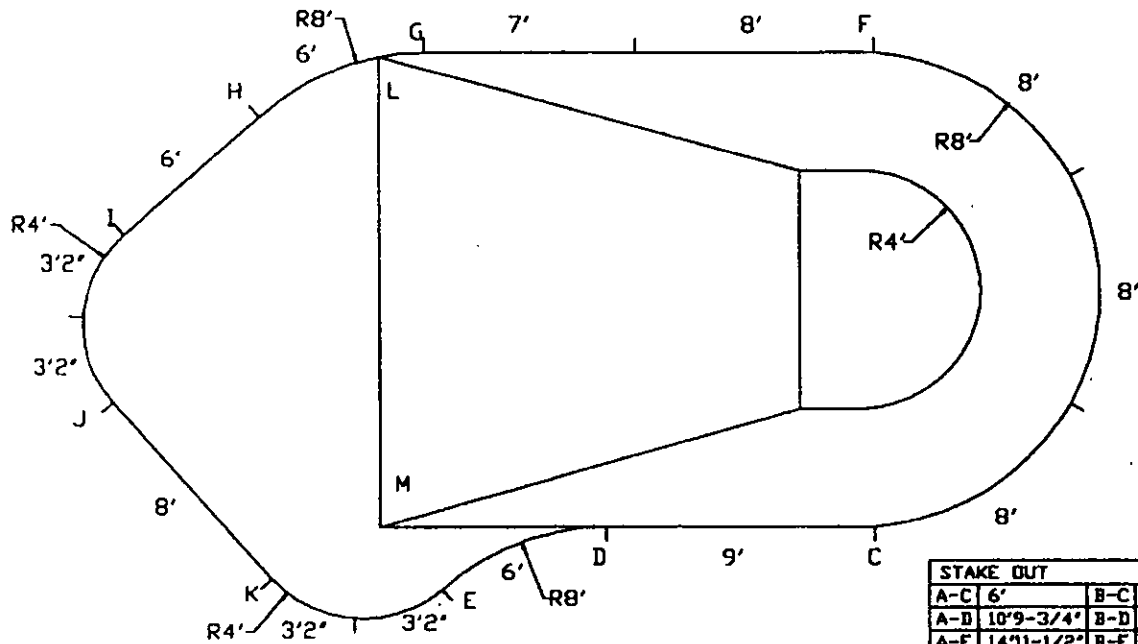

STAKE OUT			
A-C	6'	B-C	11'8"
A-D	10'9-3/4"	B-D	6'1"
A-E	14'11-1/2"	B-E	5'10-3/4"
A-F	22'	B-F	24'2"
A-G	26'7-1/2"	B-G	22'6-3/4"
A-H	28'6"	B-H	22'5-1/4"
A-I	29'7-1/4"	B-I	21'10-1/4"
A-J	27'4-1/4"	B-J	18'5-3/4"
A-K	20'6-1/2"	B-K	10'11-3/8"
A-L	27'4-5/8"	B-L	22'9-5/8"
A-M	17'6-3/4"	B-M	8'10"

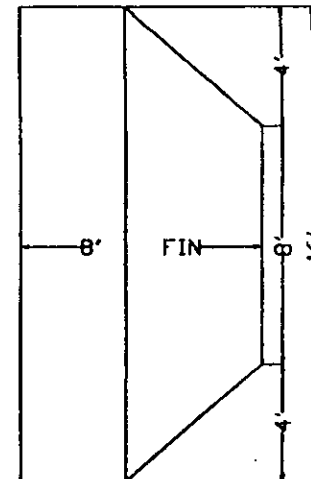

24 BAKER ST. P.O. BOX 100, HASTINGS ON KOL-1YO
705-696-2385, 1-800-465-3433, FAX 705-696-1922

16'X34' L.H. HIGHLANDER

QTY.	LENGTH	RADIUS	TYPE
2	8'0"	8'0"	PLAIN
1	8'0"	8'0"	RETURN
1	6'0"	8'0"	PLAIN
1	6'0"	8'0"	REVERSE
4	3'2"	4'0"	CORNER
1	9'0"	NA	PLAIN
1	8'0"	NA	RETURN
1	8'0"	NA	SKINNER
1	7'0"	NA	PLAIN
1	6'0"	NA	PLAIN

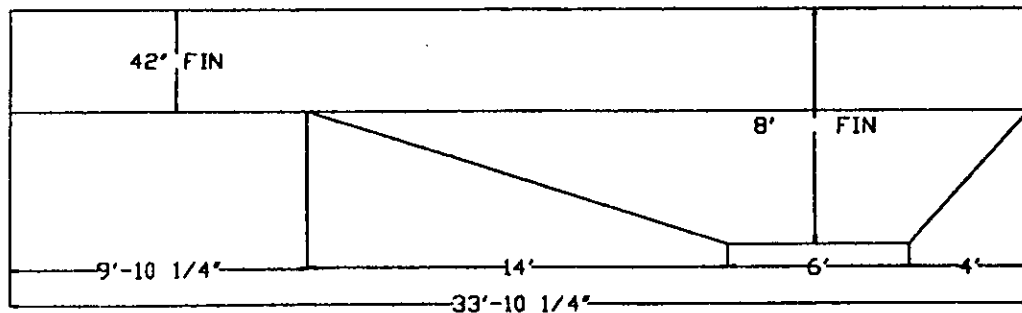

12	-	NA	A-FRAME
1	-	NA	N&B PKG
			SA: 489 sq.ft.
			PER: 86'8"
1634HILC			DATE: 09-11-00

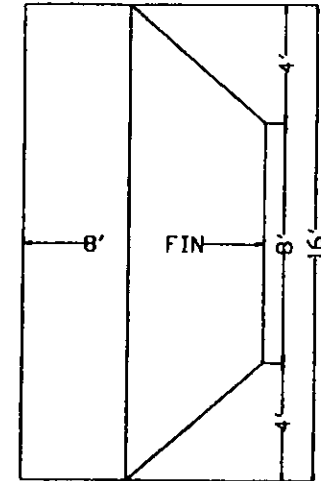
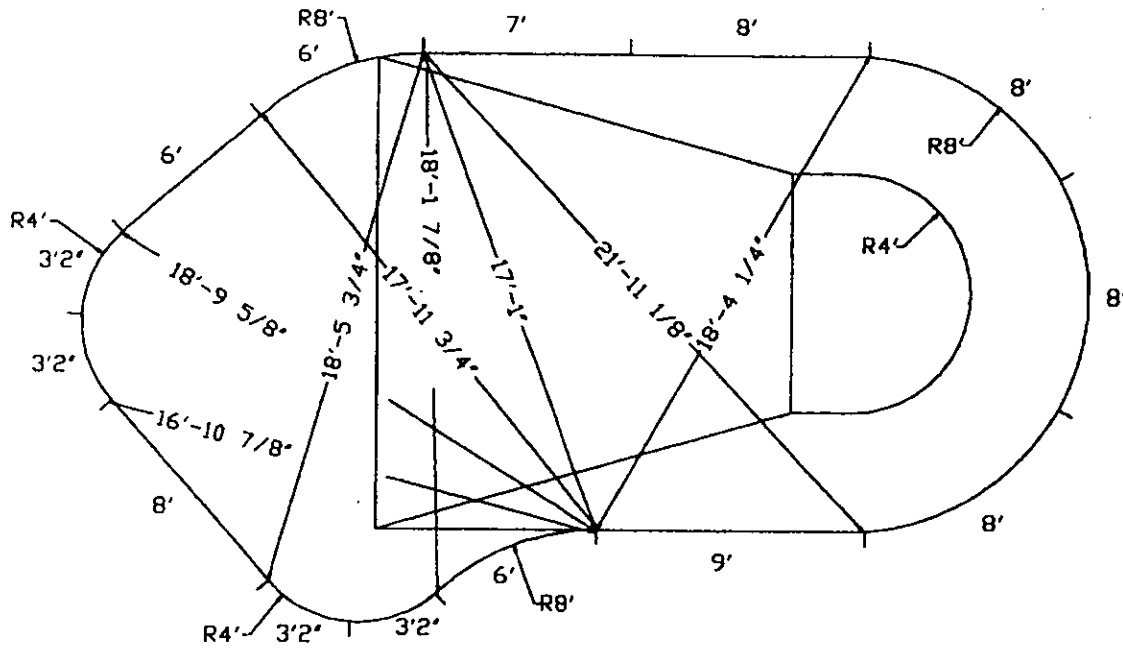

24 BAKER ST., P.O. BOX 100, HASTINGS DN, KOL-1Y0
 705-696-2385, 1-800-465-3433, FAX: 705-696-1922

16'X34' L.H. HIGHLANDER

QTY.	LENGTH	RADIUS	TYPE
2	8'0"	8'0"	PLAIN
1	8'0"	8'0"	RETURN
1	6'0"	8'0"	PLAIN
1	6'0"	8'0"	REVERSE
4	3'2"	4'0"	CORNER
1	9'0"	NA	PLAIN
1	8'0"	NA	RETURN
1	8'0"	NA	SKIMMER
1	7'0"	NA	PLAIN
1	6'0"	NA	PLAIN

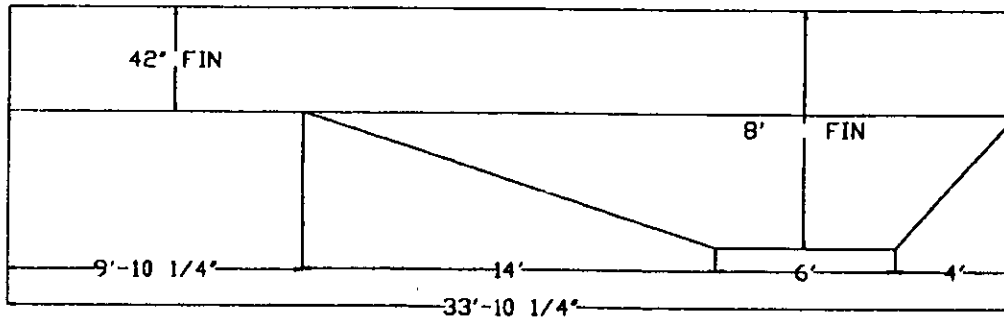

12	-	NA	A-FRAME
1	-	NA	N&B PKG
			S.A. 489 sq.ft.
			PER: 86'8"
1634HILC			DATE: 09-11-00

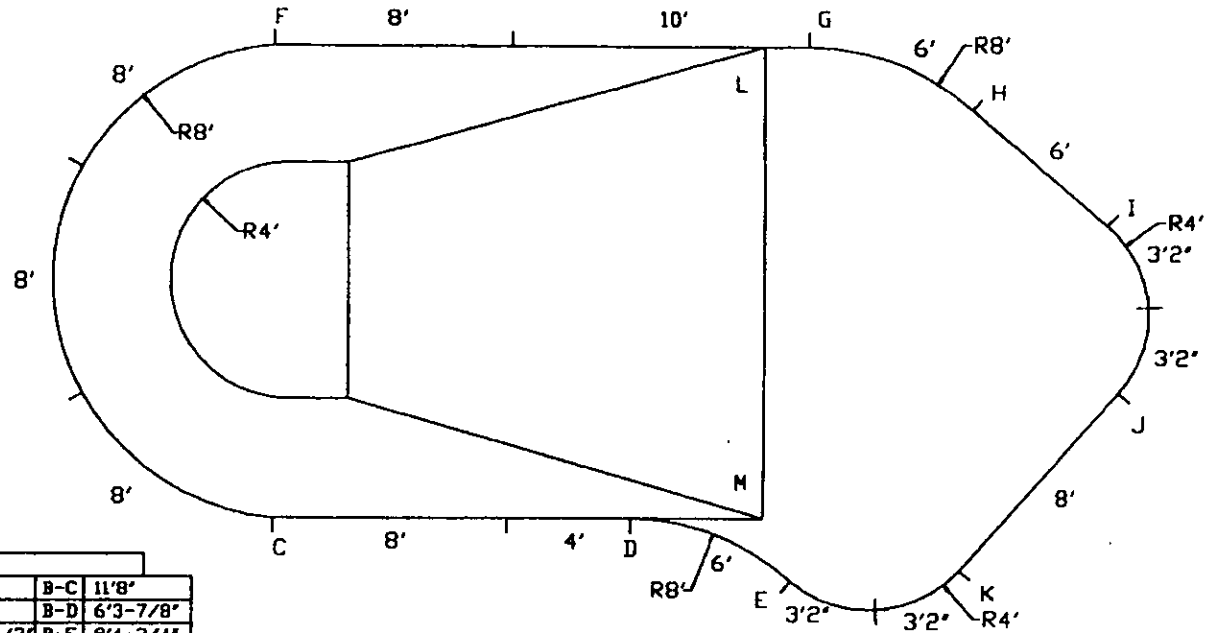
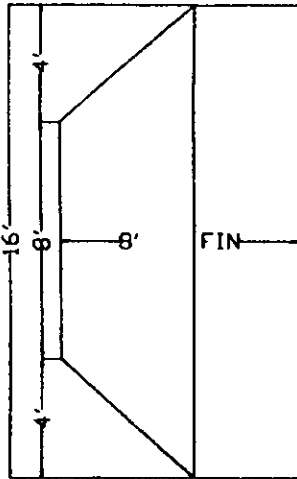

STAKE OUT			
A-C	6'	B-C	11'8"
A-D	13'5"	B-D	6'3-7/8"
A-E	17'10-1/2"	B-E	8'4-3/4"
A-F	22'	B-F	24'2"
A-G	28'5"	B-G	23'5"
A-H	30'8-3/4"	B-H	23'11-3/4"
A-I	32'2"	B-I	24'
A-J	30'1-7/8"	B-J	21'-3/8"
A-K	23'5-3/4"	B-K	13'9-1/4"
A-L	27'6"	B-L	22'11-1/4"
A-M	17'6-3/4"	B-M	8'10"

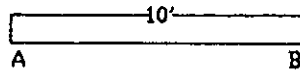

24 BAKER ST. P.O. BOX 100, HASTINGS ON KOL-1Y0
705-696-2385, 1-800-465-3433, FAX 705-696-1922

16'X37' R.H. HIGHLANDER

QTY.	LENGTH	RADIUS	TYPE
2	8'0"	8'0"	PLAIN
1	8'0"	8'0"	RETURN
1	6'0"	8'0"	PLAIN
1	6'0"	8'0"	REVERSE
4	3'2"	4'0"	CORNER
1	10'0"	NA	PLAIN
1	8'0"	NA	RETURN
1	8'0"	NA	SKIMMER
1	8'0"	NA	PLAIN
1	6'0"	NA	PLAIN
1	4'0"	NA	PLAIN
14	-	NA	A-FRAME
1	-	NA	N&B PKG
			S.A. 537 sq.ft.
			PER: 92'8"
1637HILC			DATE: 09-11-00

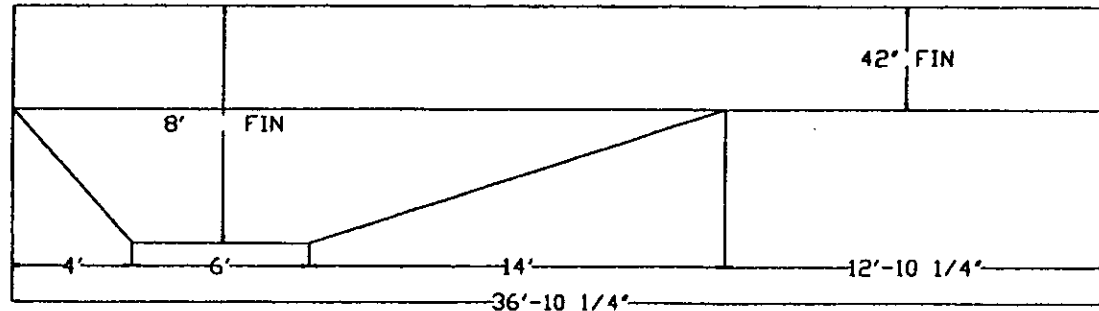

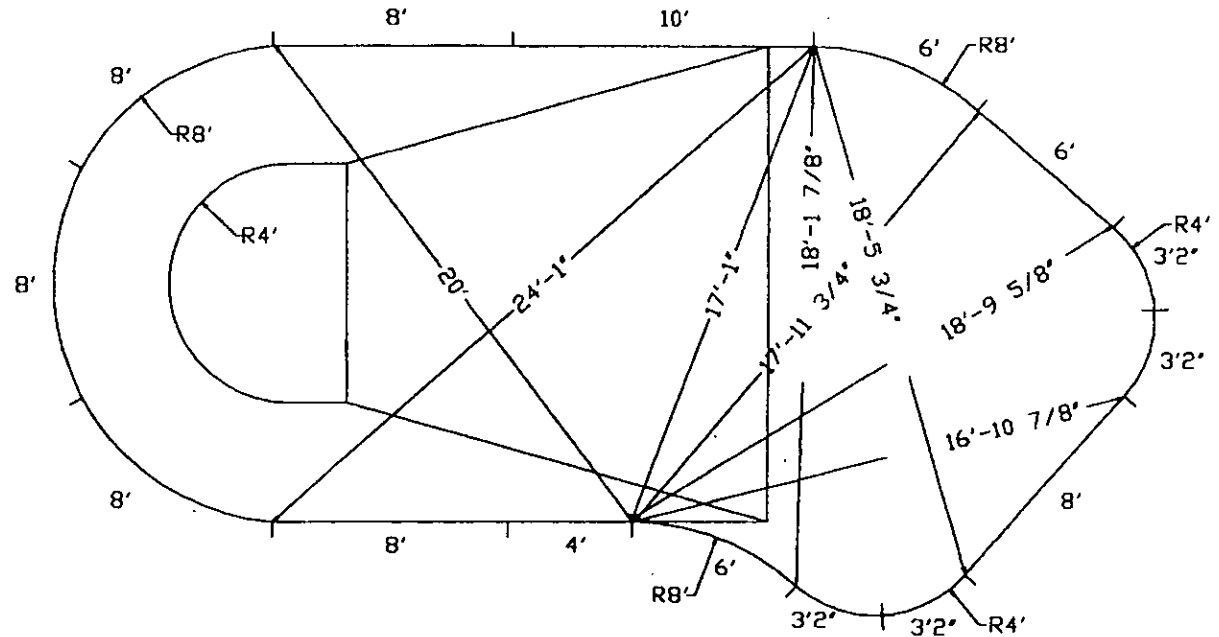
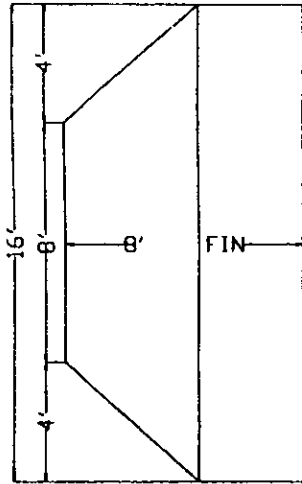

24 BAKER ST., P.O. BOX 100, HASTINGS DN, KOL-1Y0
 705-696-2385, 1-800-465-3433, FAX: 705-696-1922

16'X37' R.H. HIGHLANDER

QTY.	LENGTH	RADIUS	TYPE
2	8'0"	8'0"	PLAIN
1	8'0"	8'0"	RETURN
1	6'0"	8'0"	PLAIN
1	6'0"	8'0"	REVERSE
4	3'2"	4'0"	CORNER
1	10'0"	NA	PLAIN
1	8'0"	NA	RETURN
1	8'0"	NA	SKIMMER
1	8'0"	NA	PLAIN
1	6'0"	NA	PLAIN
1	4'0"	NA	PLAIN
14	-	NA	A-FRAME
1	-	NA	N&B PKG
			S.A.: 537 sq.ft.
			PER: 92'8"
1637HILC			DATE: 09-11-00

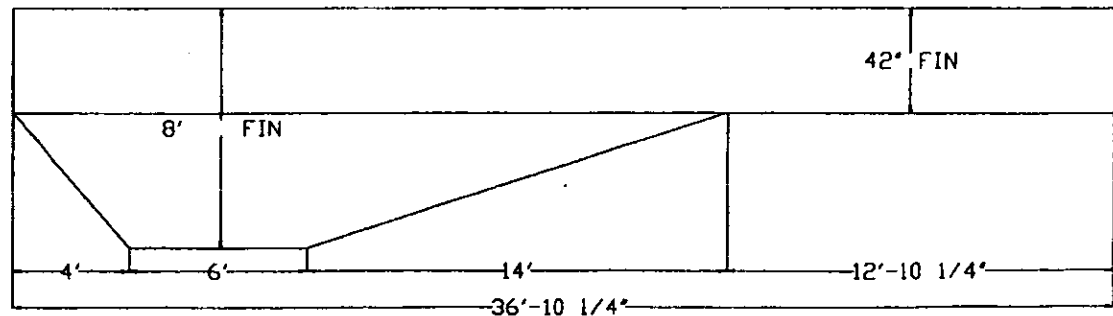

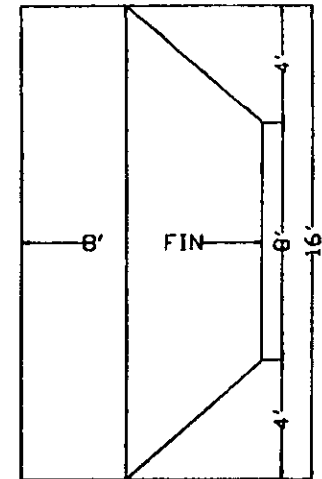
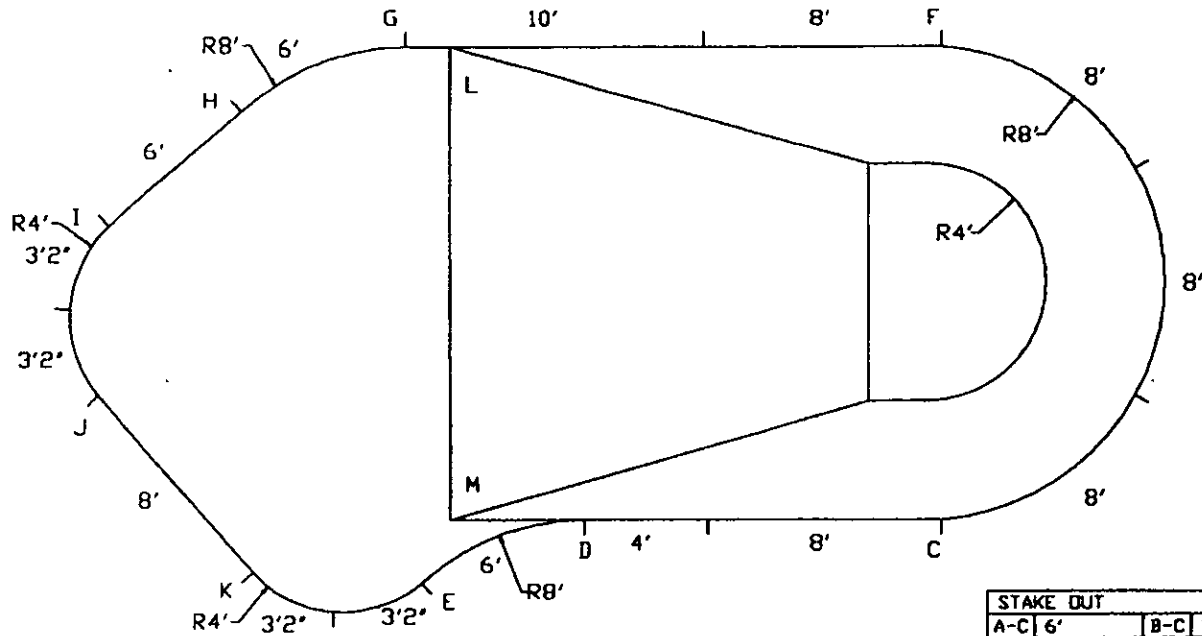

STAKE OUT	
A-C 6'	B-C 11'8"
A-D 13'5"	B-D 6'3-7/8"
A-E 17'10-1/2"	B-E 8'4-3/4"
A-F 22'	B-F 24'2"
A-G 28'3"	B-G 23'3"
A-H 30'8-3/4"	B-H 23'11-3/4"
A-I 32'2"	B-I 24'
A-J 30'1-7/8"	B-J 21'-3/8"
A-K 23'5-3/4"	B-K 13'9-1/4"
A-L 27'6"	B-L 22'11-1/4"
A-M 17'6-3/4"	B-M 8'10"

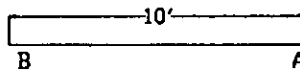

24 BAKER ST. P.O. BOX 100, HASTINGS ON KOL - 1YO
705-696-2385, 1-800-465-3433, FAX: 705-696-1922

16'X37' L.H. HIGHLANDER

QTY.	LENGTH	RADIUS	TYPE
2	8'0"	8'0"	PLAIN
1	8'0"	8'0"	RETURN
1	6'0"	8'0"	PLAIN
1	6'0"	8'0"	REVERSE
4	3'2"	4'0"	CORNER
1	10'0"	NA	PLAIN
1	8'0"	NA	RETURN
1	8'0"	NA	SKIMMER
1	8'0"	NA	PLAIN
1	6'0"	NA	PLAIN
1	4'0"	NA	PLAIN
14	-	NA	A-FRAME
1	-	NA	N&B PKG
			S.A.: 537 sq.ft.
			PER: 92'8"
1637HILC			DATE: 09-11-00

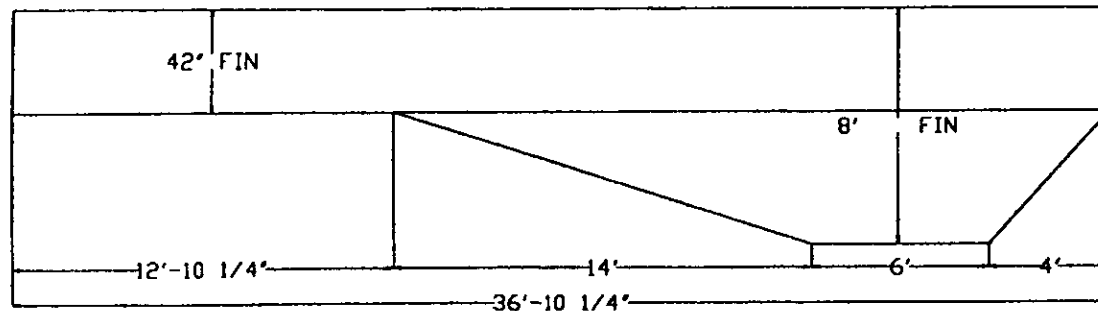

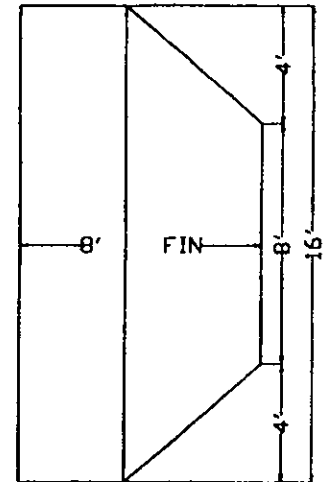
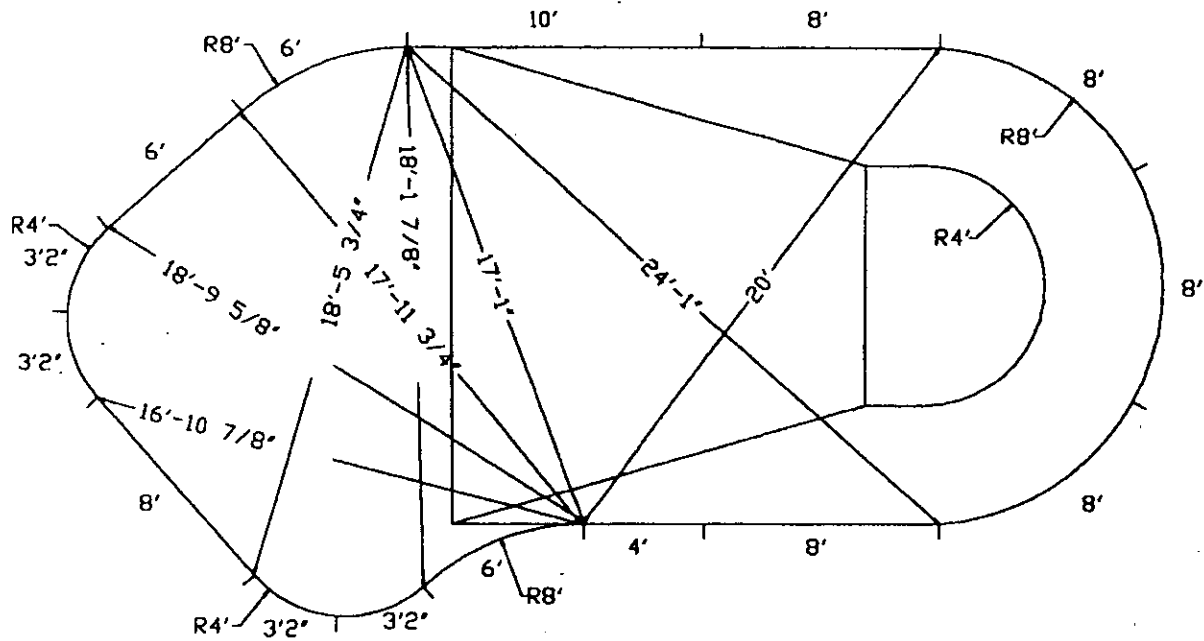

24 BAKER ST. P.O. BOX 100, HASTINGS DN. KOL-1Y0
 705-696-2385, 1-800-465-3433, FAX: 705-696-1922

16'X37' L.H. HIGHLANDER

QTY.	LENGTH	RADIUS	TYPE
2	8'0"	8'0"	PLAIN
1	8'0"	8'0"	RETURN
1	6'0"	8'0"	PLAIN
1	6'0"	8'0"	REVERSE
4	3'2"	4'0"	CORNER
1	10'0"	NA	PLAIN
1	8'0"	NA	RETURN
1	8'0"	NA	SKIMMER
1	8'0"	NA	PLAIN
1	6'0"	NA	PLAIN
1	4'0"	NA	PLAIN

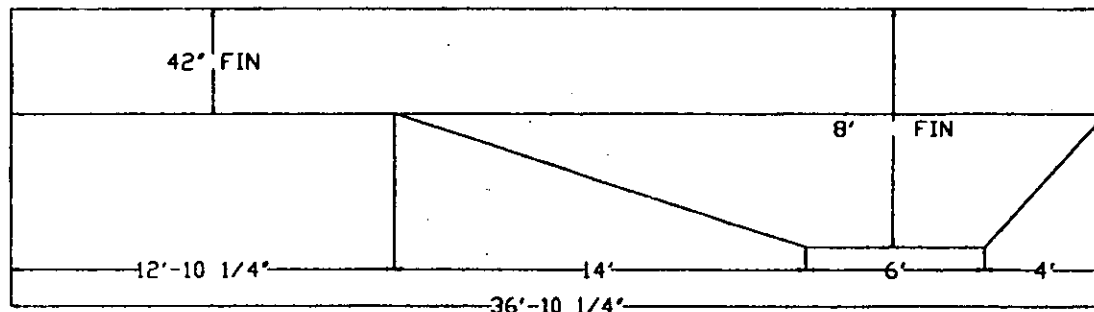

14	-	NA	A-FRAME
1	-	NA	N&B PKG
			S.A. 537 sq.Ft.
			PER. 92'8'
1637HILC			DATE: 09-11-00

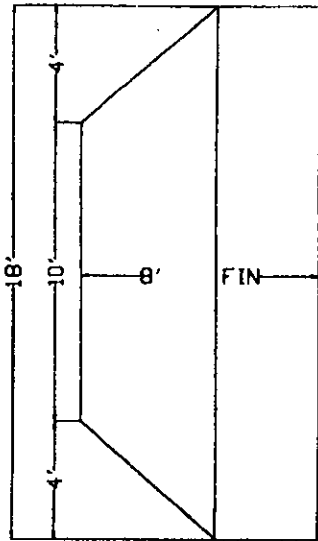

24 BAKER ST. P.O. BOX 100, HASTINGS ON KOL-1Y0
705-696-2385, 1-800-465-3433, FAX 705-696-1922

18'X40' R.H. HIGHLANDER

QTY.	LENGTH	RADIUS	TYPE
2	8'0"	9'0"	PLAIN
1	8'0"	9'0"	RETURN
1	4'0"	9'0"	PLAIN
1	6'0"	8'0"	PLAIN
1	6'0"	8'0"	REVERSE
4	3'2"	4'0"	CORNER
1	10'0"	NA	RETURN
1	10'0"	NA	SKIMMER
1	9'0"	NA	PLAIN
1	8'0"	NA	PLAIN
1	7'0"	NA	PLAIN
1	4'0"	NA	PLAIN
16	-	NA	A-FRAME
1	-	NA	N&B PKG
			S.A.: 645 sq.ft.
			PER: 100'2"
1840HILC			DATE: 09-11-00

STAKE OUT	
A-C	6'
A-D	13'5"
A-E	17'10-1/2"
A-F	24'
A-G	30'7-1/4"
A-H	32'9-1/2"
A-I	34'2-1/2"
A-J	31'11-3/4"
A-K	23'5-1/2"
A-L	28'4-1/2"
A-M	16'3-1/2"
B-C	11'8"
B-D	6'3-7/8"
B-E	8'4-3/4"
B-F	26'
B-G	25'7-1/2"
B-H	26'2-1/2"
B-I	26'-1/2"
B-J	22'11-1/4"
B-K	13'8-3/4"
B-L	24'6-1/2"
B-M	7'10-3/4"

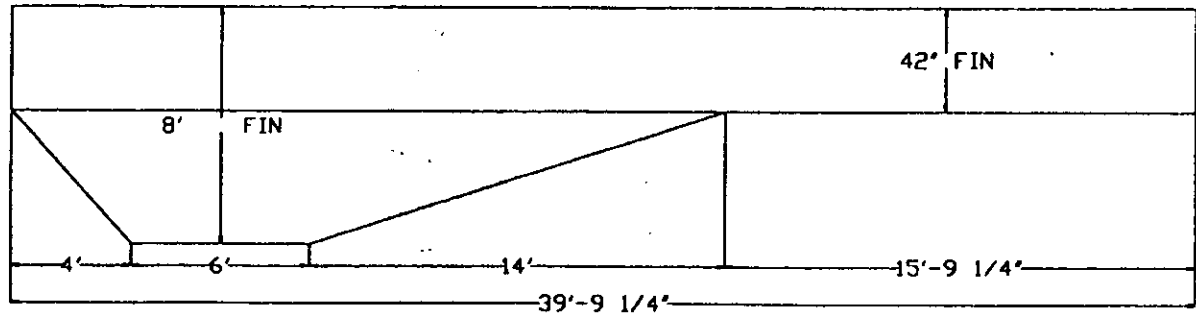
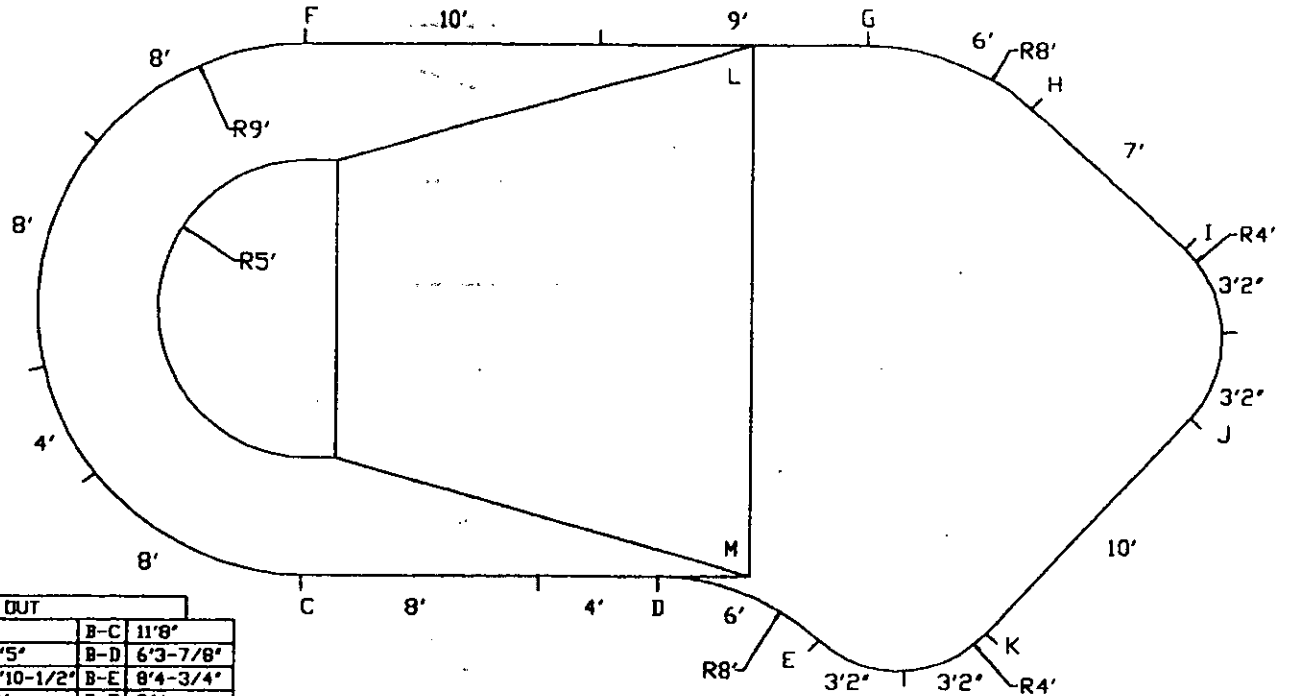
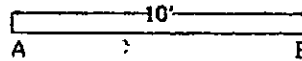

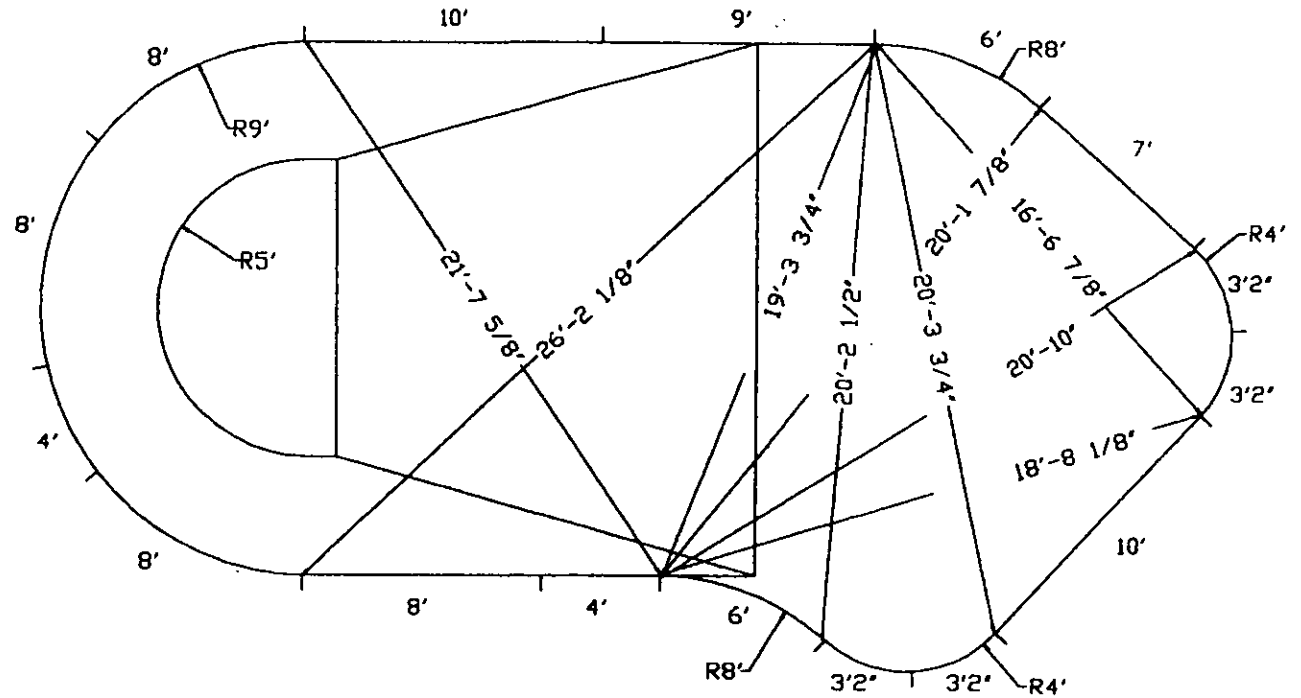
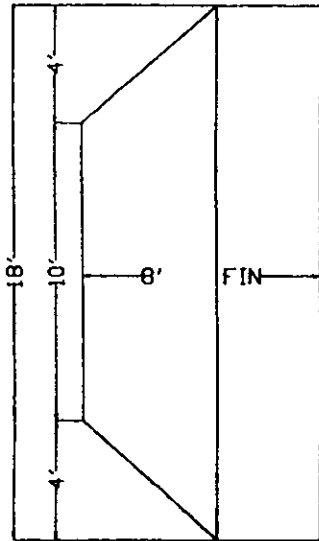

24 BAKER ST. P.O. BOX 100 HASTINGS ON KOL-1YO
 705-696-2385, 1-800-465-3433 FAX: 705-696-1922

18'X40' R.H. HIGHLANDER

QTY.	LENGTH	RADIUS	TYPE
2	8'0"	9'0"	PLAIN
1	8'0"	9'0"	RETURN
1	4'0"	9'0"	PLAIN
1	6'0"	8'0"	PLAIN
1	6'0"	8'0"	REVERSE
4	3'2"	4'0"	CORNER
1	10'0"	NA	RETURN
1	10'0"	NA	SKIMMER
1	9'0"	NA	PLAIN
1	8'0"	NA	PLAIN
1	7'0"	NA	PLAIN
1	4'0"	NA	PLAIN
16	-	NA	A-FRAME
1	-	NA	N&B PKG
			S.A. 645 sq.ft.
			PER: 100'2"
1840HILC			DATE: 09-11-00

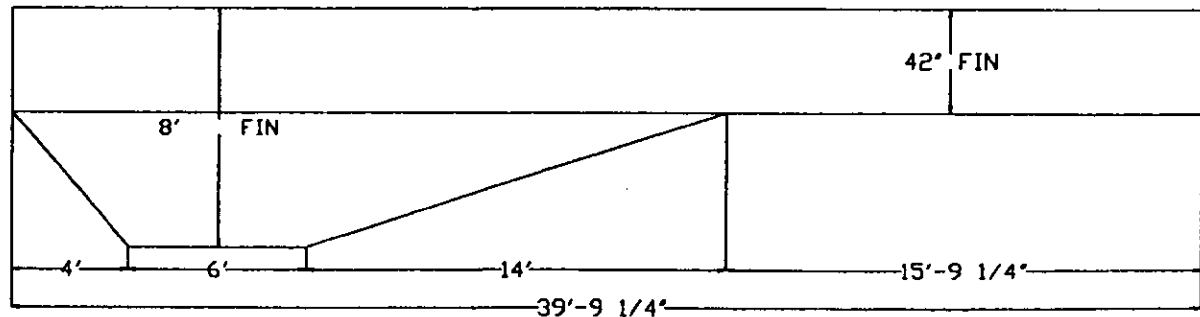

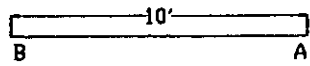
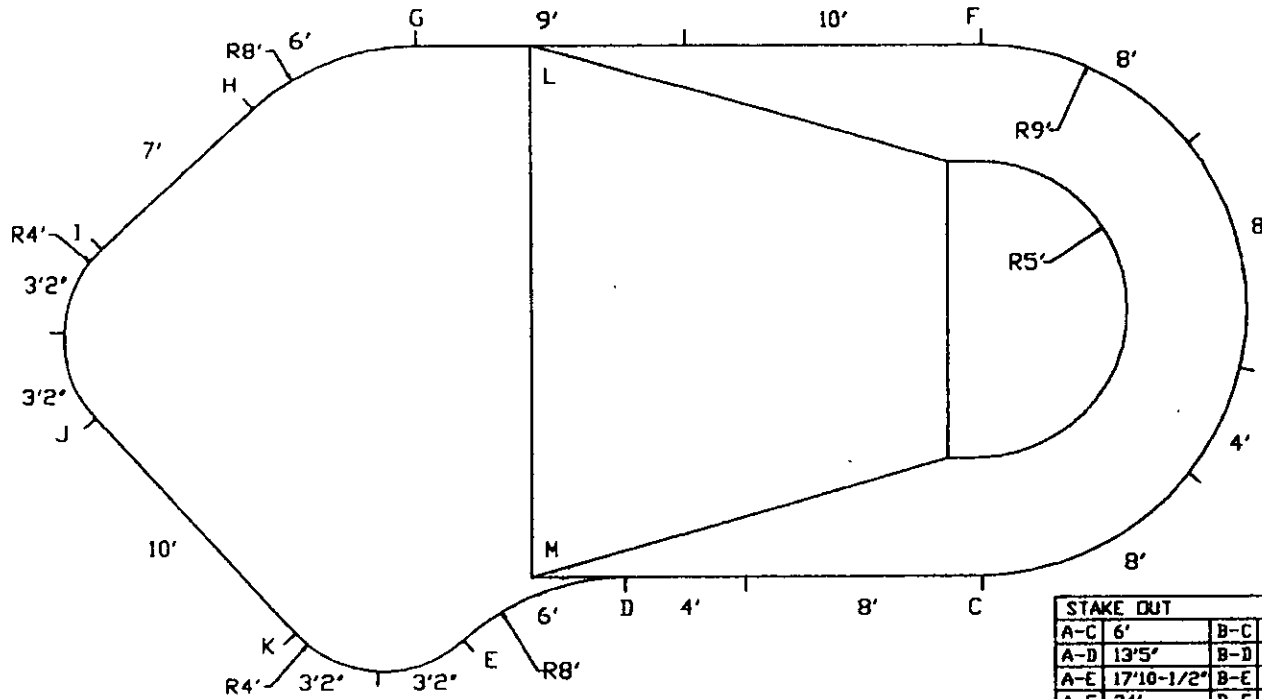

STAKE OUT			
A-C	6'	B-C	11'8"
A-D	13'5"	B-D	6'3-7/8"
A-E	17'10-1/2"	B-E	8'4-3/4"
A-F	24'	B-F	26'
A-G	30'7-1/4"	B-G	25'7-1/2"
A-H	32'9-1/2"	B-H	26'2-1/2"
A-I	34'2-1/2"	B-I	26'-1/2"
A-J	31'11-3/4"	B-J	22'11-1/4"
A-K	23'5-1/2"	B-K	13'8-3/4"
A-L	28'4-1/2"	B-L	24'6-1/2"
A-M	16'3-1/2"	B-N	7'10-3/4"

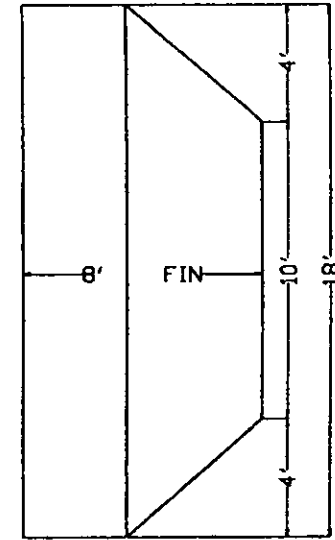

24 BAKER ST. P.O. BOX 100, HASTINGS ON KOL-110
705-696-2385, 1-800-465-3433, FAX 705-696-1922

18'X40' L.H. HIGHLANDER

QTY.	LENGTH	RADIUS	TYPE
2	8'0"	9'0"	PLAIN
1	8'0"	9'0"	RETURN
1	4'0"	9'0"	PLAIN
1	6'0"	8'0"	PLAIN
1	6'0"	8'0"	REVERSE
4	3'2"	4'0"	CORNER
1	10'0"	NA	RETURN
1	10'0"	NA	SKIMMER
1	9'0"	NA	PLAIN
1	8'0"	NA	PLAIN
1	7'0"	NA	PLAIN
1	4'0"	NA	PLAIN
16	-	NA	A-FRAME
1	-	NA	N&B PKG
			S.A. 645 sq.ft.
			PER. 100'2"
1B40HILC			DATE: 09-11-00

