

Black Widow Bows

**Handcrafted
by
WILSON BROTHERS MFG. COMPANY
Springfield, Missouri**

Dealer Catalog – Please do not remove from shop

The Wilson Brothers make only first line bows. A Black Widow Bow is not an assembly line product, when you get a Black Widow Bow you can be sure it has had the personal attention of Norman, Jack or Bob. They are Archers making bows for the Archers who appreciate the workmanship and care that goes into every Black Widow Bow. They have had many years experience in bow making and shooting. They were National Champions as far back as 1946 and were among the top group of archers at National and Regional Tournaments for many years. They know Archery, Archers and Bow Making.

We believe the performance of the BLACK WIDOW BOW will absolutely amaze you. It has a perfect combination of smooth draw, speed and stability that will prove to you why we say, "IT IS THE FINEST BOW MADE." From our seven different models you can choose the bow that is best suited to your purpose and style of shooting.

Black Widow Bows are guaranteed for three years on a pro-rated basis, guarantee and registration card accompanies each bow.



This bow is the result of several years of experimenting by the Black Widow Bowyers and it is the ultimate in smoothness and stability in a bow. It is designed to eliminate the need for rods, plugs, weights, etc. that many archers have used trying to gain additional stability and accuracy. The deep deflex grip and specially designed handle bring shock or kick to an absolute minimum.

MODEL X200

Lengths: 64" and 68"

Walnut handle
trimmed with Rosewood as shown \$135.00

All Rosewood handle section \$150.00

Deluxe padded bow case furnished with model X200.

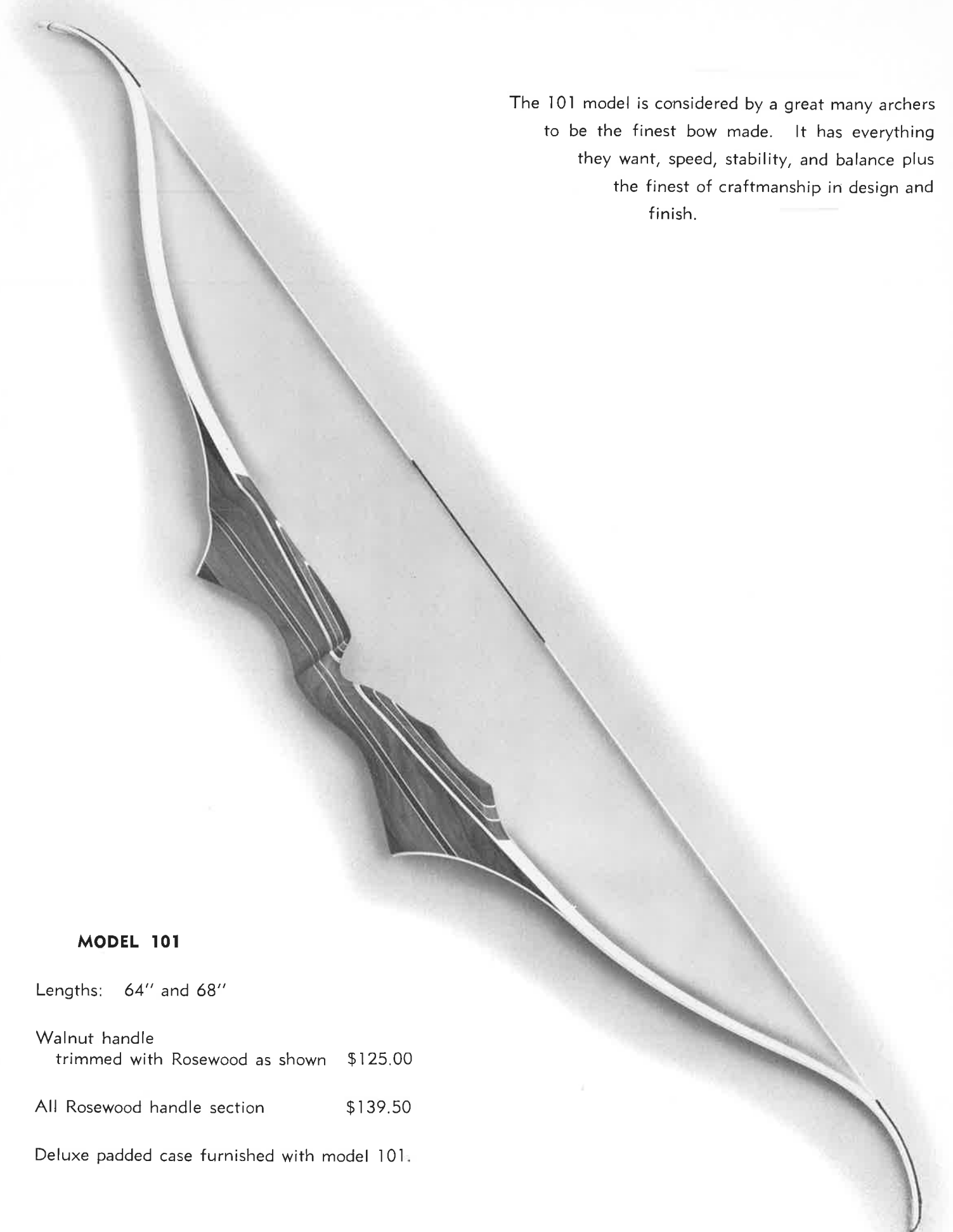

The 101 model is considered by a great many archers to be the finest bow made. It has everything they want, speed, stability, and balance plus the finest of craftsmanship in design and finish.

MODEL 101

Lengths: 64" and 68"

Walnut handle
trimmed with Rosewood as shown \$125.00

All Rosewood handle section \$139.50

Deluxe padded case furnished with model 101.



The X99 is the work horse of the Black Widow bows. There are more X99's in use all over the world than any other Black Widow bow, (it was the first Black Widow model with the large stabilizing section) and it is still preferred by many archers over any other model. It is equally at home on the field range, target range or indoor range.

MODEL X99

Lengths: 64", 66", and 68"

Walnut handle
trimmed with Rosewood as shown \$100.00

All Rosewood handle section \$112.50

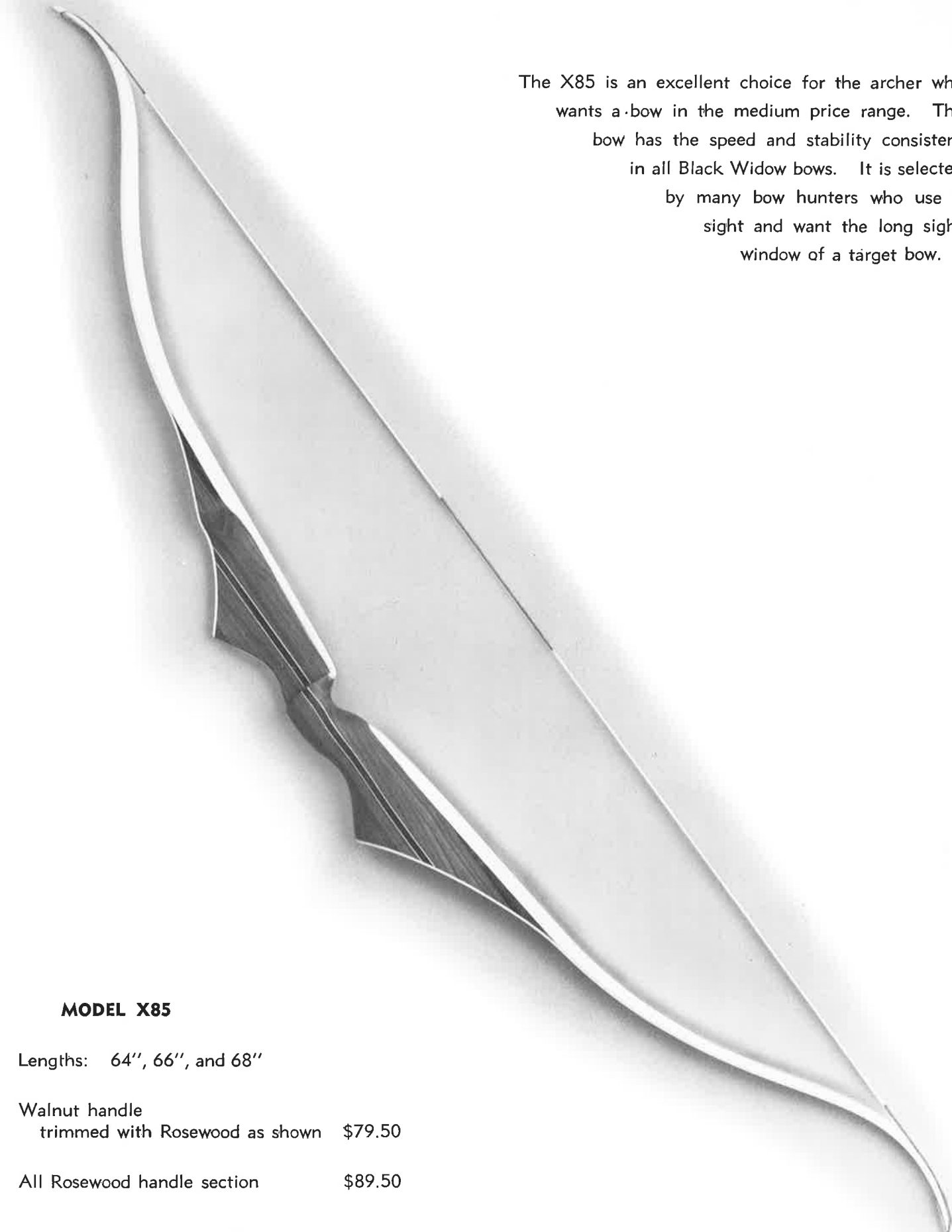

The X85 is an excellent choice for the archer who wants a bow in the medium price range. The bow has the speed and stability consistent in all Black Widow bows. It is selected by many bow hunters who use a sight and want the long sight window of a target bow.

MODEL X85

Lengths: 64", 66", and 68"

Walnut handle
trimmed with Rosewood as shown \$79.50

All Rosewood handle section \$89.50

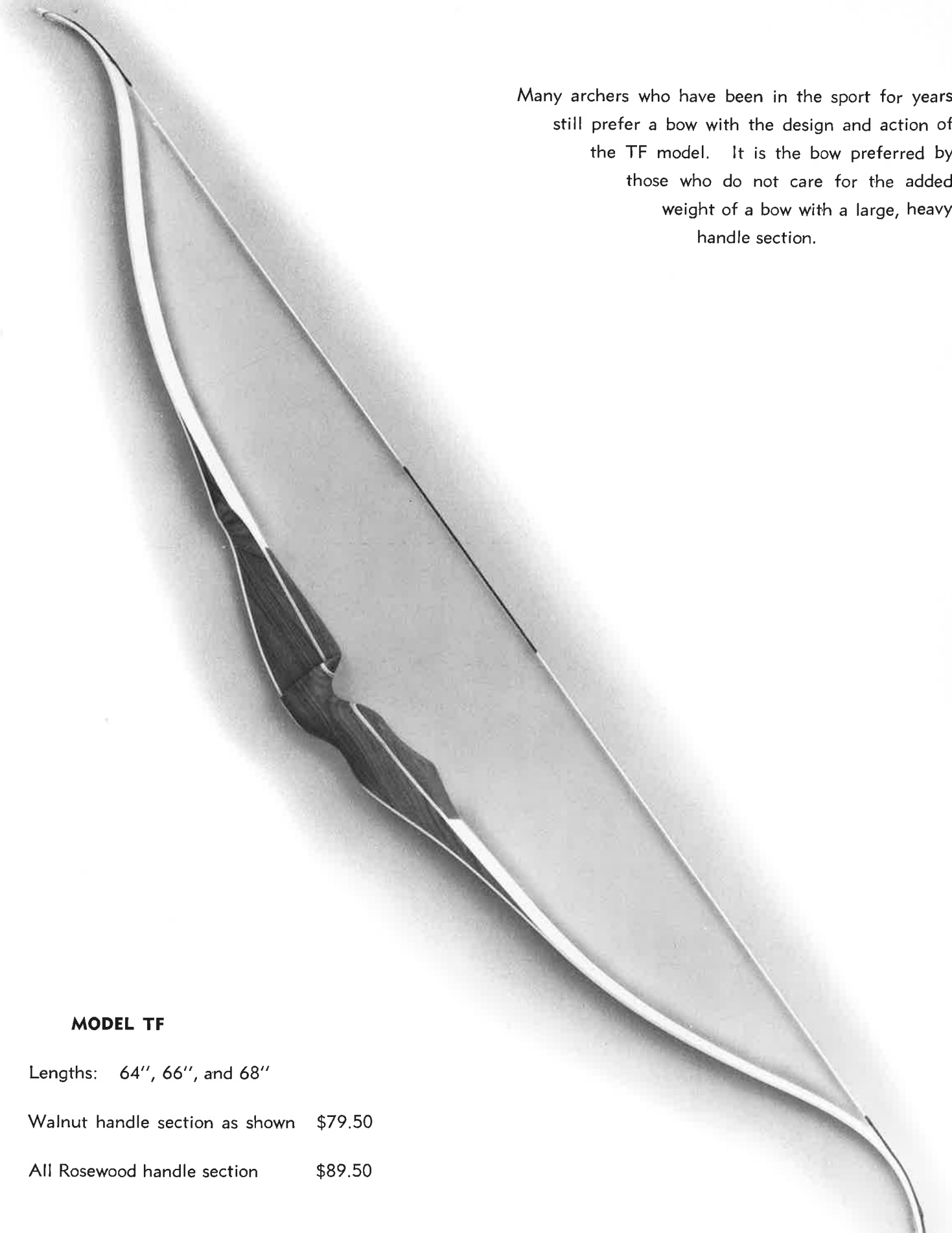

Many archers who have been in the sport for years still prefer a bow with the design and action of the TF model. It is the bow preferred by those who do not care for the added weight of a bow with a large, heavy handle section.

MODEL TF

Lengths: 64", 66", and 68"

Walnut handle section as shown \$79.50

All Rosewood handle section \$89.50

The Black Widow hunting bows are not made to compete with the ordinary production line bows such as are sold by Mail Order Houses, Discount Stores, etc. The HB models receive the same attention, selection of materials and fine workmanship as the more expensive target and field models. The 62" length is a favorite of bowhunters everywhere. The 58" shorter model is preferred by many who hunt in the more wooded and brushy areas.



MODEL HB

Lengths: 58" and 62"

Walnut handle section as shown \$59.50

All Rosewood handle section \$64.50

We believe this is the finest hunting bow ever made. Designed as a companion bow to the target model 101 it has the speed of a flight bow, the smoothness and stability found in the finest target models. If you are a man who demands the very best in his hunting equipment this is the bow for you.



MODEL H101

Length: 60"

Walnut handle
trimmed with Rosewood as shown \$89.50

All Rosewood handle section \$100.00

RECOMMENDED STRING HEIGHT

Measurements are from the string to the deepest part of the bow grip as illustrated.

		All other models	
101	68" 8" to 8 ³ / ₄ "	58"	7" to 7 ³ / ₄ "
101	64" 7 ¹ / ₂ " to 8 ¹ / ₄ "	62"	7" to 7 ³ / ₄ "
X200	68" 9 ³ / ₄ " to 10 ¹ / ₂ "	64"	7 ¹ / ₄ " to 8"
X200	64" 9 ¹ / ₄ " to 10"	66"	7 ³ / ₄ " to 8 ¹ / ₂ "
H101	60" 7 ¹ / ₄ " to 8"	68"	7 ⁷ / ₈ " to 8 ⁵ / ₈ "

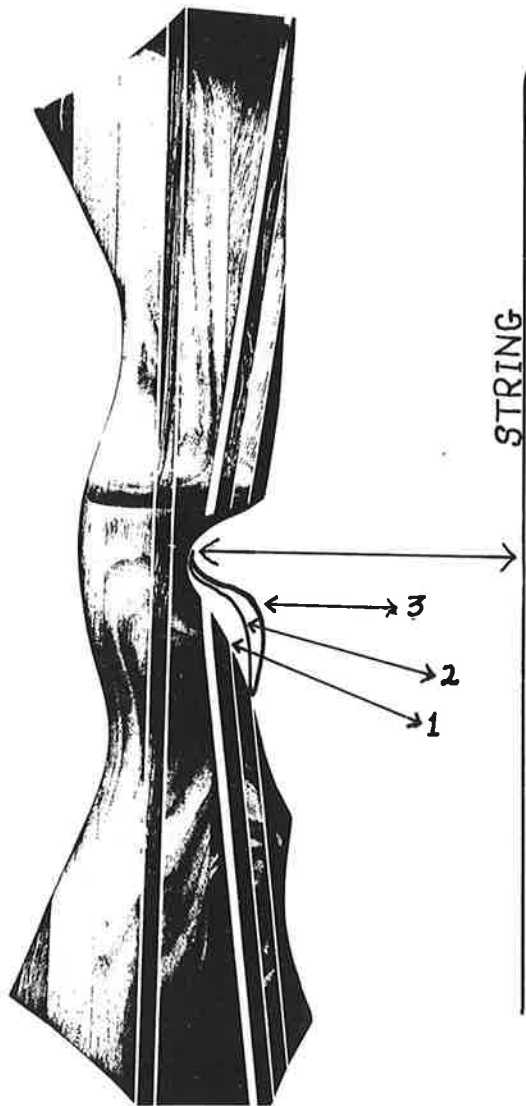

- No. 1 Standard Grip shape**
- No. 2 Semi-high wrist**
- No. 3 Straight or high wrist.**

BOW LENGTHS AND DRAW WEIGHTS

In the target models if your draw length is 27" or less we recommend a 64" bow. If it is more than 27", a 66", or 68" bow. The HB, 58" and 62" and H101 hunting bows are for draws up to 30".

HANDLE GRIP SHAPES

Handle grip shapes for all models as shown in the picture of each bow is the regular, standard handle grip and is the one we recommend, however, when it is requested we will make a semi-high or high wrist grip as shown in the illustration. The HB 58" and 62" model is made with standard handle grip only.

BOW DRAW WEIGHTS

All target models are available in weights up to 50 pounds at 28" draw. Hunting bows up to 65 pounds. Weights are marked at 28" draw unless requested otherwise.

FINISH AND MATERIALS

The beautiful finish on Black Widow bows is an exceptionally durable Epoxy coating. Handle sections are Black Walnut or Rosewood. White glass only is used on all models.

The Wilson Tab

U. S. Pat. No. 2,974,319

Price: \$1.50

Available in FIVE SIZES

Extra Small, Small, Medium, Large and Extra Large.
Right and Left Hand

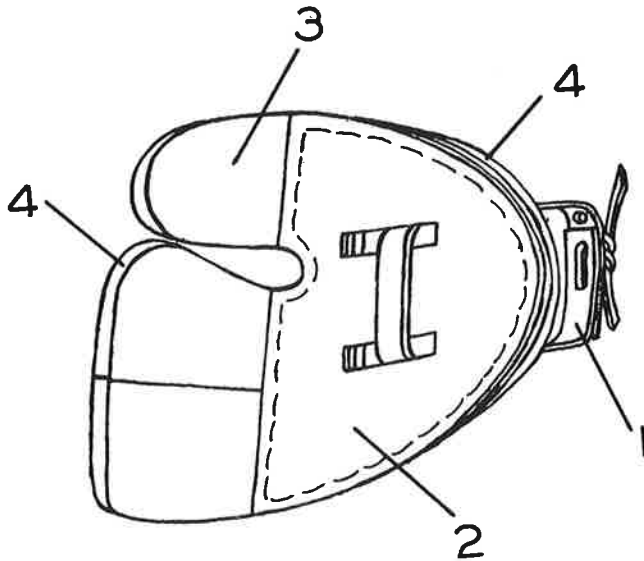

CONSTRUCTION OF TAB

- No. 1 Adjustable finger loop for a perfect fit, even over a glove for cold weather shooting.
- No. 2 The front edge of this section makes exact placement automatic.
- No. 3 Top grade Cordovan for smoothness and long wear.
- No. 4 Special felt backing absorbs sweat, keeps tab from getting sticky. This special felt backing coupled with feature No. 5 which adds flexibility and helps equalize the pressure on each finger, entirely eliminates sore fingers in most all cases.

The Wilson Powder Pouch

U. S. Pat. No. 2,940,651

Price: \$1.25

The Powder Pouch is easy to fill through the opening in the top. It holds enough powder for several days shooting, snaps on belt for convenience in carrying, and makes it easy to apply the right amount of powder on tab or glove just by patting the dispensing section. The pouch is made of a heavy durable "Rhino" finish, buff plastic for lasting service. It also has a handy place for a pencil.

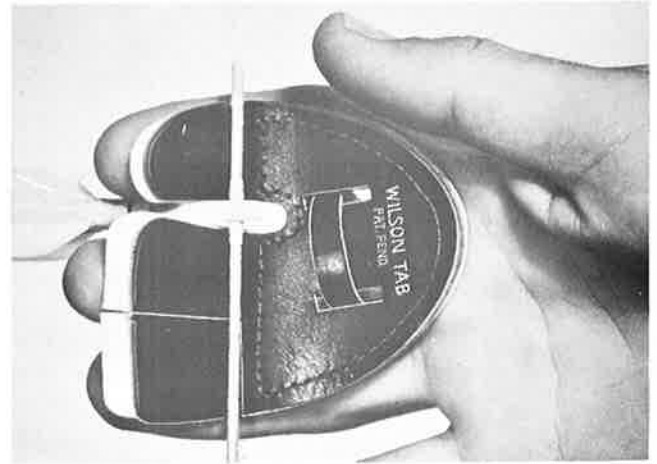

The ordinary tab is hard to break in so it will feel comfortable and give a good release. The Wilson Tab, because of its patented construction, requires no long break in period, it permits a perfect release right from the start.

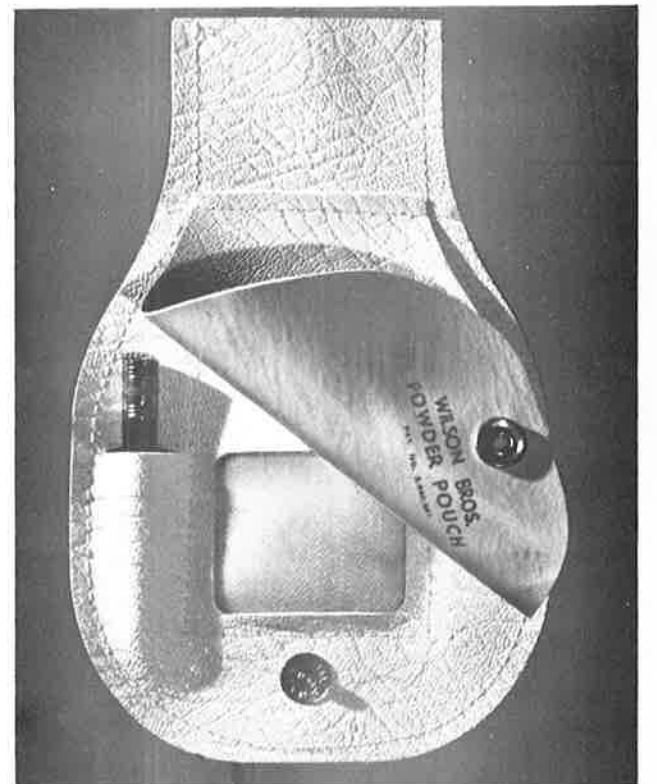

ORDER BLANK

DATE _____

Black Widow Bows

ORDER No. _____

SHIP TO:

WILSON BROTHERS MFG. CO.

2503 N. Delaware
P. O. Box 917, Commercial Station
Springfield, Missouri 65803
U.S.A.

Phone: 417 UN 6-7811

QUANTITY	MODEL	LENGTH	DRAW WEIGHT AT 28"	TYPE OF WOOD IN HANDLE SECTION WALNUT OR ROSEWOOD	HANDLE GRIP No. 1 STANDARD No. 2 SEMI-HIGH WRIST No. 3 STRAIGHT OR HIGH WRIST GRIP

QUANTITY	OTHER ITEMS — DESCRIPTION