

Novel Approach of PV and Wind MPPT by Fuzzy Rules Optimization using Grey wolf Approach

Varun Kesar¹, Navnidhi sharma²

^{1,2}Electrical department

Kurukshetra university, Emax group of institutions, Kalpi, Ambala, INDIA

Abstract- Due to substantial generation and demand fluctuations in standalone green electricity control schemes are becoming crucial for the electricity sharing and voltage regulation functions. The classical power management strategies rent the maximum energy factor monitoring (MPPT) algorithms and rely on batteries in case of possible extra or deficit of strength. However, so as to recognize constant present day-constant voltage (IU) charging regime and growth the life span of batteries, electricity control strategies require being more flexible with the power curtailment feature. The paper proposes a method for the hybrid solar photovoltaic and wind energy device in Battery management for stand-alone applications. Battery charging manner is non-linear, time-varying with an enormous time delay so it is difficult to achieve the best energy management performance by using traditional control approaches. A fuzzy manipulates approach for battery charging or discharging utilized in a renewable power generation system is analysed in the paper. To improve the life cycle of the battery, fuzzy control manages the desired state of charge (SOC). A fuzzy logic-based controller for use for the Battery SOC manipulate of the designed hybrid system is proposed and in comparison, with a classical PI controller for the overall performance validation. The whole designed device is modelled and simulated the use of MATLAB/Simulink Environment. In this thesis analysis the three cases single source, hybrid source and battery in fix load.

Keywords- Distributed Generation, Artificial intelligence, Artificial Neural Network, State of Charge, Maximum Energy Factor Monitoring.

I. INTRODUCTION

The expanding energy demand, high energy costs, and in addition concerns over environmental impact, wellbeing and environmental change, have pulled in numerous analysts and communities for moving into elective energy examines. Several examinations are done for making utilization of renewable energy sources (e.g. wind, solar and biogas) which are standalone [2, 9]. Between these, the two most promising renewable power generation technologies are wind and solar energy. Normally, the wind or solar power is utilized by load remote areas where mains power supply is inaccessible. The standalone power frameworks disservice utilizing renewable

energy sources in which their accessibility is influenced day by day and seasonal examples which bring about troubles in managing the output power to the load [1]. For instance, fluctuating every day wind speeds and solar irradiation cut around evening time and cloudy days, prompts wind and solar frameworks with low unwavering quality in providing the load in a day throughout. Since both solar and wind power is accessible constantly in a day throughout, month or year, selective breeze or solar power frameworks cannot be utilized on standalone reason to the electrical installations that requires power to be constantly ensured. A good other option to this is the hybrid energy frameworks utilization [Ekren]. These hybrid frameworks having major limitation and that is the control necessity for optimal productivity. A scientific model is required by the conventional control algorithms for the dynamic framework is controllable. Then, numerical model is utilized for constructing a controller. In numerous down to earth situations, generally, it is not possible to obtain a controlled framework having precise scientific model. Fuzzy logic control frameworks have advantages of recreating every single coveted element of human input, whereas the upsides of automatic closed-loop control advantages are maintained. The utilization of the fuzzy logic control is one the major problem is the trouble of choice and plan of enrolment functions for suiting a problem given [6]. A precise procedure to choose the kind of enrolment function and the scopes of factors in the discourse universe is as yet not accessible. Fuzzy controller tuning by error and trial is essential for getting a performance satisfaction. However, neural networks have the ability of recognizing the trademark components of a framework which is extricated from the input-output data.

1.1 Distributed Generation

Distributed generation, likewise approached dispersed generation, site generation, decentralized generation, installed generation, distributed energy or decentralized energy produces electricity from numerous small energy sources. Currently, modern nations produce the greater part of their electricity in substantially together brought offices, for example, hydropower plants or fossil fuel (coal and gas powered) atomic. These plants have superb scale economies, yet for the most part transmit long electricity separations and influence nature contrarily.

1.1.1 Distributed Energy resources

Distributed energy resource (DER) systems are small-scale

power generation innovations (regularly in the scope of 3 kW - 10,000 kW) used to give a contrasting option to or an improvement of the conventional electric power framework.

1.1.2 Distributed energy system

Distributed Generation Systems have basically been utilized as a standby power source for basic organizations. DES can offer enhanced administration dependability, better financial aspects and a lessened reliance on the local utility. the utilization of Distributed Energy Systems under the 500kW level is quickly expanding because of late technology changes in small generators, power electronics, and energy storage gadgets. Effective clean petroleum derivatives innovations, for example, micro-turbines and power modules, and naturally well-disposed renewable energy advancements, for example, sunlight based/photovoltaic, small breeze and hydro are progressively utilized for new distributed generation systems.

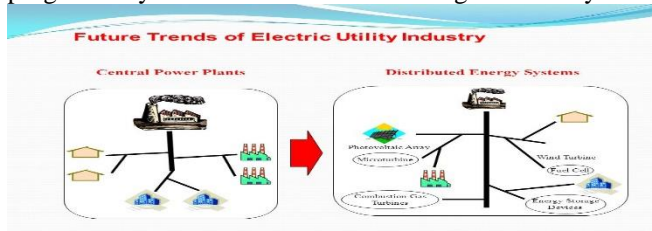

Fig.1: Large central power plant and distributed energy systems

1.3 Fuzzy logics

FL is practically synonymous with the theory of fuzzy sets, a theory which identifies with classes of articles with unsharp limits in which participation involves degree. A powerful method created by Dr. Roger Jang for this reason for existing is called ANFIS (Adaptive Neuro-Fuzzy Inference System). This method is an important segment of the tool stash. The fuzzy logic tool kit is exceedingly amazing in all regards. It makes fuzzy logic a successful instrument for the origination and outline of insightful systems. The fuzzy logic tool compartment is anything but difficult to ace and helpful to utilize. And last, however not minimum important, it gives a per-user amicable and state-of-the-art prologue to methodology of fuzzy logic and it's far reaching applications.

1.4 Particle Swarm Optimization

PSO used to optimize that objective function to obtain optimum value. Let there be x position of particle and u is the velocity about which it is used to move in the space or search space. The position of the particle is evaluated from:

$$X_{i,d}(t+1) = X_{i,d}(t) + X_{i,d}(t) \dots \dots \dots (1)$$

Where, 't' is the movement time or velocity time of particle in the search space. As we discuss above in any mean time 't' particle has sits position, velocity and location in the search space. The position of the particles is categorized into two category local best position and global best position. After

every iteration the position of particle is updated by using equation:

$$V_{i,d}(t+1) = \alpha(t)V_{i,d}(t) + \beta_p \text{ran}_p(t)(\text{persbest}_{i,d} - P_{i,d}(t)) + \beta_g \text{ran}_g(t)(\text{globest}_d - P_{i,d}(t)) \dots \dots \dots (2)$$

II. RELATED WORK

This study presents information about the background studies on PV power system, wind power system and hybrid power system. It gives an overall idea on developing, modelling, optimization and control technologies for hybrid PV-Wind system. Moreover, challenges that have been faced in wind/solar energy conversion and some of the solutions that have been proposed are also presented

2.1 Photovoltaic Energy Conversion

A photovoltaic system changes over daylight into power. The essential component of a photovoltaic system is the photovoltaic cell. Cells might be gathered to frame panels or modules. Panels can be gathered to frame expansive photovoltaic arrays. The term exhibit is normally utilized to portray a photovoltaic board (with a few cells associated in arrangement and additionally parallel) or a gathering of panels as appeared in Figure 1.

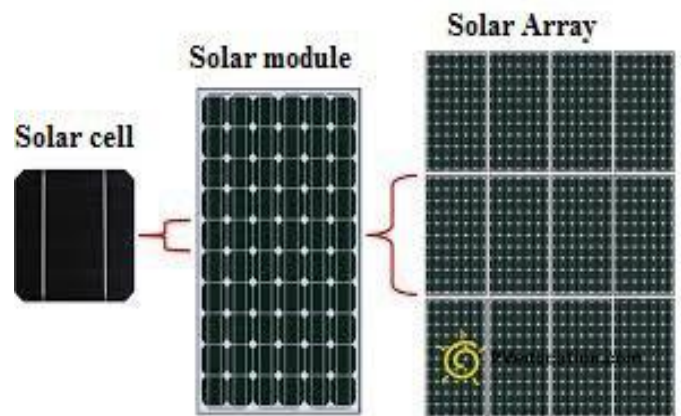

Fig.2: Photovoltaic cell, module and array

2.1.1 Modelling of Photovoltaic Module

For designing application, many researchers have investigated the improved simulation models, for example, the power productivity models, which can anticipate the time series or average performance of a PV array under variable climatic conditions. Kerr and Cuevas [9] introduced another procedure, which can decide the mutt rent {voltage (I{V) characteristics of PV modules based on simultaneously measuring the open-circuit voltage as an element of a slowly varying light intensity. They have also given a detailed theoretical analysis and interpretation of such quasi-steady-state open circuit voltage (Voc) measurements. Zhou et al. [10] introduced a novel simulation display for PV array performance expectations for designing applications based on the I-V bends of a PV module. Five parameters are acquainted with account

for the intricate reliance of PV module performance upon solar radiation powers and PV module temperatures. The authors presumed that this simulation display is basic and especially helpful for architects to calculate the actual performance of the PV modules under operating conditions, with constrained data given by the PV module manufacturers. Yang et al. [18] created one model for calculating the maximum power yield of PV modules according to the theory of equivalent circuit of solar cells by utilizing eight parameters which can be recognized by relapse with the Amoeba Subroutine or Downhill Simplex Method from experimental data. Accuracy of this model was validated by experimental data with great wellness.

2.1.2 Maximum Power Point Tracking of Photovoltaic Module

Maximum power point tracking strategy is utilized to enhance the efficiency of the solar panel. Therefore, the MPP of a photovoltaic array is an essential part of a PV system. Among these strategies, slope climbing MPPT, for example, annoy and watch (P&O) was utilized by many researchers. (P&O) is a basic algorithm that does not require past knowledge of the PV generator characteristics and is easy to actualize with analog and digital circuits.

2.2 Wind Energy Conversion

Wind turbine is an important component in a wind power system to generate electricity. It comprises of a rotor mounted to a nacelle and a tower with two or more blades mechanically associated with an electric generator. The gearbox in the mechanical assembly transforms slower rotational velocities of the wind turbine to higher rotational speeds on the electric generator. The rotation of the electric generator's shaft generates electricity whose yield is maintained by a control system. Currently, two sorts of configurations for wind turbine exist, which is the vertical-axis wind turbine (VAWT) configuration and the broadly utilized horizontal-axis wind turbine (HAWT) configuration.

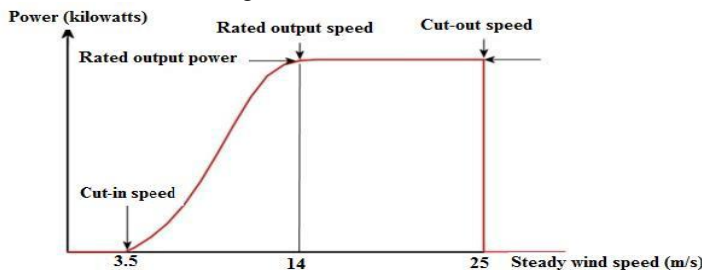

Fig.3: Wind turbine power output with steady wind speed

Zamani and Riahy [6] exhibited another method for calculating the power of a wind turbine by considering wind speed variations. The rate of wind speed variations is assessed by the energy pattern factor (EPF) of actual wind, and the performance of rotor speed and pitch angle controllers is evaluated by another factor, named wind turbine controllability (Ca). By utilizing the EPF and Ca, the power

bend is altered by considering the extra power that is captured by the controllers. The mathematical formulation of turbine display considering the variation of wind speed is portrayed next.

For an object having mass m and velocity v_w under a constant acceleration, the kinetic energy W_w is given by equation 2.5. The mechanical power P_m in the wind is given by the rate of change of kinetic energy, i.e.

$$W_w = \frac{1}{2} m v_w^2 \dots\dots\dots(2)$$

But mass flow rate $\frac{dm}{dt}$

$$P_w = \frac{dW_w}{dt} = \frac{1}{2} \frac{dm}{dt} v_w^2 \dots\dots\dots(3)$$

$$\frac{dm}{dt} =$$

$$\rho A v_m \dots\dots\dots(4)$$

Where A is the swept area of the turbine and is the density of air expression, Equation 2.7 becomes

$$P_m = \frac{1}{2} \rho A v_w^3 \dots\dots\dots(5)$$

$$C_p = \frac{1}{2} (\lambda - 0.022\beta^2 - 56)e^{-0.17\lambda} \dots\dots\dots(6)$$

With this gradually increases, the curve of C_p will decrease significantly. Generally, to achieve the maximum wind power, value should be very small. If is at a given value, then C_p has a maximum value C_{pmax} .

2.3 Energy Storage System

The advancement of battery behavior models has been the concentration of researchers for many years. Based on the model given by Cugnet and Liaw [3 and incorporation of the diffusion precipitation mechanism considered by Oliveira and Lopes [8] in the reaction energy of the negative terminal. Nguyen et al. [13] introduced a model analogous to the flooded sort and examined the dynamic behavior of the phone amid dis-charge as for icy cranking amperage and save capacity. In general, these models are unpredictable as far as the articulations and number of parameters utilized. Broad SOC determination methods have been presented by Sabine Piller et al. [12]. It presumed that the most utilized demonstrating strategy at this time for all systems is ampere-hour numbering method because it is the most direct and transparent method and easily actualized with satisfyingly accurate outcomes for short-time applications, especially if utilized as a part of the range of low to medium SOC. The lead-acid battery is utilized as a part of this proposition for energy storage. The segment underneath portrays the mathematical formulation of lead acid battery display based on its state of charge.

2.4 The Power Conditioning Unit

To associate a photovoltaic or wind turbine to an external system, it is necessary to support its voltage or to increase its

number. Therefore, a lift converter is utilized.

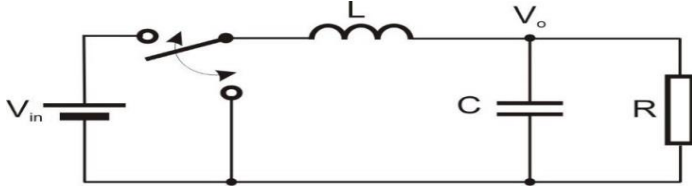

Fig.4: Schematic of DC-DC Boost converter

A lift converter is a class of exchanging mode power supply containing at least two semiconductor switches and at least one energy storage component. In addition, a capacitor is regularly added to the converter output to diminish the ripple of its output voltage as shown in Figure 3.

Equation 5 describes the relation between the input and the output voltage of a boost converter as a function of the duty cycle D.

$$\frac{V_{out}}{V_{in}} = \frac{1}{1-D} \dots \dots \dots (1)$$

2.5 System Control for Energy Flow in PV-Wind Hybrid System

A few analysts have utilized diverse traditional controlling technique for various mixes of hybrid energy systems. Natsheh et al [41] built up a novel model of shrewd network associated PV/WT hybrid system. It contains wind turbine, photovoltaic exhibit, non-concurrent (acceptance) generator, converters and controller. The model was actualized utilizing MATLAB/SIMULINK programming bundle. Bother and watch (P and O) calculation was utilized for boosting the created power based on greatest power point tracker (MPPT) execution. The dynamic conduct of the proposed show was analyzed under various working conditions. Solar irradiance, temperature and wind speed information is assembled from a matrix associated, 28.8kW solar power system situated in focal Manchester. Constant measured parameters were utilized as contributions for the created system. The issue of dependability was accounted for to influence the execution and power nature of the system. Francisco et al [11] built up a neural-fuzzy controller for a wind-diesel system made out of a slowdown managed wind turbine with an enlistment generator associated with an A.C bus-bar in parallel with a diesel generator set having a synchronous generator. In their exploration, this gasifies was fit for changing over huge amounts of wood chips every day into a vaporous fuel that was bolstered into a diesel motor. The controller inputs were the motor speed blunder and its subordinate for the representative piece of the controller, and the voltage mistake and its subsidiary for the programmed voltage controller. It was demonstrated that by turning the fuzzy logic controllers, ideal time area execution of self-governing a wind-diesel system could be accomplished in an extensive variety of working conditions contrasted with settled parameters fuzzy logic controllers and PID controllers

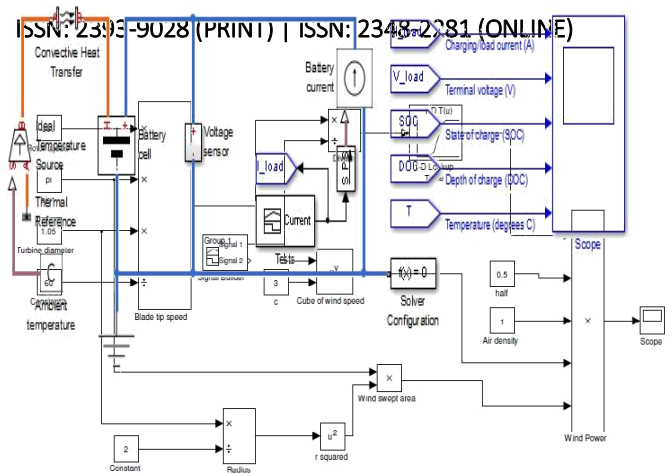

III. THE PROPOSED METHOD

3.1 Development of PV- wind Hybrid Power System Model

In power applications and system configuration, displaying and reproduction are fundamental to upgrade control and improve system operations. In this section, the models for the primary parts of the proposed hybrid power system are created and approved. It incorporates wind turbine power system, photovoltaic power system, battery storage, dc-ac converter, and dc-dc converter. Moreover, the MATLAB Simulink circuit piece models for each system are appeared in separate segment.

3.1.1 System Description

Displaying of the PV-Wind hybrid system is completed utilizing MATLAB Simulink.

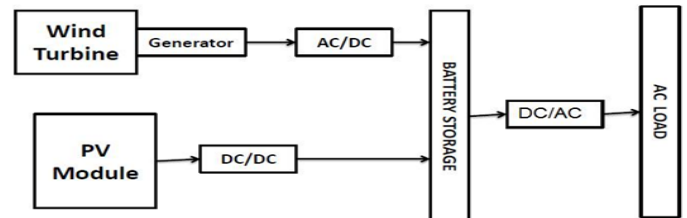

Fig.5: Block diagram of system conceptual framework

The Solar-Wind Hybrid Power System (SWHPS) comprises of a few units, PV power and wind power units as essential energy sources, battery bank unit as helper energy source, dc-air conditioning and dc-dc converters, control and load unit. The capacity of controller unit is to guarantee the power administration, which is conveyed by the hybrid system to fulfil the load request and to charge the battery.

Modelling of Wind Turbine

The wind turbine power system comprises of a wind turbine model and a Permanent Magnet Synchronous Machine (PMSM) block that is accessible in the Simulink library. Figure 5 demonstrates the wind turbine block model produced by Simulink. This model is utilized as an establishment for later models consolidating the FLC, and its motivation is to advance the power created by the wind turbine.

Fig.6: Wind turbine block model generated by Simulink

Modelling of Photovoltaic Module

Figure 6 demonstrates the subsequent Matlab-Simulink model. The nonlinear idea of PV module is obvious as appeared in the figures, i.e., the yield power and current of PV module rely upon the cell temperature, and solar irradiance and the cell terminal working voltage also.

Fig.9: Battery model generated by Simulink

Modelling of DC-DC Converter

This model can be readily used for any closed loop design, that is, PI or fluffy. Figure 9 shows a Simulink model for a closed loop dc-dc converter.

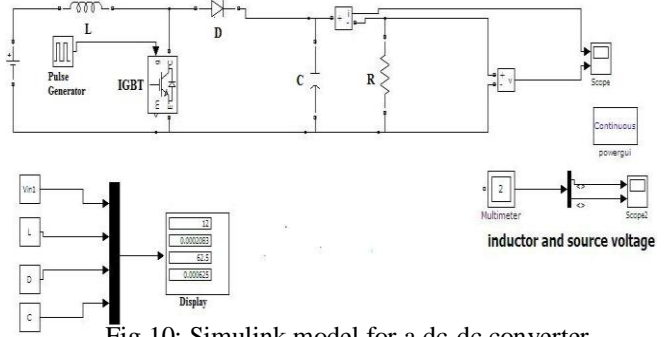

Fig.10: Simulink model for a dc-dc converter

Fig.11: Simulink model for a dc-ac converter

Modelling of DC-AC Converter

DC-AC inverters are electronic devices used to produce mains voltage AC power from low voltage DC energy (from a battery or solar panel). This makes them very suitable when you need to use AC power tools or appliances. The model describing the operation of inverter is implemented in the Simulink block as shown in Figure 10.

Input parameters

Table.1: Input parameters for Simulation Environment

Wind		Battery	
Power	8.5e3 W	Voltage	300V
Speed	12 m/s	Initial SOC	60%
Maximum Power	0.8MW	Maximum Capacity	7KW
Rational	1 PV	Normal	353.38

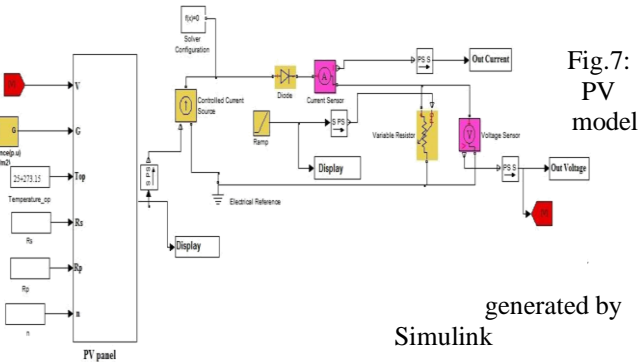

Fig.7: PV model

generated by Simulink

Modelling of Battery Storage

A validated electrical circuit model for lead-acid batteries, shown in Figure 7 is available in Mat lab-Simulink library, as reported in [48].



Fig.8: Battery Model

		Discharge current	
		Resistance	6.25 Ohm

PV		Simulation	
Base Power	100e6	t	300-600V
P2 Tolerance	1e-4	V_{iv}	26.3V
Frequency	50 Hz	Nominal voltage	48.0V

In table.1 use different parameter for initializing the experiment and its constraint. "Base power" is the capacity of grid. "P2tolerance" power changes error tolerance if error increase given limit Simulink given error "frequency" represent frequency of voltage "t" changes is power limit or load flow which is tolerate without error. " V_{iv} " minimum voltage and "nominal voltage" is maximum voltage these voltage balance the load a battery discharge

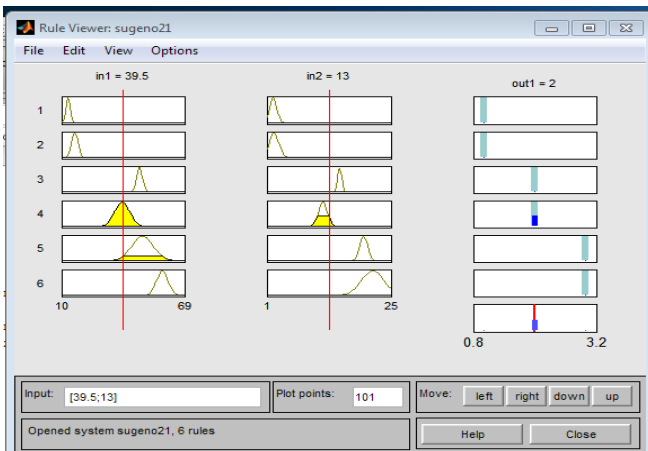

Fig.12: Fuzzy rules optimization by fuzzy logics

Development of optimal power management algorithm

1. *Perturb and Observe PV maximum power Point Tracking Algorithm:* The problem considered by MPPT techniques is to automatically find the optimum voltage (V M P) or current (IM P) at which a PV module should operate, under a given solar irradiance and temperature. Perturb and observe method is the most commonly used technique because of its simplicity and ease of implementation. It requires two inputs; measurement of the current (I_{pv}) and measurement of the voltage (V_{pv}).

2. *ANFIS Based PV Maximum Power Point Tracking:* Figure 14 show the proposed PV MPPT controller based on ANFIS.

3. *FLC based wind maximum power point tracking:* During the control process, fuzzy membership functions with a range [0, 1] are utilized for converting the controller's input variables for the membership values.

IV. RESULT ANALYSIS

4.1 Result Analysis

Table 1: Simulation Environment

Wind		Battery	
Power	8.5e3 W	Voltage	300V
Speed	12 m/s	Initial SOC	60%
Maximum Power	0.8MW	Maximum Capacity	7KW
Rational	1 P.V	Normal Discharge current	353.38
		Resistance	6.25 Ohm

PV		Simulation	
Base Power	100e6	t	300-600V
P2 Tolerance	1e-4	V_{iv}	26.3V
Frequency	50 Hz	Nominal voltage	48.0V

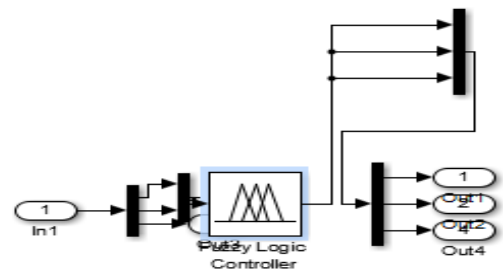

Fig.13: Fuzzy Interface in Simulink

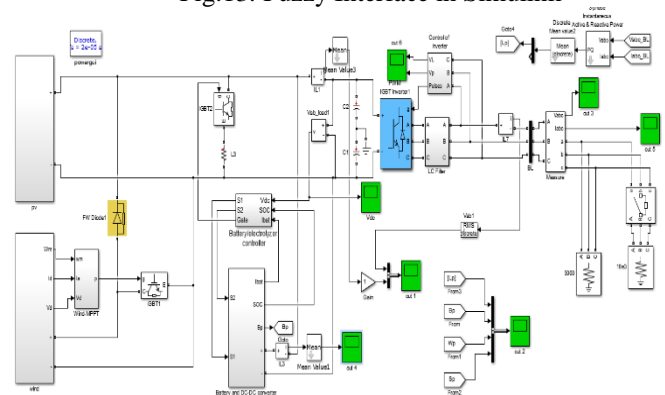

Fig.14: Simulink Used for Simulation

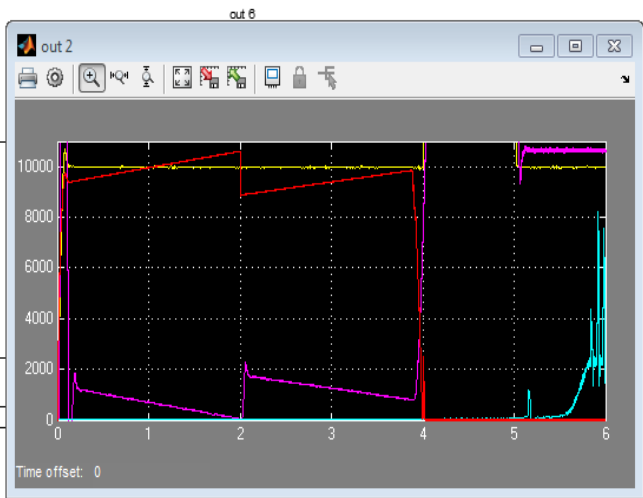

Fig.15: Voltage angle of PV, Battery and wind during Fuzzy logic

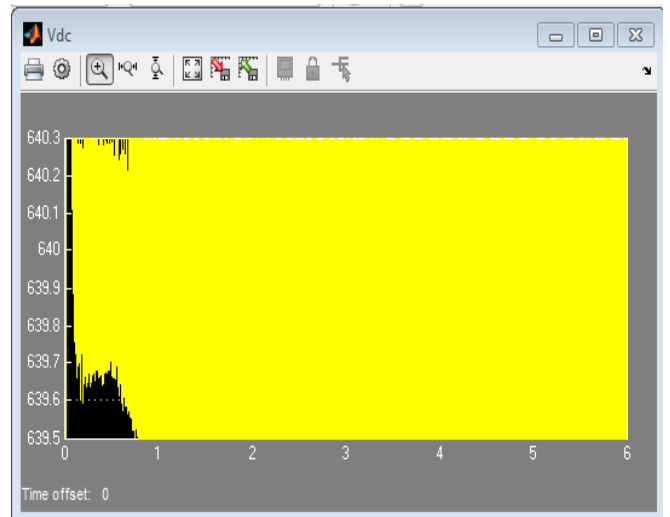

Fig.18: Battery gain by PSO

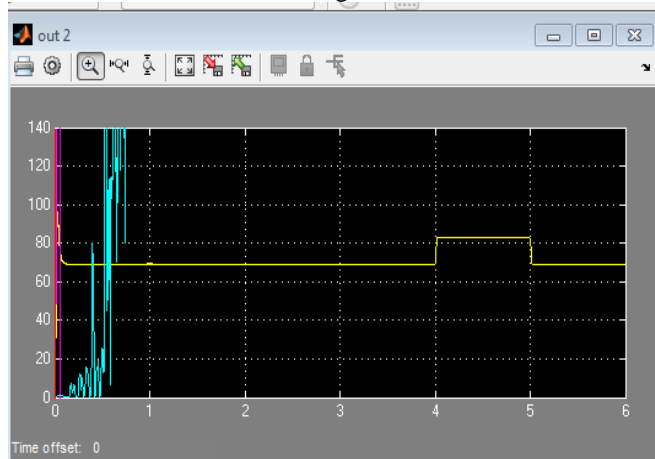

Fig.16: Voltage angle of PV, Battery and wind during PSO

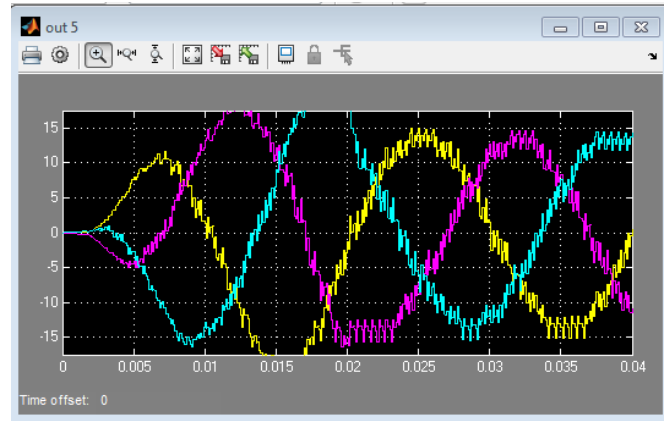

Fig.19: Load flow by fuzzy logic

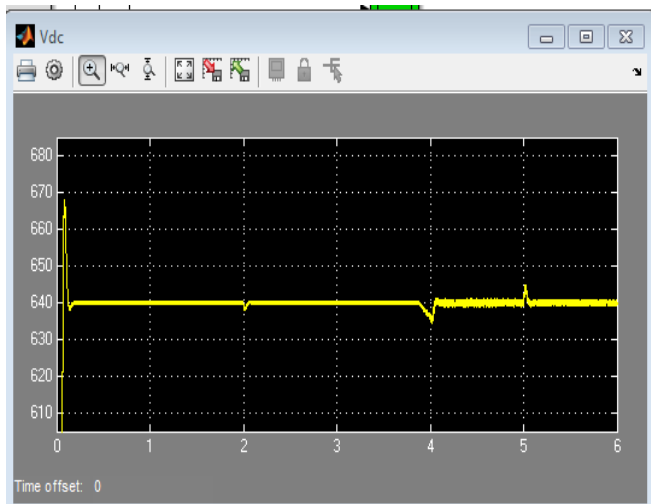

Fig.17: Battery gain by Fuzzy logic.

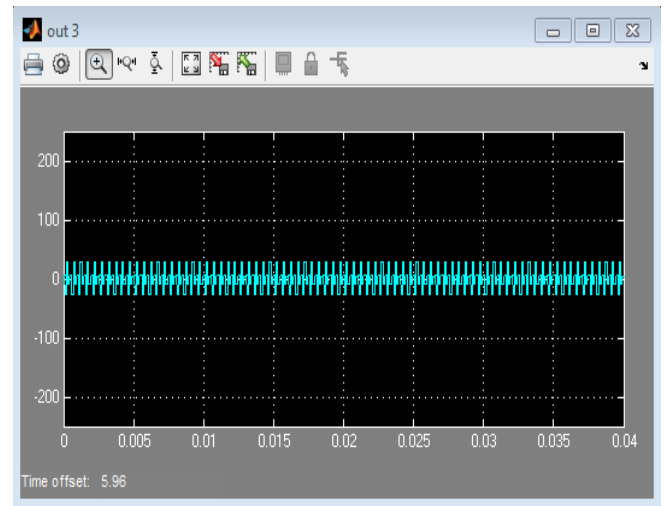

Fig.20: load flow by PSO

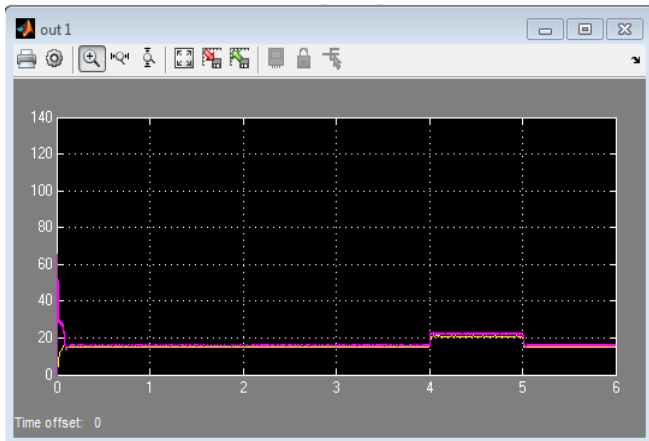

Fig.21: Volume of wind and PV array current by fuzzy logic

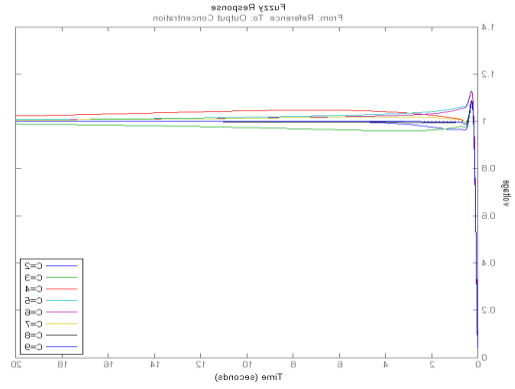

Fig.24: Voltage stability comparison in different constraint

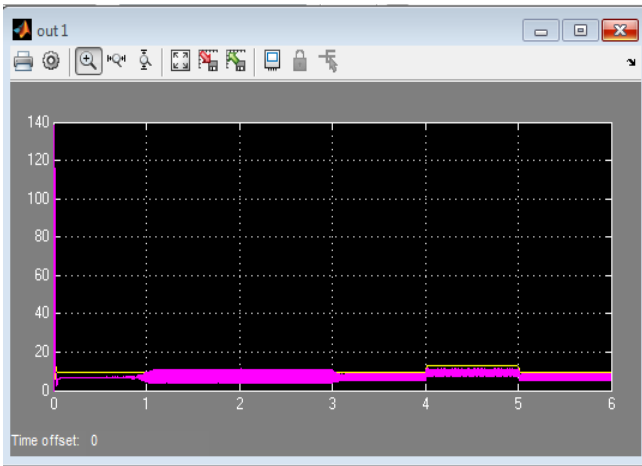

Fig.22: Volume of wind and PV array current by PSO

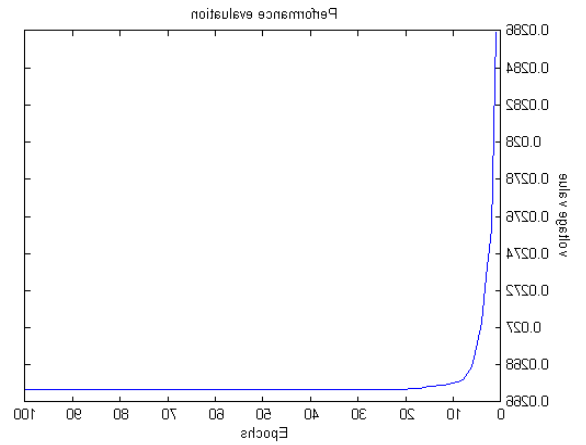

Fig.25: voltage stability in different iteration by PSO

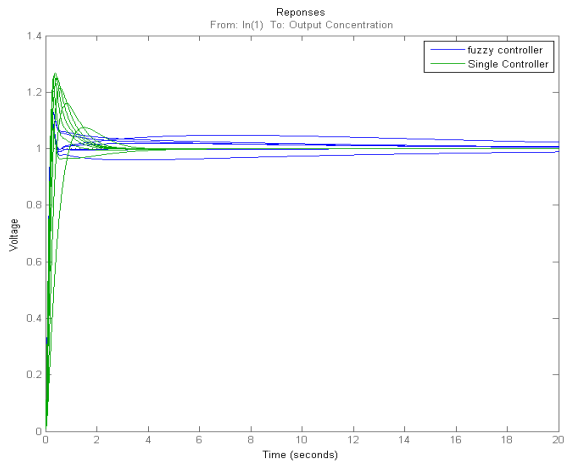

Fig.23: Voltage stability comparison

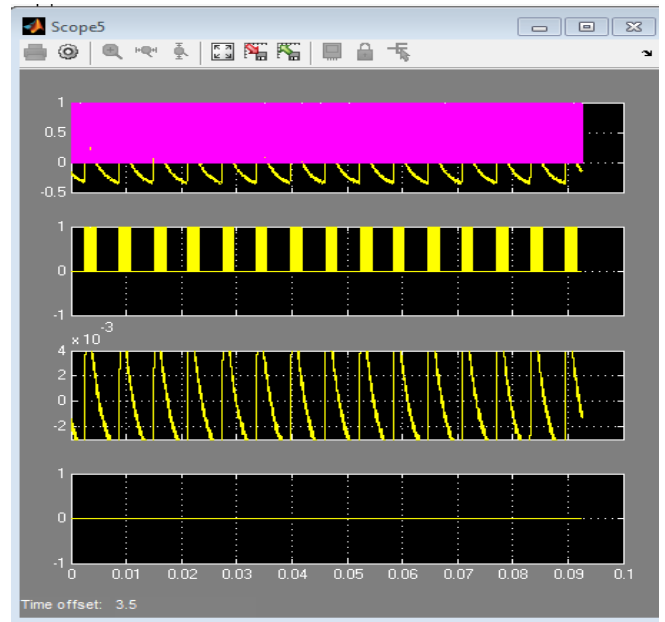

Fig.26: voltage stability of wind and PV array current by PSO

Table .2: For case study environment

Component	Rating(W)
Wind Power	1500
PV Power	1500
Battery	3000
Load	2000

Case1: In Hybrid: Here it considers the state where all of the renewable sources are insufficient to run the load and battery alone is sufficient to run the load. The battery selector switch (SSW4) is activated and remaining selector switches are turned off.

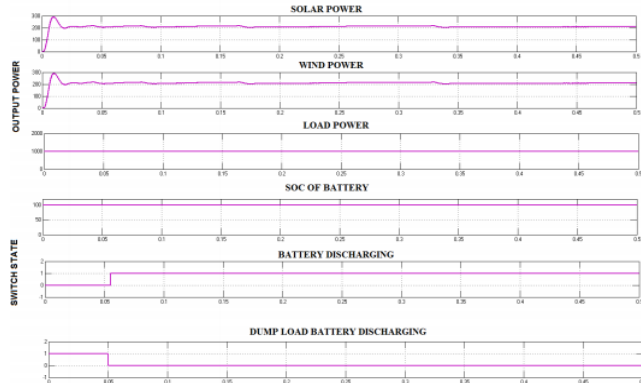

Fig.27: Simulation result of the FLC power management when hybrid

In Figure 26, the power produced by PV and wind are very low, the load demand is medium and the battery state of charge is high enough to run the load. In this case the FLC activates the battery discharging switch SSW3 and all the remaining selector switches are turned off. Fuzzy rule satisfying this condition is: "If (P_i is M) and (P_{pv} is VL) and (P_w is VL) and (P_b is H) and P_{db} is (VL, L, M) then (SSW1 is OFF) and (SSW2 is OFF) and (SSW3 is ON) and (SSW4 is OFF) and (SSW5 is OFF) and (SSW6 is OFF)"

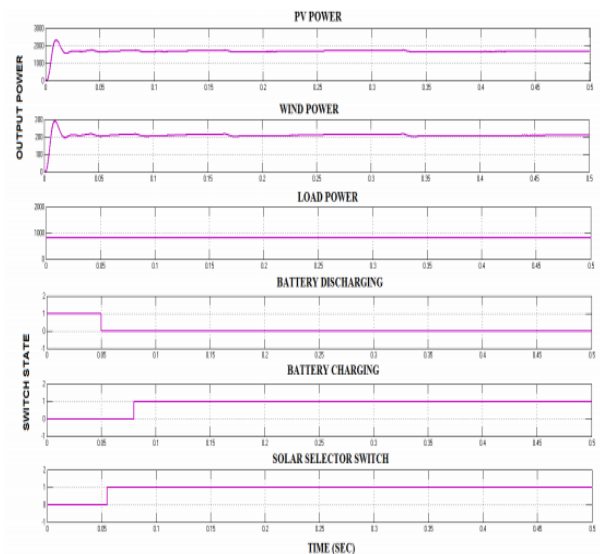

Fig.28: Simulation result of the FLC power management when PV power alone supplies load

Case2: IN PV: Figure 27 shows the status of a single source supplied load. This is the state where any of the renewable sources is sufficient to run the load. In Figure 27, PV alone is sufficient to run the load, PV selector switch (SSW2) is activated and the remaining selector switches are turned off. In the event that the solar power supplied is more than the load demand, the excess power is used to charge the battery through SSW4. The excess power thus activates the charge control SSW4. Fuzzy rule which satisfies this condition is: "If (P_i is M) and (P_{pv} is H) and (P_w is VL) and (P_b is VL/L/M) then (SSW1 is ON) and (SSW2 is OFF) and (SSW3 is OFF) and (SSW4 is ON) and In Figure 22 the power produced by the PV is very high, approximately to its maximum power of 1500w, the power produced by wind is very low, less than 200w while the load demand is high. In this case the PV alone is sufficient to run the load; the excess power from the wind is used to charge the battery through FLC signals to SSW4. (SSW5 is off).

In Case 3: PV with wind: Here is considered the state where all of the renewable sources are sufficient to run the load. The PV selector switch SSW1, the wind selector switches SSW2, and charge control switches (SSW4 and SSW6) are activated and the other selector switches are turned off. Figure 24 shows the response of FLC to this mode of operation. In Figure 28, the power produced by PV and wind is high; the load demand is so high. In this case the FLC activates the PV selector switch SSW2, the wind selector switch SSW1 and battery charging switches SSW4 and SSW6. Fuzzy rule which satisfies this condition is: "If (P_i is H) and (P_{pv} is H) and (P_w is H) and (P_b is VL/L/M) and P_{db} is (VL,L,M) then (SSW1 is

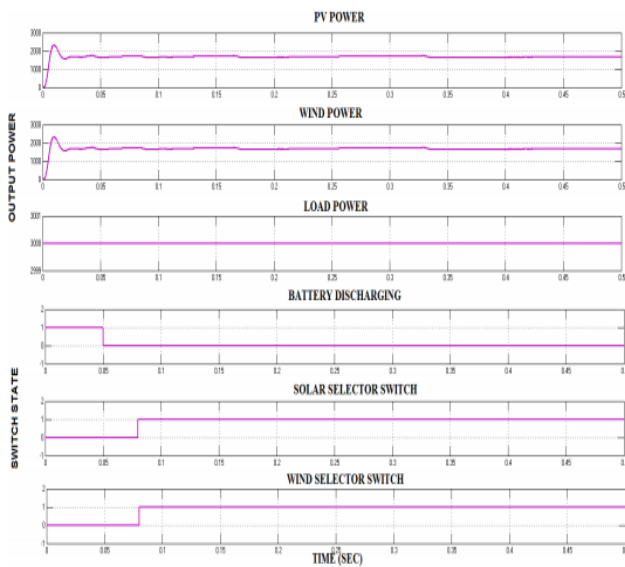

Fig.29: Simulation result of the FLC power management when PV and Wind supplies loadon) and (SSW2 is on) and (SSW3 is off) and (SSW4 is on) and (SSW5 is off) and (SSW6 is on)”

V. CONCLUSION

The conclusion of this research study depends on the following methods:

1. PV cell, module and array are simulated and effect of environmental conditions on their characteristics is studied
2. Wind energy system has been studied and simulated
3. Maximum power point of operation is tracked for both the systems using FUZZY rules algorithm
4. Both the systems are integrated and the hybrid system is used for battery charging and discharging
5. Battery discharging reduces by using fuzzy rules use in management of load.
6. Power and wind reduce the power loss because effective monitoring of power management

V. REFERENCES

- [1]. Ramu, K., and Rambabu, K. (2014). Renewable Energy Based Small Hybrid Power System for Desalination Applications in Remote Locations, *International Journal of Electrical, Electronics and Data Communication*, 2 (1), 2320-2084.
- [2]. Manyonge, R., Ochieng, F., and Shichikha, J. (2012). Mathematical Modeling of Wind Turbine in a Wind Energy Conversion System Power Coefficient Analysis, *Applied Mathematical Sciences*, 6 (2), 4527 - 4536.
- [3]. Cugnet, M., and Liaw, B. (2011). Effect of discharge rate on charging a lead-acid battery simulated by mathematical model, *Journal of Power Sources*, 196 (7), 3414-3419.
- [4]. Yang, Y., and Zhao, F. (2011). Adaptive Perturb and Observe MPPT Technique for Load- Connected Photovoltaic Inverters, *Procedia Engineering*, 23 (2), 468-473.

- [5]. Natsheh, E., Albarbar A., and Yazdani, J. (2011). Modeling and Control for Smart Load Integration of Solar/Wind Energy Conversion System, *Innovative Smart Load Technologies (ISGT Europe)*
- [6]. Zamani, M., and Riahy, G. (2008). Introducing a new method for optimal sizing of a hybrid (wind/PV/battery) system considering instantaneous wind speed variations, *Energy for Sustainable Development*, 12 (2), 27-33.
- [7]. Zhou, W., Yang H., and Fang, Z. (2007). A novel model for photovoltaic array performance prediction, *Applied Energy*, 84 (12), 1187-1198.
- [8]. De Oliveira, C., and Lopes, M. (2004). Early stages of the lead-acid battery discharge, *Journal of Power Sources*, 138 (1-2), 294-300
- [9]. Kerr, M., and Cuevas, A. (2004). Generalized analysis of the illumination intensity vs. open-circuit voltage of solar cells, *Solar Energy*, 76 (1-3), 263-267.
- [10]. Kerr, M., and Cuevas, A. (2003). Generalized analysis of the illumination intensity vs. Open circuit voltage of PV modules. *Solar Energy* 76 (1) 263-267.
- [11]. Jurado, F., and Saenz, J. (2003). An adaptive control scheme for biomass-based diesel{wind system, *Renewable Energy*, 28 (1), 45-57.
- [12]. Piller, S., Perrin M., and Jossen, A. (2001). Methods for state-of-charge determination and their applications, *Journal of Power Sources*, 96 (1), 113-120.
- [13]. Nguyen, T. (1990). The Effects of Separator Design on the Discharge Performance of a Starved Lead-Acid Cell, *J. Electrochem. Soc.*, 137 (10), 2998.