

1975



ROUTE 5, BOX 127
WALLA WALLA, WASHINGTON 99362
AREA CODE 509, Phone 529-2554

INDEX

ACCESSORY CASE.....	4	HAND LOCATORS.....	13
ARMGUARDS.....	13, 14, 15, 18	INSECT REPELLENT.....	39
ARROWS.....	7, 8, 9	KISSER BUTTONS.....	25
ARROW BOXES.....	43	KNIVES.....	48
" " CLIPS.....	41	KWIK KNURL.....	49
" " HOLDERS.....	32	LACQUER.....	29
" " NUMBERS.....	18	LURE.....	33
" " RESTS.....	19	NOCKS.....	45
" " STRAIGHTENERS.....	41	NOCKING POINTS.....	30
BELTS.....	13, 16	POINTS-	
BINOCULARS.....	21	Field, Target, Blunts.....	49
BLUNTS.....	11, 49	POUCH.....	14
BOOKS.....	36	POWDER POUCH.....	13
BOWBIRDS.....	31	QUIVERS.....	12, 13, 16, 17
BOWS.....	2, 3, 4, 5	RACKS.....	40
BOW LEVELS.....	31	RAW MATERIALS.....	49
" SADDLES.....	13	RELEASES.....	21
" SLINGS.....	13	RESTS.....	19
" SQUARES.....	28	SCENT.....	33
" STRINGS.....	27	SCORE CARDS.....	18
" STRING JIG.....	28	SERVING THREAD.....	27
" STRING SILENCERS.....	31	SHAFTS.....	49
" TIP PROTECTORS.....	30	SHAFT SPIDER KIT.....	38
BROADHEADS.....	10, 11	SIGHTS.....	22, 23
BROADHEAD COVERS.....	17	SIGHT APERTURES.....	24, 26
" " SHARPENERS.....	37	" BRACKETS.....	23
" " STONES.....	37	" EXTENSIONS.....	26
BRUSHES.....	29	" PARTS (Reynolds).....	26
CALLS.....	33	SMOKE CLIPS.....	40
CAMOUFLAGE.....		SNAKE BITE KIT.....	39
Clothing, Hats, Tape.....	34, 35	STABILIZERS.....	6
CEMENTS.....	44	STRING KEEPERS.....	30
CHARTS.....	48	" SIGHTS.....	25
CHEST GUARDS.....	15, 18	TABS.....	20
CLICKERS.....	32	TAPER TOOLS.....	45
COMPASS.....	40	TARGETS.....	46, 47
CRESTING LACQUER.....	29	TARGET ADHESIVE.....	46
CRESTOR.....	41	VINYCALS.....	38
CROSSBOW.....	6	WATER REPELLENT.....	29
DIP TUBE.....	49	WRIST ROCKETS.....	18
FEATHER TRIMMERS.....	41	X-ACTO SETS.....	41
FIRST AID KITS.....	39		
FISH LINE.....	36		
" POINTS.....	37		
" REELS.....	36		
FLETCHING Feathers,			
Fur Fletch, Plasti-Fletch.....	42		
FLETCHING JIGS.....	43		
GLOVES.....	14		
GLOVE POWDER.....	20		
GROUND QUIVERS.....	18		

FOR RUSH ORDERS, CALL 1 (509) 529-2554

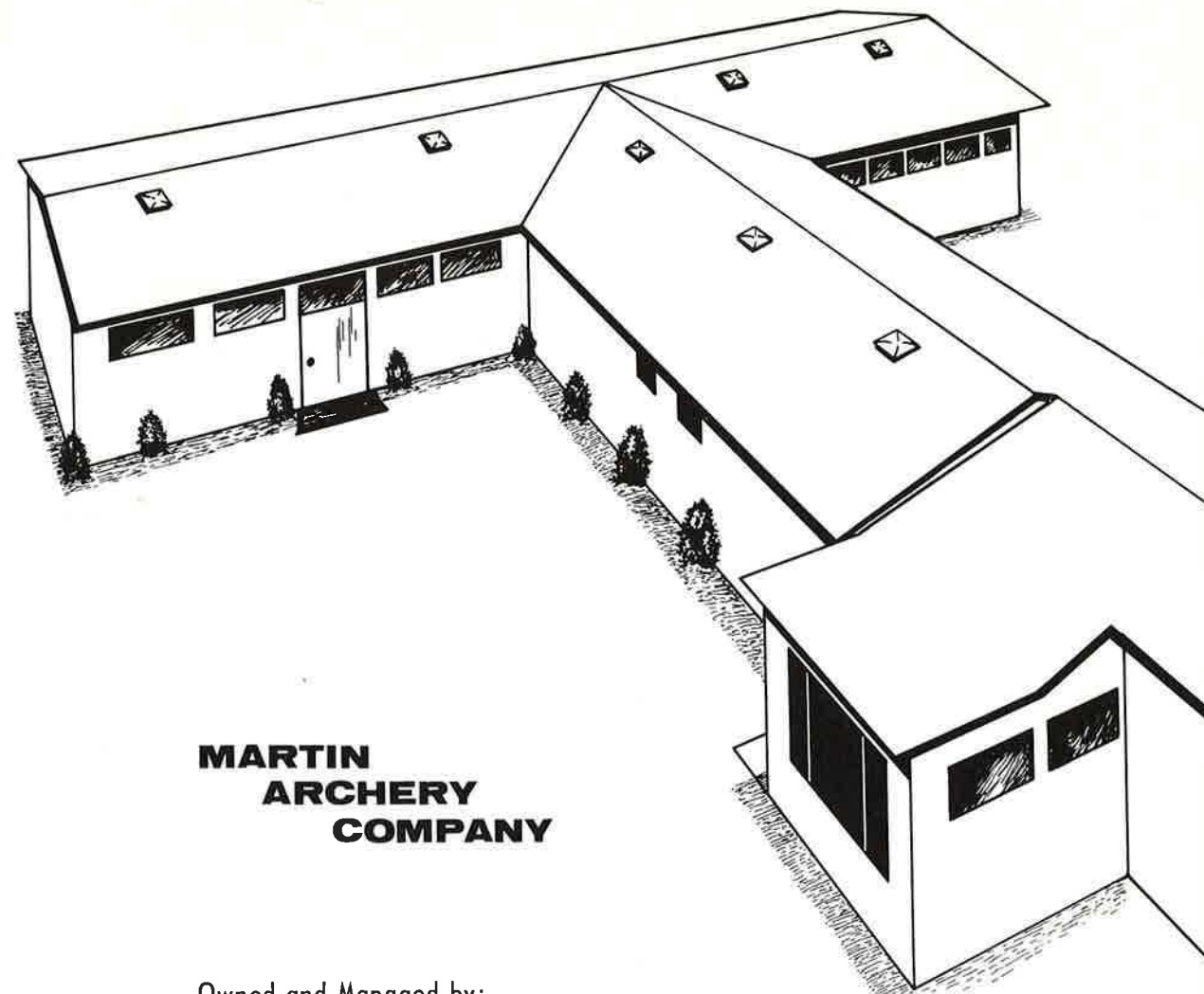

**MARTIN
ARCHERY
COMPANY**

Owned and Managed by:

Mr. and Mrs. Gail Martin
and Sons, Terry and Dan

**Largest, Most Complete Stock of
Archery Supplies in the West**

TERMS:

All prices F.O.B. Walla Walla. Cash with order or C.O.D., unless credit has been established. Do not return merchandise unless approved - Returns subject to 10% deduction.

SHIPPING:

Specify method of shipping or we will ship by least expensive means . . .

AIR MAIL - PARCEL POST - UNITED PARCEL SERVICE - AUTO FREIGHT

MOST ORDERS ARE SHIPPED THE SAME DAY RECEIVED BY US!

- Prices subject to change without notice -

MARTIN BOWS

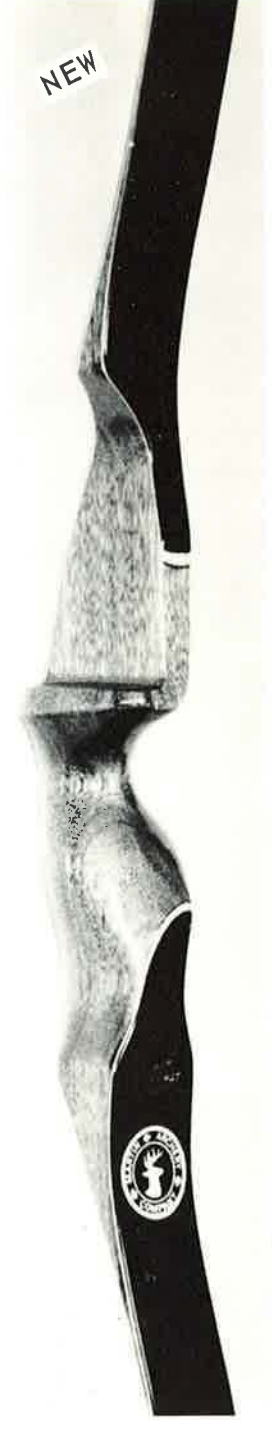

MX800

Superbly styled and finished. An excellent performer.
Lengths — 66" and 69"
Weights — to 55 lbs.
Handle riser — Rosewood and Bubinga
Glass color — white
With stabilizer insert

\$115.00

MX750

Performance and beauty in a bow reasonably priced.
Length — 66"
Weights — to 55 lbs.
Handle riser — Shedua and Bubinga
Glass color — white
With stabilizer insert

\$79.50

MX600

Our finest hunting bow. Superb speed, smooth power, and remarkable accuracy.
Lengths — 54", 58" and 62"
Weights — to 55 lbs.
Handle riser — Bubinga and Rosewood

Glass color — black
\$65.00

MX500

A truly great performer. Combines smoothness and hitting power.
Length — 60"
Weights — to 55 lbs.
Handle riser — Dark Tropical Hardwood

Glass color — Dark brown
\$43.50

MX400

Smooth action. Excellent accuracy.
Length — 62"
Weights — to 55 lbs.
Handle riser — Eastern Maple
Glass color — assorted

\$29.50

MX300

For hunting or youngster target bow.
Length — 52"
Weights — to 50 lbs.
Handle riser — Hardwood
Glass color —

\$26.50

MARTIN BOWS

#1000 TAKE DOWN BOW WITH CASE

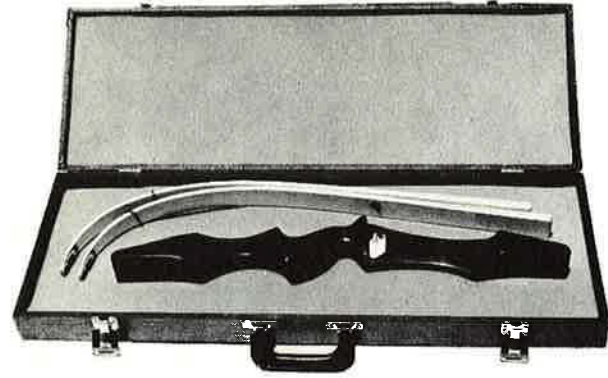

Available in the following lengths
70" - 66" - 64" - 60"

The case is large enough to hold the handle and up to 3 sets of limbs, yet small enough to go anywhere. Its dimensions are 29" x 9" x 3".

The handle is guaranteed for 5 years and the limbs for 2 years against failure due to defects in workmanship or material.

Bow complete with case \$139.50
Extra limbs \$ 49.50

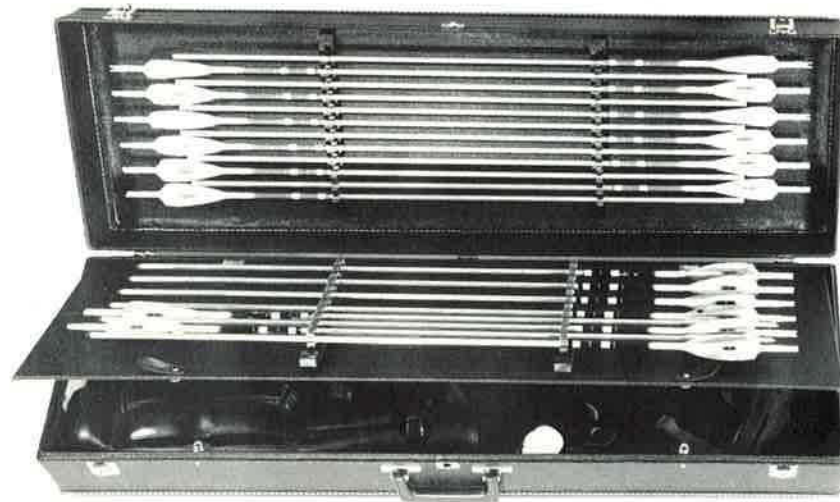

MARTIN
8" x 12" x 37"
ARROW AND
ACCESSORY CASE

- Holds 24 Arrows
- Vinyl Covered Case
- Chrome Corner Bumpers
- Lower Section for Accessories

\$34.50



Fred Bear Field Model
ALL-PURPOSE
TAKE-DOWN BOW
60"

Standard Equipment (Complete Bow): Vinyl Arrow Rest, Vinyl-Covered Adjustable Arrow Plate, Convert-A-Accessory Insert, Powered Limbs, Standard Pistol Grip, Bear Custom Black Temper Strand Bowstring.

Complete Bow \$159.50
Limb only \$ 82.50
Handle only \$ 78.50

Available Wts. 25-70 lbs.



#2181 Magnesium Take-Down
Bow Grips

The Field Model Take-Down handle is designed for simple installation of three different handle grips. Made of non-slip vinyl, you choose the specific type grip you prefer. The standard pistol grip is standard equipment on all Field Model Take-Downs. But you can choose either a medium or a high pistol grip. Specify #1 Standard pistol, #2 Medium pistol, #3 High pistol, and right or left hand when ordering.

\$2.00

FIBRE-GLASS BOWS
(Bow weights in 5 lb. increments)

No. 1	42 in.	10 lbs.	\$ 5.00
No. 3	48 in.	20-25 lbs.	7.00
No. 4	54 in.	20-35 lbs.	9.00
No. 6	60 in.	20-30 lbs.	11.00
No. 8	60 in.	40-55 lbs.	14.00

COLORFUL EPOXY FINISHES

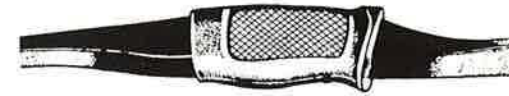

Extra 10% discount on 10 or more



"All bows hand nocked"



#18 CUB ARCHERY SET
(Up to 8 years of age)

- 1 42" Fibre-Glas Bow—10 lbs./15 lbs.
- Hemp String
- 3 Cedar Target Arrows
- 1 Quiver
- Target face and Booklet

\$6.00



#19 TEEN ARCHERY SET
(10-16 years of age)

- 1 54" Fibre-Glas Bow—30 lbs./35 lbs.
- Dacron String
- 3 Cedar Target Arrows
- 1 Armguard
- 1 Finger Tab
- 1 Belt Quiver
- Target Face and Booklet

\$13.00

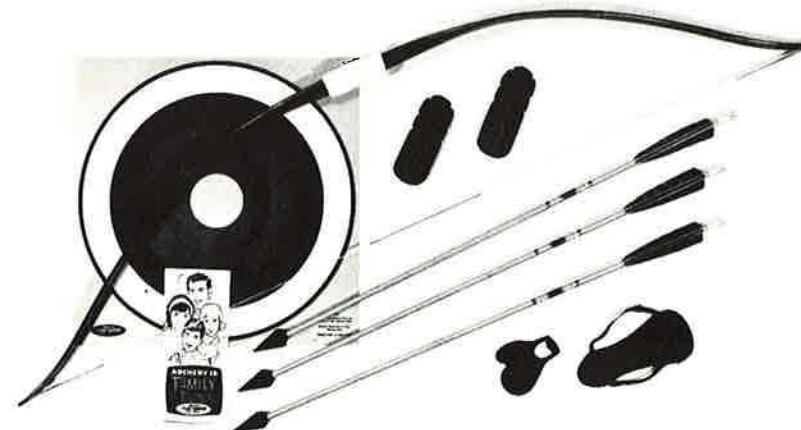

#20 HUNTING SET

- 1 58" Fibre-Glas Bow 40 lb/45 lb
- Dacron String
- 3 Cedar Hunting Arrows
- 1 Armguard
- 1 Finger Tab
- Target Face and Booklet
- 1 Bow Quiver

\$17.00

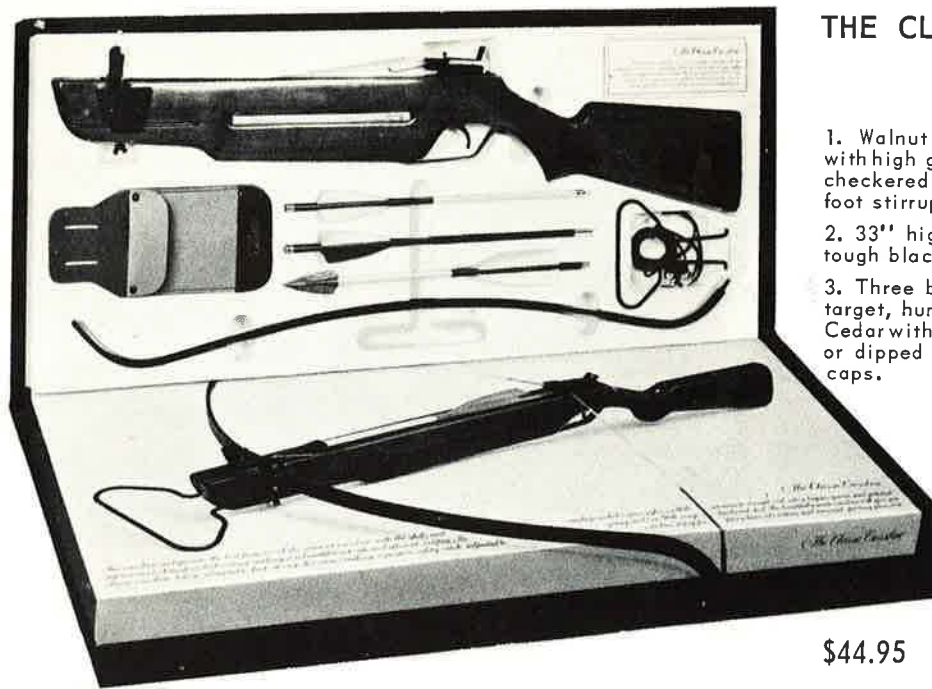

THE CLASSIC CROSSBOW SET

1. Walnut stained hardwood stock with high gloss finish and handsome checkered pistol grip, includes metal foot stirrup for easy cocking.
2. 33" high carbon steel limb with tough black oxide finish.
3. Three bolts — 1 each of blunt, target, hunting. Made of Port Orford Cedar with die cut fletching and color dipped shafts, plated steel nock caps.
4. Leather-textured vinyl quiver, with belt loops.
5. Heavy duty Dacron bow string with nylon wrapped loops.
6. 250 lb. tensile strength nylon bow stringer with rugged aluminum alloy caps.

\$44.95

#X-1 MARTIN STABILIZERS

Made of the finest aluminum with marbled ball and steel thread.
Rods anodized in red or blue.
Has tapered rod to absorb more vibration.
Thread sizes available for any bow.
Overall length: 31½". Weight: 5 oz.

Stabilizer complete \$12.50

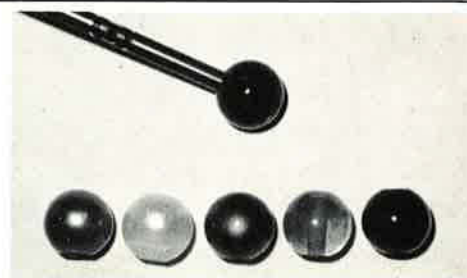

Ball weights available in: blue, red, black, yellow or pearl white.
Extra ball weights . . . \$2.00 ea.

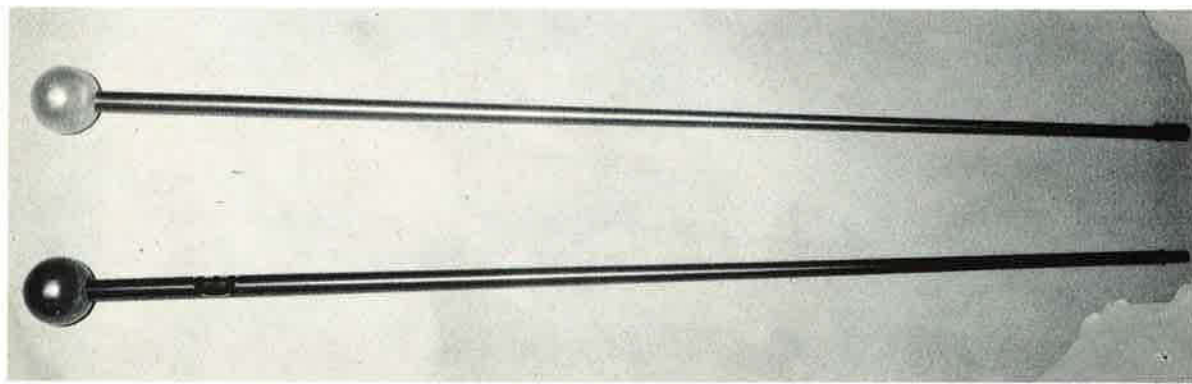

HUNTING STABILIZER
Flexible-shaft custom hunting stabilizer. \$9.95



#603 Stabilizer \$12.50

#614 Flex Connect \$9.95



MARTIN CUSTOM ARROWS



#050 Arrows 5/16 shaft, 2½" fletch
Packed in half or one gross box. Available in 24", 26", 28". Extra discount (10%) on 5 gross and up.

\$.30 each

#275 Arrows 5/16 and 11/32 shaft, full lacquer finish with two color crest, for 30 to 40 lb. bows, 3" dyed white fletch; 24, 26, 28" lengths with target points. Packed in half or one gross box. (Ideal for school use) Extra 10% discount on 5 gross.

\$.50 each

#280 Arrows 11/32 shaft, 4" fletch; length with target point, 28"; length with drawn steel field point, 29". Extra 10% discount on 5 gross.

\$.55 each

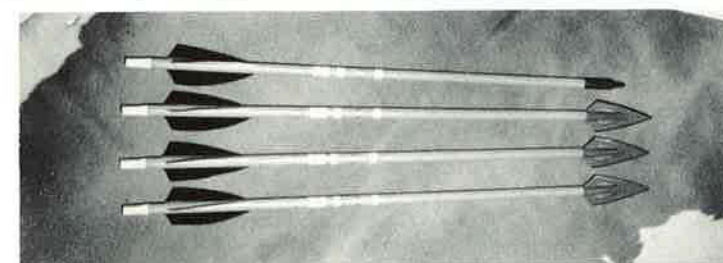

CROSSBOW ARROWS
with 125 grain field point \$.75 each
with Three Blade Broadhead 1.25 each

ARROW RECONDITIONING

GLASS — WOOD OR METAL

REFLETCHED RECRESTED
RENOCKED STRAIGHTENED

\$10.00 per doz.

4 Fletch
\$2.00 extra per doz.

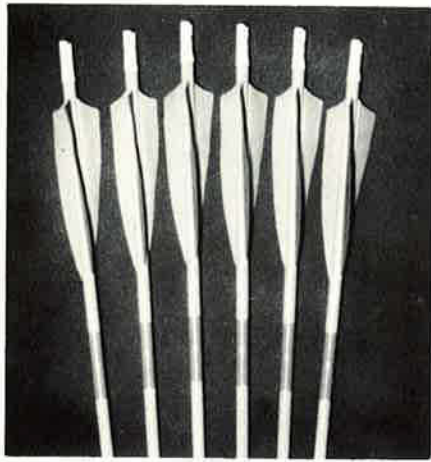

#290 Arrows 11/32 shaft, matched in spine to 5 lbs., 5" fletch, 32½" length, or tapered for broadhead. Packed in 1 gross box. Extra 10% discount on 3 gross and up.
per doz. **\$8.50**
Available with target, field point, or broadhead.
ADD PRICE OF POINT OR HEAD.

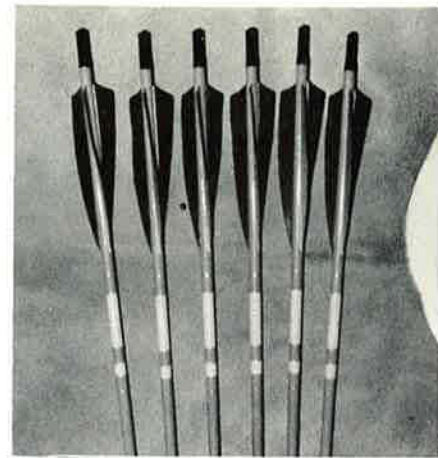

#350 Arrows 5/16 or 11/32 shaft with 5" helical 3 fletch, matched in spine, 5° taper for broadheads. (Not matched in grain weight.)
per doz. **\$10.00**
Available with target, field point, or broadhead.
ADD PRICE OF POINT OR HEAD.

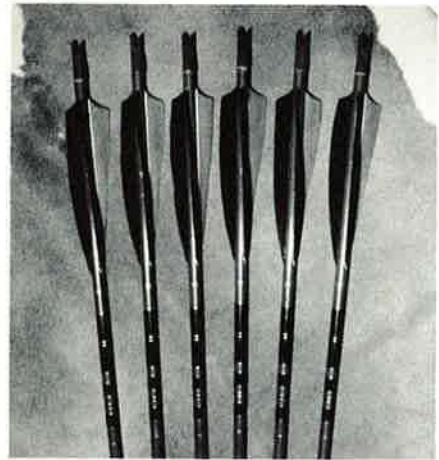

FOR 500 gr. ELK WEIGHT ARROWS, ORDER #400
#400 Arrows Our finest wood arrows, 5/16 or 11/32 shaft, matched in weight and spine, helical 3 fletch, full length or cut to length with 5° taper.
per doz. **\$12.00**
Available with target, field point, or broadhead.
ADD PRICE OF POINT OR HEAD.

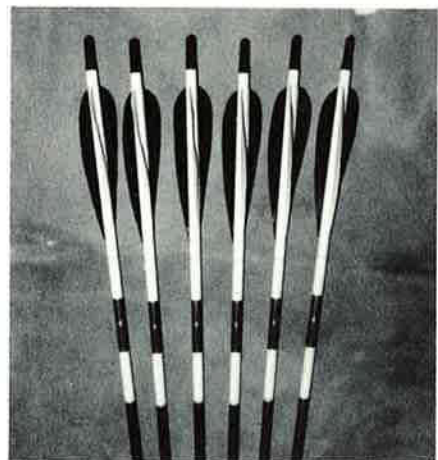

NEW HUNTER GREEN GLASS ARROWS
Available in sizes #7, 8, 9, 10, 11.
Extra 10% discount on 12 dozen.
per doz. **\$18.50**
Available with target, field point, or broadhead.
ADD PRICE OF POINT OR HEAD.



#FT-1 Flu Flu Arrows Full length without point
\$ 1.25 each

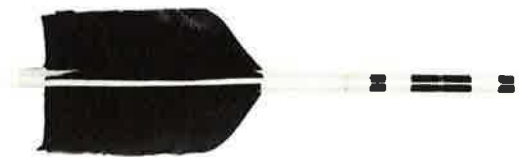

#FT-2 Flu Flu Arrows Full length without point
\$1.75 each



Solid Glass Fish Arrows each **\$2.50**

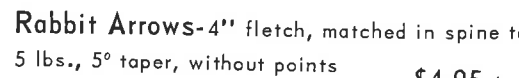

Rabbit Arrows-4" fletch, matched in spine to 5 lbs., 5° taper, without points
\$4.95 doz.



#BH Forgewood BATTLESHAFT HUNTING **\$17.95 doz.**
plus price of broadheads

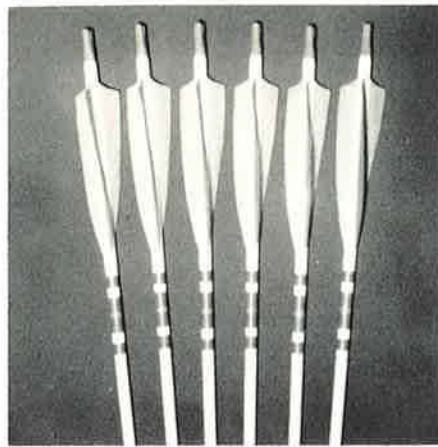

Martin Micro-Flite Glass Arrows

3 fletch, helical, target or broadhead adaptor
per doz. **\$28.50**
with field point-per doz. **\$29.50**
(Add \$2.00 extra per dozen for four fletch)

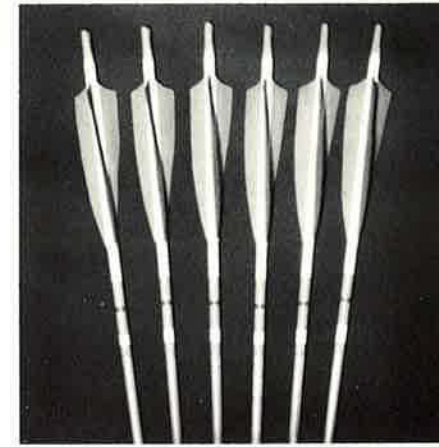

Martin Special Aluminum (Swift) Arrows

3 fletch helical target or hunting - per doz. **\$23.95**
Available in sizes: 1413, 1416, 1518, 1616, 1618, 1716, 1718, 1816, 1818, 1820, 1916, 1918, 1920, 2016, 2918, 2020, 2117, and 2219.

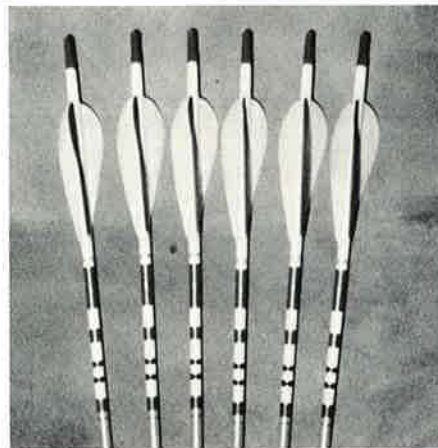

Martin Easton Aluminum

24 SRT X 3 fletch, helical - per doz. **\$29.50**
XX 75 3 fletch, helical - per doz. **\$34.50**

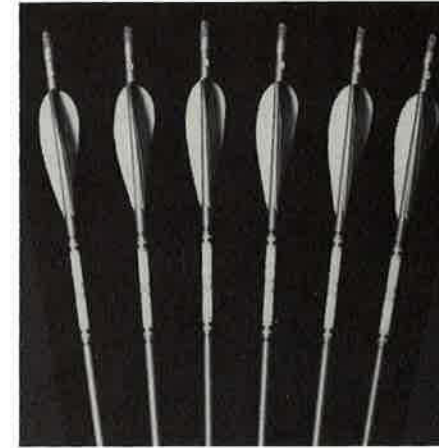

Martin Easton Aluminum X7

3 fletch, helical (Available in 1614, 1616, 1714, 1716, 1814, 1816, 1914, 1916, and 2014)
per doz. **\$39.50**

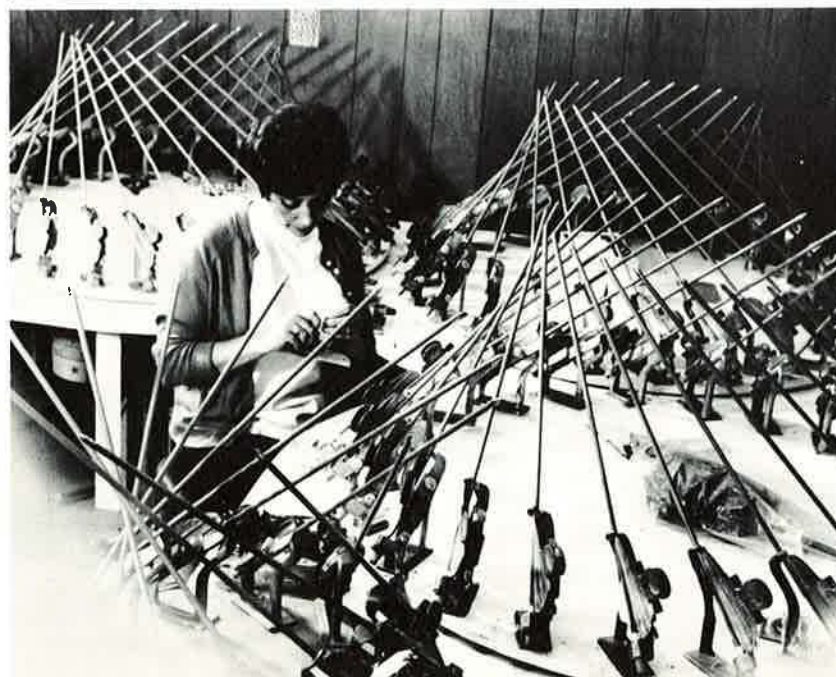

MARTIN ARROWS are made of the finest material available. All arrows are fletched with precision die cut feathers and are carefully inspected before shipping. We will be glad to make custom arrows to your specifications with the crest, fletch and nock you prefer.

BROADHEADS

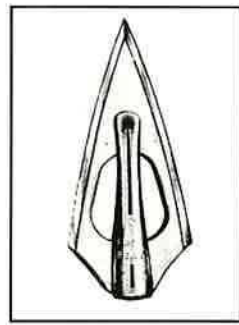

BEAR INSERTS



\$1.35 per doz.



M-A 3 BLADE

5/16 (100 grains),
11/32 (125 grains).

\$3.95 Doz.

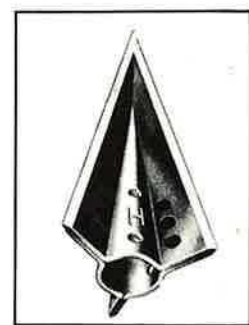

HI-PRECISION

3-Bladed, 125 grains.

\$3.95 Doz.

BEAR RAZOR HEAD On Display Cards

Heads with inserts ----- \$6.75 per doz.

Heads only ----- \$5.50 per doz.

Also available in bulk
to arrow manufacturers

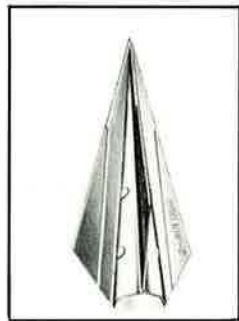

BOD-KIN

Hollow ground, 11/32"
125 grain, copper brazed,
5° taper

\$3.95 Doz.



The PANTHER IV

Cutting area 1 1/4", 125
grains, finest quality
spring steel

\$4.50 Doz.

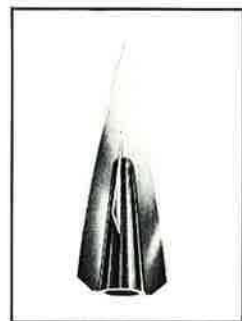

ARROWMATE

4 Blade

\$5.00 Doz.

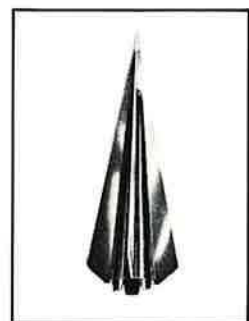

ARROWMATE

3 Blade, 1 1/8" cut-
ting circle, tempered
spring steel

\$6.50 Doz.

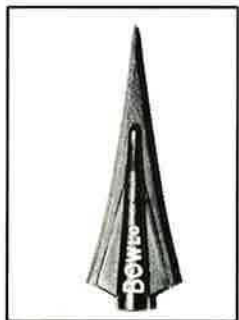

BOWLO Broadhead

Fits 5/16 and 11/32
shafts, 115 grains.

\$5.95 Doz.

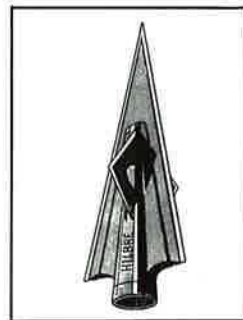

SUPER HILBRE

1 1/8" wide

\$6.95 Doz.

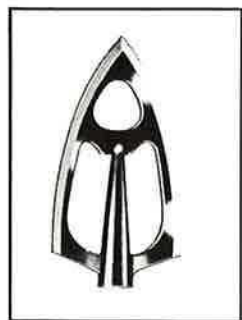

776 BROADHEAD

1 3/8 wide x 2 5/8.
Cutlery steel. Fits all
sizes. 130 grains.

\$7.00 Doz.

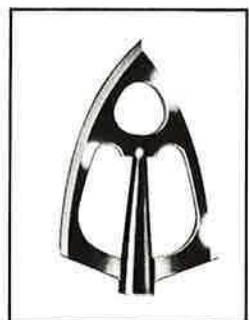

777 BROADHEAD

1 5/8 wide x 2 5/8.
Cutlery steel. Fits all
sizes. 150 grains.

\$7.00 Doz.

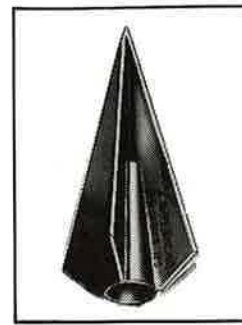

The 'SLICER'

125 grains

\$8.95 Doz.

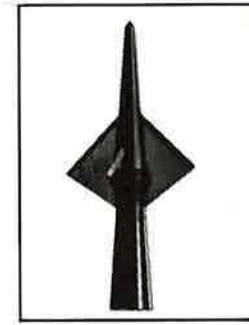

The SPIKE

Missle design. Elim-
inates all wind planing

\$8.95 Doz.



MARTIN #S-1
Adjustable FINGER SLING

\$1.95

EXPRESS

\$7.50 Doz.



BOW SADDLE

\$12.00 Doz.



**BLUDGEON
BLUNT**

Rubbery plastic head
Fits 5/16" or 11/32"

\$1.00 bag of 5

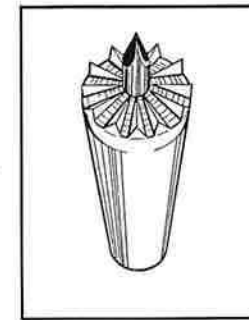

**MYCRO BLUNT
POINT**

2 sizes: 5/16" and
11/32" I.D.

\$2.00 Doz.

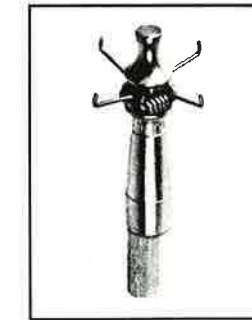

JUDO

Unloseable miracle
point. Deadly for small
game. 2 sizes: 5/16"
and 11/32".

\$2.25 Ea.



H T M BLUNT

H T M STANDARD —
125 grains; H T M JR.
SIZE — 65 grains

\$2.00 Doz.



SHOCKER

125 grains

\$4.00 Doz.

SNARO HEADS

- For birds and small game
- Eliminates near misses —
- You can't lose SNARO!
- Rugged all steel construction
- 5% ferrule
- High temper spring steel wire
- Delivers full impact force and knife-like action to any point of contact with least flight resistance

UPLANDER 6" for bird and game shooting \$2.00

GAMELANDER 3" for small game and brush shooting \$1.75



SNARO

"LITTLE SHAVER" AND THE SHARPEST EDGES EVER HONED

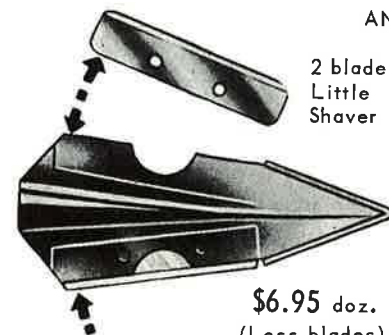

2 blade
Little
Shaver

\$6.95 doz.
(Less blades)

13/16" WIDE x 23/4" LONG
125 GRAINS WITH BLADES

- Precision engineered from the finest steel for solid deep penetration.
- Designed to increase the bow hunter's killing power.
- Economical — old injector blades used — always have a razor sharp cutting edge.
- Easy to insert — can be changed in the field.
- 5° taper — fits either 11/32" or 5/16" shaft.

3 blade
Little Shaver



\$8.95 doz.
(Less blades)

BROADI

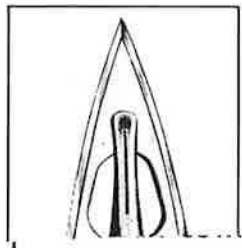

1 1/4" Black - Brown - White
#700 contoured. \$3.50

BEAR INSERTS



#444



#446



#445-S

#444 FIELDMASTER

For roving or target. Large enough to hold 12 arrows. Large tapered zipper pocket 8 x 4 1/2 x 1 3/4" for ample storage of accessories. Has divider loop to separate arrows. Pencil pocket. Right or left hand. \$15.75

#446 Roving or target

Flat style. Newly designed belt loop for better fit and style, plus new pencil pocket. Large zipper pocket 7 1/2 x 3 1/2 x 1 3/4", holds 6-8 arrows. Made of top grain cowhide leather. Colors: Black, Brown or White. Right or left hand. \$13.50

#445-S ROVER

Flat style hip quiver, split cowhide leather. Pocket with flap and heavy snap. Pocket size 6 1/2 taper to 4 1/2" deep, 3 1/2" wide, 3/4" high. Holds 6-8 arrows. Divider loop to separate arrows. Black only. Belt not included. \$8.75

#428 Large two division quiver. Top grain cowhide. 20 1/2" long. Will hold 24 arrows. Large zipper pocket & knife pocket on side. Black only. Right or left hand. \$27.50

#418 Same material and trim as No. 421. 18" long, for shorter arrows. Black only. Right or left hand. \$18.95

#489 Large shoulder quiver of tough, heavy gauge vinyl. Zipper pocket, moulded bottom. Holds 18 or more arrows. 19 1/2" long. Right or left hand. \$8.75



#428



#418



#489



#405



#409



#412



#483

#405 Selected top grain leather

Large pocket for score card. Two straps with belt clips. Divider strap for 2 division quiver. Easily holds 12 arrows. Right or Left hand. Colors: Brown - Black - White \$9.45

#408 Quiver

Same as No. 409 TARGET KING except 2" shorter and all white. \$15.50

#409 Target King

Selected top grain leather. Large zipper pocket 8 x 3 3/4 x 1 3/4". Two belt clips. Pencil pocket. Divider strap for 2 division. 20" long. Top opening 4 1/2 x 2", bottom 3 1/2 x 1 1/4". Black or Brown. Specify right or left hand. \$15.50

#412 Rangemaster

Designed to hold quiver at proper angle. Pencil pocket. Zipper pocket 8" by 4" by 1 3/4". Divider strap. Length 20", top opening 4" by 2", bottom 3 1/2" by 1 1/2". Easily holds 12 arrows. Color: Brown Specify right or left hand. \$18.95

#483 Target style quiver

Heavy weight expanded vinyl. Ring and belt clip. Divider strap for 2 divisions. Holds 12 arrows. Small flat accessory pocket. All trim and straps in grain leather. Black or white. 19" long. Specify right or left hand. \$6.25

#W-4 CUSTOM BOW-SLING

- Perfect balance with any shooting style
- Easy on and off bow hand
- No screw holes to deface bow
- Top grain cowhide — natural color
- Leather can successfully be dyed to suit taste
- Easily molded to bow contour — won't slip
- Complete instructions with each sling



\$2.50

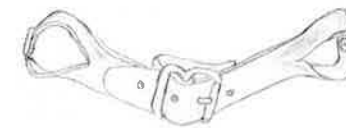

MARTIN #S-1
Adjustable FINGER SLING

\$1.95

MARTIN #S-2 ADJUSTABLE BOWSLING

FINEST QUALITY LEATHER
SELF ADHESIVE

\$1.25

Quantity
Prices Available



BOW SADDLE

\$1.00



MAX HAMILTON HAND LOCATOR

Your hand will automatically go to the same spot each shot with this two piece locator.

\$2.00



MARTIN #14

3 in 1 POWDER POUCH



Belt Clip, Pencil Holder, and Score Card Holder.

Colors: Brown, Black, White.

each . . . \$2.95



MARTIN #910 QUIVER

- Hunting or Target.
- Top Grain leather.
- Sheep skin lining.

\$19.95



MARTIN #903 BELT

\$5.75



MARTIN #902 CLIP ON ARM GUARD

\$6.95

#342 POWDER POUCH

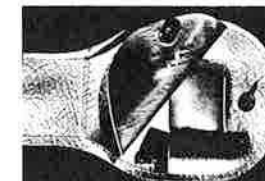

\$1.25

FINEST QUALITY Gloves



#226 Ladies All White Glove
Soft form fitting. Closed end tips. Top grain leather. Elastic back. Ladies sizes only. **\$3.35**



#227 Top Grain Cream Color Leather
Adjustable wrist strap. Elastic insert back. Soft form fitting closed end tips. Lets you feel the string. Men and ladies sizes. **\$3.35**



#225 Soft Llana Glove
Form fitting cream cowhide. One piece back Soft closed end tips. No breaking in. Men and ladies sizes. **\$2.65**

#210K Top Grain Leather Glove
One piece back. Open end style tips. Men and womens sizes. **\$2.25**



#316 Economy Leather Glove **\$1.50**

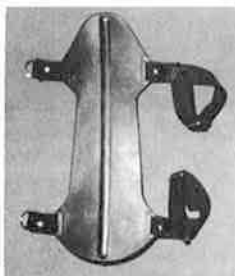

#302 Plastic Arm Guard
Ideal for school and camps
Color --- black.
\$.60

#300 Pouch
Top grain leather belt pouch. Zipper closed. Belt loop. Size 6½ x 4 x 2. Color: White or Black **\$6.95**



Gloves



#130 Arm Guard
Black or White

\$3.85



GLOVE SIZES

Men: Small, Medium, Large, Ex-Large
Ladies: Small, Medium, Large

-WOLVERINE "BULLSEYE" - New 3 Finger Glove

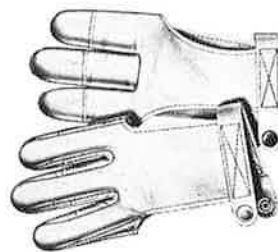

\$3.95 each

SMALL
With Velcro Fastener
MEDIUM
LARGE

- Made of genuine deerskin leather — for the ultimate in flexibility and long wear.
- Pull tape fastener to insure closeness of fit.
- Imported Persian grain goatskin tips for extra-wear and smooth jet-fast releases.
- The ultimate in hand-finger protection.
- Flexibility assures proper "feel" of the string — will not groove like hard cordovan tips.

**FOR RUSH ORDERS,
CALL
1-509 / 529-2554**

Guards

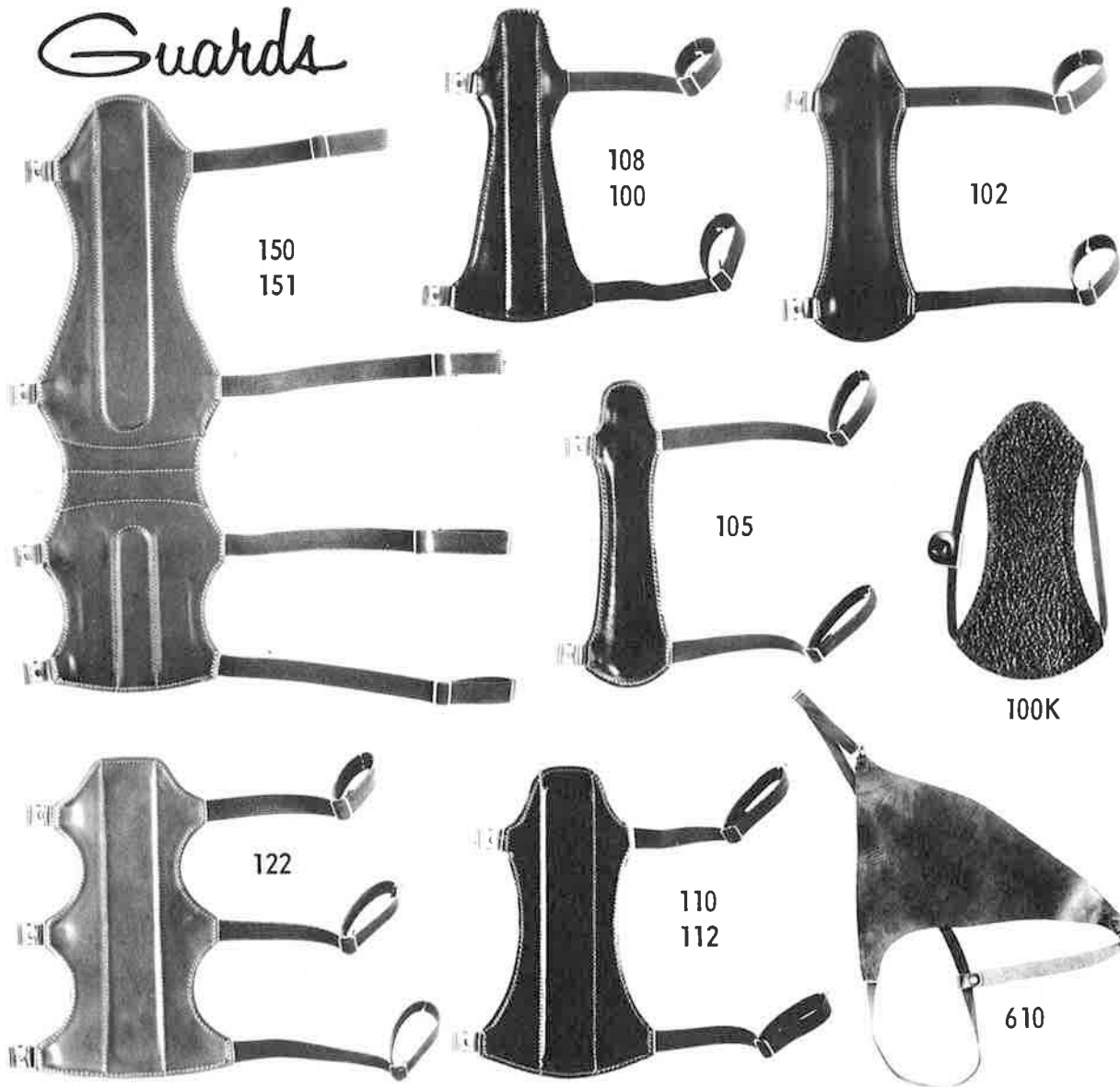

#150 For Hunting or Range
Full arm protection. Four adjustable elastic straps with metal fittings. Spring steel inserts at both ends flexible enough to bend at elbow. Leather lined. Material is tough vinyl covered cowhide. 13" long. Color: Black **\$4.85**

#151 Same as #150, only shorter
Same style and construction as 150 except 11 in. long. Color: White **\$4.25**

#122 Hunting Style extra wide
Three adjustable elastic straps. 1" steel insert. Leather lined. Material is tough vinyl covered cowhide. Colors: Black or Brown. **\$3.50**

#108 Regular Style
Two adjustable straps with metal fittings. Leather lined. Cowhide. Spring steel insert. Three colors: Black, Brown, or White. **\$2.25**

#100 Corfam Regular Style Guard
Two adjustable elastic straps with metal fittings. Spring steel insert. Leather lined. **\$2.65**

#105 Corfam Narrow Style Guard
Two adjustable elastic straps with metal fittings. Spring steel insert. Leather lined. **\$2.25**

#110 Very popular Wide Style Corfam
Two adjustable elastic straps with metal fittings. 1" spring steel insert. Leather lined. **\$3.25**

#112 Wide Style
Two adjustable elastic straps with metal fittings. 1" steel insert. Leather lined. Cowhide. Color: Black. **\$2.50**

#102 Semi Narrow Style
Vinyl covered material. Leather lined. Spring steel insert. Color: Black only **\$1.50**

#100K Inexpensive Style Guard
Cowhide material. Spring steel insert, Lined. Two elastic quick action loops with hook fastener. **\$1.00**

#610 Chest Guard
Top grain leather. Leather strap over shoulder fastened to adjustable elastic chest strap. Color: Black only. Large. Right or Left hand. **\$4.00**

KWIKEE-KWIVER

The lightweight bow quiver that snaps on and off in seconds. (6 pair to a display carton.)

\$3.95 pr



"SILENT SIX" Bow Quiver

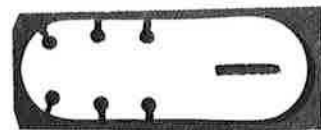

#1010 per set \$1.95

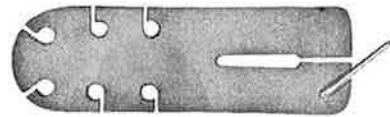

#1011 per set \$2.75

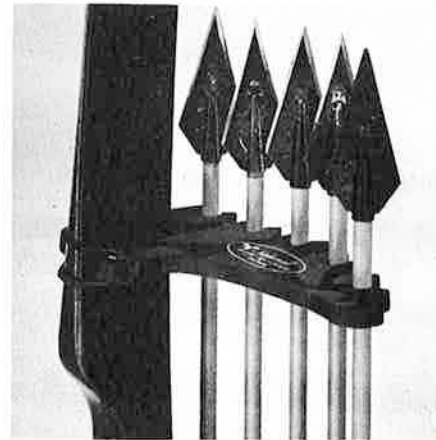

#414 "SNAP-ON" Bow Quiver
HOLDS 5 ARROWS

\$2.95 pr.

BQ-7 BOW QUIVER

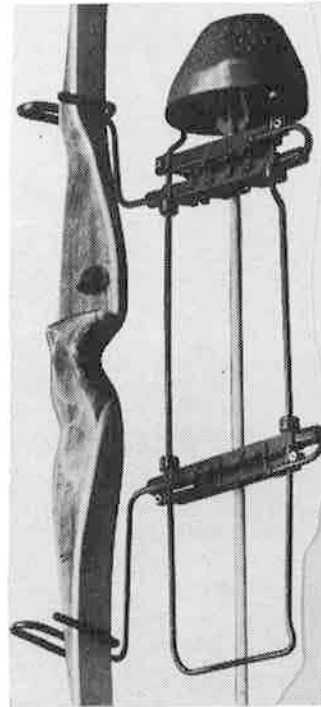

- Carries seven arrows
- Fits all hunting bows
- Torsion-grip holds securely in place
- Detaches instantly

No. BQ-7
Individually boxed bow quiver for right hand shooters \$12.95

No. BQ-7L
As described except for left hand shooters. \$12.95



\$14.95

3620 Tape-on Bow Quiver



\$14.95

3625 Bear 4-Arrow Screw-On Converta-Bow Quiver

BEAR BOW QUIVER



\$19.95

#3590
8-Arrow Bow Quiver made in three sizes.

#3590S
(short) fits most hunting bows from 52"-62". (specify right or left hand model.)

#3590R
(regular) fits bows from 60"-64". (specify right or left hand model.)

#3590L
(long) for hunting bows from 60"-66". (specify right or left hand model.)



#440

\$12.25

1 1/2" Wide
Matching Belt.
Blk., Brn., Wht.

#700, \$3.50

1. HOLDS MORE ARROWS
2. KEEPS ARROWS FREE OF BRUSH
3. ABSOLUTELY QUIET
4. STAYS OUT OF THE WAY
5. ARROWS INSTANTLY AVAILABLE
6. KEEPS BROADHEADS DEADLY SHARP
7. EXTREME LIGHT WEIGHT DESIGN
8. FULLY ADJUSTABLE
9. ULTRA FAST ARROW DRAW
10. STURDY LIFE TIME CONSTRUCTION



#442

#442 Quick Action hip quiver. Holds 6 arrows in moulded rubber clips. Made from rugged bonded vinyl.

\$8.50



matching
#700 Belt \$3.50 ea.

- 16 -



#100 QUIVER

Coated fabric model.

\$1.50

#492 HIP POCKET QUIVER



10"
Black Only

\$2.50

CATQUIVER



Kamo Cover
\$15.95

Holds 12 or more arrows, adjusts to all arrow lengths, is completely safe and affords easy access to arrows, is waterproof and light weight, has a wrapover pouch which holds extra tackle, and has adjustable straps for custom fit.

QWIFFER BOW QUIVER



\$9.95

- One model fits all bows — right or left hand
- Sturdy light weight construction
- Complete broadhead protection
- Attaches instantly without marring bow
- Sturdy arrow clip fits any size hunting arrow



\$1.50

7305 Bear Converta-Accessory Insert

KWIKEE KOVER



\$1.75 each

- Featherweight broadhead shield
- Moulded from tough, super-impact "Cyclo-lac" thermal setting plastic
- Attaches to spare arrow mounted in KwikEE-Kwiver by plastic coated non-mar spring clips
- Assures positive protection from exposed blades
- Also protects blades from dulling contact with any object
- Does not interfere with normal removal of arrows while hunting
- Stabilizer bar on stem prevents twisting on arrow

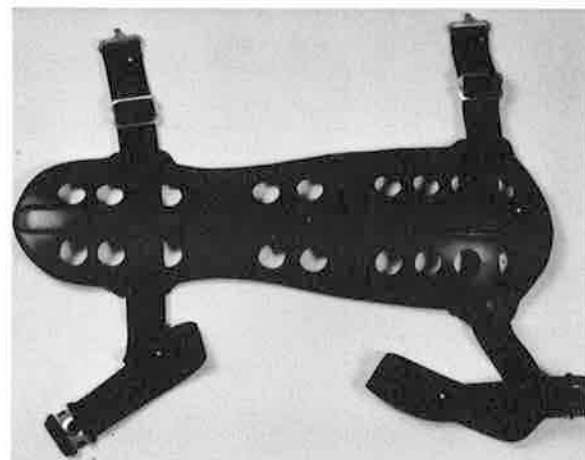

#111 ARM GUARD

Moulded of flexible plastic to a contoured shape that really fits your arm—no more frayed edges to deflect your string.

Black or white \$2.50

WRIST-ROCKETS



\$2.95

Wrist-Lok makes the difference

HUNTING SLING MODELS

Develop deadly accuracy in just a few tries!

Drop rabbits, rats and other vermin, small game, birds, with rifle precision. The finest slingshot on the market—hard-hitting, straight shooting, rubber-powered. Wrist-locking brace gives great steadiness, puts more thrust behind steel or plastic pellets. Fun for targets, an inexpensive and efficient weapon for rodent-eradication on farms, etc.

- WR-1—General purpose model—pulling weight 25 lbs. \$2.95
- WR-2—Hunter's model—pulling weight 35 lbs. 2.95
- 1RR—Standard rubber with pouch attached95
- 2RR—Extra heavy rubbers—standard pouch attached95

GROUND QUIVER (ALUMINUM)



Holds 12 Arrows
#56 each \$1.50



Knock down type— Holds bow and arrows.
#57 each \$3.25

CLASS _____ TOTAL _____

NAME _____

CLUB _____ DATE _____

	HITS	X	SCORE	HITS	X	SCORE
1			15			
2			16			
3			17			
4			18			
5			19			
6			20			
7			21			
8			22			
9			23			
10			24			
11			25			
12			26			
13			27			
14			28			
TOTAL 1st 14			TOTAL 2nd 14			
			1st 14			
GRAND TOTAL						

Field Score Cards
\$9.75/M

Cool Nylon Mesh CHEST PROTECTOR

Black or White
Left or Right
Small or Large

\$6.95



FOR RUSH ORDERS,
CALL

1-509/529-2554



#64 PRO REST

Non-interfering rest with pressure plate provides for positive clearance of vanes or feathers. Retaining finger prevents arrow from falling off rest. Flexible shelf prevents arrow bounce. Self-adhesive backing. Specify right or left-handed. \$1.00



#88 FLEX-REST

-Interference free arrow shelf of special "spring" plastic.
-Ideal for either feathers or plastic vanes.
-No tools or cement needed.
-Self-mounting posi-stik adhesive for secure and positive attachment. 50¢



#66 MARTIN VERTICAL FEATHER REST

Self adhesive and polyfoam base 50¢



#74 ADJUST-A REST

Flexible plastic. Self adhesive. Adjusting side screw. \$1.25

MARK III PARA-REST

Self adhesive. 12 per card. \$1.00 Ea.



#70 HORIZONTAL FEATHER REST 75¢



#98 MARTIN HAIR PLATE

Very slick and smooth and dampens arrow noise as it leaves the bow. Very good for hunting bows. Self adhesive. 50¢

FOR RUSH ORDERS, CALL

1-509/529-2554



#74 ALL-WEATHER REST

One-piece plastic—completely weatherproof.

12 per display card 75¢ Ea.



#49 HAIR ARROW REST

Ideal for hunting. Thick hair aids in smooth, quiet, quick draws and releases. Self-stick adhesive back. 50¢ Ea.

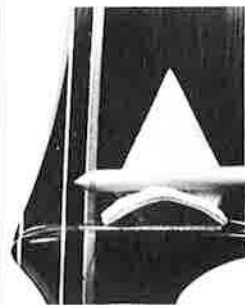

#48 WHISPER ARROW REST

-Covered with calfskin hair
-Speeds up arrow flight
-Easy to attach
-Unaffected by rain or snow \$2.00



#30 PARA REST

Nylon brush with durable plastic 75¢

#38 CUSHION PLUNGER

Acts like a shock absorber. May be used with plastic vanes and releases. Comes with installation instructions.

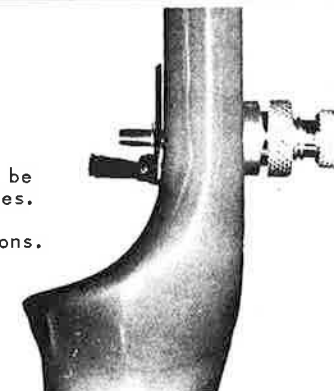

\$11.95

MARTIN TABS



#202 Martin Tab

Single thickness top grain cowhide.

\$.40

#204 Martin Tab

Double thickness, Corfam facing.

\$1.50

#206 Martin Hair Face Tab

Small, Medium, and Large. Specify right or left hand.

\$1.50

BJORN TABS



HAIR FACE

\$3.95 ea.

Small
Med.
Large
EX-Large

Right or
Left hand

MARTIN GLOVE POWDER



Friction free powder. A must for fast accurate shooting.

75¢



WILSON TAB

Sizes: Small, Medium, Large. Right or left hand

\$2.00



KANTPINCH TAB

has proven to be the answer to better shooting. Used by thousands of bow hunters, field shooters and target archers the world over.

(KP100) Cordovan — Leather backing

\$2.00



KANTPINCH SNAP-ON TAB

is identical to the NAM SNAP-ON with the addition of the famous patented finger separator. All the advantages of the NAM with the additional advantages of the KANTPINCH.

(KP300) Kantpinch Snap-on H.C. Facing
(KPREP) Hair Calf Replacement Facing

\$2.50
\$1.00



NAM SNAP-ON TAB

Here is a revolutionary new idea in tab design. The Hair Calf facing snaps on the backing with 3 tiny glove snaps.

The new Snap-On tab eliminates the problem of hair calf facing wearing rapidly. Replacement is only a matter of snapping on a new face. The tab is already broken in and shooting continues without the period of break-in usually required.

(NAM300) NAM Snap-on H.C. Facing
(NAMREP) Hair Calf Replacement Facing

\$1.75
\$1.00

ALL NATIONAL TABS ARE MADE IN SMALL — MEDIUM — LARGE, RIGHT OR LEFT HAND. SPECIFY WHEN ORDERING.

RELEASES



MODEL V

The Model V is designed to be used in a method similar to the conventional style of shooting. It is held in a vertical position with the hook between the index and second finger.

\$4.95



MODEL S

Easiest of all release aids to operate, the Model S offers maximum accuracy with its simple operation. It is designed to be held in a horizontal position with the hook between the second and third finger.

\$4.95



MODEL HV

The Model HV is designed to be used in either a vertical or horizontal position. In the vertical position, the release is held with the hook between the second and third fingers. The bow is drawn by pulling with the index and second finger.

\$5.95

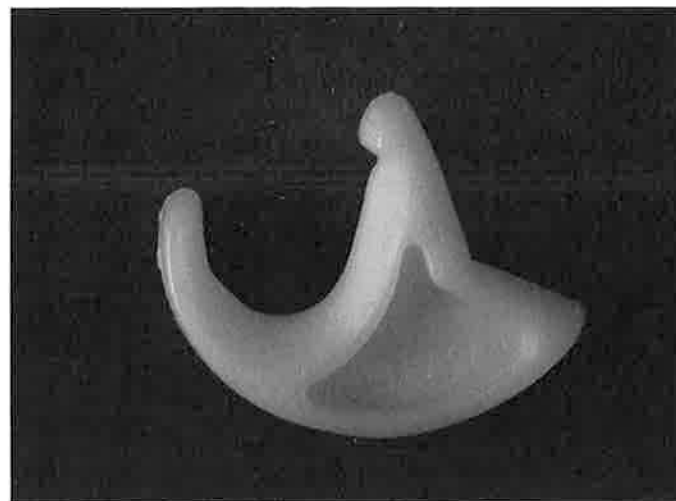

"THE RELEASE"

#BB50

Fast enough for even the most capable archers with no modifications. Designed for the professional. Safe and simple.

\$2.50

BUSHNELL EXPO BINOCULAR



POWERFUL - Full 8 X 30 power
Field of view: 394 ft. at 1000 yds.

SHOCKPROOF - Eyecups and sunshades made of shockproof rubber.

WATERPROOF - It floats

With Snap-On Lens Cover

Weight only 12 ounces

\$29.95



**REYNOLDS
DOUBLE ADJUSTMENT
BOW SIGHT**

- Center slide adapted for any 8/32 screw thread prism. 2 wire prong prisms can be used without an additional prism adapter.
- A second adjustment which enables the archer to get back on target, after a broken bow cord or a change to a different weight arrow, without disturbing the original calibration
- This sight is free from vibration, for the fact it is firmly mounted in the solid part of the grip
- The sight body is removable when not in use; such as hunting or instinctive shooting.

\$8.75

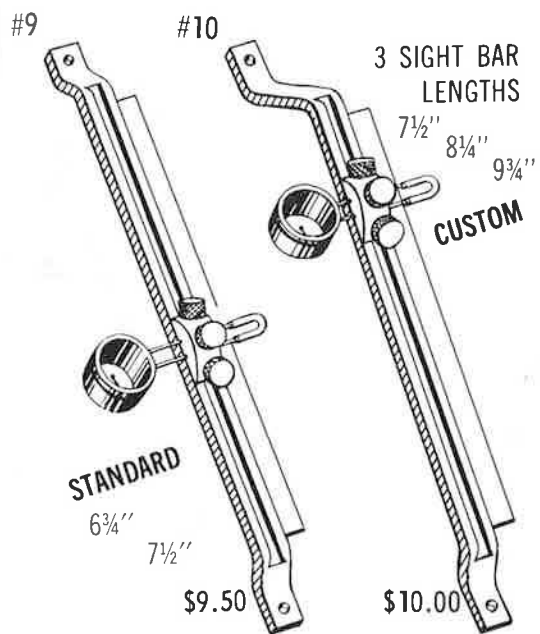

STANDARD

6 3/4" 7 1/2"

\$9.50

\$10.00

3 SIGHT BAR LENGTHS

7 1/2" 8 1/4" 9 3/4"

CUSTOM

#1001 MICROME

Hunting Site

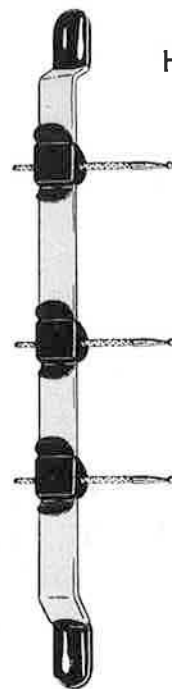

complete with 3 fully adjustable bead posts, black, copper, and cadmium. Set the posts at your choice of distance.

each \$2.95

**#33-M VEE
BOW SITE**

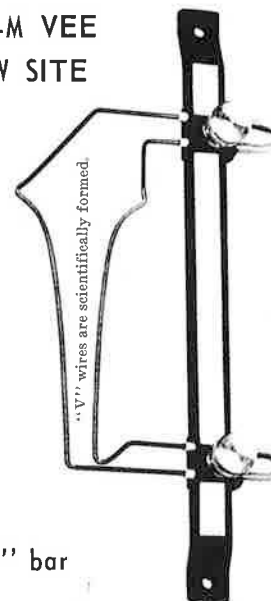

7" bar

All metal with sight wire colored bright orange.

Has 2 adjusting screens

\$5.55

#512 HUNTING SIGHT

ALL METAL

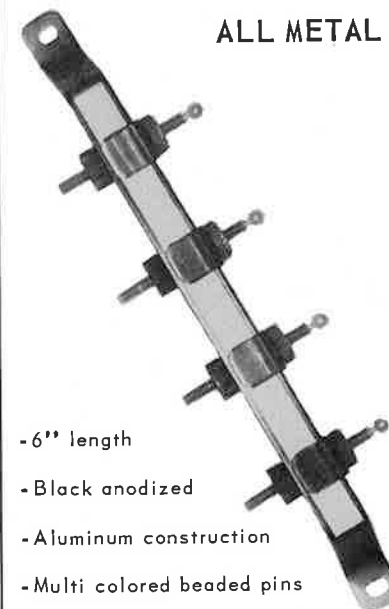

-6" length

-Black anodized

-Aluminum construction

-Multi colored beaded pins

\$4.95

MARTIN #505 BOW SIGHT

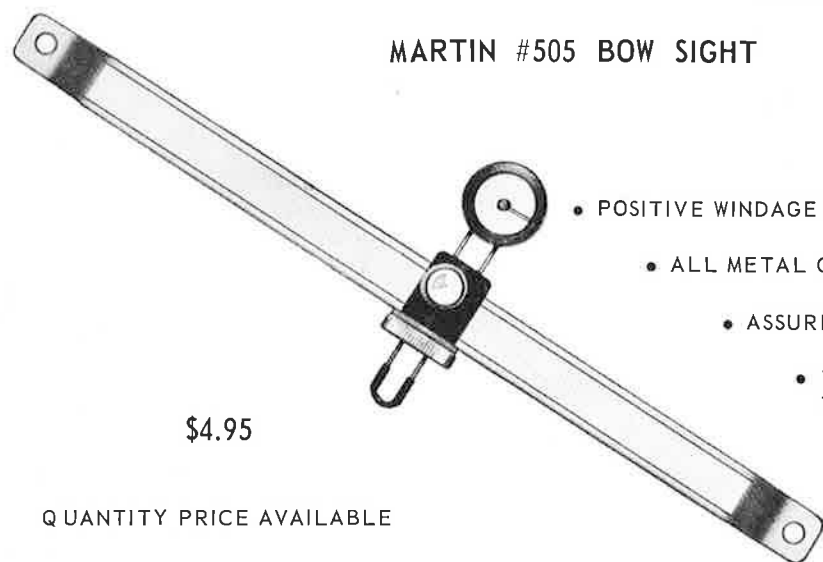

• POSITIVE WINDAGE AND ELEVATION LOCKS.

• ALL METAL CONSTRUCTION.

• ASSURED ACCURACY.

• TWO SIZES:
7 1/8" and 6" lengths.

\$4.95

QTY PRICE AVAILABLE

**#510 HEART SHOT
HUNTING SIGHT**

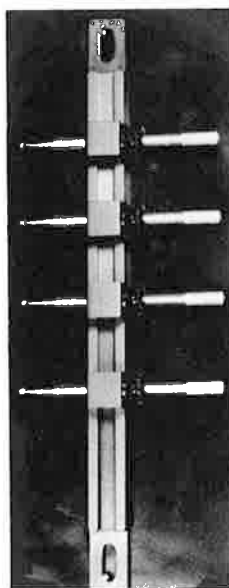

Bar Lengths

4"

5 1/2"

7 1/2"

All Metal

Easy Adjustment

\$6.50

**#511 RAIN-BOW
HUNTING SIGHT and
RANGE FINDER**

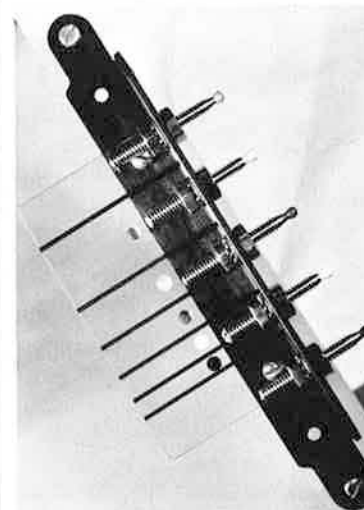

Preset the color-coded pins for five distances. Makes sighting in the field instant and sure.

\$9.95

MATCH 300

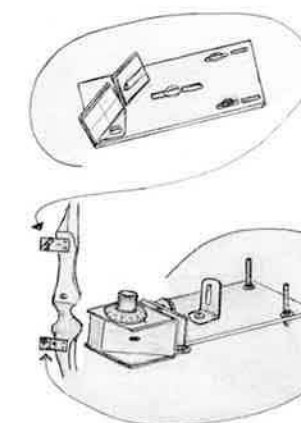

The MATCH 300 lets you reach yardage formerly attained only by using a prism.

\$49.95

#124 MICRO SIGHT

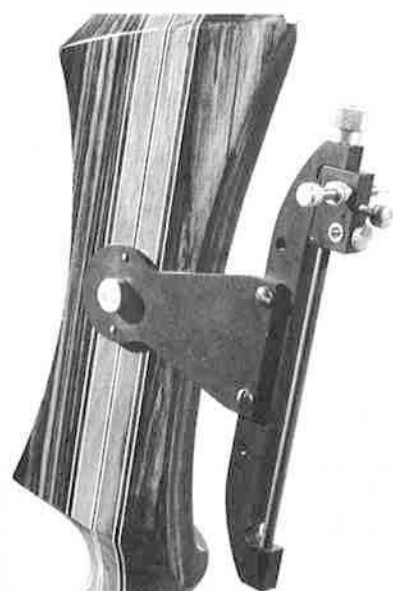

- o Capable of an infinite number of accurate micrometer adjustments for both windage and elevation.
- o All prisms, levels and wire mounted apertures can be accommodated without modification of the basic design.
- o Easily attached to any bow with or without routing.

\$25.00

D-J CUSTOM BOWSIGHT

WITHOUT YARDAGE CORRECTOR..... \$8.95

WITH YARDAGE CORRECTOR (AS PICTURED)..... \$10.20

D-J WINDAGE ADJUSTOR..... \$2.00



#344 SIGHT ATTACHMENT BRACKET



- Copper patch with pressure-sensitive back grips bow firmly without screws
- Bracket can be bent to fit contour of any bow
- Patches are easily placed to accommodate your sight base

\$1.50

#846 SIGHT MOUNT



- Makes use of tape unnecessary
- Eliminates ugly screw holes
- Removal of sight bar — quick — easy — exact replacement possible
- Precision machined
- Simple to install — complete installation instructions and diagrams

\$2.00 Set

SIGHT APERTURES

SIGHT APERTURES WITH LEVELS

- G - Small Crosshair.....\$2.75
- F - Large Crosshair..... 2.75
- H - 1/16" Peep..... 2.75
- J - 1/8" Peep..... 2.75
- K - 3/16" Peep..... 2.75
- S - Cross with Ring..... 3.00
- PD - Small Pin Down... 3.00
- R - Plain Ring..... 3.00
- XX - Centerless Crosshair 3.00

SIGHT APERTURES WITHOUT LEVELS

- B - Large Crosshair ... \$1.75
- C - 1/16" Peep..... 1.75
- D - 1/8" Peep..... 1.75
- E - 3/16" Peep..... 1.75
- IU - Large Pin Up..... 2.00
- ID - Large Pin Down... 2.00
- OU - Small Pin Up..... 2.00
- OD - Small Pin Down... 2.00

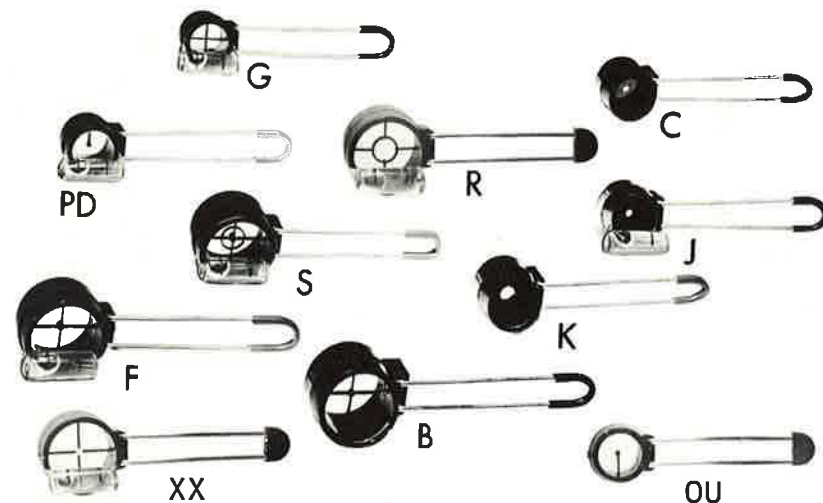

THE X-ACTA



Splitting holder grips tight — your level setting will not change or slip!! To release grip — insert coin in split!

\$4.95

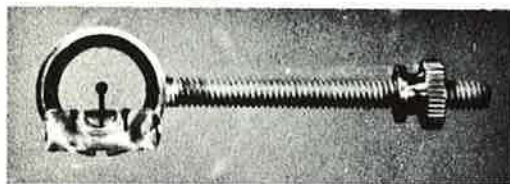

EXTRA SIGHTS for X-ACTA

\$2.50 each

B-1

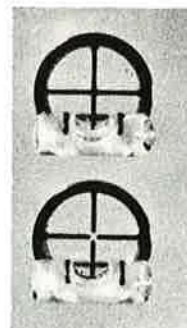

B-2

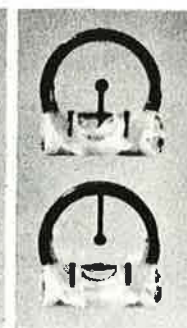

B-4



B-3

Post dots are FLUORESCENT red-orange.

VICTOR PRISM

Victor Prism comes in 0°, 2°, 4°, 8°, 12°, with or without hood.

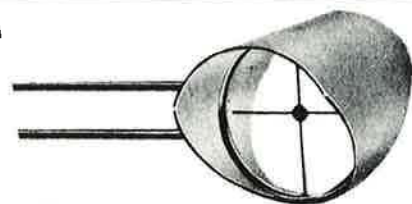

Hooded \$7.50 ea.

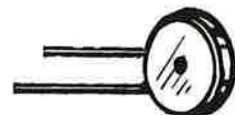

Without Hood \$6.95 ea.

EXTRA WIRE . . . 50¢



Wires have notches for windage reference.

EXTRA HEADS FOR MERRILL SIGHTS

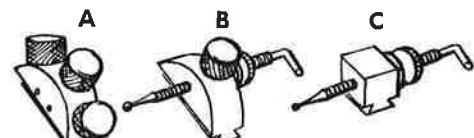

\$3.50

\$3.00

\$1.50

#303 PEEP SIGHTS



\$1.00 ea.

"LITTLE BEAUT"

\$1.00



PIN DOT HOODED SIGHT RINGS

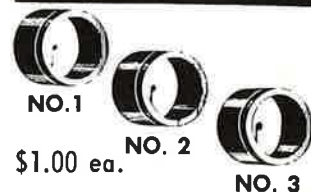

\$1.00 ea.

NO. 2

NO. 3

STRING SIGHTS



THE SAFE ONE!
GUARANTEED UNBREAKABLE
hard nylon

YOU'LL CONCENTRATE BETTER
WITH A RESTRICTED VIEW!



#263 "KISSER" BUTTON

50¢ each

Doz. on card

#264 EASY-ON KISSER

- No more serving
- Positive positioning
- Weights 5 grains — as much as an aspirin
- Improves accuracy!
- Guaranteed not to break

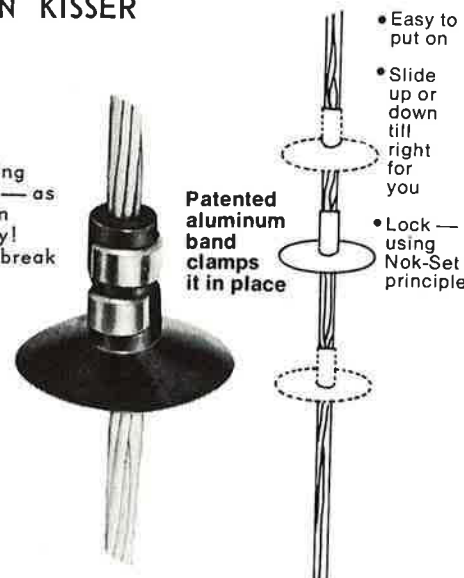

only 75¢

#6 FLETCH SITE



75c each

#8 PERFECT PEEP SITE



\$1.00

DIRECTIONS

- (1) Place PEEP SITE in halved bow string.
- (2) String bow and adjust PEEP SITE for full view of bow window and serve.

#9 STRING PEEP SIGHT

- No more serving
- Positive positioning
- Allows maximum vision right and left
- Weights 8 grains (an aspirin weighs 5 grains)
- Exclusive ribbed design minimizes sun reflection
- Patented aluminum band clamps peep in place

only \$1.49



#265 KISSER BUTTON

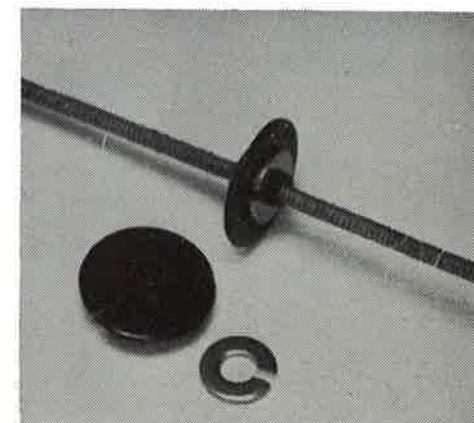

With snap clip to hold button in place on string

85¢

REYNOLDS SIGHT PARTS

MOUNTING WASHER RS-8	MOUNTING SCREW RS-9	DELIRIN SLIDE RS-3	BASE RS-49	BASE SCREW RS-29	BASE SCREW RS-29
LOCK SCREW RS-5	LOCK NUTS RS-6			BASE SCREW RS-11	SIGHT SCREW RS-7
PRISM SCREW RS-2	SPRING RS-4				

Key to Parts Tray

RS- 1	Body	-----	\$2.00
RS- 6	Lock Nut	-----	.20
RS- 2	Prism Screw	-----	.35
RS- 9	Mounting Screws	-----	.15
RS- 3	Slide Body	-----	2.50
RS- 4	Spring	-----	.35
RS- 7	Sight Screw	-----	.60
RS- 5	Lock Screw	-----	.40
RS-49	Base	-----	2.75
RS- 8	Washers	-----	.15
RS-11	Base Screw	-----	.80
RS-29	Base Screw	-----	.80
	Sight Tape 1/2" x 120"	-----	.70

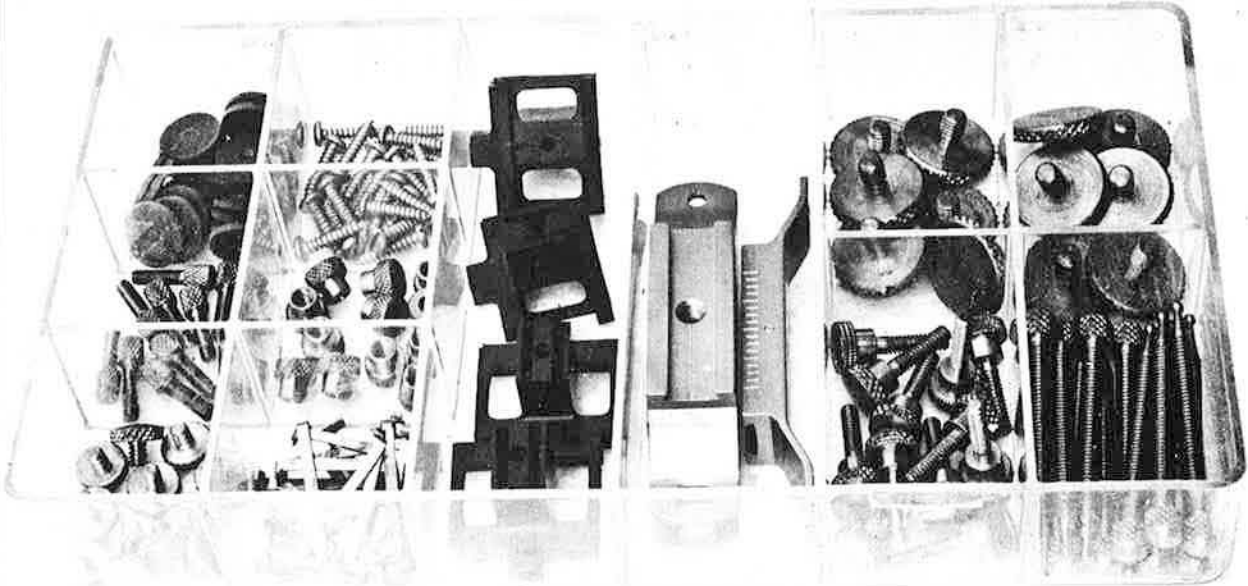

#510 MARTIN ADJUSTABLE LENGTH SIGHT EXTENSION

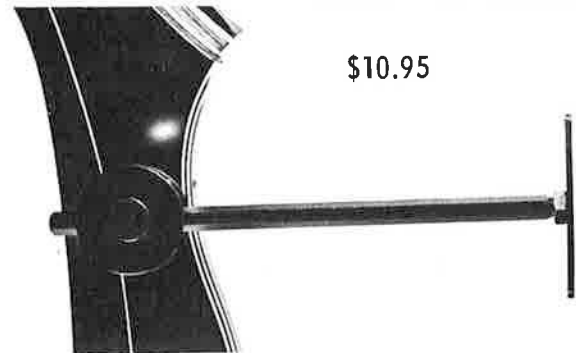

\$10.95

#530 Reynolds Adjustable SIGHT EXTENSION

\$7.95

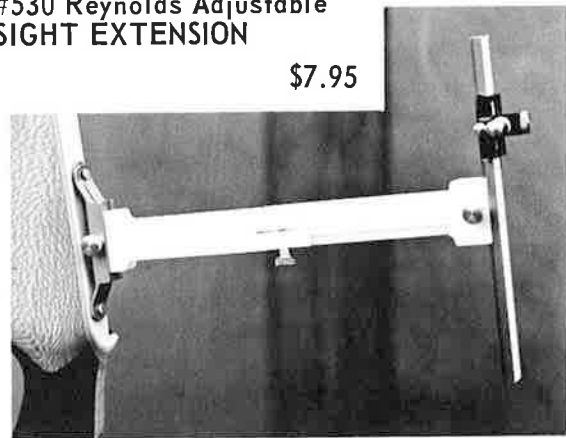

SCOPE SIGHT

- SPECIALLY GROUND GLASS OPHTHALMIC LENS ENLARGES AND SHARPENS SIGHT PICTURE!
- IDEAL FOR INDOOR OR OUTDOOR SHOOTING
- INSTALLS INSTANTLY ON MOST SIGHT BLOCKS
- IMPROVES YOUR SCORES!

\$19.95

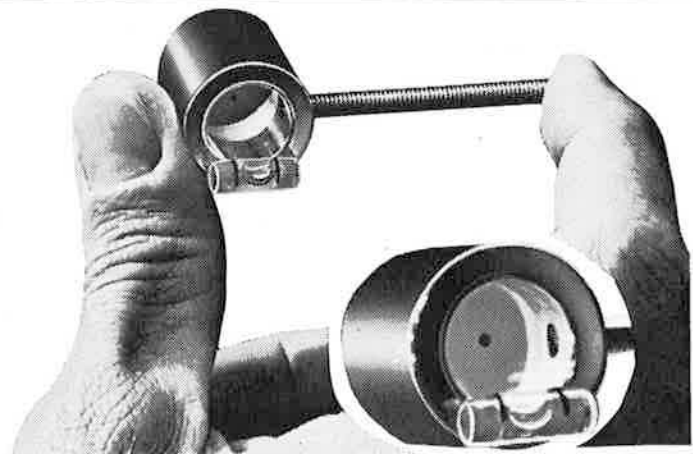

MARTIN CUSTOM BOWSTRING

We make these from the finest material available — Type B Dacron and served with soft twisted Nylon

STRANDS USED

- Up to 25 lb.-- 8 strands
- 25 to 35 lb.- 10 strands
- 35 to 45 lb.- 12 strands
- 45 to 55 lb.- 14 strands
- 55 to 65 lb.- 16 strands

Made in AMO bow lengths 44" to 72"



PACKED IN PLASTIC HANG-UP TUBE
List \$1.50 each



"NEW" DISPLAY RACK
HANGS ON PEG BOARD
HOLDS 96 BOWSTRINGS

MARTIN PRO BOWSTRING

All black bowstring with monofilament center serving. \$2.00

Cross-Bow String. \$2.00

MARTIN #305

Braided Double Loop Bowstring
BRAIDED bowstring with center serving for bows to 40 lbs. Available for the following length bows: 48, 50, 52, 54, 56, 58, & 60".
\$.95

Extra soft twist nylon SERVING THREAD



- RED
- GREEN
- YELLOW
- BLUE
- WHITE
- BLACK

100 yd.
.85 ea.

Serving Jig Spool

NYLON MONOFILAMENT SERVING



Orange or clear

.85 ea.

MARTIN SINGLE LOOP BOWSTRING

Made from 400 lb. Braided Dacron
PACKED 12 ON DISPLAY CARD



To use single loop strings, make timber hitch knot as shown. Secure with tape or rubber band.

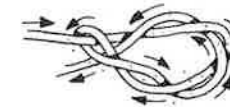

With center serving..... \$.75
Without center serving..... \$.50

DACRON "B" BOWSTRING FIBRE PRE-WAXED BONDED



- 4 oz. spool White . . \$2.50
 - 4 oz. spool White Super "B" 43 . 3.00
 - 4 oz. spool Colors . . 3.00
 - Thread Colors: Black, Yellow, and Green.
 - 1 lb. spool White . . 9.50
 - 1 lb. spool Colors 10.50
 - Colors: Black, Yellow, and Green
- (Quantity prices available)

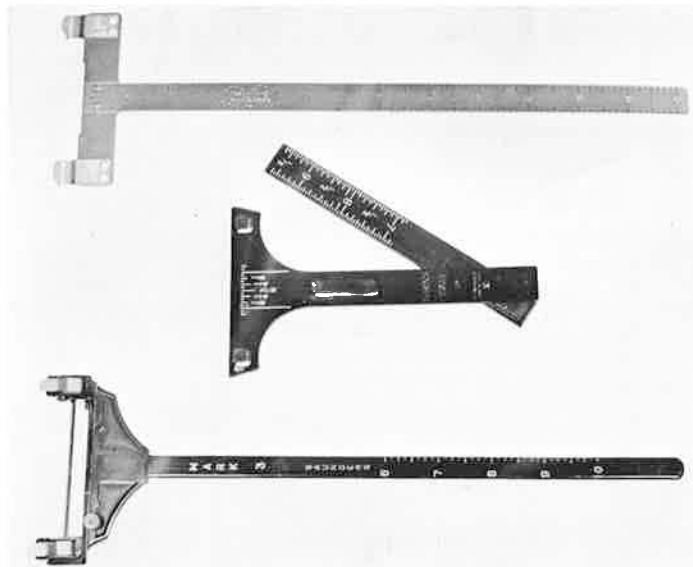

A — POTAWATOMI BOWSQUARE
New - 12" long **\$3.50**

B — FOLDING STRING GAUGE
\$2.50

C — MARK 3 BOW SQUARE
12" long. Light weight aluminum.
\$3.50

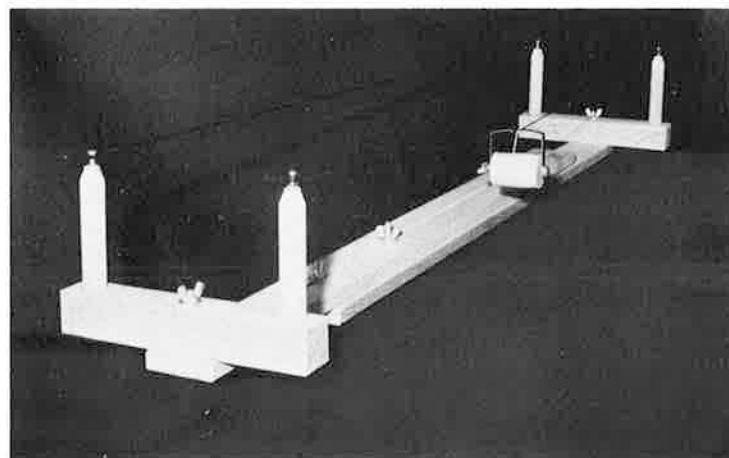

MARTIN BOW STRING JIG

- Precision built tool of select material
- Quick positive adjustment for all length bow strings
- Careful and rugged construction
- Metal fittings on end posts
- Pivoting end posts automatically spread string for ease in serving
- Designed for the professional or amateur
- With excellent step by step illustrated instructions

\$7.95

QUANTITY PRICES AVAILABLE

MINK OIL
Waterproofer and Leather Conditioner



The original patented waterproofer for
Shoes
Gloves
Jackets
Coats
Belts
Upholstery
Luggage

3 oz. \$1.00

MARTIN SILICONE WATER REPELLENT



Easy to use
Many uses
Feathers
Clothing
Boots

\$1.25

Make a Professional Serving
#7 MARTIN "SPEED-SPIN"
Fast — Perfect Servings

- No bobbin to wind
- Holds full spool of thread
- No slow hand turning
- Directions
- Spins a perfect serving in less than one minute

Colors: Red, Green, Yellow, Blue, White, and Black.



Server complete with nylon thread. . . \$2.00

CRESTING LACQUER

Colors: Gold or Silver
\$1.00 ea.

Colors: Black, Red, Blue, White, Yellow, Green, Orange.

.75¢ ea.



DIP LACQUER
colors custom mixed

COLORS READY MIXED

Camo green,
Lt. blue,
Red,
Orange,
Yellow,
White,
Black



\$2.50 qt.
Net price

Available in larger quantities

LACQUER THINNER
Net price \$.75 qt.

Striping Brush

\$1.50

¼" Brush

\$1.50

½" Brush

\$2.75

DELTA CRESTING BRUSHES



#544 BOW STRINGER

— MAKES A TRICKY JOB EASY —

- Soft vinyl saddle adjusts for different bow limbs.
- Simple to use.
- SAFE — no danger of sweaty hands slipping off bow tip.
- Complete with instructions.
- Prevents bow limbs being twisted due to improper stringing.
- Handy — fits into pocket.

\$2.45

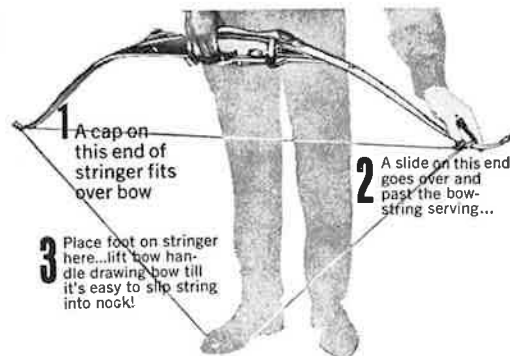

#545 Bow Pal BOWSTRINGER

Fits easily in your pocket.

each . . . **\$2.75**

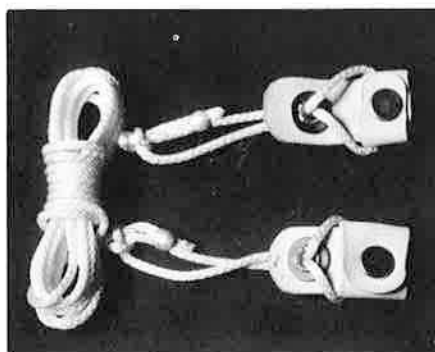

#546 DEI Telescopic Bowstringer



ELIMINATES TWISTED BOW LIMBS!
PROVEN SAFE - DEPENDABLE!
QUICKLY ADAPTS TO ANY SIZE BOW, AND ANY WEIGHT!
COMPACT - FITS IN YOUR TACKLE BOX!
INTERNATIONAL INVENTORS EXPO. GOLD MEDAL WINNER!
PACKAGED IN INDIVIDUAL DISPLAY CARTON WITH FULL INSTRUCTIONS!
FLEXIBLE SOCKET - WILL NOT MAR BOW OR FINISH!

\$9.95

NOK-SET -Positive Nocking Point-

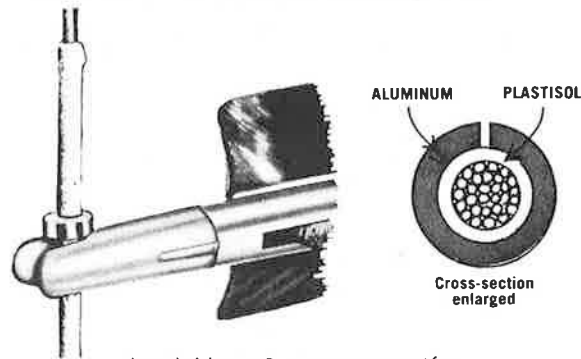

Available in 2 sizes - specify:
 T-TARGET (8-10-12 Strand Strings)
 H-HUNTING (12-13-16 Strand Strings)

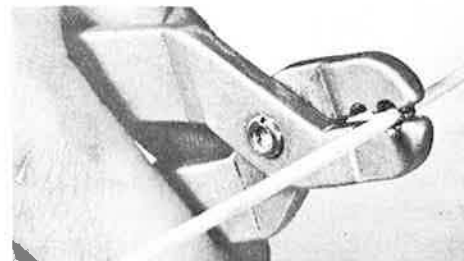

Pliers only \$1.50
 Nok-Sets pack of 5..... \$1.00
 (Carded 12 per card)
 Bulk 25 \$4.50
 50 \$8.50
 Box of 100 Nok-Sets \$15.00

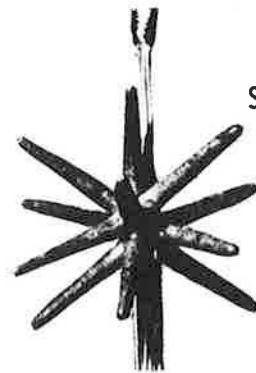

"MITY QUIET" STRING SILENCERS

Packaged
 12 pr.
 per card.

Prevent your bowstring from "spooking" game. Twin rubber "burrs" wind into bowstring at either end. Quiets bowstring "twang" to a whisper.

1 pair \$1.00

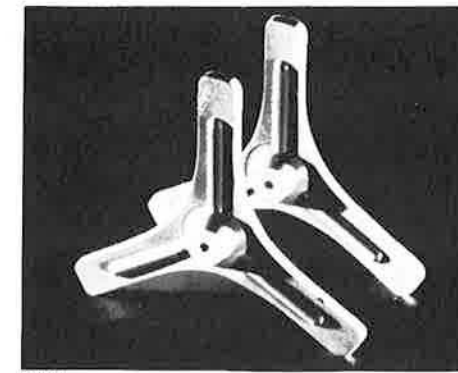

KWIKEE-SILENCER

Eliminate bow string noise. A must for the hunter. (12 pair on a display card.)

\$1.00 pr.

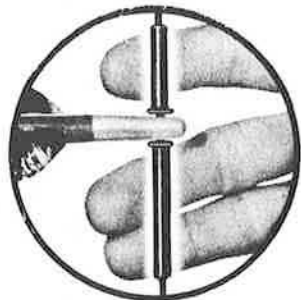

#64 NOCK RITE

Positions arrow immediately. Aids accurate shooting by preventing slippage of arrow on string. Balanced three-finger action assures smooth arrow release. No other finger protection necessary.

\$1.00

#861 HEAT NOCK NOCKING POINTS

Heat shrinks onto string. Gives an instant nocking point.



Packed 4 per pkg.
 50¢ pkg.
 One doz. pkgs.
 mounted on card

BULK \$4.50 per hundred net
 \$25.00 per thousand net

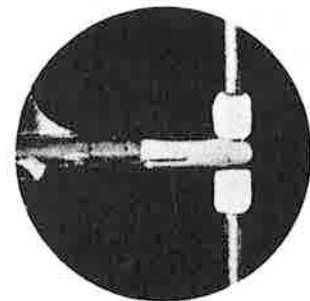

#218 NOCK LOCKS

Easily installed to give increased accuracy. Arrow can be instantly nocked and will stay nocked.

List Price \$.50

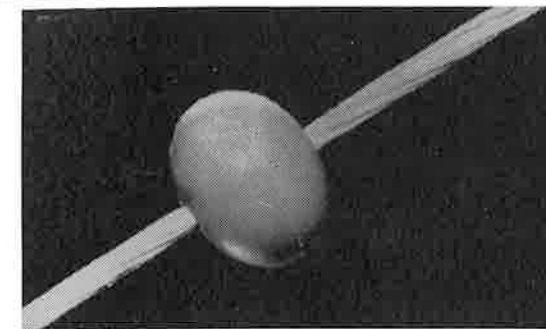

KILBEAD BOWSTRING SILENCER \$.75 pr.

#93 STRING SILENCER

12 per display card



Installed
 in
 seconds

\$.39 pr.

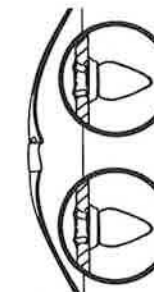

"MINI-HUSH" BOWSTRING SILENCER

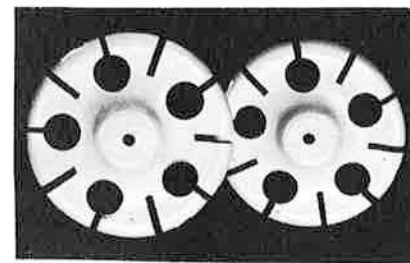

Patented design gives perfect silencing through combination internal siphon and anvil effect. Packed one dozen in plastic bags on counter display card.

\$1.00 pr.

BRUSH BUTTONS

Brush-proofs your bow and quiets the string noise. Made of soft rubber, easily attached and does not interfere with bracing or shooting.

Regular ... pr \$.60
 Super pr \$.70

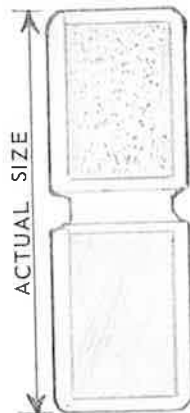

MARTIN Velcro String Keeper

SELF-ADHESIVE

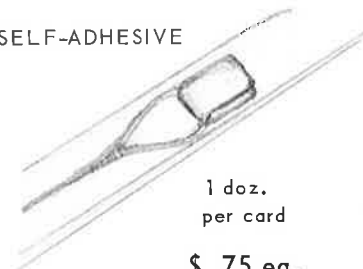

1 doz.
 per card

\$.75 ea.

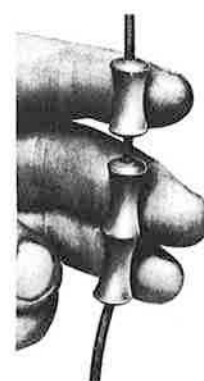

NO GLOV

Molded rubber, contoured for perfect finger fit. Eliminate need for glove or tab. Provide fast, accurate shooting no matter the weather. Positive nocking point. (12 on display card.)

\$1.00

#660 BOW-TIP PROTECTOR

Keeps bow tip in new original condition. No scuffing of bow tip while bracing bow. Made of soft pliable rubber.

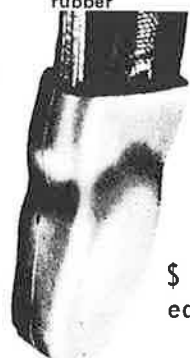

\$.50 each

#661 BOW TIP PROTECTOR

Holds bow string in place while stringing! Hole allows normal action of string!

DOES NOT AFFECT BOW ACTION!
 EASY TO ATTACH

Bow Tip Protector is a neat solution to the problems of damaged bow tips. Rugged plastic, it is not damaged by sunlight, heat, cold or oils.

\$.75

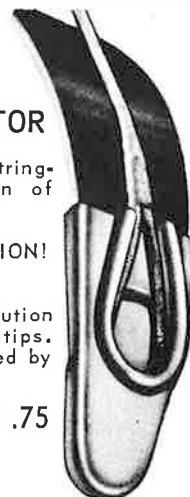

BOW BIRD

Bow Bird is a 3-dimensional target of tough cardboard approximately 15" in diameter. It is thrown into the air with a spinning motion. Shot with flu-flu type arrows on any baseball-diamond-size area. It's great practice for all moving targets.

3 for \$2.00



#BL-1 ADJUST-A-LEVEL

Eliminates accidental canting. Self-adhesive, no holes to drill. Fits any place on bow.

\$1.50



#BL-2 BOW LEVEL 85¢

**FOR RUSH ORDERS,
 CALL
 1-509 / 529-2554**

502 KWIK-LOK ARROW READY

- Holds your arrow in the bow...
- Releases instantly when you draw!

Individually carded.....only \$2.00

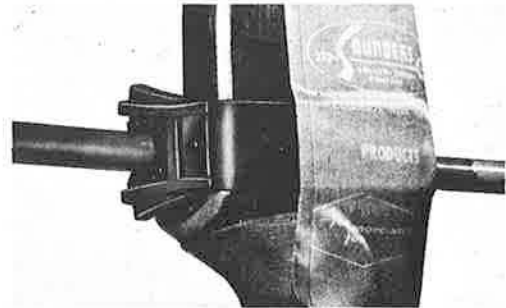

#504 STA-JAC ARROW CINCH

Field tested in all kinds of weather, summer and winter.

- Holds Fast
- Releases easily

One doz. on Card

\$2.25 ea.

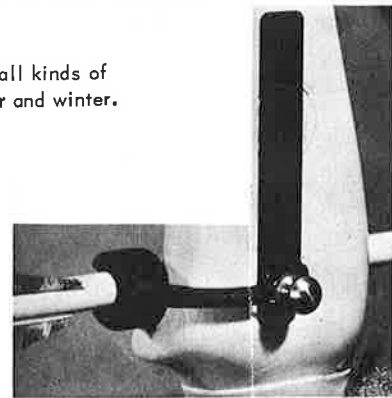

#506 NELSON ARROW HOLDER

Constructed of high grade spring steel and rubber, the Nelson Arrow Holder fastens to any bow handle. Snaps in and out of the Jiffy Clip which is taped or screwed to the bow handle.

\$2.00



JIFFY CLIP

Jiffy Clip for easy removal (optional)



\$1.00

MAGNA KLICK

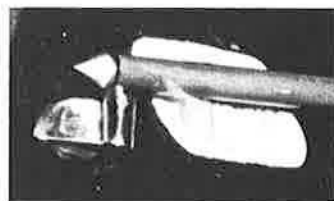

\$4.95

- Legal draw check/clicker
- For bare bow or free style
- Also a broadhead draw check
- An arrow positioning device located 1/8" below the arrow and just in front of the arrow rest
- Can be used as a draw check or a clicker-type trigger
- A magnet is used to "feel" and "hear" when the arrow is at exactly full draw
- Fits both right and left hand bows by just turning around
- Can also be mounted on face of the handle and used with most broadheads
- With illustrated simple installation directions

HOYT KLICKER
\$1.25



DRAW FLAG



BRIGHT Fluorescent Orange Tip!

Self-adhesive

70¢ each

BOW MATE CLICKER

This new clicker signals the archer audibly when his arrow reaches full draw.

\$1.50 each

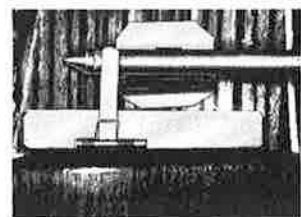

Clicker rests on arrow as arrow is being drawn

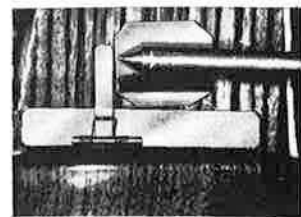

When arrow reaches full draw position, Clicker is released, snaps against bow.



Varmint Callers
OFFICIAL CALLS of the ARIZONA VARMINT CALLERS ASSOCIATION



45 RPM RECORD

World's Champion, Bill Dudley, and Arizona State Field Champion, Del Western, demonstrate their winning techniques and explain how to most effectively use the CIRCE calls for successful hunting. A full 11 minutes of instruction by champions.

Model R-1 \$2.00

JACKRABBIT Model P-1 \$3.00

P-1 Jackrabbit Model Call — Extreme Long Range

COTTONTAIL Model P-2 \$3.00

P-2 Cottontail Model Call — Long Range

HAWK Model H-1 \$3.00

CIRCE VOICE KIT (pkg. of 4) - - - \$2.00



PROFESSIONAL MVP-4 \$5.00

MVP-4 Professional Model Call
Three calls in one. Comes with one P-1 jackrabbit, one P-2 cottontail and one P-3 coxer voice. Completely self contained and changes from voice to voice in a second.



TROPHY CALL P-5 \$4.00

The Trophy Predator Call has been added to the CIRCE line of varmint calls. It is one full inch longer than the other calls and produces better tonal qualities. It has proven superior to all other calls in actual field tests by championship callers.



CIRCE SQUEALER P-6 \$3.00



COON Model C-1 \$3.00

Reproduces the terrified scream of a small rodent and is used to call the game in close after the game has been called within sight or hearing by either the P-1, Jackrabbit, or P-2, cottontail Model Calls.

COAXER MODEL Model P-3 \$1.00



ELK CALL

\$5.50

The call that sounds exactly like the bull bugle call when in rutt. The flow of air blown into either end will determine the pitch and tone — no practice needed.



PETE RICKARD'S BUCK LURE

\$2.00 per bottle



SCENT VENT

\$1.50 each Forest Green

- Eliminates soiled hands and odor on clothing and person
- Use with your favorite deer or other animal scent
- Pin on clothes or place on tree or ground
- Opens to carry scent with the wind — closes air tight — store anywhere



\$3.00

REPLACEMENT VOICE . . . 75¢ each

DEER CALL

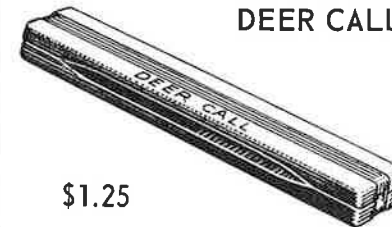

\$1.25

- Two piece plastic body
- Two special-type rubber bands
- Length 3 1/2", width 7/8", thickness 5/8"
- Produces deer's baa-when used like a mouth organ
- Peg board packed

MARTIN #411 PREDATOR CALL



Long Ranger

\$3.00

Quantity Prices Available

PINE OIL SCENT

\$1.50



CAMOUFLAGE TWO-PIECE SUITS
#80 CAMOUFLAGE PATTERN



Two-piece suit. Has best features of Viet Nam pattern and KAMO pattern. Jackets have two extra large front pockets. Two large hip pockets with flaps and buttons. Large cigarette pocket on left breast. Non-reflective buttons. Pants have two extra large front patch pockets. Two large hip pockets with buttons and flaps. Take up tabs at waist. Brass zipper fly.

#80 Two-piece suit. Made of KAMO cotton poplin. S, M, L, XL

\$12.95

Jacket only ----- 7.00

Pants only ----- 6.00

#81 KAMO Tiger Stripe Suit. \$13.95

#180 KAMO NYLON PARKA JACKET



Lightweight Viet Nam camouflage pattern of rip stop nylon. Folds small enough to fit in hip pocket. Full zipper front, two large pockets. Draw string hood. Instant camouflage. Sizes: S, M, L, XL. **\$7.95**

CAMOUFLAGE ONE-PIECE SUITS



Regular Coveralls
\$13.95



Insulated Suit
\$27.50

Sizes: S, M, L, XL. Both come with zipper pockets and are made of durable sateen.

Hood for Insulated Suit
\$5.00



#100 CAMOUFLAGE GLOVES

So light you don't even know you're wearing them. Full cut for wearing with or without other gloves. Conceals the hands perfectly. One size only.

\$2.00 pair

#17 CAMO PASTE TUBE



White and green paste in each tube

\$.50

See Dealers' sheet for quantity discounts



#34 JONES STYLE

Jones style Camouflage hunting hat. Cotton poplin with lined ear flaps. Hat has foam lamination inside for insulation. Flexible stitched brim all around. Washable, ideal for bow and gun hunter. Sizes: 6 3/4 to 7 5/8

\$3.00



#175 AUSTRALIAN BUSH HAT

Featuring a large brim hat that snaps — up onto the crown, has a full sweatband, a laminated black rayon lining and a leatherette cord with a slide.

\$5.00



#1209 NEW VENTED CAP

Washable and colorfast. Sizes: Sm., Med., Lg.

\$1.95



#87 NEW HAT

Small rim makes it ideal for the archer. Foam lamination inside with lined ear flaps. Sizes: 6 3/4 to 7 5/8.

\$3.50



#15 KAMO PASTE KIT

Two large tubes of KAMO camouflage paste, packed in plastic box. One tube is Forest Brown color, one is Leaf Green. Contains insect repellent, too. Camouflage hunters, bows and guns. Easily removable.

Per Kit **\$2.00**



#35 CAMOUFLAGE HEADNET

Made of KAMO mosquito netting. Can be worn over parka hood or cap. Fits any size. Completely conceals face, eyes and neck. Perfect insect protection, too. Permits wearer easy vision.

each **\$1.50**

#101 NYLON CLOTH BOW TAPE

Conceal your bow. Four pieces of bow tape 32" long x 3" wide. Adhesive backing, will not affect finish on bow. Peel off and use again.

\$1.00

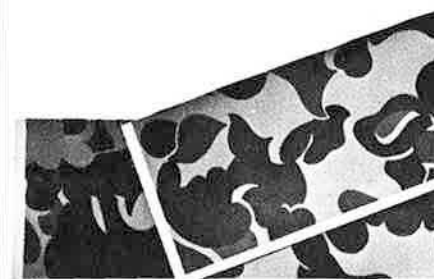

#125 BOW COVERS

Water repellent. Elastic thread backing to assure snug bow fit. Lasts for years, use over and over. Easy on — easy off. Will not interfere with bow action. Individually packed in clear poly bag. Two sizes: Small and Large.

\$2.00 each





LAYFLETCH — The Unit Arrow Fletching

30¢ each

- Flexible
- Tough
- Slips over shaft
- Weatherproof
- Waterproof
- Adjustable
- No jig needed
- Twist to spiral desired
- Fits 9/32" and 5/16" shaft sizes

FISH REELS

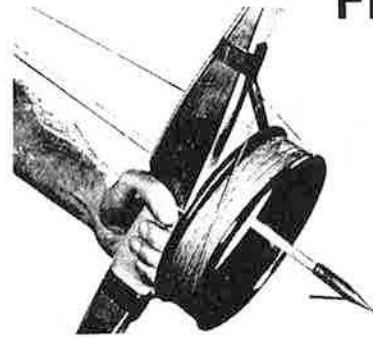

ST 25 "SHOOT-THRU" REEL
\$3.95

- 7" diameter
- Direct center-shot design
- All aluminum (anodized) construction
- Snag-proof line holder
- Easily adapted to any bow
- Equipped with 50 ft. of 80 lb. test line

BOW REELS



DELUXE CUSTOM

#16 DELUXE 4½" \$3.50
#19 CUSTOM 6" \$3.95

- Aluminum constructed with flange mounting bracket
- Easily taped to bow
- Full circle construction offers snag-proof uncoiling
- Complete with 50 ft. of 80 lb. test line
- Snag proof line holder



#ST21 DELUXE FISH REEL
\$3.70

- Tough plastic with metal straps
- Easily taped to bow
- Built-in clip to hold line
- Shoot thru reel
- 5" diameter



BOWREEL LINE
\$.95 per package

- Braided line.
- 50 feet.
- 80 lb. test line.

FREE FOR THE EATING

• A nature-study cook book showing how to find and feast on 100 wild plants • Over 300 recipes • 88 wholesome wild fruit uses • 124 undomesticated wild green dishes • 41 tantalizing wild root and tuber tempters • 21 savory wild nut eatings • 27 centuries old wild beverage bush brews.
By Bradford Angier
\$4.95



POCKET GUIDE TO ARCHERY

• Revised and up-dated P.F.G. to Archery • Coaches the beginner • Steers him on equipment and technique • Advises on bowhunting, field and target shooting • Animal habits • How to get started inexpensively.
By Howard T. Sigler
\$2.95

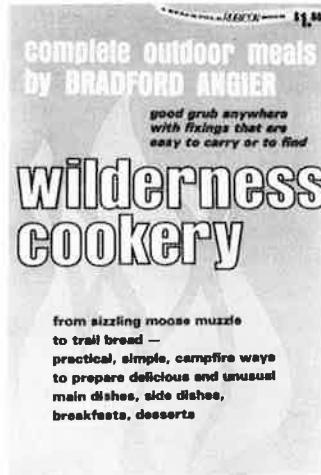

WILDERNESS COOKING
\$1.95

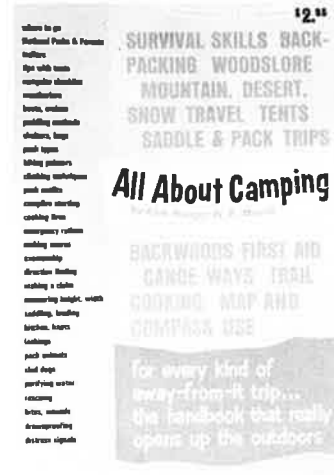

ALL ABOUT CAMPING
\$2.95



ISHI IN TWO WORLDS

• A biography of the last wild Indian in North America • How Ishi, a stone age man, adapted to 20th century society after he was discovered naked, weaponless, and starving into a slaughter house.
By Theodora Kroeber
Paperback \$1.95



THE ARCHER'S BIBLE

• Principles of bowhunting • Bowhunting big game • Underwater Bowhunting • Safety • Foundations • Faults and corrections • State bowhunting directories.
By Fred Bear
\$1.95



#51 FISH POINT
Single Barbed, One Piece Harpoon Point..... \$1.75 ea.



#54 AL'S FISH SLICK
-New retractable fishing point with moving barb
-No need to disconnect line from arrow
-5/16" I.D. \$1.95



#58 FISH POINT
250 grains.
5/16" parallel hole.
Barb can be reversed for easy removal from fish.
85¢ ea.

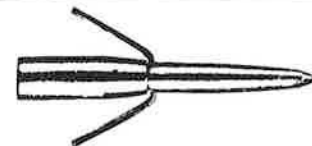

#53 FISH POINT
Good steel FISH POINT with very strong wire barbs. Take-apart design for easy removal from fish. Long slender nose for penetration.
75¢ ea.

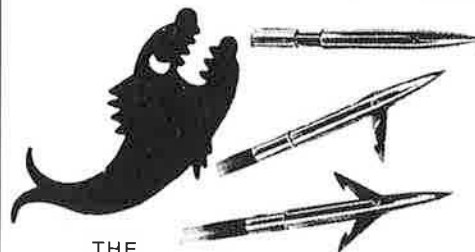

#59 "AQUA KILLER"

- Opening force adjustable by bending blades
- Made of finest quality stainless steel
- Guaranteed rust proof and salt water proof
- Opens instantly on contact!
- Simply close blades to remove from fish

Single Blade \$2.50 each
Double Blade 3.50 each

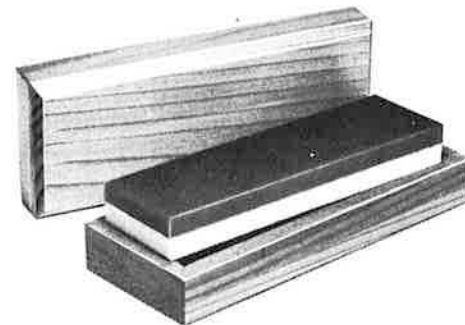

#710 ARKANSAS OILSTONE

Combination hard/soft bench stone

Enclosed in wooden box

\$5.00

#701 UTILITY SHARPENING STONE



-With Molded Case-

- Molded saddle leather
- Oil finish
- Slotted for belt
- Always "there" for instant use
- Medium fine grit crystallon stone

\$1.75

#704 STONE/METAL MATCH CASE



- With metal match and sharpening stone
- Metal Match lights any fire a regular match can EVEN WHEN WET!

\$3.95

#705 BROADHEAD SHARPENER

An easy way to sharpen broadheads.

\$2.00

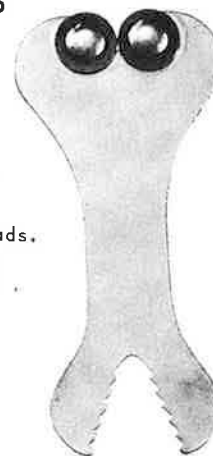

#706 HONING OIL



\$1.10

#708 ORIGINAL ARKANSAS OILSTONE, pocket size

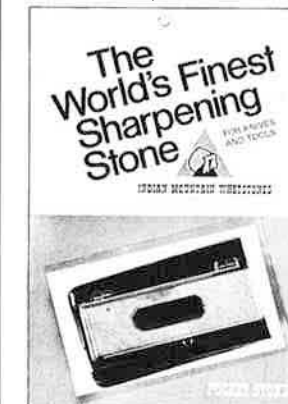

Available in hard or soft
\$2.65 ea.

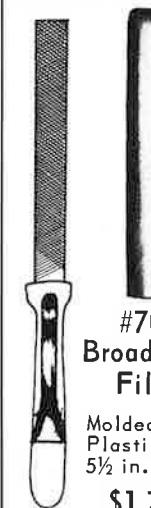

#709 Broadhead File

Molded Plastic Case.
5½ in. long.
\$1.75

GIANT VINYCALS for campers, boats and trailers

FULL COLOR
SELF ADHESIVE



VDD-8 ELK



VDD-6 JUMPING DEER

8" X 12" Size

\$1.29 Ea.

Extra 10% discount on 12 or more

- | | | |
|-----------------------|-----------------------|---------------------------------|
| VDD- 1 Mallard Duck | VDD-20 Raccoon | VDD-47 Coyote |
| VDD- 2 Bighorn Sheep | VDD-21 Horse | VDD-48 Bald Eagle |
| VDD- 3 Fawn | VDD-22 Razorback | VDD-53 American Flag |
| VDD- 4 Buffalo | VDD-23 Black Angus | VDD-54 Confederate Flag |
| VDD- 5 Moose | VDD-24 Hereford | VDD-55 Canadian Flag |
| VDD- 6 Jumping Deer | VDD-25 Husky Dog | VDD-56 Holstein Cow |
| VDD- 7 Chipmunk | VDD-28 Indian Head | VDD-57 Caribou |
| VDD- 8 Elk | VDD-29 Cardinal | VDD-58 Quarter Horse |
| VDD- 9 Rainbow Trout | VDD-31 Road Runner | VDD-59 Cougar |
| VDD-10 Black Bear | VDD-32 Antelope | VDD-60 Jackalope |
| VDD-11 Pheasant | VDD-33 Elk Head | VDD-61 Spread Eagle (U.S. Seal) |
| VDD-12 Seagull | VDD-34 Canadian Goose | VDD-62 Red Fox |
| VDD-13 Black Bass | VDD-35 Deer Head | VDD-63 Comic Coyote |
| VDD-14 Quail | VDD-36 Appaloosa | VDD-64 Comic Road Runner |
| VDD-15 Totem Pole | VDD-40 Mountain Goat | VDD-65 Am. Flag (Waving) |
| VDD-16 Polar Bear | VDD-42 Northern Pike | VDD-66 Square Dancers |
| VDD-17 Longhorn Steer | VDD-43 Muskie | VDD-67 American Thoroughbred |
| VDD-18 Wild Turkey | VDD-45 Pointer | VDD-68 Tenn. Walking Horse |
| VDD-19 King Salmon | VDD-46 Dall Sheep | VDD-69 Kodiak Bear |



SHAFT SPIDER KIT

The kit contains Shaft Spider parts to fit three of your own hollow shafts, either aluminum or fiberglass, with an inside diameter of 1/4" or greater. The Shaft Spider kit can be used also to replace spent bobbins in the Shaft Spider arrows. Complete with easy-to-use instructions.

Kit of 3 \$4.95

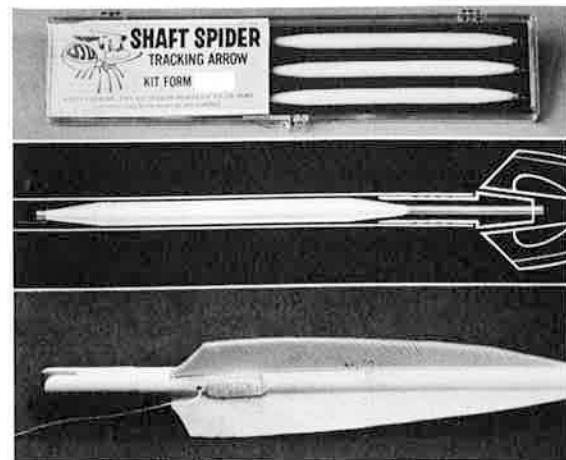

BUGGED?



CUTTER
INSECT REPELLENT
... is incredibly effective!!



\$1.49

LOOK!

NOT JUST ONE,
BUT THREE
SUCTION CUPS
THE MORE
SUCTION
CUPS
THE BETTER!

CUTTER
SNAKE
BITE KIT

You can buy more gadgety-looking kits but you can't buy one as practical or as effective.

No mixing pills to break or get out of water. Cutter Snake Bite Kit is used like all others combined. Durable. Officially by Ray Searles of America.

Impervious rubber cups rest to form with compact package - fits in pocket. Eliminates carrying hard slippery, bulky box.



\$2.98



ACTUAL SIZE



CUTTER TRAIL PACK

Featherweight personal kit designed specifically for the backpacker, with over 35 essential first aids included! A unique lifesaver for quick, on-the-spot emergencies. Small, unbreakable contoured case fits pocket or pack. Unique closure prevents accidental opening; bars dirt, dust and moisture.

\$3.98



CUTTER CAMP PACK

Most complete, practical and compact emergency kit made! Contains over 50 essential aids for fast, effective first aid care. CUTTER Snake Bite Kit is included, too. Sturdy, lightweight flexible cover with zippered clear plastic inner compartments that let you see what you need in a hurry. Seals out moisture and dust, too.

\$9.95

#435 ANGELO BOW HOLDER SET

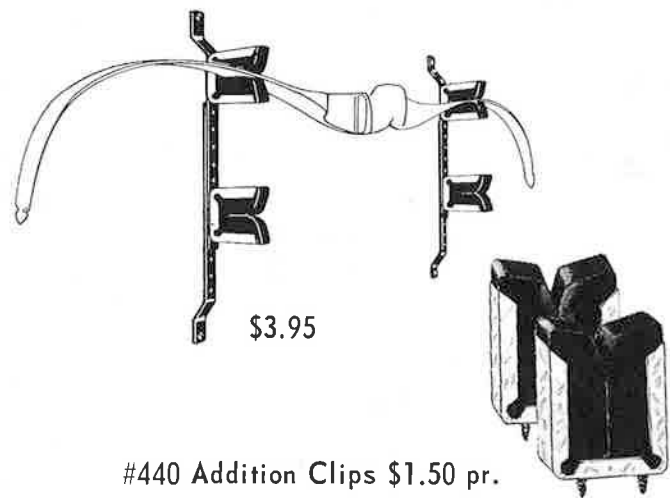

\$3.95

#440 Addition Clips \$1.50 pr.

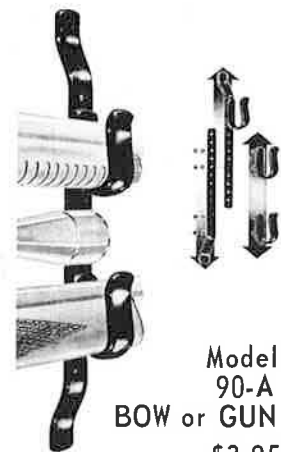

Model
90-A
BOW or GUN RACK
\$3.95

#93C Additional Pr.
Clips \$1.50



BUCK HORN MOUNTING KIT

This is a complete kit with all parts pre-installed. Only a screwdriver is needed after your horns are sawed. Just make cuts No. 1 and No. 2 on your horns and clean. Throw away dummy horns No. 5 and replace with your horns. Replace the head piece No. 3. It's as simple as that. Fits large or small horns.

Plaque Size: 3/4 x 9 1/2 x 12 in.
No. 475-G Emerald Green
No. 476-R Old Glory Red
PRICE \$6.95

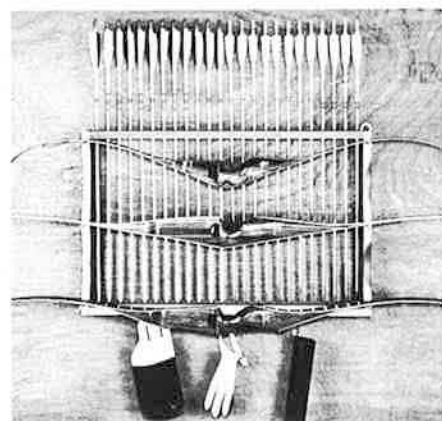
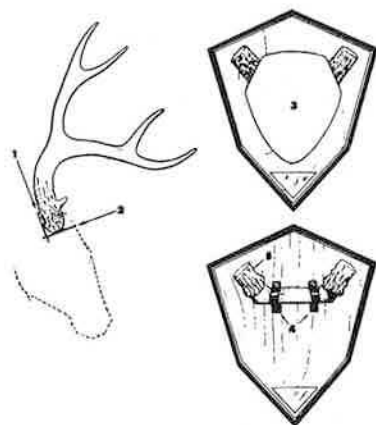

BOW & ARROW WALL RACK

Do-it-yourself kit comes packaged complete, with instructions for fast assembly. Made of California Redwood, with metal wall hangers and special accessories hooks. Holds 6 bows and 2 dozen arrows. Grooved at rear to allow display of your enlarged club or state emblem, favorite hunting scene, etc. as a background if desired. Can be assembled in 5 minutes and finished as you please. An ideal gift.

\$7.65 Each

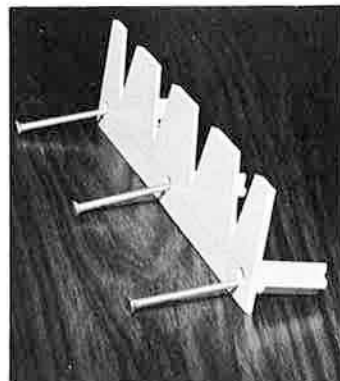

#81 BOW HANGER
High Impact Styrene
... \$1.90 ea.



#243
Pin On
COMPASS ... \$1.95



SMOK-CLIPS \$1.00

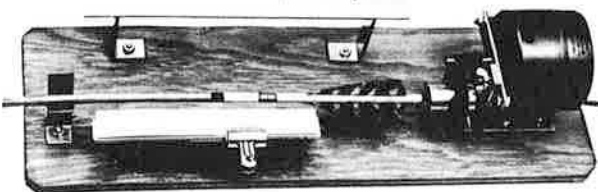

EASTERN CRESTOR

- Adjustable 2 speed — 300 RPM — for broad stripes
400 RPM — for fine stripes
- 1/100 h.p. fan cooled, continuous operating, heavy duty motor
- Painting guide and arm rest of steel
- A & D chuck with replaceable rubber bushings fits all size nocks
- Oil impregnated bronze chuck bearing

\$20.55

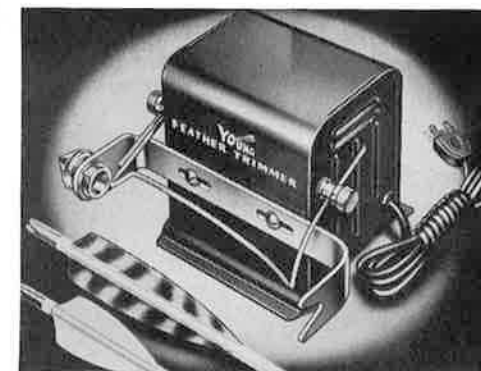

YOUNG FEATHER TRIMMER

Sturdy all steel case, red finish
Adjustable aluminum bracket
Complete with three Klean-Cut ribbons

\$22.50

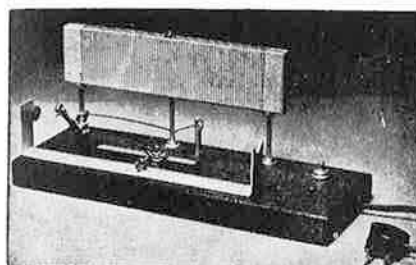

Extra Wires for
Eastern Trimmer
Package of 3
\$.30

EASTERN TRIMMER

Wooden base in mahogany finish.
Easily adjusted.
Conveniently placed switch.
Supplied with 3 trimming wires.
Resistor more efficient and cooler.
Adjustable left and right wire post holders for different feather lengths.
Shaft holder movable in any direction — eliminates moving burning wire.
Accommodates to 6" feather.

\$6.40

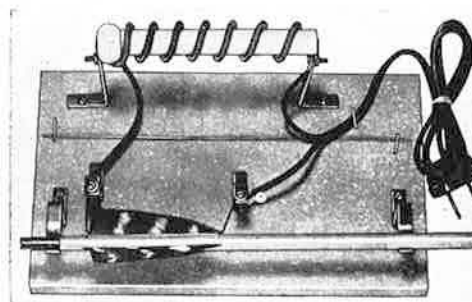

#5166 BURNER KIT

Ready to assemble including resistance element. (Kit does not include mounting board)

\$3.25



ARROW CLIPS

The perfect clip for tackle boxes, arrow display racks. Made of finest spring steel, nickel plated over copper and burnished.

No. AC—Arrow Clip and Screw.
per gross \$6.60 each \$.06



\$4.95
X-ACTO SET

#2211 ALUMINUM ARROW STRAIGHTENER



\$22.95

-Nylon V blocks — pair \$2.50

- Indicator shows arrow trueness to one-thousandth of an inch
- Straightens bends even in feathers
- Fully illustrated instructions
- Precision made to close tolerances
- Fits any size shaft — no bushings required

- Moveable plastic V blocks
- Soft handle — stops denting
- Easy to operate
- Fast to operate
- Sturdy gold anodized aluminum frame

MODERNIZE
YOUR ARROWS
WITH →



Fluorescent colors —
Orange
Green
Ruby
Add \$1.00 per hundred for
fluorescent colors.

ACTUAL SIZE



P15 - 1 5/8" - \$3.00 per 100

P15 — The smallest size is used for a four or six vane fletch on target arrows.



P16 - 1 6/8" - \$3.50 per 100

P16 — NEW Mini-Vane — 1 3/4" (45mm) x 3/8" (8.5mm). Fluorescent colors only.



P22 - 2 2/8" - \$3.50 per 100

P22 is used by those who want a little more steering surface than the P15 offers.



P23 - 2 3/8" - \$3.50 per 100

P23 a new parabolic cut — excellent for women's arrows.



P25 - 2 5/8" - \$4.00 per 100

P25 is the original target size vane.



P26 - 2 6/8" - \$4.00 per 100

P26 is 1/8" longer than P25 yet is lower than P22. Total surface area between P22 and P25.

Regular colors —
Red
White
Black
Yellow

Sold only in
boxes of 100.

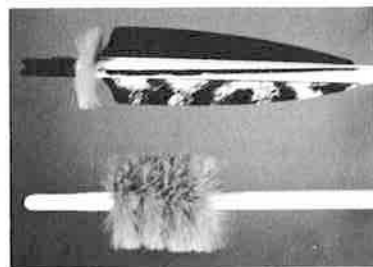

FUR FLETCH

-Use for fur fletch or tracer
-Quick simple installation

Colors: white, yellow, blue,
red, and orange

\$2.50/doz., \$18.00/100

**FOR RUSH ORDERS,
CALL
1-509/529-2554**

DIE CUT FEATHERS



Left or
right wing



MARTIN NO. 1 PREMIUM FEATHERS

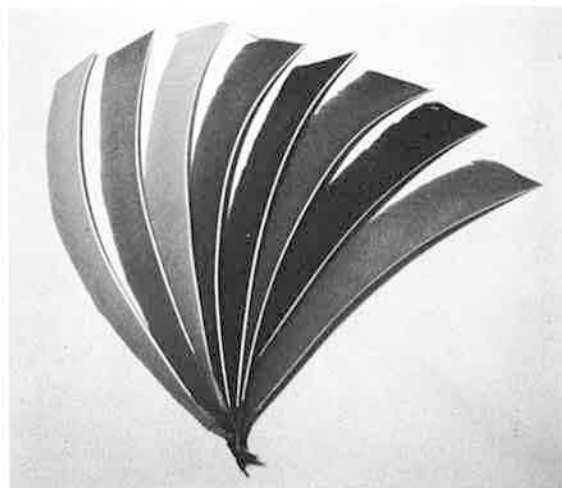

Specify Right or Left Wing

WHITE List per doz. \$1.00
Per Hundred..... \$6.50
DYED WHITE List per doz. \$1.10
Per Hundred..... \$7.00
See Price Sheet for Quantity Discount

	3"	3 1/2"	4"	5"
Per dozen	\$.50	\$.65	\$.75	\$.90
Per 100	2.80	3.80	4.30	5.50

Extra 10% discount on 1000 and up.



New Bitzenburger Dial-O-Fletch

Fletches arrows diagonally, straight, or with true helical fletch right hand or helical fletch left hand. Precisioned die-cast, form-fitting, thumb-controlled clamps. Graduated scale on side of clamps accurately spaces feather or vanes from nock—120°, 75° x 105°, 90°, or 60°. New self-centering nock receiver fits all nocks. Knife edge on base of clamps eliminates surplus glue.

Jig with straight clamp..... \$22.50
With right or left hand-true helical
clamp. (Specify right or left clamp).. \$25.00
Straight clamp only..... \$5.00
Helical clamp only (Specify R or L).... \$6.50



THOMPSON FLETCHING JIG

Infinitely variable degree of right or left spiral can easily be set. Ideal for replacing one or two damaged feathers.

\$18.95



MONO-FLETCHER with
Straight Clamp
\$8.50



MONO-FLETCHER with
Helical Clamp Right or left
\$9.50

ONE DOZEN BOX



Telescope type corrugated
box for 1 dozen arrows.
Now 6" x 34" x 2-1/4".
100 boxes net ---- \$23.00



ARROW PADS Holds one
dozen arrows in display box.
100 pads net----- \$3.25
1M Net ----- \$20.00
10M@ Net --- \$18.50 per M



EASTERN FLETCHER
Converts in seconds from
3 to 4 fletch of any angle
desired. Mounts on bench
at convenient angle.
#715 Fletcher \$6.95



Fleetwood
SPIRAL FLETCHER
Non adjustable spiral
#5089 for L. W. feathers \$3.75
#5088 for R. W. feathers \$3.75



SPIRAL 4 FEATHER FLETCHER
#5159 90° left spiral \$4.25
#5083 90° right spiral \$4.25

MULTI-FLETCHER

FLETCHES 6 SHAFTS IN ONE JIG
Fletches any length feather up to 6".

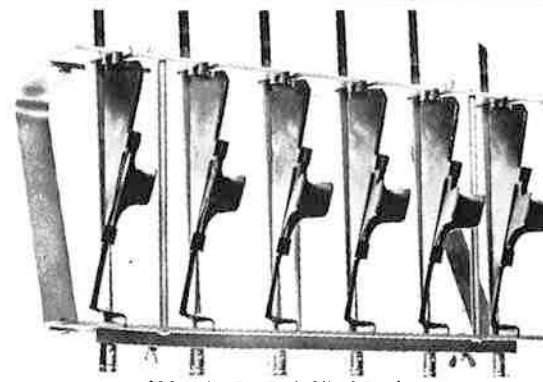

• 11° Helix For Each 1" of Feather •
aluminum frame and plated steel clamps.

STRAIGHT
Right or Left Offset
3 or 4 Feathers
\$27.00

HELICAL
MULTI-FLETCHER
SPECIFY: LEFT OR RIGHT WING
3 or 4 Feathers
\$32.50



RESIWELD EPOXY... \$.98



"5 MINUTE" EPOXY.. \$1.25

MARTIN BULK

FLETCHING CEMENT

- Crystal Clear
- Fast Drying
- Super Strength

For Wood, Glass or Al. WGA-66

\$1.50 pt. net

2 oz. DISPENSER for bulk glue 25¢ ea. net

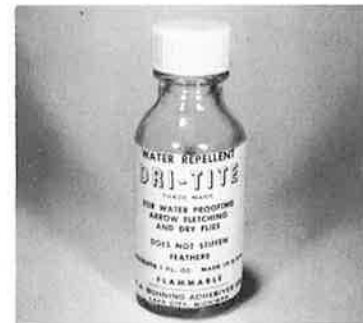

DRI-TITE 65¢ bottle

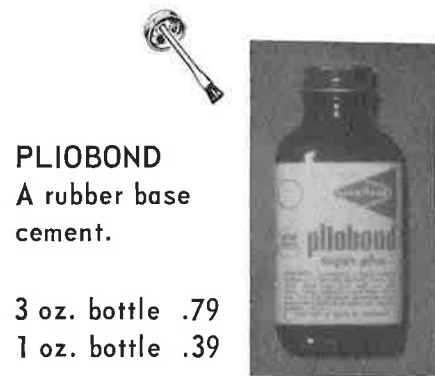

PLIOBOND A rubber base cement.

3 oz. bottle .79
1 oz. bottle .39



TEX-TITE BOW STRING WAX Tube 65¢



-MARTIN FLEXIBLE POINT CEMENT For point or broadhead. \$.75

-FERR-L-TITE (stick) \$.65

FERR-L-TITE (bulk), 1/2# \$2.95

-FERR-L-TITE (liquid)..... \$.75

-EVERFAST CEMENT..... \$.25

-FLECHTITE CEMENT \$.65

-24SRT-X CEMENT \$.60

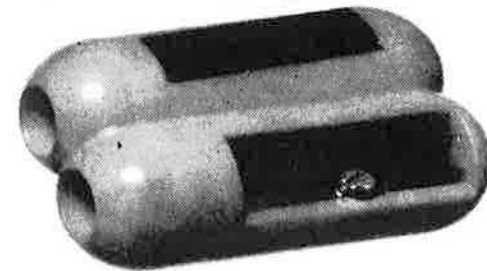

ACCURATE ARROW TAPER & TENON TOOL

TT-2-5/16" Broadhead and nock taper in one
TT-3-11/32" small unit made of durable plastic with metal cutting blades.
\$1.50 ea.



#935 TAPERING SET

-2 main bodies: Nock taper — field or broadhead taper
-4 bushings — 1/4", 9/32", 5/16", and 11/32"
-Bushings have tapered sleeves to fit into tapered hole of main body
-Blades are regular Schick Injector Type
-Directions included \$5.00

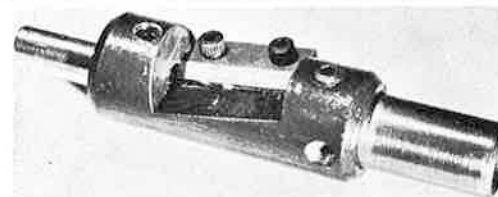

EASTERN TAPERING TOOL

The EASTERN TAPERING TOOL has a durable aluminum body. The hollow ground blade is of hardened tool steel. An adjustable steel stop and four steel interchangeable guide bushings for shaft sizes 9/32", 5/16", 11/32", and 3/8" are included. All screws are Allen screws.

ET-5 FOR 5° POINT TAPERS.....\$7.95
ET-11 FOR 11½° NOCK TAPERS.....\$7.95
EXTRA BLADE — FOR ET-5 OR ET-11...\$1.00

MID-NOX

SIZES 7/32", 1/4", 9/32"

COLORS White, Flame Orange

PRICE \$1.20/dozen \$9.50/100

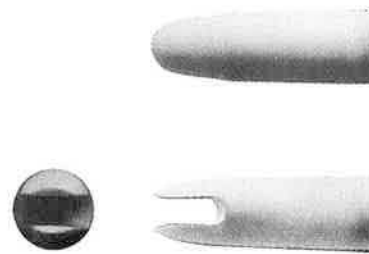

BJORN-NOCK

SIZES 1/4", 9/32", 5/16"

SOLID COLORS White and Black

PRICE \$1.00/dozen \$7.50/100

TRANSPARENT COLORS Blue, Ruby, Fluorescent Orange, Light Green

PRICE \$1.10/dozen \$8.30/100

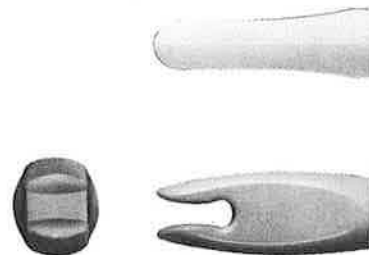

TRU-NOCK

FLOURESCENT COLORS red, green, white
No sharp corners to cut string
Shaped to reduce finger pinch
Feather edged end

Sizes — 1/4, 9/32,

Per DOZEN \$.75

Per HUNDRED \$4.00

Per THOUSAND \$30.00

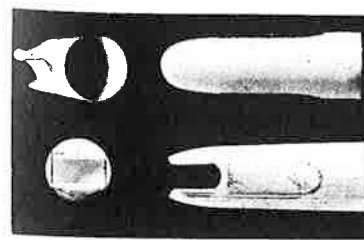

INDEX-NOCKS

Available in seven bright colors: Red, yellow, green, black, orange, blue and white. Four sizes: 1/4", 9/32", 5/16" and 11/32".

45¢ Per Doz.

\$2.00 Per Hundred

\$14.25 Per Thousand

Quantity Prices Available



OFFICIAL N.F.A.A. BIG GAME FACES
OVER-HURLING SCORING!
\$6.95 SET
14 TARGETS

AFRICAN SAFARI SET
 By MARAVIOV
\$11.25 SET (14 targets)

Official Animal Round (Broadhead)
 Heavy Tag

Size	No.	Price	Set Inc.
40x28	OAR1	Bear, Deer, Moose	\$.70 (3)
28x22	OAR2	Antelope, Mountain Lion, Ram	.40 (3)
22x14	OAR3	Coon, Goose, Javelina, Coyote	.30 (4)
14x11	OAR4	Pheasant, Prairie Dog, Jack Rabbit, Duck	.15 (8)
Set of 18	OAR18	Set for 14 Target Course	5.95 (18)

7381 White tail buck eating 35" x 45"
\$1.50

OFFICIAL SIZE FIELD FACES
 TOUGH 100# HEAVY TAG CORRUGATED

Size	No.	Price	Set Inc.	No.	Price
24"	B24	\$.25	(4)	CB24	\$.45
18"	B18	.15	(6)	CB18	.30
12"	B12	.10	(8)	CB12	.15
8"	B 8	.07	(18)	CB 6	.08
6"	B 6	.04			

36-Face Set B36 3.40 Quantity prices available

#G18 SPRAY TARGET
ADHESIVE
\$3.50

OFFICIAL NFAA BLACK HUNTER
 CORRUGATED

Size	Set Inc.	No.	Price
24"	(3)	CH 24	\$.60
18"	(5)	CH 18	.60
12"	(1)	CH122	.60
12"	(4)	CH 12	.20
6"	(5)	CH 6	.10

8-Face Set (18) CHFS 4.00

FULL COLOR ANIMAL FACES

So lifelike they'll give you "buck fever!" Line includes deer, mountain lion, fox, wild turkey, pheasant, bobcat, squirrel and bluejay... each in its natural color and habitat. Available in Saunders famous TOUGHENIZED or tag stock. Add extra fun to your archery.

Size	Full Natural Color	Tag Stock	Tough-enized	Set Inc.
24"	Deer	CA24	.50	TCA24 .95 (2)
24"	Mountain Lion	CA24	.95	TCA24 .95 (2)
18"	Fox	CA18	.30	TCA18 .50 (3)
18"	Wild Turkey	CA18	.50	TCA18 .50 (3)
12"	Pheasant or Bobcat	CA12	.15	TCA12 .20 (8)
6"	Squirrel or Bluejay	CA 6	.04	TCA 6 .05 (18)
	36 Faces in set	CA36	6.50	(36)

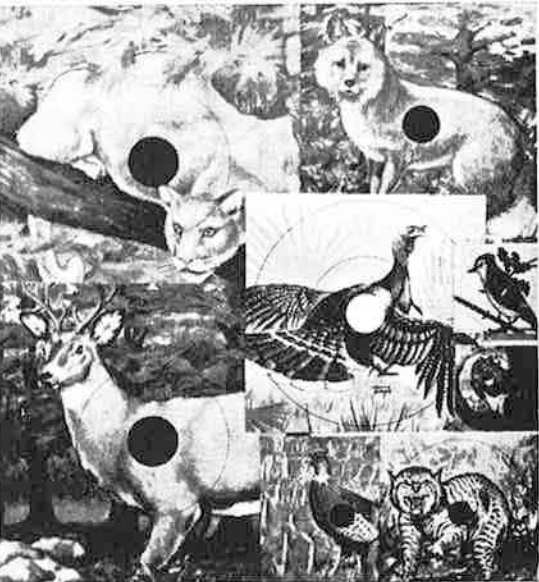

REGULATION OUTDOOR MATTS
 CHEMICALLY TOUGHENIZED

FAMOUS INDIAN CORD GRASS
 EXCLUSIVE END-GRAIN CENTERS

- Tightly woven Indian cord grass construction gives toughness and resiliency that far outlasts any competitive matt
- Unlike bales which are cumbersome, break apart and become unsightly
- Are "self-healing"
- Unique zig-zagged outer windings stay tighter — can't loosen — so matt lasts far longer
- Arrows enter parallel to the fibers

BURLAP COVERED

Size	Weight	No.	Price
48 in.	70 lbs.	No. 48B	\$39.95
36 in.	40 lbs.	No. 36B	23.95
30 in.	30 lbs.	No. 30B	17.50
24 in.	20 lbs.	No. 24B	13.95
16 in.	10 lbs.	No. 16B	6.95

We maintain a complete stock of matts. All orders shipped direct from Walla Walla.

200# up — Freight Prepaid

MATT EASEL

- Cold rolled steel for maximum strength
- Hinged—folds flat for easy storage/handling
- Webbing across base supports matt — keeps legs from spreading

HME-1 — 24" and 30"	\$ 5.95
HME-5 — 30" and 36"	\$ 6.95
HME-2 — 36" and 48"	\$13.95

NEW NFAA IN DOOR
 Score 5-4-3 at 20 yds.
15¢ ea.

NYLON BACKSTOP NET

This all nylon woven net will stop an arrow from any weight bow without injury to either the arrow or the net. Perfect as a backstop for archery range, school, store, or club. 8" high by any length.
32¢ per sq. ft.

STANDARD 4 COLOR FACE
 — SQUARE — —Non-glare — Fade-proof

Size	Tag No.	Price	Toughened No.	Price	Oil Cloth No.	Price
48"	P48	\$1.65	T48	\$2.98	O48	\$5.00
36"	P36	.95	T36	1.98	O36	3.50
80CM				1.00		
24"	P24	.50	T24	.95	O24	2.00
16"	P16	.20	T16	.25		
12"	P12	.15				

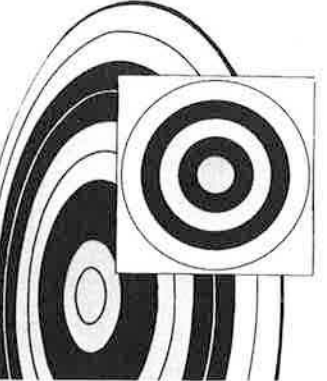

- SKIRTED —
- Circular face -Thin muslin-draw-string skirt

TOUGHENIZED OIL CLOTH

Size	No.	Price	No.	Price
48"	TS48	\$4.50	48OS	\$6.50
36"	TS36	3.50	36OS	5.00
30"	TS30	2.49		
24"	TS24	1.89	24OS	3.50
16"	TS16	.95		

OFFICIAL PAA OUTDOOR ROUND

•Black on heavy tag
 -10 target unit
 -Scoring — 5, 4, 3 points
 -Round — 2 units of 10 shot

Size	No.	Each	Distance shot (1 unit)
30"	P30	\$.65	65/60/55 yards
22"	P22	.45	50/45/40/35 yards
14"	P14	.15	30/25/20 yards

Per Set 5.55

INDOOR PAA FACES BLUE
 with **WHITE BULLSEYES**
 New blue and white 20" face on heavy tag.
 SCORE—5-4-3-2-1
 5 Arrows—12 Ends

PAA Patches
10¢

25¢ each

NFAA FREEMAN (INDOOR) ROUND FACE

-Green face with white lines
 -18" diameter
 -5 rings (5-4-3-2-1)

3 ends (of 5 arrows) at 10 yds.
 4 ends (of 5 arrows) at 15 yds.
 5 ends (of 5 arrows) at 20 yds.

Heavy tag . . . 15¢ ea.

MICRO-FLITE® SHAFT SIZE SELECTION CHART

TARGET ARROWS

Bow Weight at Draw Length	Draw Length										
	23"	24"	25"	26"	27"	28"	29"	30"	31"		
20-25	0	0	0	1	2	3	4	5	6		
25-30	0	0	1	2	3	4	5	6	7		
30-35	0	1	2	3	4	5	6	7	8		
35-40	1	2	3	4	5	6	7	8	9		
40-45	1	2	3	4	6	7	8	9	10		
45-50	2	3	4	5	6	7	8	9	10		
50-55		4	5	6	7	8	9	10	11		
55-60			5	6	7	8	9	10	11	11	
60-65				7	8	9	10	11	11	12	
65-70					8	9	10	10	11	12	12
70-75						10	10	11	12	12	12

HUNTING AND FIELD ARROWS

Bow Weight at Draw Length	Draw Length										
	23"	24"	25"	26"	27"	28"	29"	30"	31"		
30-35	1	2	3	4	5	6	7	8	9		
35-40	2	2	3	4	5	6	7	8	9		
40-45		3	4	5	6	7	8	9	10		
45-50			4	5	6	7	8	9	10	11	
50-55				5	6	7	8	9	10	11	11
55-60					7	8	9	10	11	11	12
60-65						8	9	10	11	12	12
65-70							9	10	11	12	12
70-75								10	11	12	12
75-80									11	12	12
80-85										11	12
85-90											12

EASTON SHAFT SIZE SELECTION CHART

These charts will give the shaft size that will shoot well for the majority of archers with a minimum of additional bow tuning.

ACTUAL BOW WT.	ARROW LENGTH (See Step 4, page 2)										SHAFT WEIGHT (per 100 grains)
	22	23	24	25	26	27	28	29	30	31	
15-20#						1713	1713	1713			EX LIGHT (.013)
	1416	1416	1416	1416	1516	1616	1616	1716			LIGHT (.016)
20-25#						1713	1713	1813	1813		EX LIGHT (.013)
	1416	1416	1416	1516		1616		1716			LIGHT (.016)
25-30#					1713	1713	1713	1813	1813	1913	EX LIGHT (.013)
	1416	1416	1516		1616		1716	1816			LIGHT (.016)
30-35#					1713	1713	1813	1813	1913	2013	EX LIGHT (.013)
			1516		1616		1716	1816	1816	1916	LIGHT (.016)
35-40#					1713	1713	1813	1813	1913	2013	EX LIGHT (.013)
			1616	1716	1816	1816	1916	1916	2016		LIGHT (.016)
40-45#					1713	1713	1813	1813	1913	2013	EX LIGHT (.013)
			1716	1816	1816	1916	1916	2016	2016		LIGHT (.016)
45-50#					1713	1713	1813	1813	1913	2013	EX LIGHT (.013)
			1716	1816	1816	1916	1916	2016	2016		LIGHT (.016)
50-55#					1713	1713	1813	1813	1913	2013	EX LIGHT (.013)
			1716	1816	1816	1916	1916	2016	2016		LIGHT (.016)

HUNTING Broadhead Shaft Size and Finished Arrow Weight*

ACTUAL BOW WEIGHT	SHAFT SIZE	BROADHEAD ARROW LENGTH					
		27	28	29	30	31	32
45	WEIGHT IN GRAINS	444	476	466	523	535	588
	SHAFT SIZE	1918	2016	2016	2016	2020	2219
50	WEIGHT IN GRAINS	468	456	511	523	575	598
	SHAFT SIZE	1918	2016	2018	2020	2219	2219
55	WEIGHT IN GRAINS	469	456	511	562	584	596
	SHAFT SIZE	2018	2018	2020	2219	2219	2219
60	WEIGHT IN GRAINS	487	499	549	570	584	598
	SHAFT SIZE	2018	2020	2219	2219	2219	
65	WEIGHT IN GRAINS	487	536	557	570	584	
	SHAFT SIZE	2020	2020	2219	2219		
70-80	WEIGHT IN GRAINS	523	536	557	570		
	SHAFT SIZE						

*Weight includes: shaft, 125 grain broadhead point and fletching.

EASTON X7 SHAFT SIZE SELECTION CHART

BOW WEIGHT	ARROW LENGTH (INCHES)									
	24	25	26	27	28	29	30	31	32	
20-25			1614	1616	1714	1716	1814			
25-30		1614	1616	1714	1716	1814	1816	1914		
30-35	1614	1616	1714	1716	1814	1816	1914	1916	2014	
35-40	1616	1714	1716	1814	1816	1914	1916	2014	2014	
40-45		1716	1814	1816	1914	1916	2014	2014		
45-50			1814	1916	2014	2014				

The Russell Belt Knife

Russel Canadian Knife Model 1

- Flat back edge for easy slitting
- Unique 4-inch elliptical blade
- Handle gives knuckle clearance

PRICE \$14.00
Trout & Bird Knife Model 2

- Stainless, resists corrosion
- Women handle this knife easily

PRICE \$12.00
Russel Boat Knife Model 3

- Neat, comfortable to hold
- Self-hilt, good finger protection
- Wrist thong for extra holding

PRICE \$16.00
Russel Big Game Knife Model 4

- 5½ in. Swedish steel blade
- Ideal for trail blazing
- Heavy enough for light chopping

PRICE \$29.50
RusselBELT KNIVES are provided with original design scabbards of hand-moulded, 6-ounce, top grain stained and polished cowhide.



RAW MATERIALS

Easton Swift shafts Full length, Points loose	per doz.	16.60
Easton shafts 24SRT-X Full length, Points loose	per doz.	20.80
Easton shafts 24SRT-X Cut to length, Points installed	per doz.	22.00
Easton shafts XX75 Full length, Points loose	per doz.	25.80
Easton shafts XX75 Cut to length, Points installed	per doz.	27.00
Easton shafts X7 Full length, Points loose	per doz.	30.80
Easton shafts X7 Cut to length, Points installed	per doz.	32.00

Extra Broadhead Adaptors for Easton Shafts	per doz.	2.40
Extra Target Points for Easton Shafts	per doz.	3.80

MARTIN HUNTER Green Glass Shafts with Inserts ... per doz. 12.00

Micro-flite shafts Full length, Nock and points loose	per doz.	17.50
Micro-flite shafts Cut to length, Nock & points installed	per doz.	19.50

Compressed Wood Battleshaft Shafts ... per doz. 9.95

Port Orford Cedar Shafts - Matched within 5# spine

No. 1 - 11/32 or 5/16 Matched in weight and spine	per doz.	3.00
No. 1 - 11/32 or 5/16 Matched in weight and spine	per C	17.50
PREMIUM Port Orford Cedar Shafts (Net Price)	per M	75.00
No. 2 Select Port Orford Cedar Shafts (Net Price)	per M	52.50
Mill Run Port Orford Cedar Shafts (Net Price)	per M	52.50
Utility Grade Port Orford Cedar Shafts (Net Price)	per M	37.50

LACQUERED SHAFTS in your choice of color	per doz.	3.50
Solid Glass Fish Shafts 5/16 x 30 in.	each	1.00
Solid Glass Fish Shafts 5/16 x 30 in.	per doz.	10.00

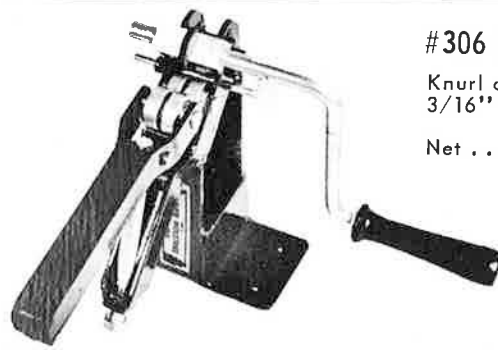

#306 KWIK-KNURL

Knurl any point from 3/16" to 3/8".

Net \$27.65

Motor drive attachment

\$11.20

Match-All ARROW POINTS

AVAILABLE IN ALL SIZES

	FIELD POINT - Taper Hole	\$1.25 Doz., \$9.00 per 100
	TARGET POINT - Taper Hole	\$1.25 Doz., \$9.00 per 100
	BLUNT POINT - Taper Hole	\$1.00 Doz., \$8.00 per 100
	TARGET POINT - Parallel Hole	\$1.00 Doz., \$8.00 per 100
	HEADSHRINKER - Aluminum	\$1.00 Doz., \$8.00 per 100
	FLIGHT POINT - Brass	\$1.25 Doz., \$9.00 per 100

5/32 O.D. 1/8" Parallel Hole
4 grains

DRAWN STEEL POINTS



DS-20 Grain 5/16" O.D.	doz	100
	.35	2.50
DS-25 Grain 11/32" O.D.	.45	3.00



DS-35 Grain 11/32" O.D.	doz	100
	.60	4.50

HSP - HEAVY STEEL POINTS

- For the professional tournament archer
- ¼" long shoulder
- 20 grains over standard weight
- Bow must be "tuned" when using them
- Fine adjustments possible by cutting off up to 1" (10 grains) of the extra long aluminum tube



\$6.00 doz.

For all X7 sizes
Also 1616, 1716, 1816, 1916 (SRT-X)

MARTIN
CUSTOM BOWSTRINGS



Largest Stock



Fastest Service

71 - 72

