

Window Shadings

Installation, Operation and Care Instructions

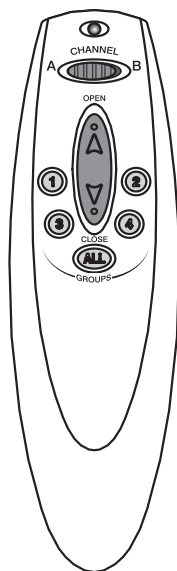

Battery-Powered
Motorized System

CONTENTS

Getting Started:

Product View	1
Tools and Fasteners Needed	2

Installation:

Installation Overview	3
STEP 1 — Install the Brackets.....	3
Mount the Installation Brackets — Inside Mount	4
Mount the Installation Brackets — Outside Mount	6
Mount the Installation Brackets — End Mount	9
STEP 2 — Install the Shading.....	10
STEP 3 — Connect the Power Source.....	12
Attach Magnetic Hold-Down Brackets (Optional)	16

Operation:

Operate the Shading	17
Resetting the Shading	19
Troubleshooting	20

Care:

Removing the Shading.....	24
Cleaning Procedures	24

Radio Frequency FCC Compliance:

This device complies with Part 15 of the FCC Rules. Operation is subject to the following two conditions:

- (1) This device may not cause harmful interference, and
- (2) This device must accept any interference received, including interference that may cause undesired operation.

This equipment has been tested and found to comply with the limits for a Class B digital device, pursuant to Part 15 of the FCC Rules. These limits are designed to provide reasonable protection against harmful interference in a residential installation. This equipment generates, uses and can radiate radio frequency energy and, if not installed and used in accordance with the instructions, may cause harmful interference to radio communications. However, there is no guarantee that interference will not occur in a particular installation. If this equipment does cause harmful interference to radio or television reception, which can be determined by turning the equipment off and on, the user is encouraged to try to correct the interference by one or more of the following measures:

- Reorient or relocate the receiving antenna.
- Increase the separation between the equipment and receiver.
- Connect the equipment into an outlet on a circuit different from that to which the receiver is connected.
- Consult the dealer or an experienced radio/TV technician for help.

Any changes or modifications not expressly approved by the party responsible for compliance could void the user's authority to operate the equipment.

Product View

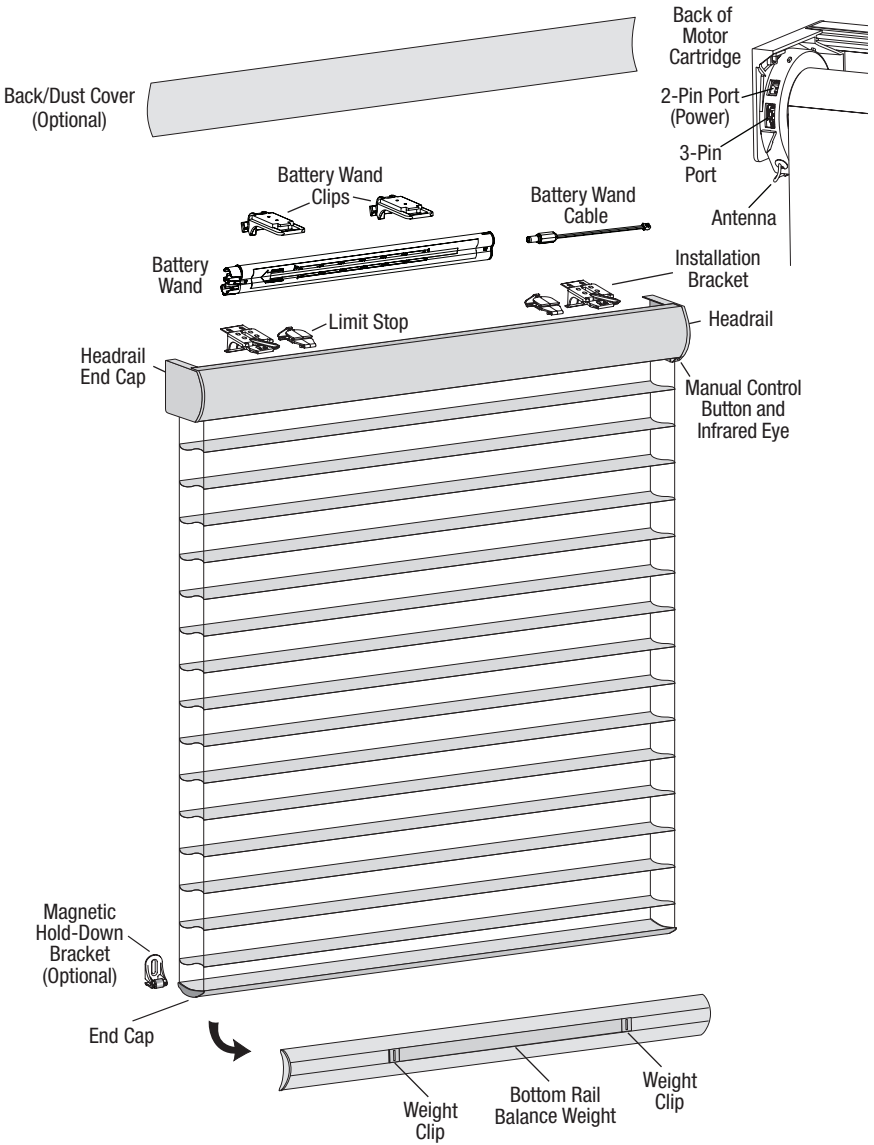

GETTING STARTED

Thank you for purchasing Window Shadings. With proper installation, operation, and care, your new shadings will provide years of beauty and performance. Please thoroughly review this instruction booklet before beginning the installation. For information regarding operation and programming, refer to the guide included with your remote control.

Tools and Fasteners Needed

- Flat blade and Phillips screwdrivers
- Level (laser level is recommended)
- Measuring tape and pencil
- Pliers
- Power drill, $\frac{3}{32}$ " drill bit, and $\frac{1}{4}$ " hex driver
- Scissors (heavy duty)

In addition, you will need fasteners designed to work with your specific mounting surface(s).

- **#6 Hex Head Screws (Provided).** Two $1\frac{1}{2}$ " screws are provided per installation bracket.
- **Longer Hex Head Screws (Not Provided).** If using spacer blocks, use #6 screws long enough for a secure attachment.
- **Speed Nuts and Screws (Provided).** Extension brackets come with screws and speed nuts.
- **Drywall Anchors (Not Provided).** Use drywall anchors when mounting into drywall.



#6 x $1\frac{1}{2}$ "
Hex Head Screw
(Provided)



Longer #6 Hex Head Screw
for Use with Spacer Blocks
(Not Provided)



Speed Nut
and Screw
(Two Provided with
Each Extension Bracket)

Installation Overview

To install your shading, you will need to perform the following three steps:

STEP 1: Install the Brackets

STEP 2: Install the Shading

STEP 3: Connect the Power Source

STEP 1 — Install the Brackets

- Your order will include the correct number of installation brackets for your shading width, as shown in the table below.
- Shading orders may also include spacer blocks or extension brackets, if they were specified for added clearance.
 - Extension brackets are used for end mount shadings, as well.

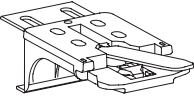

Installation Bracket

Panel Width	Brackets
12" – 36"	2
36 ¹ / ₈ " – 79"	3
79 ¹ / ₈ " – 96"	4
96 ¹ / ₈ " – 120"	5

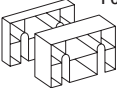

For Added Clearance
1/4" and 1/2"
Spacer Blocks

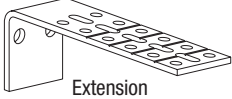

Extension Bracket

Mounting Types and Window Terminology

If the installation brackets are mounted correctly, the rest of the installation process follows easily. To prepare for this important first step, review the mounting types and basic window terminology illustrated below.

Molding

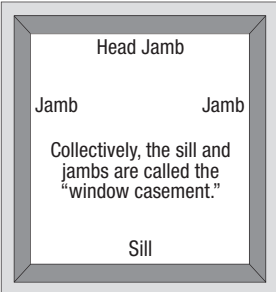

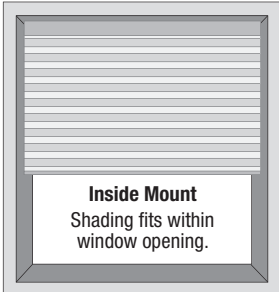

Inside Mount
Shading fits within window opening.

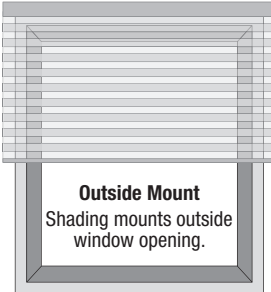

Outside Mount
Shading mounts outside window opening.

■ Refer to the appropriate page below based on your order:

- **Inside Mount — Page 4**
- **Outside Mount — Page 6**
- **End Mount — Page 9**

INSTALLATION

Mount the Installation Brackets — Inside Mount

Prepare the Installation Brackets

- **If using the optional back cover:** Use pliers or heavy duty scissors to remove both the top and bottom tabs on the installation brackets.
 - If a satellite battery pack or DC power supply is used, then remove the top tab on the back cover brackets.
 - Snap the prongs on the back cover brackets into the holes on the back of the installation brackets.
- **If not using the optional back cover with a battery wand:** Leave both tabs on the brackets. The top tab ensures that there is clearance for the wand.
- **If not using the optional back cover with a satellite battery pack or DC power supply:** Remove the top tab only on the installation brackets.

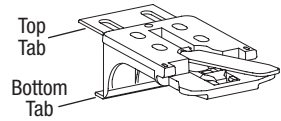

Remove the top tab if using a satellite battery pack or DC power supply.

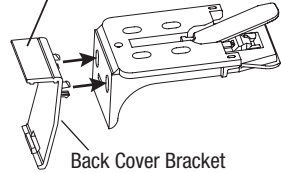

NOTE: Save these tabs once removed. They may be used as shims, as described later in these instructions.

Mount the Installation Brackets

- Measure and mark end bracket locations 2" in from each jamb.
 - If more than two installation brackets are required (see table on page 3), mark the location of additional bracket(s) spaced evenly between the two end bracket locations. Mount into wood whenever possible. **Allow a minimum of 18" from the motor side for the battery wand.**

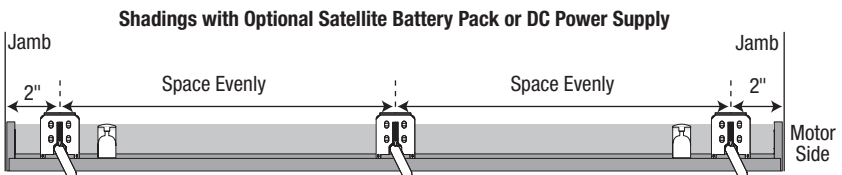
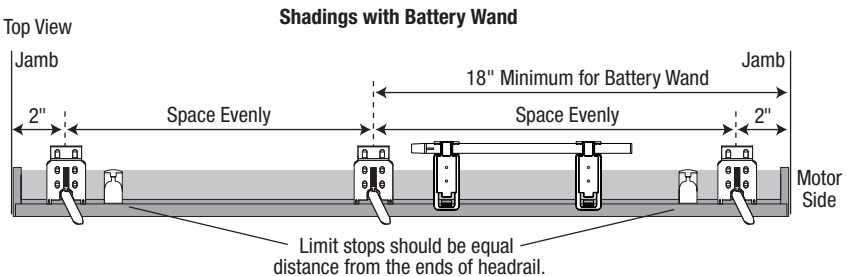

- Center the brackets on your marks, then mark the screw hole locations.

- Refer to the chart below for mounting depth requirements.

Mounting Depth	Minimum	Fully Recessed
Battery Wand & Back Cover	2"	4"
Satellite Battery Pack or DC Power Supply & Back Cover	1 1/4"	3 1/2"

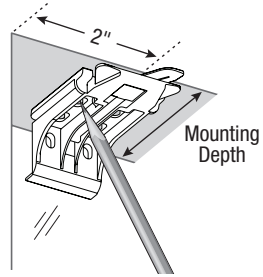

- Use the rear set of holes with shallow mounting depths. Use the front set of holes when depth permits.

IMPORTANT: The front edges of the installation brackets must be level and aligned.



WARNING: Failure to properly align the brackets could result in the headrail releasing from the brackets.

- Drill the screw holes using a 3/32" drill bit.

IMPORTANT: Use drywall anchors when mounting into drywall.

- Use a level to check that the mounting surface is level. Shim the brackets, if necessary. (Use the top tab that was removed from the brackets.)
- Attach the installation brackets using the screws provided.

IMPORTANT: Do not overtighten the screws. Check to ensure the lever can be moved easily side to side. If not, loosen the screws in one-eighth turn increments until the lever can be moved easily.

IMPORTANT: The front edges of the installation brackets must be level and aligned to each other.

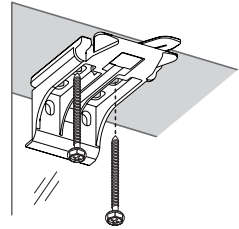

Proceed to "STEP 2 — Install the Shading" on page 10.

INSTALLATION

Mount the Installation Brackets — Outside Mount

Prepare the Installation Brackets

- Use pliers or heavy duty scissors to remove both the top and bottom tabs on the installation brackets.

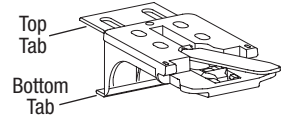

NOTE: Save these tabs once removed. They may be used as shims, as described later in these instructions.

Mount the Installation Brackets

- Center the headrail over the window opening at the desired height. Use a pencil to lightly mark each end of the headrail.
 - Alternatively, measure the width of the headrail and use that width to mark the headrail end points over the window opening.
- Mark 2" in from each of the headrail end marks.
 - If more than two installation brackets came with your order, space additional bracket(s) evenly between the two end brackets and mark their location. Mount into wood whenever possible. **Allow a minimum of 18" from the motor side for the battery wand.**

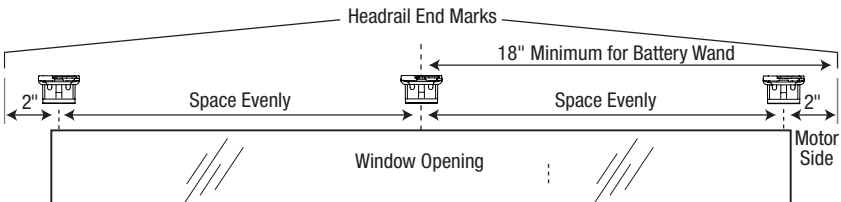

- Center the installation brackets or extension brackets on your marks and mark where to drill the screw holes.
- A minimum $1\frac{1}{8}$ " flat vertical surface is required for the installation brackets. Extension brackets require $1\frac{1}{4}$ ".
- The tops of the installation brackets or extension brackets should be at the desired height. The brackets should be level and aligned.

CAUTION: The rear of the brackets must be flush against a flat mounting surface. Do not mount brackets on curved molding.

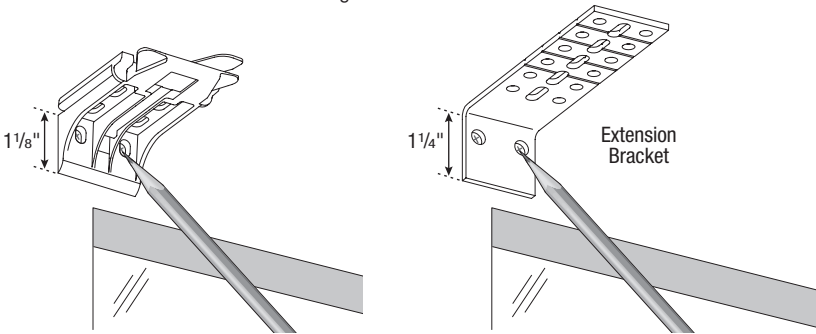

- Drill the screw holes using a $\frac{3}{32}$ " drill bit.

CAUTION: Use drywall anchors when mounting into drywall.

- Attach the installation or extension brackets using the screws provided.

IMPORTANT: If using a battery wand, use a minimum of one $\frac{1}{2}$ " and one $\frac{1}{4}$ " spacer block per installation bracket to provide the clearance required for the battery wand and battery wand bracket.

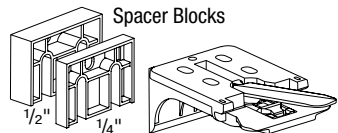

- The solid side of the spacer blocks faces the mounting surface.

IMPORTANT: The tops of the installation brackets or extension brackets must be level with their front edges aligned.

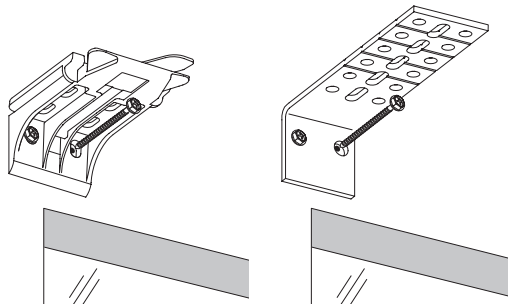

INSTALLATION

- If using spacer blocks, attach the spacer block(s) and installation bracket to a flat vertical mounting surface with #6 screws long enough for a secure installation.

IMPORTANT: Do not add more than 1 1/2" of clearance using spacer blocks.

IMPORTANT: The tops of the installation brackets must be level with the front edges aligned.

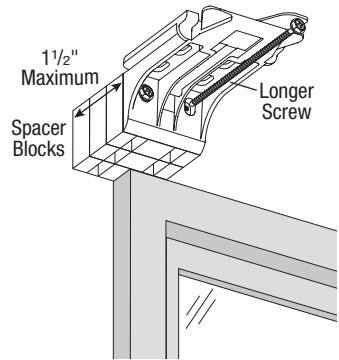

- If using extension brackets, attach an installation bracket to the underside of each extension bracket using the speed nuts and screws provided.

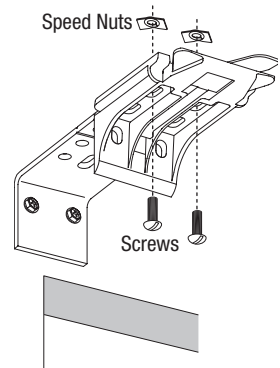

Proceed to "STEP 2 — Install the Shading" on page 10.

Mount the Installation Brackets — End Mount

End mount the headrail when conventional mounting techniques will not work — for example, in an arched window opening.

■ **If using the optional back cover:** Use pliers or heavy duty scissors to remove both the top and bottom tabs on the installation brackets.

- If a satellite battery pack or DC power supply is used, then remove the top tab on the back cover brackets.
- Snap the prongs on the back cover brackets into the holes on the back of the installation brackets.

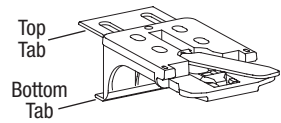

Remove the top tab if using a satellite battery pack or DC power supply.

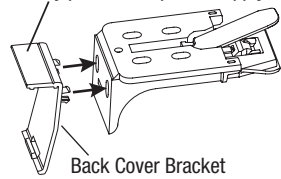

■ Mount the extension brackets on a surface at least 1 1/4" wide.

- Add 1/4" to the minimum depth if using the optional back cover.

■ Attach the installation brackets to the extension brackets using the provided screws and speed nuts.

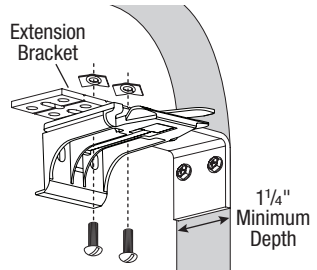

WARNING: To end mount shadings into a surface other than a secure wall stud, use medium to heavy-duty wall anchors (not provided) matched to the wall thickness. Failure to mount the brackets securely may result in injury or property damage.

Proceed to “STEP 2 — Install the Shading” on page 10.

INSTALLATION

STEP 2 — Install the Shading

CAUTION: Take care when handling the antenna wire attached to the motor cartridge. Do not cut or remove this antenna.

- If you have an external eye, plug it into the 3-pin port on the back of the shading. Be sure the plug is oriented correctly. Do not force the connection.
- Position the shading so that the front (colored fabric) faces you.
- Slide the headrail into the installation brackets so the edge of the headrail is between the lever and the bracket, as shown.
- Firmly push the headrail into each bracket until it clicks and the lever snaps to the right side of the bracket.

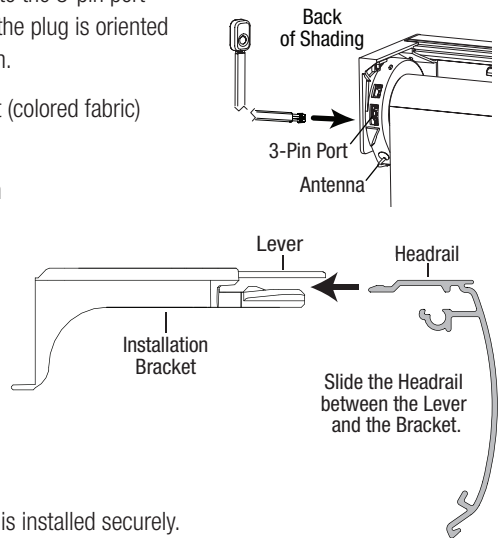

IMPORTANT: Carefully pull on the headrail at each bracket to ensure it is installed securely.

Enhance the Antenna Reception

- Carefully unsnap the antenna from its storage position on the motor cartridge and form it to hang straight down from the shading. This helps increase the signal range for the remote.

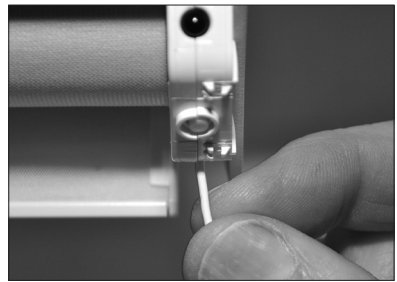
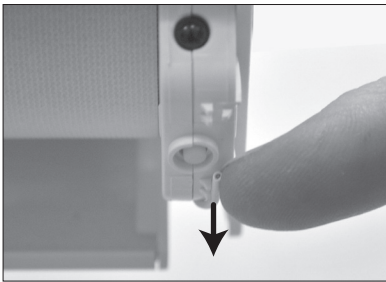

If You Have an Optional External Eye (Infrared Only)...

The plastic of the external eye can be painted. Do not paint the infrared eye.

CAUTION: Handle the external eye carefully to avoid damaging the infrared eye. Do not touch or push the infrared eye.

- Choose a location where the infrared signal from the remote is not obstructed. Check that the wire is not caught or pinched in the brackets or headrail.

IMPORTANT: For infrared operation, do not mount the external eye in direct sunlight or bright, focused light from halogen or fluorescent light fixtures, track lighting, spotlights, or neon lights.

- Break off the back cover from the snap-on front cover.
- Place the back cover at the desired location and mark the screw hole.
- Drill the screw hole using a $\frac{3}{32}$ " drill bit.
- Attach the back cover using the screw provided.
- Place the infrared eye into the back cover with the eye facing out.
- Snap on the front cover with the hole placed over the infrared eye.

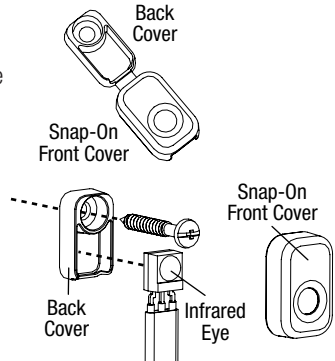

If You Have an Optional Dust Cover (For Outside Mount Shadings)...

The dust cover is used to protect the top of the headrail from exposure to dust on outside mounted shadings.

- Cut the dust cover to desired width.
- Remove the paper backing on one side of the hook and loop fastener dots.
- Apply the dots to the installation brackets on each end of the shading.

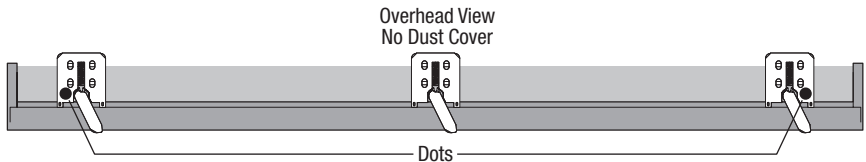
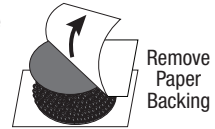

- Remove the remaining paper backing from the dots.
- Center the dust cover over the top of the shading and press it down onto the dots.



INSTALLATION

STEP 3 — Connect the Power Source

- Refer to the appropriate page based on your order.
 - For a battery wand, see below.
 - For an optional satellite battery pack, see page 13.
 - For an optional DC power supply, see page 14.
 - For an optional DC power supply with daisy-chain connections, see page 15.

If You Have a Battery Wand...

Install the Batteries into the Battery Wand

- Squeeze the cap latch to release the cap.
- Remove the cap from the battery wand.
- Install the batteries according to the instructions on the battery wand label.
 - AA alkaline batteries are recommended for use with battery-powered shadings. These will provide approximately one year of operation, depending on usage. Lithium and rechargeable batteries are not recommended.
- Replace the cap.
 - Align the tab with the end of the wand.
 - Press the cap on until it latches.

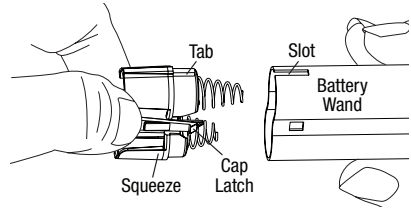

Mount the Battery Wand into the Battery Wand Clips

- Place the battery wand with its socket toward the motor end of the shading.
- Push the battery wand straight up into the battery wand clips until it snaps into place. Check to make sure the battery wand is secure.

CAUTION: Be sure the cables do not become pinched by the battery wand clips during installation. Damage or overheating of components could result.

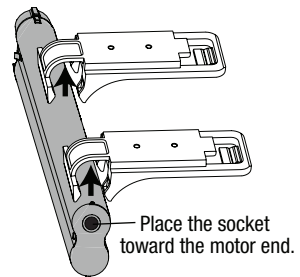

Plug the Power Cable into the Battery Wand

- From the back of the shading headrail, connect the power cable (from the motor side) into the socket on the battery wand.

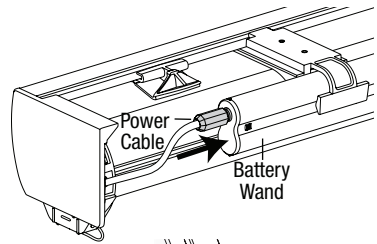

Install the Back Cover (Optional)

- If using a back cover, install it into the back cover brackets, as shown. If necessary, trim the back cover to the desired width.

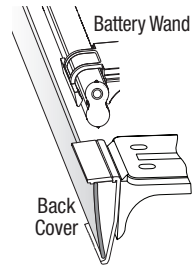

Proceed to “Attach Magnetic Hold-Down Brackets (Optional)” on page 16 or “Operate the Shading” on page 17.

If You Have a Satellite Battery Pack...

Install the Batteries into the Battery Wand

- See the instructions on the previous page.

Mount the Satellite Battery Pack

- Decide where you want to mount the bracket. A satellite battery pack may be mounted in any orientation.
- Mark the screw holes.
- Drill the screw holes using a $\frac{3}{32}$ " drill bit.
- Remove the backing from the double-sided tape. Press the bracket into place.
- Attach the bracket using the screws provided.
- Position the battery wand so the power cable is easily connected to the socket.
- Snap the battery wand into the bracket.

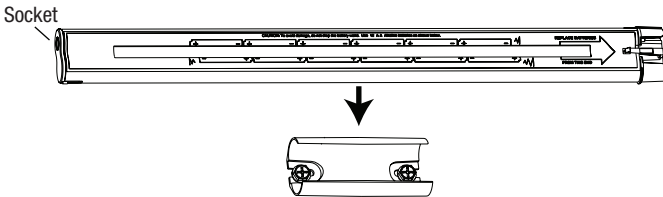
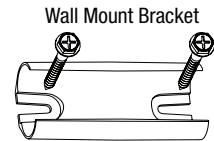

- Replace the cover with the slot aligned to the socket in the battery wand.

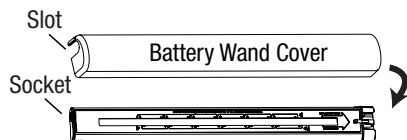

INSTALLATION

- Plug the power cable from the shading into the extension cable.
- Plug the other end of the extension cable into the socket in the battery wand.

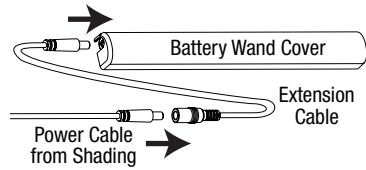

Install the Back Cover (Optional)

- If using a back cover, install it into the back cover brackets, as shown. If necessary, trim the back cover to the desired width.

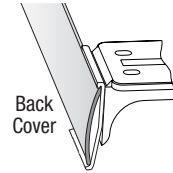

Proceed to “Attach Magnetic Hold-Down Brackets (Optional)” on page 16 or
“Operate the Shading” on page 17.

If You Have a DC Power Supply...

Connect the Power Supply

- Plug the power cable from the shading into the extension cable.
- Plug the other end of the extension cable into the DC power supply.
- Plug the DC power supply into a standard outlet.
- Secure the power supply cable using wire retainers (not supplied). If hiding the cable behind the shading, make sure it does not impede the operation of the shading.
- Space the wire retainers approximately 15" apart along the power supply cable, as shown.

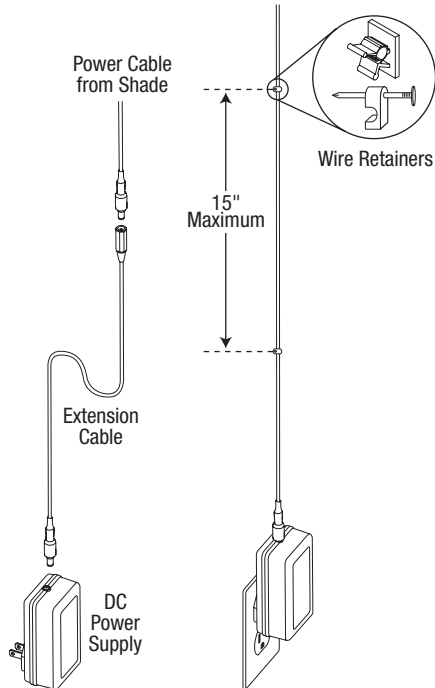

WARNING: Keep cords and small parts out of the reach of children. They can wrap cords around their necks and **STRANGLE**. They can also put small parts in their mouths and **CHOK**.



WARNING: Electric shock and/or a fire hazard may occur, if not properly installed.

Install the Back Cover (Optional)

- If using a back cover, install it into the back cover brackets, as shown. If necessary, trim the back cover to the desired width.

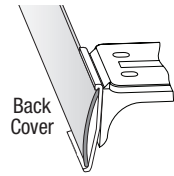

Proceed to “Attach Magnetic Hold-Down Brackets (Optional)” on page 16 or
“Operate the Shading” on page 17.

If You Have a DC Power Supply with Daisy-Chain Connections...

The daisy-chain feature allows up to three battery-powered shadings to be powered by a single DC power supply. However, each shading has its own receiver eye and can operate independently. The daisy-chain feature is only available with the DC power supply option.

- Route the power cables from each shading to the connector, using an extension cable, if necessary.
- Plug an extension cable into the connector and the DC power supply. Two extension cables and two connectors are used for three shadings.

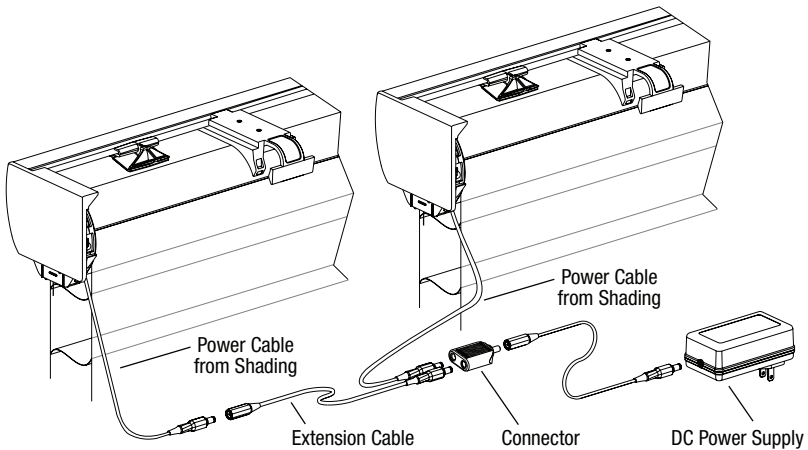

Proceed to “Attach Magnetic Hold-Down Brackets (Optional)” on page 16 or
“Operate the Shading” on page 17.

INSTALLATION

Attach Magnetic Hold-Down Brackets (Optional)

- Lower the shading, keeping the vanes closed.
- Place the magnetic hold-down brackets onto the bottom rail just inside the end caps, oriented as shown.
- Hold the brackets while opening and closing the vanes. (It may be necessary to have someone assist you.) Adjust the brackets to the best overall position.
- Mark the screw location using one of the mounting options shown below.

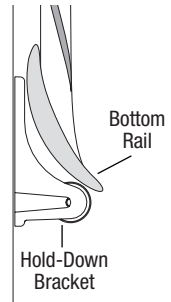

- The screw should be placed in the middle of the channel. This will allow for adjustment.

Outside Mount

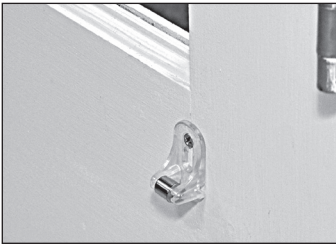

Preferred



Alternate

Inside Mount



Preferred



Alternate

- Drill the screw holes using a $\frac{3}{32}$ " drill bit.

IMPORTANT: Use drywall anchors when mounting into drywall.

- Attach the hold-down brackets to the mounting surface using the screws provided.
- If necessary, adjust the bracket height by loosening the screw and sliding the bracket up or down.

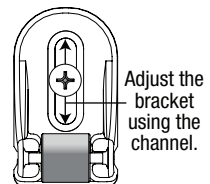

Operate the Shading

Test the Shading Using the Manual Control Button

Testing the shading with the manual control button will allow you to ensure that the motor and power source are working correctly.

- Press the manual control button on the bottom of the motor side end cap to test operation. If the shading does not operate, see “Resetting the Shading” on page 19 or refer to “Troubleshooting” on page 20.

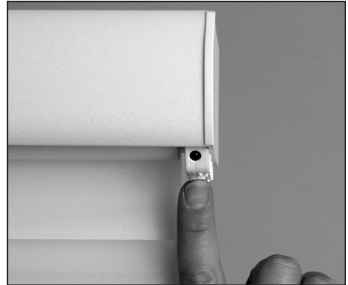

- Press the button to alternately lower, stop, and raise the shading.

CAUTION: When raising the shading for the first time, observe how the fabric rolls up into the headrail. It should roll up evenly. If the bottom rail is not level or the shading starts to rub against either window jamb, immediately press the manual control button to stop the shading. See “Adjust the Bottom Rail Weight” on page 22.

Further Operation and Programming Information

Remote Operation

For information regarding operation and programming of the remote control, refer to your *Remote Control Guide*.



Remote Control Guide



Battery-Powered
Window Shadings

OPERATION

Alternate Push-Button Programming Method (Professional Installation Only)

To Add a Shading to a Group:

- Press and hold the manual control button located at the window covering or on the external eye.
- While continuing to press the manual control button, press the desired group number button, then press the UP ▲ button on the remote.
- The window covering will move slightly to indicate it has been assigned to a group.

To Remove a Shading from a Group:

- Press and hold the manual control button located at the window covering or on the external eye.
- While continuing to press the manual control button, press the desired group number button, then press the DOWN ▼ button on the remote.
- The window covering will move slightly to indicate it has been removed from that group.

Resetting the Shading

If you need to reset the limits:

Basic Reset

- Press and hold the manual control button for 6+ seconds. The shading moves slightly up and down once to indicate that it has been reset. Release the button.
- Press and release the manual control button to close the shading completely. This sets the lower motor limit.
- Press and release the manual control button again to open the shading completely. This sets the upper motor limit.

Factory Reset (Professional Installation Only)

To clear all stops, erase all radio frequency (RF) programming, and reset the shading to factory default:

- Press and hold the manual control button for 12+ seconds. The shading moves slightly up and down twice to indicate that it has been reset. Release the button.
- Press and release the manual control button to close the shading completely. This sets the lower motor limit.
- Press and release the manual control button again to open the shading completely. This sets the upper motor limit.

NOTE: Both upper and lower motor limits have been reset. However, any intermediate stop position is still cleared; and all RF programming has been erased and will need to be set up again.

Troubleshooting

If your shading is not operating correctly:

- First review the guide that came with your remote control.
- Refer to the following troubleshooting procedures for specific solutions for your shading.

Problem	The shading will not fit into the installation brackets.
Solution	<p>Check that the installation brackets are level and aligned. Adjust and/or shim to level, if necessary.</p> <p>Be sure the heads of the mounting screws are flush against the installation bracket.</p> <p>Make sure that the shading fabric is not caught between the installation bracket and the headrail.</p> <p>Check that the headrail is completely inserted into the installation brackets. See “STEP 2 — Install the Shading” on page 10.</p>
Problem	The shading is not responding to the manual control button.
Solution.	<p>Check that the batteries in the wand or satellite battery pack are correctly inserted and are fresh.</p> <p>Check that the battery wand, satellite battery pack, or DC power supply is securely connected to the power cable and the cables are not pinched or caught in the headrail or installation brackets.</p> <p>See the <i>Remote Control Guide</i> for operating or programming troubleshooting solutions.</p>
Problem	The shading is not responding to the remote.
Solution.	<p>Check that the batteries in the remote, wand, or satellite battery pack are correctly inserted and are fresh.</p> <p>Check that the battery wand, satellite battery pack, or DC power supply is securely connected to the power cable and the cables are not pinched or caught in the headrail or installation brackets.</p> <p>See the <i>Remote Control Guide</i> for operating or programming troubleshooting solutions.</p>

Problem	The vanes do not open when the shading is first operated.
Solution	Open and close the shading several times to help open the vanes. If necessary, gently pull down on the bottom rail.
Problem	The bottom rail does not raise or lower completely, or its location when fully lowered has changed over time.
Solution	<p>The batteries may be low in the wand or satellite battery pack. Replace the batteries.</p> <p>Check that the battery wand, satellite battery pack, or DC power supply is securely connected to the power cable and the cables are not pinched or caught in the headrail or installation brackets.</p> <p>Check that there is clearance between the ends of the shading and the window casement on inside mounts.</p> <p>Check if the fabric rolls up evenly into the headrail. If not, see “Adjust the Bottom Rail Weight” on page 22.</p> <p>Reset the stop positions. See “Resetting the Shading” on page 19.</p> <p>See the <i>Remote Control Guide</i> for operating or programming troubleshooting solutions.</p>
Problem	Adjacent shadings do not roll up evenly.
Solution	<p>It is considered normal if the roll-up on both shadings is within $\frac{5}{16}$" of each other. If one shading rolls up tighter than another, lower and raise both shadings several times.</p> <p>Reset the shading. See “Resetting the Shading” on page 19.</p> <p>Check that the shading fabric is not catching on any brackets or components.</p> <p>Check that the fabric winds evenly and does not rub against the headrail. If uneven, see “Adjust the Bottom Rail Weight” on page 22.</p> <p>For a more exact roll-up, use the intermediate stop feature to set a specific height. See the <i>Remote Control Guide</i> for operating or programming troubleshooting solutions.</p>

OPERATION

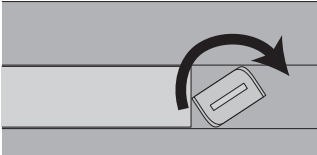
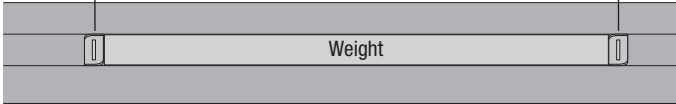
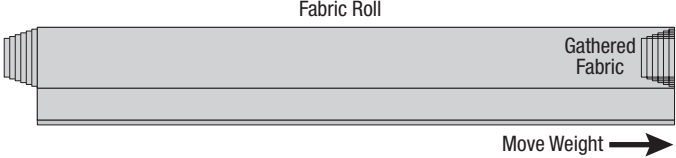
Problem	The shading raises or lowers unevenly, the fabric rubs against one end of the headrail, or the bottom rail is uneven when fully raised.
Solution	<p>Check that the window is square by measuring the diagonals.</p> <p>Check that the installation brackets are level. Shim to level, if necessary.</p> <p>Adjust the Bottom Rail Weight:</p> <ul style="list-style-type: none">■ Release the weight clips by inserting a flat blade screwdriver into the weight clip and turning clockwise.  <p>Weight Clip Bottom Rail Weight Clip</p>  <ul style="list-style-type: none">■ Move the weight in 1" increments toward the side where the fabric is gathering.  <p>Fabric Roll Gathered Fabric</p> <p>Move Weight →</p> <ul style="list-style-type: none">■ Secure the weight clips in position by turning them counterclockwise after making the adjustment.■ Test and, if necessary, adjust again.

Problem	The vanes do not close fully when the shading stops in the lowest position.
Solution	<p>The shading should be programmed to stop in its lowest position with the vanes closed. A small distance between the front and back fabric facings in the fully closed position is normal.</p> <ul style="list-style-type: none"> ➤ If this distance is excessive or moves over time, open the shading to its full “vane open” position and try again. If this does not correct the problem, reset the bottom limit. See “Resetting the Shading” on page 19. ➤ See the <i>Remote Control Guide</i> for operating or programming troubleshooting solutions.
Problem	The shading raises from the sill when the vanes are closed.
Solution	<p>A small gap between the sill and the bottom of the shading is normal in the fully lowered “vane closed” position. The gap is necessary to allow for the unimpeded movement of the bottom rail.</p> <ul style="list-style-type: none"> ➤ If this gap is excessive or moves over time, open the shading to its full “vane open” position and try again. If this does not correct the problem, reset the bottom limit. See “Resetting the Shading” on page 19. ➤ See the <i>Remote Control Guide</i> for operating or programming troubleshooting solutions.
Problem	The front fabric appears to cling to the back fabric.
Solution	<p>Lightly apply a static spray for home furnishings. Follow the manufacturer’s directions.</p> <p>Allow the shading to dry in the fully lowered position.</p> <p>If necessary, reapply the static spray each time the shading is professionally cleaned.</p>

Removing the Shading

- Fully raise the shading.
- Disconnect the power source from the power cable at the back of the shading.
- Move the lever on the installation brackets to the left to release the shading.
 - A flat blade screwdriver can be used to move the lever.
 - If the lever is inaccessible or inoperable, lower the shading until you can see the underside of the bracket. Carefully reach a small flat blade screwdriver behind the shading to the tab on bottom of the bracket between the screw holes.
 - Push the tab away from the shading and pull the headrail to release it from the bracket.

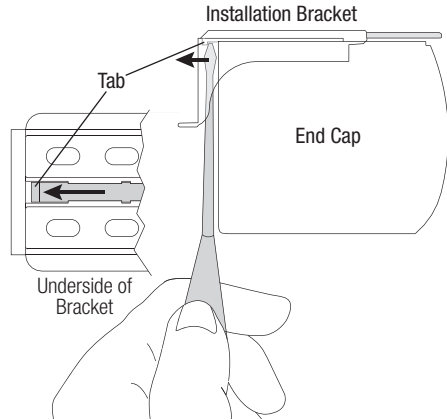
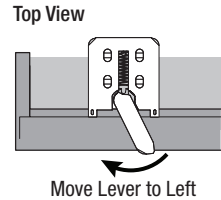

CAUTION: Be very careful not to tear or damage any of the fabric.

- Carefully pull the shading to remove it from the brackets.

Cleaning Procedures

Window Shadings are made of 100% polyester, which means they are inherently durable and resilient. However, care must be taken to avoid wrinkling the fabric, particularly where the vanes meet the facings.

Dusting

- Regular light dusting with a feather duster is all the cleaning that is needed in most circumstances.

Vacuuuming

- Use a low suction, hand-held vacuum for more thorough dust removal.

Forced Air

- Blow away dirt and debris between the vanes using clean compressed air.

Spot-Cleaning

- Do not spot-clean Window Shadings.

Ultrasonic Cleaning

Window Shadings can be ultrasonically cleaned by a professional with the exception of light dimming fabrics.

- Specify that a mild detergent solution be used.
- Never immerse the headrail in the solution.
- Dry the shading completely in the lowered position.

Injection/Extraction

Window Shadings can be professionally cleaned using the injection/extraction method.

- A dry method of injection/extraction is required for light dimming fabrics.
- Never immerse the headrail in the solution.

Electrostatic Cleaning

Do not use electrostatic cleaning wipes on any Window Shadings.

A Note About Fabrics

As with all textiles, Window Shading fabrics are subject to some variations. Slight wrinkling, puckering, or bowing is inherent to this textile product and should be considered normal, acceptable quality. These characteristics are not usually visible from the front or rear but may be visible from a side angle.

Precautions should be taken to reduce exposure to harsh environmental elements, such as salt air. Continuous exposure through open windows and doors will accelerate the fabric deterioration.

LIMITED LIFETIME WARRANTY

Congratulations on Your Selection of a Custom Window Covering.

Because we take pride in our workmanship and quality that goes into every one of our products, we back our products with this:

Limited Lifetime Warranty Covering Our Custom Made Window Coverings

We extend this limited lifetime warranty to the original purchaser. This warranty applies only to battery-powered Custom Products properly installed in the window, door or interior area for which they were intended.

Installation of the product must be in accordance with the accompanying instructions. The product cannot be modified. It is the purchaser's responsibility to maintain and clean the product in compliance with the instructions provided. The product must be used only in the window for which it was purchased.

This warranty covers our product for defects in materials, mechanisms, workmanship, or failure to operate properly.

Any conditions caused by damage to the product resulting from misuse, abuse, direct exposure to salty air or discoloration due to sunlight or the passage of time are NOT covered by this warranty.

This warranty does not apply to conditions caused by normal wear and tear upon this product.

This warranty is exclusive and in lieu of all other obligations, liabilities or warranties. In no event shall we be liable for INCIDENTAL or CONSEQUENTIAL DAMAGES or any other direct or indirect damage, loss, cost, expense or fee. Some states do not allow the exclusion or limitation of incidental or consequential damages, so this exclusion or limitation may not apply to you.

In the event of a defect under this warranty, we will repair or replace the product, at our option, provided it is returned to an authorized dealer.

Our warranty excludes shipping charges and labor costs for removal, measuring and installation. Repairs will be made with like or similar parts.

This warranty gives you specific legal rights, and you may also have other rights, which may vary from state to state.

NOTES: Motorized Systems are warranted for five years from the date of purchase.

This warranty does not apply to commercial orders.

