

**NORMAN**<sup>®</sup>  
SHUTTERS. BLINDS. SHADES.



---

Quality Wholesale Window Coverings  
Contract • Hospitality • Healthcare • Residential

# Brightwood<sup>®</sup> Shutters

Program Reference Guide  
2020

2020 Shutter Revision log



Effective Date	Topic	Section	Note
2020/02/20	Frame Styles, Special Options, Specialty Shapes	e,k,l	<p>e: add content: Default principle: Regarding shutter with horizontal T-post type issue: Horizontal T-Post type will always be the Chamfer T post unless otherwise specified.</p> <p>k: 1.Café Shutters add content: When the height of the framing material (including t-posts) exceeds the panel height, by more than 5", a surcharge will apply.</p> <p>2.Custom Colors add a new custom color deck " Benjamin Moore, Off White Collection M2451888TL"</p> <p>l: add contents for Specialties shutter</p>

## 2019 Shutter Revision log



Effective Date	Topic	Section	Note
2019/01/01	Colors Option Louvers Options Frame Options	All except j&o	2019 updated specification
Middle of January 2019	Motorized	o	2019 updated specification
2019/01/10	Track	j 2	Add 3" louver for Open bypass
2019/02/01	Color	e,i,m,n	Add 6 new hinge colors Change color coordination chart
2019/02/01	stile	c	Add stile options Optional: Chamfer stile
2019/02/27	Side magnet	i	Add notes: if panels only with side magnets and there is no standard magnet on the back of panels, panels may open for external factors.
2019/03/01	tracks	j1, j2	2016 stopper Change Note: Bifold track: For 90° Floating Panels outside mount/semi-inside mount without side boards <del>but with fascia return</del> , the 2016 Stopper will be supplied by default. The gap between the fascia return / end of top track and the panel is 5mm each side. Bypass track: 1 · Note: For Semi-Inside/OM bypass without side boards <del>but with fascia return</del> , 2016 Stopper will be supplied. 2 · Note: For outside mount/semi-inside mount bypass without side boards <del>but with fascia returns</del> , the 2016 Stopper will be supplied by default. The gap between the fascia return / end of top track and the panel is 5mm each side.
2019/03/13	New PerfectTilt RF	O/k/j2	O: Revise Norman Dial (Remote) Dimensions : 68mm diameter x 21mm K: remove <del>Available in January 2017.</del> j2: 2016 Track Shutters-Bypass
2019/03/16	New PerfectTilt RF	O	Add comments of PerfectTilt G4 & groups

## 2019 Shutter Revision log



2019/04/09	surcharge notes	b,e,g,i,k,l	<b>Change notes from</b> *Surcharge applies. Please see Options and Surcharges page for details <b>to</b> *Some surcharges apply <b>on the bottom of a page</b>
2019/04/27	New PerfectTilt RF	o	Hub note: change "It will be available in March 2019" to "It will be available soon"
2019/04/30	Custom color	k	Update custom color booklet name
2019/05/06	Hardware-pole	i	Pole remove pole length 43"
2019/05/09	Custom T post	e	move Custom T post comment near to T post drawing
2019/07/10	New PerfectTilt RF		Change Micro USB cable usage.
2019/07/15	New PerfectTilt RF		1. Remove the O section, and that motorization is now in a separate program binder; 2. Add Micro USB Cable Length: 3 meters;
2019/07/27	Specialty Shutters	l	<b>Change the drawing of Standard unit with horizontal arch center</b>
2019/08/05	Custom T post, S1 and S2 Scribe trim	e	1. Add content for Custom T post: <ul style="list-style-type: none"> <li>▪ Size limits (7 1/2")</li> <li>▪ Available for composite but it will be made from wood</li> <li>▪ That a surcharge applies and customers should refer to their shutter pricing</li> <li>▪ Any limitations</li> </ul> 2. Add drawing and description of the S1 and S2 Scribe trim
2019/08/05	Direct Mount 3" Hinge , Pole	i	1. Add comment: Direct Mount 3" Hinge is not suitable for drywall installations. 2. Increase 1 pole length (2pcs combined by connector).
2019/08/14	Specialty Shutters, Shutter pole	i, l	1. Rounding new added pole length to 53" (2pcs combined by connector). 2. Add Specialty Shutters drawings

2019 Shutter Revision log



2019/08/26	quarter round scribe trim	e	Add quarter round scribe trim (made in wood)
2019/08/30	Table of Contents , Colors & Louver Sizes/Louver Clearance, Hardware,	b,i,n	<ol style="list-style-type: none"> <li>1. Revise the table of contents information, rename point b</li> <li>2. i: Remove Oil-Rubbed hinge color information</li> <li>3. i: Revise "Nickel" hinge color to "Nickel Plated", revise color coordination chart</li> <li>4. i: Remove shutter pole length 32"</li> <li>5. Remove n section, and that information will be in b&amp;i sections</li> </ol>
2019/10/05	Tilt rods; General product specification; Bifold track	f,g,j1	<ol style="list-style-type: none"> <li>1) Revise Split tilt information.</li> <li>2). Add Content: <b>Shutters without bottom supports</b>  Shutters without bottom supports may sag and deform, including situations below: <ol style="list-style-type: none"> <li>1. Shutters with bottom gap over 0.1";</li> <li>2. Shutters with no frame or no existing sill at the bottom to support the panel (or bottom has frame/existing sill, but the panel keep to open long time without bottom support).</li> </ol> </li> <li>3). Revise track drawing ( correct 1 1/2" louver to 2 1/2")</li> </ol>
Middle of October	1.6" sill plate with 3/8" light block, 1.6" sill plate with 5/8" light block,	e	Use new 1.6" sill plate with 3/8" light block to replace 1.5" sill plate with 3/8" light block, use new 1.6" sill plate with 5/8" light block to replace 1.5" sill plate with 5/8" light block
2019/10/23	1.6" sill plate with 3/8" light block, 1.6" sill plate with 5/8" light block,	e	For all deco frames and L frames with 1/4 Light Block: Use new 1.6" sill plate with 3/8" light block to replace 1.5" sill plate with 3/8" light block, use new 1.6" sill plate with 5/8" light block to replace 1.5" sill plate with 5/8" light block.

2019 Shutter Revision log



2019/11/01	Invisible hinge, Panel Lock position, Shutter pole	i	<ol style="list-style-type: none"> <li>1. Invisible hinge: add Invisible hinge drawing, update point2 description</li> <li>2. Panel Lock position: add drawings of L/R/LR panel configuration</li> <li>3. Update New pole lengths (2pcs Combined by Connector): Poles will be with Plastic Tube.</li> </ol>
2019/11/07	Ring Pull	i	<p>Add content:</p> <p><b>Ring pull location principle for Floating Panels:</b></p> <ol style="list-style-type: none"> <li>1. When floating panel config is in pairs, it will be split into halves, the left will be for LL and the right will be for RR. So the ring pull location for FF/FF, FF/FF/FF/FF will be same as that of panel config as LL/RR, LL/LL/RR/RR.</li> <li>2. When floating panel config is FF, the ring pull location will be same as that of panel config LL.</li> <li>3. When floating panel config is FFFF/FF, the ring pull location will be same as that of panel config LLLL/RR.</li> <li>4. When floating panel config is singular, it will be split into 3 sections, the left and mid sections are for LL and the right section is for RR. So the ring pull location for FF/FF/FF, FF/FF/FF/FF/FF will be same as that of LL/LL/RR, LL/LL/LL/RR/RR.</li> </ol>
2019/12/01	Custom Colors	k	Revise Custom Colors information
2019/12/05	Slim Fit Posts	e	<p>Add content:</p> <p>Note: Due to size and weight limitations, Slim Fit Posts may only be hinged on one side and with a single panel (no bi-folded panels). Please consider this when determining panel configuration.</p>

<u>Table of Contents</u>	<u>Page</u>
a. Features & Benefits	BW a-1
<b>b. Colors &amp; Louver Sizes/Louver Clearance</b>	BW b-1
c. Stiles	BW c-1
d. Panel Configurations	BW d-1
e. Frame Styles	BW e-1
f. General Product Specifications	BW f-1
g. Tilt Rods	BW g-1
h. Divider Rails	BW h-1
i. Hardware	BW i-1
j. Track Shutters	BW j-1
k. Special Options	BW k-1
l. Specialty Shapes	BW l-1
m. Pricing	BW m-1
<del>n. Appendix</del>	<del>BW n-1</del>

## Features and Benefits

- Enhance view with extremely wide panels. Up to 42" in width for each single panel to create the clean, streamlined look.
- Reinforced engineered stile-- Multiple layers of wood bonded together to reinforce durability to the core of the stile, which results in a robust support system for the shutter panel.
- Employs mortise and tenon joinery that resists shear and racking forces endured by shutters to ensure prolonged quality and durability.
- Quick and easy on-site assembly and installation with the pre-installed magnets and hinges, pre-mitered frames and slotted keyholes.
- Special panel and frame design that is custom cut to accommodate every unique windows.
- Personalize shutters with special options. Choose from fixed louvers, center or offset tilt rod, double hung panels, café shutters, track systems, French door cutout, specialty shapes and many more.
- A guarantee of Norman Shutters exemplary quality with a lifetime limited warranty on materials and workmanship.



## Colors & Louver Sizes/Louver Clearance

Color ID	Color Name
001	Pure White
002	Extra White
003	Silk White
004	Bright White
006	Pearl
007	Ivory Lace
009	Creamy
012	Crisp Linen
016	Butter
019	String
030	Moondust
032	Sea Mist
042	Hall Gray
046	Ice
048	Chai
049	Stone Gray
051	Brown Gray
053	Clay
063	Decorators White
066	Winchester White 2010
073	Sky Gray
074	Element Gray
075	Storm Gray
077	Dawn
078	Cloud Blue
080	Taupe Gray
836	Classic Black

\*Some surcharges apply

BW b-1

Louvers	
Elliptical	1 7/8"
	2 1/2"
	3"
	3 1/2"
	4 1/2"

Louver Depth Clearance

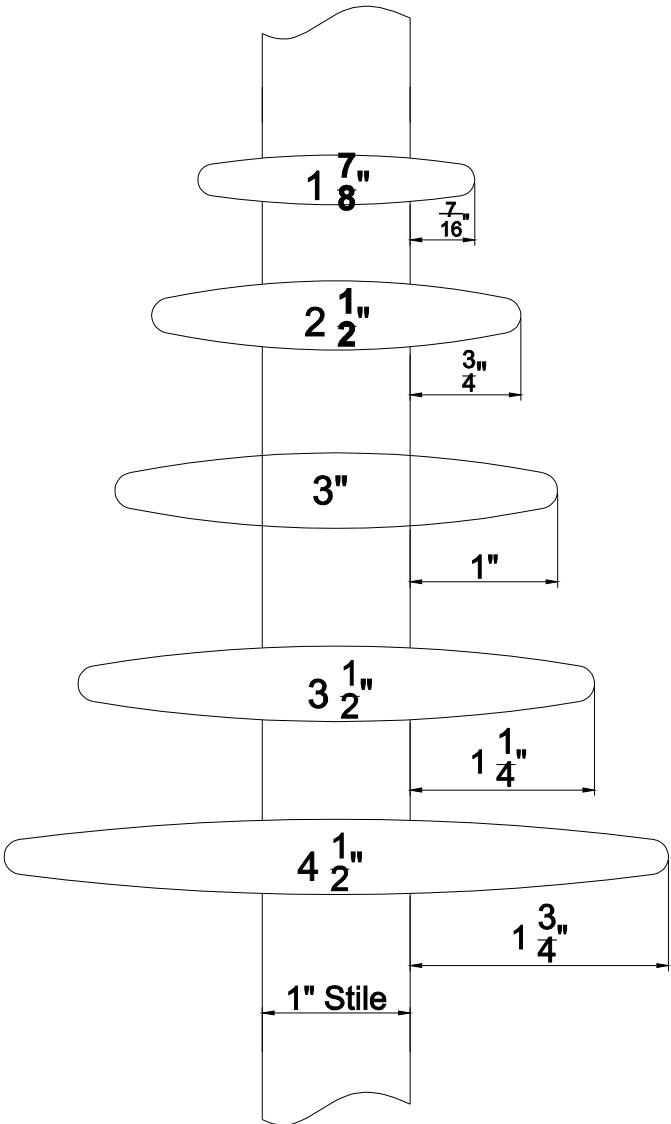

\*Some surcharges apply

# Louver Depth Clearance for Specific Frames

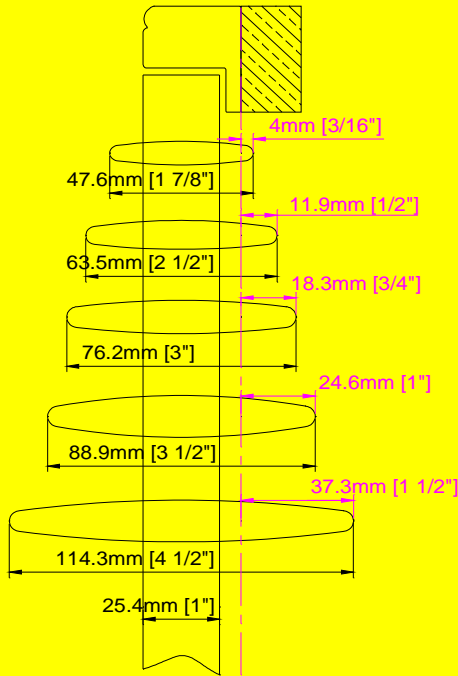

L Frame with 1/4" light block

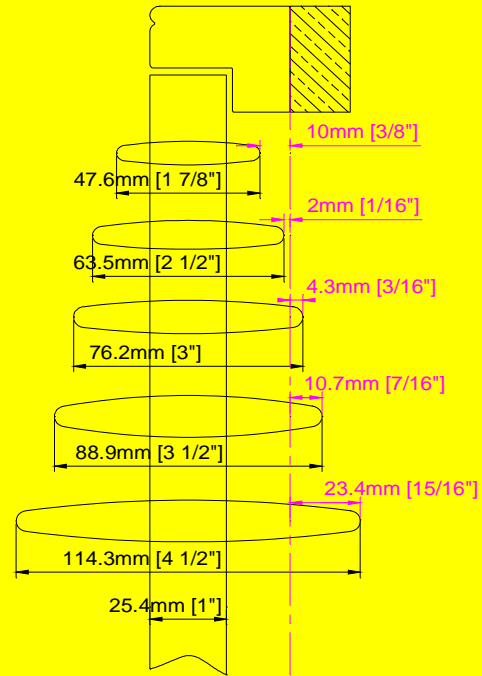

L Frame

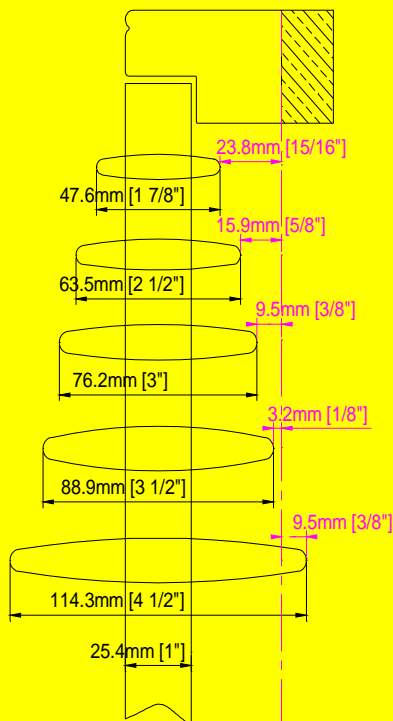

L Frame with 1/2" Buildout

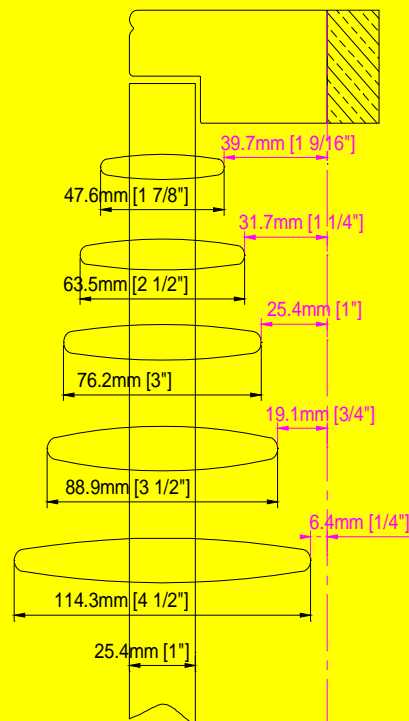

L Frame with 1" Buildout

\*Some surcharges apply

BW b-3

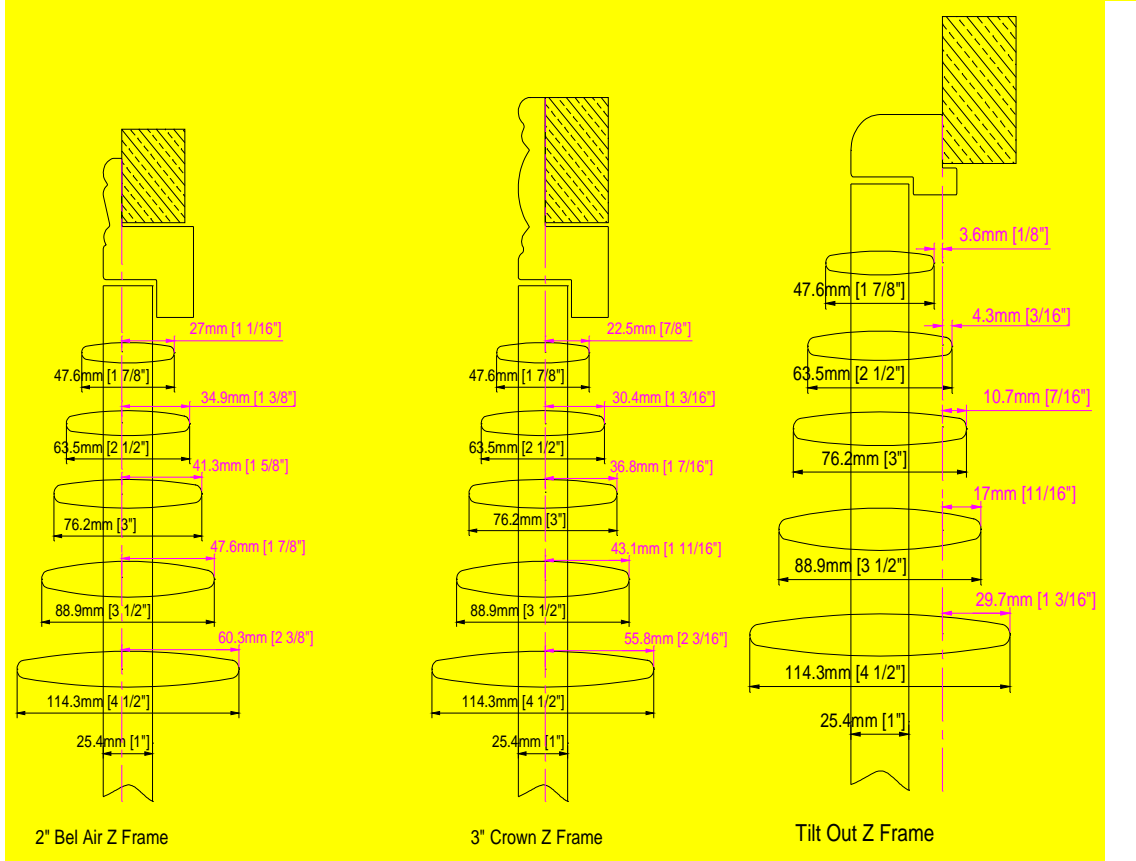
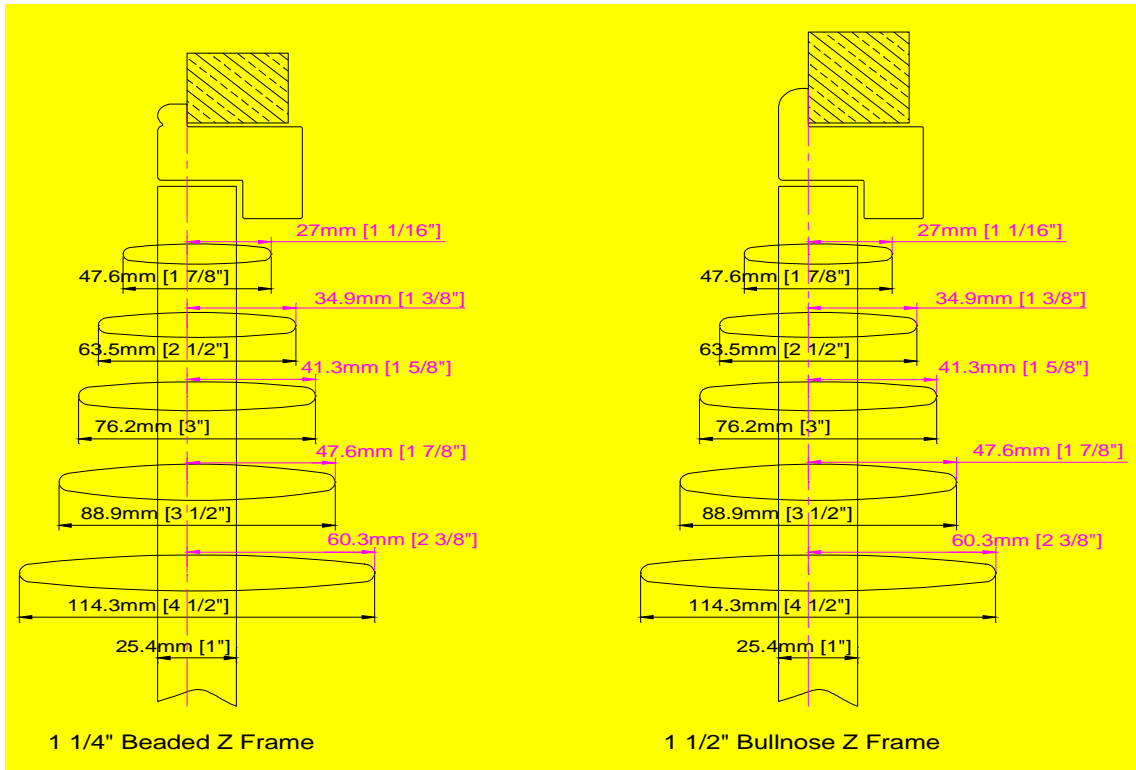

\*Some surcharges apply

BW b-4

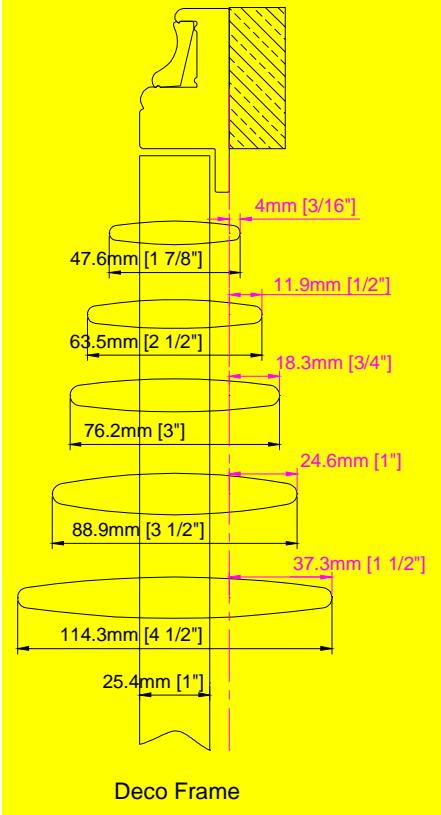
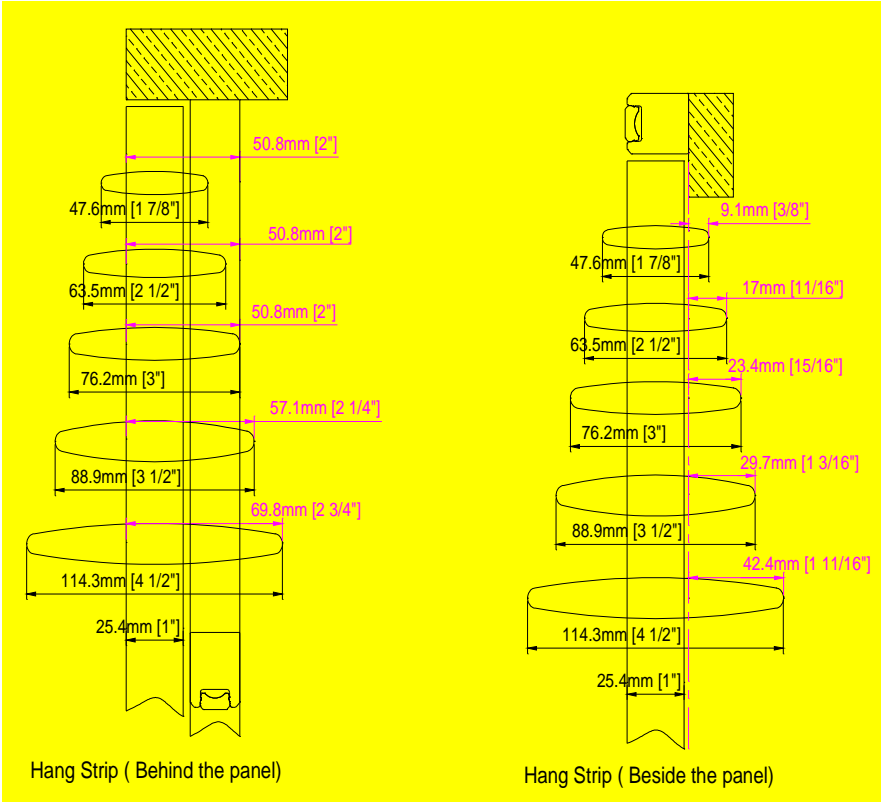

\*Some surcharges apply

# Stiles

## Default: Beaded stile

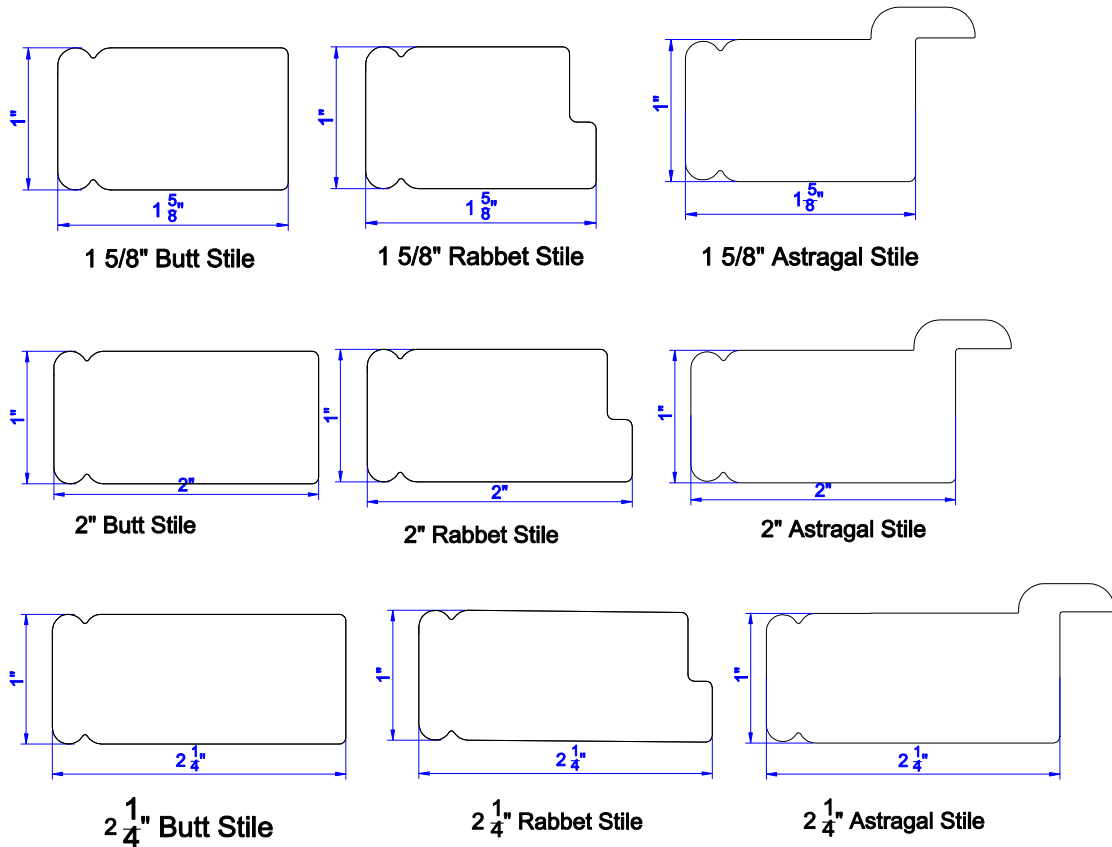

## Optional: Chamfer stile

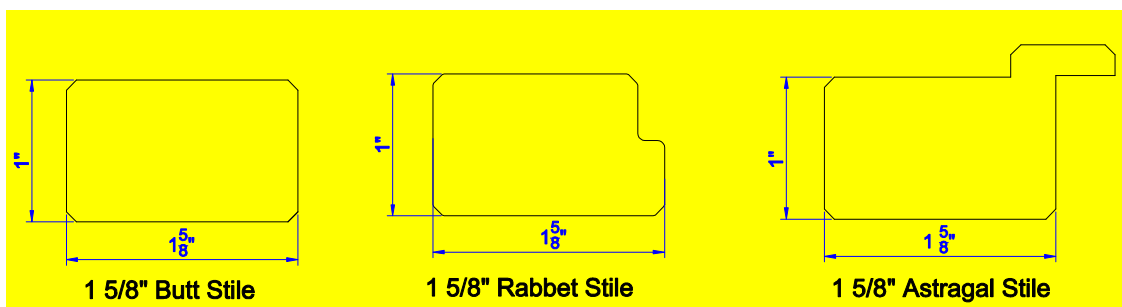

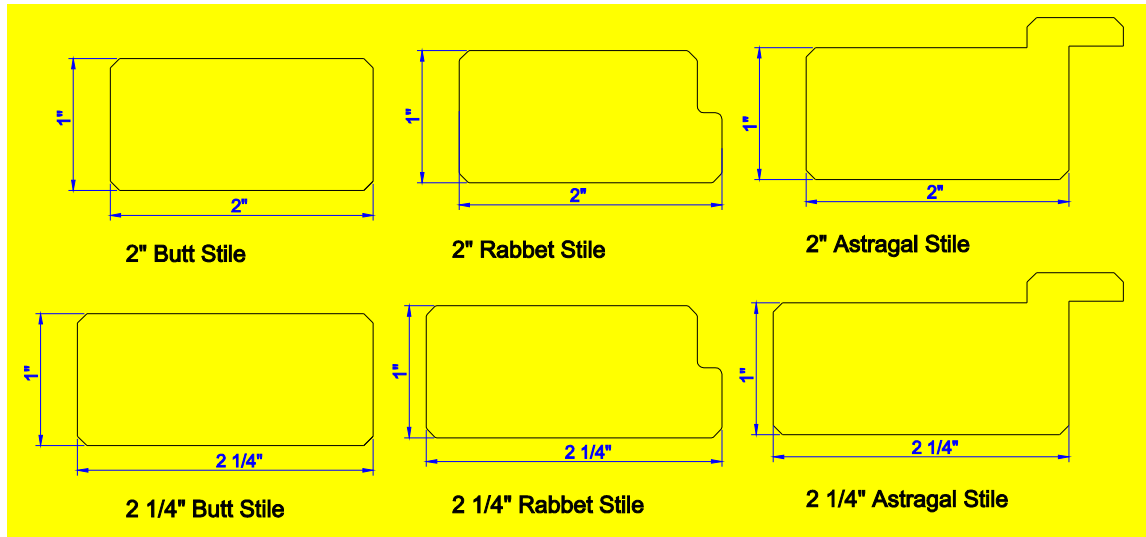

## Stiles (continued)

### Stile between panel closure

#### Single panel

- I) Panel width < 9"
- Rabbeted stile (Deco frame, L frame, Z frame and Hang strip beside panel)
    - 1 <sup>5</sup>/<sub>8</sub>"
    - 2" (default)
    - 2 1/4"
  - Butt stile only (Hang strip behind panel)
    - 1 <sup>5</sup>/<sub>8</sub>"
    - 2" (default)
    - 2 1/4"
- II) Panel width ≥ 9"
- Butt stile only
    - 1 <sup>5</sup>/<sub>8</sub>" ( Optional for panel width ≤ 12" )
    - 2" (default)
    - 2 1/4"

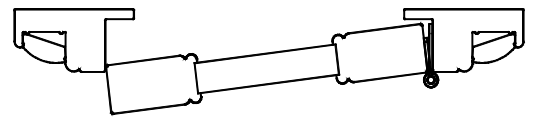
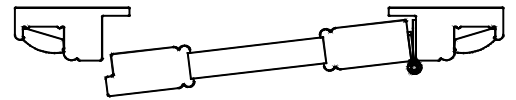

#### 2 panels or more

- Rabbet stile
  - 1 <sup>5</sup>/<sub>8</sub>" ( Optional for panel width ≤ 12" )
  - 2" (default)
- Astragal stile
  - 1 <sup>5</sup>/<sub>8</sub>" ( Optional for panel width ≤ 12" )
  - 2"
  - 2 1/4"



# Panel Configurations

## Single Panel

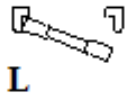

L

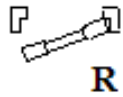

R

OR

## Two Panels



LR



LL



RR

## Three Panels



LLR

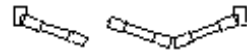

LRR

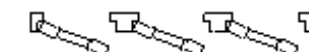
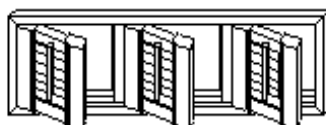

LTLTL

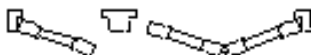
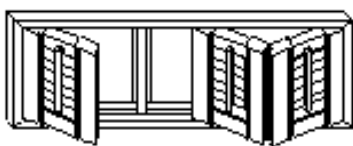

LTRR

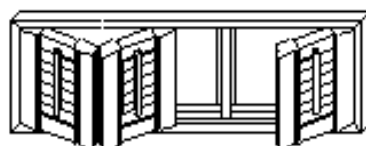

LLTR

## Panel Configurations (continued)

### Four Panels

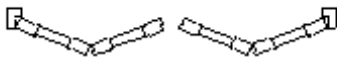
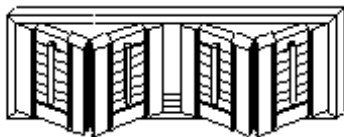

**LLRR**

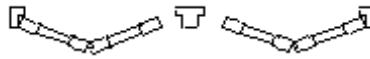
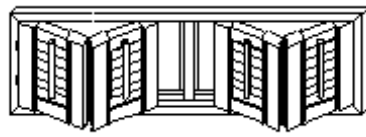

**LLTRR**

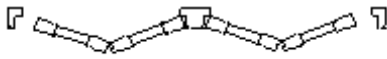
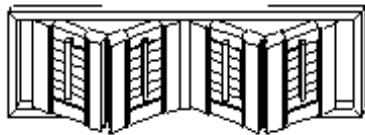

**RRLL**



**LTLRTR**

### Six Panels



**LRTLRTL**

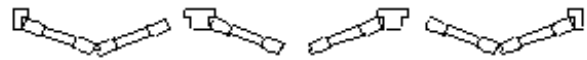

**LLTLRTRR**

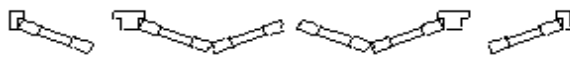
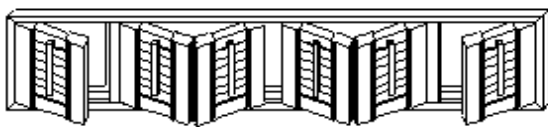

**LTLRRTR**

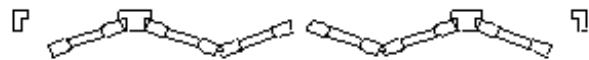

**RTLRLRTL**

## Panel Configurations - Astragal Stile

- 2 Panels - LR

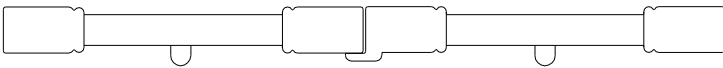

- 3 Panels - LRR

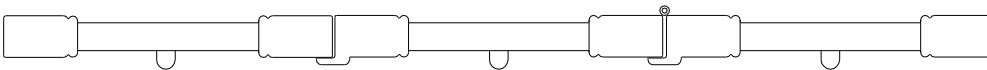

- 3 Panels - LLR

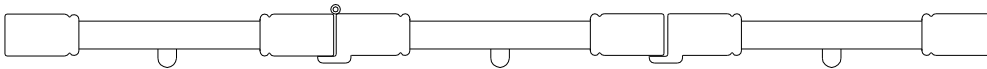

- 4 Panels - LLRR



## Frame Style

Frame material: Woodlore Plus

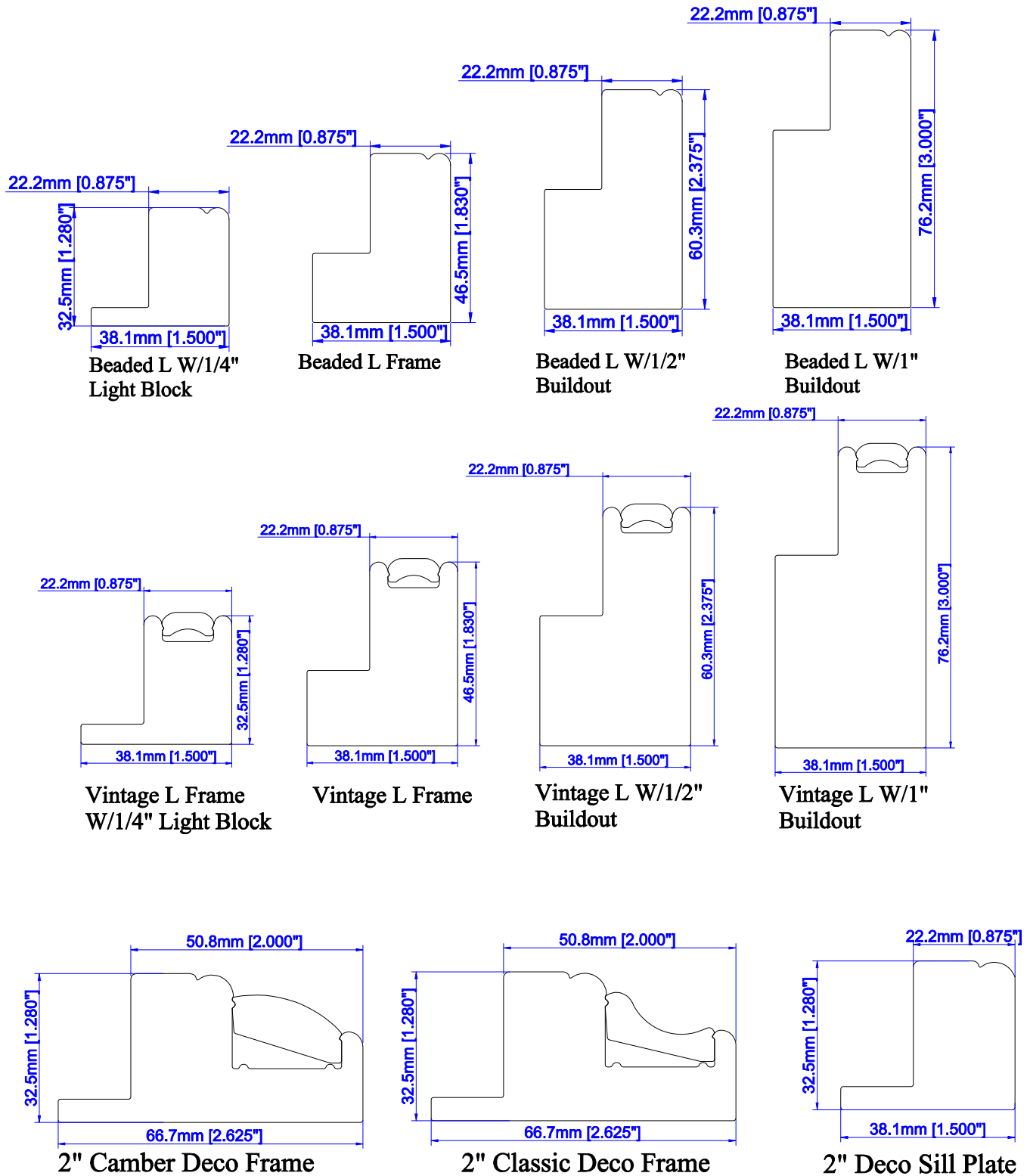

\*Some surcharges apply

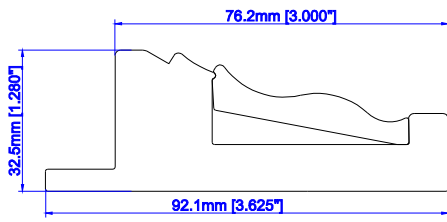

3" Ridge Deco Frame

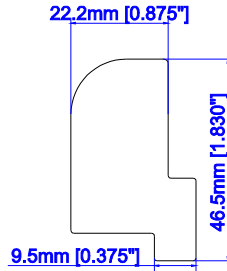

Tilt Out Z Frame

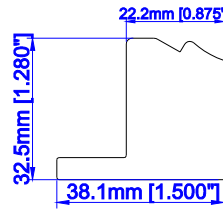

Ridge Deco Sill Plate

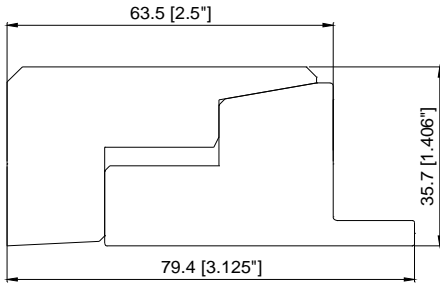

2.5" Mission Deco Frame

There are 2 options for the Deco frame installation when Window Size is given (Take Camber Deco frame as an example)

1. Default: light block part install into the window opening;

The window size is the exact size of the window opening;  
The MFF size is the measurement of the entire shutter, including the frames;  
The MFF size = Window Size + Face Width

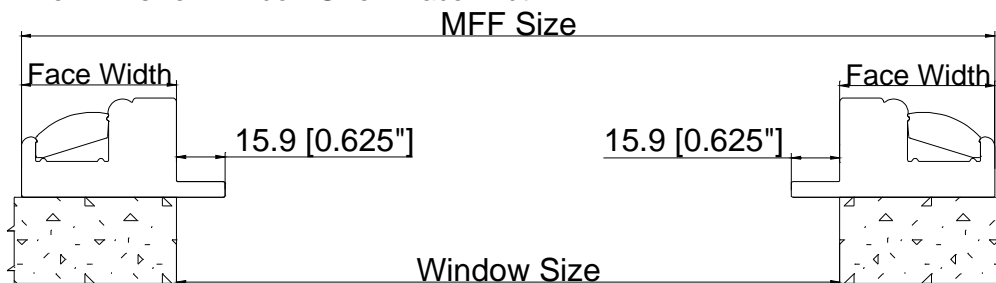

2. Optional: light block part flush with window opening.

The window size is the exact size of the window opening;  
The MFF size is the measurement of the entire shutter, including the frames;  
The MFF size = Window Size + Frame Back Width



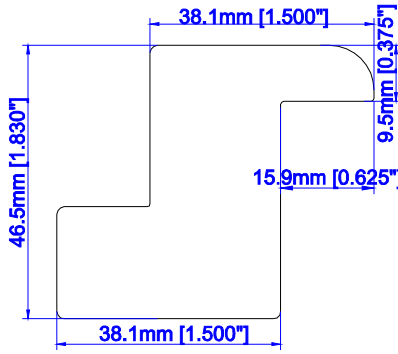

1 1/2" Bullnose Z Frame

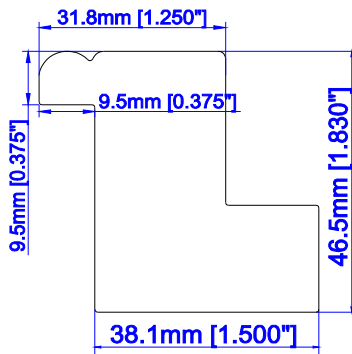

1 1/4" Beaded Z Frame

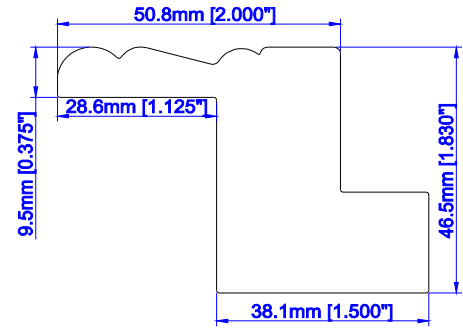

2" Bel Air Z Frame

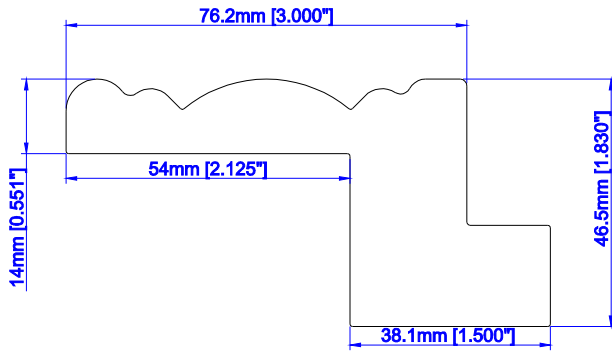

3" Crown Z Frame

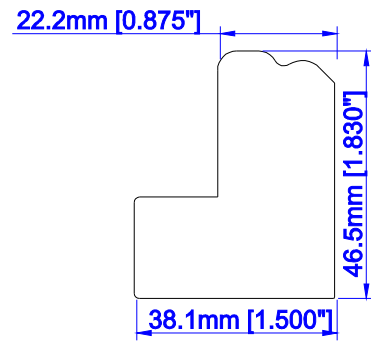

3" Crown Z Sill Plate

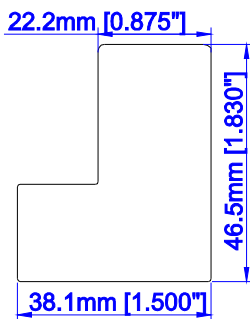

Bullnose Z  
1 1/4" Beaded Z  
Sill Plate

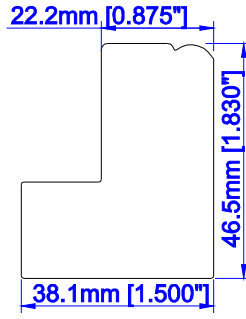

2" Bel Air Z Sill Plate

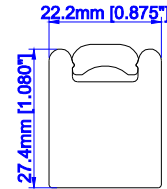

Vintage Hang Strip

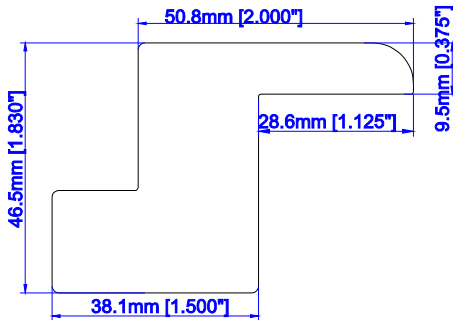

2" Bullnose Z Frame

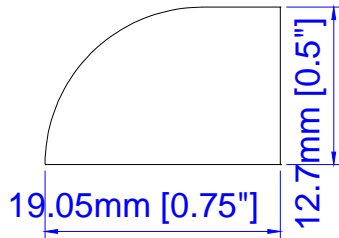

Quarter Round  
Scribe Trim

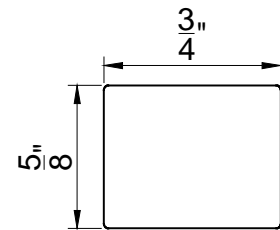

Light Block

Note: Quarter Round Scribe Trim will be made in Wood.

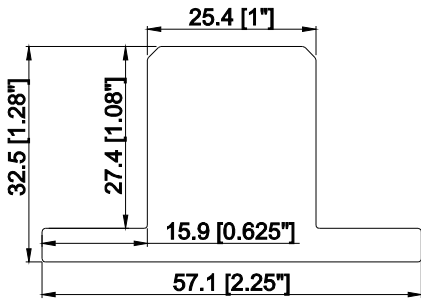

1" Chamfer T Post W/ 1/4" Light Block (Deco)

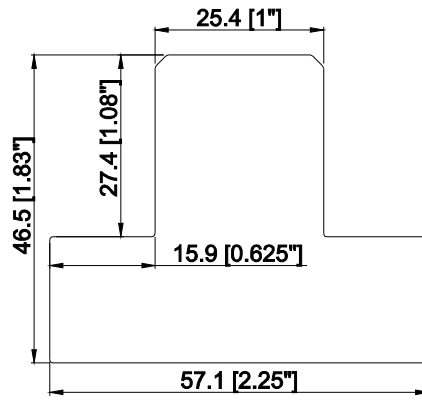

1" Chamfer T Post W/ 3/4" Light Block (L/Z/HS)

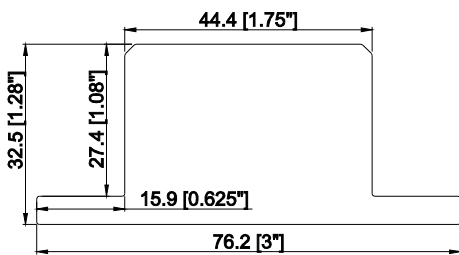

1.75" Chamfer T Post (Deco)

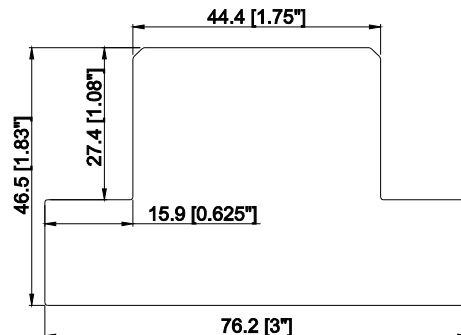

1.75" Chamfer T Post (L/Z/HS)

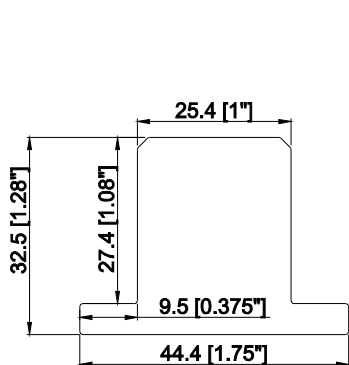

1" Chamfer T Post W/ 1/4" Thick 3/8" Wide Light Block (Deco)

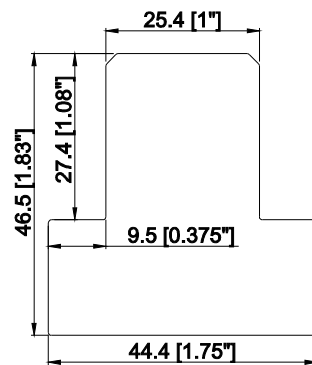

1" Chamfer T Post W/ 3/4" Thick 3/8" Wide Light Block (L/Z/HS)

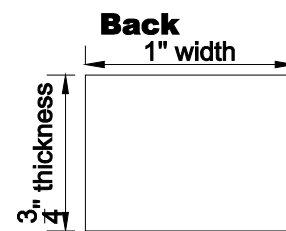

1" \* 3/4" Post (No light block)

- Custom width\* up to 7½" for T Posts (Made of Wood)
  - Size limits (7 1/2")
  - Available for composite but it will be made from wood
  - That a surcharge applies and customers should refer to their shutter pricing
  - Any limitations

\*Some surcharges apply

Note: The 1"x3/4" Post (No Light Block) is only available for Direct Mount. And no hardware will be supplied to install it on the existing window opening.

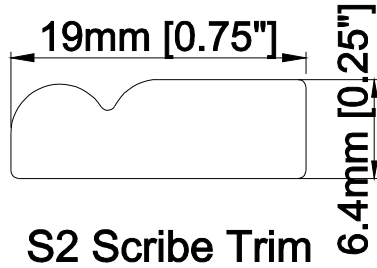
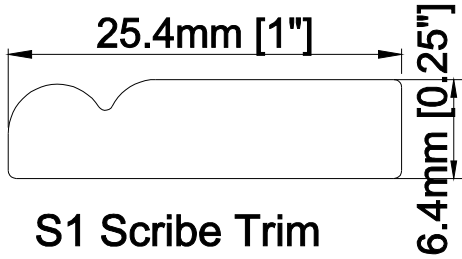

Note: S1&S2 Scribe Trim will be made of wood.

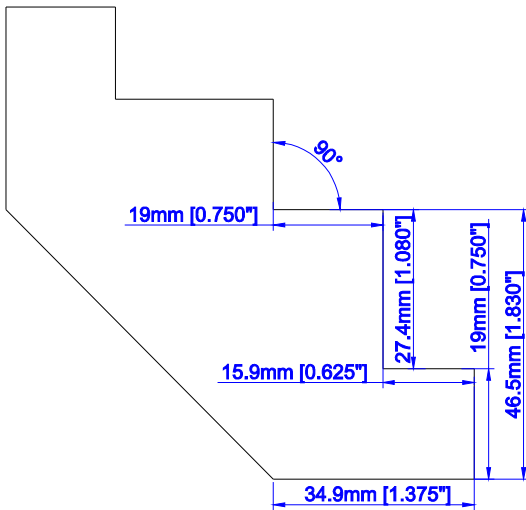

**Corner Post W/ 3/4"  
Light Block (L/Z/HS)**

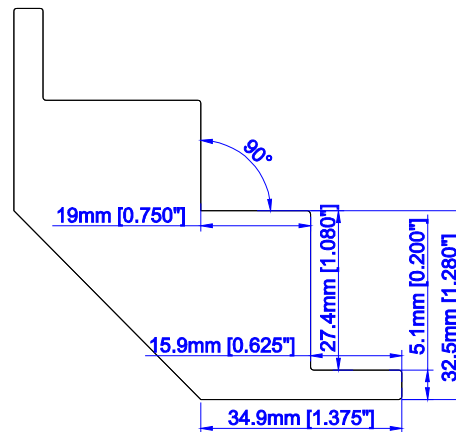

**Corner Post W/ 1/4"  
Light Block (Deco)**

\*Notch out corner post required if ordering Z Frame with solid drywall corner.

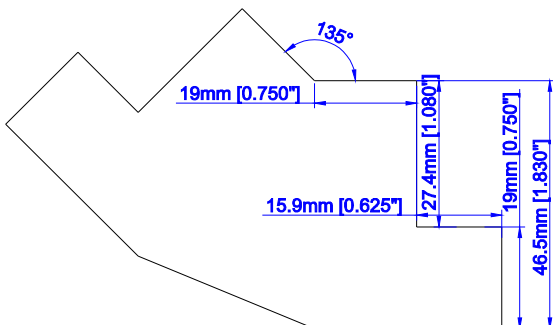

**Bay Post W/ 3/4"  
Light Block (L/Z/HS)**

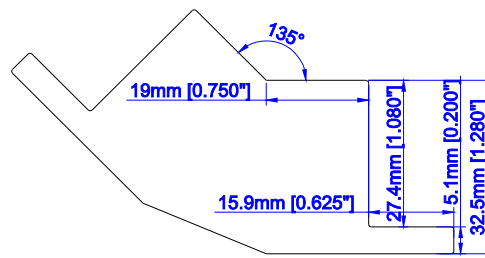

**Bay Post W/ 1/4"  
Light Block (Deco)**



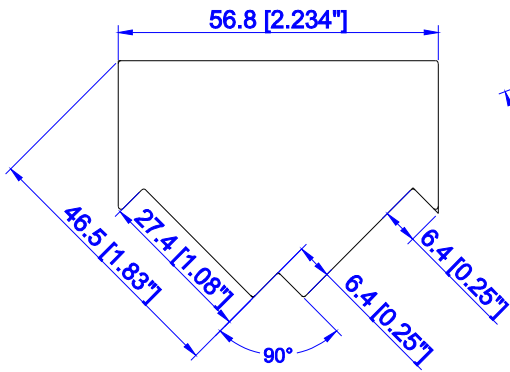

Slim Fit Corner Post for  
90 Degree (L/Z/HS)

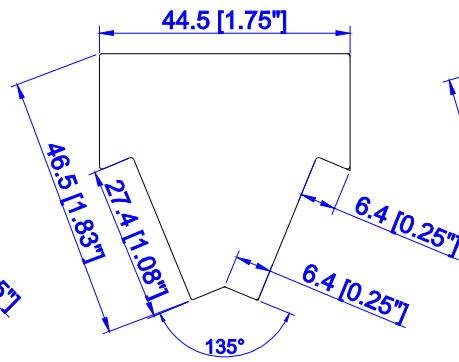

Slim Fit Bay Post for  
135 Degree (L/Z/HS)

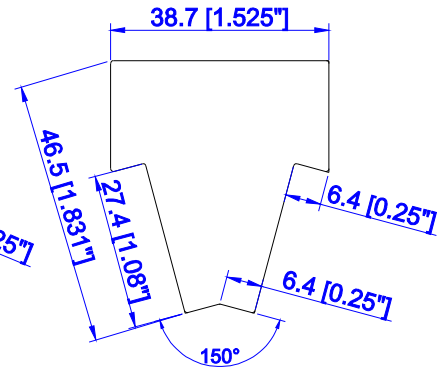

Slim Fit Bay Post for  
150 Degree (L/Z/HS)

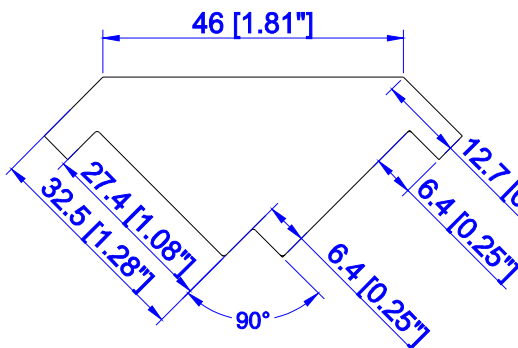

Slim Fit Corner Post for 90 Degree (D)

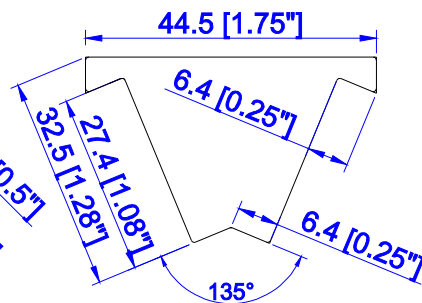

Slim Fit Bay Post for 135 Degree (D)

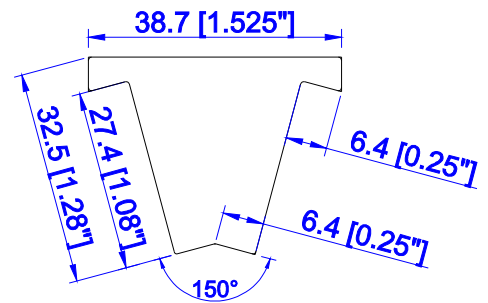

Slim Fit Bay Post for 150 Degree (D)

Note: Due to size and weight limitations, Slim Fit Posts may only be hinged on one side and with a single panel (no bi-folded panels). Please consider this when determining panel configuration.

Also available

- Custom angle bay posts\* (Made of Wood)

#### For bay window at 170 degree or above

- 1" T Post with 3/8" light block will be used as Bay post;
- For Hang Strip (Behind Panel), bay post will be used.

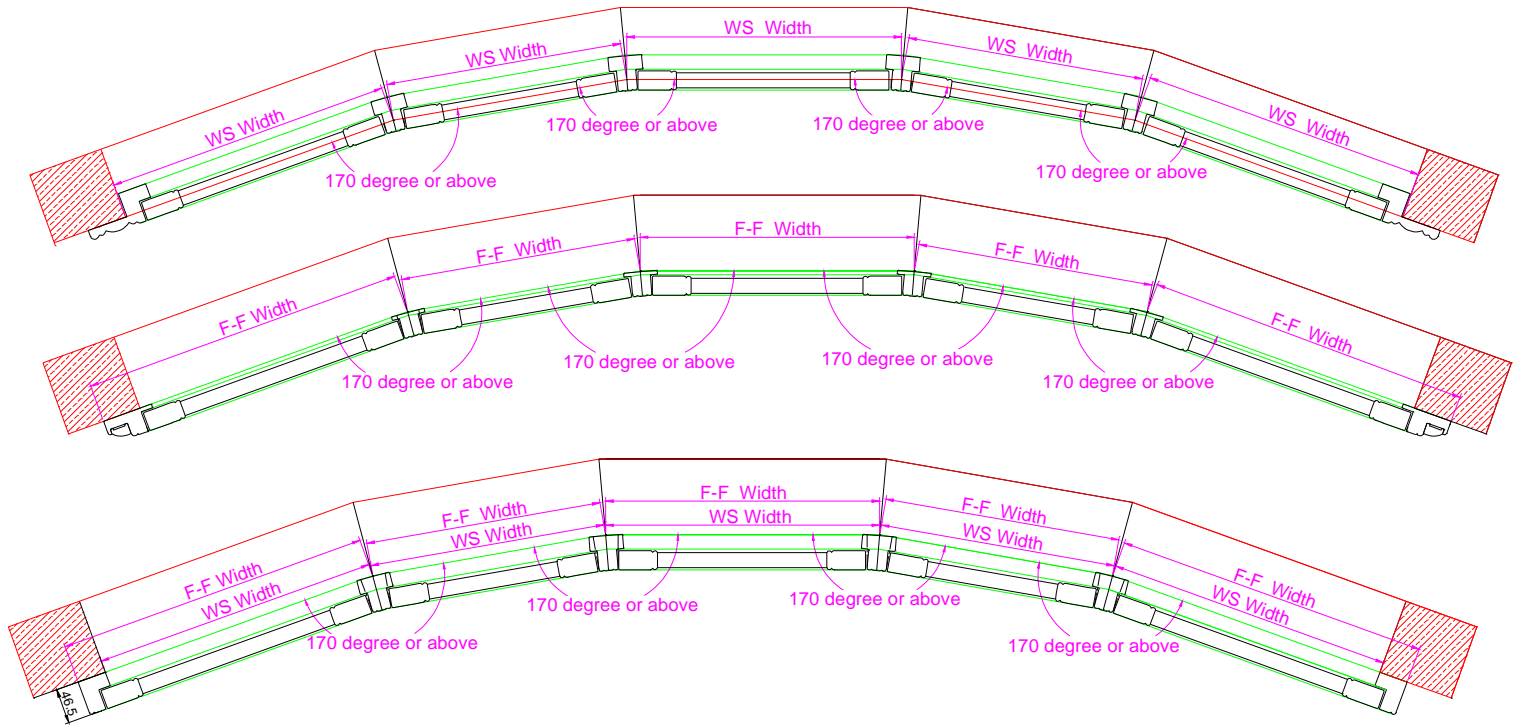

**Sill Frames- For use where there is no existing sill**

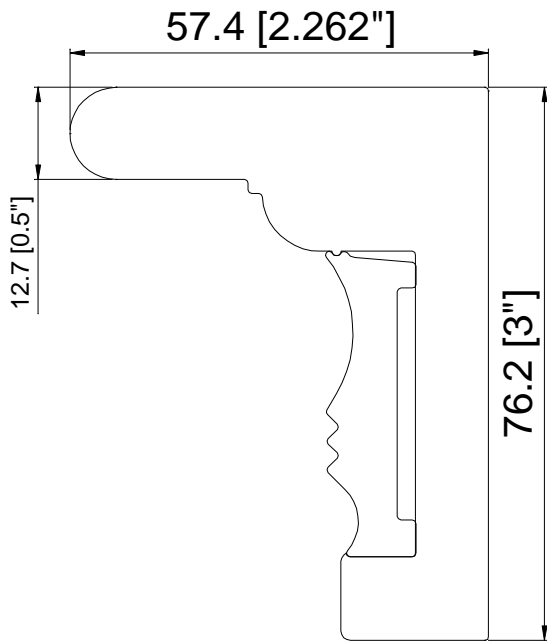

**3" Deco Sill Frame**

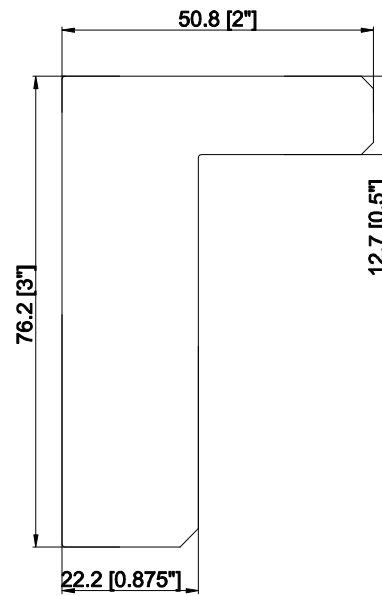

**Mission sill Frame**

Sill Caps-Used to cover existing sills

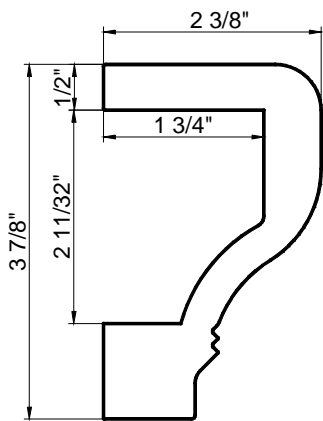

Curved Designer Sill Cap (L)

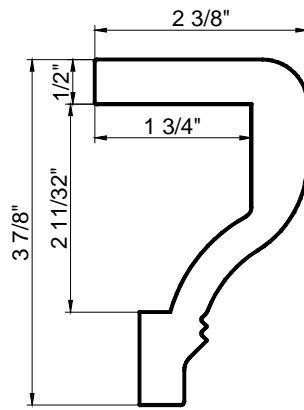

Curved Designer Sill Cap (D/HS)

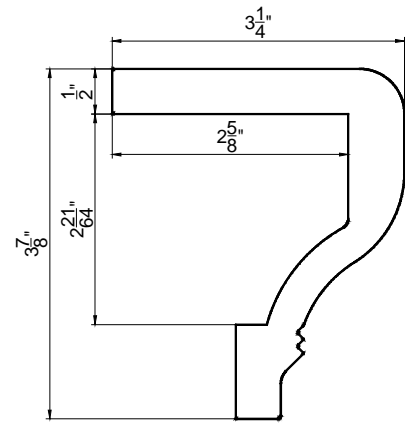

Curved Designer Sill Cap (Z)

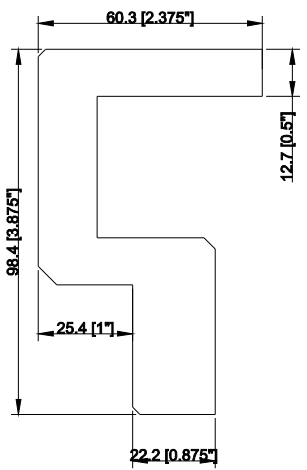

Mission Sill Cap (D/HS)

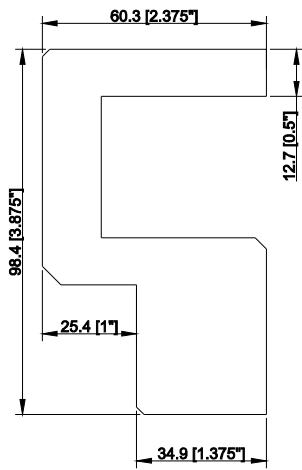

Mission Sill Cap (L)

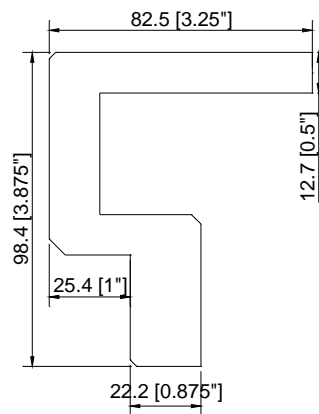

Mission Sill Cap (Z)

Note: For Mission Sill Cap, the extended size at each side needs to be 1" at least.

Sill Plates- Used with existing sills

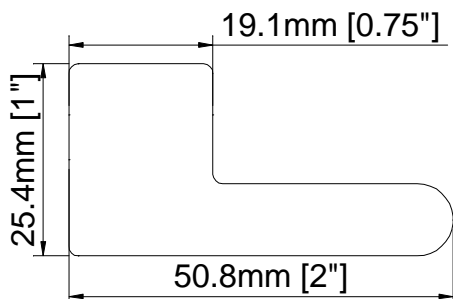

2" Sill Plate with 5/8" Light Block (L/Z)

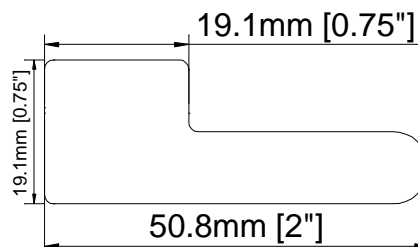

2" Sill Plate with 3/8" Light Block (L/Z)

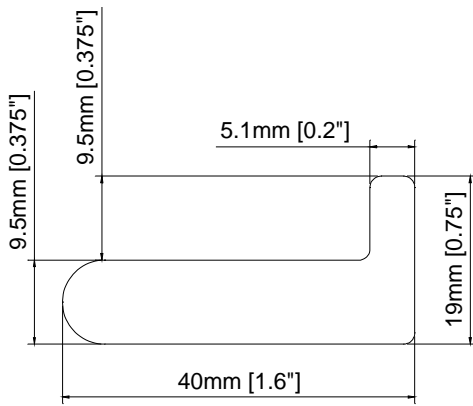

1.6" Sill plate with 3/8" light block

(All Deco & L frames with 1/4" light block)

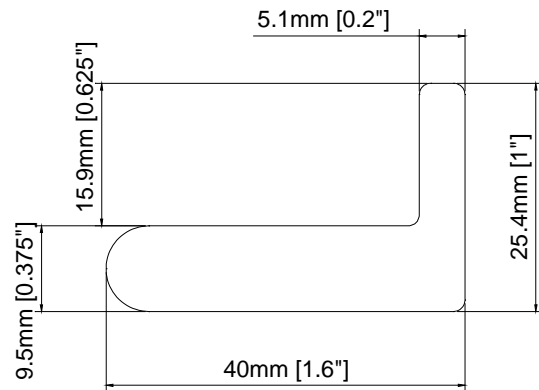

1.6" Sill plate with 5/8" light block

(All Deco & L frames with 1/4" light block)

Pre-drill L Frames (Inside Mount Only) or Z frames:

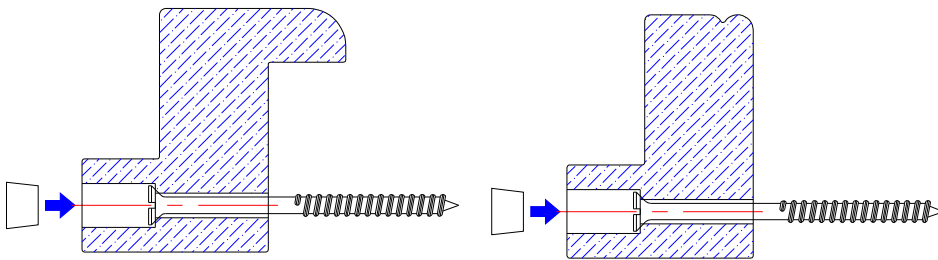

**Extension for Deco Frame\* (Default to have full extension):**

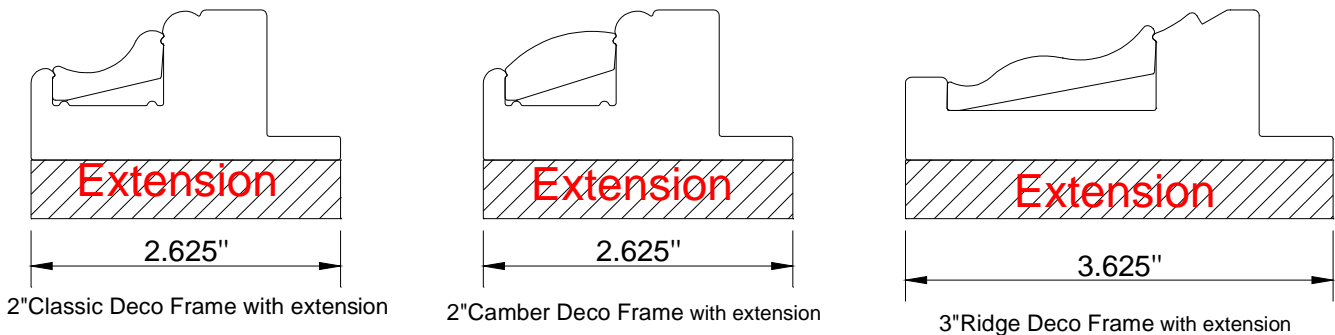

**Note: When the extension thickness of the frame & T post is more than 2", the extension will not be attached with the frame and T post.**

Notch out\*:

- L Frame
- T Post

Specify dimensions in special instruction box.

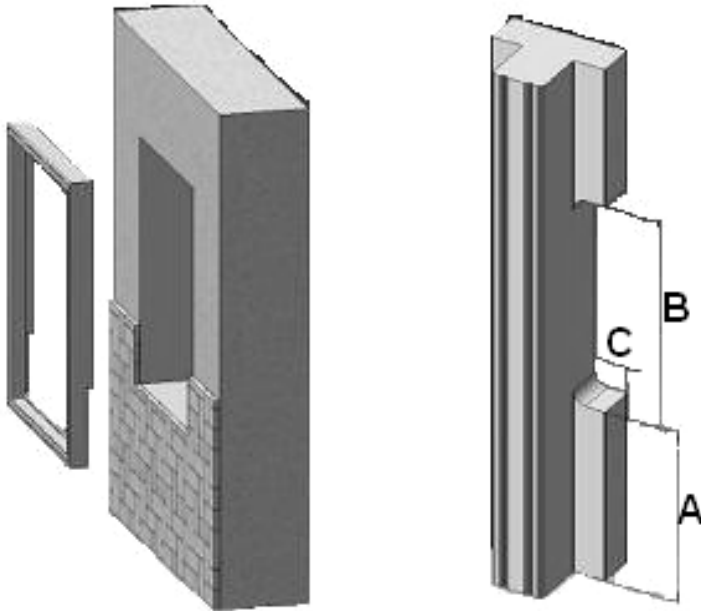

Default principle:

Regarding shutter with horizontal T-post type issue: Horizontal T-Post type will always be the Chamfer T post unless otherwise specified.

# General Product Specifications

<u>Description</u>	<u>Minimum</u>	<u>Maximum</u>
Single Panel Width (Regular)	6"	30" for 1 7/8" louver 36" for 2 1/2" & 3" louver 42" for 3 1/2" & 4 1/2" louvers
Single Panel Width (Bi-fold)	6"	26"
Single Panel Width (Bi-fold Track)	6"	26"
Single Panel Height	10"	132"
Shutter Width (Without T Post)	N/A	4x single panel width (bifold) + frame
Shutter Width (With T Post)	N/A	Unlimited <b>(For orders shipped by sea, frames longer than 142" will be spliced in the middle. For orders shipped by air, frames longer than 120" will be spliced in the middle.)</b>
Shutter Height	N/A	132" + frame

## Shutters without bottom supports

Shutters without bottom supports may sag and deform, including situations below:

1. Shutters with bottom gap over 0.1";
2. Shutters with no frame or no existing sill at the bottom to support the panel (or bottom has frame/existing sill, but the panel keep to open long time without bottom support).

Brightwood Shutters will be covered by our warranty for this application, be subject to our standard specification limitation and the guidelines listed below:

### All Brightwood panel configurations:

- You must inform Norman Shutters of situations where shutters will not have bottom support when placing the initial order.
- Informing Norman Shutters when placing such orders ensures that the factory will add extra hinges to support the panel. This will reduce the probability of the panels sagging and increase shutter integrity.
- If you fail to notify Norman Shutters that the shutter will be used without bottom support, this will constitute a misapplication of the shutter. Consequently, you will be responsible for the cost of any RGA that is submitted.
- If you want a bi-fold shutter, a track must be ordered to support the panels.

## Tilt Rods

### Standard Tilt Rod

**Default Location:** In the middle of the panel on front side (default).

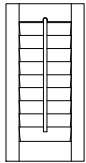

### Offset Tilt Rod\*

**Default Location:** On the front side of the panel and at 1" from the louver ends on the hinged side.

**Optional location:** per your request

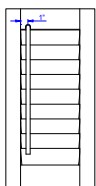

### InvisibleTilt™ \*

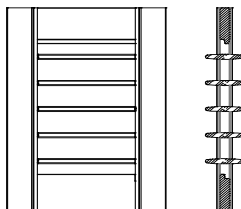

Louver tilting system embedded within panel stile. It is not available for 1<sup>7</sup>/<sub>8</sub>" louver. The tilting system is split when the number of louvers exceeds the limits as listed below:

Louver Size	Maximum Possible Louvers	Panel Height Range
2½"	24	54 ¾" – 57 ¼"
3"	19	54 ¼" – 57"
3½"	16	54 ¾" – 58"
4½"	12	54 ¾" – 60"

For even numbers of louvers, the number of louvers operated by the top and the bottom tilting system will be the same;

For odd numbers of louvers, the number of louvers operated by the bottom tilting system will be one more than the number of louvers operated by the top tilting system;

To ensure split tilt is included, always specify on the order.

### Split Tilt

When selected, the louvers are split evenly by default unless a custom location is requested.

When the customer selects a custom location, the measurement will be as follows (please note that the louvers are in the closed position when measured):

\*Some surcharges apply

BW g-1

**Window size:**

- Measure from the bottom of the window to the top of the louver

**Max frame-to-frame:**

- Measure from the bottom of the frame (or panel if there is no bottom frame, sill or sill cap) to the top of the louver.

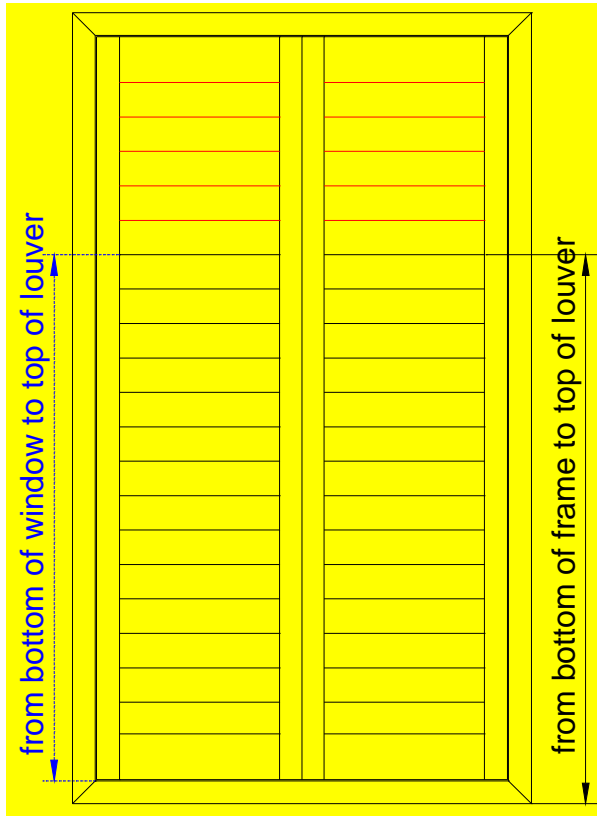

**Split tilt allowable deviations**

Louver Size	Allowable ± Deviation
1 7/8"	3/4"
2 1/2"	1"
3"	1 1/4"
3 1/2"	1 1/2"
4 1/2"	2"

**Split Location:**

- Per the customer's specification. However, the location of the top louver of the bottom split section may be adjusted to achieve more balanced top and bottom rails when **allow deviations** is selected during order entry. If necessary the location will be moved up from the desired height to ensure any obstruction is covered. The amount of the deviation from the desired height will depend on the size of the louver selected.

If the exact location of the split is critical, customer may select **exact location** in the order entry system when placing the order. This may result in significantly different top and bottom rails. When exact location is selected, a popup will reveal the resulting top and bottom rails measurements from which the customer may either:

1. Accept the listed top and bottom rail sizes
2. Modify the split location (sometimes a slight adjustment in the exact split location may achieve desired top and bottom rail sizes)
3. Change to **allow deviations** so the system will calculate the split location

**Note:** Top and bottom rail sizes may change if the current line item is being matched with another line item. Carefully review all top and bottom rail sizes and split locations to ensure a desirable look is achieved



# Divider Rails

- A divider rail is an extra rail in the middle of the panel.
- Creates two sections in the panel so louvers can be operated independently.
- Strengthens the panel and enhances structural integrity.
- Required for panel heights over 78"
- Custom Size(3"~7.875") Divider Rail is available with surcharge.

## Specifications

- Standard width: 3"
- Default location: center of the panel unless specified otherwise

## Measurements:

- Window size:
  - Measure from the bottom of the window to the center of the divider rail.
- Max frame-to-frame:
  - Measure from the bottom of the frame to the center of the divider rail.
- Position:
  - Per customer's specification. However, the divider rail may be adjusted to a lower or higher position, within our allowable deviation, to ensure reinforcement and aesthetics of the shutter.

When placing the order, please clearly specify if the divider rail position needs to line up with that of other shutter divider rails in the same room. Please also refer to the table below for the allowable deviation details.

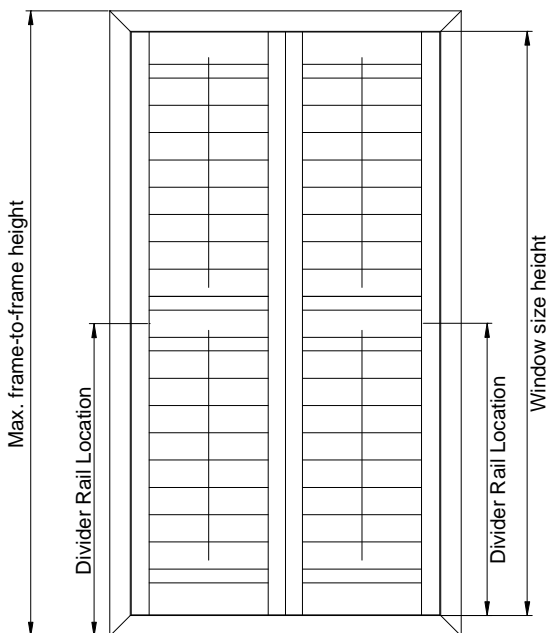

## Divider rail allowable deviations

Louver Size	Allowable ± Deviation
1 7/8"	3/4"
2 1/2"	1"
<b>3"</b>	<b>1 1/4"</b>
3 1/2"	1 1/2"
4 1/2"	2"

# Hardware

## Hinges

Self-Mortise Hinge

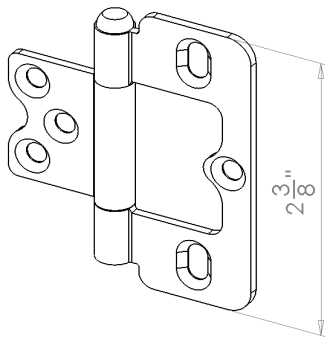

Bi-fold Hinge

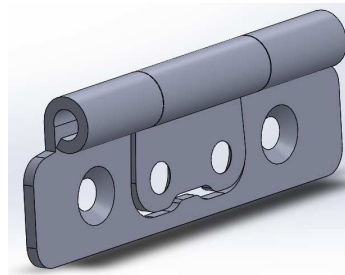

L Hinge

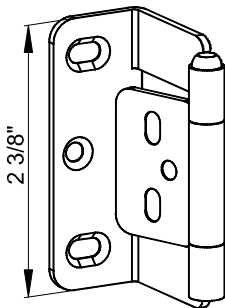

Direct Mount 3" Hinge

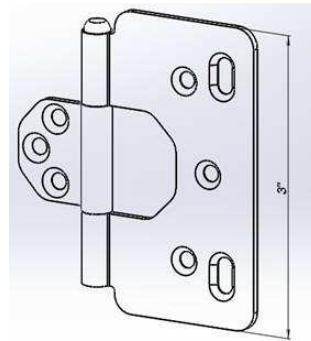

Hinges are available in:

Pure White, Silk White, Bisque, Pearl, Bright Brass, Antique Brass, Black, Nickel plated, Brushed Nickel, Stainless Steel\*, Crisp Linen, String, Sea Mist, Stone Gray, Brown Gray, Taupe Gray.

While hinge colors of Crisp Linen, String, Sea Mist, Stone Gray, Brown Gray, Taupe Gray are not available for Direct mount 3" Hinges.

➤ Direct Mount 3" Hinge:

1. The hinge position of the direct mount 3" hinge will be different from that of the 2.375" ones. For shutters used both the 2.375" and the direct mount 3" hinge, the hinge position of the 2.375" ones will match that of the direct mount 3" hinge;

\*Some surcharges apply

- The hinge is only to install between the panel and the existing window. For other situation, 2.375" hinges will be used;
- To avoid conflict, there will be cut-out for the light block of the hinged side. Please refer to the drawing below.

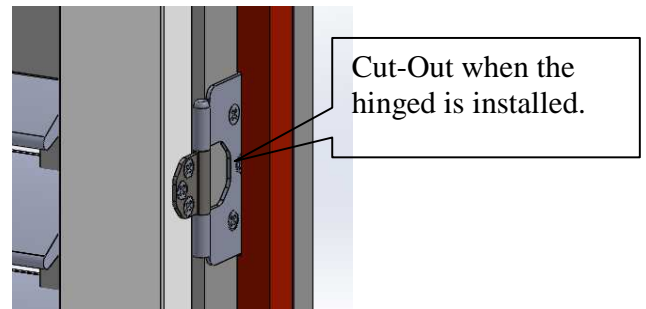
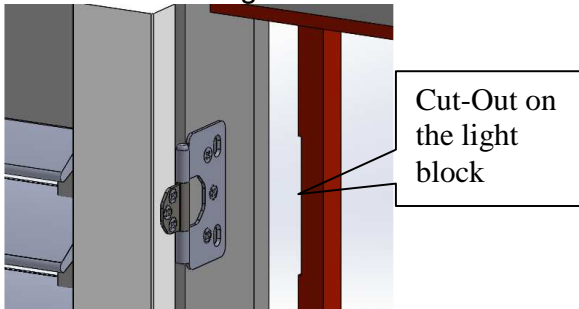

- Direct Mount 3" Hinge is not suitable for drywall installations.

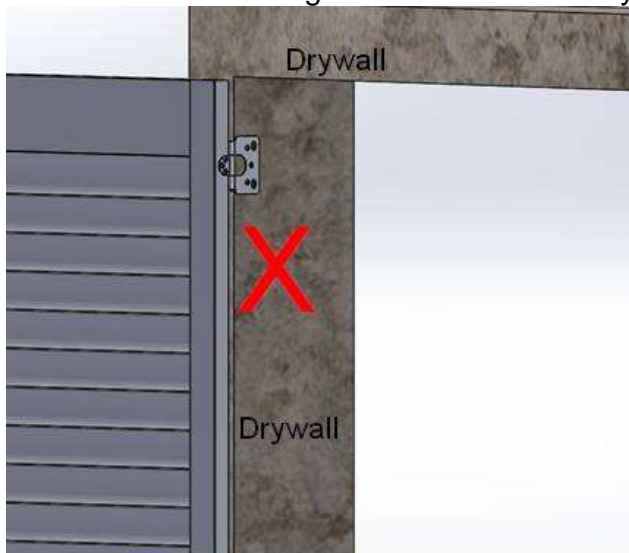

Direct Mount 3" hinge is not suitable for drywall installations.  
It's not recommended.

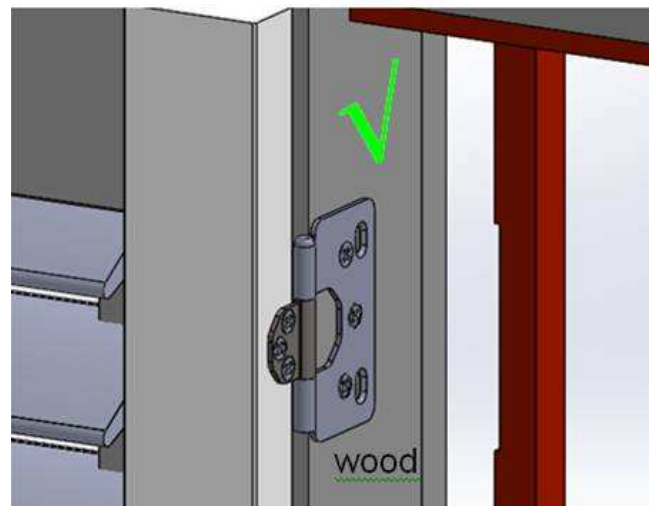

It's acceptable.

### Invisible Hinge\*:



- Invisible hinge is not available for multifold panels.
- Invisible hinge can only be between the panel & frame/T post, connections from panel to panel will use a regular hinge.

\*Some surcharges apply

3. Color Option: Only available for Pearl Chrome Plated.

Frame Options	Hinge	Notes
2" Camber Deco Frame	Y	/
2" Classic Deco Frame	Y	/
2.5" Mission Deco Frame	N	/
3" Ridge Deco Frame	N	/
Vintage L Frame W / 1/4" Light Block	N	/
Vintage L	N	/
Vintage L Frame w/ 1/2" Buildout	N	/
Vintage L Frame w/ 1" Buildout	N	/
Beaded L w 1/4"light block	Y	/
Beaded L	Y	/
Beaded L Frame w/ 1/2" Buildout	Y	/
Beaded L Frame w/ 1" Buildout	Y	/
Tilt out Z Frame	N	/
1.25" Beaded Z Frame	Y	/
1.5" Bullnose Z Frame	Y	/
2" Bullnose Z Frame	Y	/
2" Bel Air Z Frame	Y	/
3" Crown Z Frame	N	/
7/8" Vintage Hang Strip	N	/
1" Chamfer T-Post w/ 1/4" Light Block(for Deco)	Y	only available with hinge on one side, for example, LTL is available, but RTL is not.
1" Chamfer T-Post w/3/4" Light Block(for L/Z/HS)	Y	
1" Chamfer T-Post w/ 1/4" thick 3/8" wide Light Block(for Deco)	Y	
1" Chamfer T-Post w/3/4" thick 3/8" wide Light Block(for L/Z/HS)	Y	
1 3/4" Chamfer T-Post w/1/4" Light Block(for Deco)	Y	available with hinge on BOTH side, for example, RTL.

\*Some surcharges apply

1 3/4" Chamfer T-Post w/3/4" Light Block(for L/Z/HS)	Y	
Corner Post w/1/4" Light Block(for Deco)	Y	/
Corner Post w/3/4" Light Block(for L/Z/HS)	Y	/
Bay Post w/1/4" Light Block(for Deco)	Y	/
Bay Post w/3/4" Light Block(for L/Z/HS)	Y	/
Invisible Hinge Qty		
Panel Height (H)	Hinge Qty	
H<=48"	2	
48"<H<=78"	3	
78"<H<=96"	4	
96"<H<=120"	5	
H>120"	6	

**Preinstallation:**

Panels and frames will be packaged individually, and the hinge is preinstalled onto the frame/post, with the screws for the other half part on the panels in the hardware box.

**Panel Lock: (not available for 1.625" Stile)**

**Available Material: All**

**Color: Brush Nickel Plated**

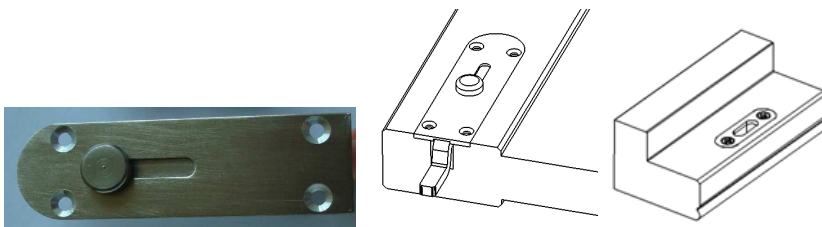

**Position: (Only available on Bottom for Track Shutters with Bottom Track; For Regular, available on Top/Bottom/both Top and Bottom)**

\*Some surcharges apply

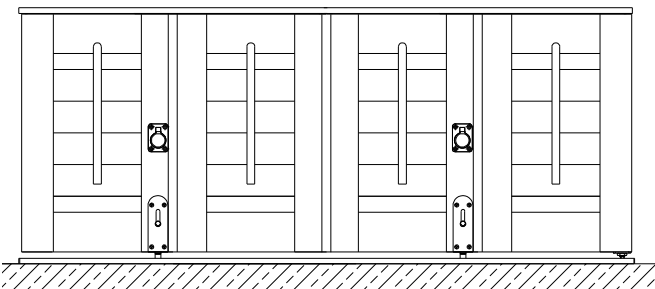
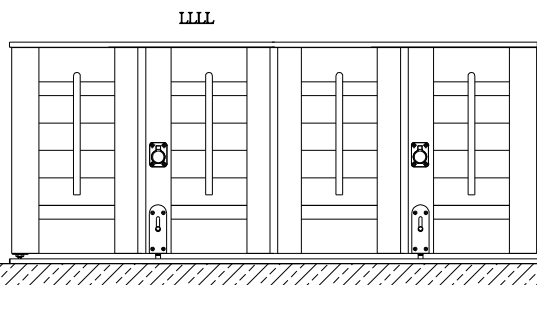
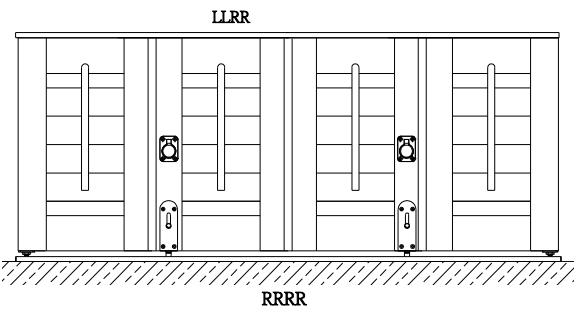
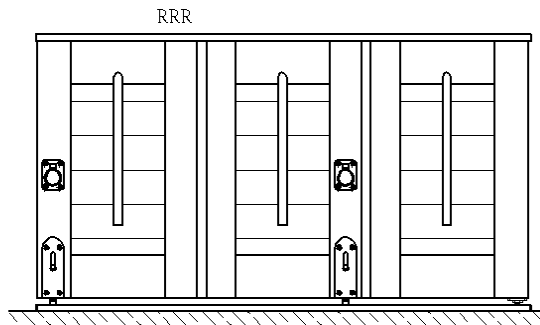
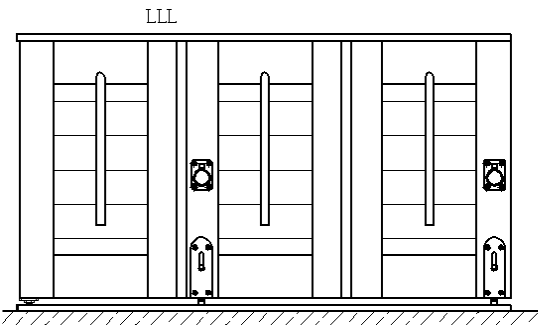
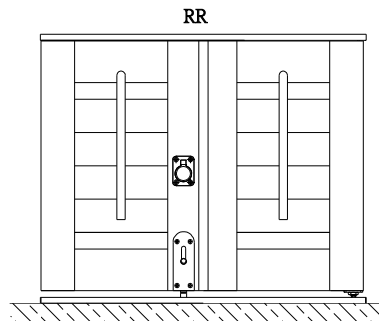
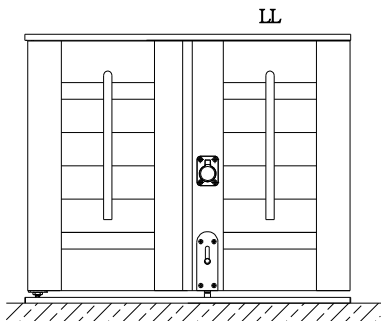
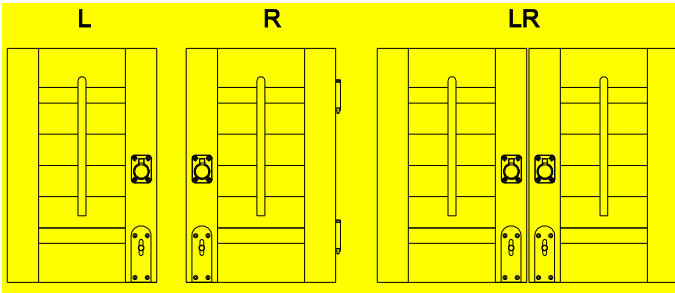

\*Some surcharges apply

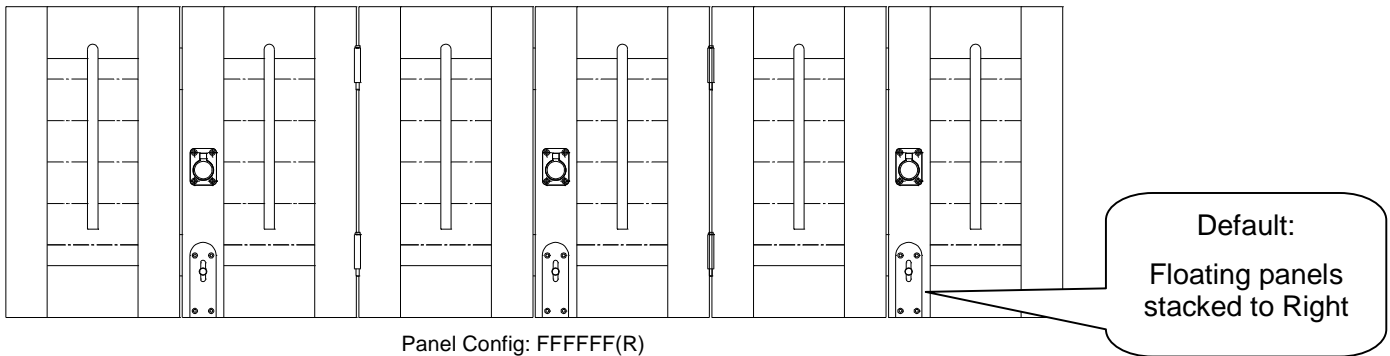

The Panel Lock location for both track system shutters and regular shutters would be the same. The general principle is that the Panel Lock position will avoid the stile which will install the spring-loaded guide at bottom (same stile as the Wheel carrier).

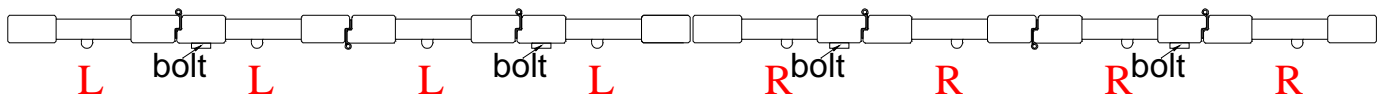

**Ring pull:** for easy opening and closing

(Not available for 1.625" Stile)

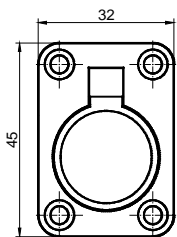

**Ring pull location principle for Floating Panels:**

1. When floating panel config is in pairs, it will be split into halves, the left will be for LL and the right will be for RR. So the ring pull location for FF/FF, FF/FF/FF/FF will be same as that of panel config as LL/RR, LL/LL/RR/RR.
2. When floating panel config is FF, the ring pull location will be same as that of panel config LL.
3. When floating panel config is FFFF/FF, the ring pull location will be same as that of panel config LLLL/RR.
4. When floating panel config is singular, it will be split into 3 sections, the left and mid sections are for LL and the right section is for RR. So the ring pull location for FF/FF/FF, FF/FF/FF/FF/FF will be same as that of LL/LL/RR, LL/LL/LL/RR/RR.

Please note the ring pull color will match with the hinge color. When shutter order with Invisible Hinge, the ring pull color will match with the normal hinge color. Please see the matching chart below:

\*Some surcharges apply

Hinge color	Pure White	Silk White	Bisque	Pearl	Black	Nickel Plated	Brushed Nickel	Antique Brass	Bright Brass	Stainless Steel
Ring Pull color	White	White	Bisque	Pearl	Black	Brushed Nickel	Brushed Nickel	Antique Brass	Bright Brass	Brushed Nickel

Hinge color	Crisp Linen	String	Sea Mist	Stone Gray	Brown Gray	Taupe Gray
Ring Pull color	Bisque	Bisque	Brushed Nickel	Brushed Nickel	Brushed Nickel	Brushed Nickel

Color ID	Color Name	2.375" Hinge color (Default)	Direct Mount 3" Hinge color (Default)	T post connector color	Ring pull color	Top Track color (Default)	Invisible hinge color
001	Pure White	Pure White	Pure White	Pure White	White	White	Pearl Chrome Plated
002	Extra White	Silk White	Silk White	Silk White	White	White	
003	Silk White	Silk White	Silk White	Silk White	White	White	
004	Bright White	Silk White	Silk White	Silk White	White	White	
006	Pearl	Pearl	Pearl	Pearl	Pearl	White	
007	Ivory Lace	Bisque	Bisque	Bisque	Bisque	White	
009	Creamy	Pearl	Pearl	Pearl	Pearl	White	
012	Crisp Linen	Crisp Linen	Bisque	Bisque	Bisque	White	
016	Butter	Crisp Linen	Bisque	Bisque	Bisque	White	
019	String	String	Bisque	Bisque	Bisque	White	
030	Moondust	Sea Mist	Nickel Plated	Nickel Plated	Brushed Nickel	Anodised Silver	
032	Sea Mist	Sea Mist	Nickel Plated	Nickel Plated	Brushed Nickel	Anodised Silver	
042	Hall Gray	Sea Mist	Nickel Plated	Nickel Plated	Brushed Nickel	Anodised Silver	
046	Ice	Silk White	Silk White	Silk White	White	White	
048	Chai	Nickel Plated	Nickel Plated	Nickel Plated	Brushed Nickel	Anodised Silver	
049	Stone Gray	Stone Gray	Nickel Plated	Nickel Plated	Brushed Nickel	Anodised Silver	
051	Brown Gray	Brown Gray	Nickel Plated	Nickel Plated	Brushed Nickel	Anodised Silver	

\*Some surcharges apply



053	Clay	Nickel Plated	Nickel Plated	Nickel Plated	Brushed Nickel	Anodised Silver
063	Decorators White	Silk White	Silk White	Silk White	White	White
066	Winchester White 2010	Pearl	Pearl	Pearl	Pearl	White
073	Sky Gray	Silk White	Silk White	Silk White	White	Anodised Silver
074	Element Gray	Sea Mist	Nickel Plated	Nickel Plated	Brushed Nickel	Anodised Silver
075	Storm Gray	Sea Mist	Nickel Plated	Nickel Plated	Brushed Nickel	Anodised Silver
077	Dawn	Silk White	Silk White	Silk White	White	White
078	Cloud Blue	Silk White	Silk White	Silk White	White	White
080	Taupe Gray	Taupe Gray	Nickel Plated	Nickel Plated	Brushed Nickel	Anodised Silver
836	Classic Black	Black	Black	Black	Black	Anodised Silver

**Position:** For different panel configuration, please refer to the location of Panel Lock to show on which stile the pull will be fixed.

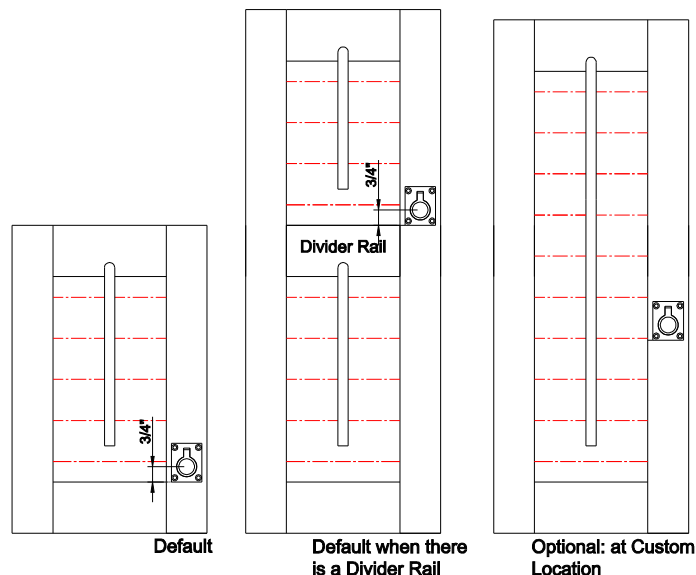

**Position:**

- A. Above Bottom Rail (Default)
- B. Above 1<sup>st</sup> Divider Rail (Default when there are Divider Rails)
- C. Custom Location

\*Some surcharges apply

If both Panel Lock & ring pull are specified, the distance between them is 2 3/4", and the ring pull location is 6 3/4" from the bottom of panel.

When there is no mid rail, ring pull will be just on the top of Panel Lock (2 3/4" above Panel Lock) as default location; if there are mid rails, bottom of ring pull lines up with top of the 1<sup>st</sup> mid rail as default location.

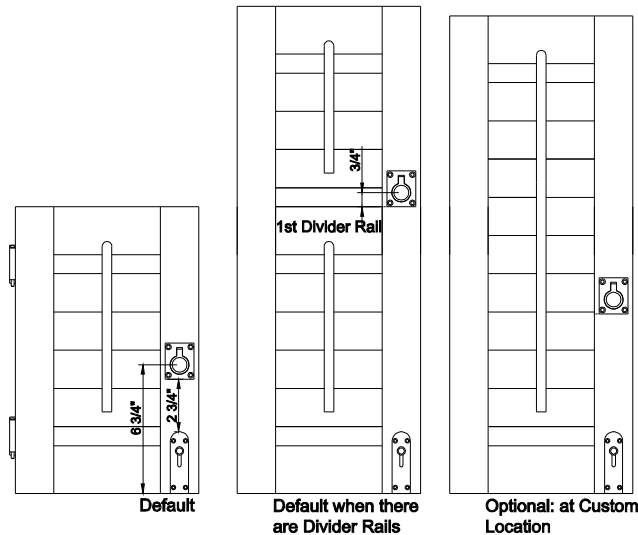

**Position:**

- A. 2 3/4" Above Panel Lock (Default when both Ring Pull and Panel Lock are specified)
- B. Above 1<sup>st</sup> Divider Rail (Default when there are Divider Rails)
- C. Custom Location

**Measurements:**

- Window size:
  - Measure from the bottom of the window to the center of the ring pull.
- Max frame-to-frame:
  - Measure from the bottom of the frame to the center of the ring pull.

**Side Magnet: Available for Butt, rabbet and Astragal stile**



Side Magnets will be applied in following situation:

1. Double Hung shutter but without horizontal T post:
  - Side magnets will be applied to the meeting stiles of the L and R panel. (Default)

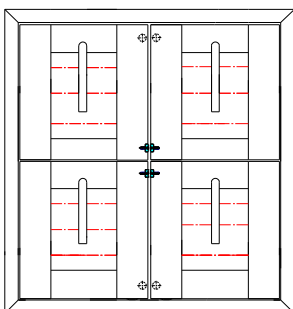

2. Café Shutter

\*Some surcharges apply

Side magnets will be applied to the meeting stiles of the L and R panel. (Default)

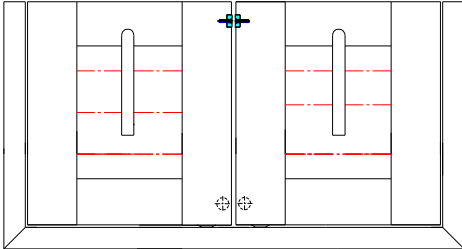

3. No frame or light block or L-shape striker plate on either top or bottom, or if larger than standard top or bottom gap is requested.

Side magnets will be applied to the meeting stiles of the L and R panel. (Optional)

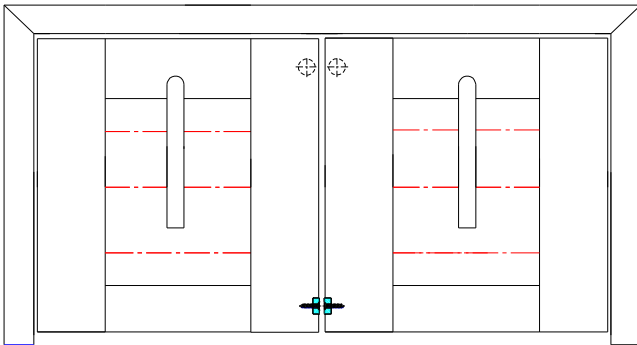

4. Note: if panels only with side magnets and there is no standard magnet on the back of panels, panels may open for external factors.

## **T-Post Connector**

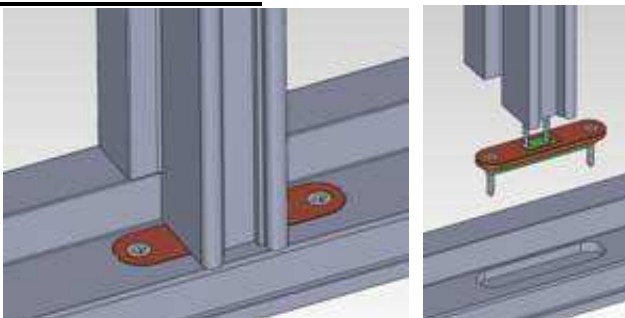

- Available colors: Pure White; Silk White; Pearl; Bisque; Black; Nickel-Plated.
- Available for all types of T Posts (custom-width T posts excluded).

**T Post Connector can be used with the following Frames.**

**L Frame:**

**Deco Frame:**

**Z Frame:**

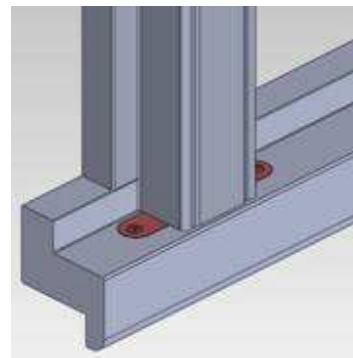
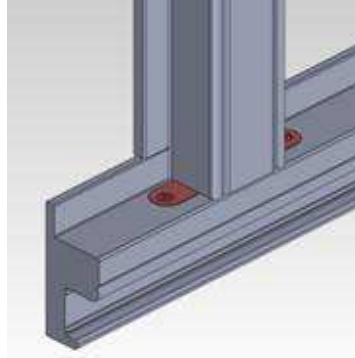
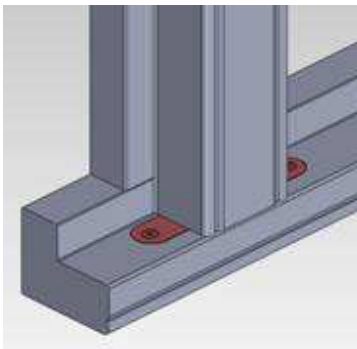

**Hang Strip (Beside)**

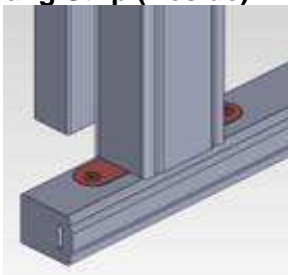

**Note:**

1. For Horizontal T Post, Hang Strip (Behind) and shutter with 1.5"/2" Sill, T Post connector is not available and T Post will be installed by screws instead;
2. If there is a panel lock which may interfere with the T-Post connector, all the T-Posts for the entire shutter will be installed with screws and the frames to be pre-drilled, even in cases where the panel lock may only interfere with one T-Post;
3. The screw color is nickel-plated regardless of the color of the T Post connector;
4. T post connectors can only be installed on a straight piece, and screws will be used instead for T Post installed on a curved or raked piece.

## **Optional Poles:**

### 1. Terminology

\*Some surcharges apply

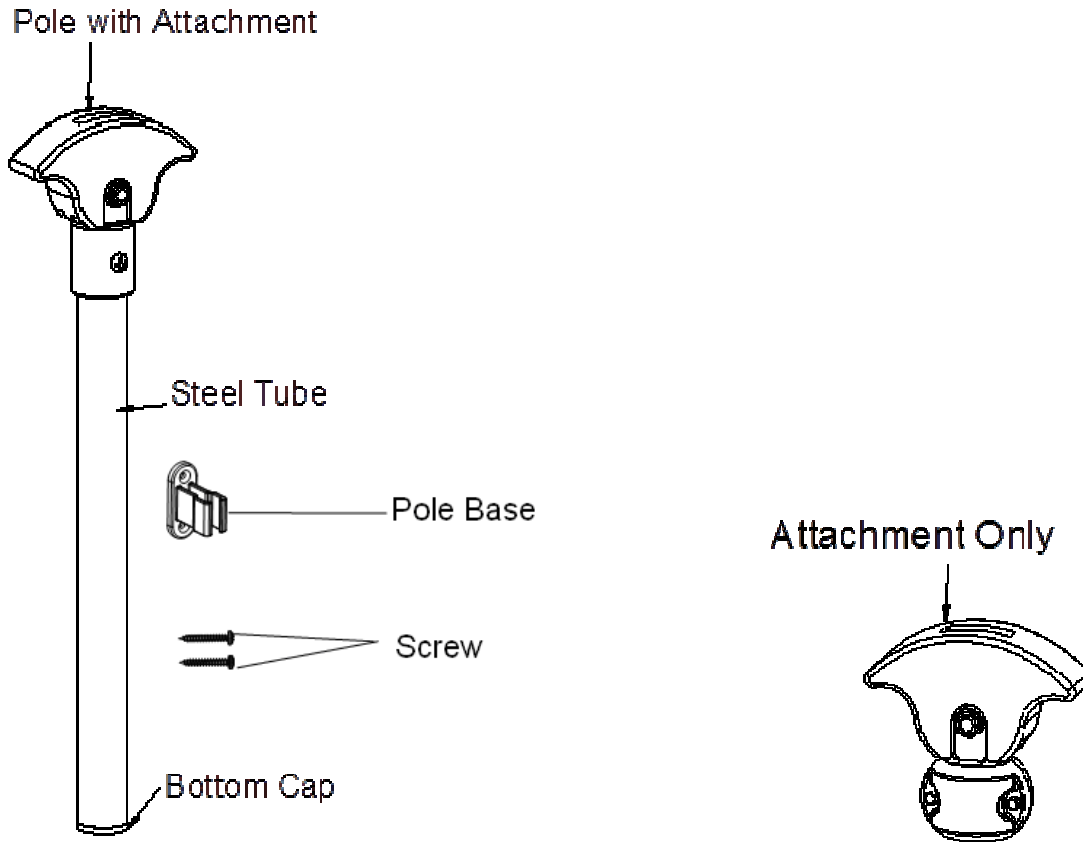

**Component**

NO.	Name	Note
1	Pole with Attachment	Steel tube, Pole Base and Bottom Cap included *Surcharge applies.
2	Attachment only	<ul style="list-style-type: none"> <li>● Compatible with extension poles found in most home improvement stores.</li> <li>● Screw thread (3/4") and thread pitch (1/5")</li> </ul> *Surcharge applies.

**2. Available Pole Length**

	2pcs Combined by Connector
Pole length (inch)	53"

The Connector (the center one):

\*Some surcharges apply



The Finished Product:

Pole with Plastic Tube:



# Bi-fold 180<sup>™</sup>

## Guidelines

<u>Description</u>	<u>Minimum</u>	<u>Maximum</u>
Single-Panel Width (Bi-fold Track)	6"	26"
Single-Panel Width (LLL/RRR)	6"	20"
Single-Panel Height	10"	132"

### Outside Mount

Max frame-to-frame width: window width + 3 1/2"

Max frame-to-frame height: window height + 4 1/2"

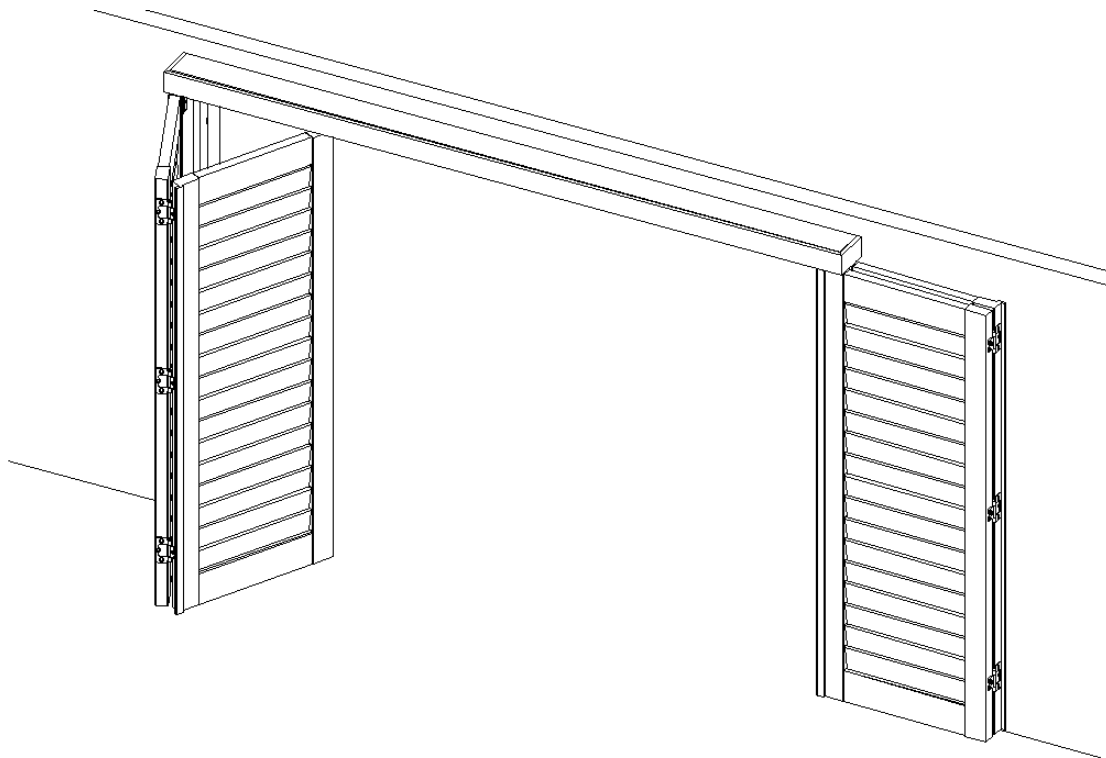

- Track is pre-installed on the header; standard 1 track only.

Mounting Options: Outside Mount only

Side View

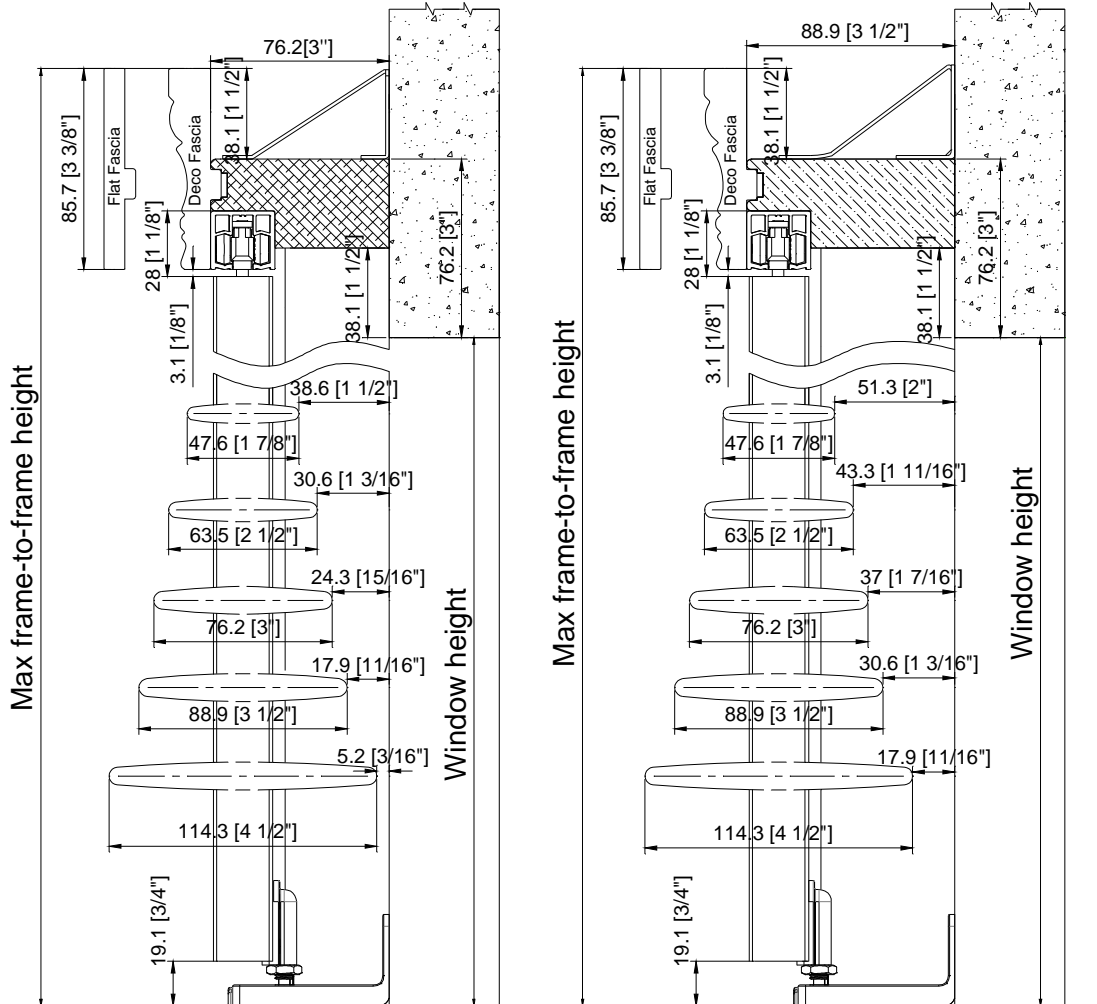

Top View

Without Casing:

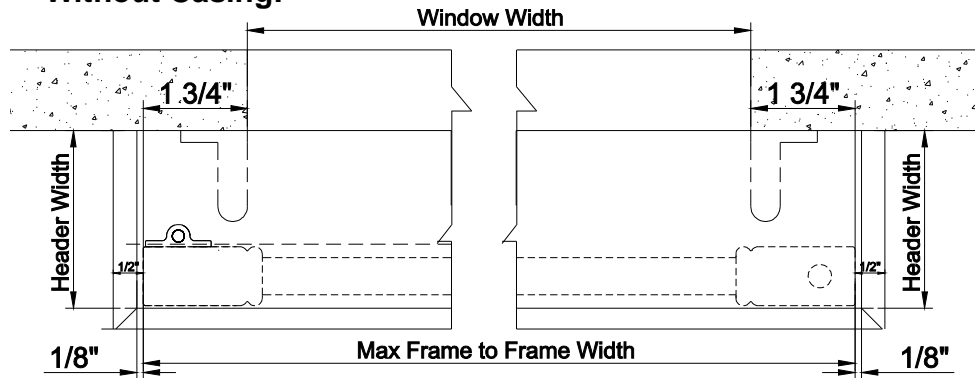

Note:

- ◇ Fascia return will protrude the panel about 1/2" for each side.
- ◇ The header will protrude the panel about 1/8" for each side.
- ◇ Header, light blocks, and bottom pivot bracket(s) must be installed on a flat surface.



**With Existing Casing:**

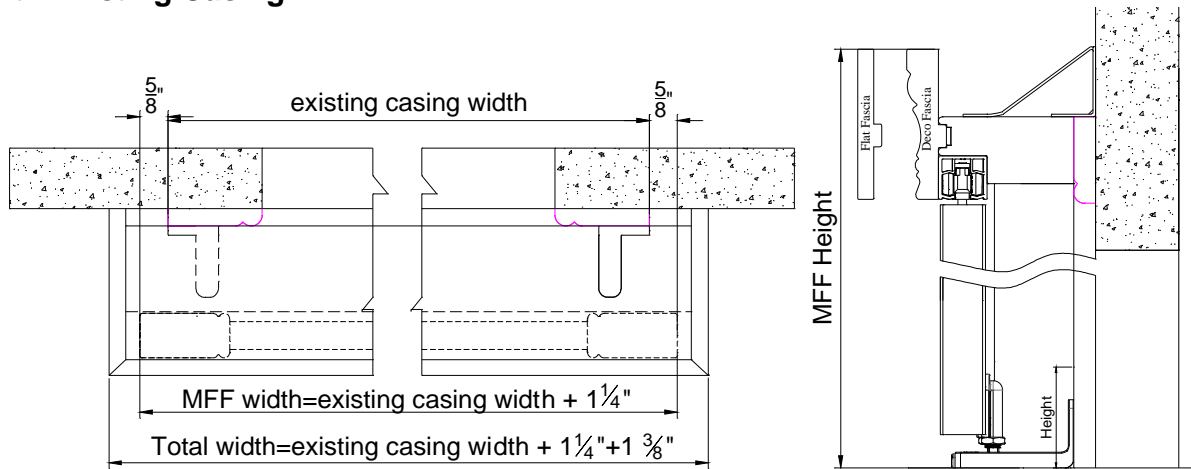

- ✧ Header Extension: Optional
- ✧ Custom extension up to 2" for Header
- ✧ When extension is needed, the header will protrude the panel 5/16" for each side and the fascia return will protrude the panel 11/16" for each side.

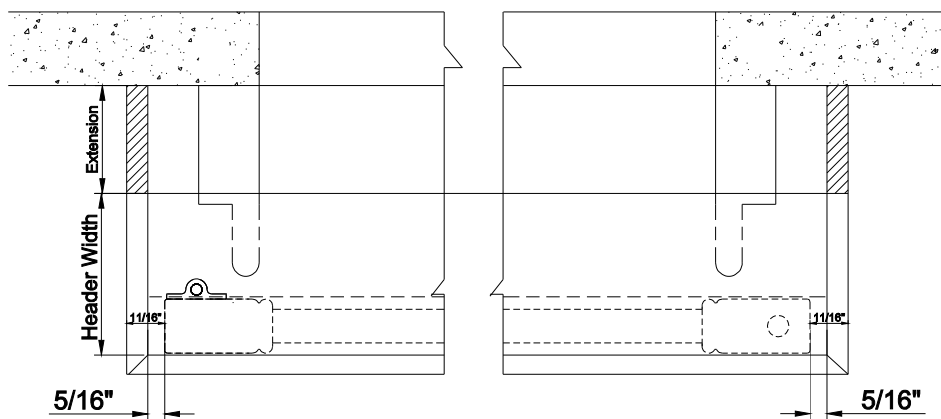

The extension will be pre-attached.

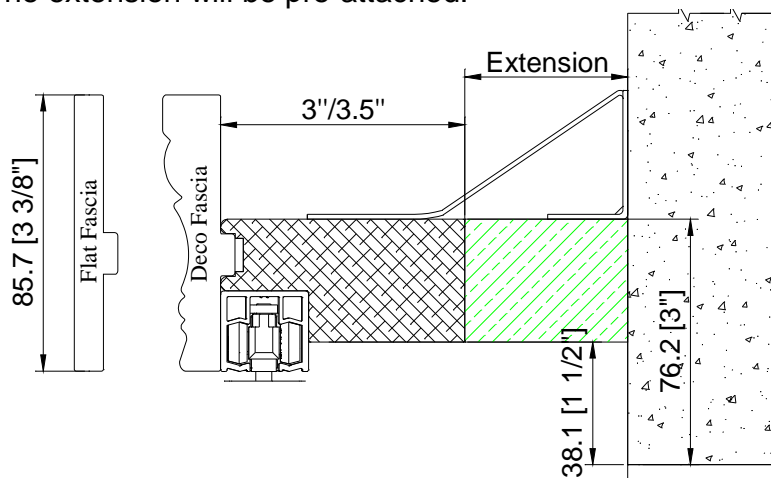

For 180 Bi-fold, if Bottom Pivot L Bracket is required, the extension for the L shape light block will be 1 3/4" in width. Please see picture below:

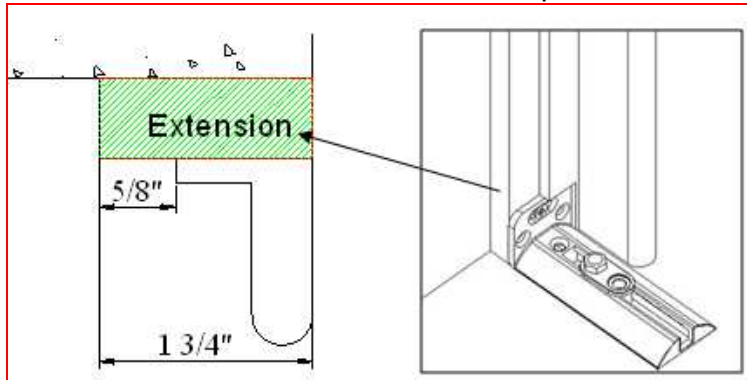

**Panel Configuration : Only 2", 2 1/4" rabbet and butt stiles are available. Center stile is not available.**

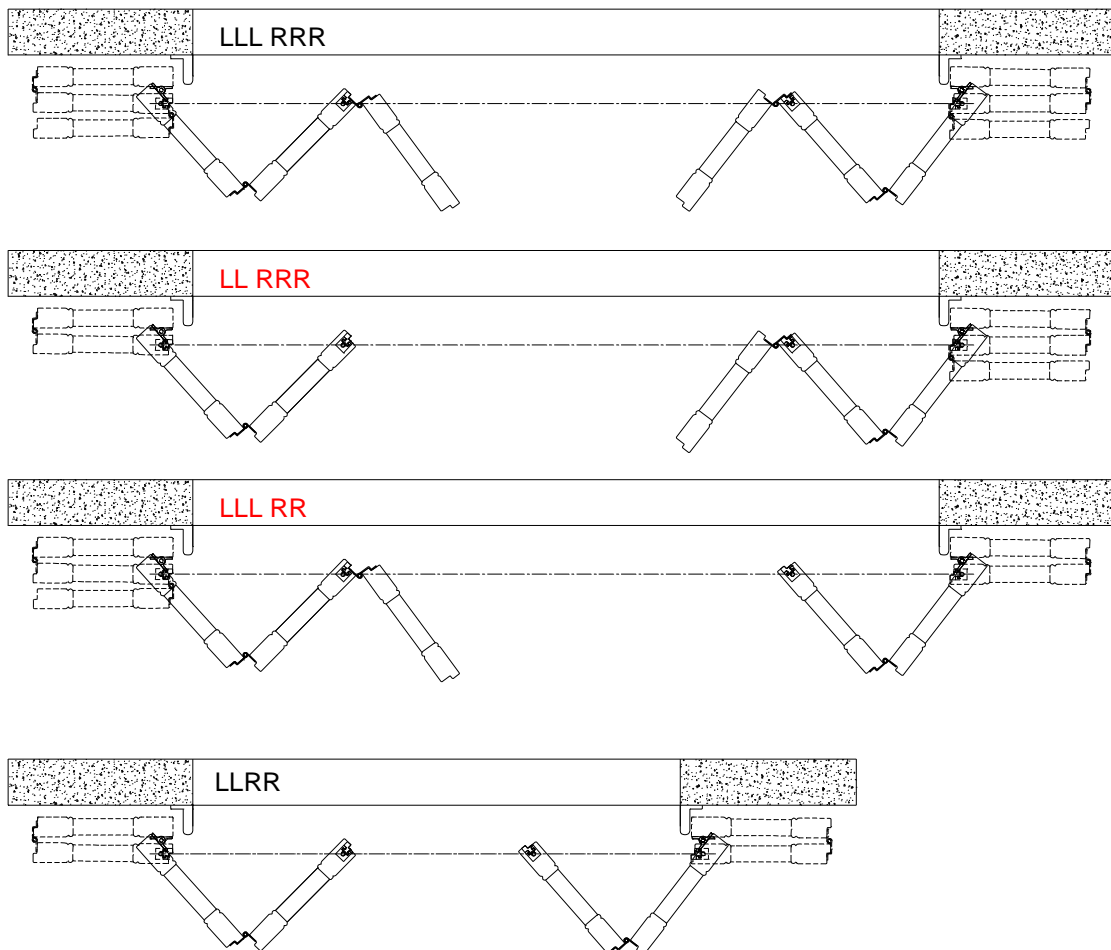

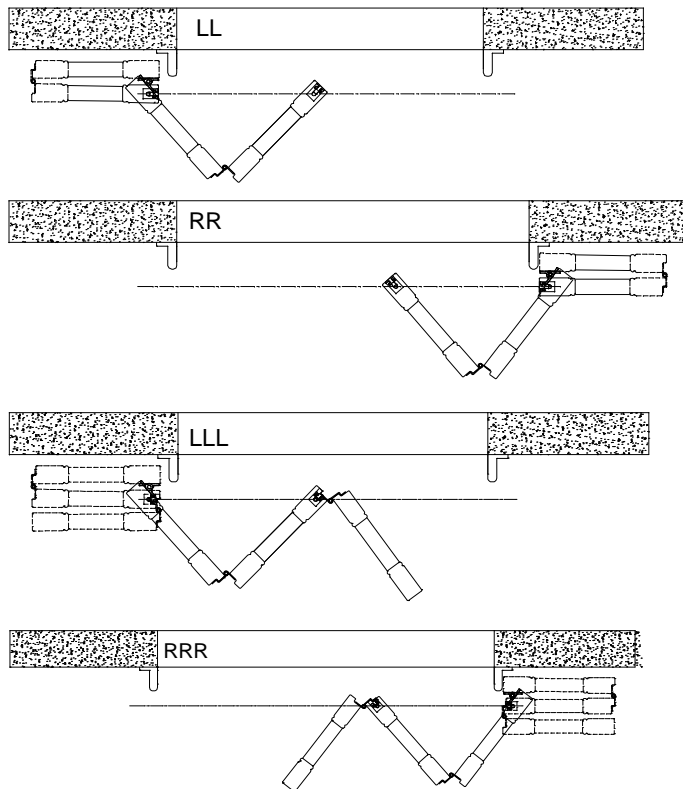

**Notes:**

If there is no baseboard to the wall, 3" header can be used.

If there is baseboard to the wall, then it should be as below:

1. If base board thickness is less or equal to 5/8", 3 1/2" header can be used.
2. If base board thickness is over 5/8", it is suggest using the 3" header with build out. And the build out thickness=base board thickness-1/8".

Please see the drawing below:

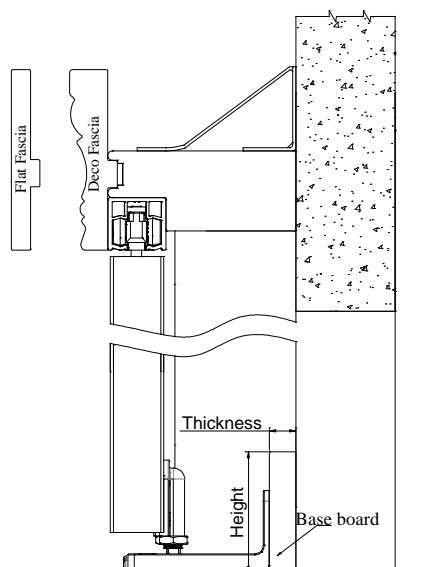

**180° Bi-fold Track Shutters Framing Materials**

Type	Header Dimension	Top Fascia Dimension	L Shape Light Block Strip Dimension
Header & Top Fascia & Light Block Strip	3"	3 3/8"	1 9/16"
	3 1/2"		2 1/16"

**180° Bi-fold Track Shutters Hardware Box**

Parts
Wrench
Hinge Pin
Support L Bracket (based on the length of header)
2 ½ " screws for support L bracket
¾ " screws for support L bracket
Bottom Pivot Bracket
1 ½ " screws for bottom pivot bracket
2 ½ " screws for Frame with predrilled screw holes

# Bi-fold 90™

## Guidelines and Specs:

<u>Description</u>	<u>Minimum</u>	<u>Maximum</u>
Single-Panel Width (Bi-fold Track)	6"	26"
Single-Panel Width (Multifold track up to 4 panels)	6"	20"
Single-Panel Height	10"	132"

### Outside Mount

Max frame-to-frame width: window width + 3 1/2"

Max frame-to-frame height: window height + 4 1/2"

### Semi-Inside Mount

Max frame-to-frame width: window width - 1/8"

Max frame-to-frame height: window height + 1 3/8"

### Inside Mount

Max frame-to-frame width: window width - 1/8"

Max frame-to-frame height: window height - 1/8"

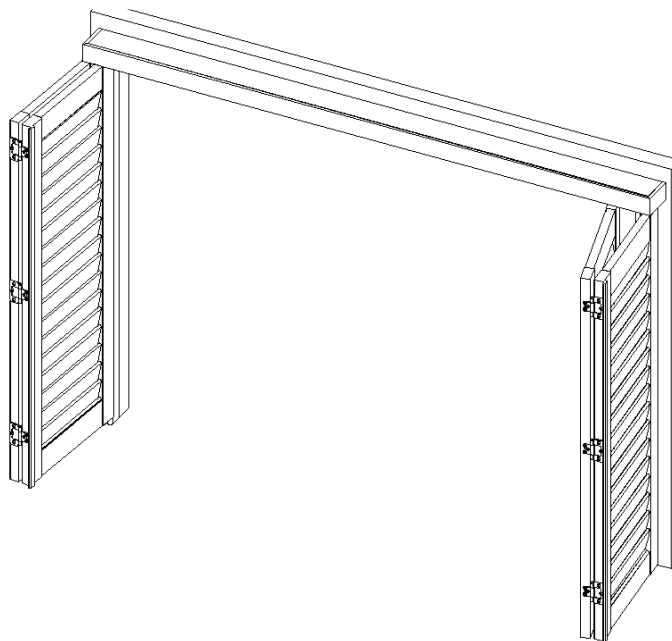

Track is pre-installed on the header; standard 1 track only.

Mounting Options: Outside Mount

Side View

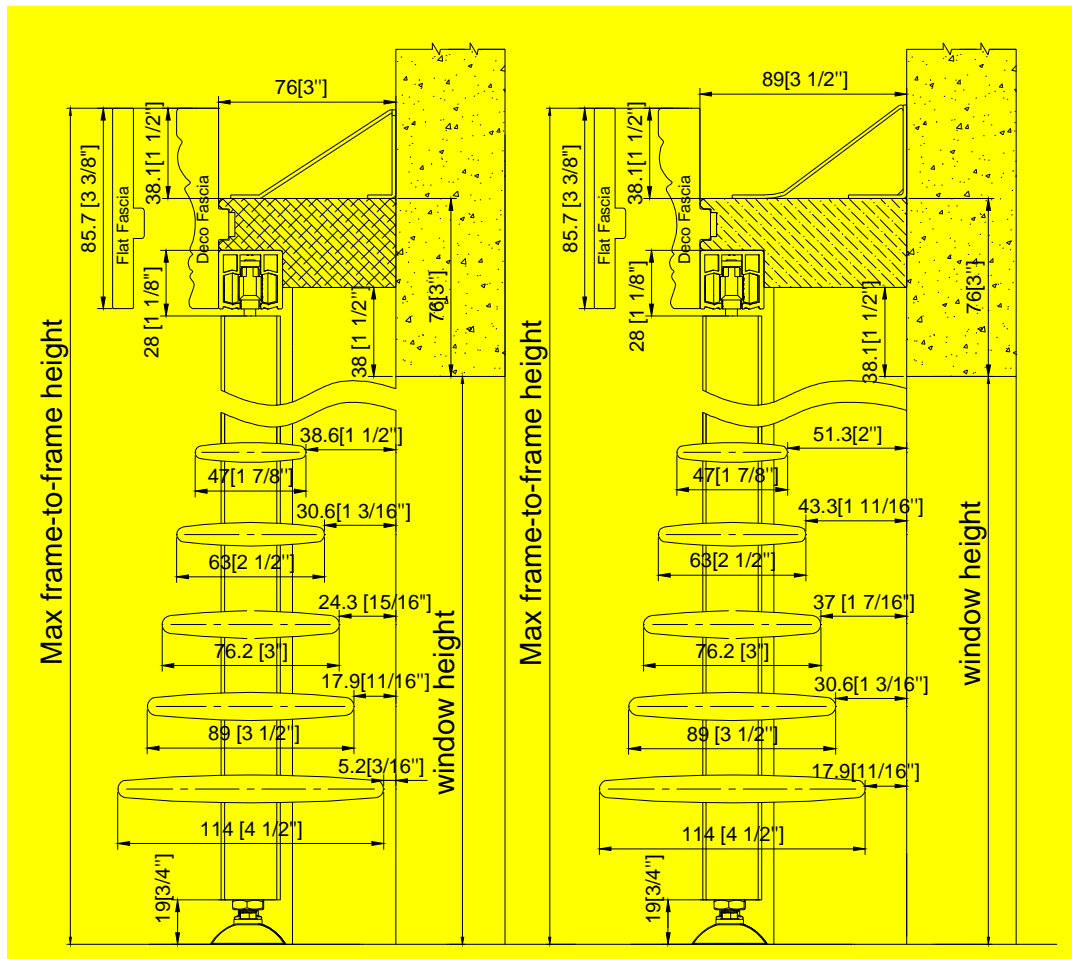

Top View

Without Casing:

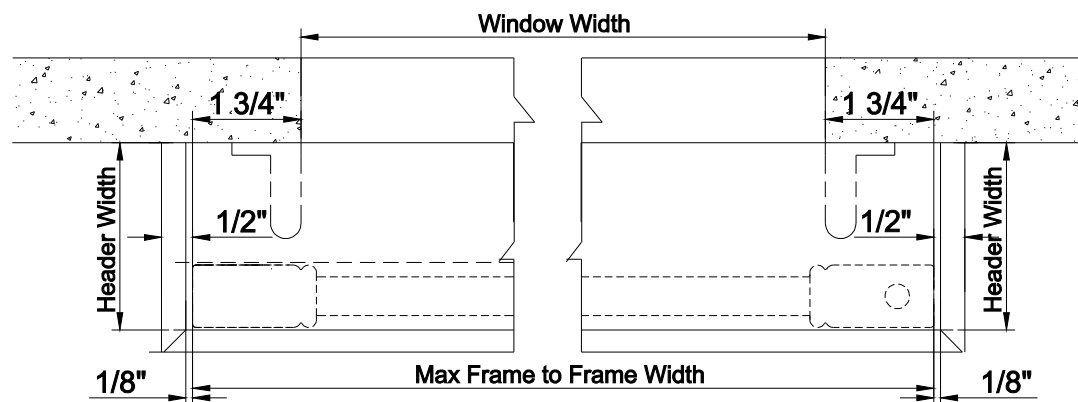

Note:

- ◇ Fascia return will protrude the panel about 1/2" for each side.
- ◇ The header will protrude the panel about 1/8" for each side.
- ◇ Header, light blocks, and bottom pivot bracket(s) must be installed on a flat surface.

**With Existing Casing:**

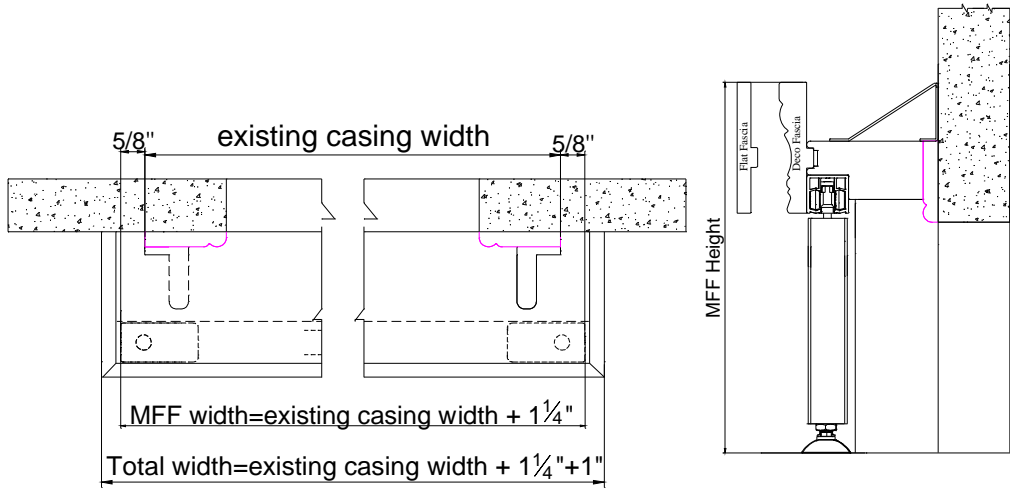

**Semi-Inside/Inside Mount**

**Side View**

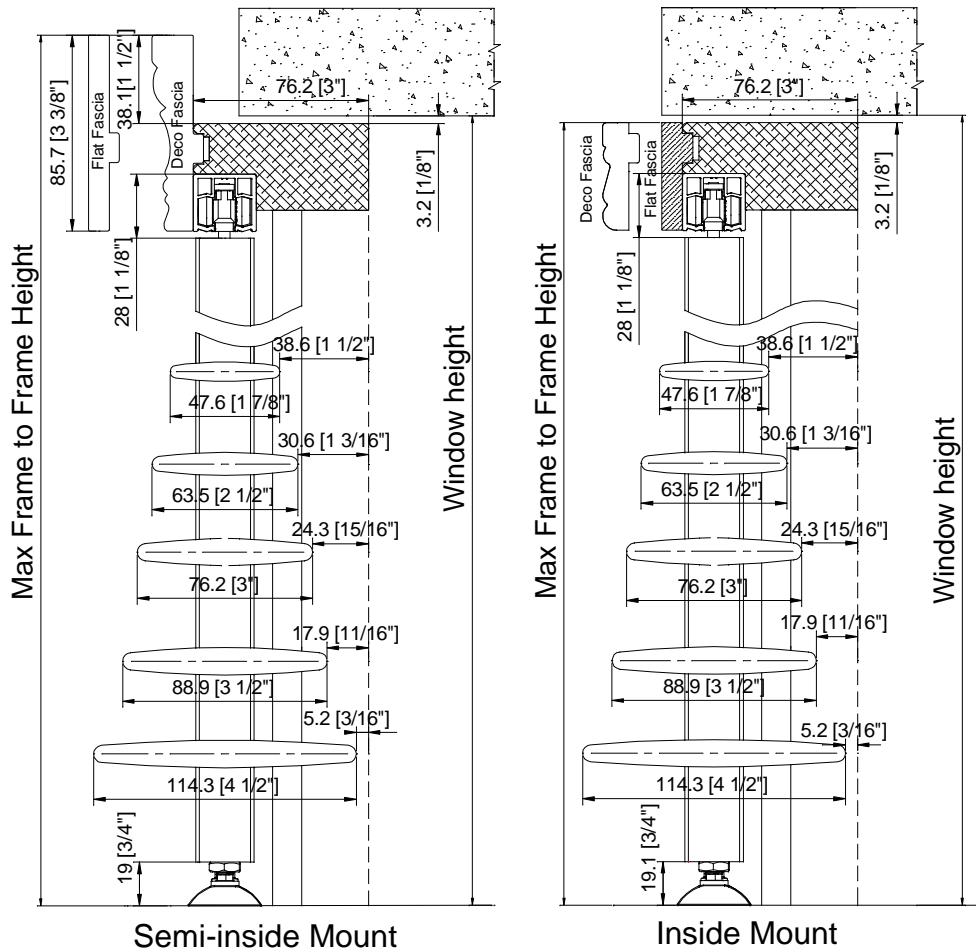

Semi-Inside Mount Top View

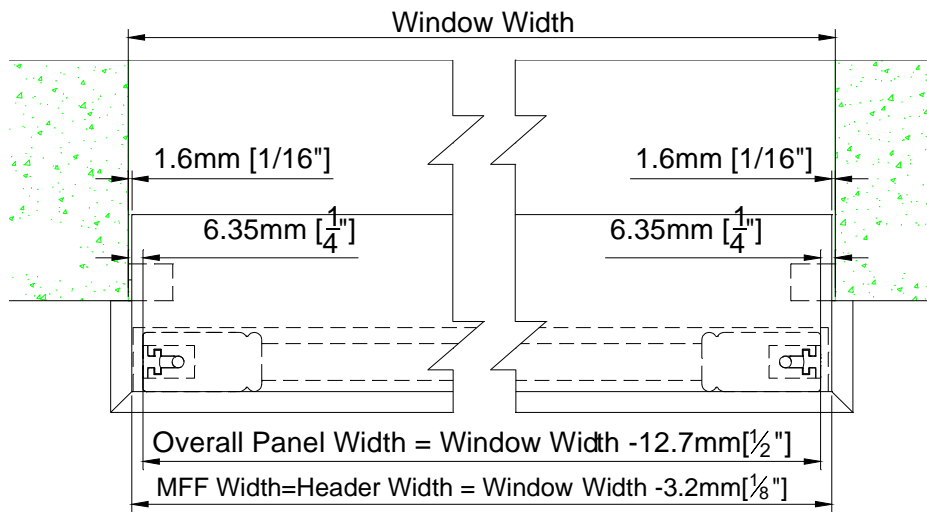

Inside Mount Top View

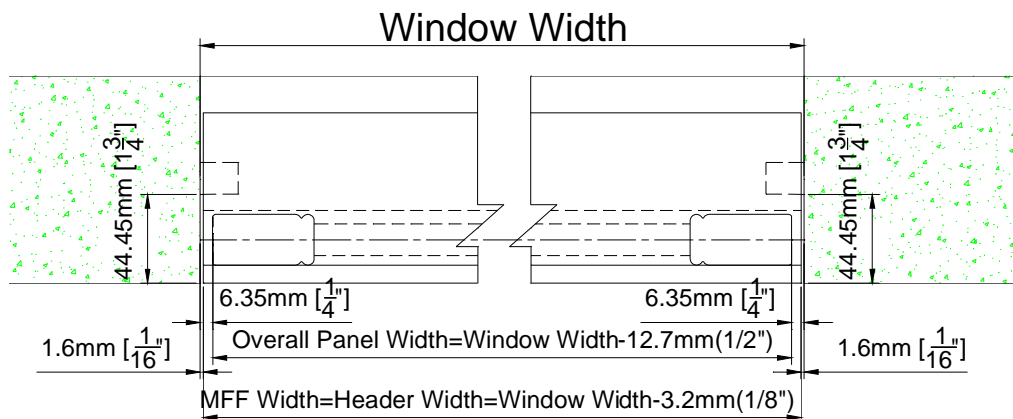

- ✧ Header Extension: Optional.
- ✧ Custom extension up to 2" for Header
- ✧ The extension will be pre-attached.

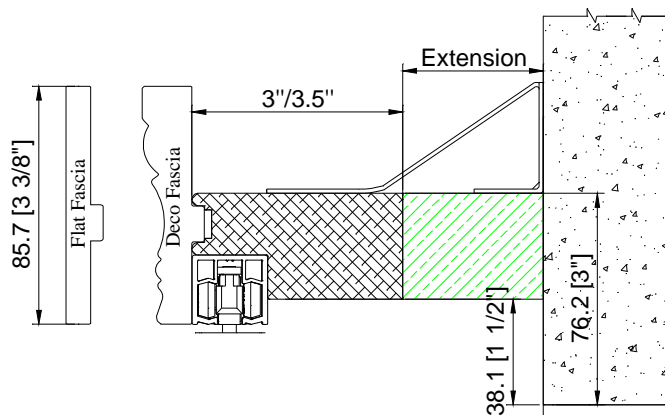



**Panel Configuration : Only 2", 2 1/4" rabbet and butt stiles are available. Center stile is not available.**

LL or RR

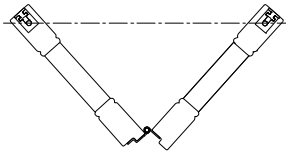

LLRR

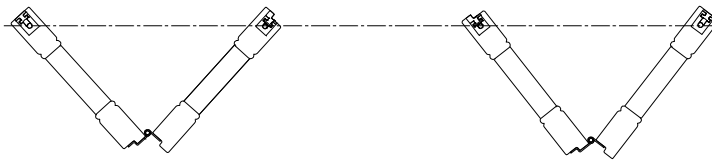

### 90° Multi-Fold Track Shutters (Wood only)

Maximum single panel width for multi-fold is 20"  
Panel Configuration: LLLL, RRRR, or LLLLRRRR

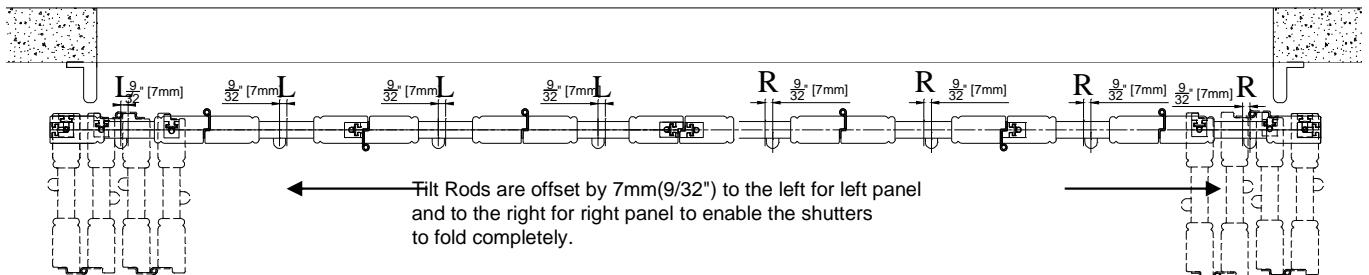

### 90° Floating Panels

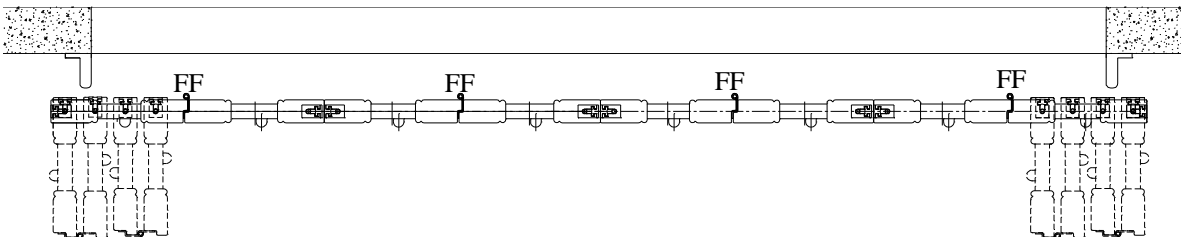

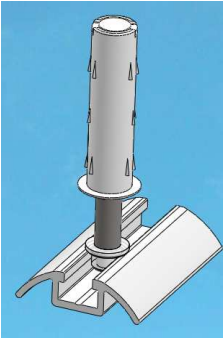

- Two or four panels can be hinged together, fold and slide to either direction
- Application comes with wheel carrier, spring loaded guide and floor track
- Can be used on large window

Note: For 90° Floating Panels outside mount/semi-inside mount without side boards, the 2016 Stopper will be supplied by default. The gap between the fascia return / end of top track and the panel is 5mm each side. The 2016 stopper can also be used in the center or any position of the top track as an option.

2016 Stopper

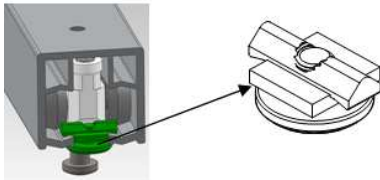

Please see drawing below to show the gap.

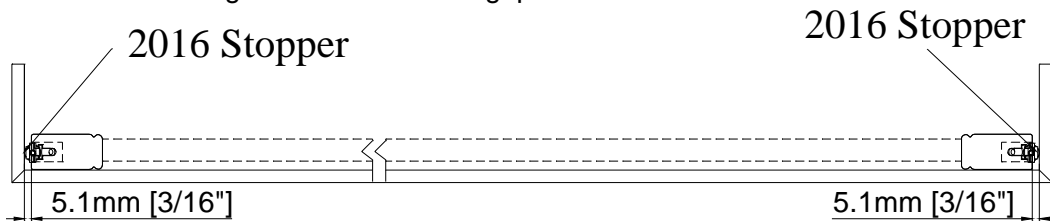

2. When rabbet stile required, the meeting stile of unhinged stile will be butt stile by default.

**Optional (Hang Strip for Inside Mount Only)**

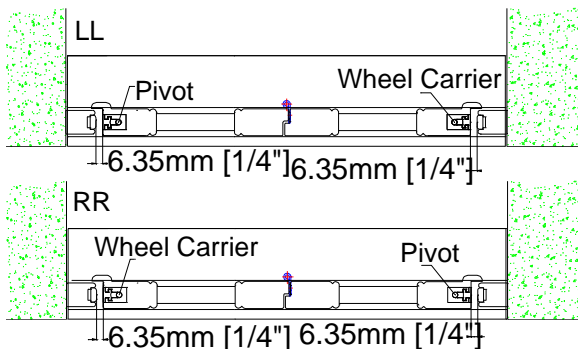

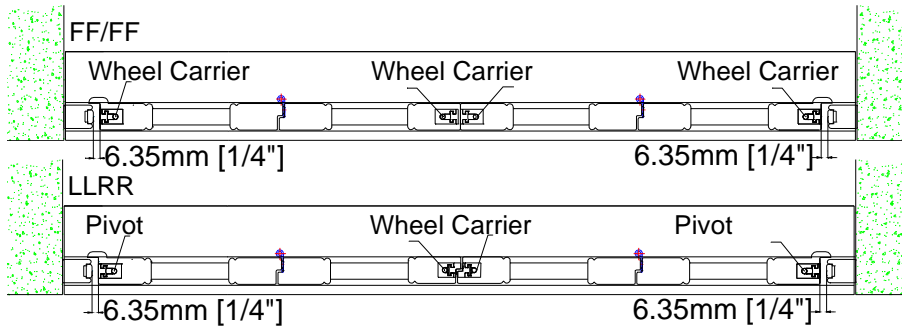

Note: When Butt/rabbit Stile is required, the stile next to the hang strip will be astragal stile.

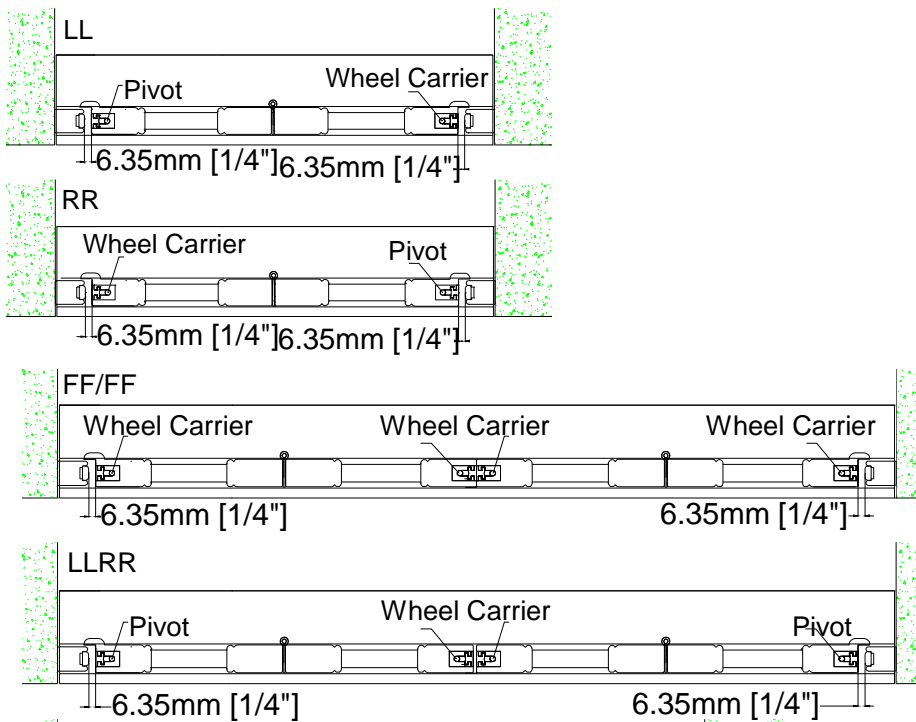

### 90 Degree Bi Fold Track Shutters Framing Materials

Type		Header Dimension	Top Fascia Dimension	Light Block Strip Dimension	Hang Strip Dimension
Header & Top Fascia & Light Block Strip	OM	3"	3 3/8"	1 9/16"	1.08"x0.875"
		3 1/2"		2 1/16"	
	Semi-IM	3"	5/8"x3/4"		
	IM	3"	5/8"x3/4"		

Note: It will be L shape light block strip for outside mount.

## Frame Hinged Bifold

Available Stile: Rabbet Stile Only

Available Frame type

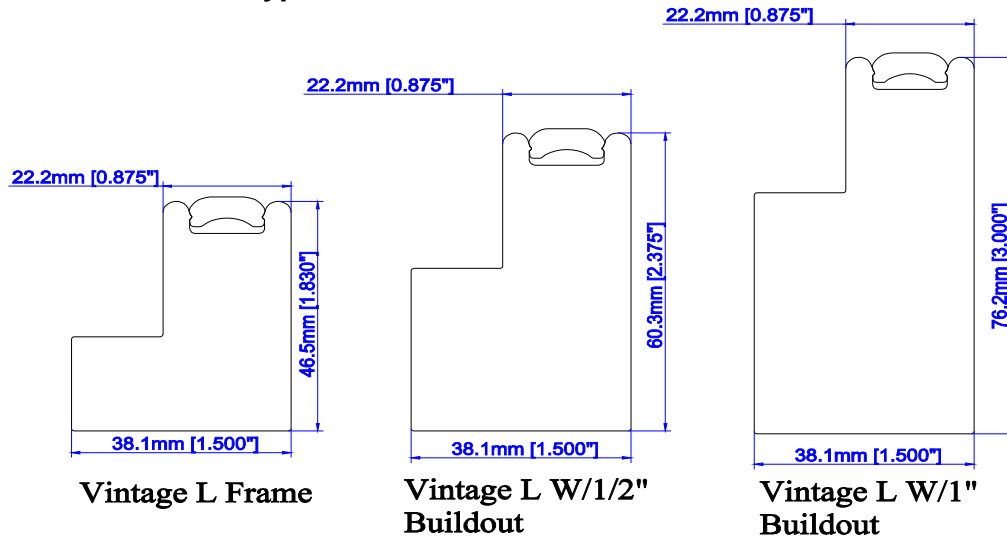

**Vintage Hang Strip with 13mm light block:** For single direction shutter with even panel qty, the frame on the unhinged side will be Vintage Hang Strip with 13mm [0.512"] light block, the height of the Vintage Hang Strip will match with that of the hinged side frame. The Vintage Hang Strip will be made in wood with surcharge.

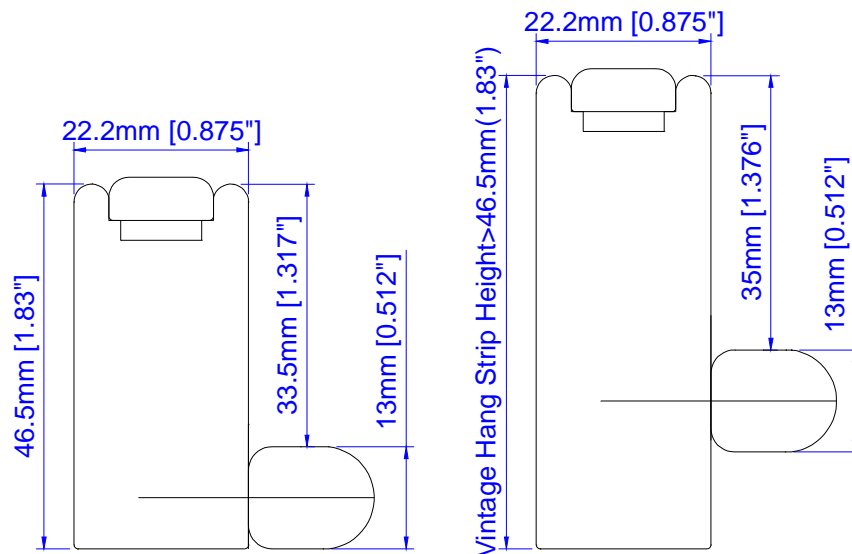

**Top View**

Hinged at Left or Right with wheel assembly at top;

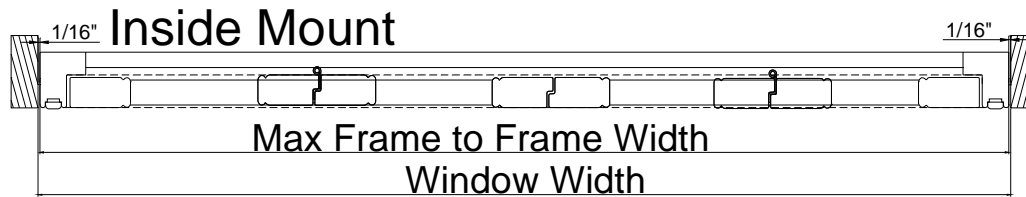
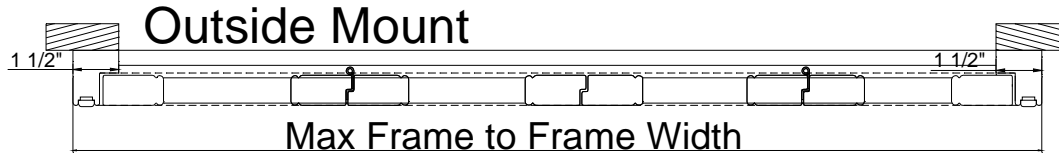

**Side View**

Outside Mount

3-Sides + bottom light block

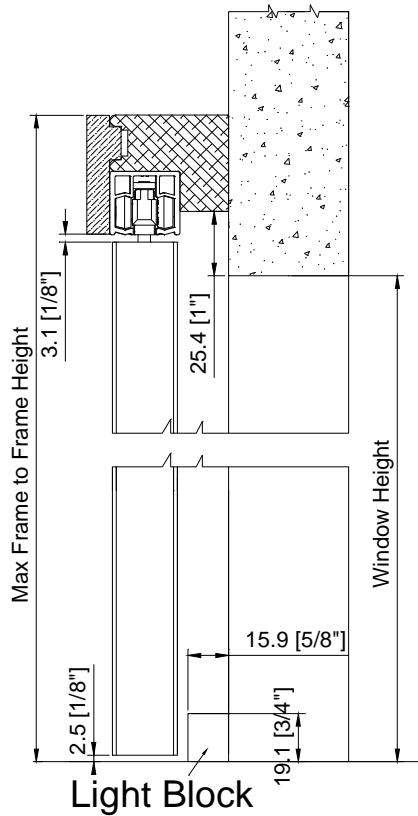

3-Sides + 3" Deco Sill Frame

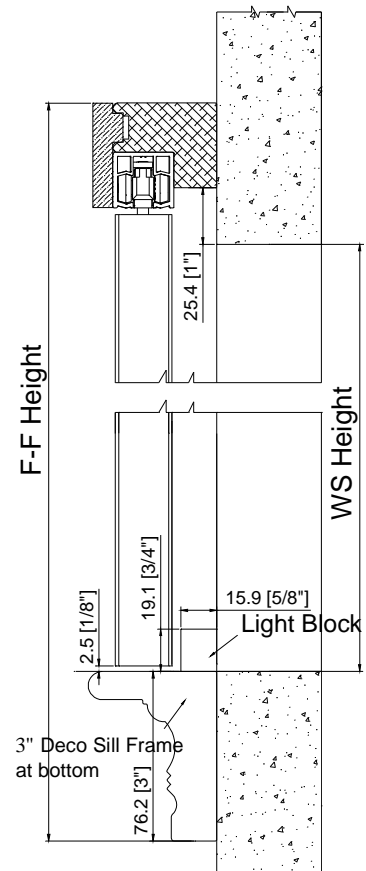

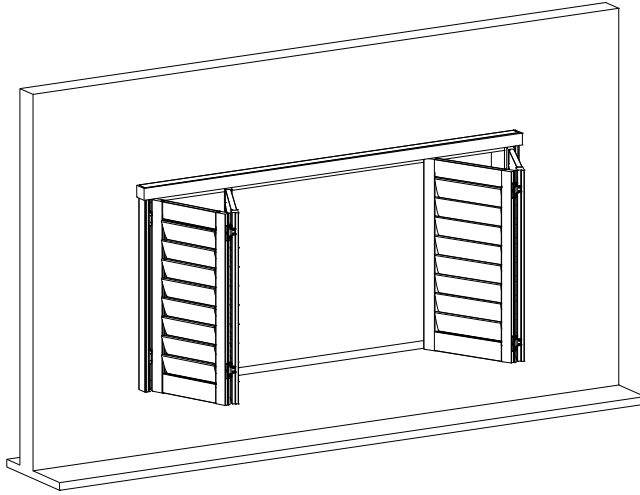

Note: For OM Frame Hinged Bifold shutter not to use as a door, if there is no existing sill at the bottom of the window opening, it is recommended to have the 3" Deco Sill Frame at the bottom.

Semi-Inside

Inside Mount

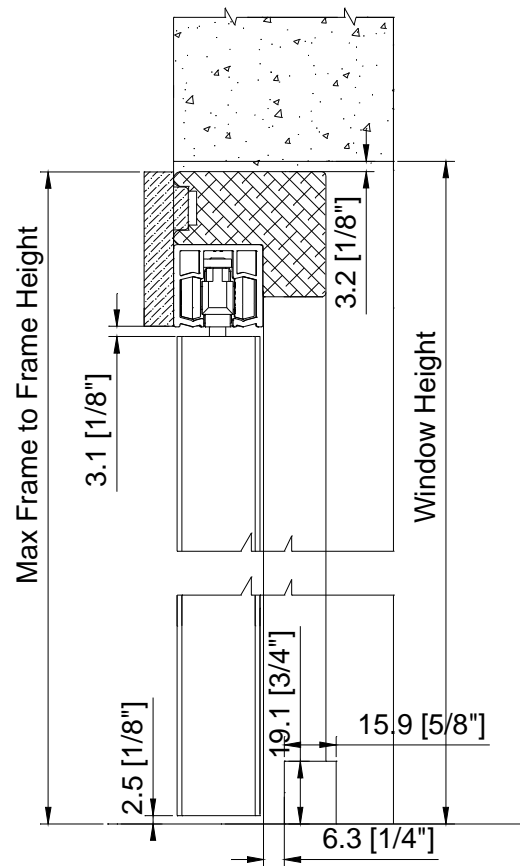
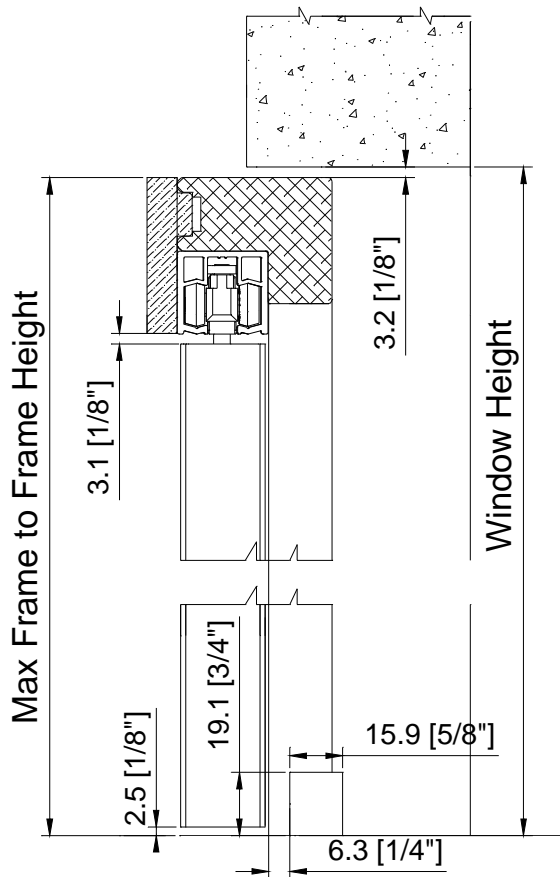

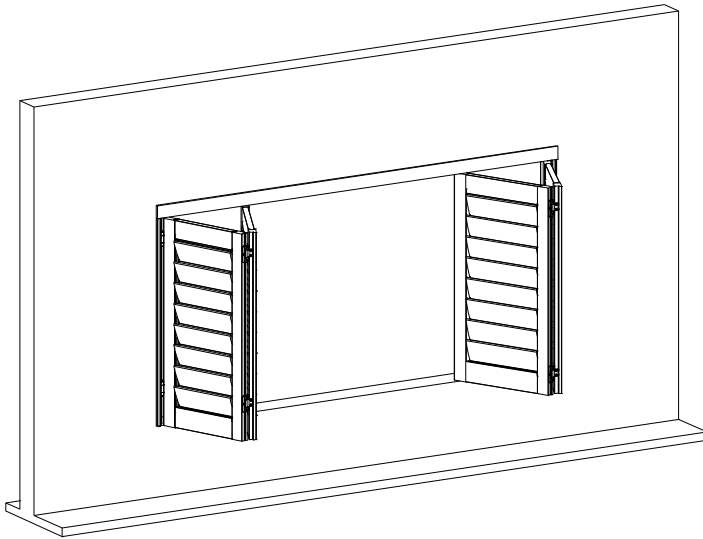

For frame hinged bifold track shutter used as door, the bottom gap will be 19mm by default. Please specify "Used As Door" on the order form.

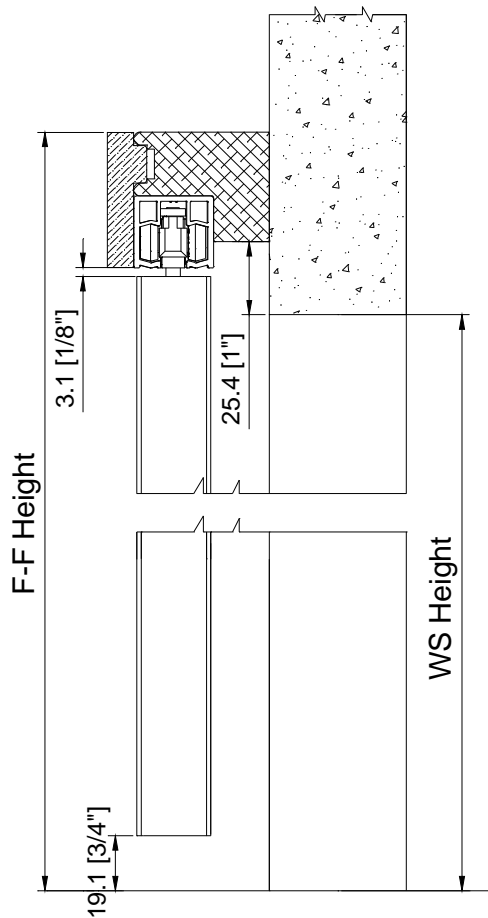

Panel Configuration (uneven panel width)

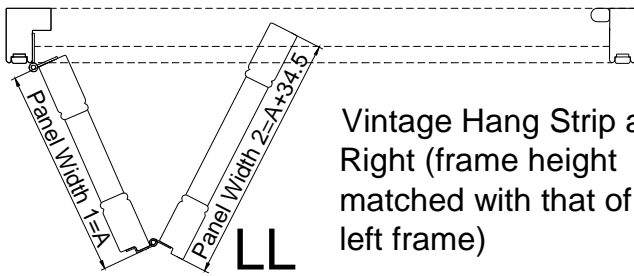

Vintage Hang Strip at Right (frame height matched with that of the left frame)

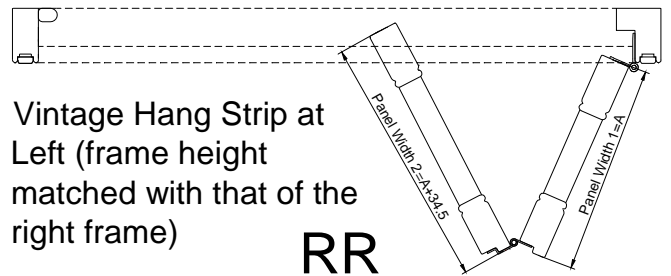

Vintage Hang Strip at Left (frame height matched with that of the right frame)

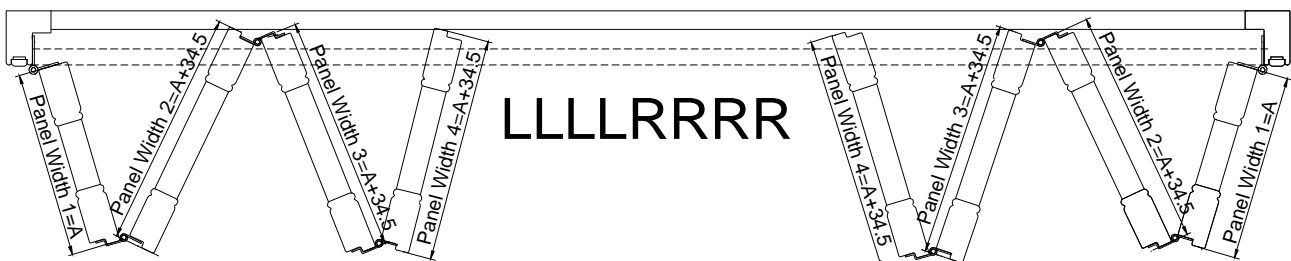
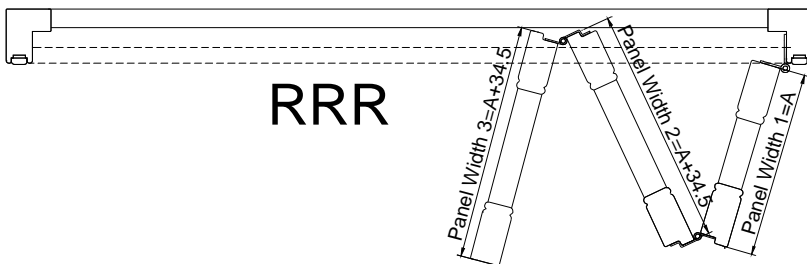
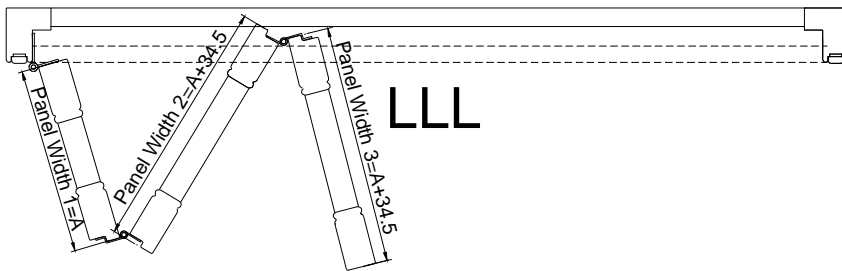
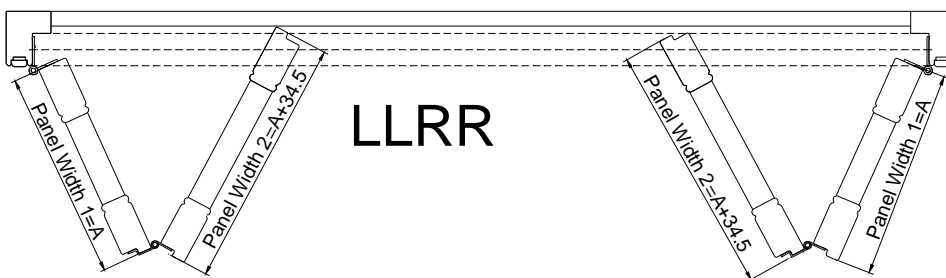



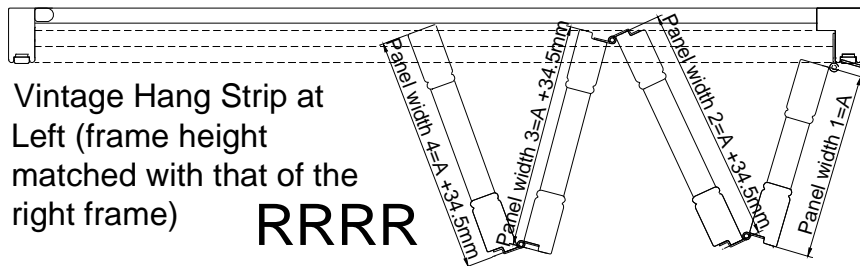
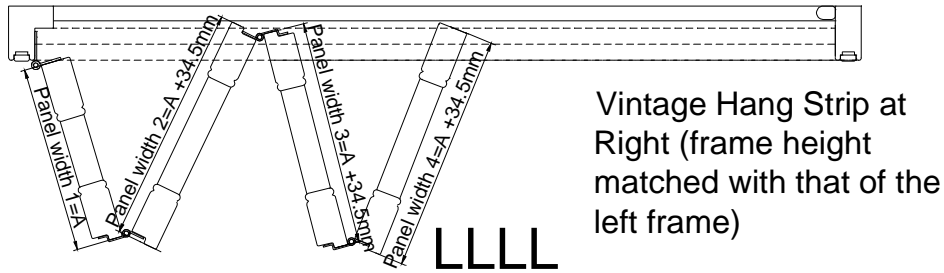

Notes:

1. Only available for 3-Sides + bottom light block or 3-Sides + 3" Deco Sill Frame (4-sides is not available); Panels can be folded and open at 90 degree;

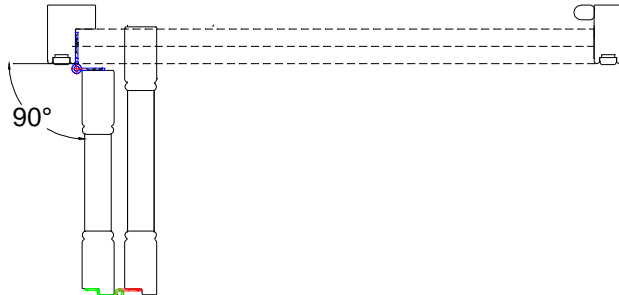

2. Frames available: Only Vintage L Frame
  - 1) For top frame, the insert will be replaced by top fascia;
  - 2) Top track will be pre-attached to the top frame;
  - 3) Frame will be pre-drilled with screw holes same as regular shutters.

**Ring Pull:** The ring pull will be provided as an option; and for frame hinged bi-fold, the ring pull will be supplied as default; Customer need specify ring pull location on the order form. Ring pull location is measured from the floor to center of the ring pull in height direction. Ring pull color will match the hinge color.

Please refer to below drawing of ring pull position for all shutter type:

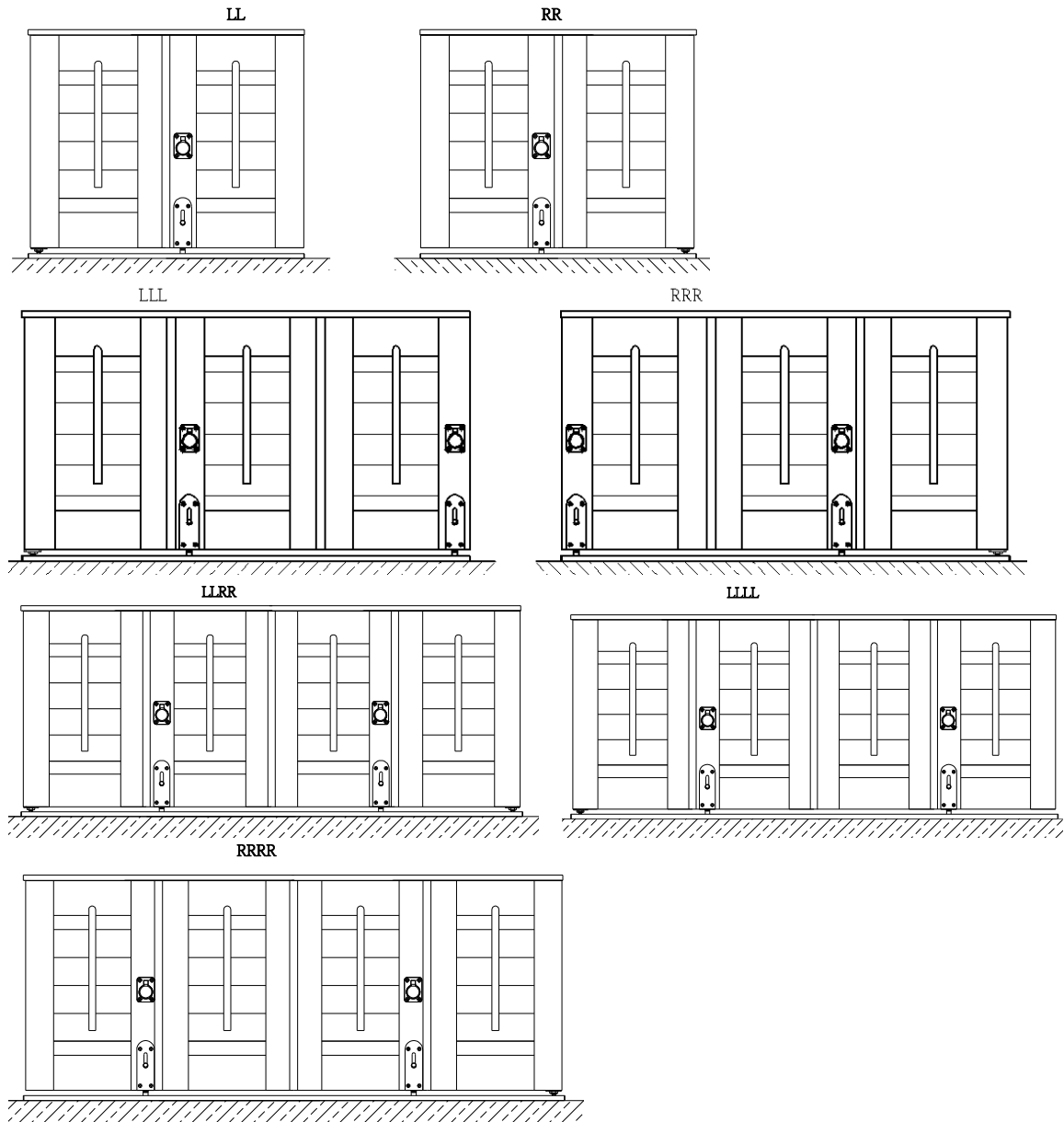

**Bottom Pivot Bracket for 90 degree bifold:**

For 90° Bifold Track Shutter, there will be 2 types of Bottom Pivot Brackets available.

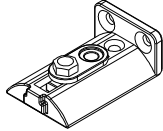

For Inside Mount, Bottom Pivot L Bracket will be supplied as default;

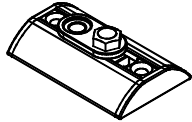

For Semi-Inside or Outside Mount, bottom pivot bracket will be supplied as default.

For 180° Bifold Track Shutter, 81mm Bottom Pivot L Bracket will be supplied as default.

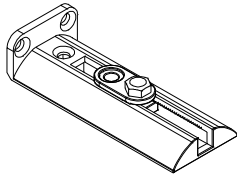

**Track Dimension:**

Top Track

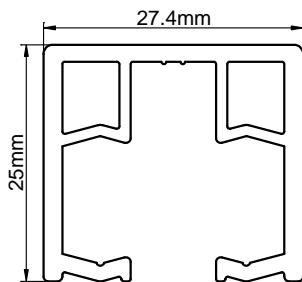

**Extra Magnets will be supplied for Bifold hinges: (only for the most top and bottom hinges)**

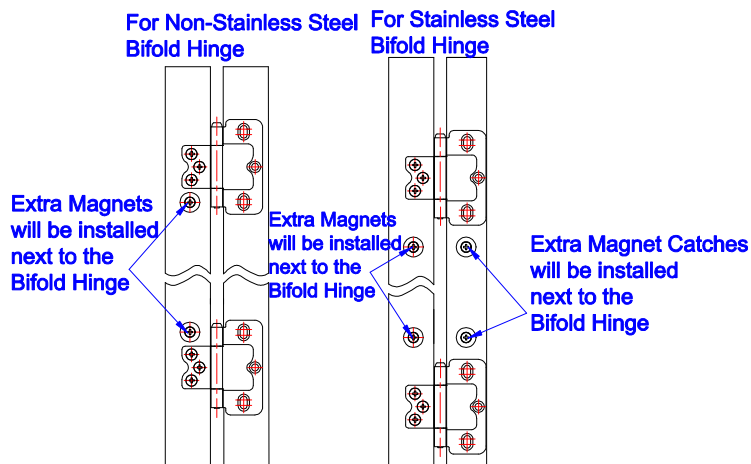

**Side Magnet:** applied to the meeting stiles of LR panels

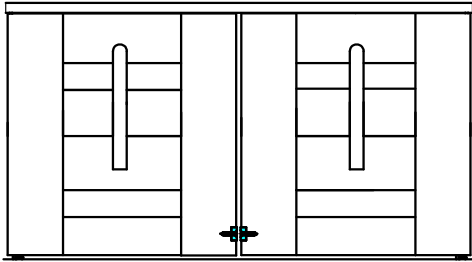

**Extra magnet and Side Magnet:**



### 90° Bi Fold Track Shutters Hardware Box

Parts
Wrench
Hinge Pin
Support L Bracket (based on the length of header)
2 ½ " screws for support L bracket
¾ " screws for support L bracket
Bottom Pivot Bracket
38.1mm screws for bottom pivot bracket
63.5mm screws for Frame with Predrilled holes

#### Notes:

1. for all bifold track shutter Outside Mount, the header will be pre-drilled with screw holes in the insert and screws will be supplied by default;
2. for all bifold track shutter Inside/Semi-Inside Mount, the header will be pre-drilled with holes for screws and wood plug, screws and wood plug will be supplied by default

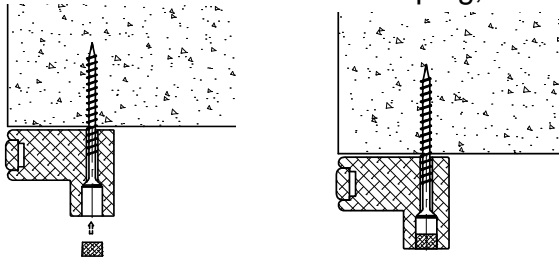

**90 Degree Bifold Track & Floating Panels Hanger Location:**

**LL/RR/LLRR**

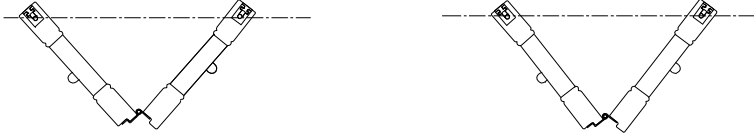

**LLL/RRR/LLLRRR**



**LLLL/RRRR/LLLLRRRR**

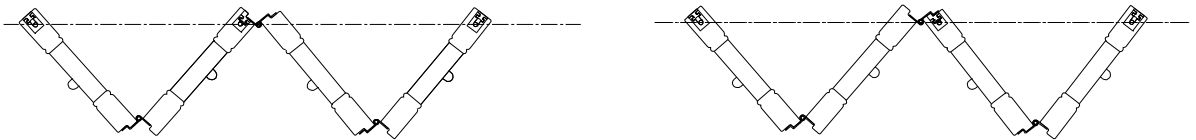

**180 Degree Bifold Track Panel Hanger Location:**

**LL/RR/LLRR**

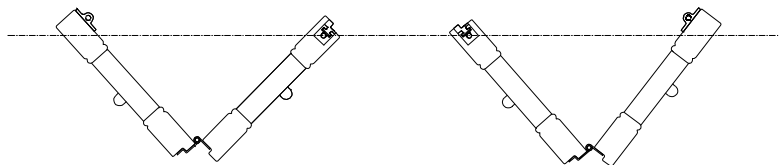

**LLL/RRR/LLLRRR**

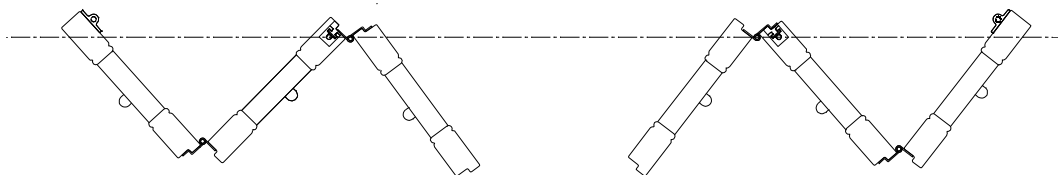

**Frame Hinged Bifold Track Panel Hanger Location:**

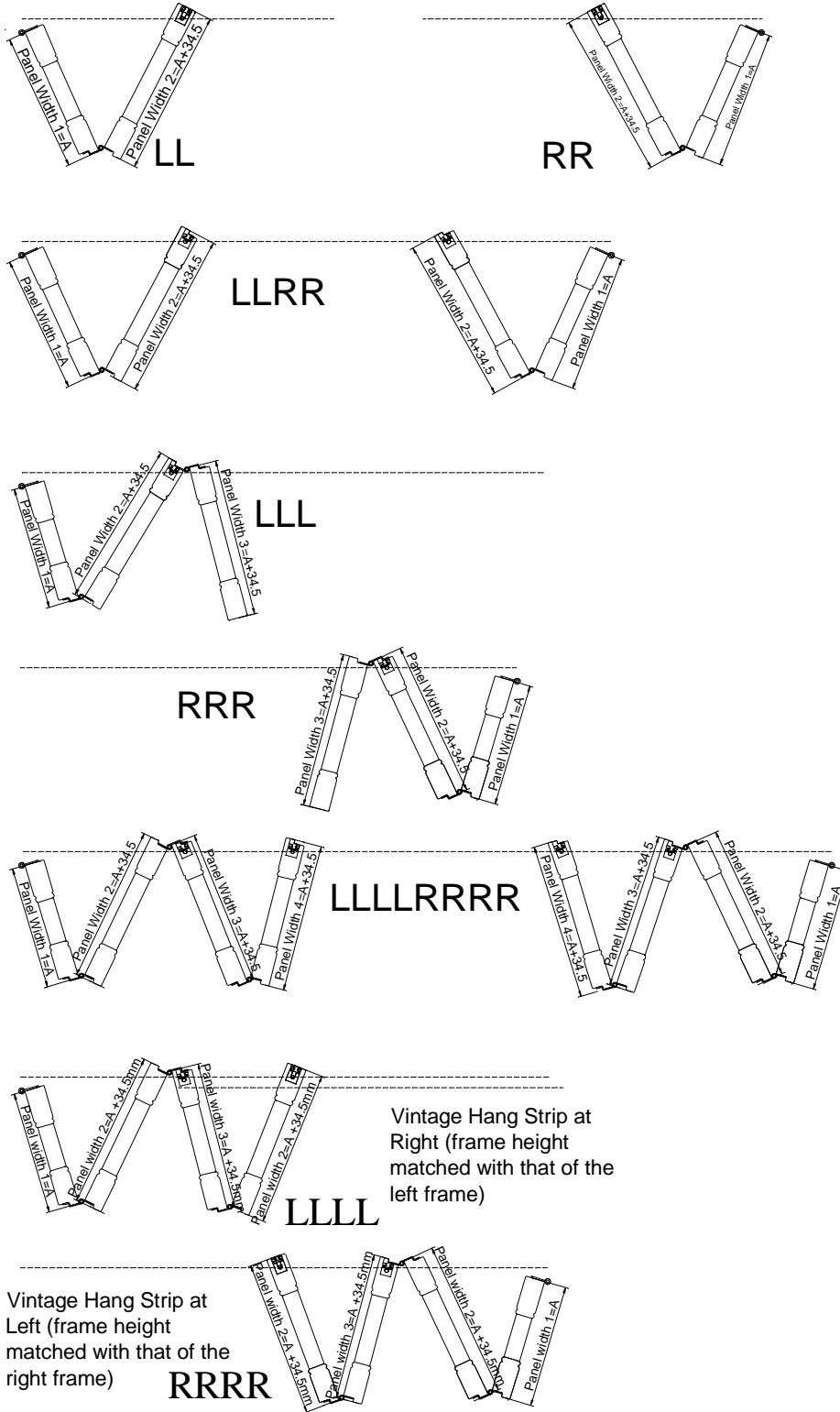

## Keystone for Fascia of the Track Shutter

When fascia length exceeds the limitation and needs to split, keystone design fascia will be supplied without surcharge for track shutters.

For fascia length within the split limitation, keystone can also be supplied as an option with surcharge.

For Deco Fascia:

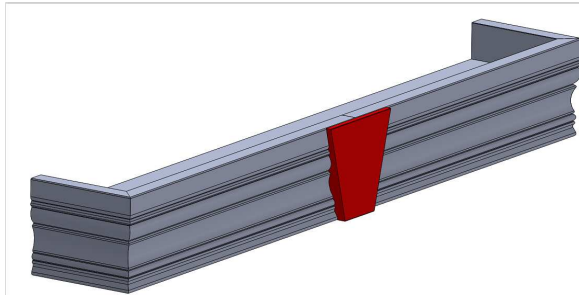

For Flat Fascia:

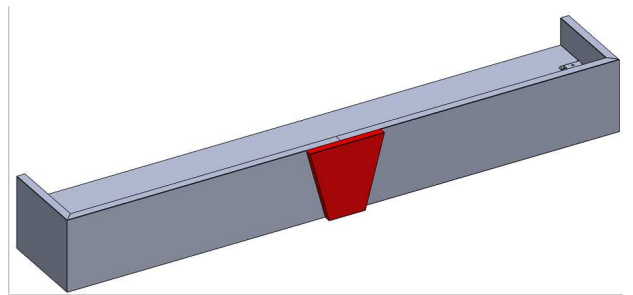

The keystone will be installed by screws. We will pre-drill the screw holes and the screws will be packed in hardware box.

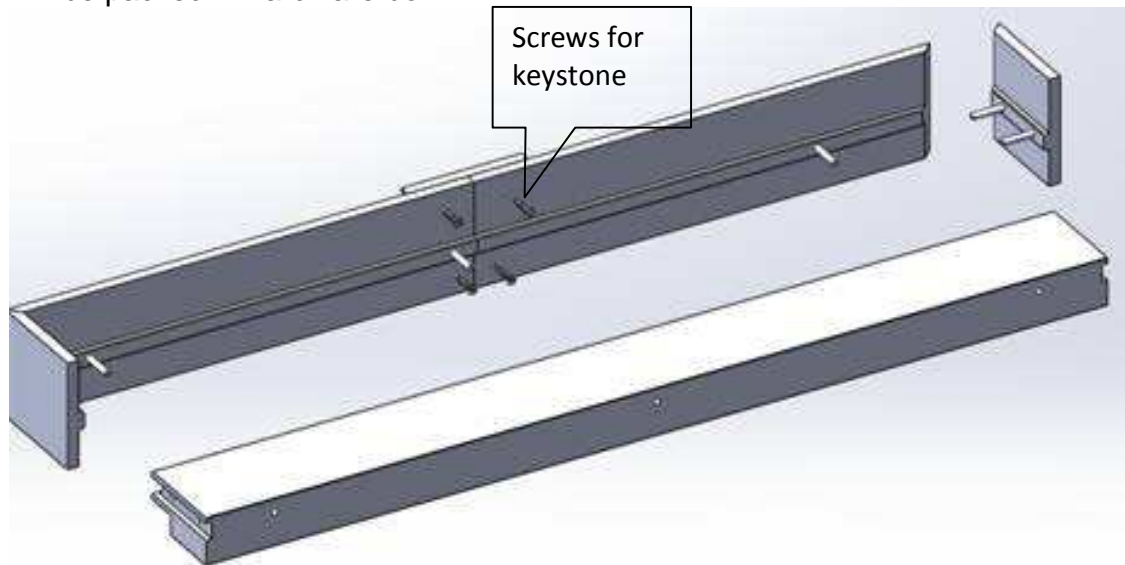

# Track Shutters—Bypass



## Guidelines and Specs:

<u>Description</u>	<u>Minimum</u>	<u>Maximum</u>		
		1 $\frac{7}{8}$ "	2 $\frac{1}{2}$ " , 3"	3 $\frac{1}{2}$ " ; 4 $\frac{1}{2}$ "
Single-Panel Width (Wood)	6"	30"	36"	42"
Single-Panel Height	10"	132"	132"	132"

### Outside Mount

Max frame-to-frame width: window width + 3"

Max frame-to-frame height: window height + 4 $\frac{1}{2}$ "

### Semi-Inside Mount

Max frame-to-frame width: window width -  $\frac{1}{8}$ "

Max frame-to-frame height: window height + 1  $\frac{3}{8}$ "

### Inside Mount

Max frame-to-frame width: window width -  $\frac{1}{8}$ "

Max frame-to-frame height: window height -  $\frac{1}{8}$ "

### Carriers are in the Track / Hangers are in the Panel:

Adjustments to panel alignment are made by turning the Carrier Bolt with the wrench included in the Hardware Box

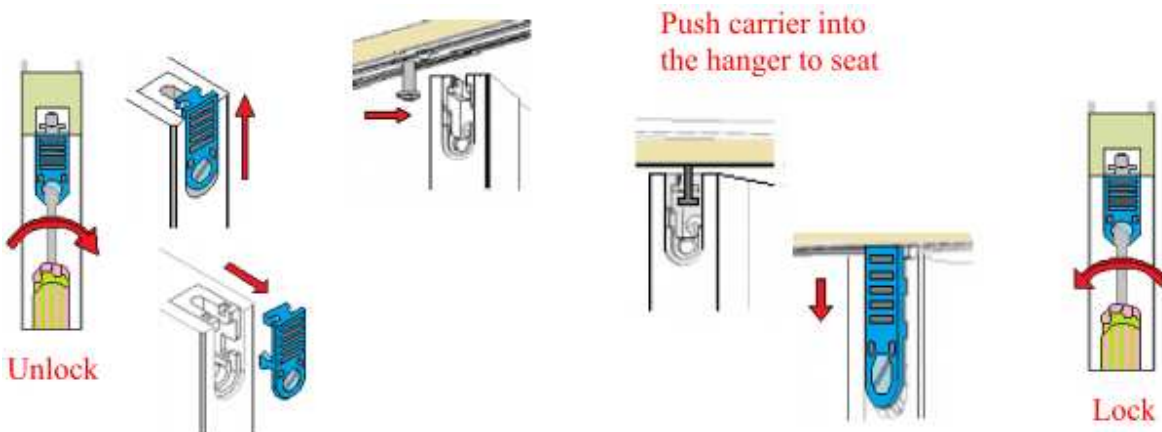



# Track Shutters—Bypass



## Top View

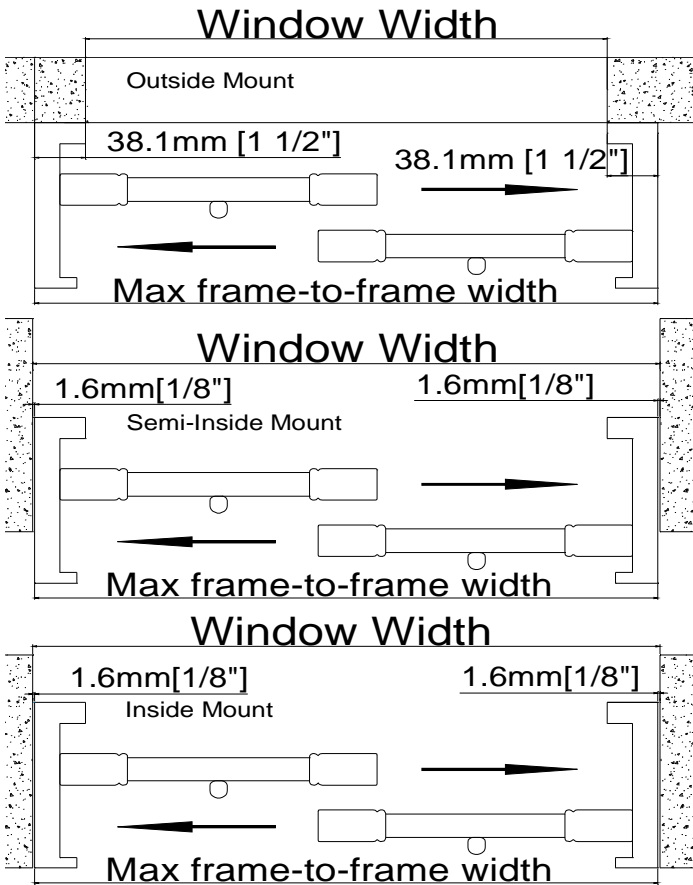

## Size Definition

### For Semi-Inside/OM without side boards

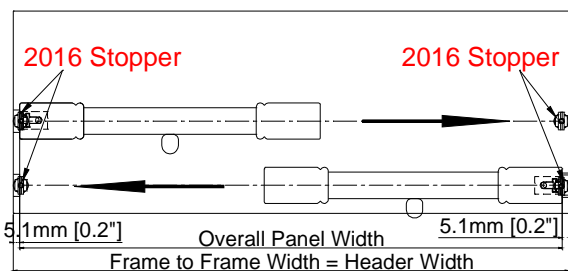

### For IM without side boards

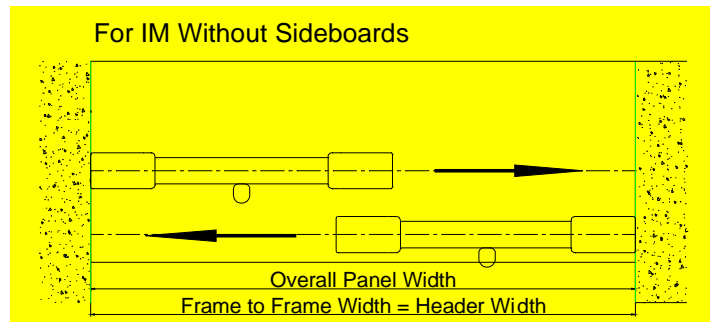

**Note:** For Semi-Inside/OM bypass without side boards, 2016 Stopper will be supplied.

# Track Shutters—Bypass



## Top View

Combi - joined Panels (optional)

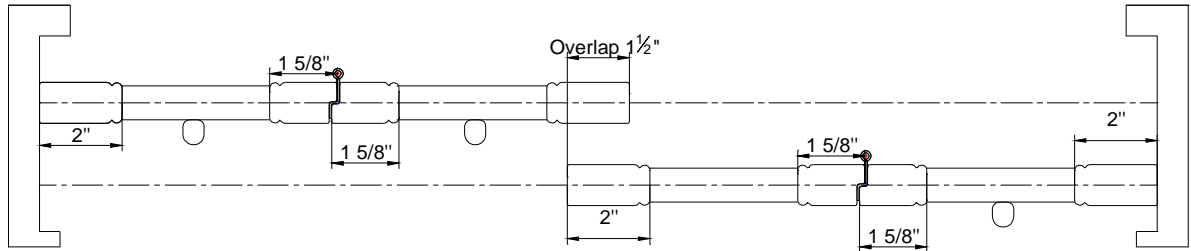

For shutters with 4 or more panels, please select "side open" or "center open"

### Side Open

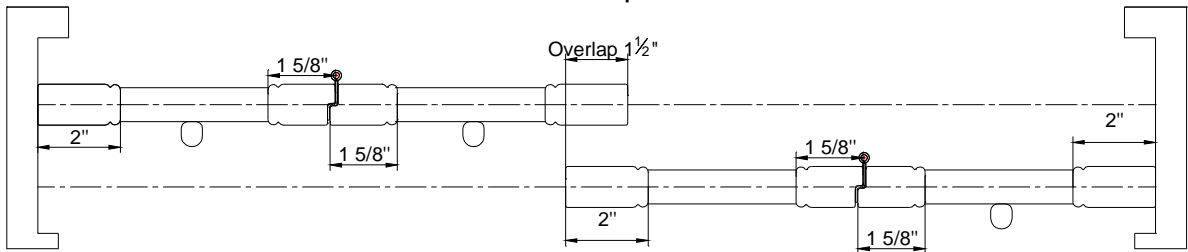

### Center Open

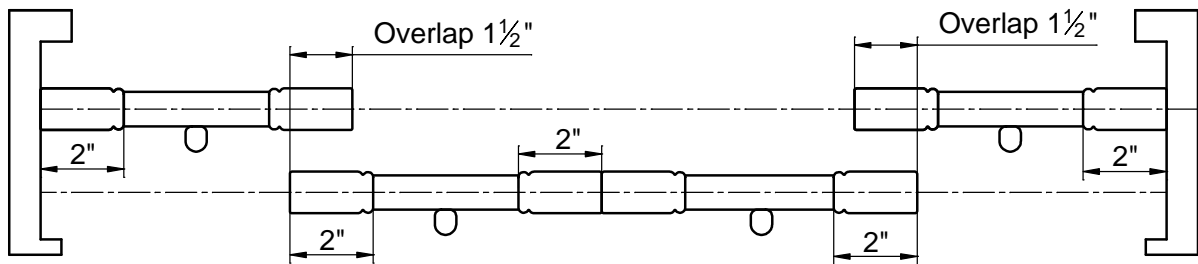

# Track Shutters—Bypass



## 4 panels side open w/Rabbit stile

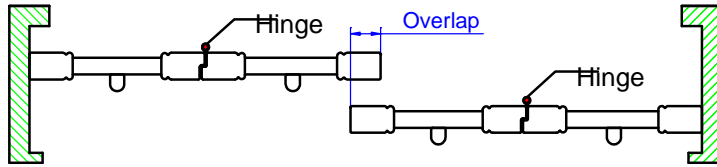

## 4 panels center open w/Rabbit stile

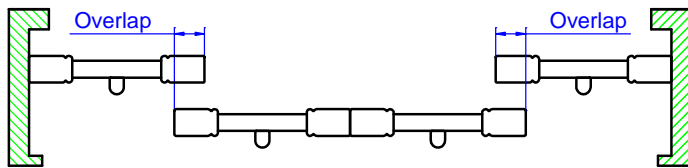

## 6 panels side open w/Rabbit stile

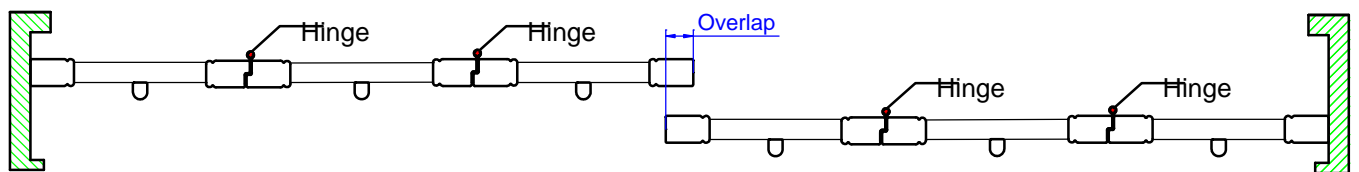

## 6 panels center open w/Rabbit stile

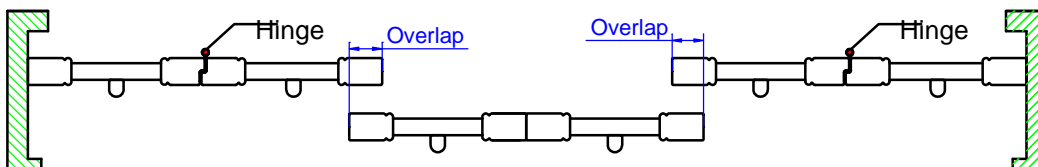

**Stile:** Only 2", 2 1/4" butt and rabbit stiles are available,  
1 5/8" rabbit stile only used for combi-joined panels.  
Center stile is not available.

# Track Shutters—Bypass



## Mounting Options (Closed Bypass)

### Side View

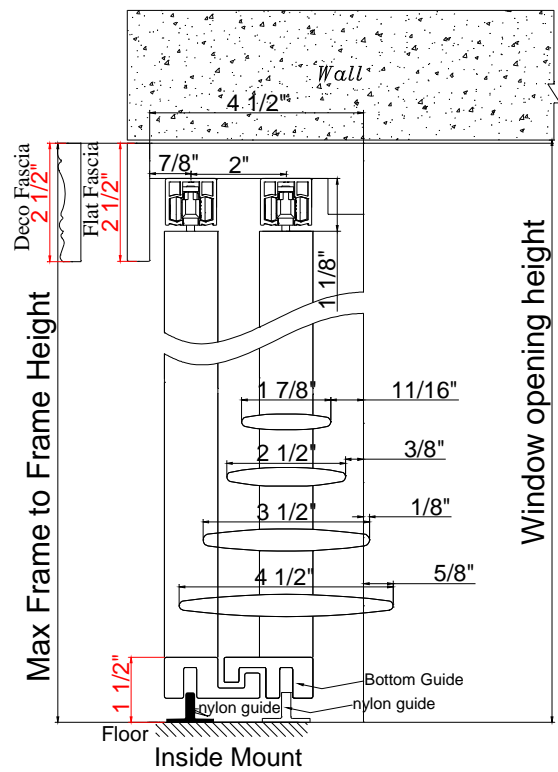
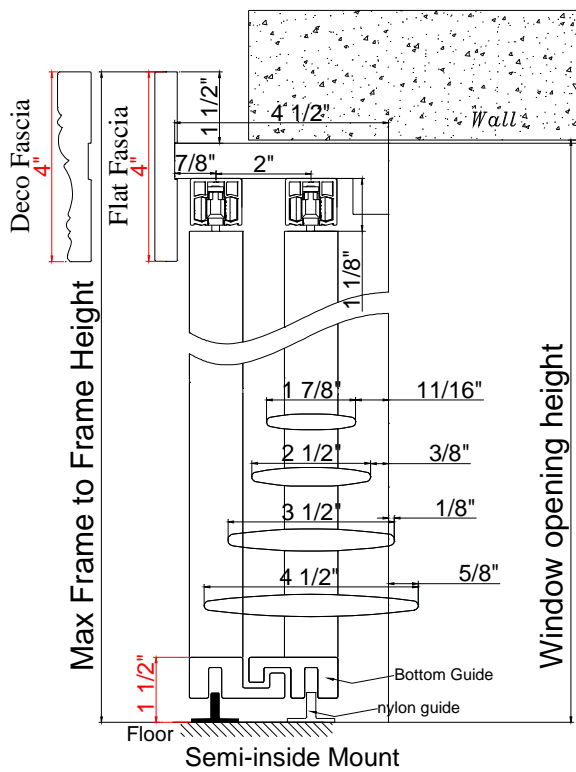
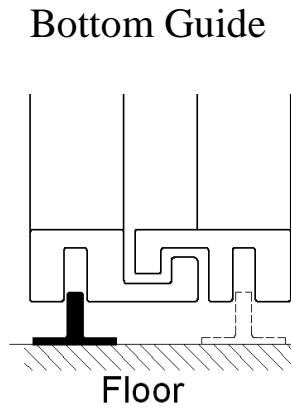
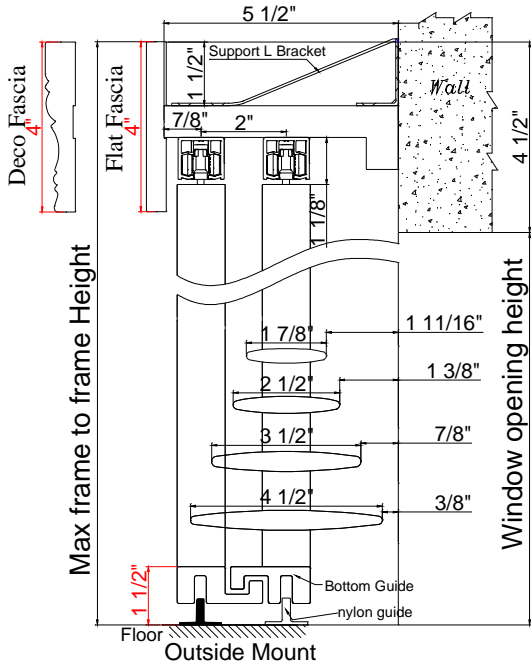

# Track Shutters—Bypass



## Mounting Options (Closed Bypass with 3 Tracks):

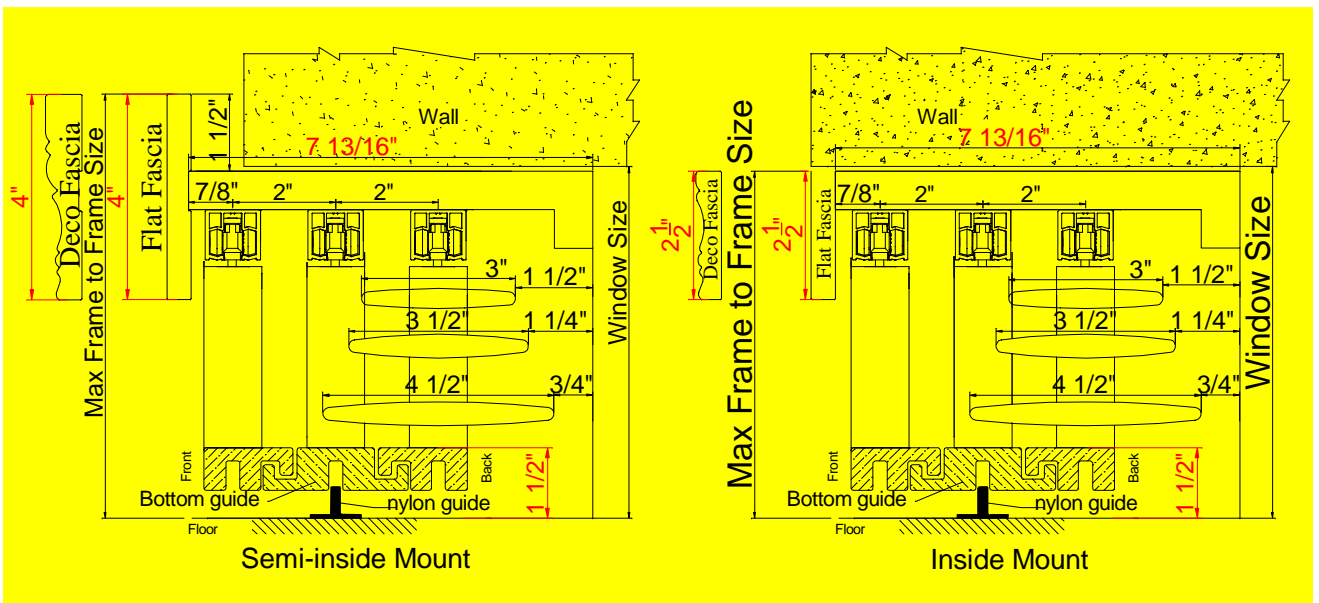
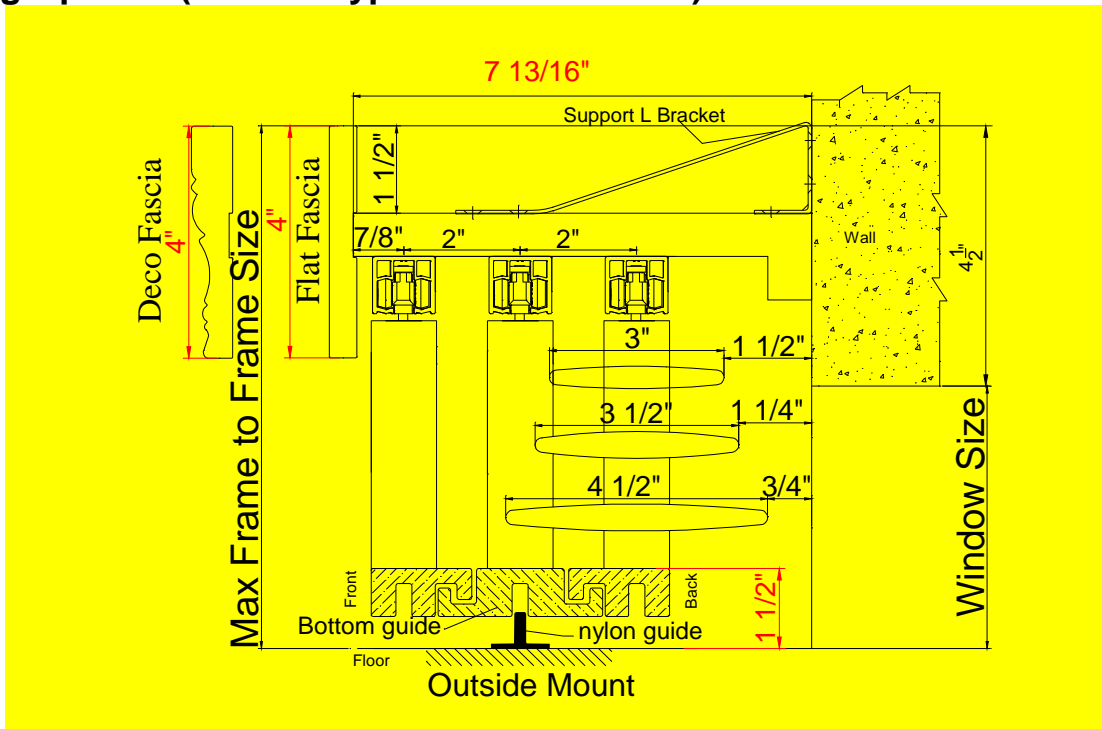

# Track Shutters—Bypass

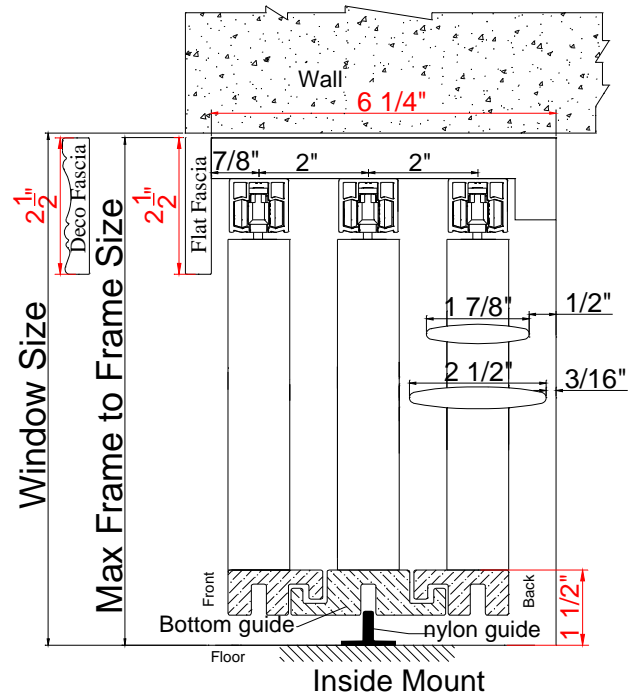
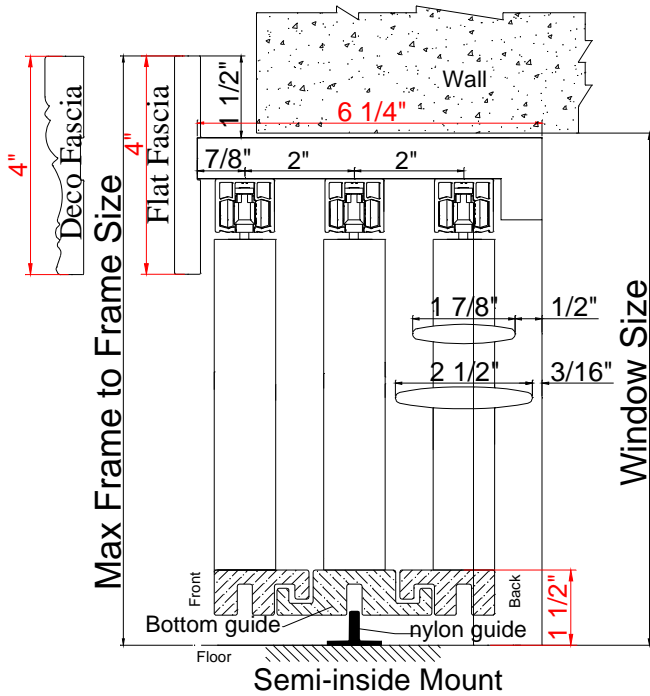
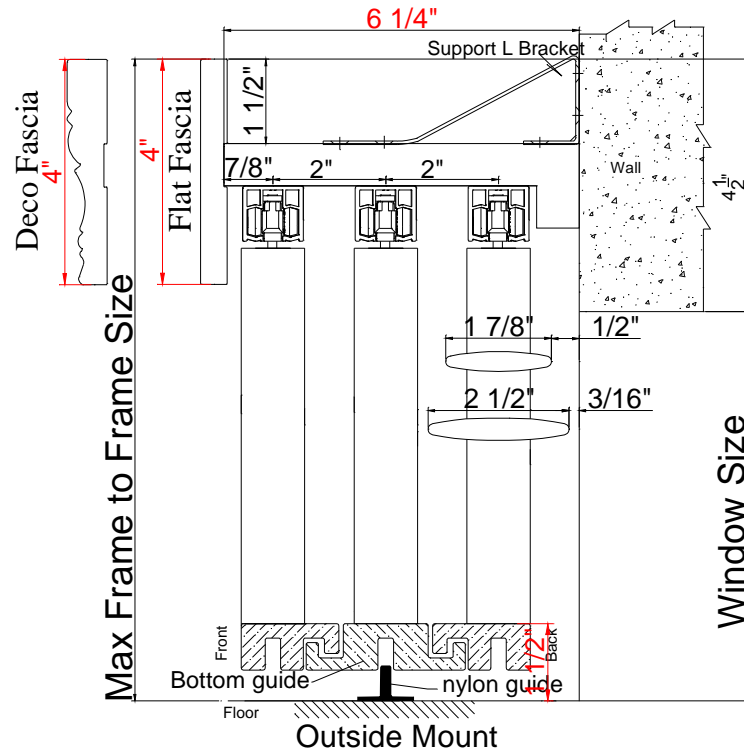

# Track Shutters—Bypass



## Mounting Options (Opened Bypass)

Only available in 2 1/2", 3" and 3 1/2" louver sizes

### 2 1/2" Louver

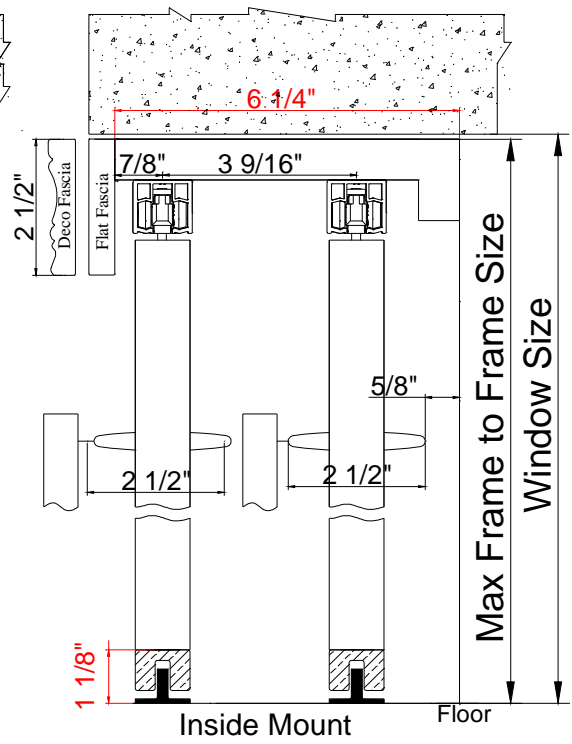
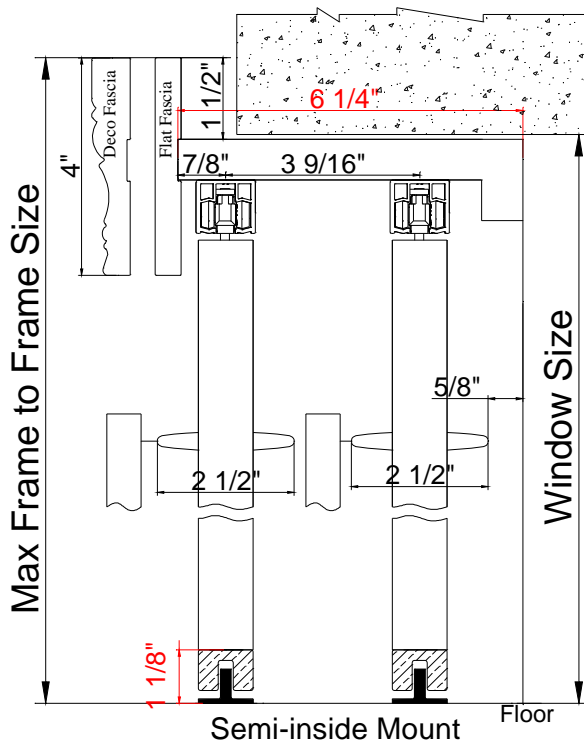
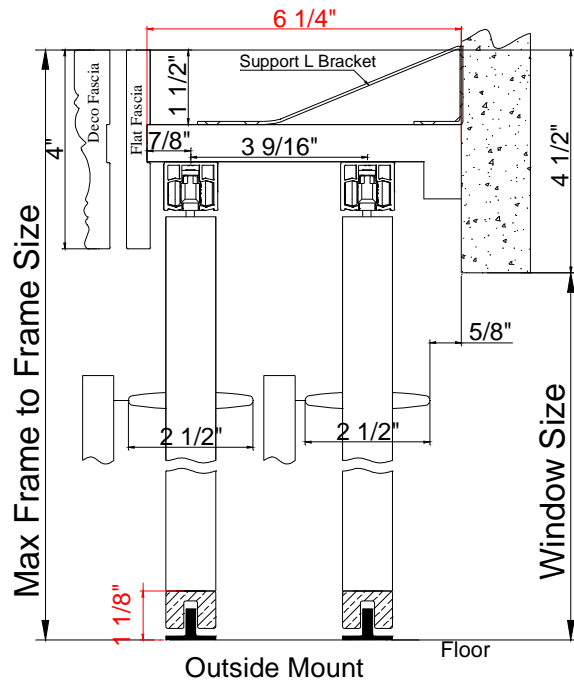

# Track Shutters—Bypass

**3" / 3 1/2" Louver**

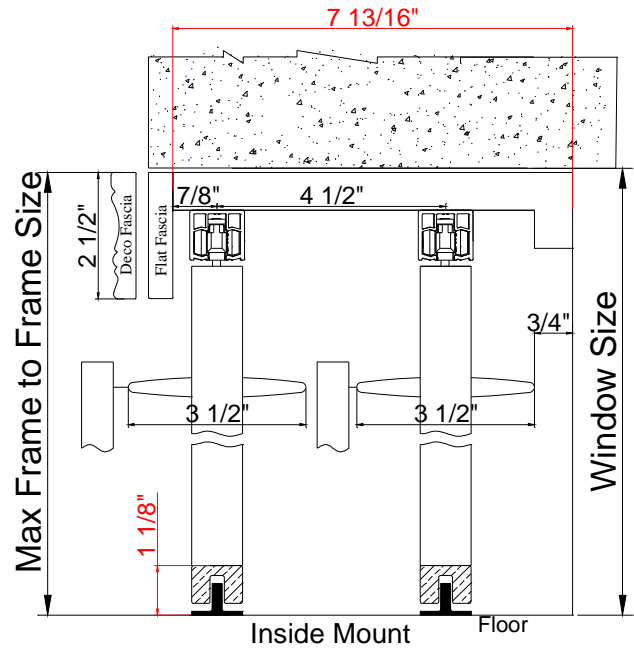
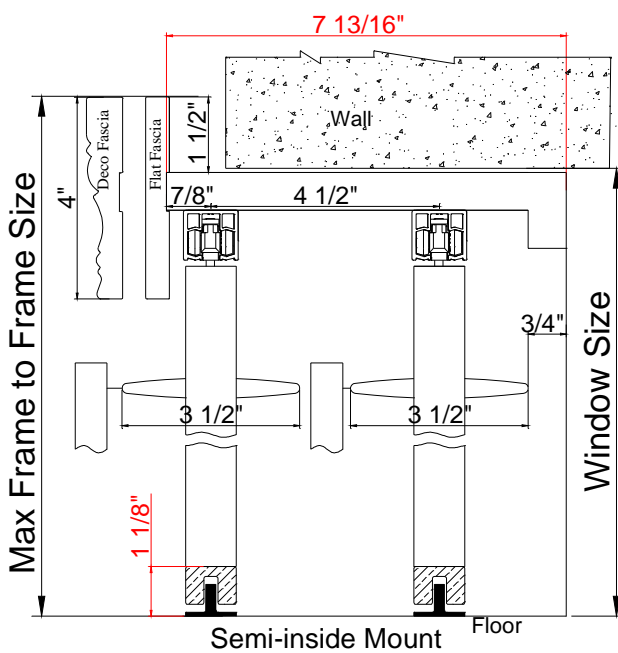
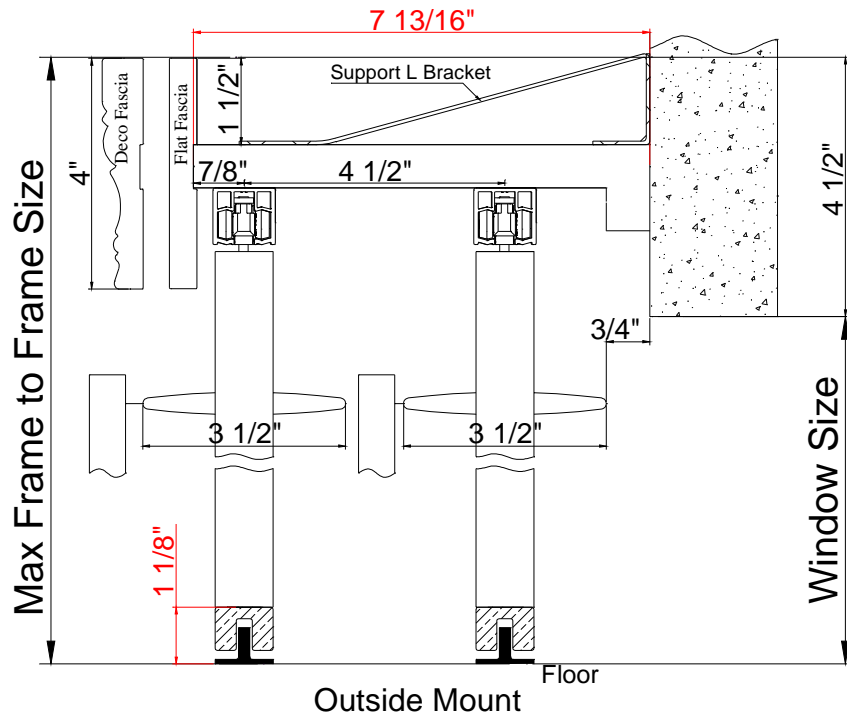



# Track Shutters—Bypass



Open By Pass: has 2 kinds of bottom guide

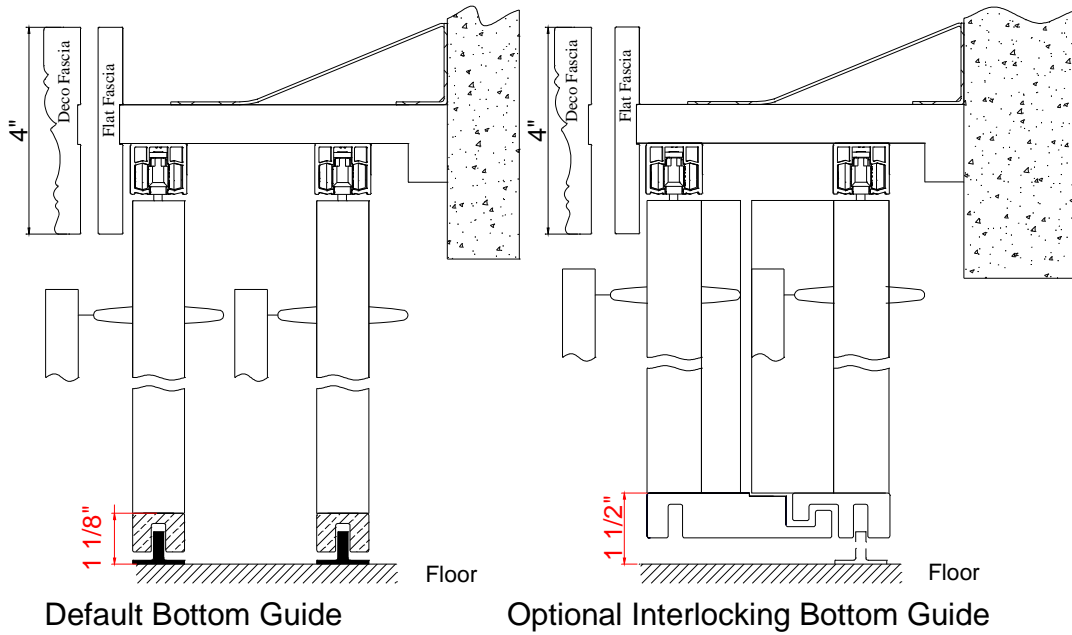

Default Bottom Guide

Optional Interlocking Bottom Guide

## Opened Bypass

### Top View

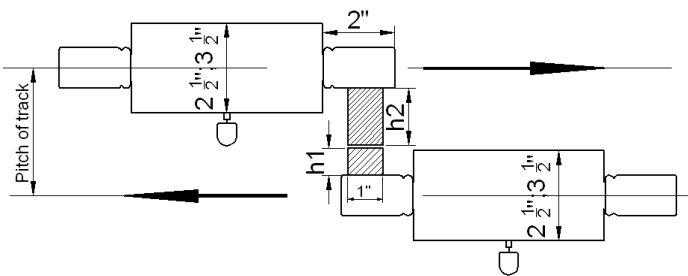

Note: The light block for open bypass will be changed to use screws with wood plugs instead of current dowels.

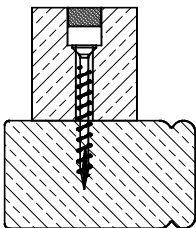

### Separation of track

Louver	U shape bottom guide		Interlocking bottom guide	
	Regular Tilt Rod	Invisible tilt	Regular Tilt Rod	Invisible tilt
2.5"	3 9/16"	2 3/4"	3 9/16"	3 9/16"
3" / 3.5"	4 1/2"	3 5/8"	4 1/2"	4 1/2"

# Track Shutters—Bypass



Light block thickness for panel

Louver		U shape bottom guide		Interlocking bottom guide	
		Regular Tilt Rod	Invisible tilt	Regular Tilt Rod	Invisible tilt
2.5"	h1	3/4"	3/4"	3/4"	3/4"
	h2	1 9/16"	3/4"	1 9/16"	1 9/16"
3" / 3.5"	h1	1 3/16"	1 3/16"	1 3/16"	1 3/16"
	h2	1 15/16"	1 3/16"	1 15/16"	1 15/16"

**Nylon Guide:** The nylon guide is composed by 2 parts and will be supplied as a whole set by default (bottom part 16mm and top part 5mm), please remove the top part if necessary.

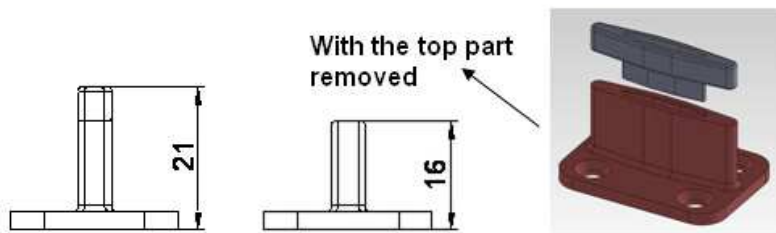

## The 2016 Stopper

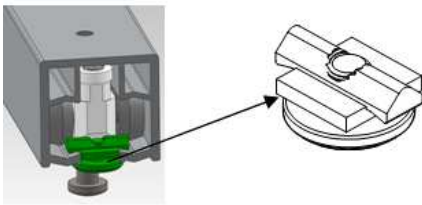

For outside mount/semi-inside mount bypass without side boards, the 2016 Stopper will be supplied by default. The gap between the fascia return / end of top track and the panel is 5mm each side. The 2016 stopper can also be used in the center or any position of the top track as an option. Please see drawing below to show the gap.

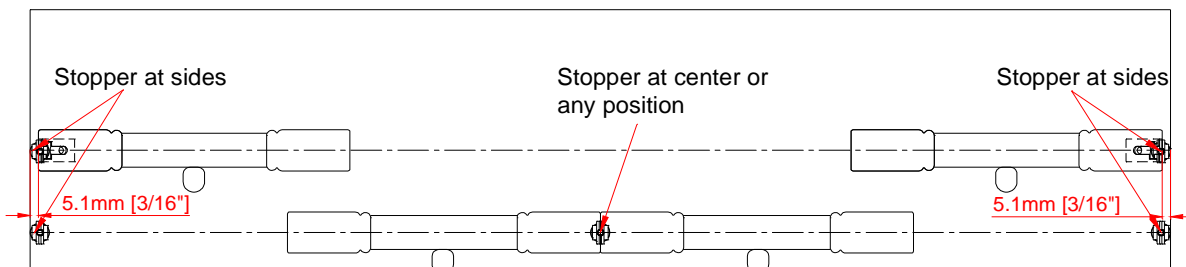

# Track Shutters—Bypass



## Track Shutters Framing Materials

Framing	Size			Pc(s)	
<b>L Shape Header</b>	<b>Header (Closed Bypass)</b>	<b>Header (Opened Bypass)</b>	<b>Supporting Strip</b>	1 pc	
<b>(2 in 1)</b>	$\frac{3}{4}$ " x $5\frac{1}{2}$ "* (Default for Outside Mount; Optional for Semi-Inside and Inside Mount)	$\frac{3}{4}$ " x $6\frac{1}{4}$ "* ( $2\frac{1}{2}$ " Louver)	$\frac{3}{4}$ " x $\frac{3}{4}$ "		
Header with Supporting Strip	$\frac{3}{4}$ " x $4\frac{1}{2}$ "* (Default for Semi-Inside and Inside Mount; Optional for Outside Mount)	$\frac{3}{4}$ " x $7\frac{13}{16}$ "* ( $3\frac{1}{2}$ " Louver)			
	Custom * $\leq 8$ "	Custom * $\leq 8$ "			
<b>U Shape Side Frame</b>	<b>Side Frame (Closed Bypass)</b>	<b>Side Frame (Opened Bypass)</b>	<b>Supporting Strip</b>	<b>Side Fascia</b>	2 pcs
<b>(3 in 1)</b>	$\frac{3}{4}$ " x $5\frac{7}{8}$ "* (Default for Outside Mount; Optional for Semi-Inside and Inside Mount)	$\frac{3}{4}$ " x $6\frac{5}{8}$ "* ( $2\frac{1}{2}$ " Louver)	$\frac{3}{4}$ " x $\frac{3}{4}$ "	$\frac{3}{8}$ " x $1\frac{1}{4}$ "	
Side Frame with Supporting Strip & Side Fascia	$\frac{3}{4}$ " x $4\frac{7}{8}$ "* (Default for Semi-Inside and Inside Mount; Optional for Outside Mount)	$\frac{3}{4}$ " x $8\frac{1}{4}$ "* ( $3\frac{1}{2}$ " Louver)			
	Custom * $\leq 8$ "	Custom * $\leq 8$ "			
Top Fascia (Plain/Deco)	4" (Semi-inside and Outside Mount)			1 pc	
	$\frac{1}{2}$ " x $2\frac{1}{2}$ " (Inside Mount)				
Top Fascia Return	4" (Semi-inside and Outside Mount)			2 pcs	
	N/A (Inside Mount)				

Note:

- When the header size is  $4\frac{1}{2}$ "\*,  $5\frac{1}{2}$ "\*,  $6\frac{1}{4}$ "\* or  $7\frac{13}{16}$ "\*, the L Shape header and the U Shape Side Frame will be sent integrally. That is:
  1. The header and the supporting strip will be sent integrally as L Shape Header;
  2. The side frame, supporting strip and the side fascia will be sent integrally as U Shape Side Frame.
- For any custom header sizes other than  $4\frac{1}{2}$ "\*,  $5\frac{1}{2}$ "\*,  $6\frac{1}{4}$ "\* or  $7\frac{13}{16}$ "\*, the L Shape Header and the U Shape Side Frame will be sent separately. That is:
  1. The header and the supporting strip will be sent separately for L Shape Header;
  2. The side frame, supporting strip and the side fascia will be sent separately for U Shape Side Frame.

# Track Shutters—Bypass



## Hardware Box

Hardware Box
<b>Part</b>
Wrench
Nylon Guide
¾ " screws for Nylon Guide
Support L Bracket (based on the length of header)
2 ½ " screws for support L bracket
¾ " screws for support L bracket

### Keystone for Fascia of the Track Shutter

When fascia length exceeds the limitation and needs to split, keystone design fascia will be supplied without surcharge for track shutters.

For fascia length within the split limitation, keystone can also be supplied as an option with surcharge.

For Deco Fascia:

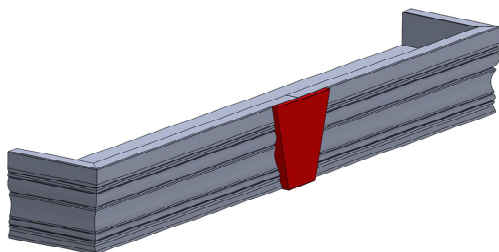

For Plain Fascia:

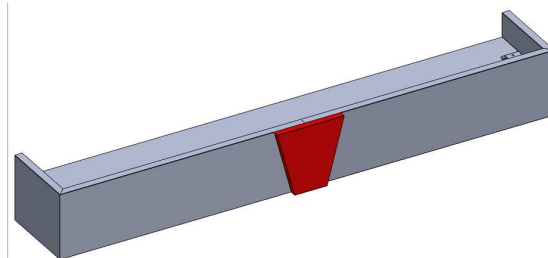

The keystone will be installed by screws. We will pre-drill the screw holes and the screws will be packed in hardware box.

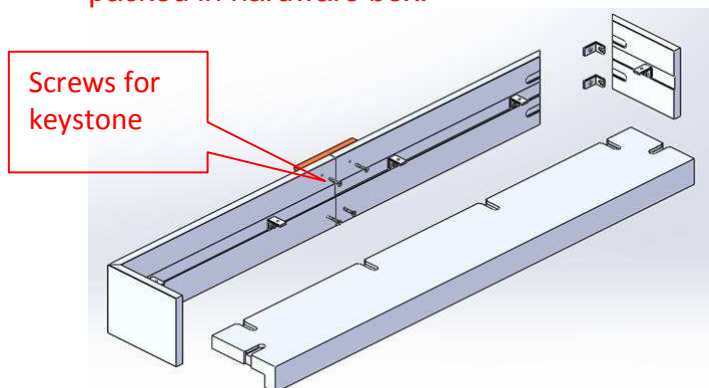

# Track Shutters—Bypass



## Plastic L Bracket to Connect the Header, Fascia & Fascia Returns



L Bracket will be used to connect the header, fascia and fascia returns for Bypass shutter. This applies for Inside Mount, Semi-Inside Mount & Outside Mount.

### OM & Semi-IM

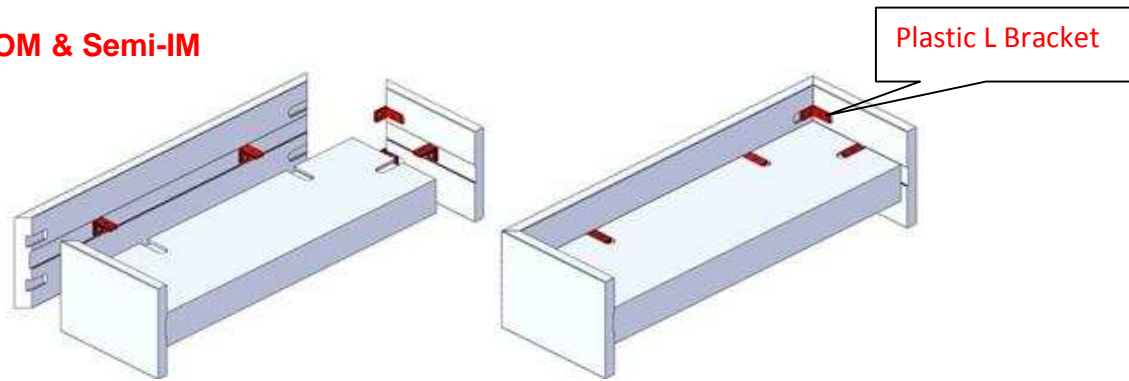

### IM

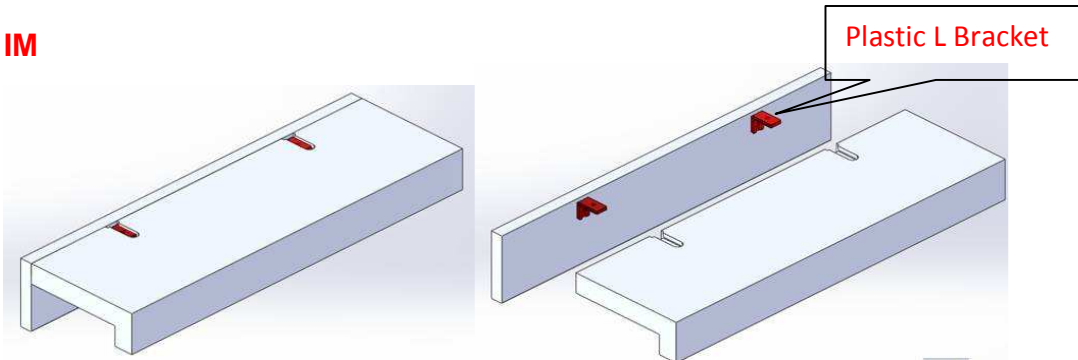

# Special Options

## Café\* Shutters

- The top of the panel requires a special finish. Please indicate “café shutter” when placing orders.
- The shutter does not come with recessed magnet on top.
- When the height of the framing material (including t-posts) exceeds the panel height, by more than 5", a surcharge will apply.

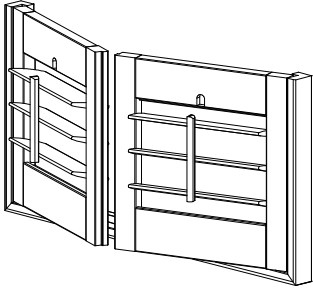

## Double-Hung\* Shutters

- For total number of panels, please include panels in both rows.
- The default location for the division point is the center unless specified otherwise.
- Horizontal T Post can be added for increased structural integrity.
- Warranty needs to be waived for the horizontal T post length exceeds 48”.

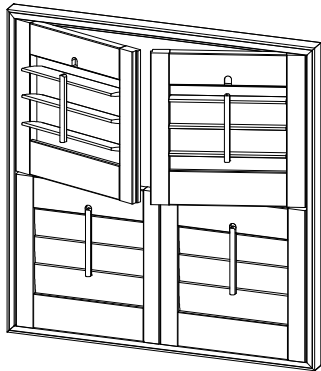

## Fixed Louvers

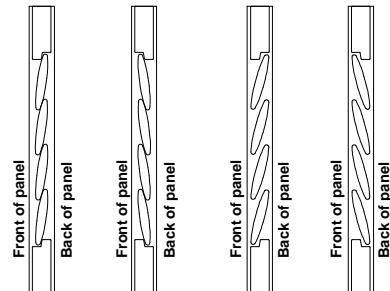
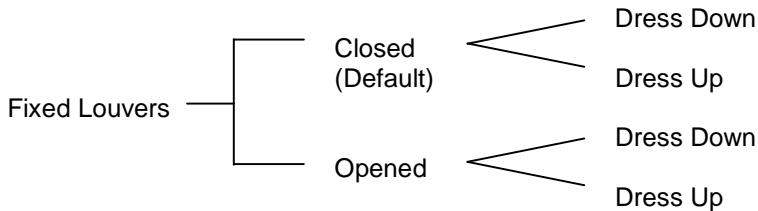

\*Some surcharges apply

BW k-1

## French Door Contour Collection\*

- Flush and offset cutout options are available in both curved and square French door cutout.
  - Offset cutout is a good option for French Door with molding around the glass.
- All French door cutouts are only available in L frame except Type E and F. The batten is placed behind the Type E/F panel to block light.

Louver size	Batten Width	Batten thickness
1 7/8" & 2 1/2"	3/4"	1"
3" & 3 1/2"	3/4"	1 3/8"
4 1/2"	3/4"	1 7/8"

- For measurement details please refer to forms section.
- French Door cutouts with Arch/Quarter Arch at the top are also available except Type E and F

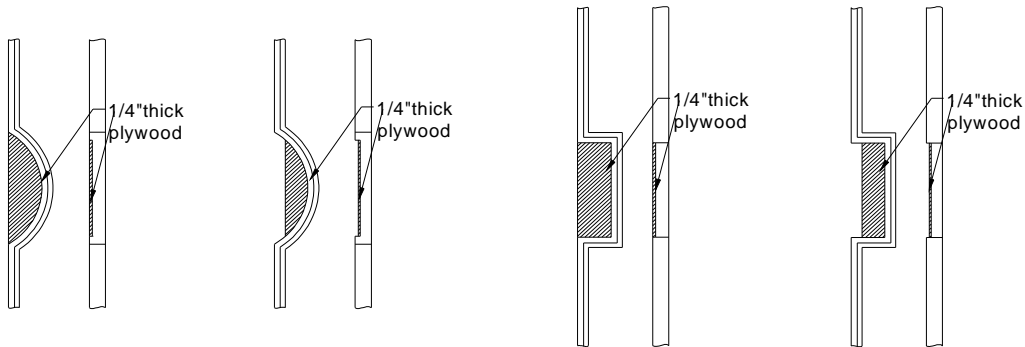

Type A

Type B

Type C

Type D

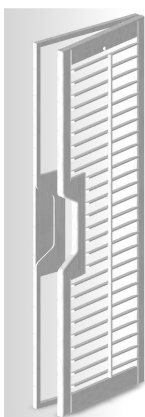

Type E

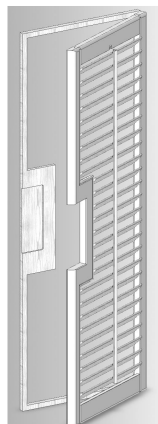

Type F

\*Some surcharges apply

**Auto Tilt<sup>™</sup> (Patented) \***

- Available in Bifold or Multi-fold panel configuration
- Available with Invisible Tilt Only
- Available in 2" Butt, Astragal and Rabbet Stile
- Minimum Louver Qty (Please see below for details)
- Ring pulls included. For ring pull location, please refer to the ring pull section.

When there is only one louver section (no divider rail/no split tilt)

Louver Size	Rail Size	Minimum Louver qty
2.5"	<4.25"	6
	>=4.25"	4
3"	<3.75"	5
	>=3.75"	4
3.5"	2.75"~6.5"	4
4.5"	2.75"~6.5"	3

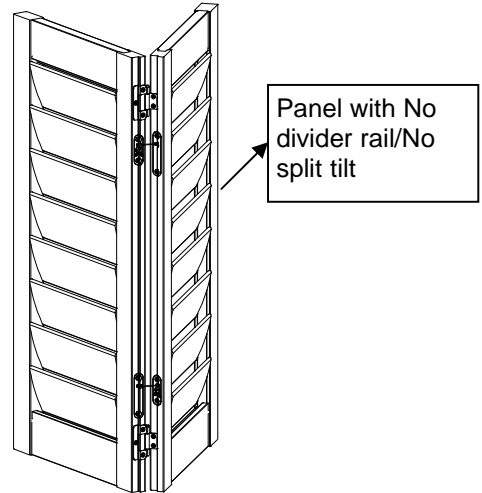

When there is more than one louver sections (with divider rail/ split tilt)

Louver Size	Rail Size	Minimum Louver qty
2.5"	<4.25"	5
	>=4.25"	4
3"	2.75"~6.5"	4
3.5"	2.75"~6.5"	3
4.5"	2.75"~6.5"	3

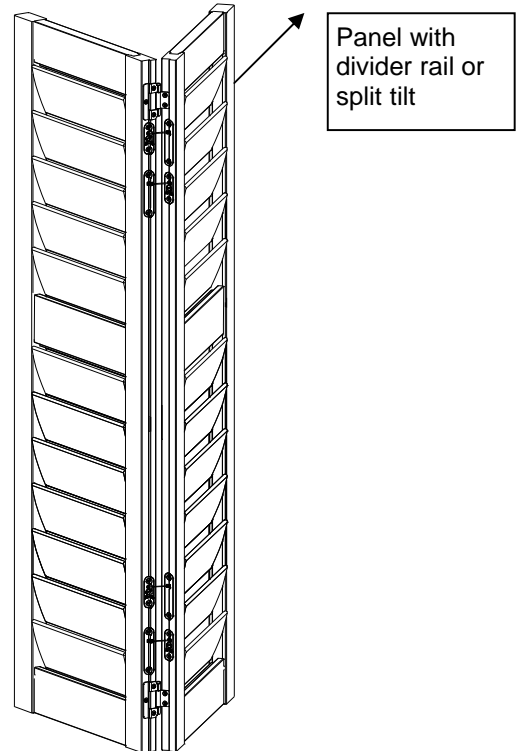

\*Some surcharges apply



## Special Options (continued)

### Custom Colors \*

Available in Brightwood shutters.

Option (Color Code)	Sample Size	<u>Confirmation Process</u>
<b>Custom Solid (C01)</b>	A least 4"x4" on a clean, flat surface, such as wood or cardboard (please do not send anything critical as the sample will not be returned)	All orders require customer's confirmation via <b>digital photo OR actual swatch</b> in the mail before production. An additional shipping and Custom handling fee applies.

Note:

- 1) All custom colors will be finished with the standard gloss used on all Norman products.
- 2) Please be aware that we will only be able to match the tone and not the texture or finish of the sample you submit.
- 3) Only one color revision will be allowed during the color confirmation process.
- 4) Customer may shorten the production lead-time by opting to waive the color confirmation process or by approving a digital photo. Norman will not be responsible for any color variation on waived confirmations or approved digital photos.

Disclaimer:

Sherwin Williams ColorSnap (MWCS),  
 Sherwin Williams Designer Expressions (MWDE),  
 Benjamin Moore Classic (MBMC) (M2460009TL) &  
 Benjamin Moore Preview (MBMP) (M2440564TL)

**Benjamin Moore, Off White Collection M2451888TL**

are registered trademarks or trademarks of their respective owners. All other trademarks mentioned herein are the property of Norman International, Inc. and/or its affiliates in the U.S. and certain other countries. Reference herein to the commercial products or service of others by trade name, trademark, manufacturer, or otherwise, does not necessarily constitute or imply its endorsement.

\*Some surcharges apply

BW k-4

# Specialties

## Specialty Shutters\*

Specialty shutters are made of premium solid wood, finished to match the beauty of all Norman shutters. Templates are required if it is an imperfect specialty. Delivery time is 8 weeks from the order confirmation date for all specialty shutters. Please refer to Specialties and Template Requirement sections for details.

### Regarding frame with an insert or solid frame issue:

#### 1). For Half Round Sunburst, Quarter Round Sunburst, Eyebrow Sunburst & Elongated Eyebrow Sunburst:

- All deco frames will be made as solid frames;
- All Vintage L frames & Vintage hang strip: all top frames (curve shape frame) will be made as a solid frame but the bottom & both sided frames (straight frames) will be made as regular frames with inserts

#### 2). For Triangle, Hexagon, Octagon, Peak & Angle top: all frames will be made as regular frames with inserts.

#### 3). For Circle, Oval: all frames will be made as solid frames (not with an insert).

#### 4). For Sunburst on top with Divider strip: the top frame (curve shape frame) will be made as a solid frame but the bottom & both side frames (straight frames) will be made as regular frames with inserts.

#### 5). For Louver Arch with Eyebrow curve shape:

- All deco frames excluding 2.5" Mission deco frame: all frames will be made as solid frames (not with an insert).
- All Vintage L frames & Vintage hang strip & 2.5" Mission deco frame: the top frame (curve shape frame) will be made as a solid frame but the bottom & both sided frames (straight frames) will be made as regular frames with inserts;

#### 6). For other Specialty Shutters when curve shape is similar as perfect arch (such as Louver Arch except Louver Arch with Eyebrow curve shape in point 5), Horizontal louvers center arch with quarter round side panels(-Standard louvered arch & Continuous arch), Sunburst louvers center arch with quarter round side panels, Arch Top Picture Window with horizontal louvers, Arch Top Picture Window with Sunburst, Standard unit with horizontal arch center etc.):

- All deco frames will be made as solid frames;
- All Vintage L frames & Vintage hang strip: all top frames (curve shape frame) will be made as a solid frame but the bottom & both sided frames (straight frames) will be made as regular frames with inserts.

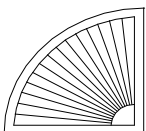

Quarter Round  
Sunburst

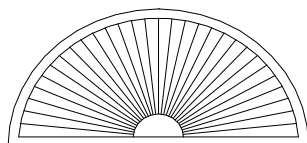

Half Round  
Sunburst

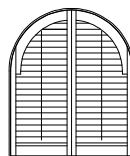

Louvered Arch  
w/ Center Tilt Rod

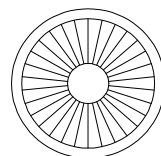

Circle Sunburst

\*Some surcharges apply

BWI-1

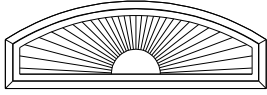

**Elongated Eyebrow Sunburst**

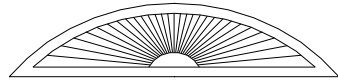

**Eyebrow Sunburst**

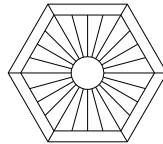

**Hexagon Sunburst**

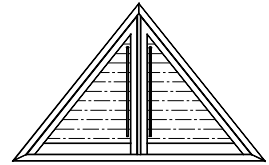

**Triangle**

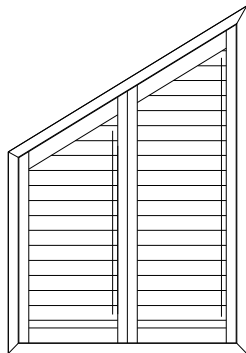

**Angle Top**

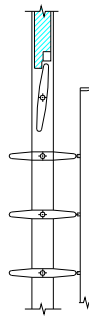

**\*Top louver of angle top might be fixed as shown**

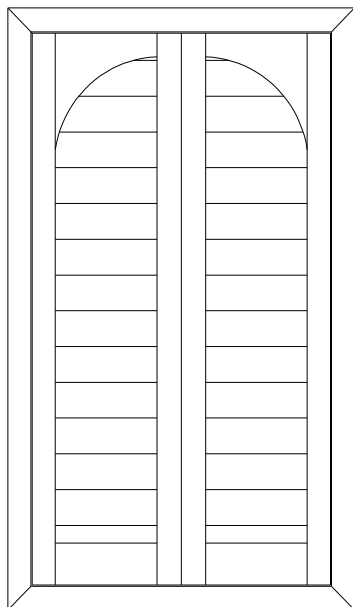

**Louver Arch in a Rectangle**

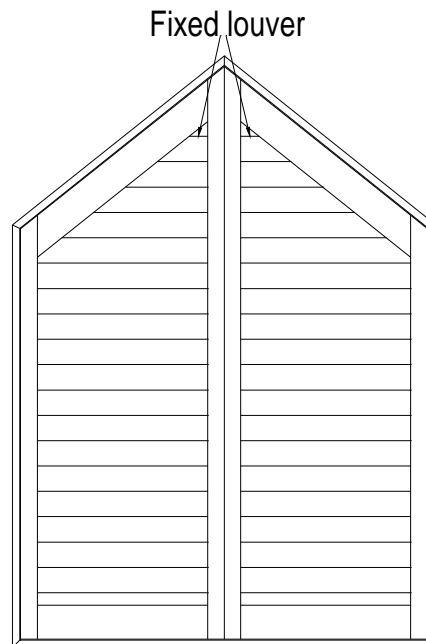

**Fixed louver**

**Peak**

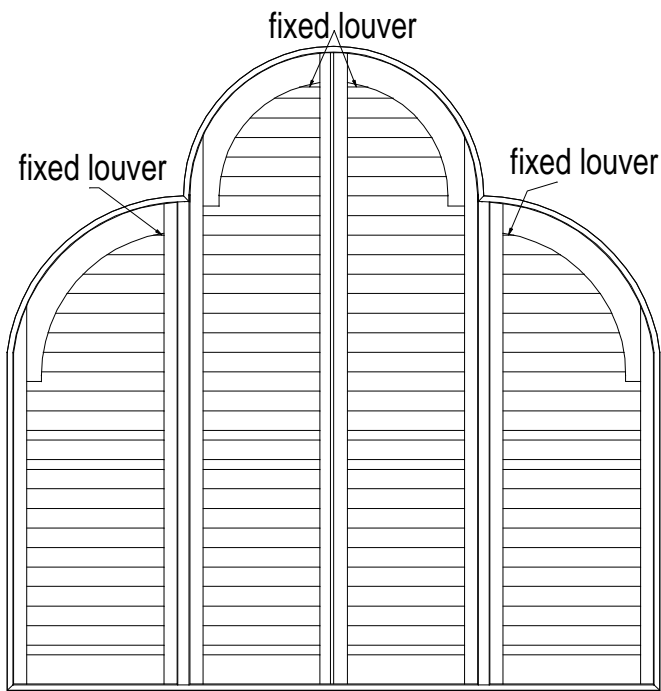

Horizontal louvers center arch  
with quarter round side panels  
-Standard louvered arch

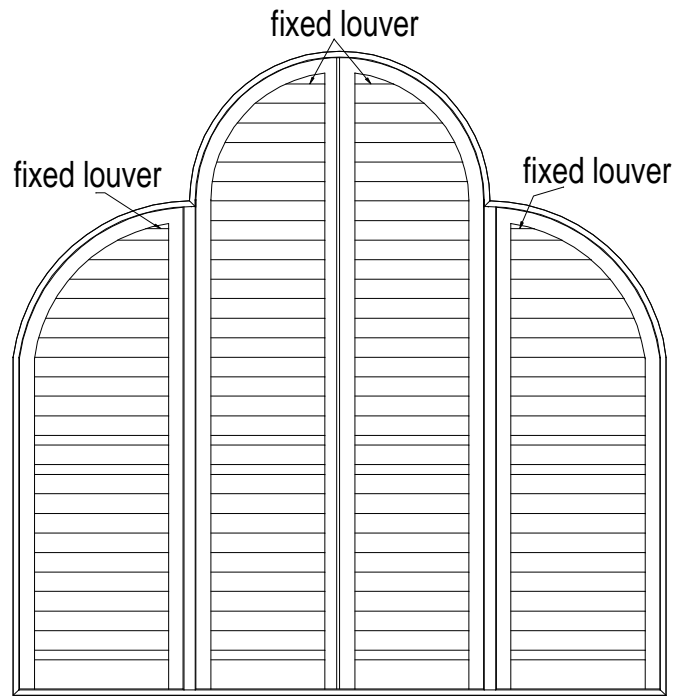

Horizontal louvers center arch  
with quarter round side panels  
-Continuous arch

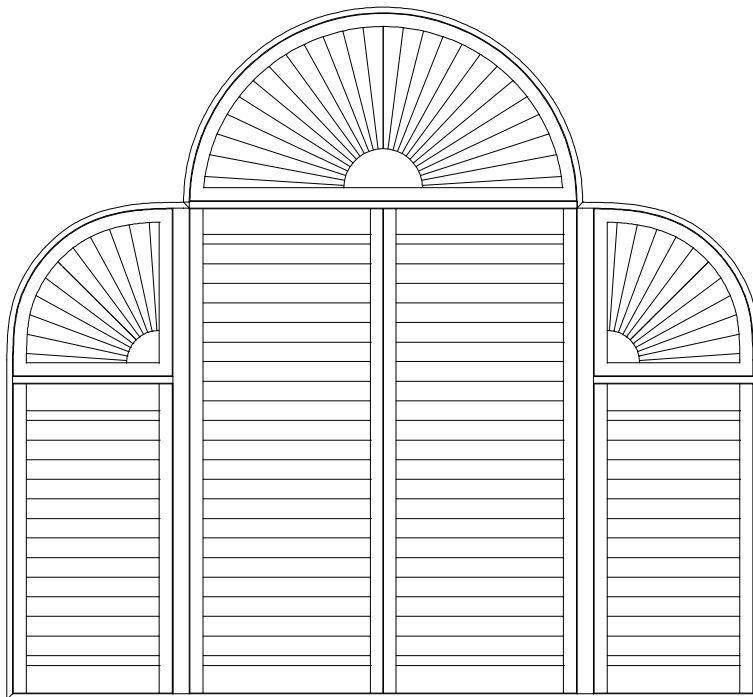

Sunburst louvers center arch with quarter round side panels

\*Some surcharges apply

Fixed louver

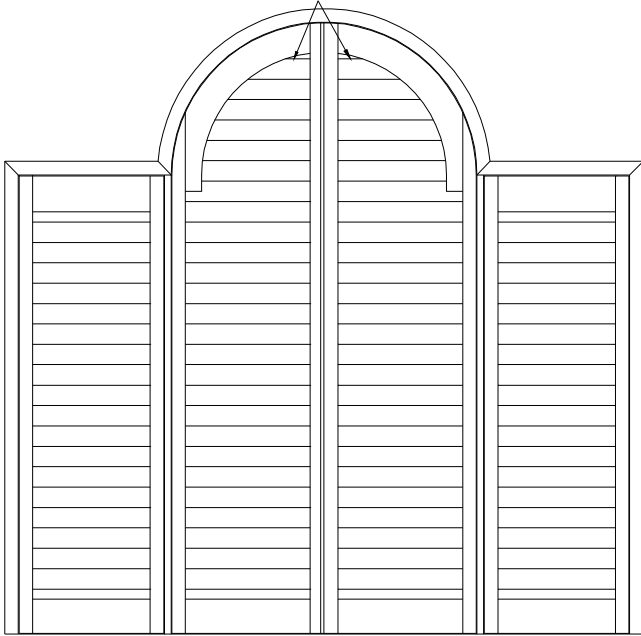

Arch Top Picture Window with horizontal louvers  
-Standard louvered arch

Fixed louver

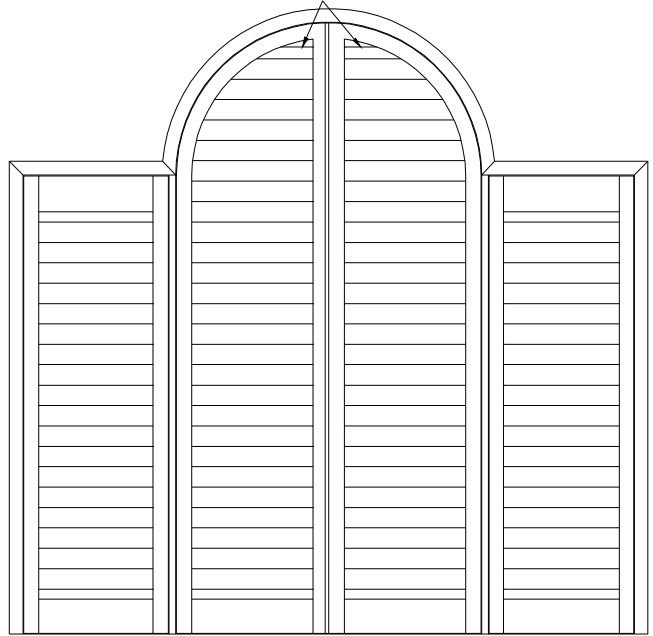

Arch Top Picture Window with horizontal louvers  
-Continuous arch

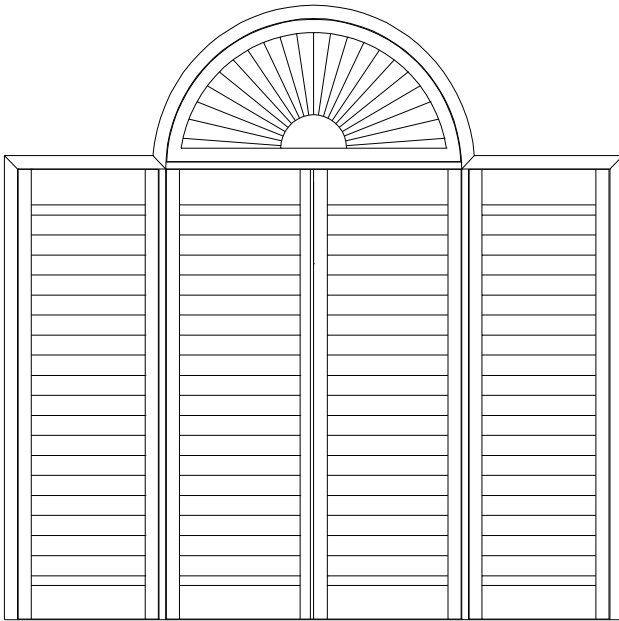

Arch Top Picture Window with Sunburst

fixed louver

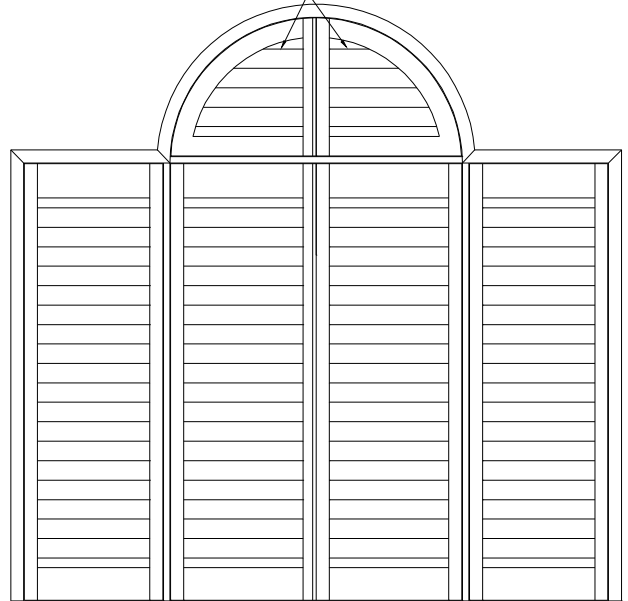

Standard unit with horizontal arch center

\*Some surcharges apply

BWI-4

# Pricing

<b>1) By Max Frame-to-Frame Measurement:</b>						
<b>Regular Shutter</b>						
Inside and Outside Mount	Width	x	Height	/ 144	x	\$/sq ft
<b>Track Shutter**</b>						
Inside	Width	x	Height	/ 144	x	\$/sq ft
Semi-Inside and Outside Mount	Width	x	(Height-1½")	/ 144	x	\$/sq ft
<b>2) By Net Panel Measurement:</b>						
	Width	x	Height	/ 144	x	\$/sq ft
<b>3) By Window Size:</b>						
<b>2" Camber Deco Frame 2" Classic Deco Frame</b>	4-sided	(Width+4")	x	(Height+4")	/ 144	x \$/sq ft
	3-sided with Sill Plate	(Width+4")	x	(Height+4")	/ 144	x \$/sq ft
	3-sided	(Width+4")	x	(Height+2")	/ 144	x \$/sq ft
	2 sided with Sill Plate	(Width+4")	x	(Height+2")	/ 144	x \$/sq ft
	2-sided	(Width+4")	x	(Height)	/ 144	x \$/sq ft
<b>3" Ridge Deco Frame</b>	4-sided	(Width+6")	x	(Height+6")	/ 144	x \$/sq ft
	3-sided with Sill Plate	(Width+6")	x	(Height+6")	/ 144	x \$/sq ft
	3-sided	(Width+6")	x	(Height+3")	/ 144	x \$/sq ft
	2-sided with Sill Plate	(Width+6")	x	(Height+3")	/ 144	x \$/sq ft
	2-sided	(Width+6")	x	(Height)	/ 144	x \$/sq ft
<b>2.5" Mission deco frame</b>	4-sided	(Width+5")	x	(Height+5")	/ 144	x \$/sq ft
	3-sided	(Width+5")	x	(Height+2.5")	/ 144	x \$/sq ft
	2-sided	(Width+5")	x	(Height)	/ 144	x \$/sq ft
<b>3" Crown Z Frame</b>	4-sided	(Width+4 ½")	x	(Height+4½")	/ 144	x \$/sq ft
	3-sided with Sill Plate	(Width+4 ½")	x	(Height+4½")	/ 144	x \$/sq ft
	3-sided	(Width+4 ½")	x	(Height+2¼")	/ 144	x \$/sq ft
	2-sided with Sill Plate	(Width+4 ½")	x	(Height+2¼")	/ 144	x \$/sq ft
	2-sided	(Width+4 ½")	x	(Height)	/ 144	x \$/sq ft

# Pricing

<b>2" Bel Air Z Frame</b> <b>2" Bullnose Z Frame</b>	4-sided	(Width+2 ½")	x	(Height+2½")	/ 144	x	\$/sq ft
	3-sided with Sill Plate	(Width+2 ½")	x	(Height+2½")	/ 144	x	\$/sq ft
	3-sided	(Width+2 ½")	x	(Height+1¼")	/ 144	x	\$/sq ft
	2-sided with Sill Plate	(Width+2 ½")	x	(Height+1¼")	/ 144	x	\$/sq ft
	2-sided	(Width+2 ½")	x	(Height)	/ 144	x	\$/sq ft
<b>1 1/2" Bullnose Z Frame</b> <b>1 ¼ " Beaded Z Frame/ Bullnose Tilt Out Z Frame</b>	4-sided	(Width+2")	x	(Height+2")	/ 144	x	\$/sq ft
	3-sided with Sill Plate (N/A w/ Tilt out Z)	(Width+2")	x	(Height+2")	/ 144	x	\$/sq ft
	3-sided	(Width+2")	x	(Height+1")	/ 144	x	\$/sq ft
	2-sided with Sill Plate (N/A w/ Tilt out Z)	(Width+2")	x	(Height+1")	/ 144	x	\$/sq ft
	2-sided	(Width+2")	x	(Height)	/ 144	x	\$/sq ft
<b>Vintage Hang Strip</b>	Inside	Width	x	Height	/ 144	x	\$/sq ft
	Outside 4-sided	(Width+3")	x	(Height+3")	/ 144	x	\$/sq ft
	Outside 3-sided	(Width+3")	x	(Height+1½")	/ 144	x	\$/sq ft
	Outside 2-sided	(Width+3")	x	(Height)	/ 144	x	\$/sq ft
<b>Vintage L Frame/ Beaded L Frame</b>	Outside 4-sided	(Width+3")	x	(Height+3")	/ 144	x	\$/sq ft
	Outside 3-sided	(Width+3")	x	(Height+1½")	/ 144	x	\$/sq ft
	Outside 2-sided	(Width+3")	x	(Height)	/ 144	x	\$/sq ft
<b>Track Shutter**</b>							
Inside and Semi-Inside Mount		Width	x	Height	/144	x	\$/sq ft
Outside Mount		(Width+3")	x	(Height+3")	/144	x	\$/sq ft