

Left Side Open Configuration

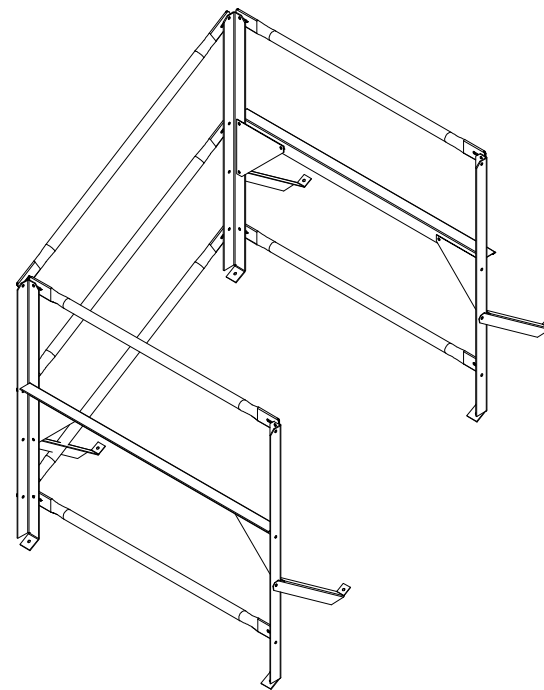

Right Side Open Configuration

PARTS LIST - 51450

| ITEM | QTY | PART NUMBER | DESCRIPTION |
|------|-----|-------------|-----------------------------------|
| 1 | 7 | HR15048 | 48" 1.5" O.D. Slotted End Railing |
| 2 | 2 | MG-0001 | Left Post |
| 3 | 2 | MG-0002 | Right Post |
| 4 | 4 | MG-0003 | Diagonal Brace |
| 5 | 2 | MG-0004 | Handrail |
| 6 | 2 | MG-0005 | Left Knee Brace |
| 7 | 2 | MG-0006 | Right Knee Brace |



| | | | |
|--------------------|-----------|-------------------------------------|--------------------|
| DRAWN Bill Huff | 1/31/2017 | Greene Galvanized Stairs | |
| CHECKED | | TITLE | |
| QA | | 51450 Manhole Guardrail Instruction | |
| MFG | | SIZE A | DWG NO IN-50009 |
| APPROVED | | SCALE | REV 1 |
| | | SHEET 1 OF 4 | |

**51450 Manhole Guardrail,
with Easy Step Roof Ladder Handrail
and Peak Handrail**

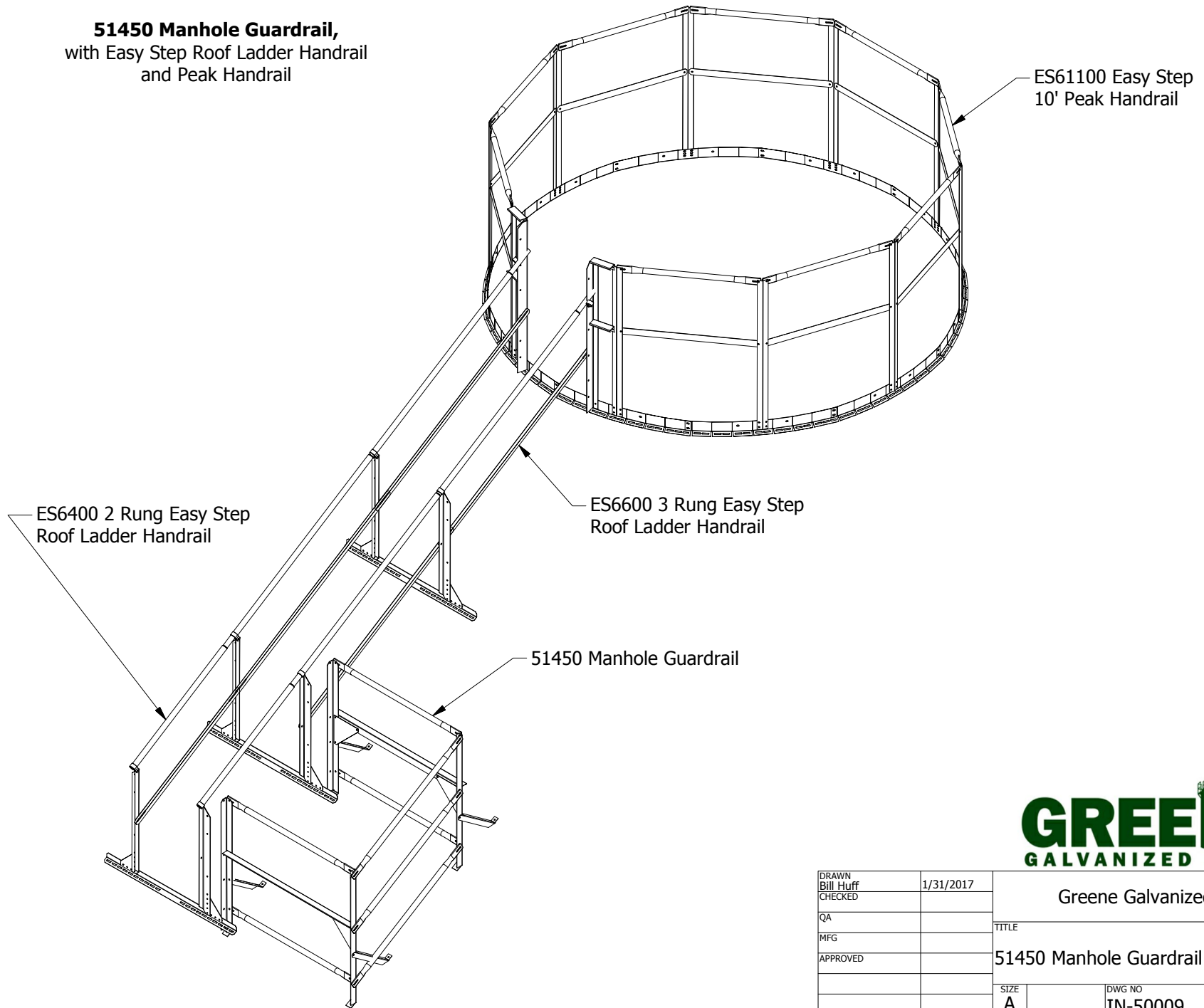

| | | | | |
|--------------------|-----------|-------------------------------------|--------------|-----|
| DRAWN Bill Huff | 1/31/2017 | Greene Galvanized Stairs | | |
| CHECKED | | TITLE | | |
| QA | | 51450 Manhole Guardrail Instruction | | |
| MFG | | SIZE | DWG NO | REV |
| APPROVED | | A | IN-50009 | 1 |
| | | SCALE | SHEET 2 OF 4 | |

**51450 Manhole Guardrail,
with Easy Step Roof Stairs
and Peak Walkaround**

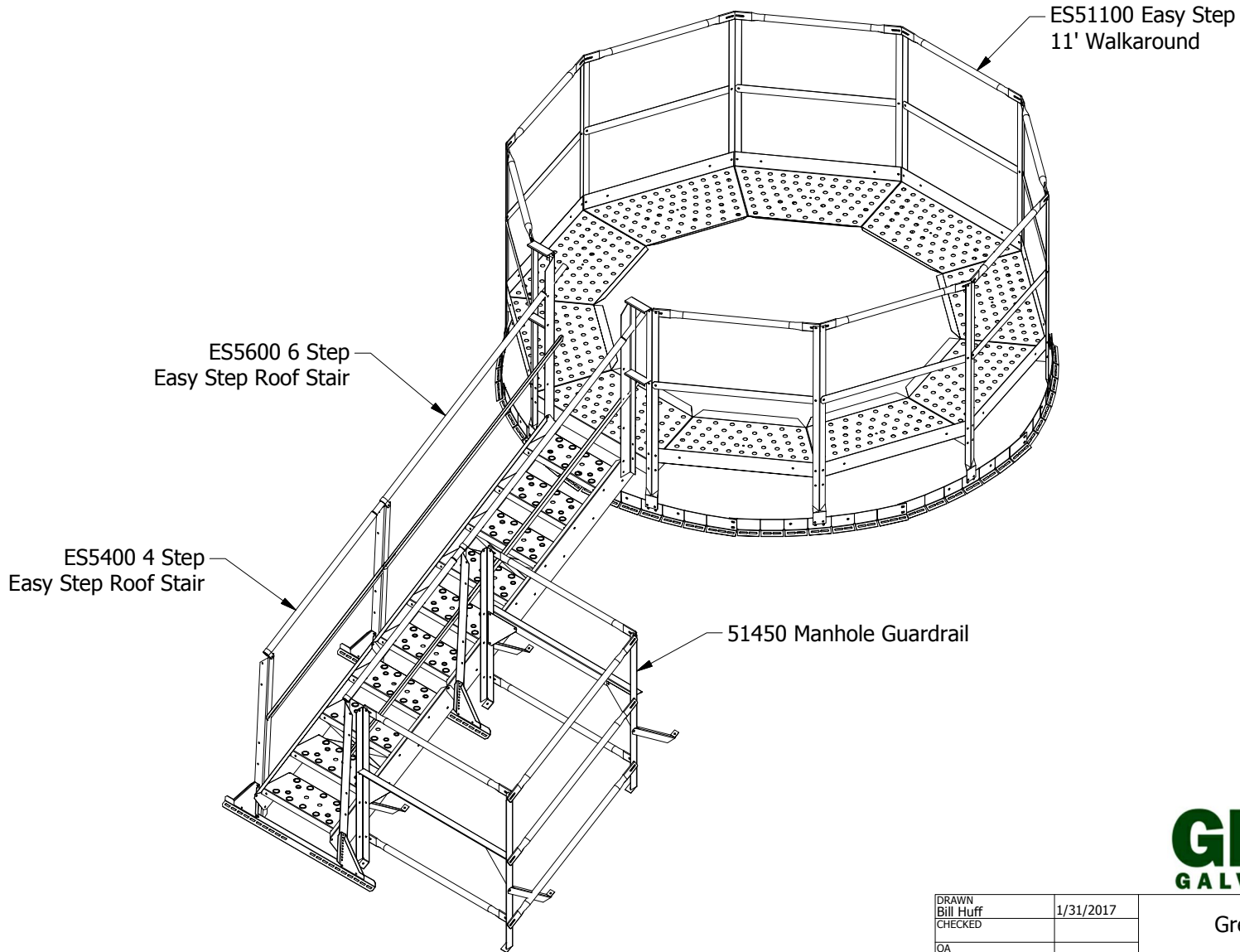

| | | | | |
|--------------------|-----------|-------------------------------------|----------|--------------|
| DRAWN Bill Huff | 1/31/2017 | Greene Galvanized Stairs | | |
| CHECKED | | TITLE | | |
| QA | | 51450 Manhole Guardrail Instruction | | |
| MFG | | SIZE | DWG NO | REV |
| APPROVED | | A | IN-50009 | 1 |
| | | SCALE | | SHEET 3 OF 4 |

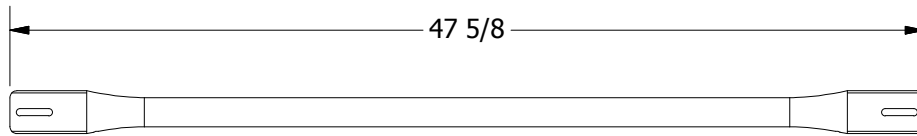

HR15048

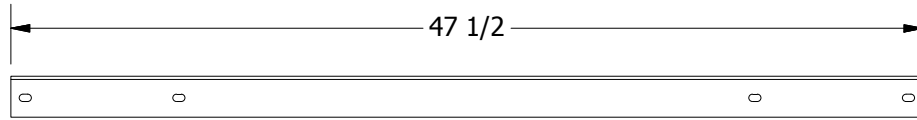

MG-0004

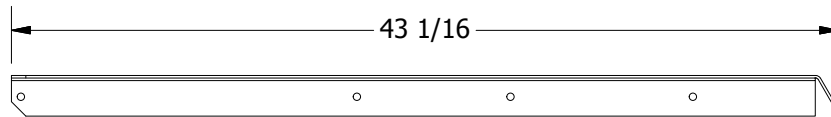

MG-0001

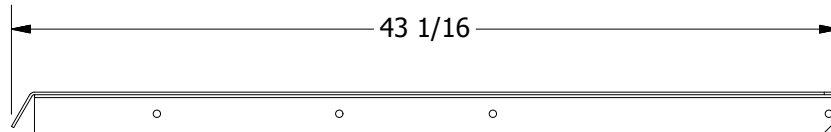

MG-0002

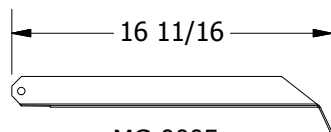

MG-0005

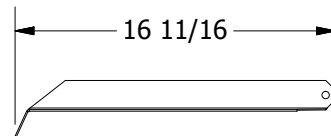

MG-0006

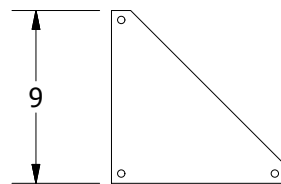

MG-0003



5/16-18 x 1-1/2
Carriage Bolt

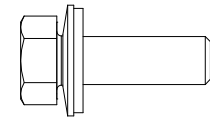

5/16-18 x 1
Bin Bolt

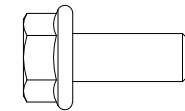

5/16-18 x 3/4
Flange Bolt

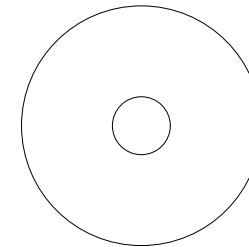

5/16 Backing Washer

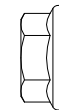

5/16-18 Whiz
Lock Nut



| | | | |
|--------------------|-----------|-------------------------------------|--------------------|
| DRAWN Bill Huff | 1/31/2017 | Greene Galvanized Stairs | |
| CHECKED | | TITLE | |
| QA | | 51450 Manhole Guardrail Instruction | |
| MFG | | SIZE A | DWG NO IN-50009 |
| APPROVED | | SCALE | REV 1 |
| | | SHEET 4 OF 4 | |