



Unified Computing Platform & Wireless Routers

Product Selection Guide

SDK
Serial Device Servers
Modbus Gateways
Protocol Gateways

2021/2022

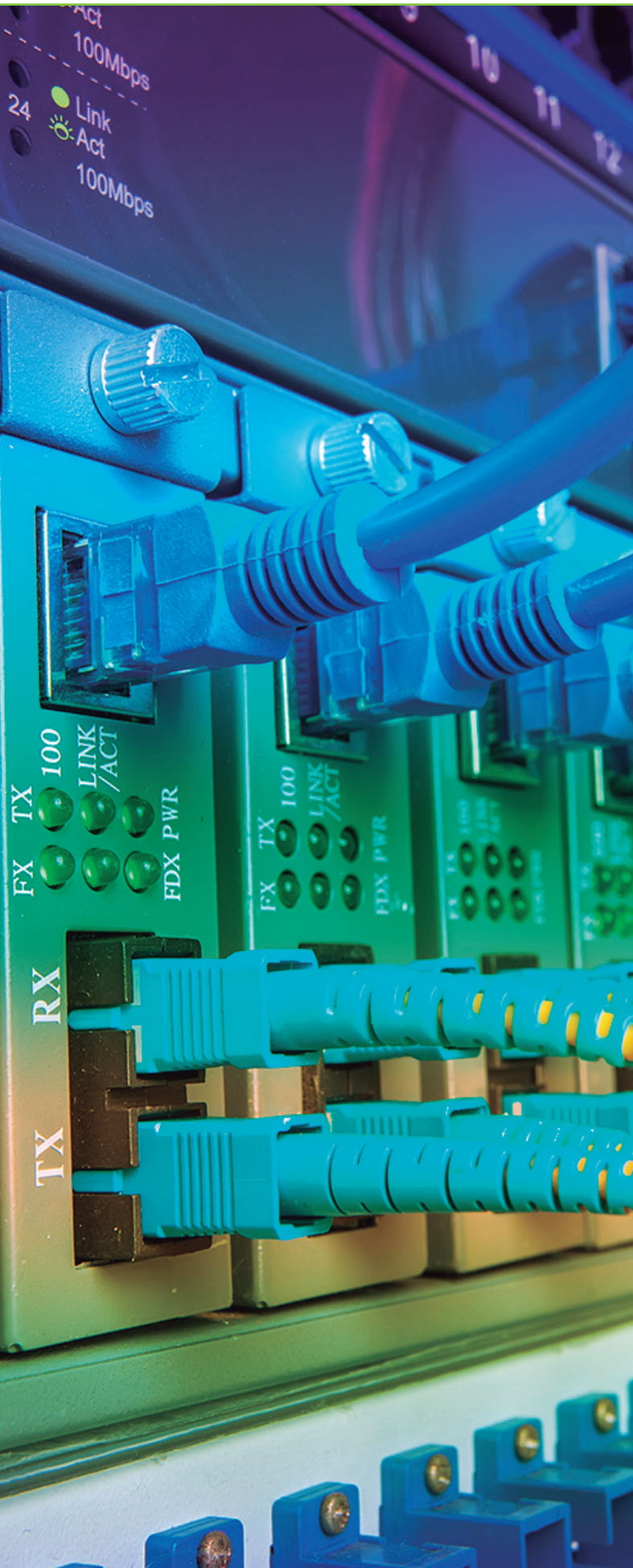

SDK (Embedded Computers)

Leverage ATOP's rugged industrial hardware to run your applications

————— *page 4*

SDK version comes with an easily programmable embedded edge computer with cloud connectivity. A few highlights are:

- ATOP's customized **Linux OS**
- ATOP's **custom APIs and utilities** to control hardware with a wide variety of programming solutions
- An integrated **Building Block programming environment**, in addition to C programming. The environment includes a wide range of customized APIs, allowing you to access hardware through a visual programming environment.

To learn more about our edge computing, check out our Embedded Computing Brochure.

Serial Device Servers

Communicate with legacy devices leveraging your Ethernet-based network

————— *page 6*

Serial Server Application: For transparent conversion between Serial and Ethernet.

Modbus Gateways

Seamlessly convert or concentrate Modbus RTU/ASCII data to Modbus TCP and greatly increase your application performance

————— *page 9*

Modbus Gateway Application: To convert from Modbus TCP to RTU/ASCII, and vice-versa.

Modbus Concentrator: For faster Modbus polling responsiveness, redundancy, and register remapping.



Protocol Gateways for Smart Grid and Substations

Use ATOP to integrate legacy substation devices into newer networks, or vice-versa

_____ page 12

Protocol Gateway: For advanced protocol conversion applications, such as Substation and Industrial scenarios.



Wireless Routers





Connectivity for seamless Wi-Fi mesh communication and mobile 4G/5G high-performance throughput

_____ page 17

Application: Secure your own internal link and provide cloud service through mobile 4G/5G connectivity.

SDK (Embedded Computers)

SDK: Software development kit of ATOP platforms. A Linux based environment allowed to develop proprietary applications on ATOP SW architecture.

SE59XX series		
 SE5901	 SE5901B platform (with 4G/LTE Cellular)	 SE5904D
 SE5908/SE5916	 SE5908A/SE5916A (IEC61850-3 certified)	

Features:

- FW redundancy mechanism during FW upgrade/downgrade process
- Rich example codes of C and WEB for easy development of proprietary WEB style and applications
- Flexible architecture allows you to easily add 3rd party source, applications, scripts in the SDK

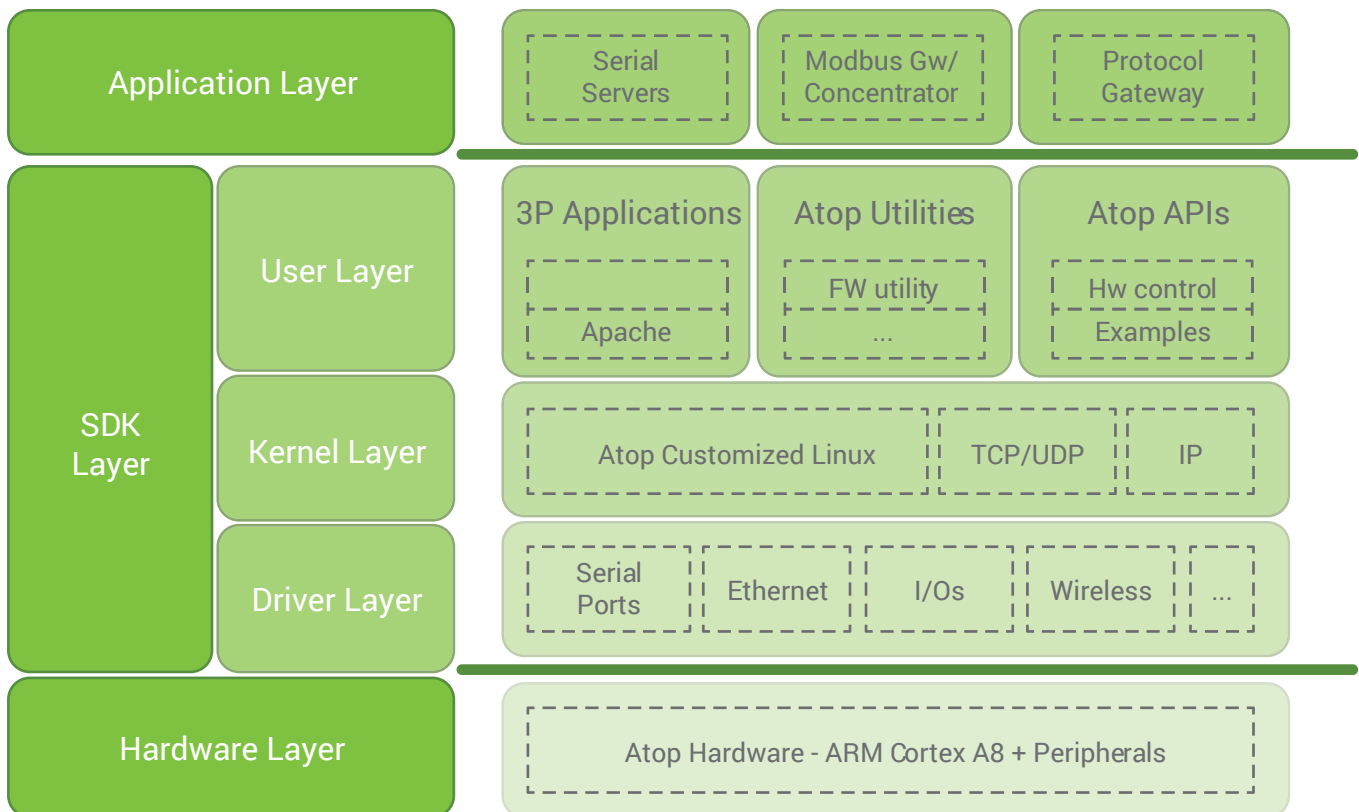

SDK (Embedded Computers)

Advanced



General Information

Model Number	SE5901	SE5901B	SE5904D	SE5908/16	SE5900A	SE5908A/16A
--------------	--------	---------	---------	-----------	---------	-------------

Network Interfaces

Total number of ports	2	1	2	2	6	6
Total Fast Ethernet	2	-	(2)	2	6	6
10/100 BaseT(X)	2	-	(2)	2	(6)	(6)
100 Base-X (SFP)	-	-	-	-	(6)	(6)
Total Gigabit	-	1	(2)	-	-	-
10/100/1000 BaseT(X)	-	1	-	-	-	-
100/1000 Base-X SFP	-	-	(2)	-	-	-
3G/4G interfaces	-	•	-	-	-	-

Serial Ports

Number of ports	1	(1)/(2)	4	8/16	-	8/16
RS-232 RS-422 RS-485 full func.	1	1 (RS-232/485)	4	8/16	-	8/16
RS-232 only	-	1 (only IO vers.)	-	-	-	-
Serial port Isolation	-	-	3kV (Optional)	2.5kV (Optional)	-	3kV (Optional)
Terminal Block (TB) ports	(1)	(2)	(4)	-	-	(8)/(16)
D-Sub 9 (DB9) ports	(1)	(1)	(4)	-	-	(8)/(16)
RJ45 Serial ports	-	-	-	(8)/(16)	-	-

Hardware Specifications

CPU Architecture	ARM	ARM	ARM	ARM	ARM	ARM
CPU Speed	800MHz	800MHz	800MHz	800MHz	1000MHz	1000MHz
RAM	256MB (Max)	256MB (Max)	512MB (Max)	512MB (Max)	512MB (Max)	512MB (Max)
Flash	128MB (Max)	128MB (Max)	128MB (Max)	128MB (Max)	128MB (Max)	128MB (Max)
Hardware Watchdog	•	•	•	•	•	•
Buzzer	•	•	•	•	•	•
Digital Inputs	-	2 (Optional)	-	-	-	-
Digital Outputs	-	2 (Optional)	-	-	-	-
Relay Output	-	-	1	-	2	2
USB	2	2	1	-	-	-
SD or MicroSD cards slot	-	•	•	•	•	•

Power Supply input

Power Input	9~48 VDC	9~48 VDC	12~48 VDC	24~48 VDC	24~48 VDC	24~48 VDC
Power PoE 802.3af (PD)	Optional	-	Optional	-	-	-
AC power input	-	-	-	100~240VAC	100~240VAC	100~240VAC
High Voltage DC power input	-	-	-	-	100~370VDC	100~370VDC
Power Redundancy	-	-	•	-	•	•

Mechanical

Installation	DIN-Rail	DIN-Rail	DIN-Rail	Rack-mount	Rack-mount	Rack-mount
Ingress Protection	IP30	IP30	IP30	IP30	IP30	IP30
Dimensions (L x H x D) in mm	TBD	TBD	TBD	440 x 44 x 200	440 x 44 x 309	440 x 44 x 309

Supported Temperatures

Operations Temperature	-40~85° C	-40~70° C	-40~85° C	-20/70° C	-40/85° C	-40/85° C
Storage Temperature	-40~85° C	-40~85° C	-40~85° C	-40~85° C	-40~85° C	-40~85° C

Compliance

Industrial EMC Protection	•	•	•	•	•	•
CE/FCC	•	•	•	•	•	•
UL/EN/IEC(CB)60950-1 and/or 62368-1	-	•	-	-	-	-
EN60950-1 and/or EN62368	•	•	•	•	•	•
UL61010-2-201	-	-	•	-	-	-
EN50155 / EN50121-4	-	-	-	-	-	-
IEC61850-3 / IEEE1613	-	-	-	-	•	•

Serial Device Servers

At ATOP we understand that it can be difficult to integrate various application needs. So, we develop solutions that bring interoperability between various hardware and software platforms. In addition, we develop with a product strategy in mind, so that flexibility and network scalability are factored in to provide solutions that are fit for the future.

Families



Entry Level

A low-cost, hardened hardware device for serial server applications in standard operating environments in normal temperature ranges, with basic functionalities and semi-industrial EMC protection.



Wireless

Designed to equip serial server functionality with wireless connectivity, our wireless devices support 3G and 4G or IEEE 802.11abgn and IEEE 802.11bgn.



Advanced

By featuring a high-powered industrial CPU and high EMC protection at Levels 3 to 5 or IEC61850-3, these advanced serial servers provide performance and scalability for Modbus Gateways, Modbus Concentrators, Protocol Gateways, and programmable environment support (SDK), in which you can write your own software in C or build your own IIoT application with a visual building-block tool.

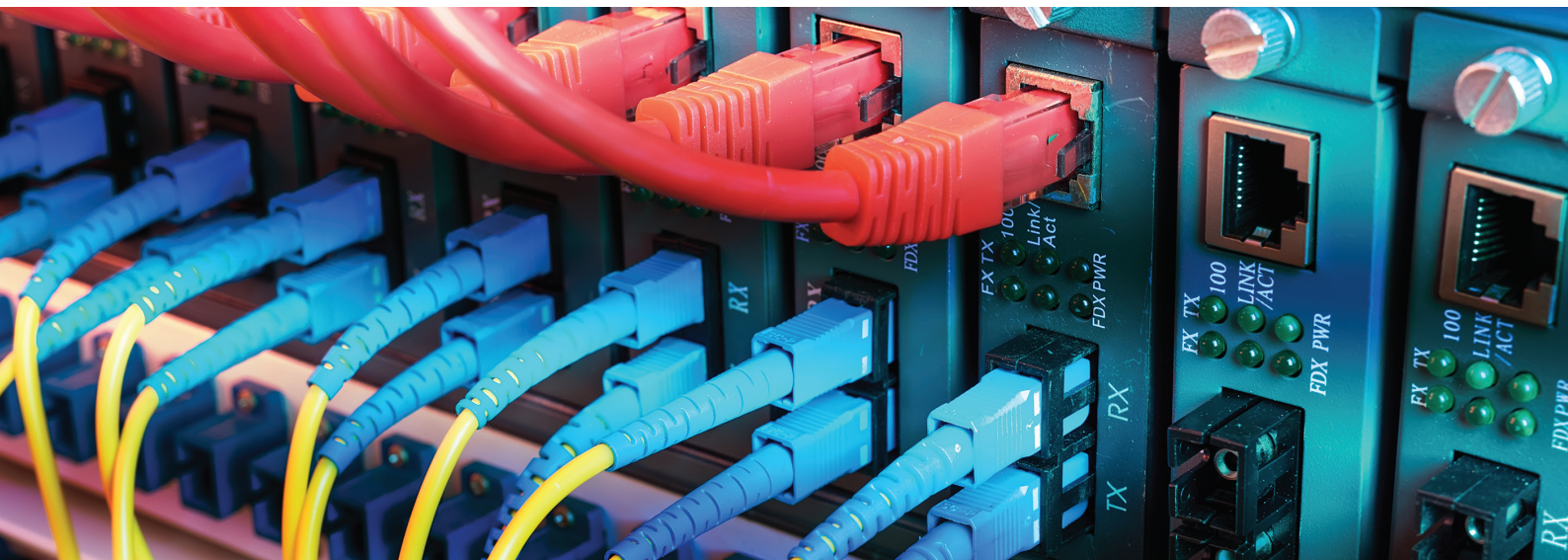

Serial Device Servers

	Entry-level			Wi-Fi		4G	Advanced	
								
General Information								
Model Number	SE5201C	SE5201	SE5202	SW5501/2	SW5501/2C	SE5901B	SE5901	SE5904D
Network Interfaces								
Total number of ports	1	1	1	1	1	1	2	2
Total Fast Ethernet	1	1	1	-	1	-	2	(2)
10/100 BaseT(X)	1	1	1	-	1	-	2	(2)
100 Base-X (SFP)	-	-	-	-	-	-	-	-
Total Gigabit	-	-	-	1	-	1	-	(2)
10/100/1000 BaseT(X)	-	-	-	1	-	1	-	-
100/1000 Base-X SFP	-	-	-	-	-	-	-	(2)
Wi-Fi interface	-	-	-	2.4/5GHz	2.4GHz	-	-	-
3G/4G interfaces	-	-	-	•	•	•	-	-
Network Redundancy								
RSTP redundant ports	-	-	-	-	-	-	2	2
Serial Ports								
Number of ports	1	1	2	1/2	1/2	(1)/(2)	1	4
RS-232 RS-422 RS-485 full func.	1	1	2	1/2	1/2	1 (RS-232/485)	1	4
RS-232 only	-	-	-	-	-	1 (only IO vers.)	-	-
Serial port Isolation	-	-	3kV (Optional)	3kV (Optional)	-	-	-	3kV (Optional)
Serial port connector	DSub9/TB	DSub9/TB	DSub9/TB	DSub9/TB	DSub9/TB	DSub9/TB	DSub9/TB	DSub9/TB
Other interfaces								
Digital Inputs						2 (Optional)		
Digital Outputs						2 (Optional)		
Relay Output								1
Power Supply input								
Power Input	5 VDC	5 & 9~30 VDC	5 & 9~30 VDC	9~48 VDC	9~48 VDC	9~48 VDC	9~48 VDC	12~48 VDC
Power PoE 802.3af (PD)							Optional	Optional
AC power input								
High Voltage DC power input								
Power Redundancy		•	•					•
Mechanical								
Installation	Field-Mount	Field-Mount	Field-Mount	DIN-Rail	DIN-Rail	DIN-Rail	DIN-Rail	DIN-Rail
Ingress Protection	IP30	IP30	IP30	IP30	IP30	IP30	IP30	IP30
Dimensions (L x H x D) in mm	65 x 78 x 27	65 x 78 x 27	75 x 85 x 28	7 x 110 x 90	7 x 110 x 90	32 x 110 x 90	32 x 122 x 92	55 x 145 x 113
Supported Temperatures								
Operations Temperature	-40~70° C	-40~70° C	-40~70° C	-10~60° C	-10~60° C	-40~70° C	-40~85° C	-40~85° C
Storage Temperature	-40~85° C	-40~85° C	-40~85° C	-40~85° C	-40~85° C	-40~85° C	-40~85° C	-40~85° C
Serial Server								
TCP Client (max connections)	1/VCOM	1/VCOM	1/VCOM	2/VCOM	2/VCOM	2/VCOM	2/VCOM	2/VCOM
TCP Server (max connections)	1/VCOM	1/VCOM	1/VCOM	4/VCOM	4/VCOM	4/VCOM	4/VCOM	4/VCOM
UDP (ranges)	4	4	4	4	4	4	4	4
VirtualCOM	•	•	•	•	•	•	•	•
Reverse Telnet	•	•	•	•	•	•	•	•
VPN				•	•	•	•	•
Compliance								
Industrial EMC Protection		•	•	•	•	•	•	•
CE/FCC	•	•	•	•	•	•	•	•
UL/EN/IEC(CB)60950-1 and/or 62368-1				•	•	•		
EN60950-1 and/or EN62368	•	•	•	•	•	•	•	•
UL61010-2-201								•
EN50155 / EN50121-4								
IEC61850-3 / IEEE1613								

Serial Device Servers

	Advanced				IP68
					
General Information					
Model Number	SE5908	SE5916	SE5908A	SE5916A	SE8502
Network Interfaces					
Total number of ports	2	2	6	6	1
Total Fast Ethernet	2	2	6	6	1
10/100 BaseT(X)	2	2	(6)	(6)	1 (M12)
100 Base-X (SFP)	-	-	(6)	(6)	-
Total Gigabit	-	-	-	-	-
10/100/1000 BaseT(X)	-	-	-	-	-
100/1000 Base-X SFP	-	-	-	-	-
Wi-Fi interface	-	-	-	-	-
3G/4G interfaces	-	-	-	-	-
Network Redundancy					
RSTP redundant ports	2	2	2	2	-
Serial Ports					
Number of ports	8	16	8	16	2 (M12)
RS-232 RS-422 RS-485 full func.	8	16	8	16	2 (M12)
RS-232 only	-	-	-	-	-
Serial port Isolation	2.5kV (Optional)	2.5kV (Optional)	3kV (Optional)	3kV (Optional)	-
Serial port connector	RJ45	RJ45	DSub9/TB	DSub9/TB	M12
Other interfaces					
Digital Inputs					2 (Optional)
Digital Outputs					2 (Optional)
Relay Output			2	2	
Power Supply input					
Power Input	24~48 VDC	24~48 VDC	24~48 VDC	24~48 VDC	9~48 VDC
Power PoE 802.3af (PD)					
AC power input	100~240VAC	100~240VAC	100~240VAC	100~240VAC	
High Voltage DC power input			100~370VDC	100~370VDC	
Power Redundancy			•	•	
Mechanical					
Installation	Rack-mount	Rack-mount	Rack-mount	Rack-mount	Field-Mount
Ingress Protection	IP30	IP30	IP30	IP30	IP68
Dimensions (L x H x D) in mm	440 x 44 x 200	440 x 44 x 200	440 x 44 x 309	440 x 44 x 309	80 x 145 x 24
Supported Temperatures					
Operations Temperature	-20/70° C	-20/70° C	-40/85° C	-40/85° C	-40~75° C
Storage Temperature	-40~85° C	-40~85° C	-40~85° C	-40~85° C	-40~85° C
Serial Server					
TCP Client (max connections)	2/VCOM	2/VCOM	2/VCOM	2/VCOM	2/VCOM
TCP Server (max connections)	4/VCOM	4/VCOM	4/VCOM	4/VCOM	4/VCOM
UDP (ranges)	4	4	4	4	8
VirtualCOM	•	•	•	•	•
Reverse Telnet	•	•	•	•	•
VPN	•	•	•	•	•
Compliance					
Industrial EMC Protection	•	•	•	•	•
CE/FCC	•	•	•	•	•
UL/EN/IEC(CB)60950-1 and/or 62368-1					
EN60950-1 and/or EN62368	•	•	•	•	•
UL61010-2-201					
EN50155 / EN50121-4					•
IEC61850-3 / IEEE1613			•	•	

Modbus Gateways

Why Modbus?

Modbus is one of the most popular and trusted protocols, with Modbus RTU (for serial connection) and Modbus TCP/IP (for Ethernet Networks) normally used as the backbone preference in industrial automation, substation automation, and building automation solutions. To address the slow migration of communication standards from Serial- to Ethernet-based devices, ATOP has a complete range of Modbus Gateway devices to act as converters to facilitate this migration, while extending the life of previous investment costs.

Product Line Overview

Entry level - Modbus Gateway

FEATURES

- Low-cost, easy to apply.
- Seamlessly provides conversion between ethernet-based Modbus TCP and serial-based Modbus RTU/ASCII.
- Suitable for periodic data polling. Frequent pollings may cause long latencies and Modbus TCP Timeouts.

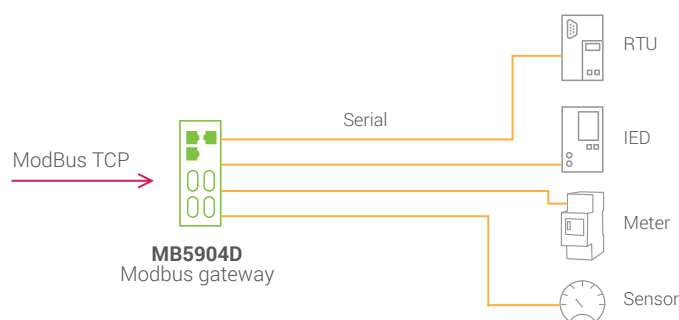

Advanced - Concentrator

FEATURES

- Suitable for frequent polling requests from multiple devices.
- Allows data to be polled automatically from slave devices. Data will be available for master polling at all times.
- Faster responsiveness, removing the risk of Modbus TCP timeouts.
- Customizable register mapping to optimize different masters needing to access different data structures.
- Supports link status and data timestamp access.

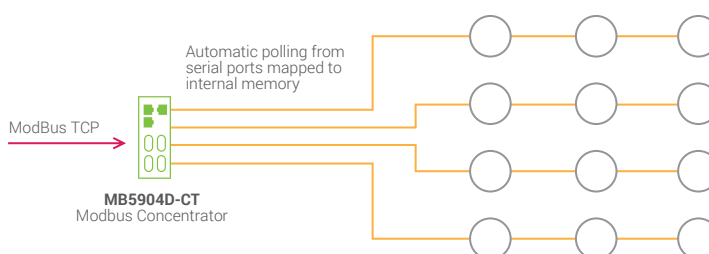

Top of the line - Redundant Concentrator

FEATURES

- All features of the Advanced Concentrator.
- Redundant architecture for the most mission critical applications. Automatic link recovery in case of Ethernet or Serial link failure.
- Supports link status and data timestamp access.
- High performance, reliability, and EMC protection.

Automatic polling from serial ports with link failure recovery mechanism.

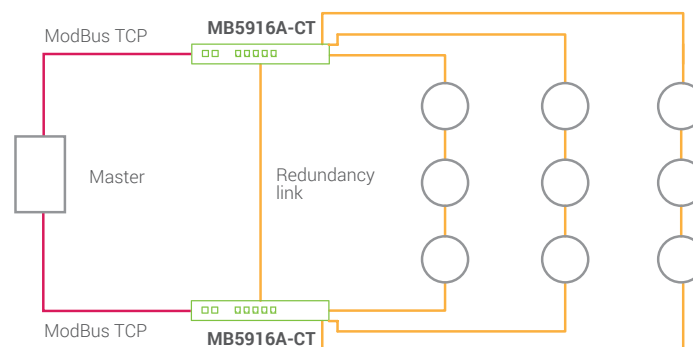

Modbus Redundant Concentrator Success Story



Modbus Redundant Concentrator

Challenge: To manage through a Modbus TCP SCADA a large low-voltage substation infrastructure that is Modbus RTU-based. The infrastructure is very complex, with each switchboard involving around 190 slaves that need to be accessed simultaneously for data, diagnostics, and configuration.

Location: Malaysia, Petrochemical and Refinery Complex

Protocol used: Modbus TCP/Modbus RTU.

Requirements: Short failure recovery time; very efficient Modbus polling in an environment with a high density of devices.

Challenges

- Supporting system integrator to define the topology.
- Customizing hardware with redundant Modbus concentrators with fiber uplink – 16 serial ports.
- Adjusting command priority to ensure each poll command can be executed within 600ms.
- Integration of customer's device management tool.
- On-site setup, config., test and troubleshooting.
- User-friendly configuration: development of a colored-block UI to identify memory area and enable easy set up of the memory mapping.

Solution provided

- Modbus redundant concentrators designed and set up in pairs, with redundancy fiber link between them and COM links that start from one device and end with the other.
- Software customization and optimization.
- Managed Ethernet switches providing the backbone to the customer's EWS.

Results achieved

- 600 ms complete polling for more than 100 slaves, each with 20 registers (19200 bps).
- 500 ms secondary recovery to handle primary device downtime or device failure.
- Multi-write command to map different slaves simultaneously to improve efficiency.

Network Topology

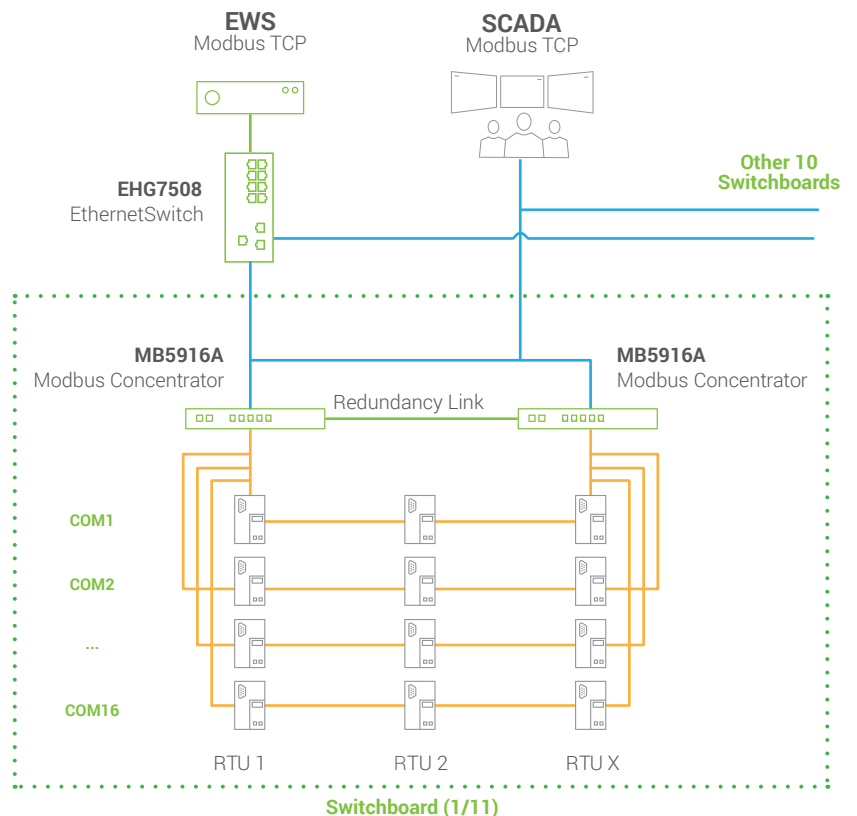

Modbus Gateways/ Modbus Concentrators

	Entry-level		Wi-Fi	4G	Advanced					
										
General Information										
Model Number	MB5201	MB5202	MW5501/2C	MB5901B	MB5901	MB5904D	MB5908	MB5916	MB5908A	MB5916A
Network Interfaces										
Total number of ports	1	1	1	1	2	2	2	2	6	6
Total Fast Ethernet	1	1	1	-	2	(2)	2	2	6	6
10/100 BaseT(X)	1	1	1	-	2	(2)	2	2	(6)	(6)
100 Base-X (SFP)	-	-	-	-	-	-	-	-	(6)	(6)
Total Gigabit	-	-	-	1	-	(2)	-	-	-	-
10/100/1000 BaseT(X)	-	-	-	1	-	-	-	-	-	-
100/1000 Base-X SFP	-	-	-	-	-	(2)	-	-	-	-
Wi-Fi interface	-	-	2.4GHz	-	-	-	-	-	-	-
3G/4G interfaces	-	-	-	●	-	-	-	-	-	-
Network Redundancy										
RSTP redundant ports	-	-	-	-	2	2	2	2	2	2
Serial Ports										
Number of ports	1	2	1/2	(1)/(2)	1	4	8	16	8	16
RS-232 RS-422 RS-485 full func.	1	2	1/2	1(RS-232/485)	1	4	8	16	8	16
RS-232 only	-	-	-	1(only 10 vers.)	-	-	-	-	-	-
Serial port Isolation	-	3kV(Optional)	-	-	-	3kV(Optional)	2.5kV(Optional)	2.5kV(Optional)	3kV(Optional)	3kV(Optional)
Serial port connector	DSub9/TB	DSub9/TB	DSub9/TB	DSub9/TB	DSub9/TB	DSub9/TB	RJ45	RJ45	DSub9/TB	DSub9/TB
Other interfaces										
Digital Inputs				2 (Optional)						
Digital Outputs				2 (Optional)						
Relay Output						1			2	2
Power Supply input										
Power Input	5 & 9~30 VDC	5 & 9~30 VDC	9~48 VDC	9~48 VDC	9~48 VDC	12~48 VDC	24~48 VDC	24~48 VDC	24~48 VDC	24~48 VDC
Power PoE 802.3af (PD)					Optional	Optional				
AC power input							100~240VAC	100~240VAC	100~240VAC	100~240VAC
High Voltage DC power input									100~370VDC	100~370VDC
Power Redundancy	●	●				●			●	●
Mechanical										
Installation	Field-Mount	Field-Mount	DIN-Rail	DIN-Rail	DIN-Rail	DIN-Rail	Rack-mount	Rack-mount	Rack-mount	Rack-mount
Ingress Protection	IP30	IP30	IP30	IP30	IP30	IP30	IP30	IP30	IP30	IP30
Dimensions (L x H x D) in mm	65 x 78 x 27	75 x 85 x 28	47 x 110 x 90	32 x 110 x 90	32 x 122 x 92	55 x 145 x 113	440 x 44 x 200	440 x 44 x 200	440 x 44 x 309	440 x 44 x 309
Supported Temperatures										
Operations Temperature	-40~70° C	-40~70° C	-10~60° C	-40~70° C	-40~85° C	-40~85° C	-20/70° C	-20/70° C	-40/85° C	-40/85° C
Storage Temperature	-40~85° C	-40~85° C	-40~85° C	-40~85° C	-40~85° C	-40~85° C	-40~85° C	-40~85° C	-40~85° C	-40~85° C
Modbus Features										
Modbus TCP/RTU/ASCII Gateway	●	●	●	●	●	●	●	●	●	●
Modbus TCP/RTU/ASCII Concentrator					●	●	●	●	●	●
Redundancy option						●	●	●	●	●
Maximum number of slaves	●	●	●	●	●	●	●	●	●	●
Exception error handling	●	●	●	●	●	●	●	●	●	●
VPN			●	●	●	●	●	●	●	●
Compliance										
Industrial EMC Protection	●	●	●	●	●	●	●	●	●	●
CE/FCC	●	●	●	●	●	●	●	●	●	●
UL/EN/IEC(CB)60950-1 and/or 62368-1			●	●						
EN60950-1 and/or EN62368	●	●	●	●	●	●	●	●	●	●
UL61010-2-201						●				
EN50155 / EN50121-4										
IEC61850-3 / IEEE1613									●	●

Protocol Gateways for Smart-Grid and Substations

Substation retrofitting

IEC 61850 standard saw quick adoption from utilities across the world. It not only enabled high levels of interoperability between devices from different manufacturers but also provided advanced means of communication. Electrical grid system is a large power distribution network that went through decades of development. Generally, the power utilities invest in the latest technologies available to them at the times of their installations such as the latest IEC 61850 compliant equipment.

However, the life-time of the equipment in the grid system can typically span several years as a life-cycle of a substation can be more than 50 years. Replacement of latest devices ahead of time is out of the question due to their substantial investments. Therefore, the legacy equipment will normally remain in use and the power grid is naturally equipped with both legacy and new technologies. The challenge for the smart grid system is to continue developing the power grid with a focus on enabling enhanced monitoring and control across the electrical distribution network by integrating newer and legacy technologies with seamless control and supervision.

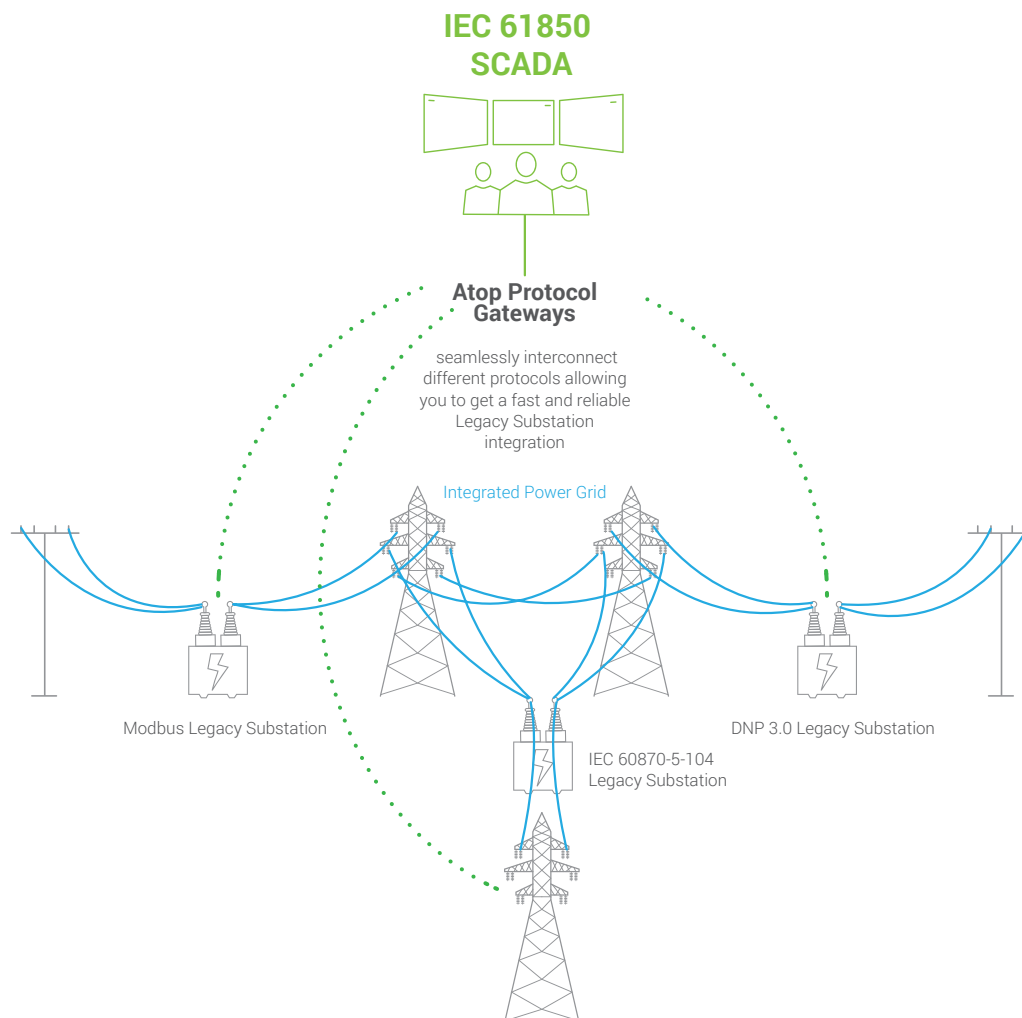

Integrating Legacy Protocols in the Smart Grid



ATOP's broad product range has been specifically designed to allow seamless integration as simple as possible. Legacy substations operating with outdated or unpopular protocols may remain in place and can be connected to the new network through ATOP's Protocol Gateways. Our powerful hardware platform with a stable and reliable software will manage the translation from protocol to protocol transparently, providing highly reliable and fault-tolerant industrial Protocol Gateways featuring integrated 3G/4G connectivity.

ATOP's user-friendly configuration tool will help the customer or the system integration to map data points. Rugged and reliable, they command within minutes by enabling the customer to manage changeovers, upgrades, or integrations in a fast and cost effective way.

To support the customer in handling these challenges easily, ATOP offers more than 80 different protocol combinations that are available on 10 different hardware platforms empowering the customer to choose among hundreds of different products!

Protocol	Interface	Function
Modbus RTU	RS-485 ; RS-232 ; RS-422	Master/Slave
Modbus TCP	Ethernet	Client/Server
DNP 3.0 over Serial	RS-485 ; RS-232 ; RS-422	Master/Slave
DNP 3.0 over Ethernet	Ethernet	Client/Server
IEC 60870-5-101	RS-485 ; RS-232 ; RS-422	Master/Slave
IEC 60870-5-103	RS-485 ; RS-232 ; RS-422	Master/Slave
IEC 60870-5-104	Ethernet	Client/Server
IEC 61850	Ethernet	Client/Server

Hardware platforms

	Hardware	Mount	Ethernet Ports	RS-485 RS-232 RS-422 ports	Additional features
	PG5901	Din-Rail	2 (RJ45)	1 (TB5 or DB9)	can be PoE-powered [optional]
	PG5901B	Din-Rail	w1 (RJ45)	1 (DB9 vers.) / 2 (TB14 I/O vers.)	4G LTE or 3G connectivity
	PG5904D-4P	Din-Rail	2 (RJ45 or SFP)	4 (TB5 or DB9)	can be PoE-powered [optional]
	PG5908	Rack-Mount	2 (RJ45)	8 (RJ45)	
	PG5916	Rack-Mount	2 (RJ45)	16 (RJ45)	
	PG5900A	Rack-Mount	6 (SFP or RJ45)		
	PG5908A	Rack-Mount	6 (SFP or RJ45)	8 (TB5 or DB9)	
	PG5916A	Rack-Mount	6 (SFP or RJ45)	16 (TB5 or DB9)	

Supported Protocols

The ATOP Protocol Gateway Platform supports:

- Modbus TCP/RTU/ASCII (Ethernet and Serial) - Client/Server and Master/Slave
- DNP3.0 (Ethernet and Serial) - Client/Server and Master/Slave
- EC 60870-5-101 (Serial) - Master/Slave
- IEC 60870-5-103 (Serial) - Master/Slave
- IEC 60870-5-104 (Ethernet) - Client/Server
- IEC 61850 (Ethernet) - Client/Server

Architecture Concept

Able to run Client-Server – Master/ Slave modes at the same time, ATOP's family of Protocol Gateways are a suite of powerful industrial gateway platforms that are bundled with different protocol stacks.

The architecture is made of 3 different parts:

- ① **Device Server/Slave interface:** It listens to a Master/Client that is outside a device, such as a PLC. This means that ATOP's Protocol Gateway will behave towards an external master as a slave device and with the respective protocol.
- ② **Device Client/Master interface:** It actively polls or issues commands to an external Slave/Server.
- ③ **ADH:** The core of the unit that moves, translates, and maps the data points, commands, and events between the client and server sides.

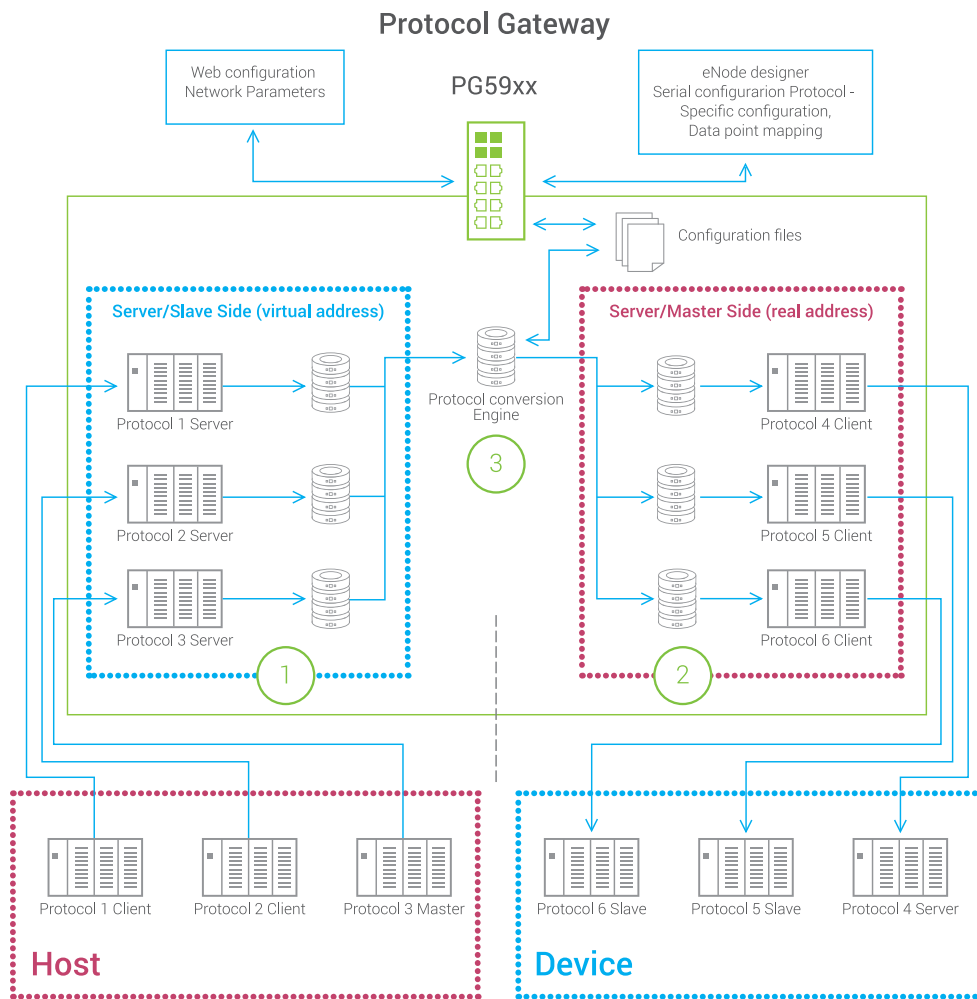

The figure shows the device as part of a general architecture.

The Protocol Gateway allows mapping of any protocol to any Serial or Ethernet port from the protocol itself. eNode Designer allows the user to assign different protocols to different ports, define the serial port settings, and define the protocol-specific parameters. Using eNode designer, the user can define for the Master/Client the real IDs of the devices needing to obtain data or send commands from, and will set for the Slave/Server the virtual addresses to be used from the client for data-point or command mapping.

The core of the Gateway is the Protocol Engine, in which data, commands, and events are stored and mapped to other protocols.

Smart-Grid Protocol Gateways - Hardware

Advanced



Model Number	PG5901	PG5901B	PG5904D	PG5908	PG5916	PG5900A	PG5908A	PG5916A
Interfaces								
Total number of ports	2	1	2	2	2	6	6	6
Total Fast Ethernet	2	-	(2)	2	2	6	6	6
10/100 BaseT(X)	2	-	(2)	2	2	(6)	(6)	(6)
100 Base-X (SFP)	-	-	-	-	-	(6)	(6)	(6)
Total Gigabit	-	1	(2)	-	-	-	-	-
10/100/1000 BaseT(X)	-	1	-	-	-	-	-	-
100/1000 Base-X SFP	-	-	(2)	-	-	-	-	-
1000Base-X SFP	-	-	-	-	-	-	-	-
Wireless LAN	-	-	-	-	-	-	-	-
3G/4G interfaces	-	3G/4G	-	-	-	-	-	-
Network Redundancy								
RSTP redundant ports	2	-	2	2	2	6	6	6
HSR/PRP redundant ports	-	-	-	-	-	-	-	-
Serial Ports								
Number of ports	1	1/2 (IO vers)	4	8	16	-	8	16
RS-232 RS-422 RS-485 full func.	1	1 (RS-232/485)	4	8	16	-	8	16
RS-232 only	-	1 (only IO vers)	-	-	-	-	-	-
Serial port Isolation	-	-	3kV Optional	2.5kV Optional	2.5kV Optional	-	3kV Optional	3kV Optional
Terminal Block (TB) ports	(1)	(1)	(4)	-	-	-	(8)	(16)
D-Sub 9 (DB9) ports	(1)	(1)	(4)	-	-	-	(8)	(16)
RJ45 Serial ports	-	-	-	8	16	-	-	-
Other Interfaces								
Digital Inputs		2 (Optional)						
Digital Outputs		2 (Optional)						
Power Supply input								
Low Voltage DC power Input	9~48 VDC	9~48 VDC	12~48 VDC	24~48 VDC	24~48 VDC	24~48 VDC	24~48 VDC	24~48 VDC
Power through PoE 802.3af	Optional		Optional					
AC power input				100~240VAC	100~240VAC	100~240VAC	100~240VAC	100~240VAC
High Voltage DC power input						100~370VDC	100~370VDC	100~370VDC
Power Inputs	1	1	2	1	1	2	2	2
Relay Output			2			2	2	2
Installation								
Mount	DIN-Rail	DIN-Rail	DIN-Rail	Rack-Mount	Rack-Mount	Rack-Mount	Rack-Mount	Rack-Mount
Ingress Protection	IP30	IP30	IP30	IP30	IP30	IP30	IP30	IP30
Environment								
Operational Temperature	-40/85° C	-40/75° C	-40/85° C	-20/70° C	-20/70° C	-40/85° C	-40/85° C	-40/85° C
Compliance								
Industrial EMC Protection	•	•	•	•	•	•	•	•
UL60950-1								
UL61010-2-201			•			EN	EN	EN
EN60950-1	•	•		•	•			
CE (EN61000-6-2 and EN61000-6-4)	•	•	•	•	•	•	•	•
RED (Radio Directive 2014/53/EU)	n/a	•	n/a	n/a	n/a	n/a	n/a	n/a
FCC Part 15 Subpart B Class A	•	•	•	•	•	•	•	•
IEC61850-3 / IEEE1613						•	•	•

Smart-Grid Protocol Gateways - Software

Advanced



General Information

Model Number	PG5901	PG5901B	PG5904D	PG5908	PG5916	PG5900A	PG5908A	PG5916A
--------------	--------	---------	---------	--------	--------	---------	---------	---------



Protocol Gateway Software Model Number / Availability

Front-End Protocol	Back-End Protocol	SKU							
Modbus RTU/ ASCII Slave	DNP3.0 Master			MBSS-DNSM	MBSS-DNSM	MBSS-DNSM		MBSS-DNSM	MBSS-DNSM
	DNP3.0 Client	MBSS-DNEC	MBSS-DNEC	MBSS-DNEC	MBSS-DNEC	MBSS-DNEC		MBSS-DNEC	MBSS-DNEC
	IEC 101 Master			MBSS-01SM	MBSS-01SM	MBSS-01SM		MBSS-01SM	MBSS-01SM
	IEC 103 Master			MBSS-03SM	MBSS-03SM	MBSS-03SM		MBSS-03SM	MBSS-03SM
	IEC 104 Client	MBSS-04EC	MBSS-04EC	MBSS-04EC	MBSS-04EC	MBSS-04EC		MBSS-04EC	MBSS-04EC
Modbus TCP Server	IEC 61850 Client	MBSS-50EC	MBSS-50EC	MBSS-50EC	MBSS-50EC	MBSS-50EC		MBSS-50EC	MBSS-50EC
	DNP3.0 Master	MBES-DNSM	MBES-DNSM	MBES-DNSM	MBES-DNSM	MBES-DNSM		MBES-DNSM	MBES-DNSM
	DNP3.0 Client	MBES-DNEC	MBES-DNEC	MBES-DNEC	MBES-DNEC	MBES-DNEC	MBES-DNEC	MBES-DNEC	MBES-DNEC
	IEC 101 Master	MBES-01SM	MBES-01SM	MBES-01SM	MBES-01SM	MBES-01SM		MBES-01SM	MBES-01SM
	IEC 103 Master	MBES-03SM	MBES-03SM	MBES-03SM	MBES-03SM	MBES-03SM		MBES-03SM	MBES-03SM
DNP3.0 Serial Slave	IEC 104 Client	MBES-04EC	MBES-04EC	MBES-04EC	MBES-04EC	MBES-04EC	MBES-04EC	MBES-04EC	MBES-04EC
	IEC 61850 Client	MBES-50EC	MBES-50EC	MBES-50EC	MBES-50EC	MBES-50EC	MBES-50EC	MBES-50EC	MBES-50EC
	Modbus Master			DNSS-MBSM	DNSS-MBSM	DNSS-MBSM		DNSS-MBSM	DNSS-MBSM
	Modbus Client	DNSS-MBEC	DNSS-MBEC	DNSS-MBEC	DNSS-MBEC	DNSS-MBEC		DNSS-MBEC	DNSS-MBEC
	DNP3.0 Master			DNSS-DNSM	DNSS-DNSM	DNSS-DNSM		DNSS-DNSM	DNSS-DNSM
	DNP3.0 Client	DNSS-DNEC	DNSS-DNEC	DNSS-DNEC	DNSS-DNEC	DNSS-DNEC		DNSS-DNEC	DNSS-DNEC
	IEC 101 Master			DNSS-01SM	DNSS-01SM	DNSS-01SM		DNSS-01SM	DNSS-01SM
DNP3.0 TCP/IP Server	IEC 103 Master			DNSS-03SM	DNSS-03SM	DNSS-03SM		DNSS-03SM	DNSS-03SM
	IEC 104 Client	DNSS-04EC	DNSS-04EC	DNSS-04EC	DNSS-04EC	DNSS-04EC		DNSS-04EC	DNSS-04EC
	IEC 61850 Client	DNSS-50EC	DNSS-50EC	DNSS-50EC	DNSS-50EC	DNSS-50EC		DNSS-50EC	DNSS-50EC
	Modbus Master	DNES-MBSM	DNES-MBSM	DNES-MBSM	DNES-MBSM	DNES-MBSM		DNES-MBSM	DNES-MBSM
	Modbus Client	DNES-MBEC	DNES-MBEC	DNES-MBEC	DNES-MBEC	DNES-MBEC	DNES-MBEC	DNES-MBEC	DNES-MBEC
	DNP3.0 Client	DNES-DNSM	DNES-DNSM	DNES-DNSM	DNES-DNSM	DNES-DNSM		DNES-DNSM	DNES-DNSM
IEC60870-5-101 Slave	IEC 101 Master	DNES-01SM	DNES-01SM	DNES-01SM	DNES-01SM	DNES-01SM		DNES-01SM	DNES-01SM
	IEC 103 Master	DNES-03SM	DNES-03SM	DNES-03SM	DNES-03SM	DNES-03SM		DNES-03SM	DNES-03SM
	IEC 104 Client	DNES-04EC	DNES-04EC	DNES-04EC	DNES-04EC	DNES-04EC	DNES-04EC	DNES-04EC	DNES-04EC
IEC60870-5-104 Server	IEC 61850 Client	DNES-50EC	DNES-50EC	DNES-50EC	DNES-50EC	DNES-50EC	DNES-50EC	DNES-50EC	DNES-50EC
	Modbus Master			01SS-MBSM	01SS-MBSM	01SS-MBSM		01SS-MBSM	01SS-MBSM
	DNP3.0 Master			01SS-DNSM	01SS-DNSM	01SS-DNSM		01SS-DNSM	01SS-DNSM
	IEC 103 Master			01SS-03SM	01SS-03SM	01SS-03SM		01SS-03SM	01SS-03SM
	Modbus Master	04ES-MBSM	04ES-MBSM	04ES-MBSM	04ES-MBSM	04ES-MBSM		04ES-MBSM	04ES-MBSM
	Modbus Client	04ES-MBEC	04ES-MBEC	04ES-MBEC	04ES-MBEC	04ES-MBEC	04ES-MBEC	04ES-MBEC	04ES-MBEC
	DNP3.0 Master	04ES-DNSM	04ES-DNSM	04ES-DNSM	04ES-DNSM	04ES-DNSM		04ES-DNSM	04ES-DNSM
IEC61850 Server	DNP3.0 Client	04ES-DNEC	04ES-DNEC	04ES-DNEC	04ES-DNEC	04ES-DNEC	04ES-DNEC	04ES-DNEC	04ES-DNEC
	IEC 101 Master	04ES-01SM	04ES-01SM	04ES-01SM	04ES-01SM	04ES-01SM		04ES-01SM	04ES-01SM
	IEC 103 Master	04ES-03SM	04ES-03SM	04ES-03SM	04ES-03SM	04ES-03SM		04ES-03SM	04ES-03SM
	IEC 61850 Client	04ES-50EC	04ES-50EC	04ES-50EC	04ES-50EC	04ES-50EC	04ES-50EC	04ES-50EC	04ES-50EC
	Modbus Master	50ES-MBSM	50ES-MBSM	50ES-MBSM	50ES-MBSM	50ES-MBSM		50ES-MBSM	50ES-MBSM
	Modbus Client	50ES-MBEC	50ES-MBEC	50ES-MBEC	50ES-MBEC	50ES-MBEC	50ES-MBEC	50ES-MBEC	50ES-MBEC
	DNP3.0 Master	50ES-DNSM	50ES-DNSM	50ES-DNSM	50ES-DNSM	50ES-DNSM	50ES-DNSM	50ES-DNSM	50ES-DNSM
IEC61850 Server	DNP3.0 Client	50ES-DNEC	50ES-DNEC	50ES-DNEC	50ES-DNEC	50ES-DNEC	50ES-DNEC	50ES-DNEC	50ES-DNEC
	IEC 101 Master	50ES-01SM	50ES-01SM	50ES-01SM	50ES-01SM	50ES-01SM		50ES-01SM	50ES-01SM
	IEC 103 Master	50ES-03SM	50ES-03SM	50ES-03SM	50ES-03SM	50ES-03SM		50ES-03SM	50ES-03SM
	IEC 104 Client	50ES-04EC	50ES-04EC	50ES-04EC	50ES-04EC	50ES-04EC	50ES-04EC	50ES-04EC	50ES-04EC

Wireless Routers

Mobile and wireless transmission are fundamental for IoT applications. ATOP wireless and cellular devices allow you to easily extend your coverage. The wireless routers support:

- Industrial FWA solution for 4G & 5G NR networks
- Wi-Fi 5 2x2 MU-MIMO with 802.11 ac peak speed 867 Mbps
- Easily Expandable Mesh WiFi System
- Backup WAN interfaces for connection reliability
- PoE PD support for flexible deployment

Wireless Routers			
			
	NEW! Coming soon	NEW! Coming soon	NEW! Coming soon
Model Number	AWR5805	CWR5805	CWG5804
General Information			
Total number of WAN ports	1	1	-
10/100 BaseT(X)	-	-	-
10/100/1000 BaseT(X)	1	1	-
Total number of LAN ports	4	4	4
10/100 BaseT(X)	-	-	-
10/100/1000 BaseT(X)	4	4	4
Wireless LAN	802.11 a/b/g/n/ac	802.11 a/b/g/n/ac	802.11 abgn/ac
Mobile interfaces	-	4G or 5G	4G or 5G
Serial Ports			
Number of ports	0	0	1
RS-232, RS-422, RS-485 full function	-	-	1 (RS-232/485)
RS-232 only	-	-	-
Serial port isolation	-	-	-
Terminal block(TB) ports	-	-	-
D-Sub 9 (DB9) ports	-	-	1
Other Interfaces			
Digital Inputs	-	-	1
Digital outputs	-	-	1
Power supply input			
Low voltage DC power input	12~48 VDC	12~48 VDC	12~48 VDC
Power through PoE 802.3af	Optional	Optional	Optional
AC power input	-	-	-
High voltage DC power input	-	-	-
Power inputs	1	1	1
Relay output	-	-	-
Installation Option			
DIN-Rail Mount	Yes	Yes	Yes
19" Rack Mount	-	-	-
Field Mount	Yes	Yes	Yes
Mobile Wireless Router			
4G/5G mobile connectivity	-	Yes	Yes
Dual-SIM Backup	-	Yes	Yes
Firewall	Yes	Yes	Yes
VPN	Yes	Yes	Yes
Wi-Fi Mesh Connectivity	Yes	Yes	Yes
Mobile Ether WAN backup/failover	-	Yes	-
Compliance			
Industrial EMC Protection	Yes	Yes	Yes
UL60950-1 and/or UL62368	Yes	Yes	Yes
UL61010-2-201	-	-	-
EN60950-1 and/or EN62368	Yes	Yes	Yes
CE (EN61000-6-2 and EN61000-6-4)	Yes	Yes	Yes
RED (Radio Directive 2014/53/EU)	Yes	Yes	Yes
FCC Part 15 Subpart B Class A	Yes	Yes	Yes
EN50155 - EN50121-4 Railway	-	-	-
IEC61850-3 / IEEE1613	-	-	-

Appendix : Protocol Specifications

IEC61850 Server/ Client	
Supported Functions (Read, Write)	<ul style="list-style-type: none"> • Generic access to the data (Read, Write) • Clock Synchronization • 8 Logical Devices per Port
Supported Control Type of commands	<ul style="list-style-type: none"> • Direct-with-Normal-Security • Select Before Operate (SBO)-with-Normal-Security • Direct-with-Enhanced Security Select Before Operate (SBO)-with-Enhanced-Security
Implemented Protocol Subsets	<ul style="list-style-type: none"> • IEC 61850-6 (Substation Configuration Language Description: SCL) • IEC 61850-7-1 (Principles and Models) • IEC 61850-7-2 (Abstract Communication Service Interface: ACSI) • IEC 61850-7-3 (Common Data Classes: CDC) • IEC 61850-7-4 (Logical Nodes and data Object Classes) • IEC 61850-8-1 (Mapping to Manufacturing Message Specification: MMS) • Edition 1 & Edition 2 are both Supported
DNP3 Server/ Client/ Master/ Slave	
Support Level	Level 2 and subset of Level 3
General Specifications	<ul style="list-style-type: none"> • Serial Mode or Ethernet with TCP or UDP Mode • Server side supports serving up to 5 client in TCP Mode • Client side in a single RS-485 port, supports connecting up to 16 IEDs • Client side supports connecting up to 16 IEDs • Maximum Fragment size 2048 octets • Protocol implementation with configurable parameters conforms to IEEE Std 1815-2012 level 2
Supported Functions	<ul style="list-style-type: none"> • Time Synchronization generic access to the data(Read, Write) • Commands with or without preselection (Select, Operate, Direct Operate) • Transmission of time-tagged events • Counter management (Immediate Freeze, Freeze and Clear) • Self-address
Supported DNP3 Object Library	<ul style="list-style-type: none"> • Binary Inputs up to 8000 pts • Binary Outputs up to 2000 pts • Double Inputs up to 4000 pts • Analog Inputs up to 250 pts • Analog Outputs up to 250 pts • Counters up to 250 pts
Modbus Server/ Client/ Master/ Slave	
General Specifications	<ul style="list-style-type: none"> • Support Modbus RTU and ASCII in Serial mode • Support Modbus in TCP mode • For Modbus devices, support connecting up to 64 Modbus slaves/servers - client/masters • Support maximum number of data points in read direction: 8000 pts • Support maximum number of commands in write direction: 4000 pts
Supported Function Codes	<ul style="list-style-type: none"> 1: Read Coils 2: Read Discrete Inputs 3: Read Holding Registers 4: Read Input Registers 5: Write Single Coil 6: Write Single Register 15: Write Multiple Coils 16: Write Multiple Registers 43: Read Device Identification (server side only)
Supported Exception Codes	<ul style="list-style-type: none"> 1: Illegal function 2: Illegal data address 3: Illegal data value 4: Server device failure 6: Server device busy

IEC 60870-5-101 Master/ Slave

General Specifications	<ul style="list-style-type: none"> • Protocol implementation with configurable parameters conforms to the IEC 60870-5-101 edition 2 specification • Process Information in Monitor and Control Direction • Balanced and Unbalanced Modes • CP24Time2a or CP56Time2a timestamp for monitor direction report
Supported Functions	<ul style="list-style-type: none"> • Station Initialization • Interrogation • Read Procedure • Cyclic Data and Spontaneous Transmission (Slave Side only) • Clock Synchronization • Transmission of Integrated Totals • Direct and SBO command
Supported Data Types	<ul style="list-style-type: none"> • Monitors Points: Each supports up to 1000 pts: Single Point, Double Point, Step Position, Bit String, Measured with Normalized Value, Measured with Scaled Value, Measured Short Floating Point Value, Integrated Totals • Control Points: Each supports up to 500 pts: Single Command, Double Command, Regulating Step Command, Set Point Command with Normalized Value, Set Point Command with Scaled Value, Set Point Command Short Floating Point, Bit string

IEC 60870-5-103 Master

General Specifications	<ul style="list-style-type: none"> • Protocol implementation with configurable parameters conforms to the IEC 60870-5-103:1997 • Master supports connecting up to 16 IEDs • Process Information in Monitor and Control Direction • Unbalanced Modes
Supported Functions	<ul style="list-style-type: none"> • Station Initialization, Supports reset FCB and CU • General Interrogation • Clock Synchronization • Command Transmission • Test Mode • Blocking of Monitor Direction
Supported Data Types	<ul style="list-style-type: none"> • Monitor direction: <ul style="list-style-type: none"> * Status indications in monitor direction: from <16> to <30> * Supervision indications in monitor direction: <32>, <33>, from <35> to <39>, <46>, <47> * Earth fault indications in monitor direction: from <48> to <52> * Fault indications in monitor direction: from <64> to <93> * Auto-reclosure indications in monitor direction: from <128> to <130> * Measurands in monitor direction: from <144> to <148> • Control direction: <ul style="list-style-type: none"> * General commands in control direction: from <16> to <19>, from <23> to <26>

IEC 60870-5-104 Server/ Client

General Specifications	<ul style="list-style-type: none"> • Server side supports serving up to 5 client • Client side supports connecting up to 10 IEDs • Protocol implementation with configurable parameters conforms to the IEC 60870-5-104 specification edition 2 • Process Information in Monitor and Control Direction • CP56Time2a timestamp for Control Commands
Supported Functions	<ul style="list-style-type: none"> • Station Initialization • Interrogation • Read Procedure • Cyclic Data and Spontaneous Transmission (Slave Side only) • Clock Synchronization • Transmission of Integrated Totals • Direct and SBO command
Supported Data Types	<ul style="list-style-type: none"> • Monitors Points: Each supports maximum 1000 pts: Single Point, Double Point, Step Position, Bit String, Measured with Normalized Value, Measured with Scaled Value, Measured Short Floating Points Value, Integrated Totals. • Control Points: Each supports maximum 500 pts: Single Command, Double Command, Regulating Step Command, Set Point Command with Normalized Value, Set Point Command with Scaled Value, Set Point Command Short Floating Point, Bitstring. • Event Logging (Server Side only) Universal Event Buffer up to 20,000 Events



Atop Technologies, Inc.

TAIWAN HEADQUARTERS

2F, No. 146, Sec. 1, Dongxing Rd.,
Zhubei City, Hsinchu County, Taiwan
Tel: +886-3-550-8137
Fax: +886-3-550-8131
E-mail: info@atop.com.tw



www.atoponline.com