

VENTING INSTRUCTIONS FOR UNIT HEATERS

MODEL UBZ: SEPARATED-COMBUSTION BLOWER TYPE

MODEL UDZ: SEPARATED-COMBUSTION FAN TYPE

GENERAL INFORMATION

This manual applies only to venting instructions and must be used with the installation manual. Both manuals are shipped with the heater. If either manual is missing, contact your distributor before beginning installation.

Important Safety Information

Please read all information in this manual thoroughly and become familiar with the capabilities and use of your appliance before attempting to operate or maintain this unit. Pay attention to all dangers, warnings, cautions, and notes highlighted in this manual. Safety markings should not be ignored and are used frequently throughout to designate a degree or level of seriousness.

DANGER: A danger statement describes a potentially hazardous situation that if not avoided, will result in severe personal injury or death and/or property damage.

WARNING: A warning statement describes a potentially hazardous situation that if not avoided, can result in severe personal injury and/or property damage.

CAUTION: A caution statement describes a potentially hazardous situation that if not avoided, can result in minor or moderate personal injury and/or property damage.

NOTE: A note provides important information that should not be ignored.

⚠ CAUTION ⚠

These units should not be used in an application where the heated space temperature is below 50°F (10°C). Operating under low ambient conditions may cause condensate to form in the heat exchanger.

⚠ DANGER ⚠

- Do not use an existing venting system. This heater requires installation of the combustion air/vent system ordered with the unit, either option CC6 for a horizontal system or option CC2 for a vertical system. Failure to comply could result in severe personal injury, death, and/or property damage.
 - Heaters certified for residential use are intended for the heating of non-living spaces that are attached to or part of a structure that contains space for family living quarters. They are not intended to be the primary source of heat in residential applications or to be used in sleeping quarters.
 - Installation should be performed by a qualified agency in accordance with these instructions. The qualified service agency installing this unit is responsible for the installation.
-

Venting and Combustion Air Requirements

⚠ WARNING ⚠

All separated-combustion units **MUST BE** equipped with both combustion air and exhaust piping to the outdoors.

GENERAL INFORMATION—CONTINUED

Venting and Combustion Air Requirements—Continued

⚠ CAUTION ⚠

- **When an existing appliance is removed or replaced in a venting system, verify that the venting system is properly sized to vent the new appliance. An improperly sized venting system may result in the formation of condensate, leakage, and/or spillage.**
 - **Do not intermix different vent system parts from different manufacturers in the same venting system.**
 - **Concentric horizontal and vertical vent/combustion air systems are the only venting/combustion air systems approved for these units.**
-

- Unit sizes 030–400 of model UBZ units and 150–400 of model UDZ units are certified only for commercial/industrial installations.
 - Unit sizes 030–125 of model UDZ units are certified for both residential and commercial/industrial installations.
-

NOTE: The unique concentric adapter assembly required with this heater allows for both combustion air and exhaust piping with only one horizontal or vertical penetration hole in the building.

Hazards of Chlorine

The presence of chlorine vapors in the combustion air of gas-fired heating equipment presents a potential corrosion hazard. Chlorine—usually in the form of Freon or degreaser vapors—when exposed to flame will precipitate from the compound and go into solution with any condensation present in the heat exchanger or associated parts. The result is hydrochloric acid, which readily attacks all metals including 300 grade stainless steel. Care should be taken to separate these vapors from the combustion process. This may be done by the wise location of the combustion air terminal with regard to exhausters or prevailing wind directions. Chlorine is heavier than air. Keep these facts in mind when determining the installation location of the heater in relation to building exhaust systems.

Type of Pipe

All pipe is field-supplied. Select the installation type that applies, Requirements are listed for both the vent pipe and the combustion air inlet pipe:

Residential installations:

- Single-wall vent pipe approved to UL standard 1738 for a category III appliance is required.
- **Horizontal vent:** the horizontal section of pipe in the vent terminal that extends through the box and runs concentric through the combustion air pipe must be one-piece with no joints.
- **Vertical vent:** the section of pipe in the vent terminal that extends through the box and runs concentric through the combustion air pipe must be one-piece with no joints.
- **Combustion air inlet pipe:** sealed, single-wall galvanized pipe is recommended for the inlet air run and terminal combustion air pipe.

Commercial/industrial installations:

- Single-wall vent pipe approved for a category III appliance or single-wall, 26-gauge or heavier galvanized or equivalent vent pipe is required between the heater and the concentric adapter box.
- **Horizontal vent:** the horizontal section of pipe in the vent terminal that extends through the box and runs concentric through the combustion air pipe must be one-piece with no joints.
- **Vertical vent:** double-wall (type B) vent pipe is required for the vertical vent terminal. The section of pipe in the vent terminal that extends through the box and runs concentric through the combustion air pipe must be one-piece with no joints.
- **Combustion air inlet pipe:** sealed, single-wall galvanized pipe is recommended for the inlet air run and terminal combustion air pipe.

Venter Outlet and Combustion Air Inlet Connection Requirements

- **Venter outlet connection on unit sizes 030, 045, and 060:** when using 3-inch diameter pipe, a 4- to 3-inch (102- to 76-mm) taper-type reducer is required at the venter outlet—for category III, attach a 4-inch appliance adapter from a category III pipe manufacturer directly to the collar and then use a reducer if using 3-inch pipe.
- **Combustion air inlet connection on unit sizes 030, 045, and 060:** when using 3-inch diameter pipe, a 3- to 4-inch (76- to 102-mm) taper-type increaser is required at the inlet air collar.
- **Both heater connections on unit sizes 200, 225, 250, 300, 350, and 400:** require a minimum of 12 inches (305 mm) of straight pipe at both heater connections.
- Connections are shown in **Figure 1**. Connection sizes are listed in **Table 1**.

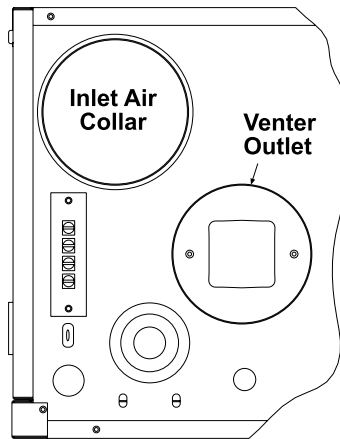

Figure 1. Typical Combustion Air Inlet and Venter Outlet Connections

Connection	Unit Size		
	030, 045, 060, 075, 100, 125	150, 175, 200, 225, 250	300, 350, 400
Connection Diameter (Inches (mm))			
Venter outlet	4 (102)	5 (127)	6 (152)
Combustion air inlet collar		6 (152)	

Pipe Size Requirements

- Pipe diameters of the outside (terminal) concentric pipes are listed in **Table 2**.
- Pipe diameter and length requirements listed in **Table 3** are for the indoor sections of pipe between the heater and the concentric adapter box.
- The minimum length between the heater and the concentric adapter box is 1 foot (305 mm) for unit sizes 030–125 and 3 feet (914 mm) for unit sizes 150–400.

Pipe	Unit Size	
	030, 045, 060, 075, 100, 125	150, 175, 200, 225, 250, 300, 350, 400
Pipe Diameter (Inches (mm))		
Inlet air	6 (152)	8 (203)
Vent	4 (102)	5 (127)

GENERAL INFORMATION—CONTINUED

Venting and Combustion Air Requirements—Continued

Pipe Size Requirements—Continued

Unit Size	Diameter (Inches (mm))		Feet (Meters)		
	Vent Pipe	Inlet Air Pipe	Maximum Vent Length	Equivalent Straight Length*	
				90-Degree Elbow	45-Degree Elbow
030, 045	3 (76)		15 (4.6)	2 (0.6)	1 (0.3)
	4 (102)		10 (3)		
060	3 (76)		25 (7.6)	3 (0.9)	1.5 (0.5)
	4 (102)		15 (4.6)	1.5 (0.5)	1 (0.3)
075	4 (102)		25 (7.6)	3 (0.9)	1.5 (0.5)
100, 125	4 (102)		35 (10.7)	4 (1.2)	2 (0.6)
150	5 (127)	6 (152)	30 (9.1)	3 (0.9)	1.5 (0.5)
175	5 (127)	6 (152)	30 (9.1)	3 (0.9)	2 (0.6)
200, 225, 250	5 (127)	6 (152)	40 (12.2)	4 (1.2)	2 (0.6)
300	6 (152)		45 (13.7)	4 (1.2)	2 (0.6)
350, 400	6 (152)		45 (13.7)	5 (1.5)	2.5 (0.8)

*Add all straight sections and equivalent lengths for elbows—the total combined length must not exceed the maximum vent length.

Joint Connection and Sealing Requirements

- **Category III pipe:** follow the pipe manufacturer's instructions for joining and sealing.
- **Single-wall pipe (vent pipe or combustion air pipe):** secure slip-fit pipe connections using sheet metal screws or rivets. Seal all joints with aluminum tape or silicone sealant.
- **Terminal section of double-wall vent pipe (vertical vent terminal option CC2 only) to vent cap:** connect in accordance with [APPENDIX](#).
- **Terminal section of double-wall vent pipe to single-wall vent pipe:** connect in accordance with [APPENDIX](#).
- **When joining two sections of double-wall vent pipe:** follow the pipe manufacturer's instructions for joining and sealing vent pipe sections.

NOTE: Joints connecting double-wall pipe apply only to commercial/industrial installations with a vertical vent terminal (option CC2).

Vent System Support Requirements

- Support horizontal runs every six feet (1.8 meters).
- Support vertical runs category III vent pipe in accordance with the pipe manufacturer's requirements.
- Support vertical single-wall pipe in accordance with accepted industry practice.

⚠ CAUTION ⚠

- **Do not rely on the heater to support either horizontal or vertical vent pipe.**
- **Use non-combustible supports on vent pipe.**

NOTE: The vertical vent terminal pipe does not attach to the concentric adapter box and must be supported during installation.

Clearance to Combustibles

⚠ DANGER ⚠

Do not enclose the vent pipe or place it closer than 6 inches (152 mm) to combustible material.

Condensation Mitigation

- On units with long vent runs—over 50% of maximum vent length allowed—or installed in low ambient conditions (below 50°F), it is recommended that vent pipes be fitted at the low point of the vent system with a tee, a drip leg, and a cleanout cap to prevent any moisture in the vent pipe from entering the unit. The drip leg should be inspected and cleaned out periodically during the heating season.
- Any length of single-wall vent pipe exposed to cold air or run through an unheated area or an area with an ambient temperature of 50°F or less, must be insulated along its entire length with a minimum of 1/2-inch foil-faced fiberglass, 1-1/2# density insulation.
- On horizontal vent runs, the flue pipe must be pitched down toward the terminal end—1/4-inch per foot for condensate drainage—for the entire length of the horizontal vent run.

⚠ CAUTION ⚠

- **Failure to pitch the vent run properly may damage the heater due to condensate running back into the unit.**
 - **Exceeding vent pipe diameter and length requirements may result in condensate forming in the vent pipe.**
-

INSTALLATION

⚠ CAUTION ⚠

Do NOT make actual connections until after reading the instructions and length requirements for installing the vent/combustion air kit (refer to [Vent Terminal Options](#) section).

Concentric Adapter Box Connections

NOTES:

- **All UBX and UDZ installations require a concentric adapter box designed to allow both combustion air and venting with only one building penetration.**
 - **The concentric adapter box is included in the vent/combustion air terminal kit. Components and instructions depend on whether the vent terminal is horizontal (option CC6) or vertical (option CC2).**
 - **Horizontal and vertical kits do not use the same adapter box. The only difference is the diameter of the opening in the box for the vent pipe. On commercial/industrial installations, a vertical vent requires double-wall pipe and a slightly larger opening through the box.**
-

- [Figure 2](#) shows a typical concentric adapter box and its airflow.
- See [Figure 3](#) for concentric adapter box dimensions.
- When pipe diameters differ, depending on the direction of airflow, join the pipes with either a taper-type reducer or increaser. Requirements vary depending on the unit size. The connection requirements are the same for both vertical and horizontal systems, but the length of pipe required varies by installation.
- [Figure 4](#) shows concentric adapter box connections.
- [Table 4](#) lists vent pipe opening diameters shown in [Figure 3](#).
- [Table 5](#) lists connection dimensions shown in [Figure 4](#), DETAIL B.
- Unit sizes 300, 350, and 400 shown in [Figure 4](#), DETAIL C always require a 6- to 5-inch (152- to 127-mm) taper-type reducer in the vent pipe.

INSTALLATION—CONTINUED

Concentric Adapter Box Connections—Continued

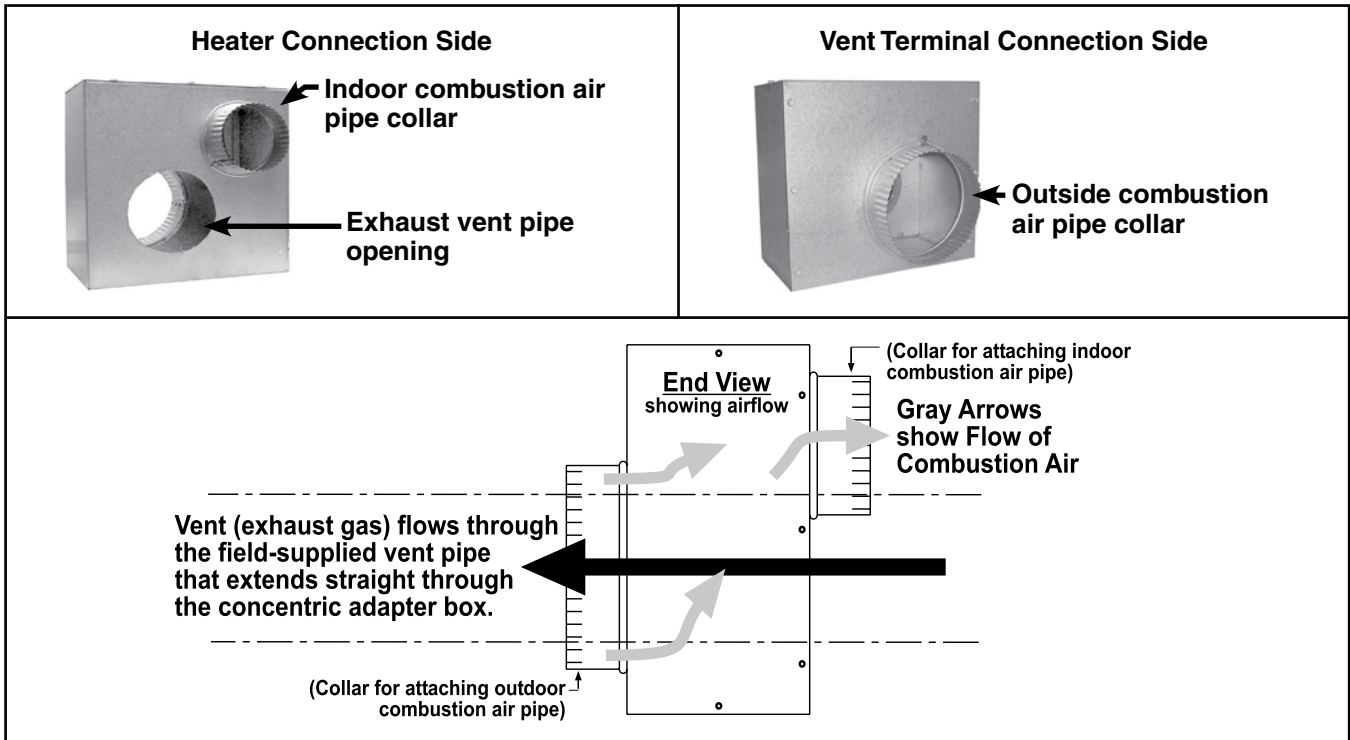

Figure 2. Concentric Adapter Box

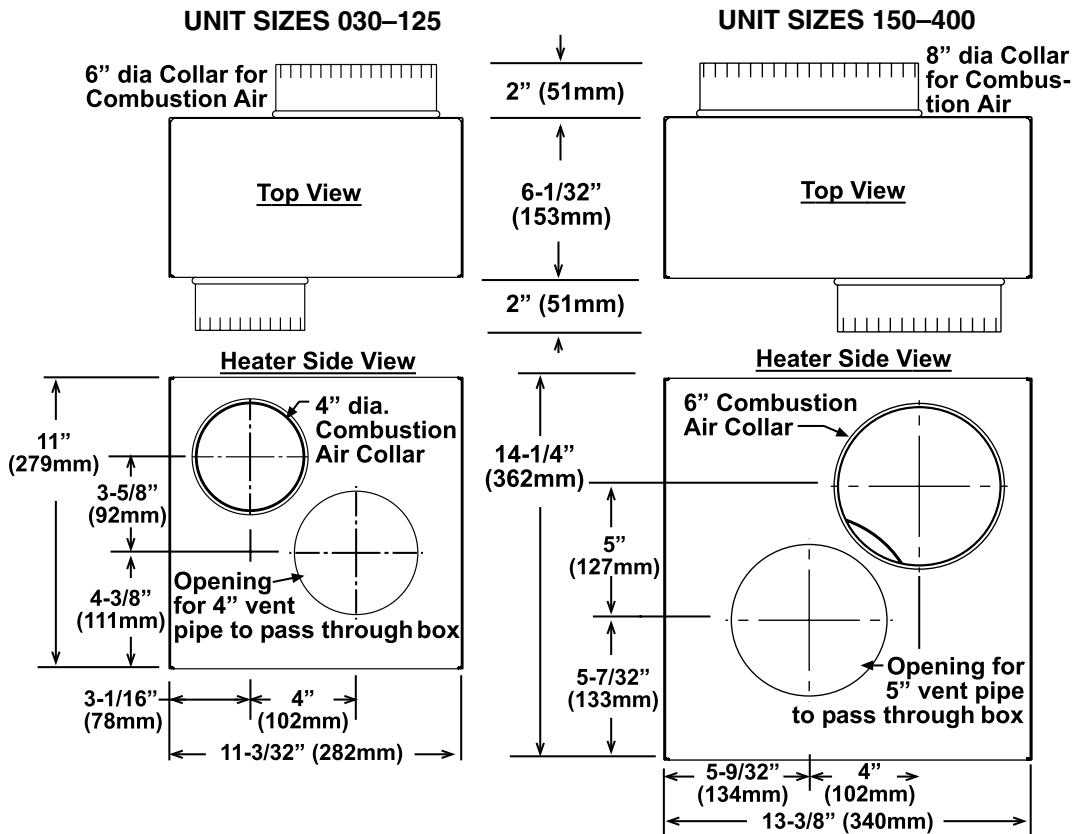

Figure 3. Concentric Adapter Box Dimensions (Refer to [Table 4](#))

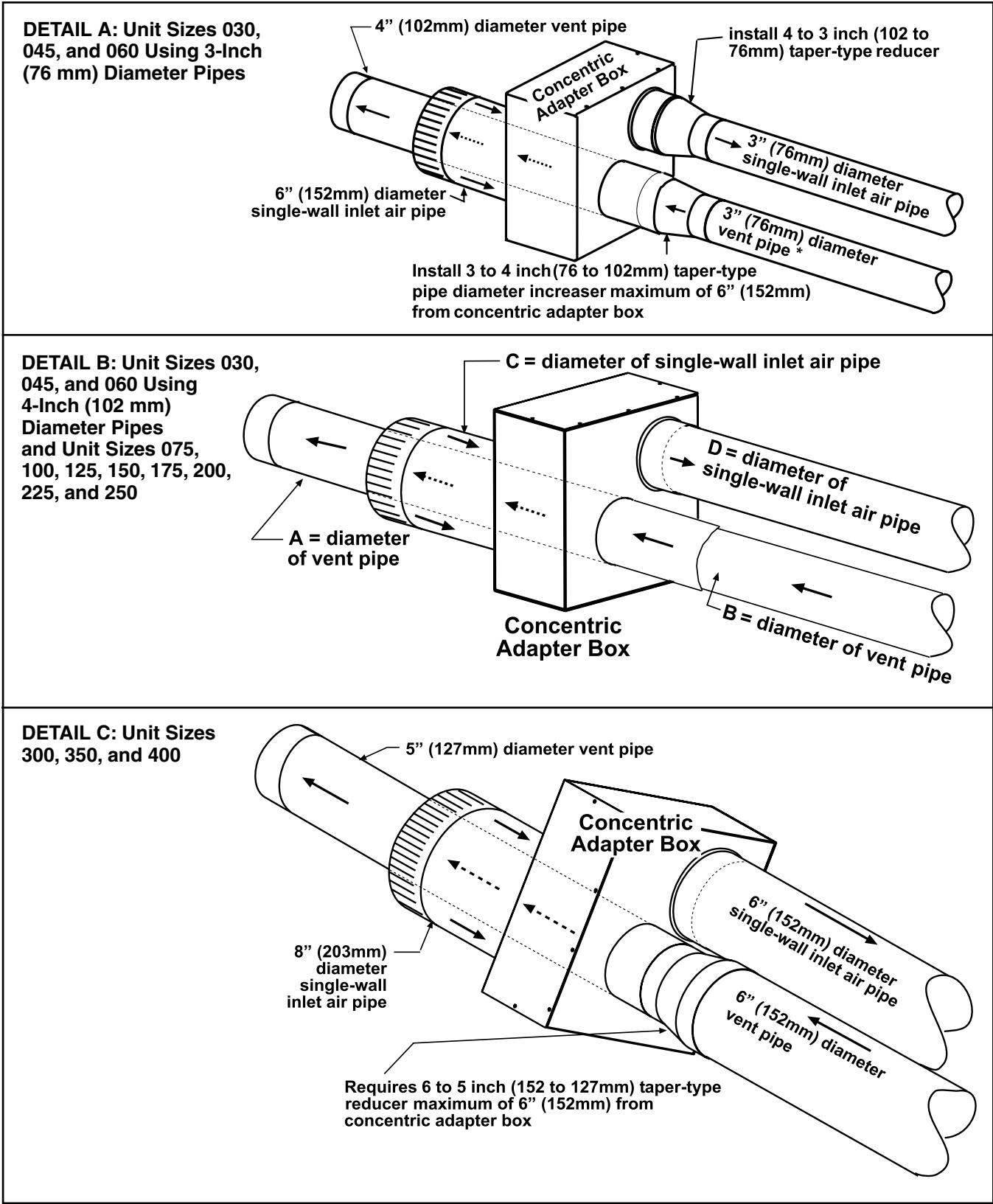

Figure 4. Concentric Adapter Box Connections (Refer to [Table 4](#))

INSTALLATION—CONTINUED

Concentric Adapter Box Connections—Continued

Table 4. Vent Pipe Opening Diameter			
Vent Terminal Configuration	Option	Unit Size	
		030–125 (5-Inch Vent Pipe)*	150–400 (5-Inch Vent Pipe)*
Diameter (Feet (Meters))			
Vertical	CC2	4-21/32 (118)	5-21/32 (144)
Horizontal	CC6	4-1/16 (103)	5-1/16 (129)

*See [Figure 3](#).

Table 5. Concentric Adapter Box Vent Pipe Sizes				
Unit Size	Dimension*			
	A	B	C	D
	Diameter (Inches (mm))			
030, 045, 060**	4 (102)	6 (152)	4 (102)	4 (102)
075, 100, 125	4 (102)	6 (152)	4 (102)	4 (102)
150, 175, 200, 225, 250	5 (127)	8 (203)	6 (152)	6 (152)

*See [Figure 4](#).

**Using 4-inch vent pipe for combustion air runs from heater to concentric adapter box.

Vent Terminal Options

Vent terminal options CC2 (vertical vent configuration) and CC6 (horizontal vent configuration) are shown in [Figure 5](#). Both options are applicable to residential and commercial/industrial installations

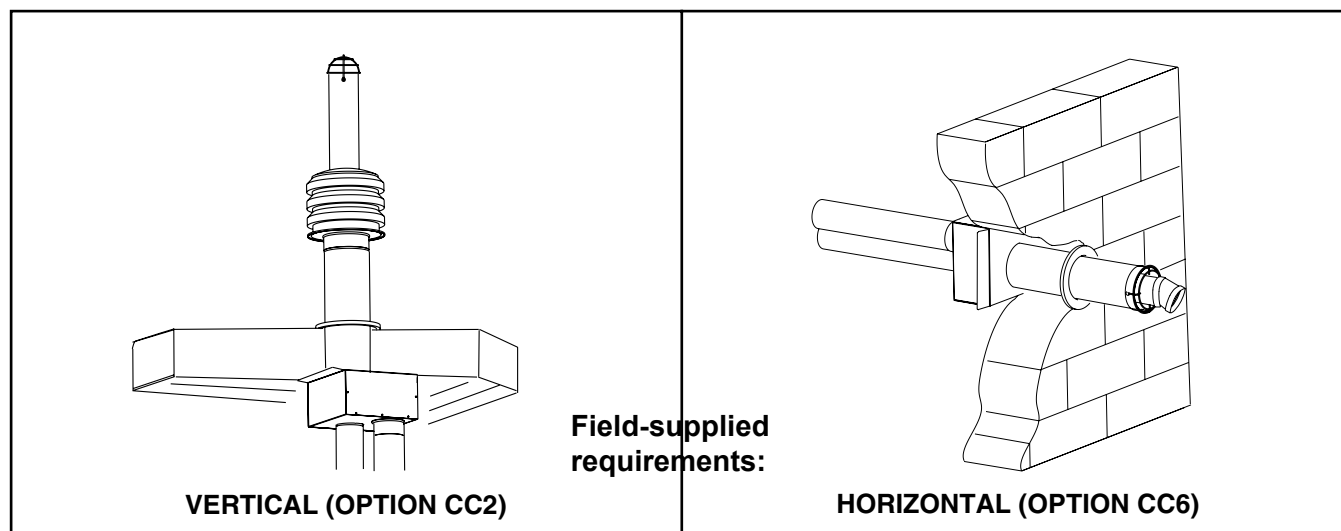

Figure 5. Vent Terminal Options

Vertical Vent Terminal (Option CC2) Installation

- Field-supplied components required for installation of the vertical vent kit are as follows:
 - Vent and combustion air piping in accordance with [Table 3](#)
 - Tapered vent pipe diameter reducers and/or increasers, as required
 - Thimble (not required if wall is of non-combustible construction)
 - Flashing
 - Sheet metal screws, tape, and sealant, as required
- Factory-supplied components for installation of the vertical vent kit are listed in [Table 6](#) and shown in [Figure 6](#).

Table 6. Vertical Vent Terminal/Combustion Air Package (Option CC2) Components			
Unit Size		Description	Qty
030–125	150–400		
PN			
205895	205896	Kit package	1
205884	205885	Concentric adapter box (see Figure 2 , Figure 3 , and Figure 4)	1
110051	110052	Exhaust vent terminal assembly (see Figure 6)	1
155635	53330	Combustion air inlet assembly (see Figure 6)	1
207232		Concentric adapter box bracket	2
53335		High-temperature silicone sealant, tube	1

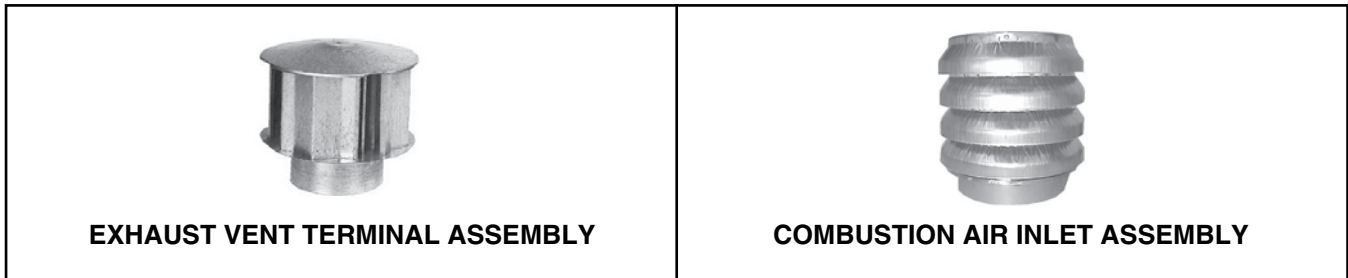

Figure 6. Option CC2 Components

Install the vertical vent kit as follows:

⚠ DANGER ⚠

To prevent combustion products from entering the occupied space, all vent terminals must be positioned or located away from fresh air intakes, doors, and windows. Failure to comply could result in severe personal injury or death and/or property damage.

1. Determine vent terminal location on outside wall:

- a. If more than one vertical vent terminal is being installed, minimum spacing between vent center lines is determined by minimum outdoor design temperature (coldest outdoor condition at installation site). Refer to [Table 7](#) to ensure that location complies with minimum outdoor design temperature requirements.

Table 7. Minimum Spacing Between Center Lines of Vertical Vent Pipes	
Minimum Outdoor Design Temperature	Minimum Spacing Between Center Lines of Vertical Vent Pipes (Inches (mm))
≥31°F (≥0°C)	36 (914)
-10 to 30°F (-23 to -1°C)	60 (1524)
< -10°F (< -23°C)	84 (2134)

- b. Select location away from fresh air intakes, allowing space for concentric adapter box inside. Vent terminal must be located away from adjacent buildings as shown in [Figure 7](#).

INSTALLATION—CONTINUED

Vent Terminal Options—Continued

Vertical Vent Terminal (Option CC2) Installation—Continued

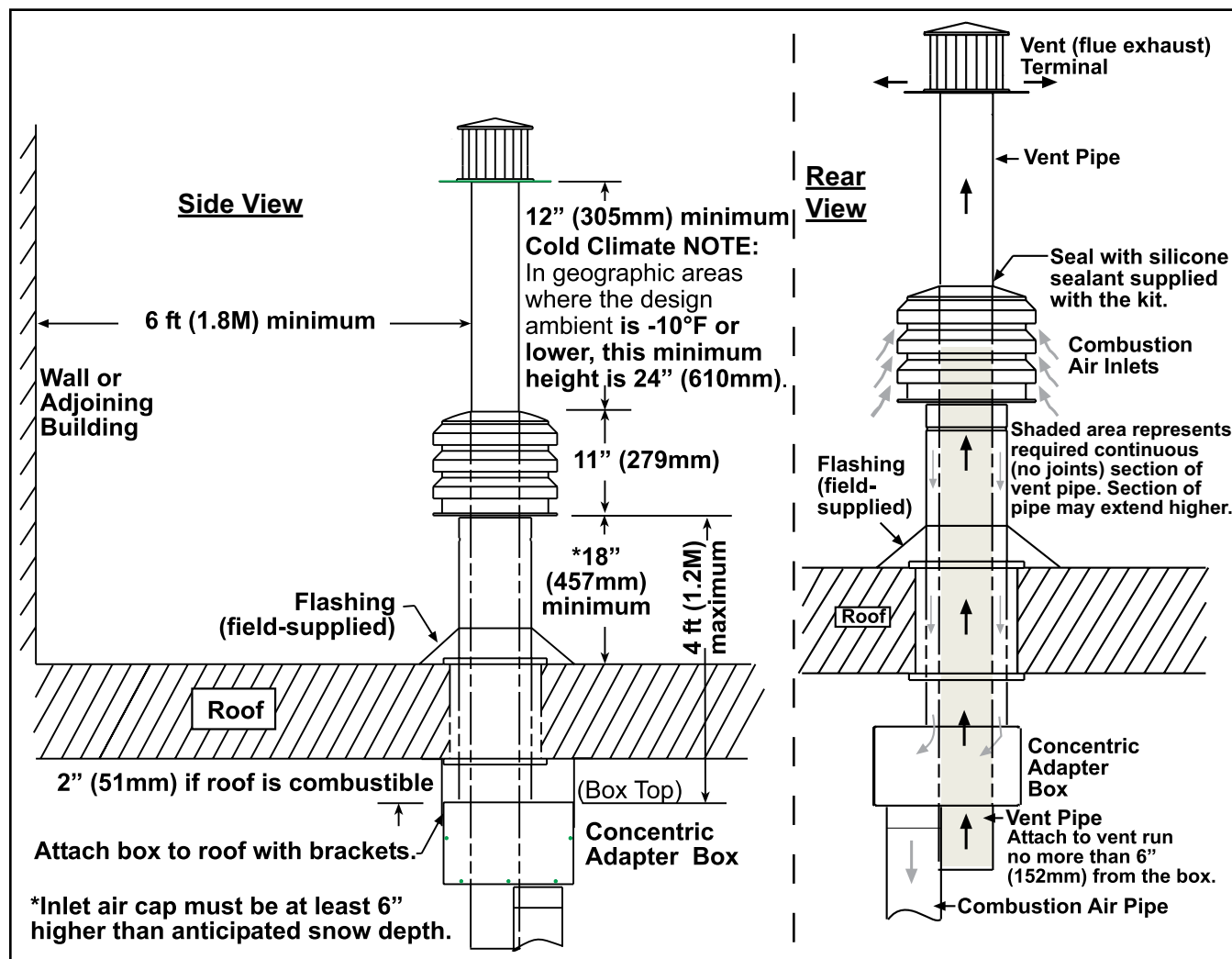

Figure 7. Option CC2 Installation

2. Install vent pipe and combustion air pipe runs:

- Connect piping to heater in accordance with specifications listed in [Venting and Combustion Air Requirements](#) section and subsections.
- Seal all joints in accordance with specifications listed in [Joint Connection and Sealing Requirements](#) section. Due to high temperature considerations, do not enclose exhaust pipe or place pipe closer than 6 inches (152 mm) to combustible material.
- Extend piping runs close to roof at location selected in step 1 and support piping in accordance with specifications listed in [Vent System Support Requirements](#) section.

NOTE: The vent pipe will extend through the roof after the concentric adapter box is installed. The indoor combustion air pipe will end at the box.

3. Cut hole through outside wall for combustion air pipe.

- Ensure that location and orientation of concentric adapter box are correct and mark and cut hole.
- Ensure that hole accommodates 6-inch (152 mm) combustion air pipe for unit sizes 030–125 or 8-inch (203-mm) combustion air pipe for unit sizes 150–400. Thimble may or may not be required depending on building construction and/or local codes. Larger diameter combustion air pipe serves as clearance for vent pipe on non-combustible construction.

4. Secure longer angles on concentric adapter box brackets (see [Figure 8](#)) to concentric adapter box.

NOTE: The longer angle of the concentric adapter box bracket has five 7/32-inch holes that allow the position of the bracket on the box to be adjusted.

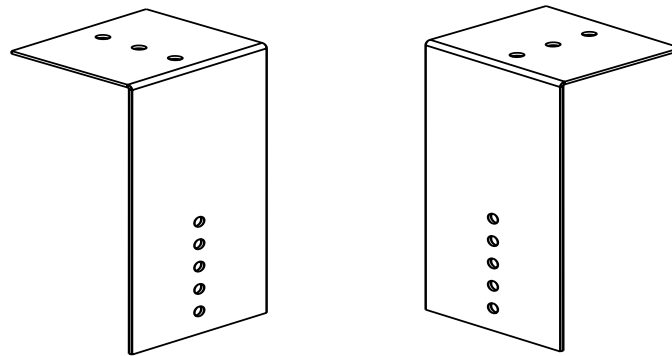

Figure 8. Concentric Adapter Box Brackets

5. Connect outside section of combustion air pipe to concentric adapter box (see [Figure 9](#)):

- a. Determine length of combustion air pipe so that dimension X in [Figure 9](#) is equal to bracket length, plus roof thickness, plus anticipated snow depth. Ensure that length of combustion air pipe does not exceed 48 inches (1,219 mm) or does not extend *less than* 18 inches (457 mm) above roof.
- b. Secure inlet air pipe to collar of concentric adapter box using sheet metal screws. Seal joint and seam using tape or sealant.

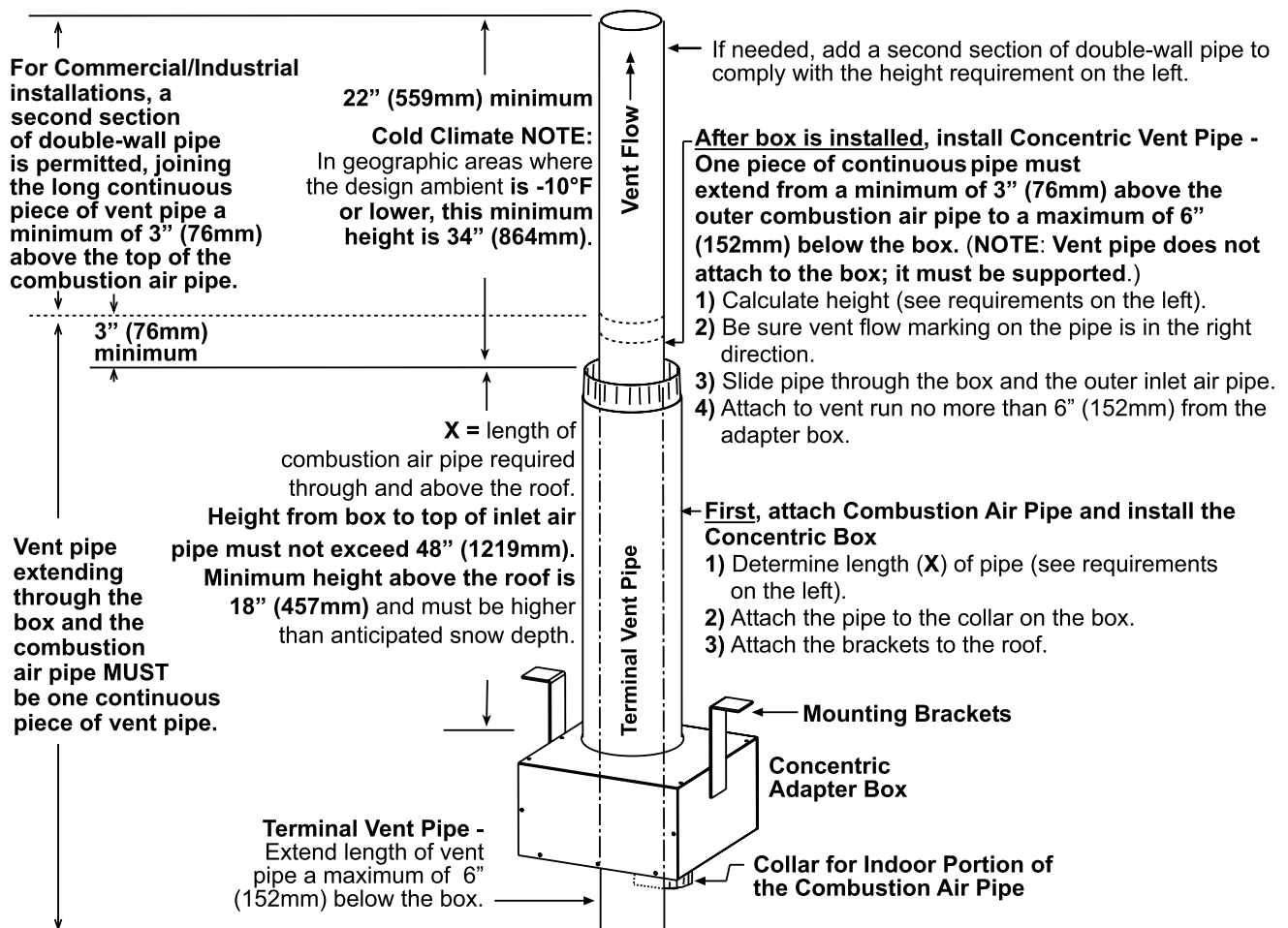

Figure 9. Combustion Air Pipe Installation

INSTALLATION—CONTINUED

Vent Terminal Options—Continued

Vertical Vent Terminal (Option CC2) Installation—Continued

6. Secure concentric adapter box to underside of roof (see [Figure 9](#)):

⚠ CAUTION ⚠

- If the roof is combustible, ensure that brackets are positioned to allow a 2-inch (51 mm) clearance between the concentric adapter box and the roof.
 - If any holes are made in the concentric adapter box in error, ensure that they are sealed.
-

- a. Insert combustion air pipe through roof as shown in [Figure 10](#).
- b. Position concentric adapter box to match pipe runs and secure short angles of concentric adapter brackets (see [Figure 8](#)) to underside of roof using field-supplied hardware.

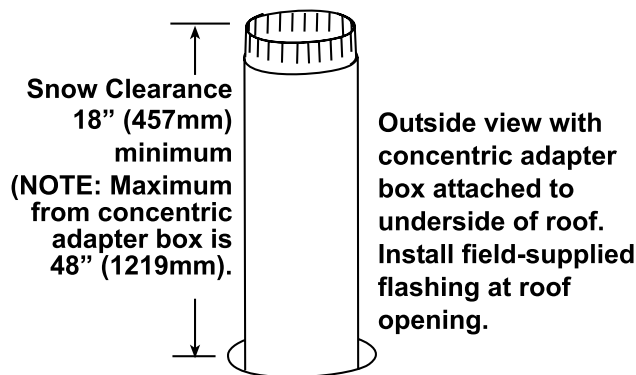

- c. Install field-supplied flashing around combustion air pipe on roof outside.

Figure 10. Combustion Air Pipe Through Roof

7. Install terminal-end vent pipe:

NOTE: The length of the terminal-end vent pipe is determined by the installation within maximum and minimum requirements. The vent pipe extending through the concentric adapter box, through the combustion air inlet pipe, and above the combustion air inlet air pipe must be one piece without joints. If the actual piece of vent pipe is longer, extend it further above the combustion air pipe. Do not extend it more than 6 inches (152 mm) below the box.

- a. Refer to [Figure 9](#) to determine required length of continuous section of vent pipe. Determine length as follows: **1)** start with no more than 6 inches (152 mm) below concentric adapter box, **2)** plus 6 inches (152 mm) through box, **3)** plus length of bracket extending above box, **4)** plus width of roof, **5)** plus height of combustion air pipe above roof, **6)** plus minimum of 3 inches (76 mm) beyond top of combustion air pipe—total is minimum length of vent pipe section.
 - b. Ensure that vent pipe is in proper flow direction and slide end of pipe into box and out through combustion air pipe. Position vent pipe to lengths determined above.
-

NOTE: The terminal-end vent pipe does not attach to the box. The installer must provide support.

- c. For commercial/industrial installations, connect double-wall pipe to single-wall pipe or taper-type connector in accordance with [APPENDIX](#).
- d. Seal completely around circumference of pipe and opening of box using silicone sealant.

8. Install combustion air inlet (see Figure 11):

- Install additional section of vent pipe if needed on outside and make joint in accordance with pipe manufacturer's requirements.
- When vent pipe is required height, slide combustion air inlet over vent pipe and fasten collar to combustion air pipe using sheet metal screws.
- Seal opening at top between vent pipe and combustion air inlet to prevent water leakage using silicone sealant.

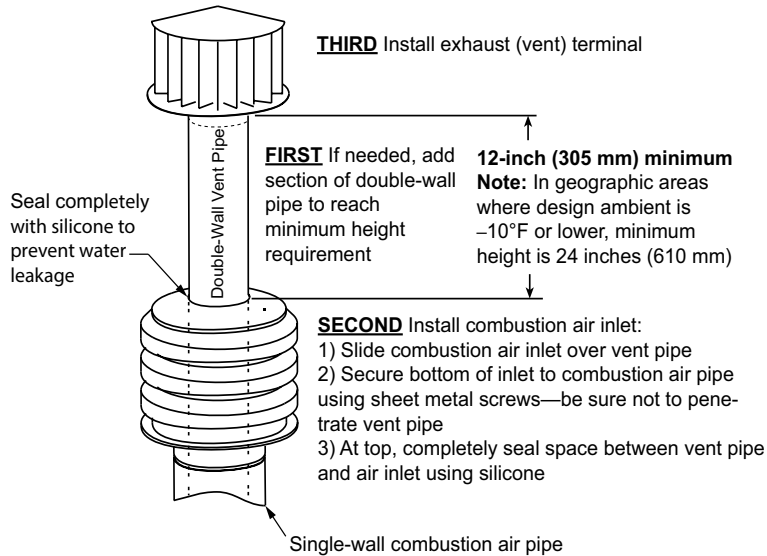

Figure 11. Combustion Air Inlet and Vent Terminal

9. Install exhaust (vent) cap in accordance with APPENDIX.

10. Install indoor combustion air pipe:

- Secure single-wall combustion air pipe run to collar on concentric adapter box using field-supplied sheet metal screws.
- Seal pipe joint using tape or sealant.

11. Verify compliance with Figure 7 and with all specifications listed in Venting and Combustion Air Requirements section and subsections.

Horizontal Vent Terminal (Option CC6) Installation

- Field-supplied components required for installation of the horizontal vent kit are as follows:
 - Vent and combustion air piping in accordance with Table 3
 - Tapered vent pipe diameter reducers and/or increasers, as required
 - Thimble (not required if wall is of non-combustible construction)
 - Flashing
 - Sheet metal screws, tape, and sealant, as required
- Factory-supplied components for installation of the horizontal vent kit are listed in Table 8 and shown in Figure 12.

Table 8. Horizontal Vent Terminal/Combustion Air Package (Option CC6) Components			
Unit Size		Description	Qty
030–125	150–400		
PN			
211762	211763	Kit package	1
211789	211790	Concentric adapter box (see Figure 2, Figure 3, and Figure 4)	1
211791	211792	Exhaust grill (see Figure 12)	1
151755	124940	Inlet guard (see Figure 12)	1
207232		Concentric adapter box bracket	2
37661		Screw, sheet metal, #10-16 × 1/2	8
53335		High-temperature silicone sealant, tube	1

INSTALLATION—CONTINUED

Vent Terminal Options—Continued

Horizontal Vent Terminal (Option CC6) Installation—Continued

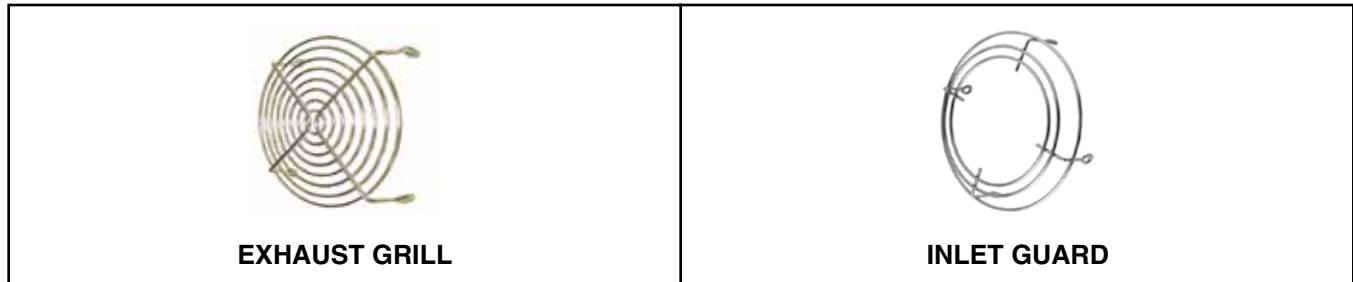

Figure 12. Option CC6 Components

Install the horizontal vent kit as follows:

⚠ DANGER ⚠

- To prevent combustion products from entering the occupied space, all vent terminals must be positioned or located away from fresh air intakes, doors, and windows. Failure to comply could result in severe personal injury or death and/or property damage.
- In climates with below freezing temperatures, condensate may form icicles on the vent terminal. Locate the terminal where falling icicles do not present a hazard.

1. Determine vent/combustion air terminal location on outside wall:

- a. Refer to [Pipe Size Requirements](#) section to ensure that location complies with vent length requirements.
- b. For most applications, ensure that vent terminal is level with heater mounting height.
- c. Allow downward pitch of 1/4-inch per foot (6 mm per 305 mm) for condensate drain.

NOTE: Local codes supersede all provisions in these instructions and in National Fuel Gas Code Z223.1.

- d. Ensure that distance of vent terminal from adjacent public walkways and buildings and window and building openings complies with local codes. Absent any local codes, distance must comply with National Fuel Gas Code Z223.1.

⚠ DANGER ⚠

Consider local snow depth conditions. The vent must be at least 6 inches (152 mm) above the anticipated snow depth.

⚠ WARNING ⚠

Avoid positioning the vent terminal above a walkway as there may be a small amount of condensate that drips from the end of the vent/combustion air terminal. In cold climates, the condensate may form icicles.

⚠ CAUTION ⚠

Products of combustion can cause discoloration of some building finishes and deterioration of masonry materials. A clear silicone sealant normally used to protect concrete driveways may be used to protect masonry materials from discoloration and deterioration. If discoloration is an esthetic problem relocate the vent or install a vertical vent.

e. Refer to [Table 9](#) to ensure that location complies with minimum clearance requirements.

Table 9. Minimum Clearance Requirements for Horizontal Vent Termination Location	
Component/Structure	Minimum Clearance, All Directions Unless Specified (Feet (Meters))
Forced air inlet within 10 feet (3.1 meters)*	3 (0.9) above
Combustion air inlet of another appliance	6 (1.8)
Mechanical air supply inlet to any building	Canada: 6 (1.8)
Any building opening (door, window, or gravity air inlet)	4 (1.2) horizontal and below
	1 (0.3) above
Gas meter,** electric meter, and relief equipment	US: 4 (1.2) horizontal
	Canada: 6 (1.8) horizontal
Gas regulator**	US: 3 (0.9) horizontal
	Canada: 6 (1.8) horizontal
Adjoining building or parapet	6 (1.8)
Adjacent public walkway	7 (2.1) above
Grade (ground level)	3 (0.9) above
*Does not apply to the inlet of a direct vent appliance.	
**Do not terminate the vent directly above a gas meter or service regulator.	

2. Install vent pipe and combustion air pipe runs:

- a. Connect piping to heater in accordance with specifications listed in [Venting and Combustion Air Requirements](#) section and subsections.
- b. Seal all joints in accordance with specifications listed in [Venting and Combustion Air Requirements](#) section and subsections. Due to high temperature considerations, do not enclose exhaust pipe or place pipe closer than 6 inches (152 mm) to combustible material.
- c. Extend piping runs close to wall at location selected in step 1 and support piping in accordance with specifications listed in [Venting and Combustion Air Requirements](#) section and subsections.

3. Cut hole through outside wall for combustion air pipe.

- a. Ensure that outside wall construction thickness is between 1 inch (25 mm) minimum and 48 inches (1,219 mm) maximum.
- b. Ensure that hole accommodates 6-inch (152 mm) combustion air pipe for unit sizes 030–125 or 8-inch (203-mm) combustion air pipe for unit sizes 150–400. Thimble may or may not be required depending on building construction and/or local codes. Larger diameter combustion air pipe serves as clearance for vent pipe on non-combustible construction.

4. Secure longer angles on concentric adapter box brackets (see [Figure 8](#)) to concentric adapter box.

NOTE: The longer angle of the concentric adapter box bracket has five 7/32-inch holes that allow the position of the bracket on the box to be adjusted.

5. Connect outside section of combustion air pipe to concentric adapter box (see [Figure 9](#)):

- a. Determine length of combustion air pipe by measuring **1**) bracket length from box to wall, **2**) wall thickness, **3**) plus 4–16 inches (102–406 mm) beyond wall.
- b. Secure inlet air pipe to collar of concentric adapter box using sheet metal screws. Seal joint and seam using tape or sealant.

6. Secure concentric adapter box to wall (see [Figure 13](#)):

- a. Insert combustion air pipe out through wall.
- b. Secure short angles of concentric adapter box brackets (see [Figure 8](#)) to wall.
- c. Seal or flash inlet air pipe on outside using sealant and/or field-supplied flashing.

INSTALLATION—CONTINUED

Vent Terminal Options—Continued

Horizontal Vent Terminal (Option CC6) Installation—Continued

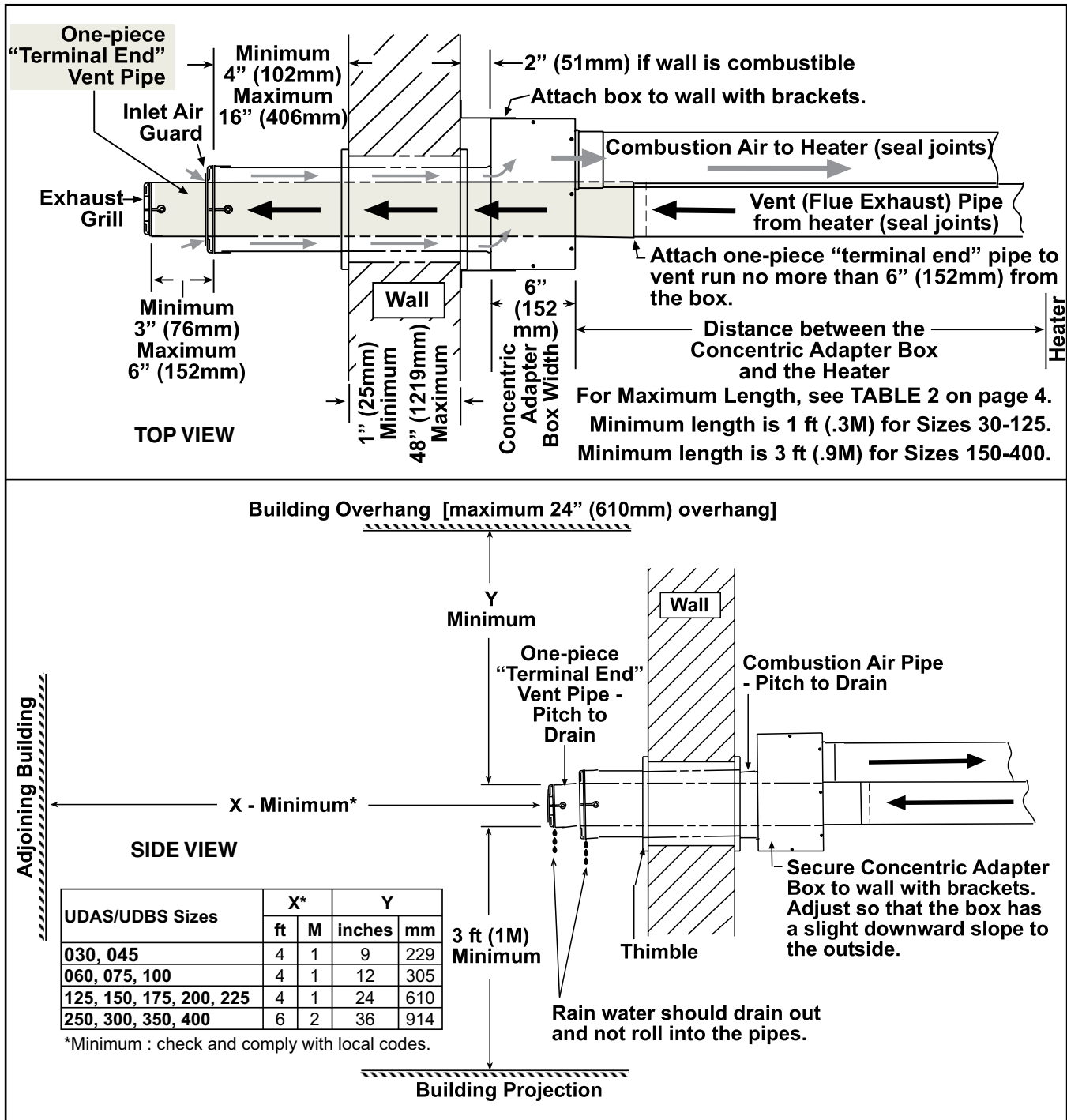

Figure 13. Option CC6 Installation

7. Install inlet guard:

- a. Position inlet guard over end of combustion air pipe in accordance with [Figure 13](#).
- b. Secure inlet guard to inlet air pipe using four 1/2-inch-long screws provided.

8. Install terminal-end vent pipe:

NOTE: The length of the terminal-end vent pipe is determined by the installation within maximum and minimum requirements. The vent pipe extending through the concentric adapter box, through the combustion air inlet pipe, and above the combustion air inlet air pipe must be one piece without joints. The connection to the vent pipe run must be a maximum of 6 inches (152 mm) from the heater side of the box.

- a. Refer to [Figure 13](#) to determine lengths of each pipe segment and to calculate total length required.
- b. Ensure that terminal-end vent pipe is in proper flow direction and slide end of pipe through box.
- c. Position vent pipe so that it extends 3–6 inches (76–152 mm) past end of combustion air pipe and no more than 6 inches (152 mm) out of box toward heater.
- d. Connect terminal-end vent pipe to vent pipe run no more than 6 inches (152 mm) from heater.

9. Install exhaust grill:

- a. Position exhaust grill over end of vent pipe in accordance with [Figure 13](#).
- b. Secure exhaust grill to end of vent pipe using four 1/2-inch-long screws provided.
- c. Seal vent pipe to concentric adapter box.
- d. Verify that terminal-end section of vent pipe has slight downward pitch of 1/4-inch (6-mm) per foot (305 mm) toward outside.
- e. Seal completely around circumference of pipe and opening of box using silicone sealant.



10. Install indoor section of combustion air pipe:

- a. Secure single-wall combustion air pipe run to collar on concentric adapter box using sheet metal screws.
- b. Seal pipe joint using tape or sealant.

11. Verify compliance with [Figure 13](#) and with all specifications listed in [Venting and Combustion Air Requirements](#) section and subsections.

APPENDIX: INSTRUCTIONS FOR ATTACHING DOUBLE-WALL TYPE B VENT PIPE TO SINGLE-WALL PIPE

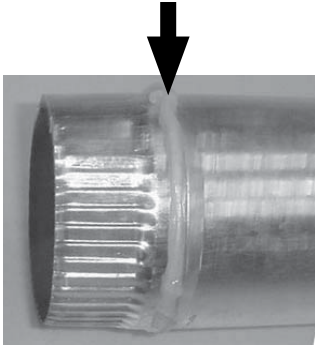
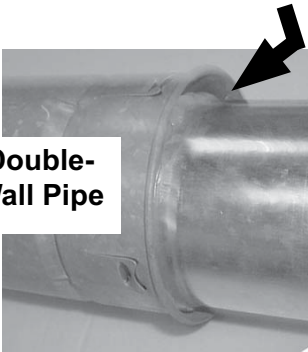
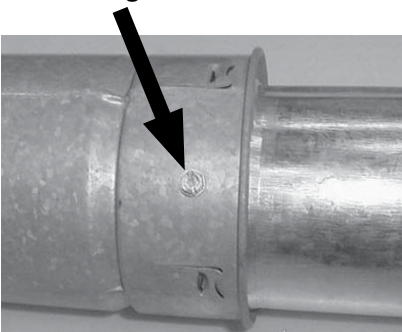
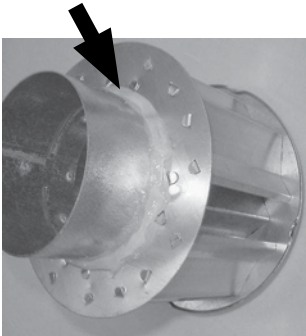
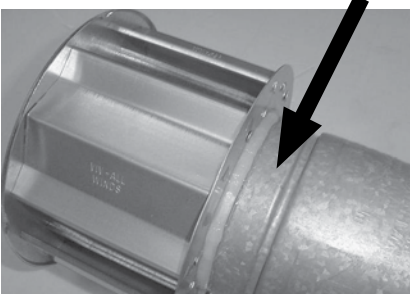
NOTE: Work quickly to assemble components before sealant dries.

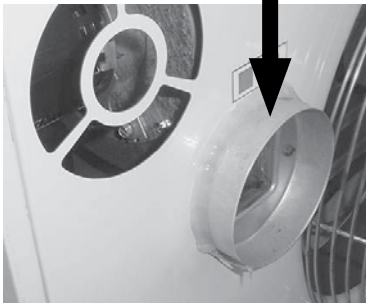
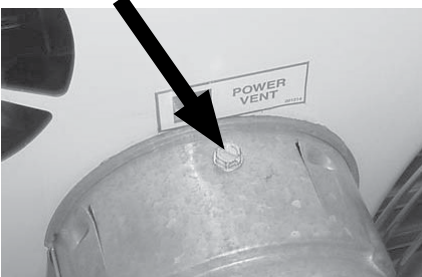
<p>STEP 1: Place continual 1/4-inch bead of silicone sealant around circumference of single-wall pipe.</p> 	<p>STEP 2: Before sealant can dry, insert single-wall pipe into inner pipe of double-wall pipe until bead of sealant contacts inner pipe to create sealed joint.</p> 	<p>STEP 3: Drill three small holes spaced equally around double-wall pipe below sealant ring. Secure joint using 3/4-inch-long sheet metal screws. Do not overtighten screws.</p> 
<p>STEP 4: Place continual 3/8-inch bead of silicone sealant around the circumference of vent cap collar to prevent any water inside vent cap from running down double-wall pipe.</p> 	<p>STEP 5: Before sealant can dry, insert collar on vent cap as far as possible inside inner wall of double-wall pipe. Apply silicone sealant to fully close any gaps between vent cap and double-wall pipe to prevent water from entering double-wall pipe.</p> 	<p>STEP 6: Drill small hole through vent cap and double-wall pipe. Secure joint using 3/4-inch-long sheet metal screw. Do not overtighten screw.</p> 
<p>STEP 7: Place continual 1/4-inch bead of silicone sealant around circumference of venter outlet collar.</p> 	<p>STEP 8: Before sealant can dry, slide double-wall pipe over collar so that collar is inside inner pipe. Push double-wall pipe tight to heater cabinet. Drill three small holes through the pipe and into collar spaced equally around pipe below sealant ring. Secure joint using 3/4-inch-long sheet metal screws. Do not overtighten screws.</p> 	

NOTES



Specifications and illustrations subject to change without notice or incurring obligations.
©2021 Nortek Global HVAC LLC, O'Fallon, MO.
All rights reserved.
CP-UBZ-UDZ-VENT (02-21) 1034632-0

