

E.5 Tower, K.5 Monitor, CR.5 Center Channel  
Owner's Manual

**E.5**  
**K.5**  
**CR.5**

**SNECI**

## SPECIFICATIONS

Specifications	E.5 Tower	K.5 Monitor	CR.5 Center Channel
Frequency Response ( $\pm 3$ dB)	32-20,000Hz	48-20,000Hz	70-20,000Hz
Recommended Amplifier Power	50-250 watts	50-200 watts	50-150 watts
Nominal Impedance	4 ohms	8 ohms	8 ohms
Sensitivity [1 watt (2.83v) at 1m]	90dB	86dB	89dB
Tweeter (video-shielded)	Front-firing: 1-inch (24mm) black-anodized aluminum dome  Rear-firing: 1-inch (24mm) soft dome	1-inch (24mm) black-anodized aluminum dome	1-inch (24mm) black-anodized aluminum dome
Bass Unit (video-shielded)	Dual 6 <sup>1</sup> / <sub>4</sub> -inch (165mm) bass units. Variably progressive spider and aluminum shorting cylinder permit high output without increased distortion. Copolymer cones and butyl rubber surrounds resist environmental extremes.	6 <sup>1</sup> / <sub>4</sub> -inch (165mm) bass unit. Variably progressive spider and aluminum shorting cylinder permit high output without increased distortion. Copolymer cone and butyl rubber surround resist environmental extremes.	Dual 5 <sup>1</sup> / <sub>4</sub> -inch (135mm) cast-aluminum baskets. Copolymer cone and butyl rubber surround resist environmental extremes.
Placement Switch Positions	Normal and Boundary	Normal and Boundary	Normal and Boundary
Cabinet Construction	<sup>3</sup> / <sub>4</sub> -inch MDF walls, I-beam internal bracing	<sup>3</sup> / <sub>4</sub> -inch MDF walls, I-beam internal bracing	<sup>3</sup> / <sub>4</sub> -inch MDF walls, I-beam internal bracing
Platform Baffle Construction	Exposed layer: <sup>3</sup> / <sub>4</sub> -inch high-density fiberboard  Damping layer: 1.5mm neoprene  Inner layer: <sup>3</sup> / <sub>4</sub> -inch medium-density fiberboard	Exposed layer: <sup>3</sup> / <sub>4</sub> -inch high-density fiberboard  Damping layer: 1.5mm neoprene  Inner layer: <sup>3</sup> / <sub>4</sub> -inch medium-density fiberboard	Exposed layer: <sup>3</sup> / <sub>4</sub> -inch high-density fiberboard  Damping layer: 1.5mm neoprene  Inner layer: <sup>3</sup> / <sub>4</sub> -inch medium-density fiberboard
Grille	Custom-perforated (51% open) cold-rolled steel, powder-coat finish	Custom-perforated (51% open) cold-rolled steel, powder-coat finish	Custom-perforated (51% open) cold-rolled steel, powder-coat finish
Dimensions (HxWxD)	42 <sup>3</sup> / <sub>4</sub> x 8 <sup>1</sup> / <sub>4</sub> x 11 <sup>1</sup> / <sub>4</sub> " 108 x 22 x 29cm	18 x 8 <sup>1</sup> / <sub>4</sub> x 12" 46 x 22 x 30cm	6 <sup>5</sup> / <sub>4</sub> x 17 x 9 <sup>9</sup> / <sub>16</sub> " 16 x 43 x 24cm
Weight/each	46 lbs (21kg)	26 lbs (11.4kg)	17 lbs (7.7kg)
Finish	Hand-sanded, hand-oiled European Beech veneer, or hand-painted Black on American Oak veneer	Hand-sanded, hand-oiled European Beech veneer, or hand-painted Black on American Oak veneer	Hand-sanded, hand-painted Black on American Oak veneer

## PRODUCT DESCRIPTIONS

---

### E.5 Tower

#### *Floorstanding system*

The E.5's slim cabinet design, Placement Switch, and video shielding provide unequaled positioning flexibility in your home. The driver complement in this tower includes a 1-inch (24mm) black-anodized aluminum dome front-firing tweeter, and 1-inch (24mm) soft-dome rear-firing tweeter for added ambiance. A pair of 6<sup>1</sup>/<sub>4</sub>-inch (165mm) bass units provides midrange and bass to 32Hz (-3dB).

### K.5 Monitor

#### *High-performance monitor for use in a cabinet or on stands*

The K.5 Monitor is sized to fit in virtually any audio/video cabinet. Its Placement Switch and smooth off-axis frequency response ensure a natural sonic presentation when placed on stands, brackets, or in a cabinet. This two-way monitor uses a 1-inch (24mm) black-anodized aluminum dome tweeter and a 6<sup>1</sup>/<sub>4</sub>-inch (165mm) bass unit. Both are video-shielded for placement near a TV.

### CR.5 Center Channel

#### *Full-range music- and movie-quality center channel*

The CR.5 Center Channel is tuned to match the tonal balance of the E.5 Tower and K.5 Monitor for seamless 5 channel music or movie reproduction. This 2<sup>1</sup>/<sub>4</sub>-way design uses a 1-inch (24mm) black-anodized aluminum dome tweeter and two 5<sup>1</sup>/<sub>4</sub>-inch (135mm) bass units. One unit concentrates on the midrange; the other supports deeper bass information to 70Hz – making the CR.5 suitable for Dolby® Digital soundtracks. Video shielding, a Placement Switch, and smooth off-axis frequency response allow placement above or below a TV or in a cabinet.

## SERIES FEATURES

---

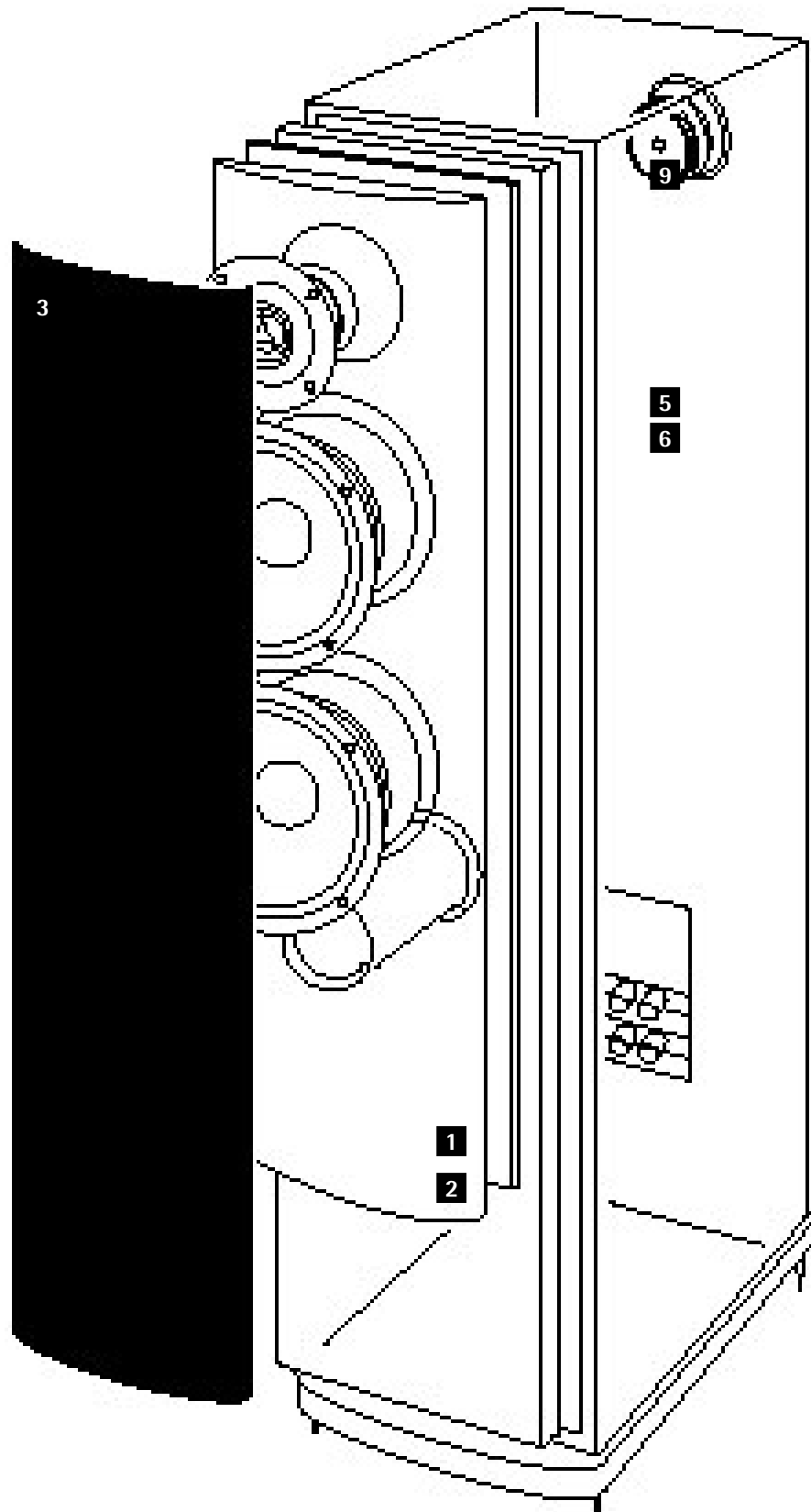

### 1 Platform Baffle

This three-layer sandwich isolates the baffle from the cabinet to decrease panel resonances and distortion especially in the critical midrange. The Platform Baffle consists of materials of varying density an extremely dense outer layer to which the tweeter and bass units are mounted, a "squishy" neoprene middle layer, and a medium-density inner layer which attaches to the cabinet.

### 2 Radiused-Edge Baffle

The elliptical radius on our baffle edge reduces re-radiation for a cleaner and smoother response especially off-axis. Snell pioneered this technique in the original Type A speaker system in 1976.

### 3 Grille Design

The custom-perforated metal grille has no frame to cause degrading reflections in the upper frequencies. Rubber mounts isolate the grille posts from the Platform Baffle.

### 4 Hand-Tuned Crossover

These networks adhere to an "in-phase" or Linkwitz Reilly design. (Time alignment and coherency are achieved through the transition region from driver to driver.) Each crossover is individually tuned by our technicians to within  $\pm 0.5\text{dB}$  of the Master Reference, assuring predictable performance in your home.

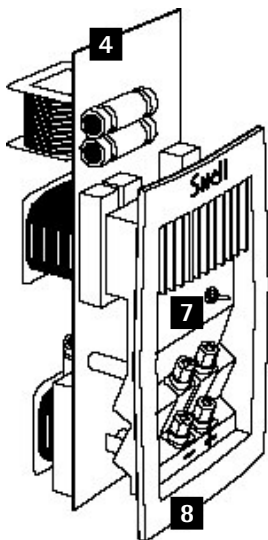

### 5 Handmade Cabinets

Our cabinet department hand assembles each unit, and then hand sands each several times. The result is a cabinet of exceptional workmanship, with sharp corners and smooth sides.

### 6 Veneers

We use premium, book-matched veneers in our oiled cabinets, chosen for grain consistency and aesthetics. A pair of speakers uses wood veneer from the same tree, so grain patterns are consistent. Our cabinet shop sequences the veneer, maintaining a match for the top, right/right, and left/left sides of each pair of speakers. We even go so far as to veneer the inside of the cabinet. This way, as the cabinet experiences changes in humidity in your home, it won't warp or come apart at the edges.

### 7 Placement Switch

This switch "normalizes" the speaker when it is placed in a cabinet or next to a large object, like a big-screen TV. This Snell feature assures predictable performance of your speaker in everyday settings.

### 8 Heat Sink/Terminal Plate

*Available on the E.5 Tower and K.5 Monitor*  
Heat-producing crossover components are mounted to a die-cast aluminum heat sink for stable, consistent performance at high power. This large heat sink also draws heat from inside the cabinet, keeping critical driver components cooler. The terminal plate has two sets of five-way gold-plated binding posts for bi-wiring or bi-amplifying.

### 9 Rear-Firing Tweeter

The rear-firing tweeter on the E.5 Tower adds necessary high-end "fill" to the soundstage, creating a broader, deeper stereo image when the speaker is placed away from a back wall. An on/off switch allows you to defeat the rear tweeter when the E.5 is placed up against a back wall.

# HOW TO PLACE YOUR SPEAKER SYSTEMS

## E.5 Tower

The E.5 Tower is designed for either freestanding or boundary placement.

*Freestanding placement* refers to a situation in which the E.5 Tower has at least a 12-inch (30cm) clearance on all four sides.

- fi *Away from large furniture*
- fi *Not close to walls*

*Boundary placement* refers to a situation in which the E.5 Tower is bounded on at least one side by a large object:

- fi *Placed beside a TV*
- fi *Placed beside a bookshelf or an audio/video cabinet*
- fi *Placed next to a wall*

### Setting the Carpet Spikes

Four steel spikes (#5/16-18 thread) are included with the E.5. Use them when placing the E.5 on the carpet to balance the speaker.

### 1 Setting the Placement Switch (far left switch)

*Freestanding placement:*

Set the Placement Switch to NORMAL.

*Boundary placement:*

Set the Placement Switch to BOUNDARY.

*Asymmetrical placement:*

Based on your room layout, you might find that one speaker performs best in the BOUNDARY setting, and the other in the NORMAL setting.

### 2 Setting the Treble Level (mid-switch)

The Treble Level Control contours the "brightness" of the E.5 Tower.

- fi *Turn the Treble Control to + to increase the high-frequency output in situations in which the E.5 sounds dull.*
- fi *Turn the Treble Control to - when the E.5 is overly bright especially in highly reflective rooms.*

### 3 Setting the Rear-Firing Tweeter (far right)

The rear-firing tweeter adds spaciousness and ambiance to the soundstage, and is particularly effective when the E.5 is placed at least 12 inches (30cm) from a back wall.

Turn the rear-firing tweeter OFF when:

- fi *The E.5 is placed directly against a back wall.*
- fi *The soundstage sounds too bright for your taste.*

Freestanding



Boundary

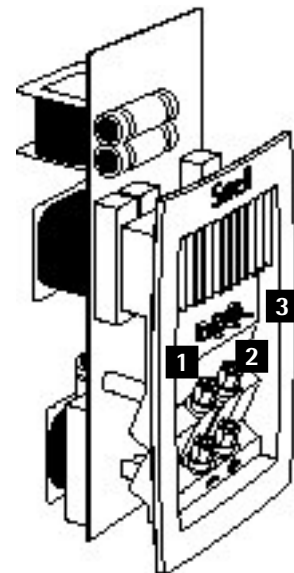
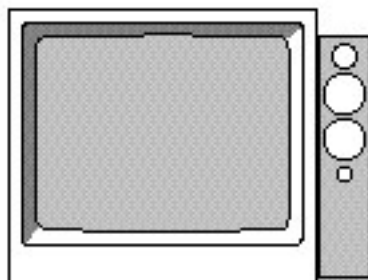

## K.5 Monitor

The K.5 Monitor is designed for either freestanding or cabinet placement.

*Freestanding placement* refers to a situation in which the K.5 Monitor has at least a 12-inch (30cm) clearance on three sides.

- fi On stands - away from any furniture
- fi On a wall bracket
- fi On an open bookshelf

*Cabinet placement* refers to a situation in which the K.5 Monitor is bounded on at least one side by a large object:

- fi In an audio/video cabinet
- fi On a crowded bookshelf
- fi On stands, but placed right next to a TV

### Setting the Placement Switch

*Freestanding placement:*

Set the Placement Switch to NORMAL.

*Cabinet placement:*

Set the Placement Switch to BOUNDARY.

*Asymmetrical placement:*

1. Based on your room layout, you might find that one speaker performs best in the BOUNDARY setting, and the other in the NORMAL setting.
2. You may place one K.5 Monitor horizontally and the other vertically without sound degradation.

## CR.5 Center Channel

The CR.5 is designed for either TV top or cabinet placement.

*TV top placement* refers to a situation in which the CR.5 is:

- fi On top of a 30-inch (76cm) or smaller TV, and the TV is freestanding in your room.

*Cabinet placement* refers to a situation in which the CR.5 is:

- fi On top of a TV larger than 30 inches (76cm)
- fi On top of a TV that is placed in an audio/video cabinet
- fi Below a TV, on a shelf

### Setting the Placement Switch

*TV top placement:*

Set the Placement Switch to NORMAL.

*Cabinet placement:*

Set the Placement Switch to BOUNDARY.

### Placement Guidelines

The center channel keeps musical or soundtrack information centered in the listening area. Therefore, its placement relative to the left and right speakers is critical.

Place the speaker on top of or beneath your TV with its front edge as forward as practical. Try to keep the front of the speaker flush with the front of the screen.

Place the CR.5 no higher or lower than 2 feet (60cm) of your left and right speakers. If you need to place the speaker any higher or lower, angle it toward ear level.

### Attaching the Felt Bumpers

Four (4) felt bumpers are included with the CR.5. Stick them to the bottom of the speaker cabinet to protect the finish on your TV.

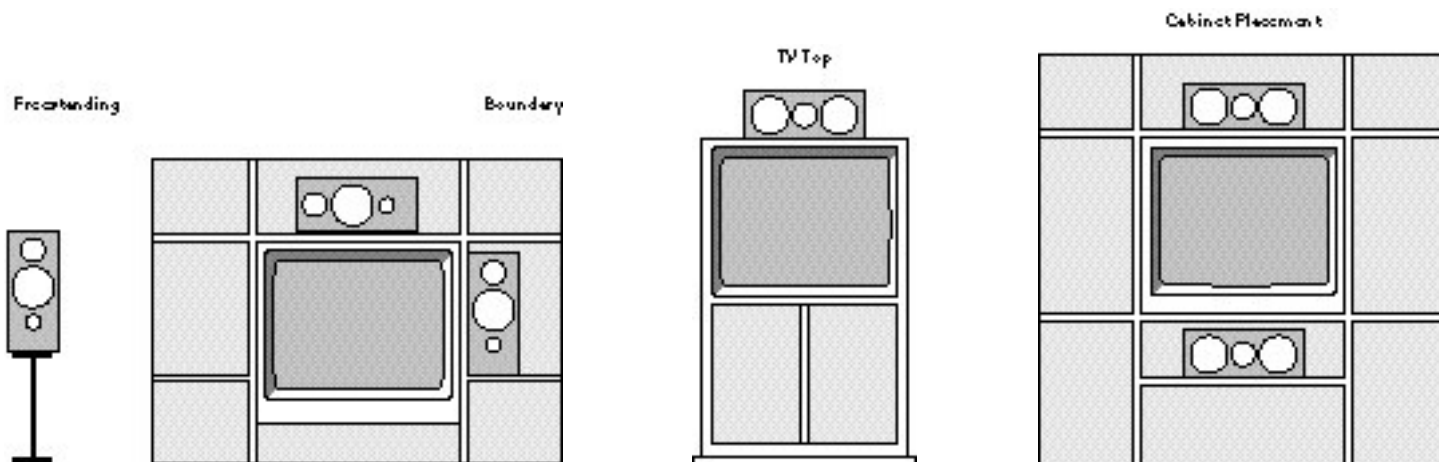

# HOW TO PLACE YOUR SPEAKER SYSTEMS

## General Guidelines

### Stand Placement

Stand height is not critical, but keep in mind that shorter stands will place the bass units closer to a boundary and will tend to increase bass response.

For best results:

- fi *Aim the center of the speaker to your ear level while listening in a seated position.*

### Bass Levels

- fi *Moving speakers nearer to a wall increases bass level.*
- fi *Moving speakers toward a corner will increase bass level even more.*
- fi *Bass is often smoother (yet thinner) with speakers placed well out from the wall, approximately 3 to 5 feet (1 to 1.5m).*
- fi *Bass response is often smoother if you keep the distance from the back wall and the distance from the side wall distinctly different.*

Experiment until you find the best overall sound for your room. Choose a source with a heavy and continuous bass line, repeat a short section until you have a firm impression of it in your mind and then try another speaker location. Repeat this process until you are content with the bass response you are getting. Moving your listening position may affect the sound as much as moving the speakers. Try different listener locations as well as speaker locations.

### Stereo Image

The distance between the speakers determines the width of the stereo image. If the speakers are placed too close together, the image will be too narrow; too far apart and the blend will suffer, creating a hole in the middle. When properly placed, your speakers will create a continuum of "Virtual Images" from left to right, with an illusion of sound outside, in front, and behind the speaker systems.

- fi *We recommend an angular separation between 45° and 60° (when viewed from above).*

This is equivalent to a separation between the speaker systems that is about 85% of the distance to either of the speakers.

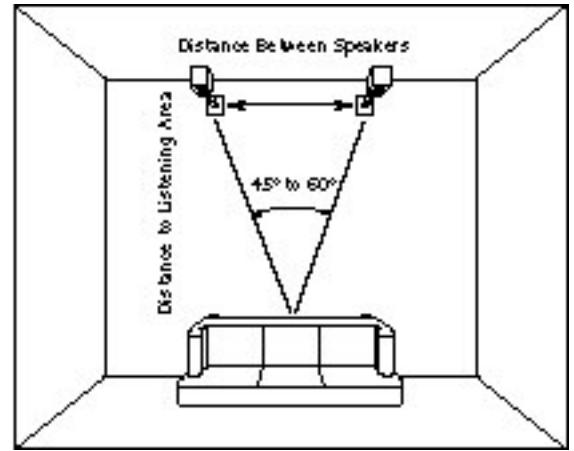

Creation of sounds between the speakers requires some precise measurements. The distance from the left speaker to the listener location should equal the distance from the right speaker to the listener location. We advise using a tape measure to equalize these two distances to the primary listening position. The payoff will be well worth the time and effort.

### Toe In

Toe in refers to the angling of the speaker systems toward the listening location. Toe in is a matter of taste. As the degree of toe in increases, the stereo effect becomes more direct-sounding, like a pair of headphones.

Toeing in should be the last step in the placement of your speaker systems. After finalizing speaker position and listening location, place the speaker's back parallel to the back wall or cabinet. Experiment from there, turning the speaker by 10 increments toward the listening area until you achieve the desired effect.



## LISTENING LEVELS AND POWER HANDLING

---

The power recommendation for the system assumes you will operate the amplifier in a way that will not produce distortion. All speakers can be damaged by a modest amplifier if it is producing distortion. If you hear a gritty noise or other signs of strain, turn down the volume. Prolonged or repeated operation of your speakers with a distorted signal can cause damage that is not covered by the warranty.

## HOW TO CARE FOR YOUR SPEAKERS

---

### For Black or White Painted Finishes

Including fronts, backs, bases, and metal grilles.

- fi *Use a soft terry cloth towel slightly dampened with water or a mild detergent. The towel should be just damp enough to wipe the surface clean without leaving a trail of moisture.*
- fi *Do not use abrasive cleaners or any cleaner containing chemicals harsher than those found in glass cleaner.*

### For Oiled Natural Wood Finishes

To remove dust and fingerprints, use the same technique as above.

- fi *If your veneer begins to dry, apply a light coat of rose or lemon wood oil. This should return the wood to its original richness.*
- fi *Do not use spray waxes. These will create a buildup and eventually cause the veneer to appear dull and lifeless.*

*Note:* Your veneer's appearance and color will mature and perhaps darken over time.

- fi *Avoid placing speakers in extreme conditions. If direct sunlight is unavoidable, be sure that there is nothing partially covering the veneer in order to prevent "tan lines".*
- fi *Avoid placing speakers where they could be subjected to standing water. It can cause the wood to swell, breaking apart glue joints and ruining the air seal.*

### Grilles

You can remove the grilles from the speaker system and wipe with a damp cloth to remove any dust.

# CONNECTING THE SPEAKERS

## Choosing Cable

We recommend 16-gauge cable or thicker for runs up to 25 feet (8m) and 12-gauge wire or thicker for longer runs. (We use a custom-configured 12-gauge oxygen-free cable in our crossover networks.)

## Connecting with Bare Wire

Insert bare wire into holes and tighten.

## Connecting with Banana Plugs, Spade Lugs, or Pins

The binding posts accept standard banana plugs and pins, and can accommodate spade lugs up to  $5/16$  inch.

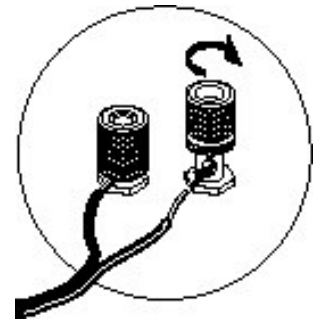

**Warning!** To prevent electrical shock, always switch off the amplifier or receiver when making connections to the speaker system.

## Connecting the E.5 and K.5

### Basic Connections

- fi Keep the jumper.
- fi When in doubt, be sure (red) an

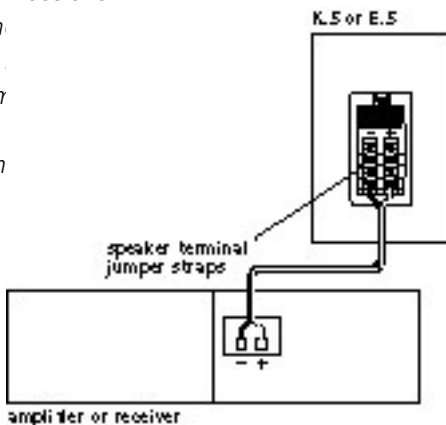

### Bi-Wiring

1. Use equal lengths of the appropriate wire when bi-wiring each speaker. Consult your dealer for cable options.
2. Unscrew both sets of terminals and remove the jumper straps.

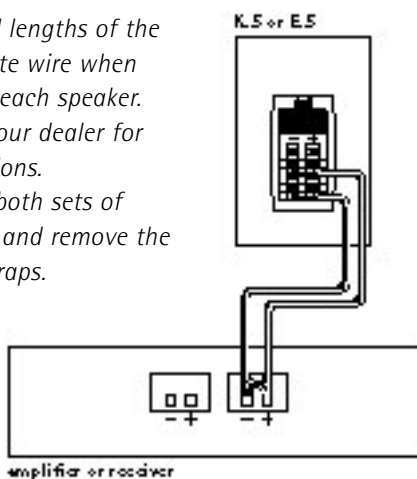

### Bi-Amplifying

Using one amplifier for the bass, and one for the high end:

1. Unscrew both sets of terminals and remove the jumper straps.
2. Connect the cables from the bottom set of terminals to the low-frequency amplifier driving the bass units.
3. Connect the cables from the top set of terminals to the high-frequency amplifier driving the tweeters.
4. Do not use an external crossover. It will interfere with the phase and frequency response of the E.5 or K.5.

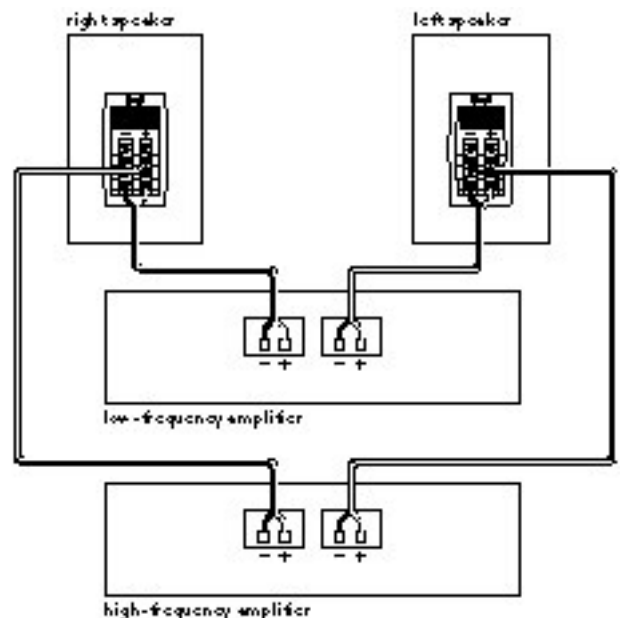

### Using One Amplifier for Each Speaker

Make sure that the amplifiers are identical.

1. Unscrew both sets of terminals and remove the jumper straps.
2. Connect the cables from the bottom set of terminals to the first amplifier's right channel.
3. Connect the cables from the top set of terminals to the first amplifier's left channel.
4. Repeat steps 2 and 3 for the second amplifier.

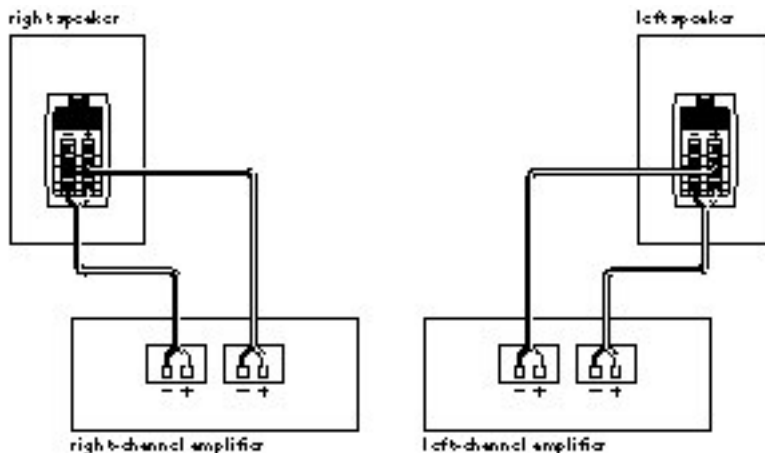

### Connecting to a Surround Processor

When using a powered subwoofer:

- fi Select the *SMALL* or *NORMAL* setting on your receiver or processor for your main and center channels. This routes all bass information (typically below 120Hz) to your subwoofer.

Match the sound levels of each speaker.

- fi Your home theater system most likely includes a test signal that simplifies level matching. Refer to the instructions provided with these electronics.

When not using a powered subwoofer:

- fi Select the *LARGE* setting on your receiver or processor for your main speakers. This routes all bass information (typically below 120Hz) to your main speakers.

## Connecting the CR.5

### Connecting the CR.5 to a Surround Processor

- fi Select the *SMALL* or *NORMAL* setting on your receiver or processor for the center channel. This routes all bass information (typically below 120Hz) to your subwoofer.
- fi When making connections, be sure to connect + to + (red) and - to - (black).
- fi Match the sound levels of each speaker. Your home theater system most likely includes a test signal that simplifies level matching. Refer to the instructions provided with these electronics.

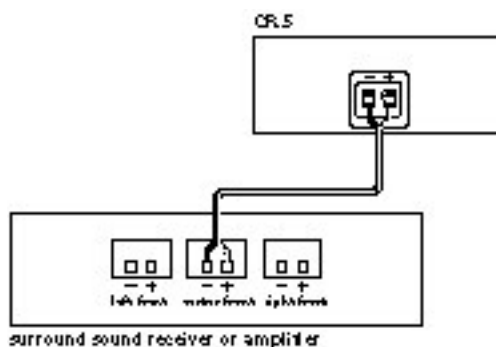

## LIMITED WARRANTY

---

For five years from the date of purchase, Snell Acoustics will repair for the original owner any defect in materials or workmanship that occurs in normal use of the speaker system, without charge for parts and labor.

Your responsibilities are to use the product according to the instructions supplied, to provide safe and secure transportation to an authorized Snell Acoustics service representative, and to present proof of purchase from an authorized Snell dealer in the form of your sales slip when requesting service.

Excluded from this warranty is damage that results from abuse, misuse, accidents, shipping, repairs, or modifications by anyone other than an authorized Snell Acoustics service representative. This warranty is void if the serial number has been removed or defaced.

This warranty gives you specific legal rights, and you may also have other rights that vary from state to state.

### **If Service Seems Necessary**

Contact the dealer from whom you purchased the speaker system. If that is not possible, call us at 978-373-6114, or write to:

Snell Acoustics  
143 Essex Street  
Haverhill, MA 01832

We will promptly advise you of what action to take. If it is necessary to return your speaker system to the factory, please ship it prepaid. After it has been repaired, we will return it freight-prepaid in the U.S. or Canada.

