



Metal Roofing Wholesalers

Classic Rib Roofing Panels

DETAIL MANUAL



www.MetalRoofingWholesalers.com

1170 Topside Rd • Louisville, TN 37777

(865) 379-7777 • Toll Free (877) 646-6382 • Fax (865) 982-4222



Figure 1 House With Classic Rib® Metal Roofing Installed

The Classic Rib® Roofing Panel

Classic Rib® panels are a strong, durable, economic, and attractive answer to the growing demand for the metal roofing needs of homes, businesses, and agricultural and utility buildings.

Classic Rib® panels provide a 36-inch coverage with ¾ inch ribs on nine-inch centers, and utilize an anti-siphoning channel to provide protection from severe weather

conditions.

Panels are roll-formed to the lengths specified by customers in either Galvalume® or any of eighteen colors of painted 29-gauge, 26-gauge, and 24-gauge high-tensile metal,

Your Metal Roofing Wholesalers representative is waiting to assist you in making the best choice for your particular roofing needs.

Features and Benefits

- Highly resistant to damage from high winds, hail, snow and rain. It is mildew-resistant, and will not rot or absorb water.
- Classic Rib is typically installed over solid sheathing with felt paper, or open framing.
- Finishes: MS Colorfast45 or ACG (Acrylic Coated Galvalume)
- 40-year paint finish warranty
- 36" wide, 29 or 26 gauge
- Minimum slope: 3:12
- Testing:
 - UL790, Class A Fire Resistance Rating
 - UL2218, Class 4 Impact Resistance
 - Texas Windstorm Approved
 - Florida Building Code Approved
 - Dade County Approved (26 gauge)

Figure 2 Classic Rib Features & Benefits

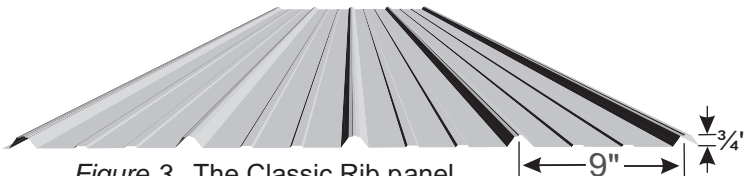

Figure 3 The Classic Rib panel

Metal Roofing Wholesaler's Classic Rib® panel is fabricated from high quality coil stock. The

Galvalume® finish is not only durable and cost effective, but offers the reflectivity which is valuable for energy efficiency. The paint system employed on our product offers optimum exterior protection plus superior resistance to corrosion and ultraviolet radiation. Classic Rib panel carries a 40-year limited coil manufacturer's finish warranty, and are of the highest known quality in the industry.



Metal Roofing Wholesalers

Installation of Panels

Roof Pitch

Classic Rib panels require a certain degree of pitch to ensure proper water drainage.

If installing panels on a roof with a pitch of 3/12, screws and sealant are applied to the laps to prevent water from siphoning over the ribs (see *Fig. 5* on p. 4). Lap screws and sealant are optional when the pitch is 4/12 or greater (4/12 pitch means that there is 4 inches of rise for every 12 inches running horizontally). As a general principle, the less steep the roof, and the more necessary also that sealant be used at all side-laps.

Consult our representative for recommendations for your particular roof pitch, and about roofing options if you have less than a 3/12 pitch.

Roof Application

Panel installation should begin at the gable end of the roof opposite the prevailing rain-bearing wind (this will provide added assurance against wind-driven rain being forced under the laps). Measure one panel width in from the roof edge. At this point chalk a line from ridge to eave. Place the leading edge of the first panel along this line. It is extremely important that this panel be laid square to the eave and ridge so that the remaining panels will line up square on the roof frame. It is wise to have a person at the eave and at the ridge to ensure that the proper panel coverage is being maintained across the roof. Also be sure that the panels are properly side-lapped (see *fig. 7* on page 6).

In applications where end-lapping is necessary, the upper panel on the slope should lap over the panel that is lower on the slope. Lower roof pitch requires a greater amount of panel overlap. All end-lap applications require two horizontal rows (across the panel) of butyl sealant tape and proper fastening to provide a maximum water seal.

An overhang of 2 to 3 inches is recommended to provide a drip edge, while only 1 inch overhang is necessary where gutters are used. The open panel ribs at the eave can be sealed with inside closures. For maximum weather-tightness, a row of butyl tape can be applied above and beneath closures material.

Trimming and Cutting Steel Panels

The best device for cutting steel panels *across the profile* is a TurboShear. This tool attaches to any 14.4 volt or larger cordless drill, and does an excellent job. You can also use a portable or hand shear or a nibbler. Nibblers, and especially Carborundum blades on electric saws, however, do have a tendency to either leave hot metal particles that can burn paint surfaces or leave rust marks on panels and trim. The same is true of any filings left on the roof caused by the application of screws. Care should be taken to brush all such particles from roof surfaces after application.

To *cut panels lengthwise*: Note carefully where the panel is to be cut, and, using a straightedge, score deeply down the length of the panel with a sharp-pointed utility knife. Folding the panel along the score mark, and bending back again if necessary, should produce a clean break in the panel.

CAUTION! clean all metal shavings and particles off of roof to avoid unsightly rust stains

(865) 379-7777 • Toll Free (877) 646-6382 • Fax (865) 982-4222

Residential Trim

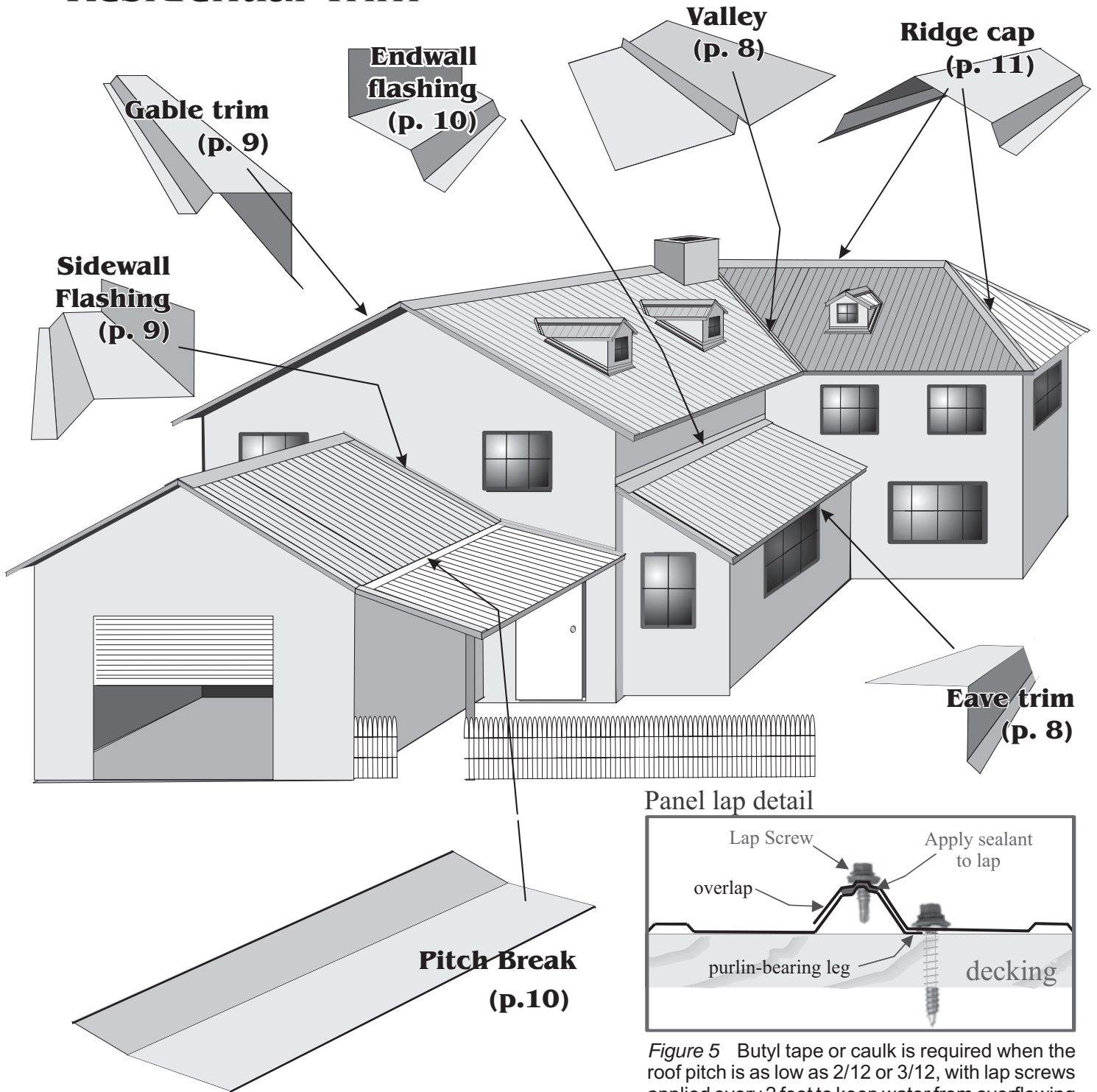

Figure 4 Roofing trims and flashings are named by the location or function of that particular piece on the building.

Figure 5 Butyl tape or caulk is required when the roof pitch is as low as 2/12 or 3/12, with lap screws applied every 2 feet to keep water from overflowing the lap. On pitches greater than 3/12, lap screws and butyl tape are optional. For more details on screws, see p. 6.



Metal Roofing Wholesalers

Ordering Roof Panels and Screws

Care should be taken to order panels of the correct length to avoid having to make corrective measures after purchase. Panel lengths should fall 2 to 3 inches short of the ridge *when a vented ridge is desired*, and should extend 2 to 3 inches past the eave to allow a sufficient drip edge (except as noted on pg. 3 concerning gutters). When a roof transition is involved, panels of the upper portion should be shortened to allow placement of the transition flashing. Our professional sales personnel are ready to assist customers with information specific to their particular roof.

Specially-washed screws applied through the flat of the metal is the most recommended method used to attach roofing panels. 1-inch screws can be used if penetration of only $\frac{3}{4}$ inch is either necessary or desired; otherwise, 1½ inch screws are usually recommended. 2 and 2½ inch screws are also available, and are often used by those who adhere to through-the-rib fastening, and for ridge-cap application. See page 6 for more information on screw spacing and ordering.

Ordering and Applying Trim

The most common flashing for metal roofing is the *ridge cap*, which is used at the peak of a roof where two opposing roof slopes join. Other flashings include *transition flashing*, *end wall* and *sidewall flashings*, and *valleys* (see diagram on right for application). Eave flashings include *gable flashing* and *eave drip*, either of which are often applied above *fascia* trim. When roof pitch exceeds 5/12 (a 5 inch rise in 12 inches), the slope of the roof should be mentioned when ordering ridge caps, endwalls, and eave drip. When a steeper roof slope meets a lesser slope, both slopes should be mentioned when ordering transition flashing.

At the gable edge the use of gable trim adds to the appearance of the structure and protects the fly-rafter, and sidewall flashing is used where the *side* of a panel butts up against an adjacent wall. In either case, the installer should be careful to seal between the gable rake or sidewall and panel with butyl sealant tape, and to fasten the rake every 6" to 12" up the slope of the roof with the appropriate screws. If eave drip is used on the gable, the number of 90 degree eave drip should be specified separately from that used on the drip edge when ordering.

To prevent penetration of water, insects, and debris at the ridge, outside closures may be inserted between the ridge cap and the top end of the panel*. Screws are applied through the ridge cap, closure, and rib in at least every other rib of the panels. At least a 1½" (or preferably 2½") screw should be used for attaching ridge caps. Self-drilling lap screws can also be used to attach ridge caps.

Keep Materials Dry!

Paint and finishes of our panels and trim are designed to withstand severe rain and wet weather conditions. Neither paint, galvanized, or Galvalume finishes, however, are designed to be in continuous contact with water for long periods of time. ***Damage will result if uninstalled panels or trim are allowed to remain wet in storage.*** Be sure to store material that will not be installed immediately in a dry location. Wet material should be air-dried and re-stacked if installation is not planned right away.

(865) 379-7777 • Toll Free (877) 646-6382 • Fax (865) 982-4222

How to Figure and Apply Screws

Metal Roofing Wholesalers carries screws in 4 different lengths: 1 inch, 1½ inch, 2 inch and 2 ½ inch. 1-inch screws will barely penetrate a 1x4, but the 1½ inch are the best all-purpose size. **1½, 2 or 2½-inch screws are necessary for attaching ridge caps.** The table on the right (Figure 6) can be used to figure approximate quantities of screws for various purlin spacings and sizes of roofs. For 2-foot spacing between rows of screws, multiply the total linear feet of metal times 2.7

Example: your order is 1250 feet of Classic Rib roofing.
1250 x 2.7 = 3375 screws

Please confirm all estimates with your representative when you placed your order.

Codes allow re-roofing over shingles without the use of battens providing the roof has been checked by a licensed roofing contractor to insure levelness and pullout integrity.

Classic Rib metal roofing can be separated from the moisture barrier by minimum, nominal 1"x3" yellow pine battens spaced on maximum 24" centers, or according to ASCE calculations where applicable. **Direct contact between pressure treated lumber and metal roofing must be avoided in order to prevent potential corrosion.**

CAUTION: Battens must be fastened to the roof deck with minimum #6 screws at 12" on-center, or two minimum 8d common or pneumatic nails spaced 8" on-center, or one every 4" on-center (or by applicable calculations according to ASCE 7-98). **Battens must be installed to support the entire width and length of ridge, eave, hip, valley, and gable-end trims.**

For solid decking, at least 15/32-inch structural plywood supported on rafters at a maximum of 24" on center is required.

If care is taken, metal roofing application can be aided by pre-drilling panels, allowing screws to go quickly and accurately into the desired spacing. Pre-drilling will work provided that pilot holes *are placed accurately* in the proper locations on panels. Purlin spacing must be uniform and carefully measured.

For panel lap details, see *Figure 5* on page 4.

| linear feet of panels in your order | Screw (purlin) Spacing | | | |
|-------------------------------------|------------------------|---------|---------|---------|
| | 12 inch | 18 inch | 24 inch | 30 inch |
| 50 | 270 | 180 | 135 | 108 |
| 100 | 540 | 360 | 270 | 216 |
| 200 | 1080 | 720 | 540 | 432 |
| 300 | 1620 | 1080 | 810 | 648 |
| 400 | 2160 | 1440 | 1080 | 864 |
| 500 | 2700 | 1800 | 1350 | 1080 |
| 600 | 3240 | 2160 | 1620 | 1296 |
| 700 | 3780 | 2520 | 1890 | 1512 |
| 800 | 4320 | 2880 | 2160 | 1728 |
| 900 | 4860 | 3240 | 2430 | 1944 |
| 1000 | 5400 | 3600 | 2700 | 2160 |
| 1100 | 5940 | 3960 | 2970 | 2376 |
| 1200 | 6480 | 4320 | 3240 | 2592 |

Figure 6 Classic Rib panel screw calculation chart

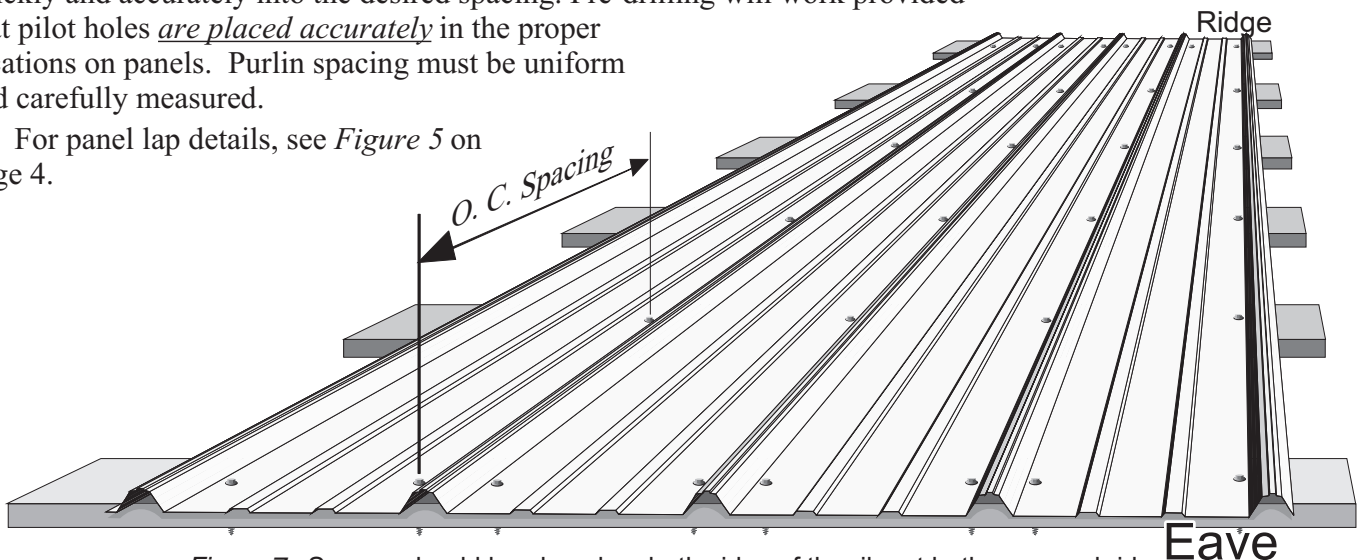

Figure 7 Screws should be placed on both sides of the ribs at both eave and ridge.



Metal Roofing Wholesalers

Policies

Delivery policy Delivery charges apply to all orders where delivery is requested. Please consult your Metal Roofing Wholesalers sales department for details.

Sales tax All orders picked up at Metal Roofing Wholesalers, and all orders delivered within the state of Tennessee are subject to state sales tax. Tax exemptions should be verified prior to delivery or customer pickup. In most instances orders delivered out-of-state are tax exempt.

Indemnity All prices and designs are subject to change without notice

Disclaimer While we have made every attempt at accuracy in this manual, we are not responsible for typographic, printing, or technical errors.

Return policy All panel orders and trim are considered the property of the customer and non-refundable once they are manufactured.

Summary of Stock Trims and Flashings

| <i>item</i> | <i>special order information</i> |
|-------------|--|
| Ridge cap | specify pitch if less than 3/12 or greater than 6/12. Closures recommended. |
| Eave trim | Used at gutter end. Many people also use as a gable trim. If you do, make sure to specify a 90° angle bend |
| Gable trim | Use butyl sealant between rake and panel. |
| W-Valley | specify pitch if greater than 7/12. Seal with universal foam closure material. |
| Sidewall | Use butyl sealant between sidewall flashing and panel. |
| Endwall | Specify pitch if greater than 5/12. Seal with outside closures. |
| Pitch break | Specify pitches of both roofs. Seal lower slope using outside closures and inside closures on upper slope. |

(865) 379-7777 • Toll Free (877) 646-6382 • Fax (865) 982-4222

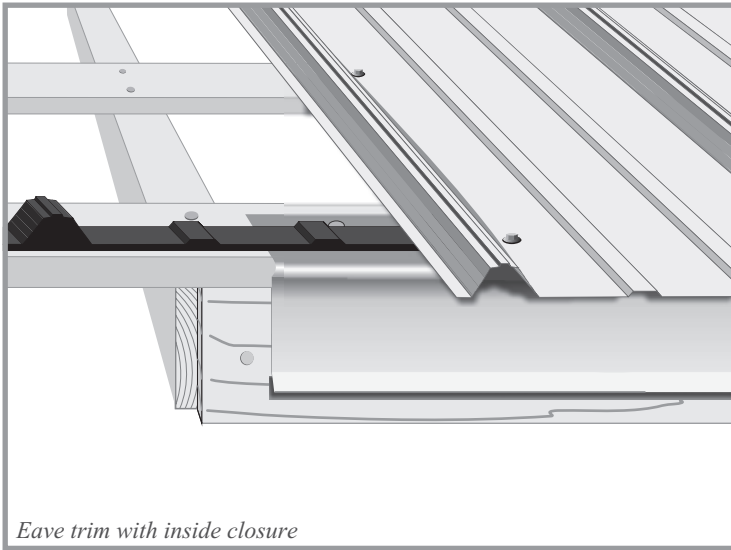

◀ Eave Trim

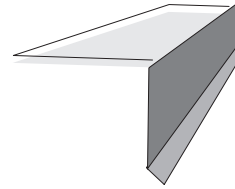

For custom eave trim, specify the amount of the eave that will be covered, and, for steeper roofs, specify pitch .

Eave trim with inside closure

Figure 8 Eave trim gives a finished look along the drip eave of the house, as well as providing protection for the materials they cover. The eave trim should completely cover the top edge of the fascia. Inside closures, which seal off the open ribs of the panels, are optional.

▶ Preformed W-Valley

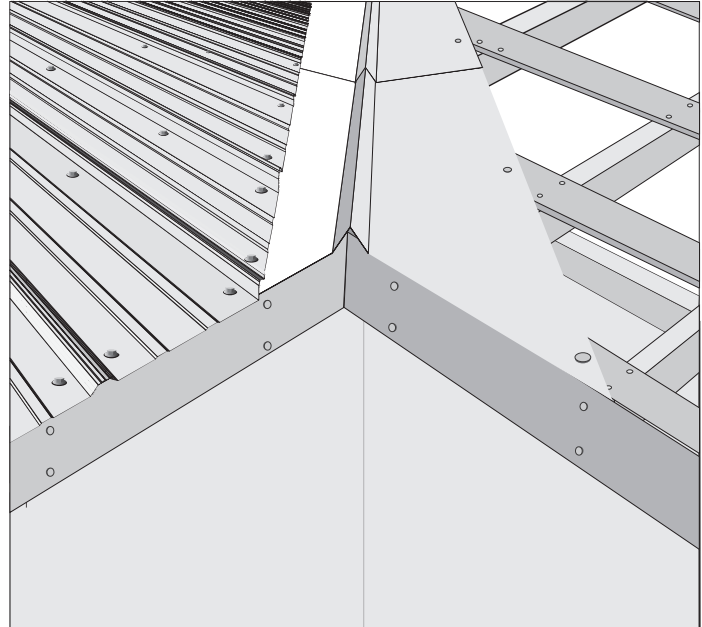
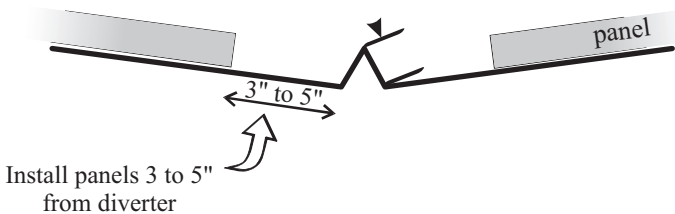

Figure 9 Pre-formed valleys use a diverter to prevent water from rushing under panels on the opposite side while meanwhile channeling water off the roof. Expanding foam closures are often used to assure a good seal.



Corner /Gable Trim

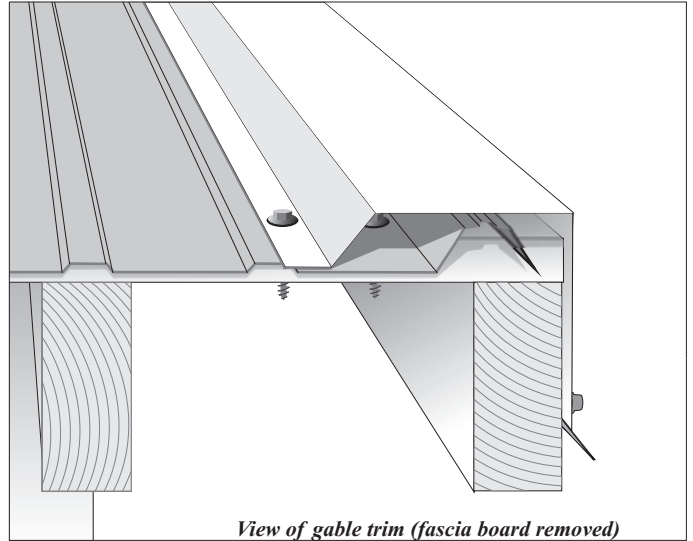
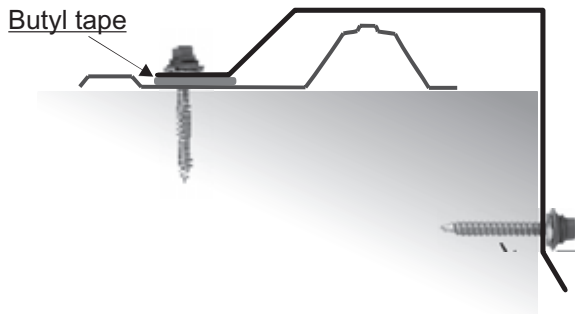

Figure 10 Gable trim is used to trim the edge of the roofing panel at the gable end of the roof. If the panel is allowed to hang over the gable end, eave drip can be used instead. Butyl tape between the trim and panel eliminates leaks.

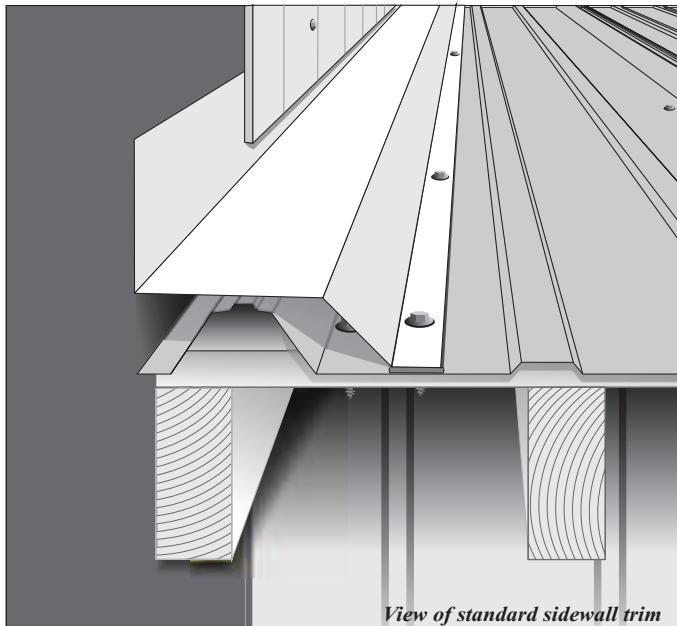
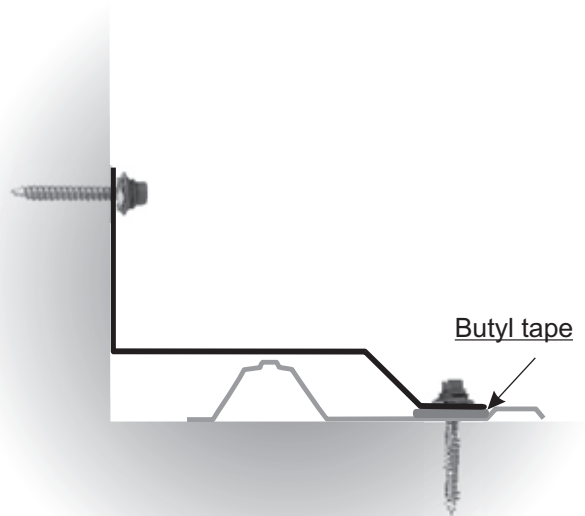

Figure 11 Sidewall flashing is applied when the side of the roof butts up against an adjacent wall. The wall-side of the flashing can either be covered over with siding or sealed with caulk. Butyl tape should be applied where the "foot" of the flashing attaches to the roof.

Side-wall Flashing



End-wall Flashing

End-wall flashing is applied where the upward slope of a roof meets a wall. The wall side of the flashing can be covered with siding or counter-flashing, and outside closures are used to seal between the flashing and the panel. Roof slope should be mentioned if roof exceeds 5/12 pitch.

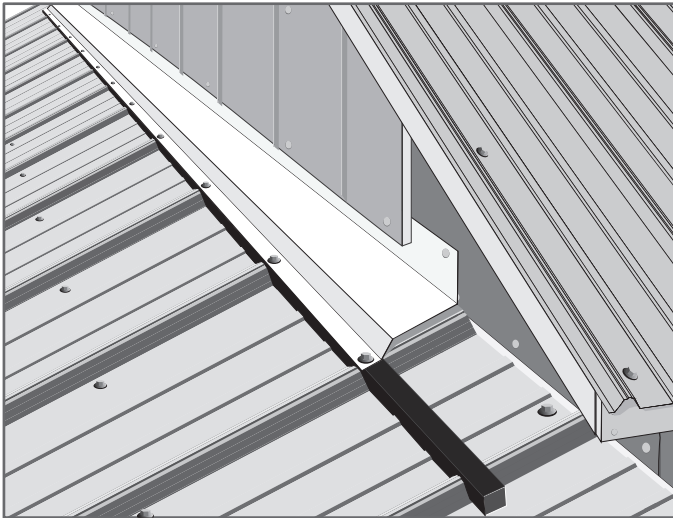
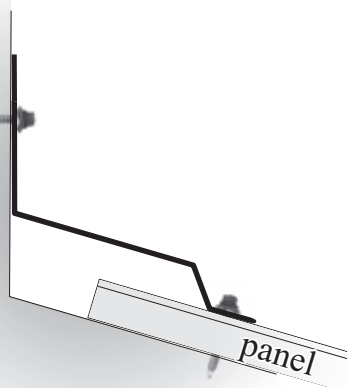
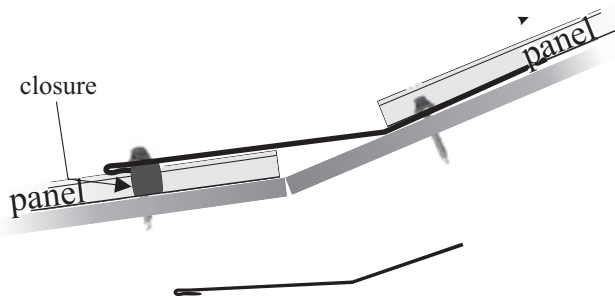

Figure 12 As with the ridge cap, the ENDWALL FLASHING above can be sealed using outside closures.

Transition /Pitch Break

PITCH BREAK prevents leakage at the point where two different roof pitches meet. It is sealed on the lower side with outside closures, and can be sealed underneath the upper panels with inside closures.



For custom pitch break specify the pitches of the two roof slopes.

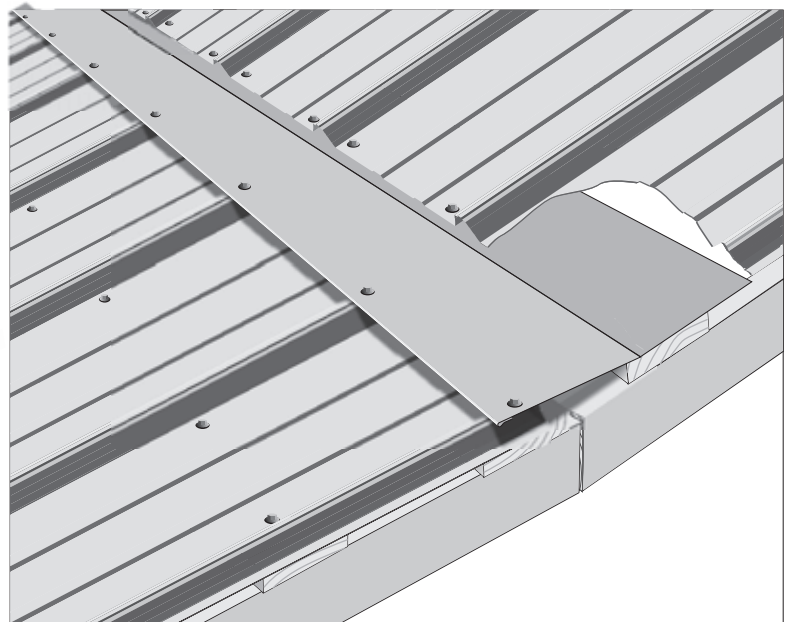

Figure 13 The pitch break provides a continuous drainage where two slopes meet.

Ridge Cap

The Ridge Cap is used to seal the point at which two upward slopes meet. This can be both along the ridge of the roof as well as a covering for a hip. Either woodgrip or self-drilling lap TEK screws are applied through the ribs of the metal.

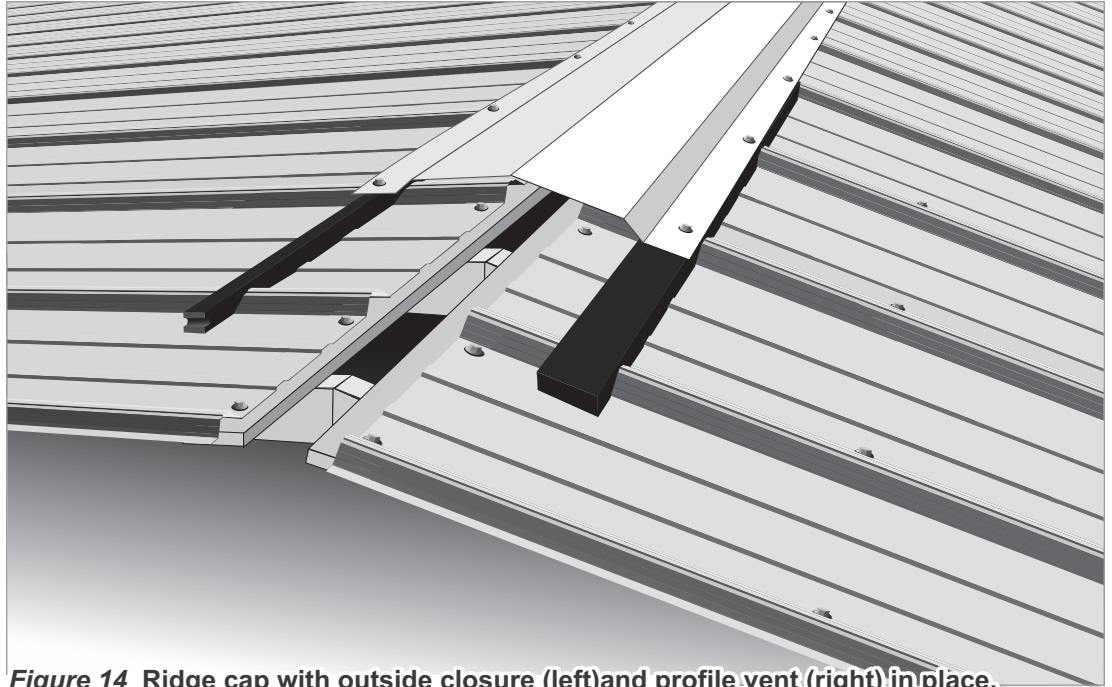

Figure 14 Ridge cap with outside closure (left) and profile vent (right) in place.

Debris, insects, and blowing rain can find easy access under the ridge cap, so closures are often used to either completely or partially seal the opening. Closures under ridge caps come in 3 types: solid, vented, and hip tape.

Solid closures (“Outside Closures”) are the same width as the panels.

They lock together in a row placed directly under the screws that attach the ridge cap, and form a solid, water-tight, air-tight barrier. (see Figure 14 on opposite page).









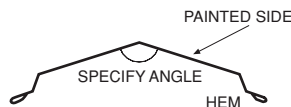

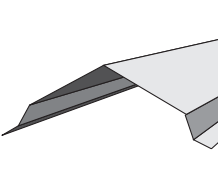
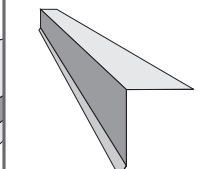
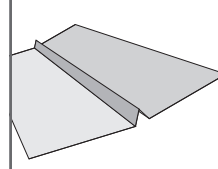
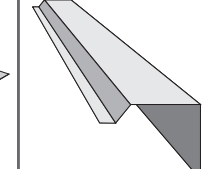
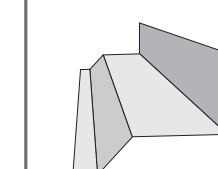
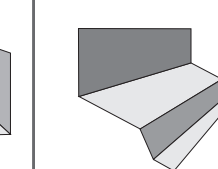
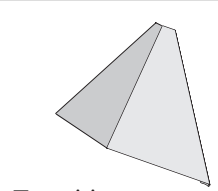
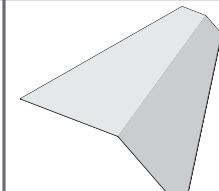

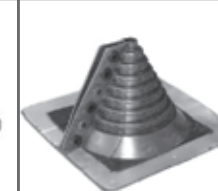
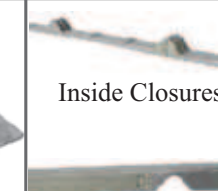
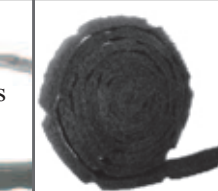
Profile Vent® comes in 100 foot rolls, is 3 inches wide, and forms a water-retardant, insect resistant barrier that allows hot air to escape from the attic, and is superior to many more elaborate and expensive vent systems. Any length may be ordered.

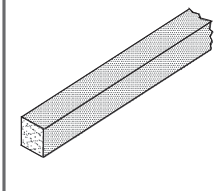

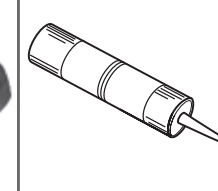
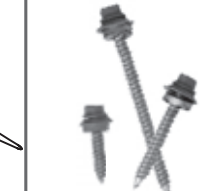
Figure 15 Pipe Boots provide a water-tight seal around roof vents and come in a variety of sizes. They seal with caulk and conform to the shape of the panel ribs.

Ridge or Hip Cap

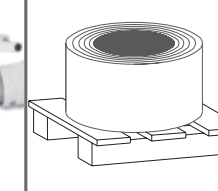
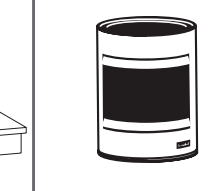

| | | | | | |
|---|--|---|--|---|---|
|  Ridge cap (pg. 11) |  Eave Trim (pg. 8) |  W-Valley (pg. 8) |  Gable Trim (pg. 9) |  Sidewall (pg. 9) |  Endwall (pg. 10) |
|  Transition flashing (pg. 10) |  Gambrel flashing |  Pipe Boot (pg. 11) |  Electrical Boot |  Inside Closures |  Outside Closures |
|  Profile Vent [®] |  Expanding Foam |  Universal Closure |  Butyl Tape |  Urethane Sealant |  Woodgrip [®] Screws |
|  Self Drill screws |  Sky Light Panels |  TurboShear |  Snow Guards |  Trim Coil |  Touch Up Paint |

Guide to Misc. Accessories

| <i>item</i> | <i>application</i> |
|------------------------------------|---|
| pipe boot | Fits over vent and heat pipes. Available also in <i>heat-resistant</i> boots. |
| electrical boot | Fits around pipes with inaccessible tops (such as weatherheads). |
| outside closures | Seals under ridge caps and transition and endwall flashings. |
| inside closures | Seals under panels, particularly on the eave. |
| Profile Vent[®] | Vented closure material surpassing many other venting systems. |
| expanding foam | Compressed adhesive foam expands to seal between valleys and panels. |
| touch-up paint | Hides scratches and mars encountered in installation. |
| butyl tape | General purpose low-cost sealant, used on panel laps and under trim. |
| Woodgrip[®] screws | Used in all applications attaching metal to wood. 1", 1½", 2", 2½" sizes. |
| TEK screws | Self-drilling TEK screws for metal purlins. Lap TEK screws draw together joints and attach trim. |
| snow guards | Used in parts of the country which receive a high amount of snow to prevent snow from sliding off the roof. |
| TurboShear | An attachment which converts any drill into a high powered metal shear |