

**NORMAN**<sup>®</sup>  
SHUTTERS. BLINDS. SHADES.



---

Quality Wholesale Window Coverings  
Contract • Hospitality • Healthcare • Residential

# Woodlore<sup>®</sup> Plus Shutters

Program Reference Guide

2020

2020 Shutter Revision log

# WOODLORE® PLUS

Effective Date	Topic	Section	Note
2020/01/01	New frames	e	Added 1 1/2" Deep Bullnose Z frame and Deep Plain L frame to Woodlore Plus Waterproof option
2020/02/20	Frame Styles, Special Options, Specialty Shapes	e,k,l	<p>e: add contents:</p> <ol style="list-style-type: none"> <li>1. The coordinating T-post for 1 1/2" Deep Bullnose Z frame &amp; Deep Plain L frame will be 1" Chamfer T post W 1/4" light block (Deco) or 1" T post W 1/4" light block (Deco), T-post light block depth more than 1/4" is not available.</li> <li>2. 1 1/2" Deep Bullnose Z frame &amp; IM Deep Plain L frame will <b>NOT</b> be pre-drilled unless <b>Pre-drilled "Yes"</b> was specified in the order.</li> <li>3. OM Deep Plain L frame will <b>NOT</b> be pre-drilled.</li> <li>4. Regarding shutter with horizontal Tpost type issue:             <ol style="list-style-type: none"> <li>1). If Woodlore Plus-Waterproof with <b>Beaded</b> vertical T-post is selected, the horizontal T-Post type will be a Beaded T post; Otherwise, horizontal T-Post type will always be Chamfer T post by default.</li> <li>2). For Woodlore Plus-non Waterproof, Horizontal T-Post type will always be the Chamfer T post unless otherwise specified.</li> </ol> </li> <li>5. Add 1" T post with insert for Monterey Plus -non Waterproof option</li> </ol> <p>k:</p> <ol style="list-style-type: none"> <li>1.Café Shutters add content: <b>When the height of the framing material (including t-posts) exceeds the panel height, by more than 5", a surcharge will apply.</b></li> <li>2.Custom Colors add a new custom color deck <b>" Benjamin Moore, Off White Collection M2451888TL"</b></li> </ol> <p>l: add contents for Specialties shutter</p>

2019 Shutter Revision log

# WOODLORE® PLUS

Effective Date	Topic	Section	Note
2019/01/01	Colors Option Louvers Options Frame Options	All except j&o	2019 updated specification
Middle of January 2019	Motorized	o	2019 updated specification
2019/01/10	Track	j 2	Add 3" louver for Open bypass
2019/02/01	color	e,l,n	Add 6 new hinge colors Change color coordination chart
2019/02/01	stile	c	Add stile options Optional: Chamfer stile
2019/02/27	Side magnet	i	Add notes: if panels only with side magnets and there is no standard magnet on the back of panels, panels may open for external factors.
2019/03/01	Specialty shutter	k	1.Add Specialty shutter information  2. Waterproof Woodlore plus Specialty Shape Shutter Still be Available
2019/03/01	tracks	j1, j2	2016 stopper Change Note: Bifold track: For 90° Floating Panels outside mount/semi-inside mount without side boards <del>but with fascia return</del> , the 2016 Stopper will be supplied by default. The gap between the fascia return / end of top track and the panel is 5mm each side.  Bypass track: 1. Note: For Semi-Inside/OM bypass without side boards <del>but with fascia return</del> , 2016 Stopper will be supplied. 2. For outside mount/semi-inside mount bypass without side boards <del>but with fascia returns</del> , the 2016 Stopper will be supplied by default. The gap between the fascia return / end of top track and the panel is 5mm each side.

# WOODLORE® PLUS

## 2019 Shutter Revision log

2019/03/13	New PerfectTilt RF	O/j2	O: Revise Norman Dial (Remote) Dimensions : 68mm diameter x 21mm j2: 2016 Track Shutters-Bypass
2019/03/16	New PerfectTilt RF	o	Add comments of PerfectTilt G4 & groups
2019/04/09	surcharge notes	b,e,g,i,k,l	<a href="#">Change notes from</a> *Surcharge applies. Please see Options and Surcharges page for details to <a href="#">*Some surcharges apply on the bottom of a page</a>
2019/04/15	French door cut outs	K	<a href="#">Add French door cut outs information</a>
2019/04/27	New PerfectTilt RF	o	<a href="#">Hub note: change “It will be available in March 2019” to “It will be available soon”</a>
2019/04/30	Custom color	k	<a href="#">Update custom color booklet name</a>
2019/05/06	pole	i	<a href="#">Pole remove pole length 43”</a>
2019/05/09	Custom T post	e	<a href="#">move Custom T post comment near to T post drawing</a>
2019/06/13	Continuous Arch	k	Continuous Arch is not available for Waterproof option.
2019/07/10	New PerfectTilt RF		Change Micro USB cable usage.
2019/07/15	New PerfectTilt RF		1. Remove the O section, and that motorization is now in a separate program binder; 2. Add Micro USB Cable Length: 3 meters;
2019/07/27	Specialty Shutters	l	<a href="#">Change the drawing of Standard unit with horizontal arch center</a>
2019/08/05	Custom T post, S1 and S2 Scribe trim	e	1. Add content for Custom T post: <ul style="list-style-type: none"> <li>▪ Size limits (7 1/2”)</li> <li>▪ Available for composite but it will be made from wood for non-Waterproof option</li> <li>▪ That a surcharge applies and customers should refer to their shutter pricing</li> <li>▪ Any limitations</li> </ul>

# WOODLORE® PLUS

## 2019 Shutter Revision log

			2. Add drawing and description of the S1 and S2 Scribe trim
2019/08/05	Direct Mount 3" Hinge , Pole	i	<ol style="list-style-type: none"> <li>1. Add comment: Direct Mount 3" Hinge is not suitable for drywall installations.</li> <li>2. Increase 1 pole length (2pcs combined by connector).</li> </ol>
2019/08/14	Specialty Shutters, Shutter pole	i, l,k	<ol style="list-style-type: none"> <li>1. Rounding new added pole length to 53" (2pcs combined by connector).</li> <li>2. K:Remove the Specialty Shutters information</li> <li>3. Add Specialty Shutters information and drawings to l section</li> </ol>
2019/08/26	quarter round scribe trim	e	Add quarter round scribe trim (made in wood) for non-waterproof option
2019/08/30	Table of Contents , Colors & Louver Sizes/Louver Clearance, Hardware,	b,i,n	<ol style="list-style-type: none"> <li>1. Revise the table of contents information, rename point b</li> <li>2. i: Remove Oil-Rubbed hinge color information</li> <li>3. i: Revise "Nickel" hinge color to "Nickel Plated" , revise color coordination chart</li> <li>4. i: Remove shutter pole length 32"</li> <li>5. Remove n section, and that information will be in b&amp;i sections</li> </ol>
2019/10/05	Tilt rods; General product specification; Bifold track	f,g,j1	<ol style="list-style-type: none"> <li>1) Revise Split tilt information</li> <li>2). Add Content: <b>Shutters without bottom supports</b> Shutters without bottom supports may sag and deform, including situations below: <ol style="list-style-type: none"> <li>1. Shutters with bottom gap over 0.1";</li> <li>2. Shutters with no frame or no existing sill at the bottom to support the panel (or bottom has frame/existing sill, but the panel keep to open long time without bottom support).</li> </ol> </li> <li>3). Revise track drawing ( correct 1 1/2" louver to 2 1/2")</li> </ol>
Middle of October	1.6" sill plate with 3/8" light	e	Use new 1.6" sill plate with 3/8" light block to replace 1.5" sill plate

# WOODLORE® PLUS

## 2019 Shutter Revision log

	block, 1.6" sill plate with 5/8" light block		with 3/8" light block, use new 1.6" sill plate with 5/8" light block to replace 1.5" sill plate with 5/8" light block for non-waterproof option at first
2019/10/23	1.6" sill plate with 3/8" light block, 1.6" sill plate with 5/8" light block	e	For all deco frames and L frames with 1/4 Light Block of non-waterproof option: Use new 1.6" sill plate with 3/8" light block to replace 1.5" sill plate with 3/8" light block, use new 1.6" sill plate with 5/8" light block to replace 1.5" sill plate with 5/8" light block.
2019/11/01	Invisible hinge, Panel Lock position, Shutter pole	i	<ol style="list-style-type: none"> <li>1. Invisible hinge: add Invisible hinge drawing, update point2 description</li> <li>2. Panel Lock position: add drawings of L/R/LR panel configuration</li> <li>3. Update New pole lengths (2pcs Combined by Connector): Poles will be with Plastic Tube.</li> </ol>
2019/11/07	Ring Pull	i	<p>Add content:</p> <p><b>Ring pull location principle for Floating Panels:</b></p> <ol style="list-style-type: none"> <li>1. When floating panel config is in pairs, it will be split into halves, the left will be for LL and the right will be for RR. So the ring pull location for FF/FF, FF/FF/FF/FF will be same as that of panel config as LL/RR, LL/LL/RR/RR.</li> <li>2. When floating panel config is FF, the ring pull location will be same as that of panel config LL.</li> <li>3. When floating panel config is singular, it will be split into 3</li> </ol>

# WOODLORE® PLUS

## 2019 Shutter Revision log

			sections, the left and mid sections are for LL and the right section is for RR. So the ring pull location for FF/FF/FF, FF/FF/FF/FF/FF will be same as that of LL/LL/RR, LL/LL/LL/RR/RR.
2019/11/20	Specialty Shutters	I	page1, revise content: material of Specialty Shutters for Waterproof option will be ABS
2019/11/22	Specialty Shutters	I	page1, revise content: Specialty Shutters for Waterproof option will be made from waterproof ABS co-polymer.
2019/12/01	Custom Colors	k	Revise Custom Colors information
2019/12/05	Invisible Hinge Slim Fit Posts	i,e	<p>i: Invisible Hinge, Frame Options: change Traditional Hang Strip to Traditional Hang Strip (beside the panel)</p> <p>e. Add content:  <b>Note: Due to size and weight limitations, Slim Fit Posts may only be hinged on one side and with a single panel (no bi-folded panels). Please consider this when determining panel configuration.</b></p>

# WOODLORE® PLUS

Table of Contents	Page
a. Features & Benefits	WLP a-1
<b>b. Colors &amp; Louver Sizes/Louver Clearance</b>	<b>WLP b-1</b>
c. Stiles	WLP c-1
d. Panel Configurations	WLP d-1
e. Frame Styles	WLP e-1
f. General Product Specifications	WLP f-1
g. Tilt Rods	WLP g-1
h. Divider Rails	WLP h-1
i. Hardware	WLP i-1
j. Track Shutters	WLP j-1
k. Special Options	WLP k-1
l. Hardwood Specialty Shapes	WLP l-1
m. Pricing	WLP m-1
<b>n. Appendix</b>	<b>WLP n-1</b>



# WOODLORE® PLUS

## Features and Benefits

- Built around the concept of modern convenience, **Woodlore® plus** combines wood composite frames with durable ABS louvers. Wood composite materials used are harvested from well-managed forests and finished with a polypropylene coating that prevents moisture absorption and allows for easy stain removal. ABS co-polymer louvers are dimensionally stable, which **resist cupping, warping and twisting**.
- 36" wide single panel for enhanced view.
- **Reinforced engineered stiles** – Stile core durability reinforced with multiple layers of wood bonded together. The result is a robust support system for shutter panels.
- **UV inhibitor** protects shutters and home décor from UV rays, prevents color fading and sun damage.
- Multiple stile options are available in various sizes to accommodate different window configurations. **Astragal** or **Rabbet stiles** provide a natural light block between panels.
- A wide range of **frames with inserts**, which keep installation screws out of sight for a clean and decorative look, match any style and preference.
- Personalize shutters with **special options**. Choose from fixed louvers, hidden or offset tilt rods, café styles, bay and corner window shutters, track systems and many more.
- Quick and easy on-site assembly and installation with the **pre-installed magnets and hinges, pre-mitered frames** and **slotted keyholes**.

### **For Waterproof Option:**

- The special option is perfect for wet or moisture prone areas in the home.
- Featuring enhanced resistance to moisture, shrinking and warping, the shutter frame, stile and louvers are made from durable and waterproof ABS co-polymer
- The unique UV inhibiting finish is designed for a virtually worry-free solution.
- Stainless steel hinges included in the option are guaranteed never to rust or corrode.

# WOODLORE® PLUS

## Colors & Louver Sizes/Louver Clearance

No.	Color ID	Color Name
1	001	Pure White
2	002	Extra White
3	003	Silk White
4	004	Bright White
5	006	Pearl
6	007	Ivory Lace
7	009	Creamy
8	012	Crisp Linen
9	016	Butter
10	019	String
11	030	Moondust
12	032	Sea Mist
13	042	Hall Gray
14	046	Ice
15	048	Chai
16	049	Stone Gray
17	051	Brown Gray
18	053	Clay
19	063	Decorators White
20	066	Winchester White 2010
21	073	Sky Gray
22	074	Element Gray
23	075	Storm Gray
24	077	Dawn
25	078	Cloud Blue
26	080	Taupe Gray
27	836	Classic Black

\*Some surcharges apply

WLP b - 1

# WOODLORE® PLUS

Louvers	
Elliptical	1 <sup>7</sup> / <sub>8</sub> "* 2 <sup>1</sup> / <sub>2</sub> " 3" 3 <sup>1</sup> / <sub>2</sub> " 4 <sup>1</sup> / <sub>2</sub> "

## Louver Depth Clearance

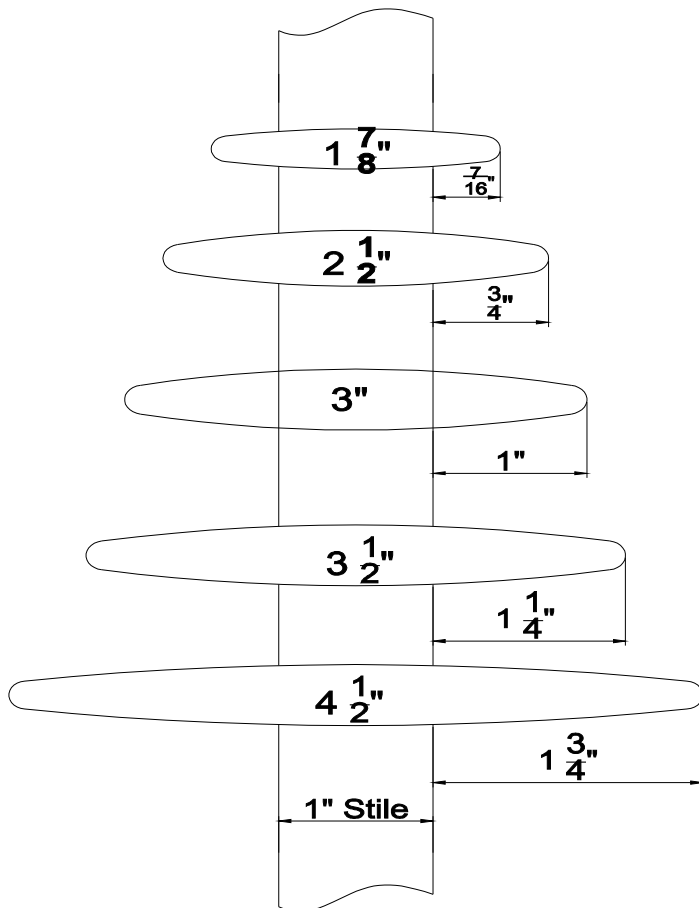

\*Some surcharges apply

WLP b - 2

# WOODLORE® PLUS

## Louver Depth Clearance For Specific Frames

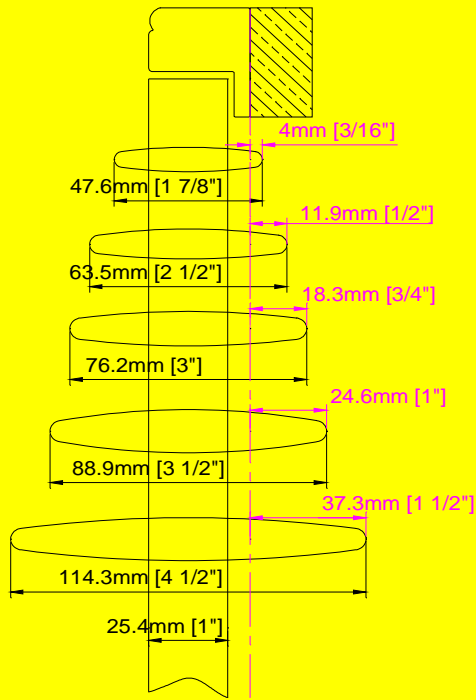

L Frame with 1/4" light block  
Not available for waterproof option

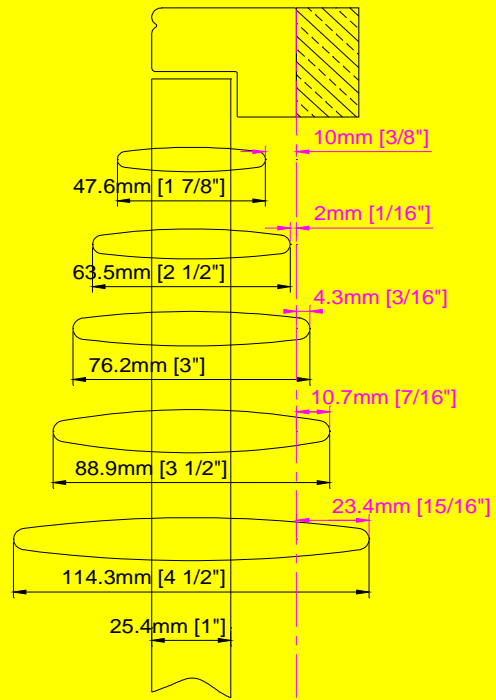

L Frame

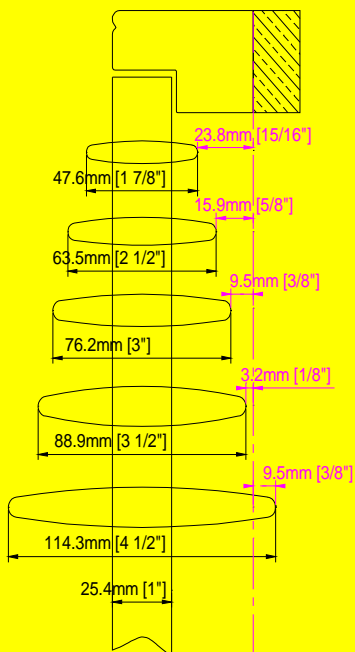

L Frame with 1/2" Buildout

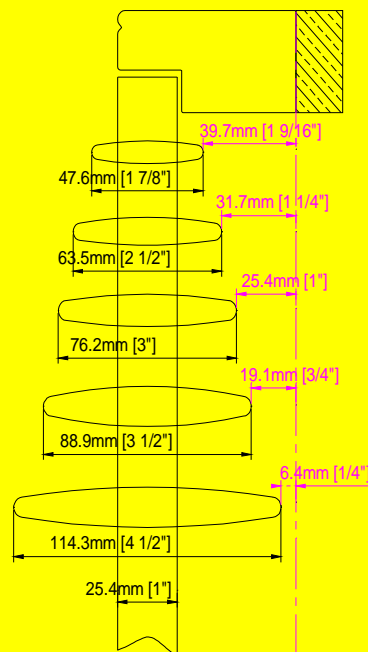

L Frame with 1" Buildout

Not available for waterproof option

\*Some surcharges apply

WLP b - 3

# WOODLORE® PLUS

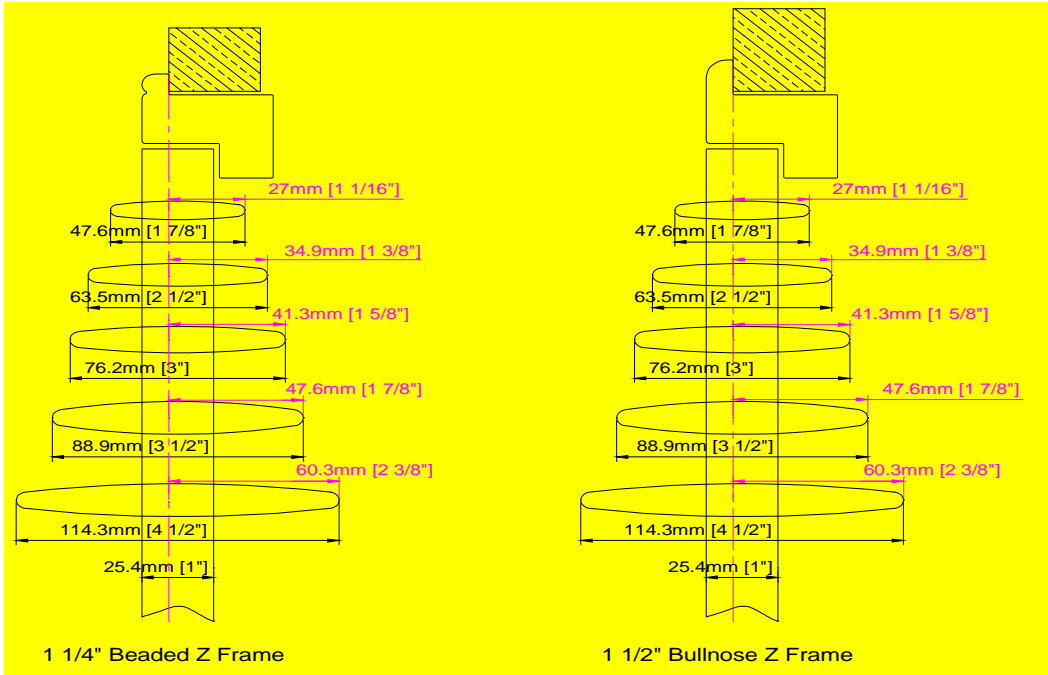

Not available for waterproof option

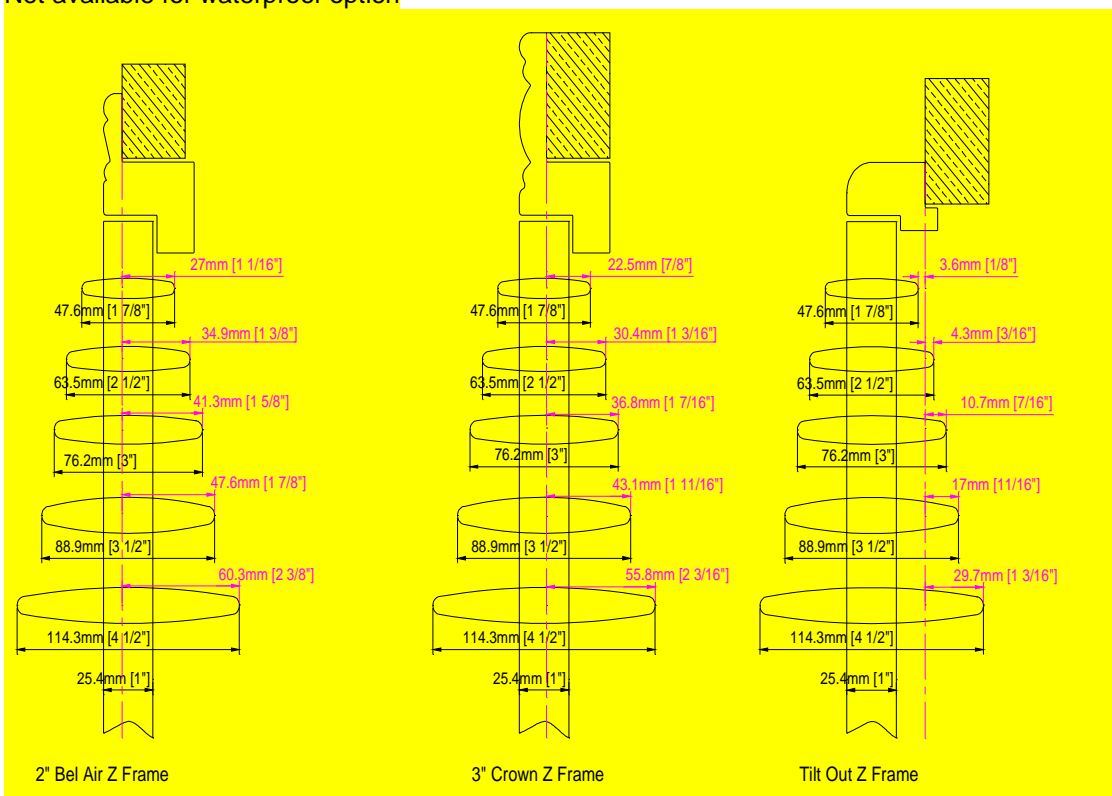

Not available for waterproof option

\*Some surcharges apply

WLP b - 4

# WOODLORE® PLUS

For non-waterproof option

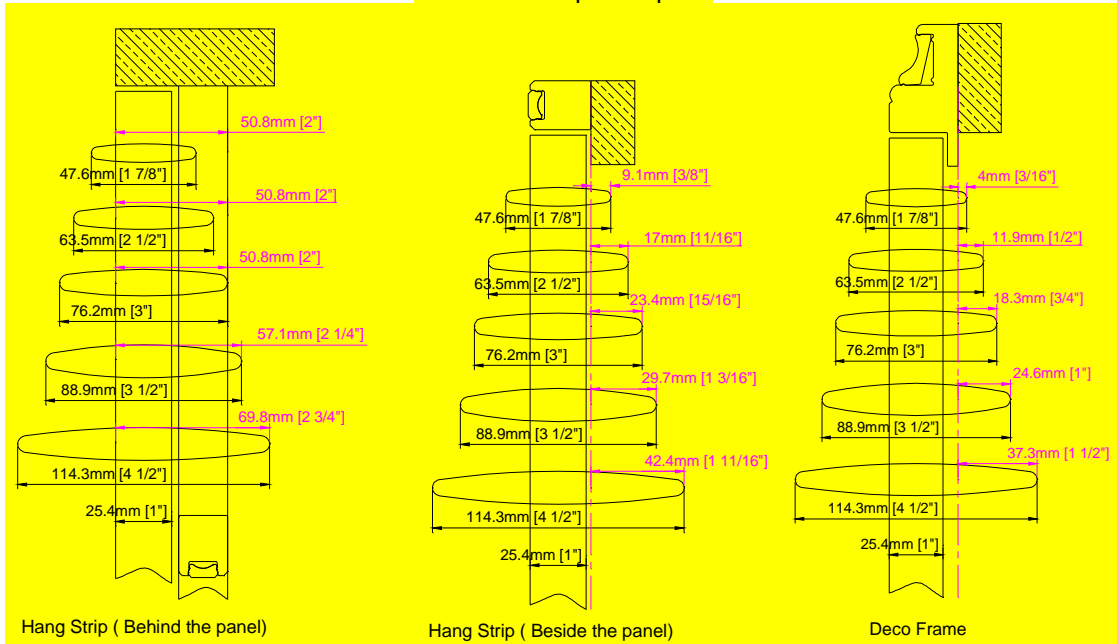

For waterproof option

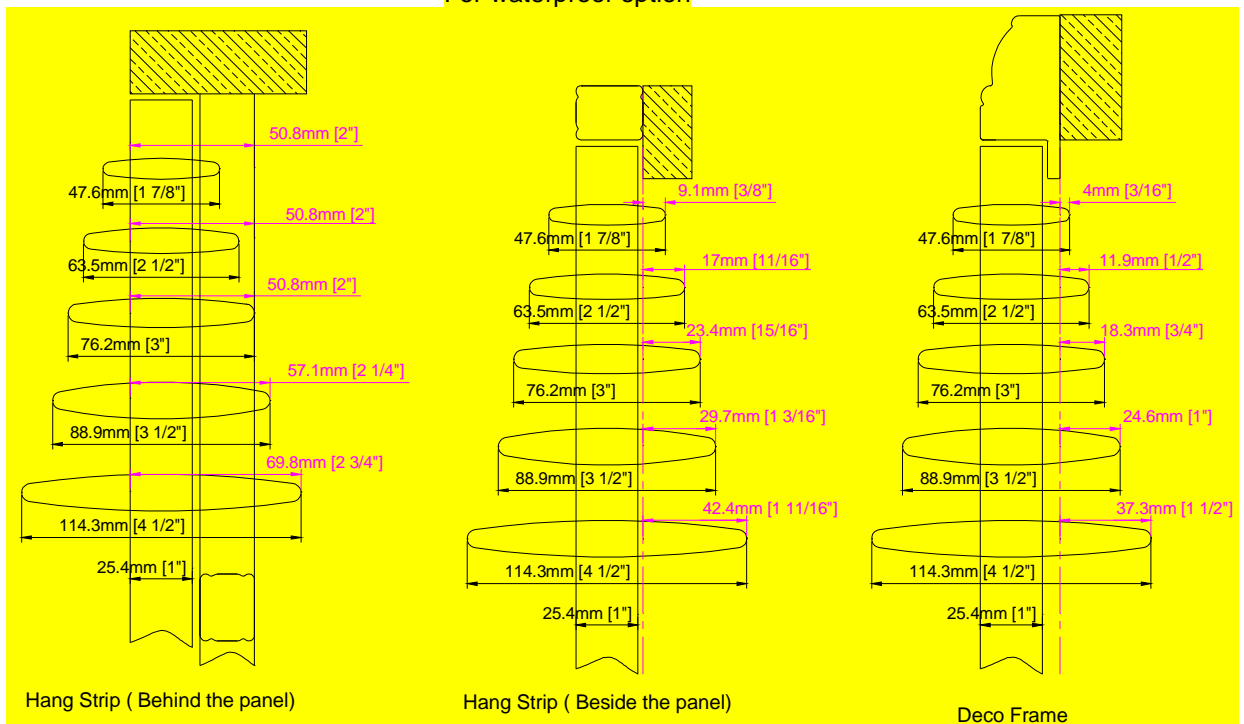

\*Some surcharges apply

WLP b - 5

# WOODLORE® PLUS

## Stiles

Default: Beaded stile

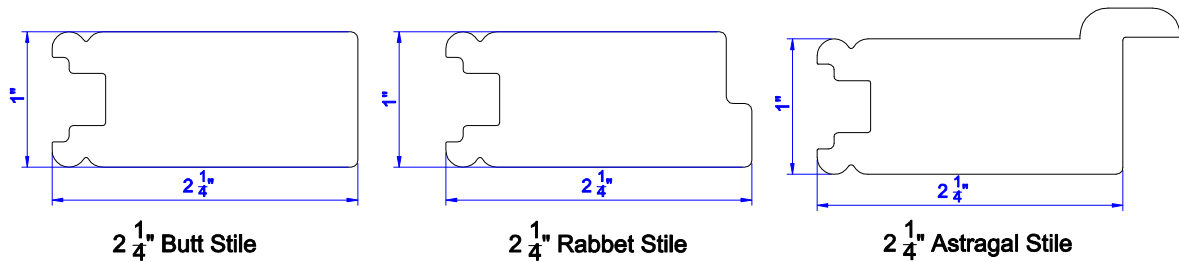
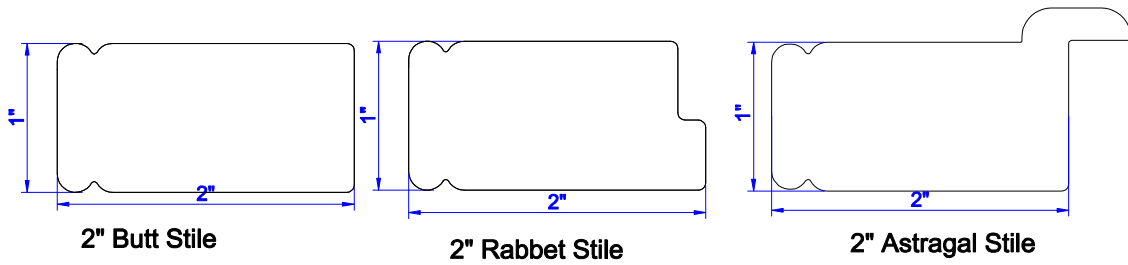
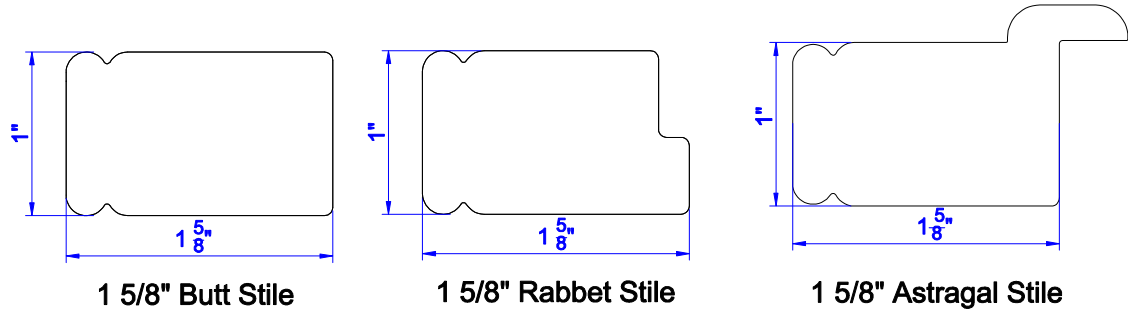

Note: 1 5/8" and 2 1/4" stile is not available for Waterproof option.

Optional: Chamfer stile

For Non-Waterproof option:

1 5/8" Stiles:

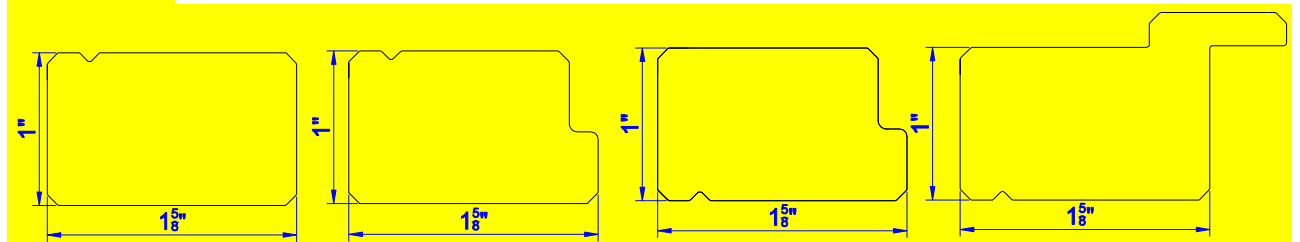

1 5/8" Butt Stile

1 5/8" Rabbet Style-R

1 5/8" Rabbet Style-L

1 5/8" Astragal Stile

# WOODLORE® PLUS

## 2" Stiles:

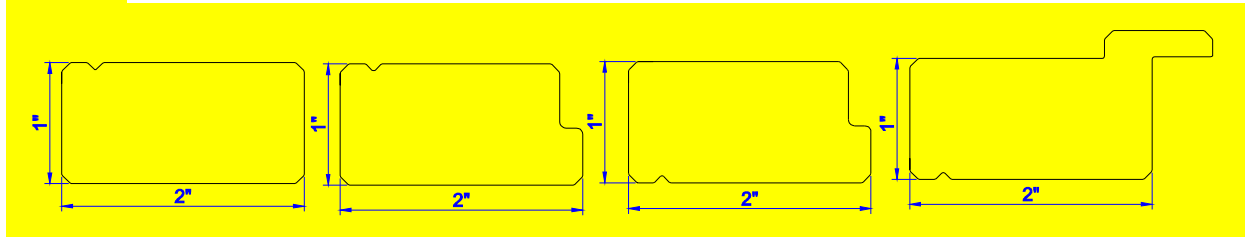

2" Butt Stile

2" Rabbet Stile-R

2" Rabbet Stile-L

2" Astragal Stile

## 2.25" Stile

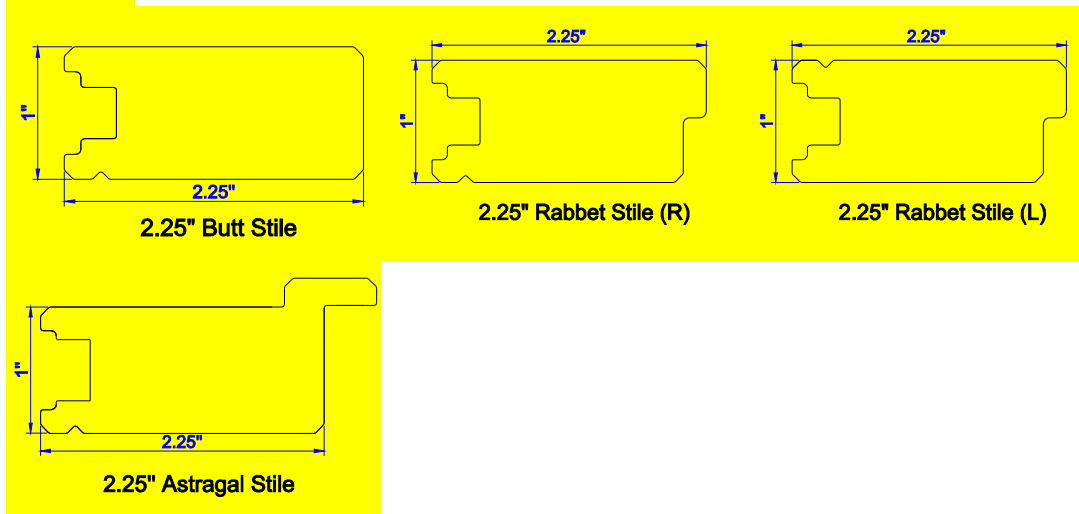

2.25" Butt Stile

2.25" Rabbet Stile (R)

2.25" Rabbet Stile (L)

2.25" Astragal Stile

## For Waterproof option:

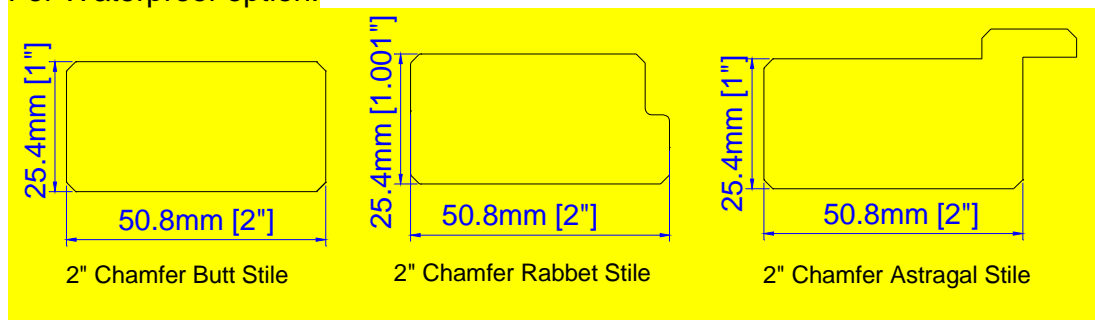

2" Chamfer Butt Stile

2" Chamfer Rabbet Stile

2" Chamfer Astragal Stile



# WOODLORE® PLUS

## Stiles (continued)

### Stile between panel closure

#### Single panel

- I) Panel width < 9"
  - Rabbeted stile (Deco frame, L frame, Z frame and Hang strip beside panel)
    - 1 <sup>5</sup>/<sub>8</sub>"
    - 2" (default)
  - Butt stile only (Hang strip behind panel)
    - 1 <sup>5</sup>/<sub>8</sub>" ( Optional for panel width ≤ 12" )
    - 2" (default)
- II) Panel width ≥ 9"
  - Butt stile only
    - 1 <sup>5</sup>/<sub>8</sub>" ( Optional for panel width ≤ 12" )
    - 2" (default)

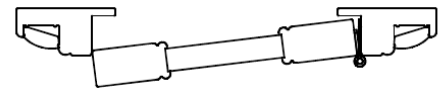

#### 2 panels or more

- Rabbet stile
  - 1 <sup>5</sup>/<sub>8</sub>" (Optional for panel width ≤ 12")
  - 2" (default)
- Astragal stile
  - 1 <sup>5</sup>/<sub>8</sub>"
  - 2"

# WOODLORE® PLUS

## Panel Configurations

### Single Panel

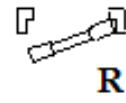
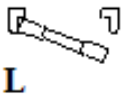

OR

### Two Panels

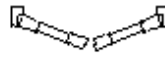

LR



LL



RR

### Three Panels

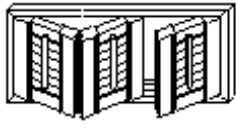

LLR

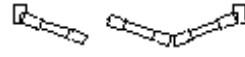

LRR

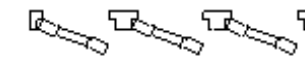
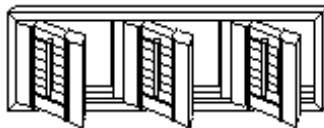

LTLTL

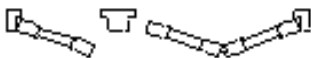
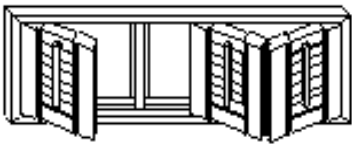

LTRR

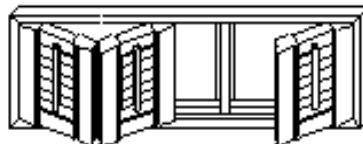

LLTR

# WOODLORE® PLUS

## Panel Configurations (continued)

### Four Panels

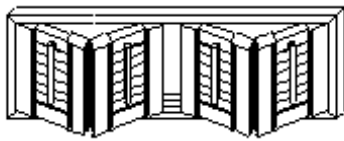

**LLRR**

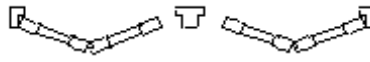
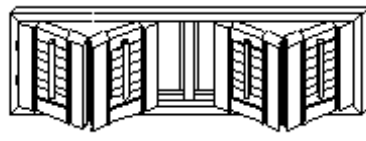

**LLTRR**

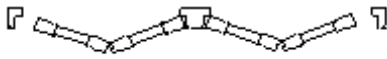
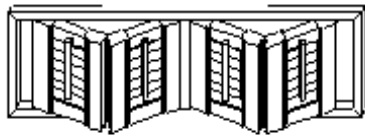

**RRDLL**



**LTLRTR**

### Six Panels

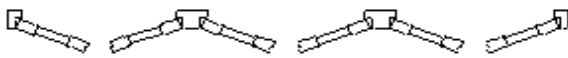

**LRTLRTL**

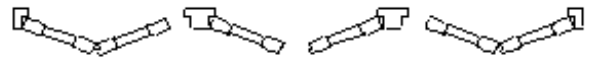

**LLTLRTRR**

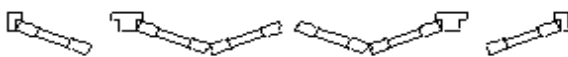

**LTLRRTR**

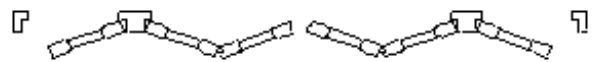

**RTLLRRTL**

# WOODLORE® PLUS

## Panel Configurations - Astragal Stile

- 2 Panels - LR/LL/RR

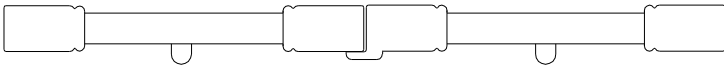

- 3 Panels - LRR

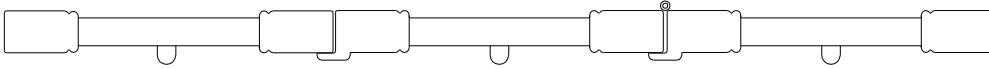

- 3 Panels - LLR

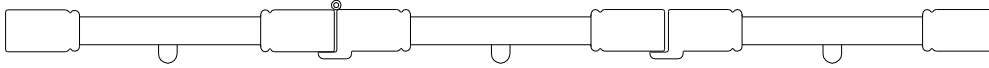

- 4 Panels - LLRR

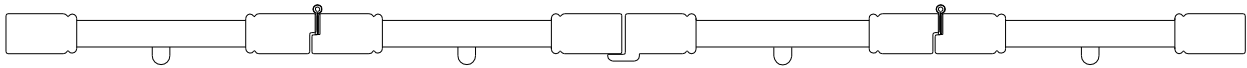

## Frame Styles

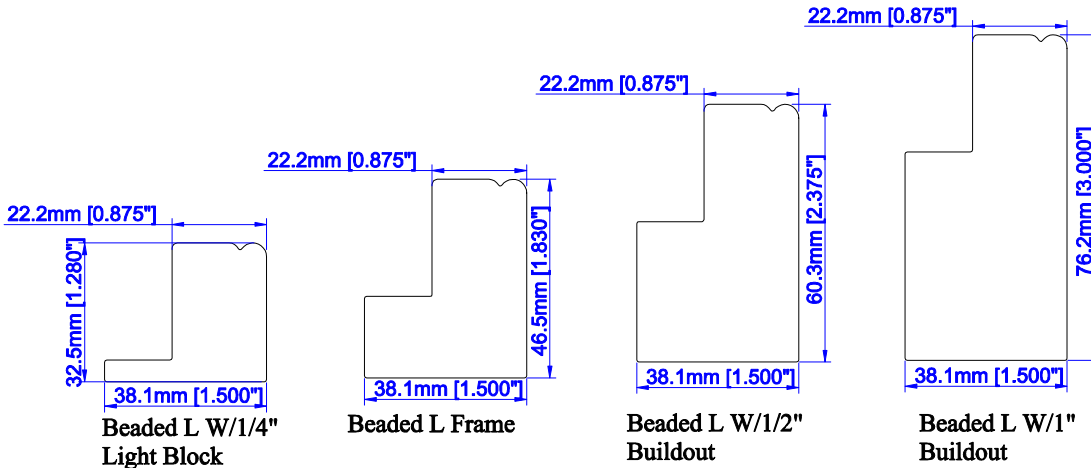

Not available for  
Waterproof option

Not available for  
Waterproof option

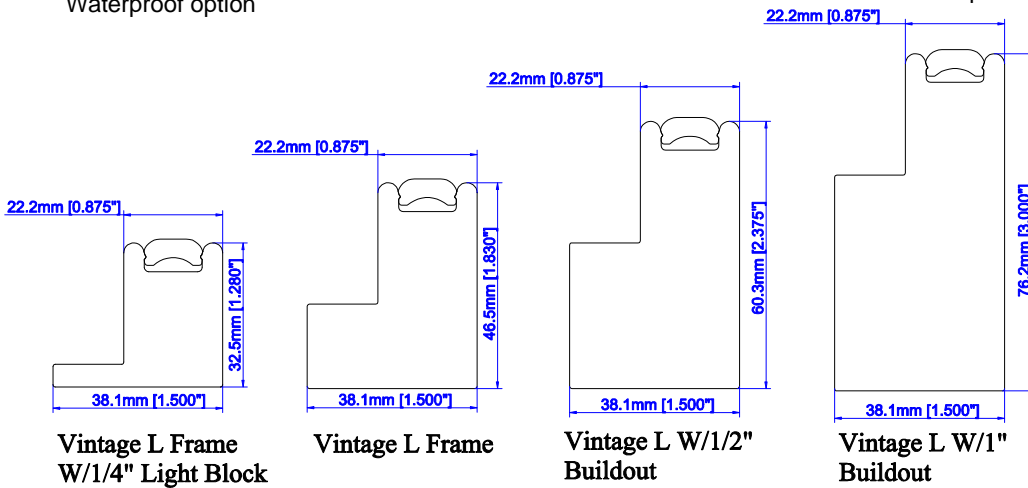

Not available for  
Waterproof option

Not available for  
Waterproof option

Not available for  
Waterproof option

Not available for  
Waterproof option

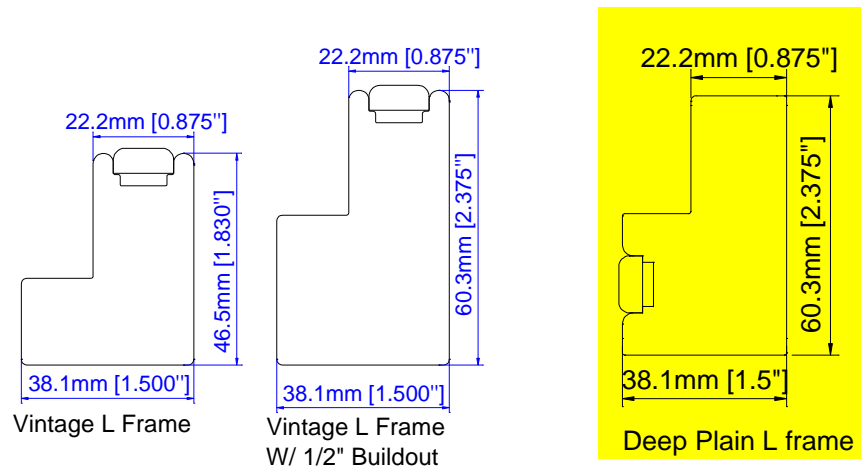

For Waterproof  
option only

For Waterproof option only

For Waterproof option only

# WOODLORE® PLUS

Note: Standard 1" extension for L frame for Waterproof option.

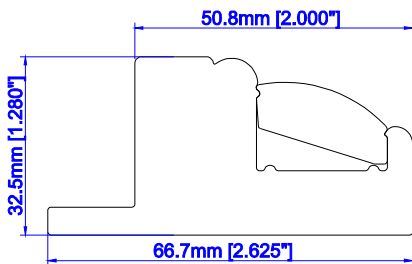

**2" Camber Deco Frame**

Not available for Waterproof option

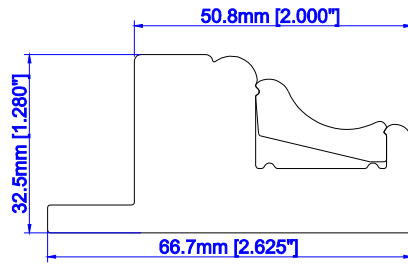

**2" Classic Deco Frame**

Not available for Waterproof option

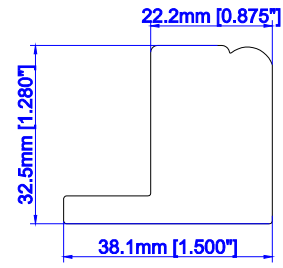

**2" Deco Sill Plate**

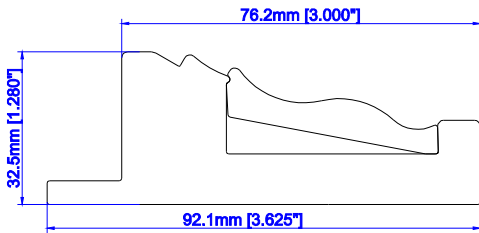

**3" Ridge Deco Frame**

Not available for Waterproof option

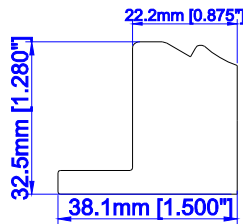

**Ridge Deco Sill Plate**

Not available for Waterproof option

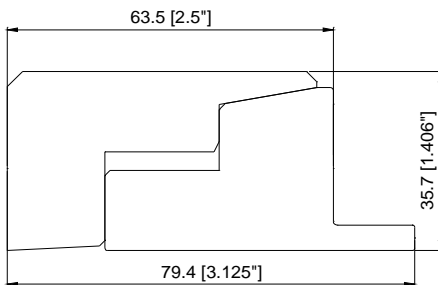

**2.5" Mission Deco Frame**

Not available for Waterproof option

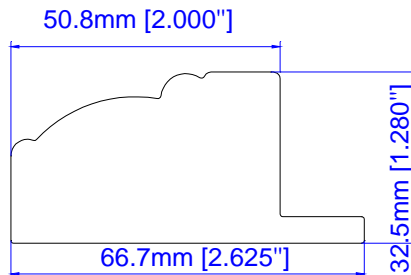

**2" Camber Deco Frame**

For Waterproof option only

There are 2 options for the Deco frame installation when Window Size is given (Take Camber Deco frame as an example)

1. Default: light block part install into the window opening;

The window size is the exact size of the window opening;

The MFF size is the measurement of the entire shutter, including the frames;

The MFF size = Window Size + Face Width

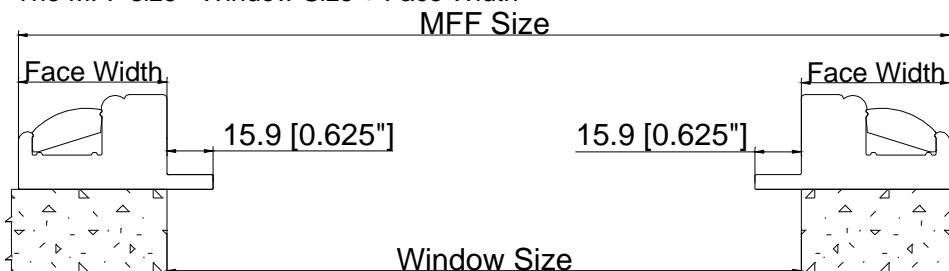

\*Some surcharges apply

# WOODLORE® PLUS

2. Optional: light block part flush with window opening.

The window size is the exact size of the window opening;

The MFF size is the measurement of the entire shutter, including the frames;

The MFF size = Window Size + Frame Back Width

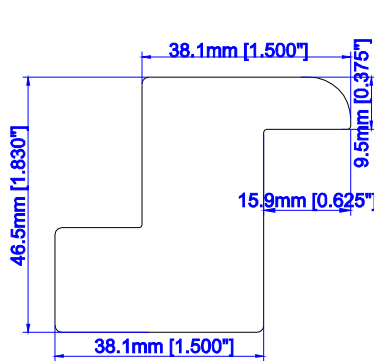

1 1/2" Bullnose Z Frame

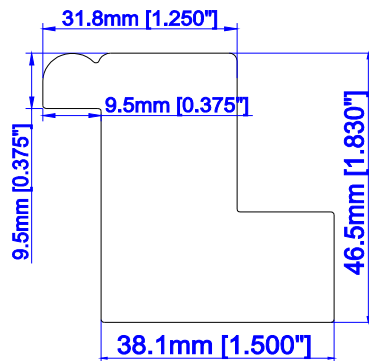

1 1/4" Beaded Z Frame

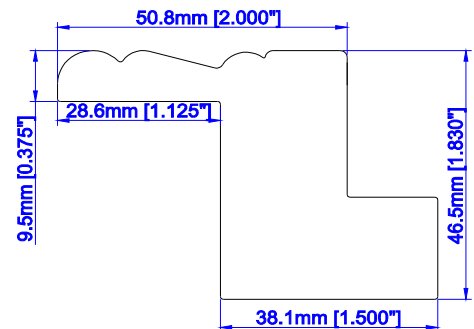

2" Bel Air Z Frame

Not available for Waterproof option

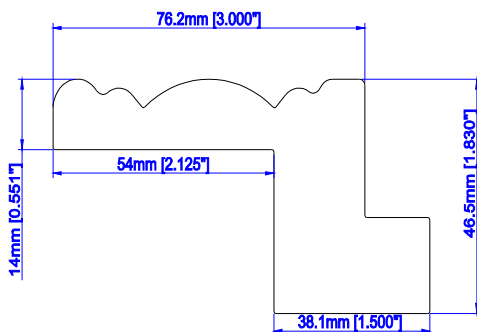

3" Crown Z Frame

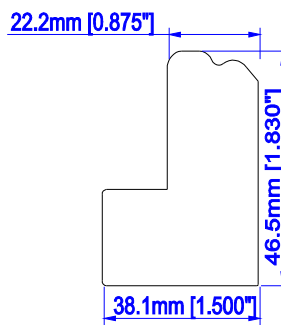

3" Crown Z Sill Plate

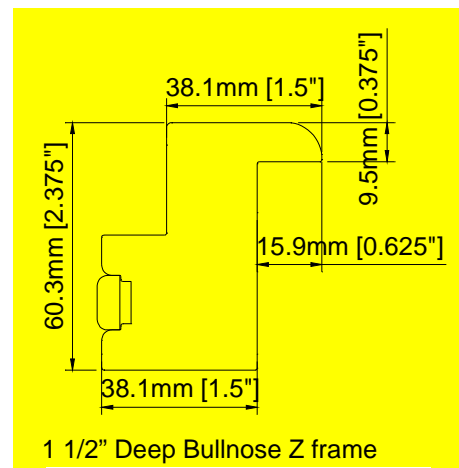

1 1/2" Deep Bullnose Z frame

For Waterproof option only

\*Some surcharges apply

# WOODLORE® PLUS

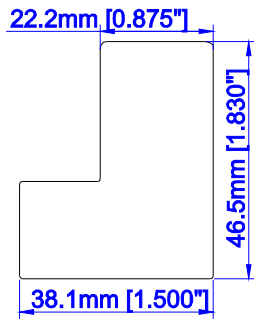

**Bullnose Z  
1 1/4\"/>Sill Plate**

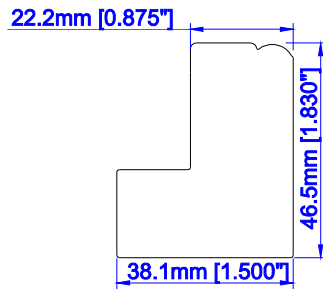

**2\"/>Bel Air Z Sill Plate**

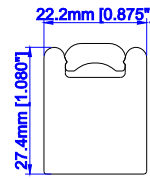

**Vintage Hang Strip**

Not available for  
Waterproof option

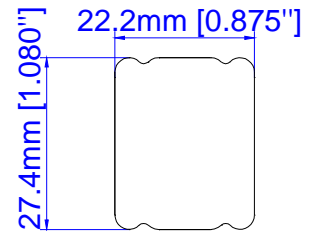

**Traditional Hang Strip**

For Waterproof option only

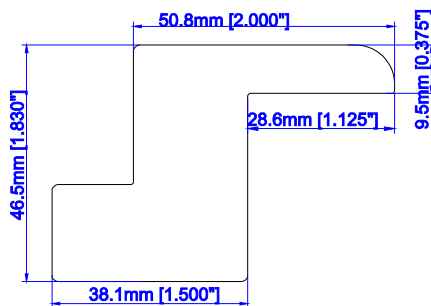

**2\"/>Bullnose Z Frame**

Not available for Waterproof option

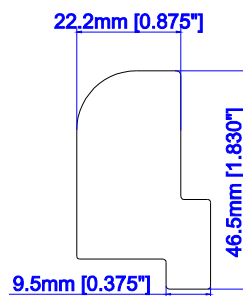

**Tilt Out Z Frame**

Not available for Waterproof option

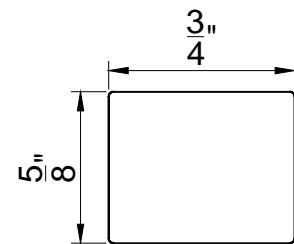

**Light Block**

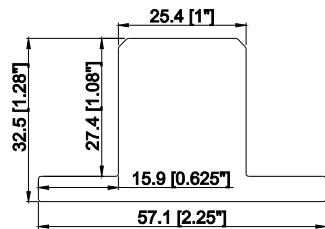

**1\"/>Chamfer T Post W/ 1/4\"/>Light Block (Deco)**

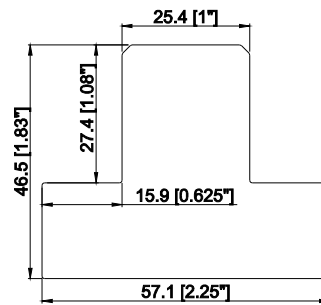

**1\"/>Chamfer T Post W/ 3/4\"/>Light Block (L/Z/HS)**

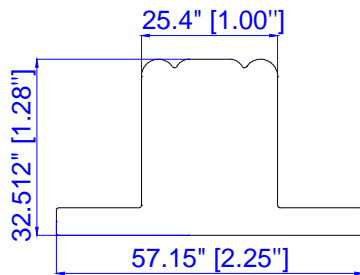

**1\"/>T Post W/ 1/4\"/>Thick Light Block (Deco)**

For Waterproof option only

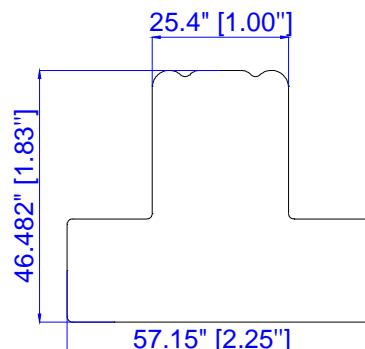

**1\"/>T Post W/ 3/4\"/>Thick Light Block (L/Z/HS/Direct Mount)**

For Waterproof option only



# WOODLORE® PLUS

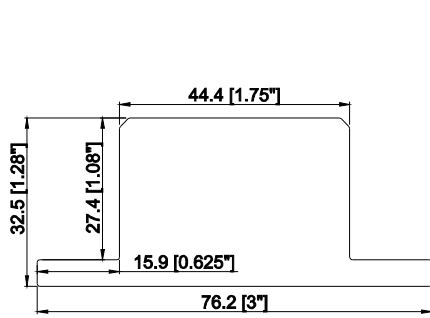

**1.75" Chamfer T Post (Deco)**

Not available for Waterproof option

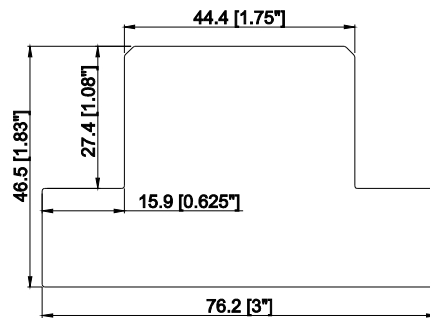

**1.75" Chamfer T Post (LZ/HS)**

Not available for Waterproof option

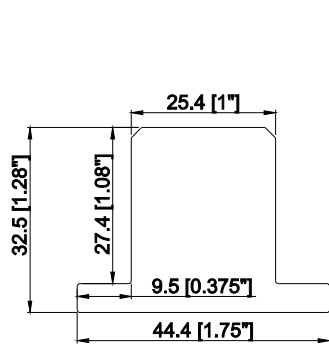

**1" Chamfer T Post W/ 1/4" Thick  
3/8" Wide Light Block (Deco)**

Not available for Waterproof option

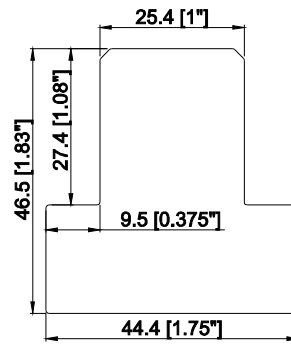

**1" Chamfer T Post W/ 3/4" Thick  
3/8" Wide Light Block (LZ/HS)**

Not available for Waterproof option

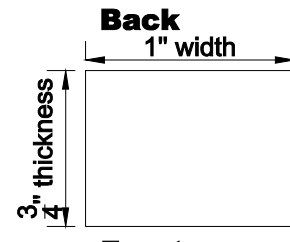

**1" \* 3/4" Post (No light block)**

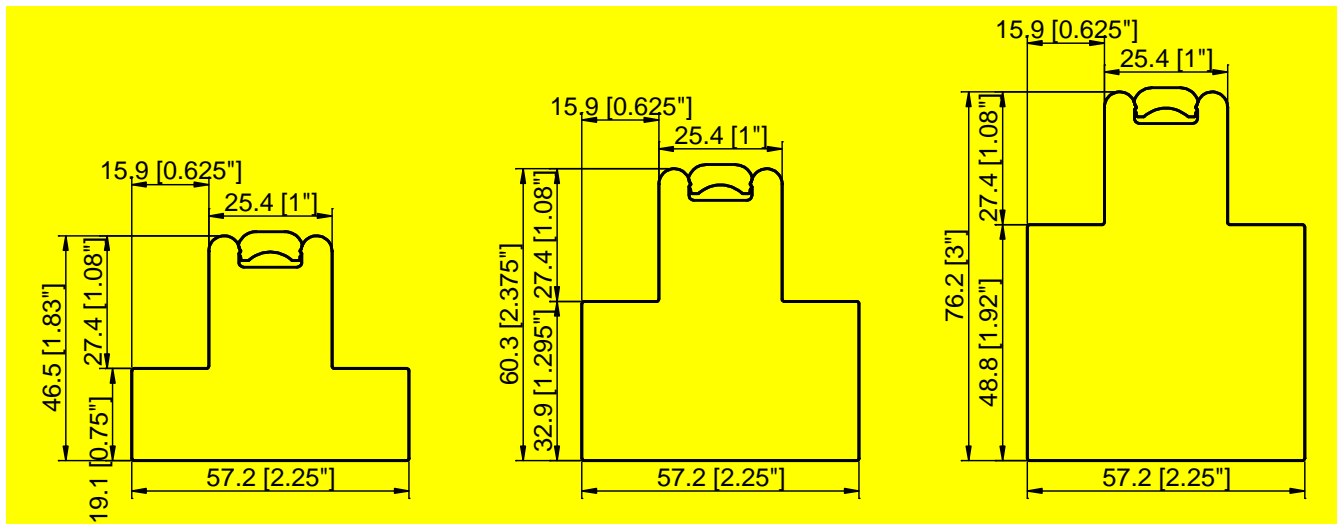

**1" T Post with Insert  
w/ 3/4" Light Block**

Not available for Waterproof option

**1" T Post with Insert  
w/ 1 5/16" Light Block**

Not available for Waterproof option

**1" T Post with Insert  
w/ 1 15/16" Light Block**

Not available for Waterproof option

○ Custom width\* up to 7½ "for T Posts (Made of Wood), and not available for Waterproof option

▪ Size limits (7 1/2")

▪ Available for composite but it will be made from wood for non-Waterproof option;

\*Some surcharges apply

# WOODLORE® PLUS

- That a surcharge applies and customers should refer to their shutter pricing
- Any limitations

Note: The 1"x3/4" Post (No Light Block) is only available for Direct Mount. And no hardware will be supplied to install it on the existing window opening.

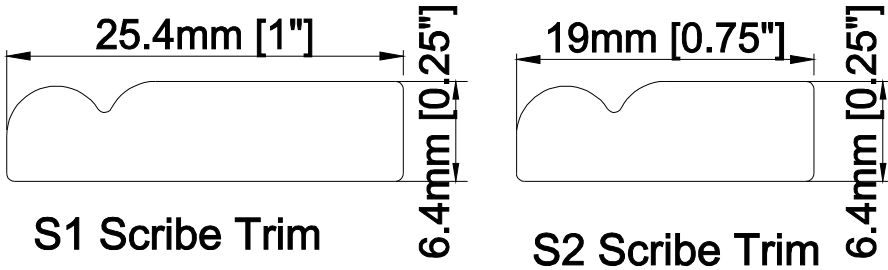

Note: S1&S2 Scribe Trim will be made of wood for non-Waterproof option;  
S1&S2 Scribe Trim will be made of Woodlore plus waterproof for Waterproof option.

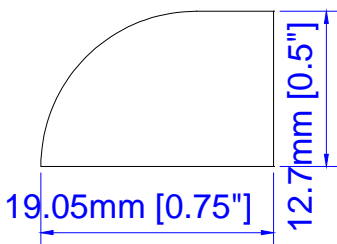

Quarter Round  
Scribe Trim

Not available for Waterproof option

Note: Quarter Round Scribe Trim will be made in Wood for non waterproof option.

## Sill Frames- For use where there is no existing sill

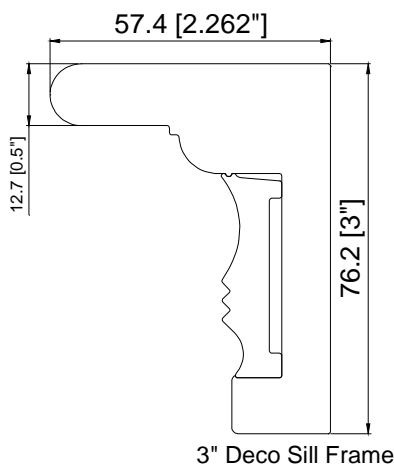

Not available for Waterproof option

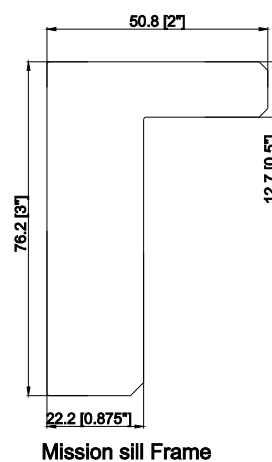

Not available for Waterproof option

\*Some surcharges apply

# WOODLORE® PLUS

## Sill caps-Used to cover existing sills

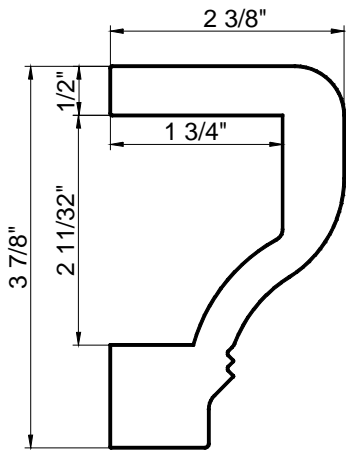

Curved Designer Sill Cap (L)

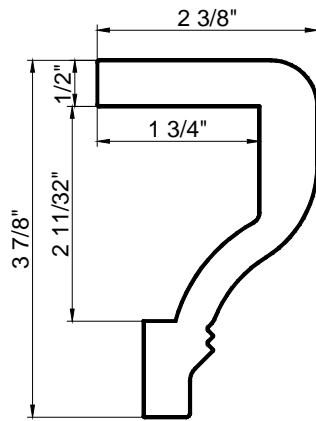

Curved Designer Sill Cap (D/HS)

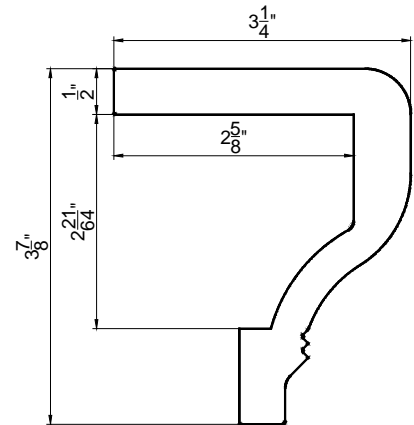

Curved Designer Sill Cap (Z)

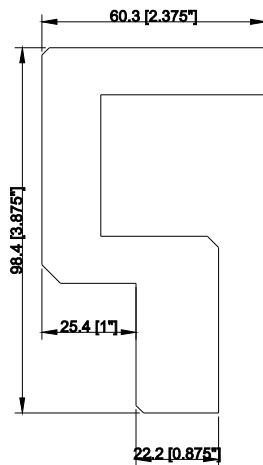

Mission Sill Cap (D/HS)

Not available for  
Waterproof option

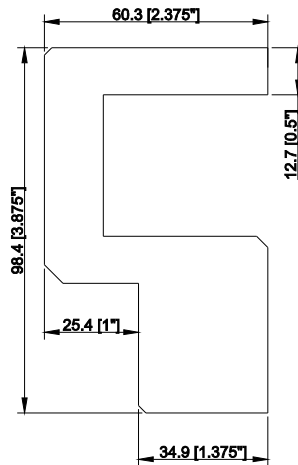

Mission Sill Cap (L)

Not available for  
Waterproof option

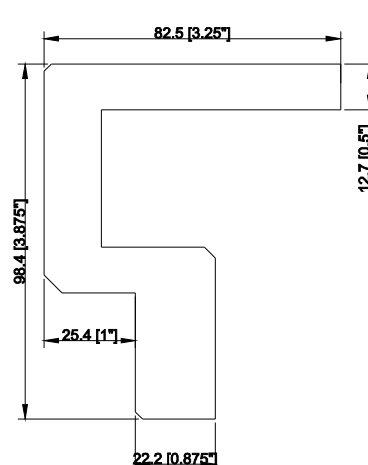

Mission Sill Cap (Z)

Not available for  
Waterproof option

Note: For Mission Sill Cap, the extended size at each side needs to be 1" at least.

## Sill Plates- Used with existing sills

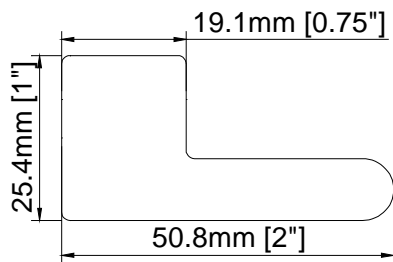

2" Sill Plate with 5/8"  
Light Block (L/Z)

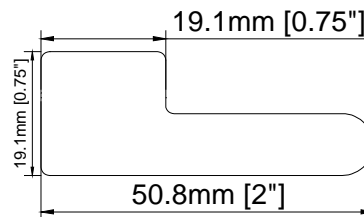

2" Sill Plate with 3/8"  
Light Block (L/Z)

# WOODLORE® PLUS

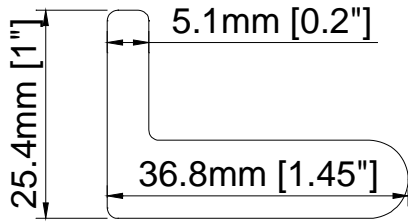

1.5" Sill Plate with 5/8" Light Block (Camber Deco)

For Waterproof option

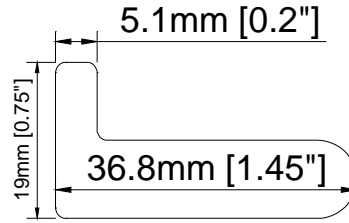

1.5" Sill Plate with 3/8" Light Block (Camber Deco)

For Waterproof option

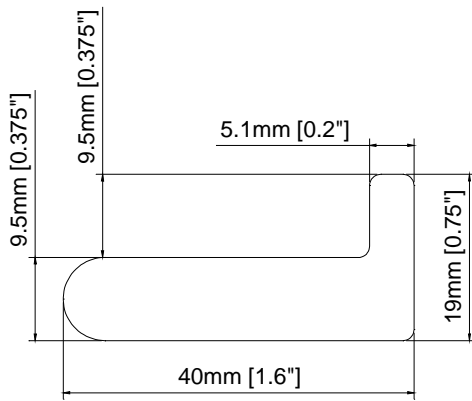

1.6" Sill plate with 3/8" light block

(All Deco & L frames with 1/4" light block) - For Non-waterproof option

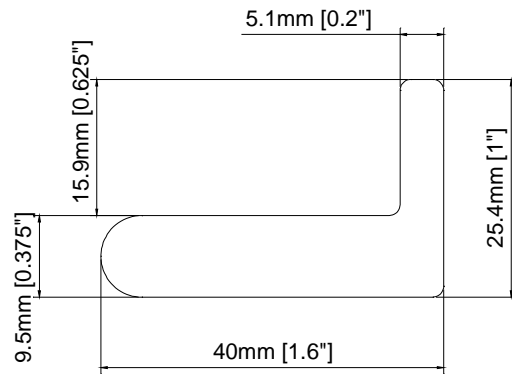

1.6" Sill plate with 5/8" light block

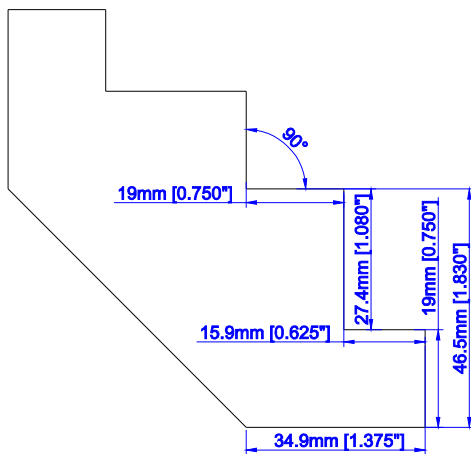

Corner Post W/ 3/4" Light Block (L/Z/HS)

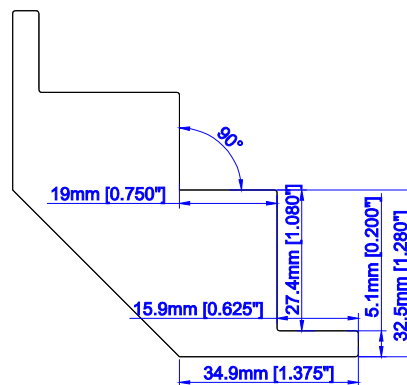

Corner Post W/ 1/4" Light Block (Deco)

\*Notch out corner post required if ordering Z Frame with solid drywall corner.

\*Some surcharges apply

# WOODLORE® PLUS

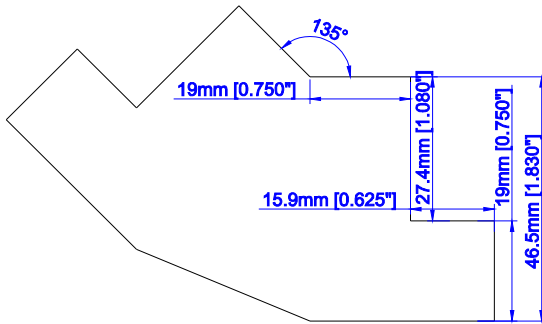

Bay Post W/ 3/4"  
Light Block (L/Z/HS)

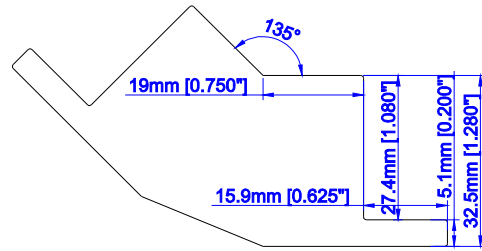

Bay Post W/ 1/4"  
Light Block (Deco)

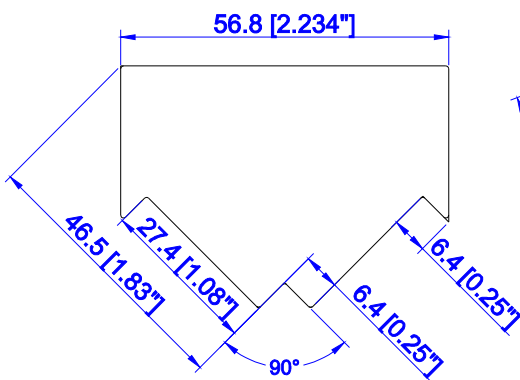

Slim Fit Corner Post for  
90 Degree (L/Z/HS)

Not available for Waterproof option  
Not available for Waterproof option

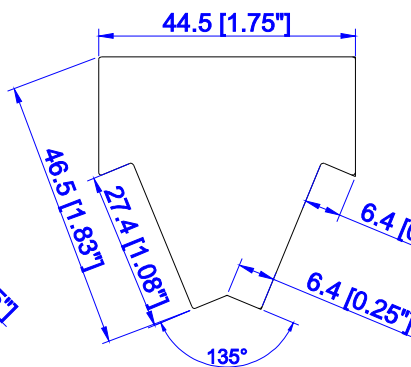

Slim Fit Bay Post for  
135 Degree (L/Z/HS)

Not available for Waterproof option  
Not available for Waterproof option

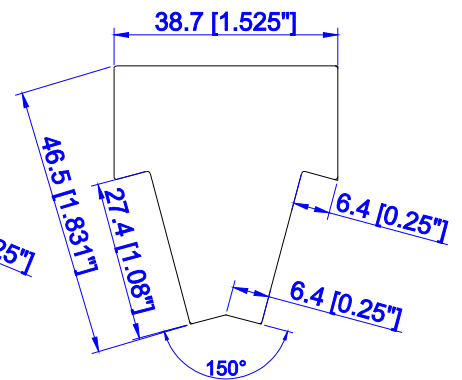

Slim Fit Bay Post for  
150 Degree (L/Z/HS)

Not available for Waterproof option  
Not available for Waterproof option

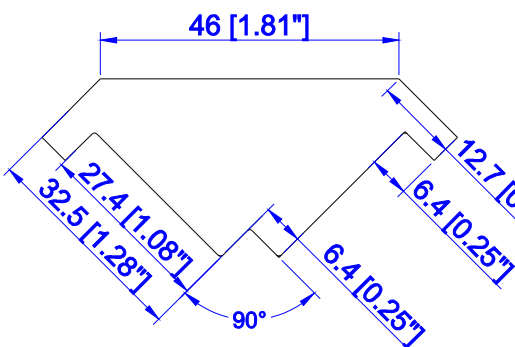

Slim Fit Corner Post for 90 Degree (D)

Not available for Waterproof option

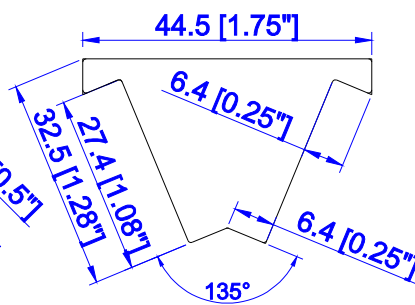

Slim Fit Bay Post for 135 Degree (D)

Not available for Waterproof option

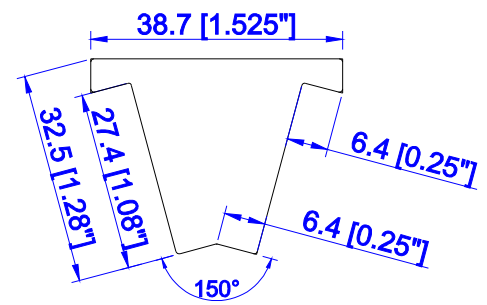

Slim Fit Bay Post for 150 Degree (D)

Not available for Waterproof option

**Note:** Due to size and weight limitations, Slim Fit Posts may only be hinged on one side and with a single panel (no bi-folded panels). Please consider this when determining panel configuration.

Also available

- Custom angle bay posts\* (Made of Wood for non-Waterproof and Made of ABS for Waterproof option).

\*Some surcharges apply

# WOODLORE® PLUS

## For bay window at 170 degree or above

- 1" T Post with 3/8" light block will be used as Bay post;
- For Hang Strip (Behind Panel) and Waterproof option, bay post will be used.

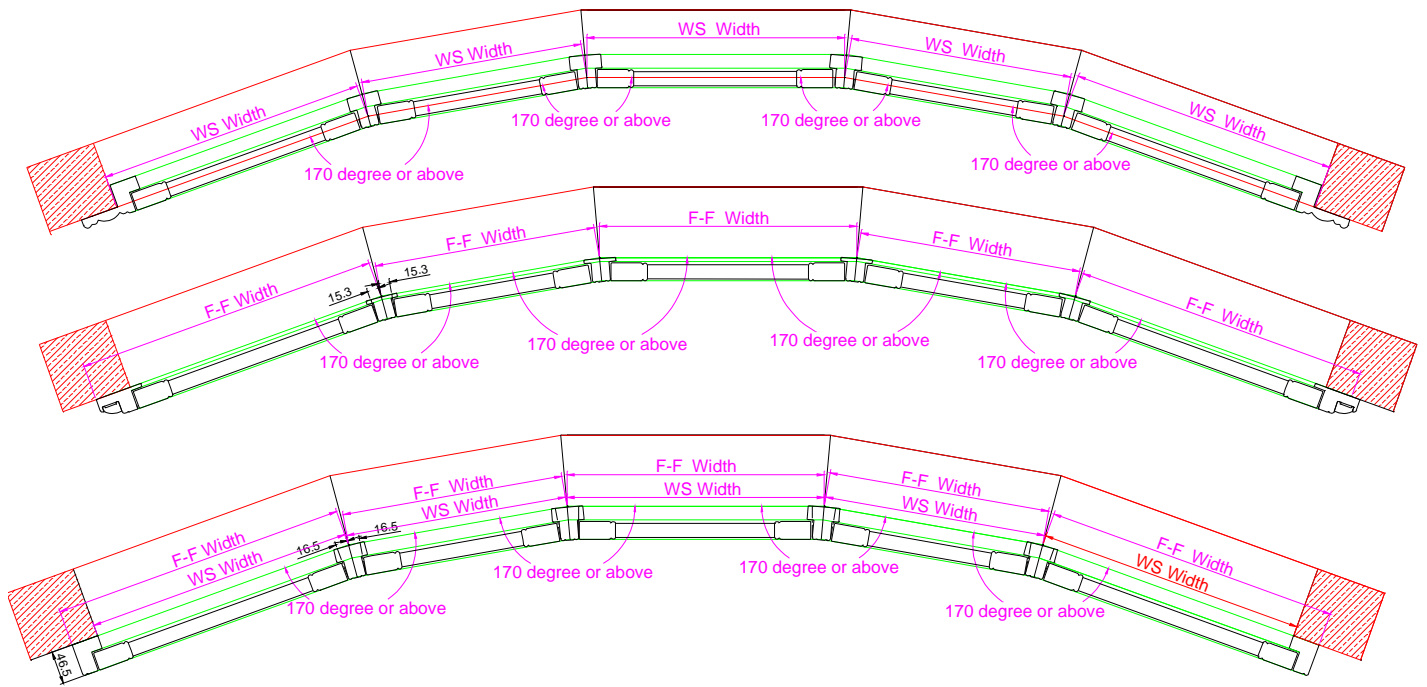

## Pre-drill L Frames (Inside Mount Only) or Z frames:

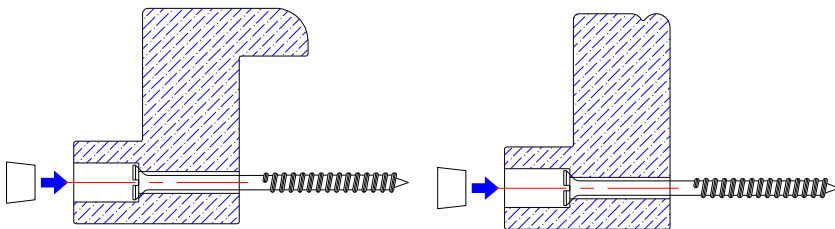

## Extension for Deco Frame\* (Default to have full extension):

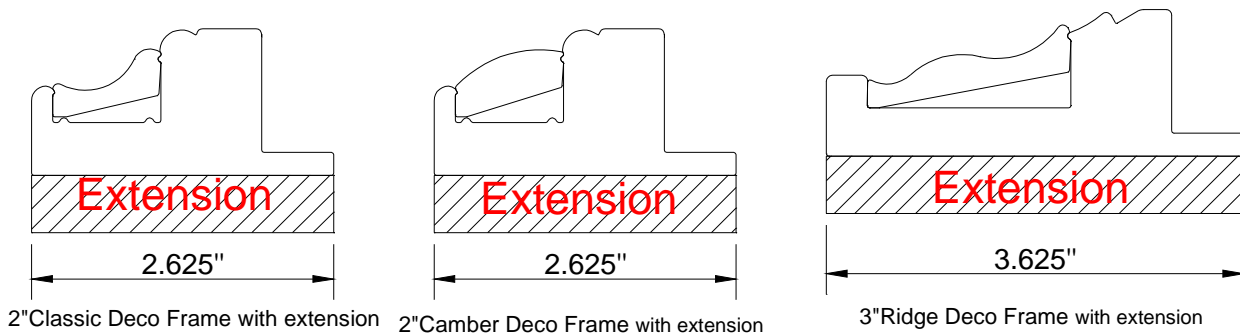

Note: When the extension thickness of the frame & T post is more than 2", the extension will not be attached with the frame and T post.

\*Some surcharges apply

# WOODLORE® PLUS

Notch out\*:

- L Frame
- T Post

Specify dimensions in special instruction box.

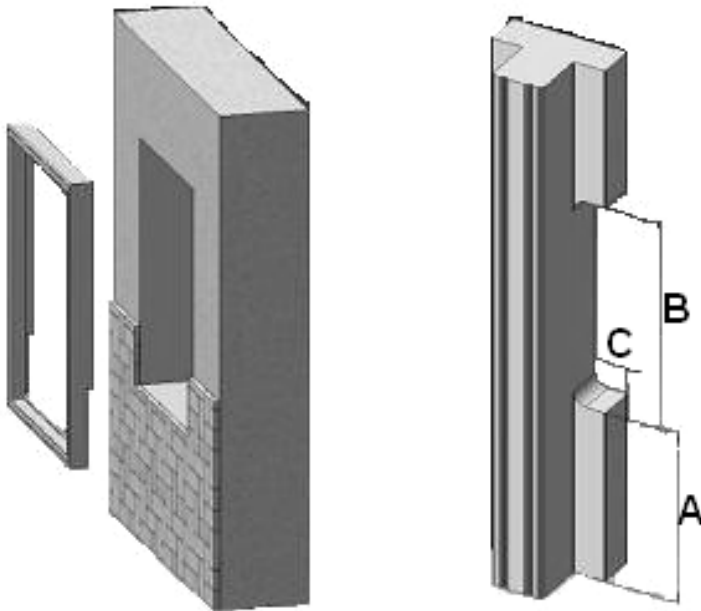

## Default principles:

1. The coordinating T-post for 1 1/2" Deep Bullnose Z frame & Deep Plain L frame will be 1" Chamfer T post W 1/4" light block (Deco) or 1" T post W 1/4" light block (Deco), T-post light block depth more than 1/4" is not available.
2. 1 1/2" Deep Bullnose Z frame & IM Deep Plain L frame will **NOT** be pre-drilled unless Pre-drilled "Yes" was specified in the order.

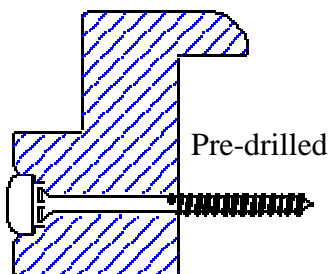

1 1/2" Deep Bullnose Z frame

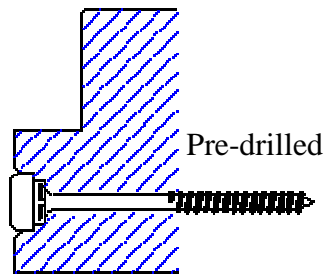

Deep Plain L frame

3. OM Deep Plain L frame will **NOT** be pre-drilled.

\*Some surcharges apply

# WOODLORE® PLUS

## 4. Regarding shutter with horizontal T-post type issue:

1). If Woodlore Plus-Waterproof with **Beaded** vertical T-post is selected, the horizontal T-Post type will be a Beaded T post; Otherwise, horizontal T-Post type will always be Chamfer T post by default.

2). For Woodlore Plus-non Waterproof, Horizontal T-Post type will always be the Chamfer T post unless otherwise specified.



# WOODLORE® PLUS

## General Product Specifications

<u>Description</u>	<u>Minimum</u>	<u>Maximum</u>	
		<u>Non-Waterproof Option</u>	<u>Waterproof Option</u>
Single Panel Width (Regular)	6"	24" for 1 7/8" louver 36" for 2 1/2", 3", 3 1/2", 4 1/2" louver	24" for 1 7/8" louver 31" for 2 1/2", 3" louver 36" for 3 1/2", 4 1/2" louver
Single Panel Width (Bifold)	6"	24"	24"
Single Panel Width (Bifold Track)	6"	24"	24" for 1 7/8" louver 26" for 2 1/2", 3", 3 1/2", 4 1/2" louver
Single Panel Height	10"	120"	
Shutter Width (Without T Post)	N/A	4x single panel width (bifold) + frame	
Shutter Width (With T Post)	N/A	Unlimited <b>(For orders shipped by sea, frames longer than 142" will be spliced in the middle. For orders shipped by air, frames longer than 120" will be spliced in the middle.)</b>	
Shutter Height	N/A	120" + frame	

### Shutters without bottom supports

Shutters without bottom supports may sag and deform, including situations below:

1. Shutters with bottom gap over 0.1";
2. Shutters with no frame or no existing sill at the bottom to support the panel (or bottom has frame/existing sill, but the panel keep to open long time without bottom support).

Therefore, we strongly discourage the use of shutters for this application. We will continue to manufacture these shutters; however, they will not be covered under our warranty and will be subject to the guidelines listed below:

### All Woodlore plus panel configurations:

- You must inform Norman Window Fashions of situations where shutters will not have bottom support when placing the initial order.
- Informing Norman when placing such orders ensures that the factory will add extra hinges to support the panel. This will reduce the probability of the panels sagging and increase shutter integrity. You must release Norman Shutters from liability in these situations.
- If you fail to notify Norman that the shutter will be used without bottom support, this will constitute a misapplication of the shutter. Consequently, you will be responsible for the cost of any RGA that is submitted.
- If you want a bifold shutter, a track must be ordered to support the panels. Without a track, Norman will not manufacture the order even with liability waived.

# WOODLORE® PLUS

## Tilt Rods

### Standard Tilt Rod

**Default Location:** In the middle of the panel on front side (default).

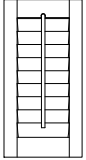

### Offset Tilt Rod

**Default Location:** On the front side of the panel and at 1" from the louver ends on the hinged side.

**Optional location:** per your request

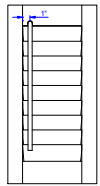

### InvisibleTilt™ \*

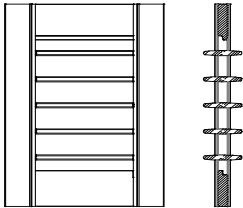

Louver tilting system embedded within panel stile. It is not available for 1<sup>7</sup>/<sub>8</sub>" louver. The tilting system is split when the number of louvers exceeds the limits as listed below:

Louver Size	Maximum Possible Louvers	Panel Height Range
2½"	24	54 ¾" – 57 ¼"
3"	19	54 ¼" – 57"
3½"	16	54 ¾" – 58"
4½"	12	54 ¾" – 60"

For even numbers of louvers, the number of louvers operated by the top and the bottom tilting system will be the same;

For odd numbers of louvers, the number of louvers operated by the bottom tilting system will be one more than the number of louvers operated by the top tilting system;

To ensure split tilt is included, always specify on the order.

### Split Tilt

When selected, the louvers are split evenly by default unless a custom location is requested.

When the customer selects a custom location, the measurement will be as follows (please note that the louvers are in the closed position when measured):

\*Some surcharges apply

# WOODLORE® PLUS

## Window size:

- Measure from the bottom of the window to the top of the louver

## Max frame-to-frame:

- Measure from the bottom of the frame (or panel if there is no bottom frame, sill or sill cap) to the top of the louver.

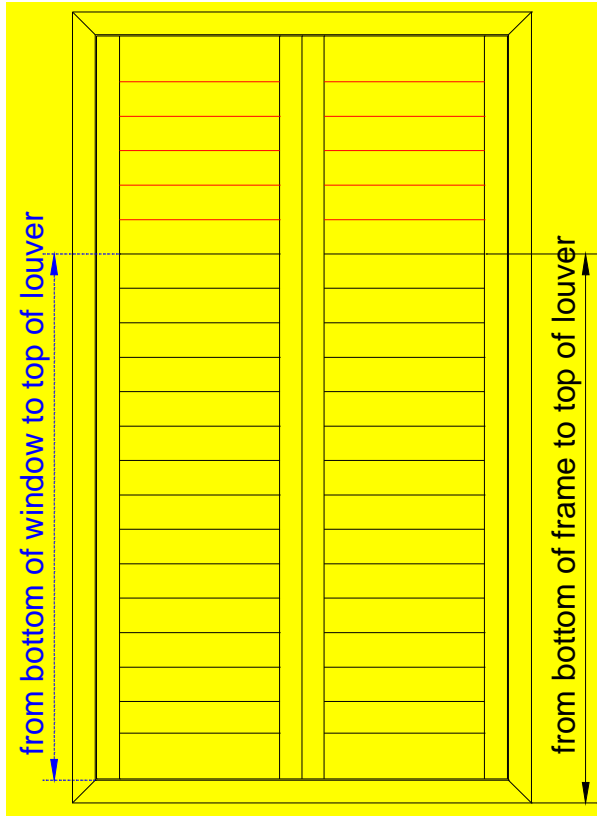

## Split tilt allowable deviations

Louver Size	Allowable ± Deviation
1 7/8"	3/4"
2 1/2"	1"
3"	1 1/4"
3 1/2"	1 1/2"
4 1/2"	2"

## Split Location:

- Per the customer's specification. However, the location of the top louver of the bottom split section may be adjusted to achieve more balanced top and bottom rails when **allow deviations** is selected during order entry. If necessary the location will be moved up from the desired height to ensure any obstruction is covered. The amount of the deviation from the desired height will depend on the size of the louver selected.

If the exact location of the split is critical, customer may select **exact location** in the order entry system when placing the order. This may result in significantly different top and bottom rails. When exact location is selected, a popup will reveal the resulting top and bottom rails measurements from which the customer may either:

1. Accept the listed top and bottom rail sizes
2. Modify the split location (sometimes a slight adjustment in the exact split location may achieve desired top and bottom rail sizes)
3. Change to **allow deviations** so the system will calculate the split location

**Note:** Top and bottom rail sizes may change if the current line item is being matched with another line item. Carefully review all top and bottom rail sizes and split locations to ensure a desirable look is achieved

\*Some surcharges apply

# WOODLORE® PLUS

## Divider Rails

- A divider rail is an extra rail in the middle of the panel.
- Creates two sections in the panel so louvers can be operated independently.
- Strengthens the panel and enhances structural integrity.
- Required for panel heights over 78" for non-waterproof option.
- Required for panel heights over 72" for waterproof option.

### Specifications

- Standard width: 3"
- Default location: center of the panel unless specified otherwise

### Measurements:

- Window size:
  - Measure from the bottom of the window to the center of the divider rail.
- Max frame-to-frame:
  - Measure from the bottom of the frame to the center of the divider rail.
- Position:
  - Per customer's specification. However, the divider rail may be adjusted to a lower or higher position, within our allowable deviation, to ensure reinforcement and aesthetics of the shutter.

When placing the order, please clearly specify if the divider rail position needs to line up with that of other shutter divider rails in the same room. Please also refer to the table below for the allowable deviation details.

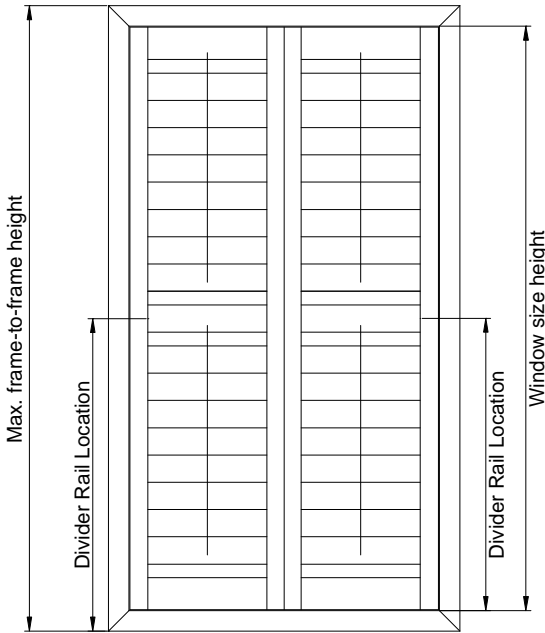

### Divider rail allowable deviations

Louver Size	Allowable + Deviation
1 7/8"	3/4"
2 1/2"	1"
3"	1 1/4"
3 1/2"	1 1/2"
4 1/2"	2"

# WOODLORE® PLUS

## Hardware

### Hinges

Self-Mortise Hinge

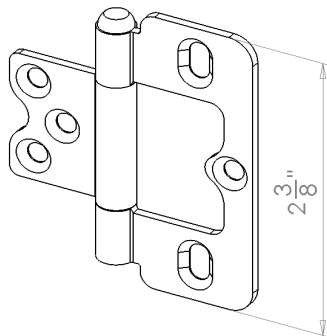

Bi-fold Hinge

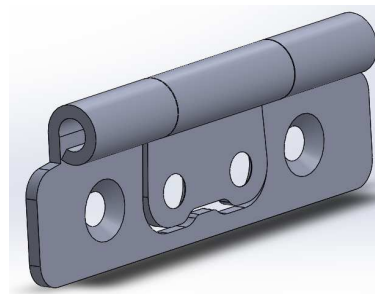

L Hinge

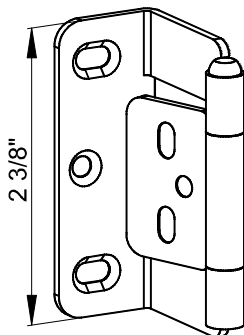

Direct Mount 3" Hinge

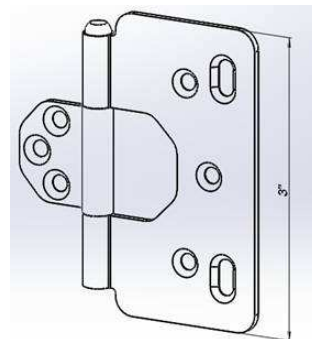

Hinges are available in:

Pure White, Silk White, Bisque, Pearl, Bright Brass, Antique Brass, Black, Nickel plated, Brushed Nickel, Stainless Steel\*, Crisp Linen, String, Sea Mist, Stone Gray, Brown Gray, Taupe Gray.

While hinge colors of Crisp Linen, String, Sea Mist, Stone Gray, Brown Gray, Taupe Gray are not available for Direct mount 3" Hinges.

For Waterproof option, hinge color is only available in Stainless Steel, and Sleeve & Base Plate will be used as catches.

\*Some surcharges apply

WLP i-1

# WOODLORE® PLUS

## ➤ Direct Mount 3" Hinge:

1. The hinge position of the direct mount 3" hinge will be different from that of the 2.375" ones. For shutters used both the 2.375" and the direct mount 3" hinge, the hinge position of the 2.375" ones will match that of the direct mount 3" hinge;
2. The hinge is only to install between the panel and the existing window. For other situation, 2.375" hinges will be used;
3. To avoid conflict, there will be cut-out for the light block of the hinged side. Please refer to the drawing below.

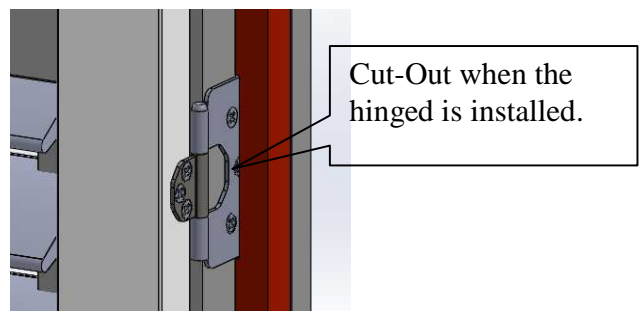
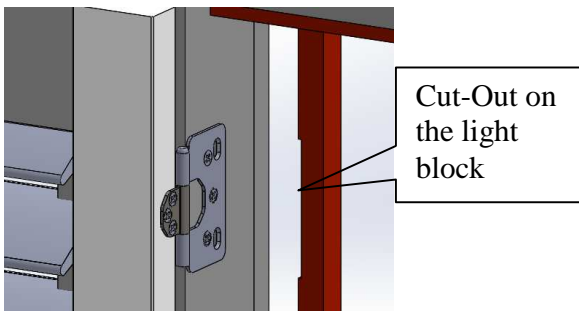

## 4. Direct Mount 3" Hinge is not suitable for drywall installations.

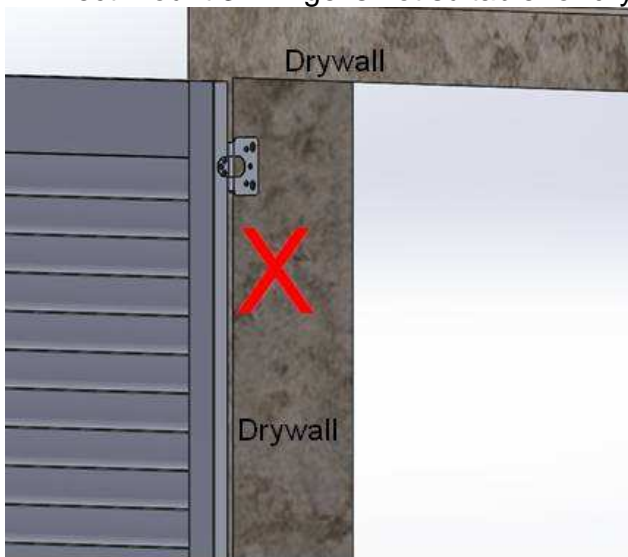

Direct Mount 3" hinge is not suitable for drywall installations.

**It's not recommended.**

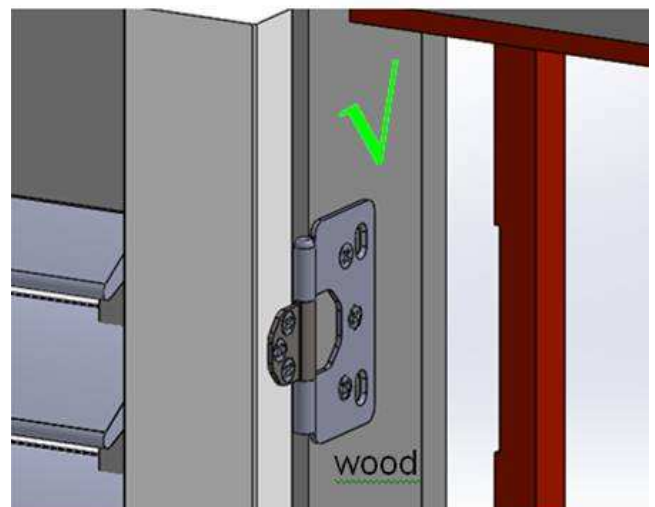

**It's acceptable.**

# WOODLORE® PLUS

## Invisible Hinge\*:



1. Invisible hinge is not available for Multifold panels.
2. Invisible hinge can only be between the panel & frame/T post, connections from panel to panel will use a regular hinge.
3. Color Option: Only available for Pearl Chrome Plated.

Frame Options	Hinge	Notes
2" Camber Deco Frame	Y	/
2" Classic Deco Frame	Y	/
2.5" Mission Deco Frame	N	/
3" Ridge Deco Frame	N	/
Vintage L Frame W / 1/4" Light Block	N	/
Vintage L	N	/
Vintage L Frame w/ 1/2" Buildout	N	/
Vintage L Frame w/ 1" Buildout	N	/
Beaded L w 1/4"light block	Y	/
Beaded L	Y	/
Beaded L Frame w/ 1/2" Buildout	Y	/
Beaded L Frame w/ 1" Buildout	Y	/
Tilt out Z Frame	N	/
1.25" Beaded Z Frame	Y	/
2" Bullnose Z Frame	Y	/
1.5" Bullnose Z Frame	Y	/
2" Bel Air Z Frame	Y	/
3" Crown Z Frame	N	/
7/8" Vintage Hang Strip	N	/
Traditional Hang Strip	Y	/

\*Some surcharges apply

# WOODLORE® PLUS

1" T-Post w/ 1/4" Light Block(for Deco)	Y	only available with hinge on one side, for example, LTL is available, but RTL is not.
1" T-Post w/3/4" Light Block(for L/Z/HS)	Y	
1" Chamfer T-Post w/ 1/4" Light Block(for Deco)	Y	
1" Chamfer T-Post w/3/4" Light Block(for L/Z/HS)	Y	
1" Chamfer T-Post w/ 1/4" thick 3/8" wideLight Block(for Deco)	Y	
1" Chamfer T-Post w/3/4" thick 3/8" wide Light Block(for L/Z/HS)	Y	
1 3/4" Chamfer T-Post w/1/4" Light Block(for Deco)	Y	available with hinge on BOTH side, for example, RTL.
1 3/4" Chamfer T-Post w/3/4" Light Block(for L/Z/HS)	Y	
Corner Post w/1/4" Light Block(for Deco)	Y	/
Corner Post w/3/4" Light Block(for L/Z/HS)	Y	/
Bay Post w/1/4" Light Block(for Deco)	Y	/
Bay Post w/3/4" Light Block(for L/Z/HS)	Y	/

## Invisible Hinge Qty:

Panel Height (H)	Hinge Qty
H<=48"	2
48"<H<=78"	3
78"<H<=96"	4
96"<H<=120"	5

## Preinstallation:

Panels and frames will be packaged individually, and the hinge is preinstalled onto the frame/post, with the screws for the other half part on the panels in the hardware box.

## Panel Lock: (not available for 1.625" Stile)

**Available Material: All**

**Color: Brush Nickel Plated**

\*Some surcharges apply



# WOODLORE® PLUS

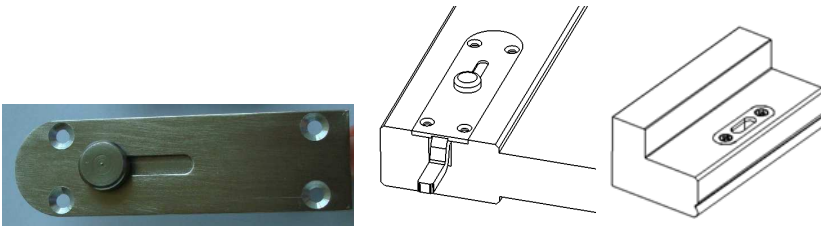

**Position: (Only available on Bottom for Track Shutters with Bottom Track; For Regular, available on Top/Bottom/both Top and Bottom)**

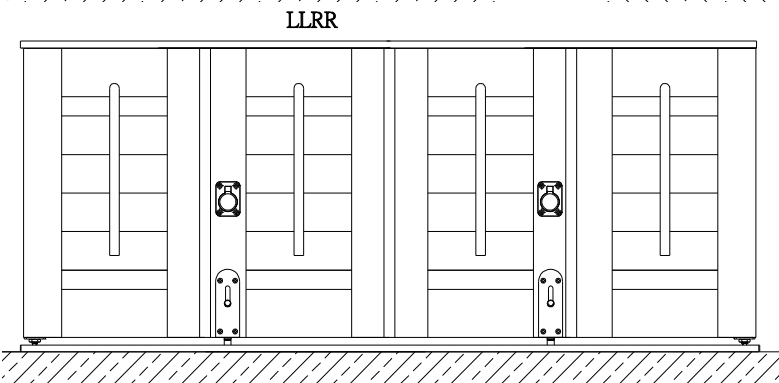
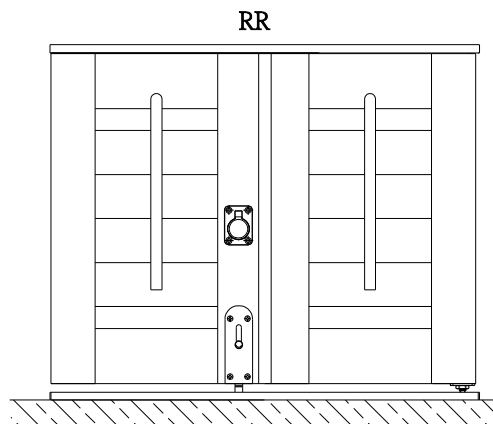
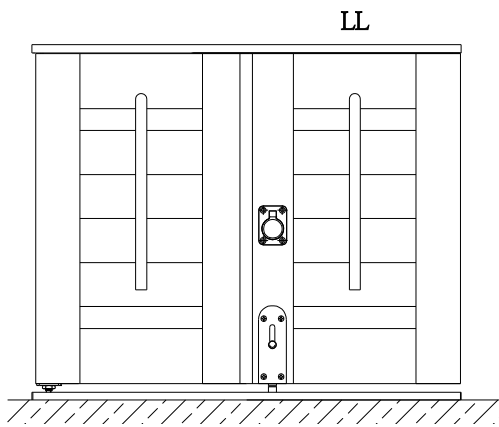
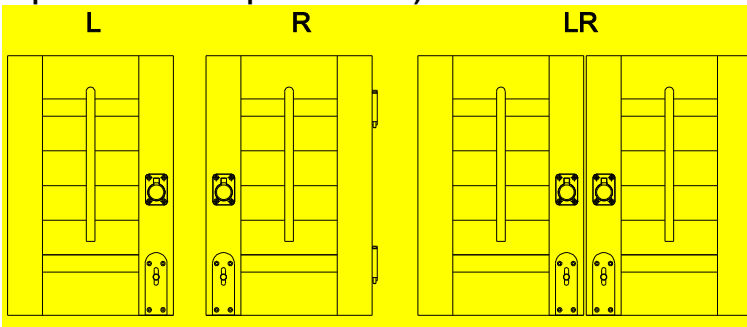

The Panel Lock location for both track system shutters and regular shutters would be the same. The general principle is that the Panel Lock position will avoid the stile which will install the spring-loaded guide at bottom (same stile as the Wheel carrier).

\*Some surcharges apply

# WOODLORE® PLUS

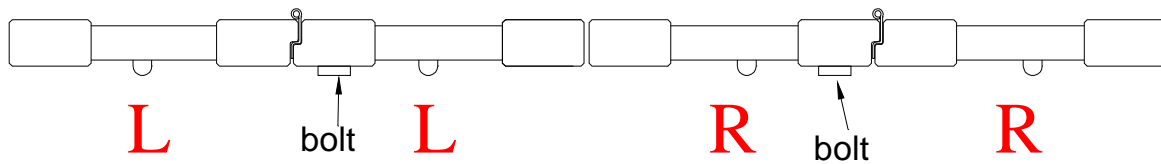

**Ring pull:** for easy opening and closing

(Not available for 1.625" Stile)

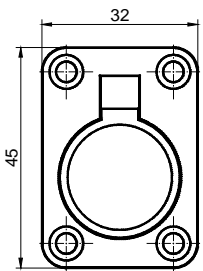

## Ring pull location principle for Floating Panels:

1. When floating panel config is in pairs, it will be split into halves, the left will be for LL and the right will be for RR. So the ring pull location for FF/FF, FF/FF/FF/FF will be same as that of panel config as LL/RR, LL/LL/RR/RR.
2. When floating panel config is FF, the ring pull location will be same as that of panel config LL.
3. When floating panel config is singular, it will be split into 3 sections, the left and mid sections are for LL and the right section is for RR. So the ring pull location for FF/FF/FF, FF/FF/FF/FF/FF will be same as that of LL/LL/RR, LL/LL/LL/RR/RR.

Please note the ring pull color will match with the hinge color.

When shutter order with Invisible Hinge, the ring pull color will match with the normal hinge color.

Please see the matching chart below:

Hinge color	Pure White	Silk White	Bisque	Pearl	Black	Nickel Plated	Brushed Nickel	Antique Brass	Bright Brass	Stainless Steel
Ring Pull color	White	White	Bisque	Pearl	Black	Brushed Nickel	Brushed Nickel	Antique Brass	Bright Brass	Brushed Nickel

Hinge color	Crisp Linen	String	Sea Mist	Stone Gray	Brown Gray	Taupe Gray
Ring Pull color	Bisque	Bisque	Brushed Nickel	Brushed Nickel	Brushed Nickel	Brushed Nickel

**For non-waterproof option:**

\*Some surcharges apply

# WOODLORE® PLUS

Color ID	Color Name	2.375" Hinge color (Default)	Direct Mount 3" Hinge color (Default)	T-post connector color	Ring color	pull	Top color (Default)	Track	Invisible hinge color
001	Pure White	Pure White	Pure White	Pure White	White		White		Pearl Chrome Plated
002	Extra White	Silk White	Silk White	Silk White	White		White		
003	Silk White	Silk White	Silk White	Silk White	White		White		
004	Bright White	Silk White	Silk White	Silk White	White		White		
006	Pearl	Pearl	Pearl	Pearl	Pearl		White		
007	Ivory Lace	Bisque	Bisque	Bisque	Bisque		White		
009	Creamy	Pearl	Pearl	Pearl	Pearl		White		
012	Crisp Linen	Crisp Linen	Bisque	Bisque	Bisque		White		
016	Butter	Crisp Linen	Bisque	Bisque	Bisque		White		
019	String	String	Bisque	Bisque	Bisque		White		
030	Moondust	Sea Mist	Nickel Plated	Nickel Plated	Brushed Nickel		Anodised Silver		
032	Sea Mist	Sea Mist	Nickel Plated	Nickel Plated	Brushed Nickel		Anodised Silver		
042	Hall Gray	Sea Mist	Nickel Plated	Nickel Plated	Brushed Nickel		Anodised Silver		
046	Ice	Silk White	Silk White	Silk White	White		White		
048	Chai	Nickel Plated	Nickel Plated	Nickel Plated	Brushed Nickel		Anodised Silver		
049	Stone Gray	Stone Gray	Nickel Plated	Nickel Plated	Brushed Nickel		Anodised Silver		
051	Brown Gray	Brown Gray	Nickel Plated	Nickel Plated	Brushed Nickel		Anodised Silver		
053	Clay	Nickel Plated	Nickel Plated	Nickel Plated	Brushed Nickel		Anodised Silver		
063	Decorators White	Silk White	Silk White	Silk White	White		White		
066	Winchester White 2010	Pearl	Pearl	Pearl	Pearl		White		
073	Sky Gray	Silk White	Silk White	Silk White	White		Anodised Silver		
074	Element Gray	Sea Mist	Nickel Plated	Nickel Plated	Brushed Nickel		Anodised Silver		
075	Storm Gray	Sea Mist	Nickel Plated	Nickel Plated	Brushed Nickel		Anodised Silver		
077	Dawn	Silk White	Silk White	Silk White	White		White		
078	Cloud Blue	Silk White	Silk White	Silk White	White		White		
080	Taupe Gray	Taupe Gray	Nickel Plated	Nickel Plated	Brushed Nickel		Anodised Silver		
836	Classic Black	Black	Black	Black	Black		Anodised Silver		

**For waterproof option:**

Color ID	Color Name	Hinge color (Default)	Ring Pull color	Invisible hinge color
001	Pure White	Stainless Steel	Brushed Nickel	
002	Extra White			
003	Silk White			
004	Bright White			
006	Pearl			
007	Ivory Lace			

\*Some surcharges apply

# WOODLORE® PLUS

009	Creamy
012	Crisp Linen
016	Butter
019	String
030	Moondust
032	Sea Mist
042	Hall Gray
046	Ice
048	Chai
049	Stone Gray
051	Brown Gray
053	Clay
063	Decorators White
066	Winchester White 2010
073	Sky Gray
074	Element Gray
075	Storm Gray
077	Dawn
078	Cloud Blue
080	Taupe Gray
836	Classic Black

Pearl  
Chrome  
Plated

**Position:** For different panel configuration, please refer to the location of Panel Lock to show on which stile the pull will be fixed.

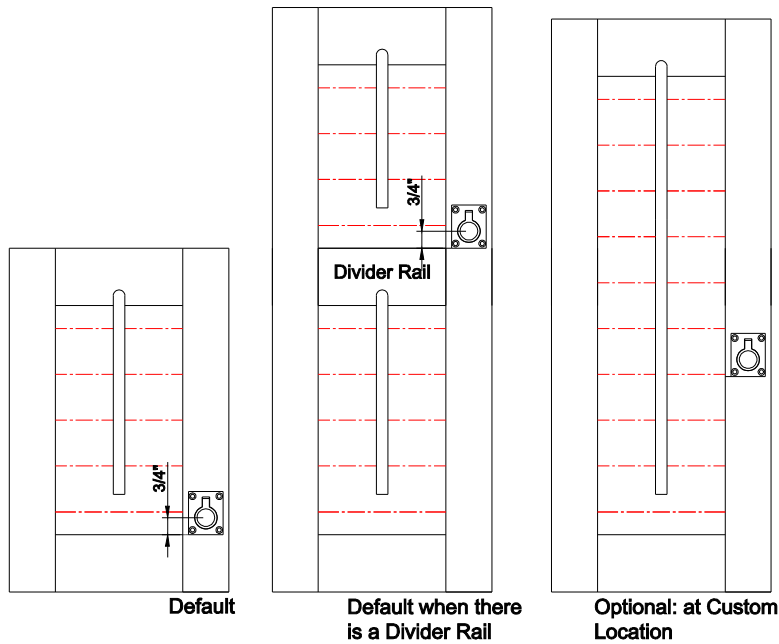

Position:

\*Some surcharges apply

# WOODLORE® PLUS

- A. Above Bottom Rail (Default)
- B. Above 1<sup>st</sup> Divider Rail (Default when there are Divider Rails)
- C. Custom Location

If both Panel Lock & ring pull are specified, the distance between them is 2 3/4", and the ring pull location is 6 3/4" from the bottom of panel.

When there is no mid rail, ring pull will be just on the top of Panel Lock (2 3/4" above Panel Lock) as default location; if there are mid rails, bottom of ring pull lines up with top of the 1<sup>st</sup> mid rail as default location.

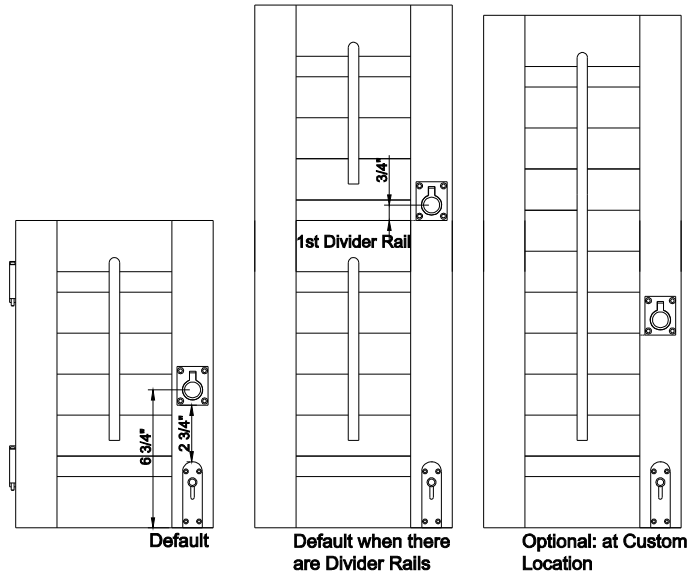

Position:

- A. 2 3/4" Above Panel Lock (Default when both Ring Pull and Panel Lock are specified)
- B. Above 1<sup>st</sup> Divider Rail (Default when there are Divider Rails)
- C. Custom Location

## Measurements:

- Window size:
  - Measure from the bottom of the window to the center of the ring pull.
- Max frame-to-frame:
  - Measure from the bottom of the frame to the center of the ring pull.

**Side Magnet: Not available for Waterproof option**

**Available for Butt, rabbet and Astragal stile**



Side Magnets will be applied in following situation:

1. Double Hung shutter but without horizontal T post:
  - Side magnets will be applied to the meeting stiles of the L and R panel. (Default)

\*Some surcharges apply

# WOODLORE® PLUS

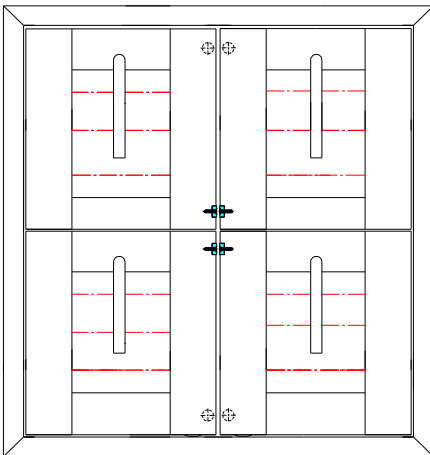

## 2. Café Shutter

Side magnets will be applied to the meeting stiles of the L and R panel. (Default)

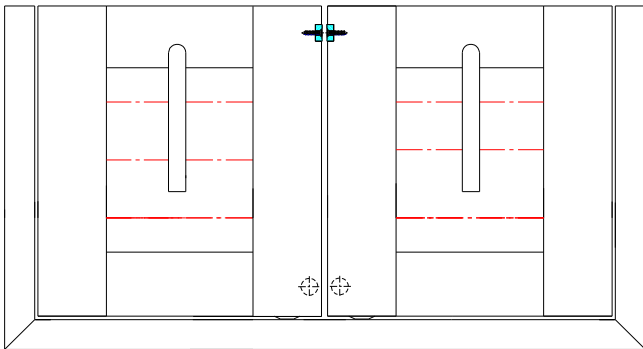

## 3. No frame or light block or L-shape striker plate on either top or bottom, or if larger than standard top or bottom gap is requested.

Side magnets will be applied to the meeting stiles of the L and R panel. (Optional)

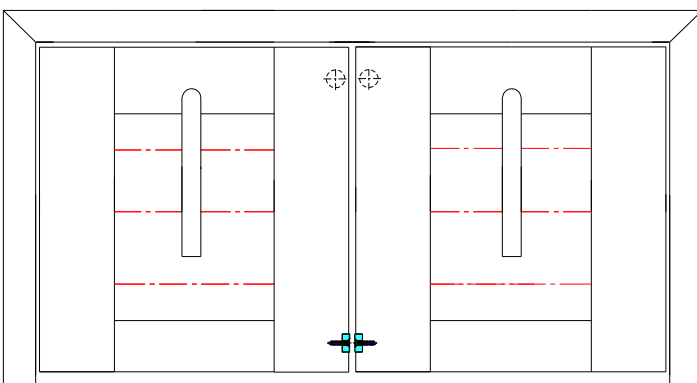

4. Note: if panels only with side magnets and there is no standard magnet on the back of panels, panels may open for external factors.

# WOODLORE® PLUS

## T-Post Connector

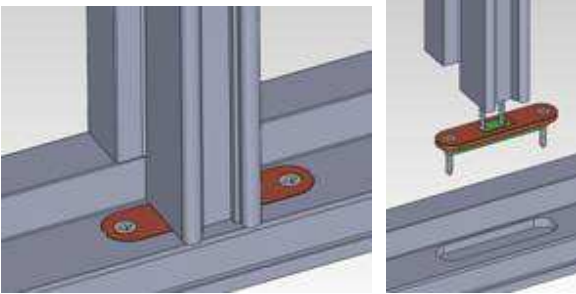

- Available colors: Pure White; Silk White; Pearl; Bisque; Black; Nickel-Plated.
- Available for all types of T Posts (custom-width T posts excluded).

**T Post Connector can be used with the following Frames.**

**L Frame:**

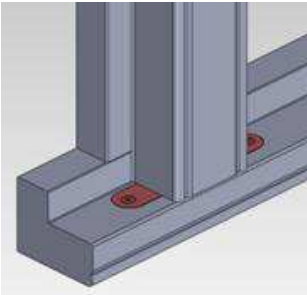

**Deco Frame:**

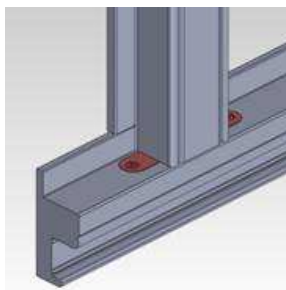

**Z Frame:**

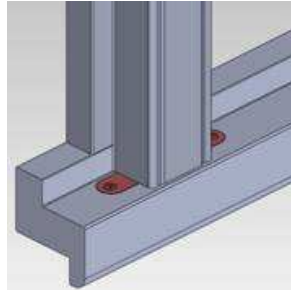

**Hang Strip (Beside)**

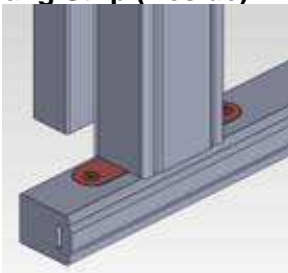

**Note:**

1. For Horizontal T Post, Hang Strip (Behind) and shutter with 1.5"/2" Sill, T Post connector is not available and T Post will be installed by screws instead;
2. If there is a panel lock which may interfere with the T-Post connector, all the T-Posts for the entire shutter will be installed with screws and the frames to be pre-drilled, even in cases where the panel lock may only interfere with one T-Post;
3. T post connectors can only be installed on a straight piece, and screws will be used instead for T Post installed on a curved or raked piece.
4. The screw color is Stainless Steel for Waterproof shutter regardless of the color of the T Post connector;
5. The screw color is Nickel Plated for Non-Waterproof shutter regardless of the color of the T Post connector;

\*Some surcharges apply

WLP i-11

# WOODLORE® PLUS

## Optional Poles:

### 1. Terminology

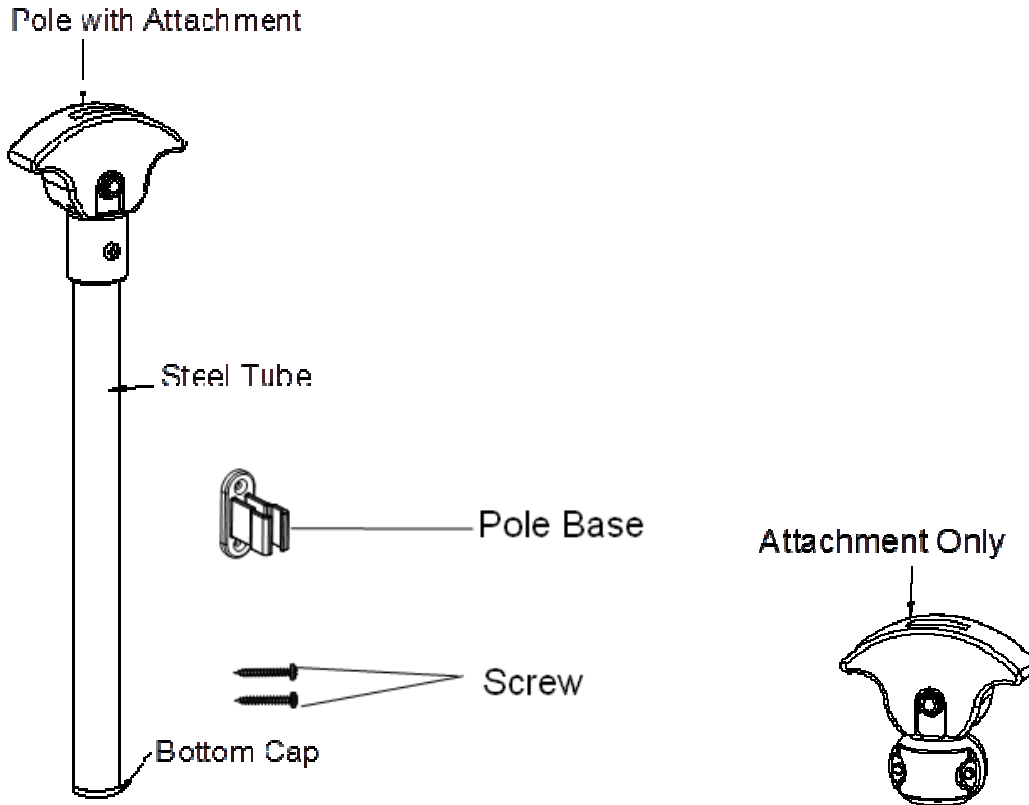

### Component

NO.	Name	Note
1	Pole with Attachment	Steel tube, Pole Base and Bottom Cap included *Surcharge applies.
2	Attachment only	<ul style="list-style-type: none"> <li>● Compatible with extension poles found in most home improvement stores.</li> <li>● Screw thread (3/4") and thread pitch (1/5")</li> </ul> *Surcharge applies.

### 2. Available Pole Length

	2pcs Combined by Connector
Pole length (inch)	53"

\*Some surcharges apply



# WOODLORE® PLUS

The Connector (the center one):



The Finished Product:

Pole with Plastic Tube:



# Track Shutters—Bypass

**Guidelines and Specs:**

Description	Minimum	Maximum		
		1 <sup>7</sup> / <sub>8</sub> "	2 <sup>1</sup> / <sub>2</sub> " / 3"	3 <sup>1</sup> / <sub>2</sub> " / 4 <sup>1</sup> / <sub>2</sub> "
Single-Panel Width (Regular) for Non-Waterproof option	6"	24"	36"	36"
Single-Panel Width (Regular) for Waterproof option	6"	24"	31"	36"
Single-Panel Height	10"	120"	120"	120"

Outside Mount

Max frame-to-frame width: window width + 3"  
 Max frame-to-frame height: window height + 4<sup>1</sup>/<sub>2</sub>"

Semi-Inside Mount

Max frame-to-frame width: window width - 1<sup>1</sup>/<sub>8</sub>"  
 Max frame-to-frame height: window height + 1<sup>3</sup>/<sub>8</sub>"

Inside Mount

Max frame-to-frame width: window width - 1<sup>1</sup>/<sub>8</sub>"  
 Max frame-to-frame height: window height - 1<sup>1</sup>/<sub>8</sub>"

**Carriers are in the Track / Hangers are in the Panel:**

Adjustments to panel alignment are made by turning the Carrier Bolt with the wrench included in the Hardware Box

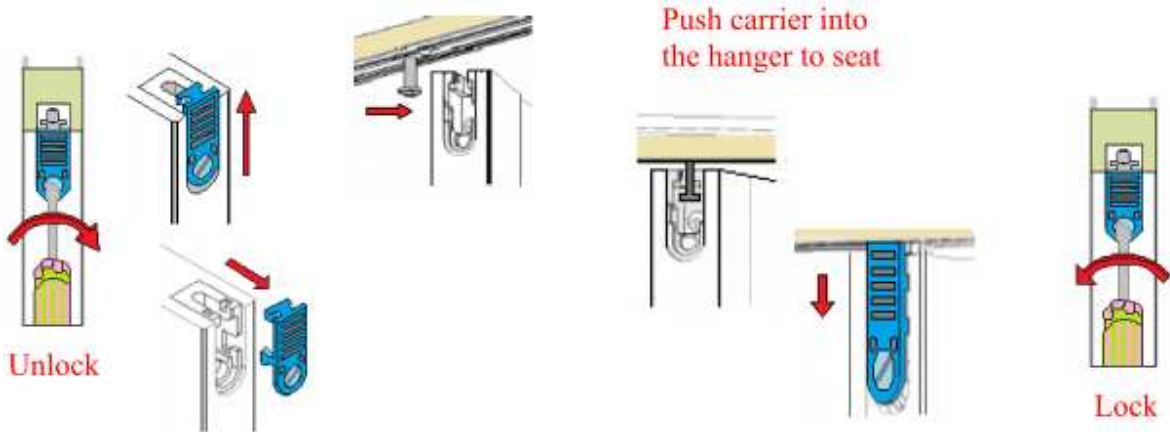

# Track Shutters—Bypass

## Top View

Outside Mount

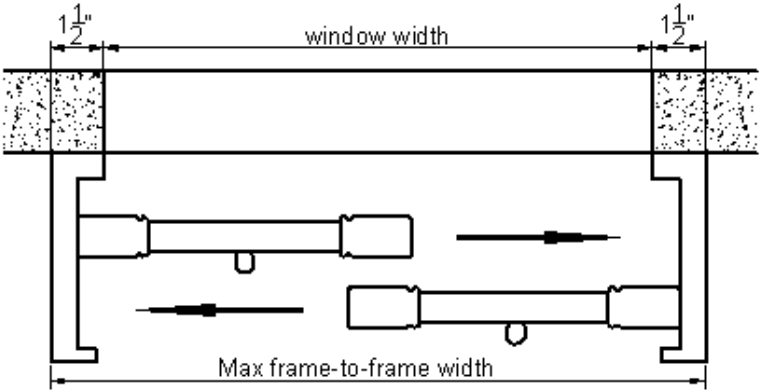

Semi-Inside Mount

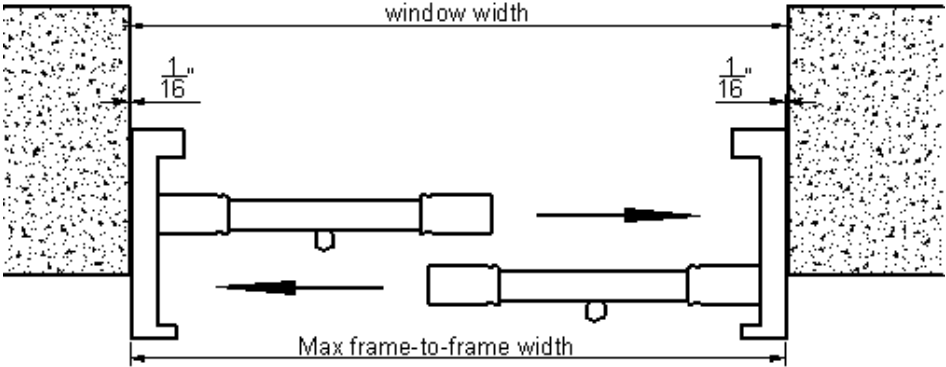

Inside Mount

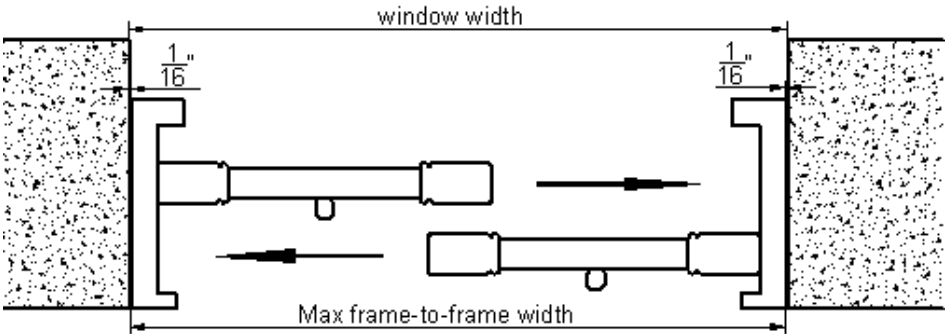

# Track Shutters—Bypass

## Top View

Combi - joined Panels (optional):

**For Non-Waterproof option:**

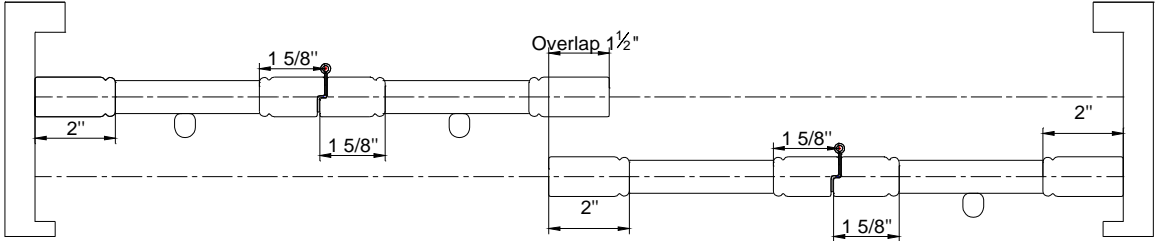

**For Waterproof option:**

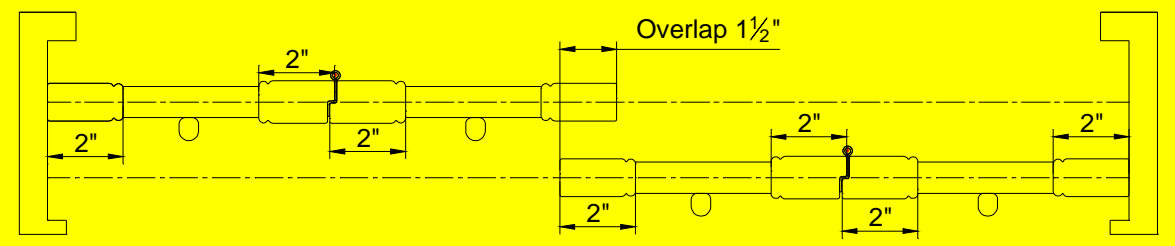

For shutters with 4 or more panels, please select “side open” or “center open”

**Side Open for Non-Waterproof option:**

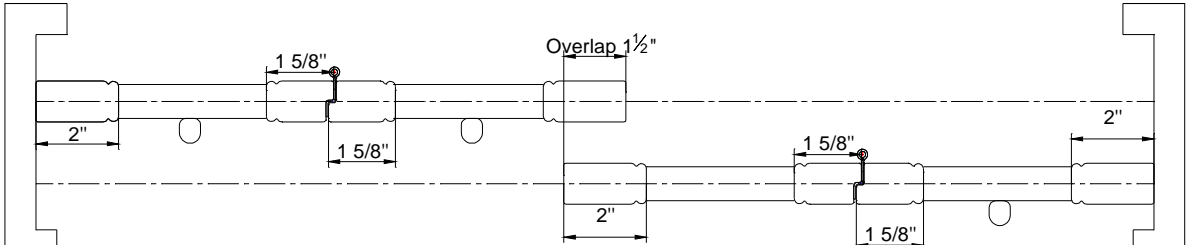

**Side Open for Waterproof option:**

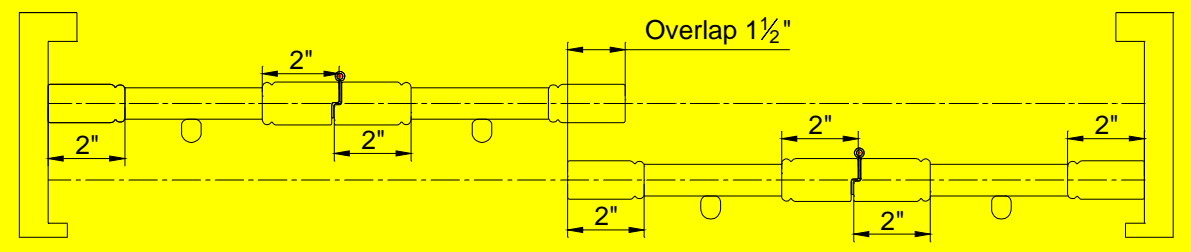

# Track Shutters—Bypass

Center Open

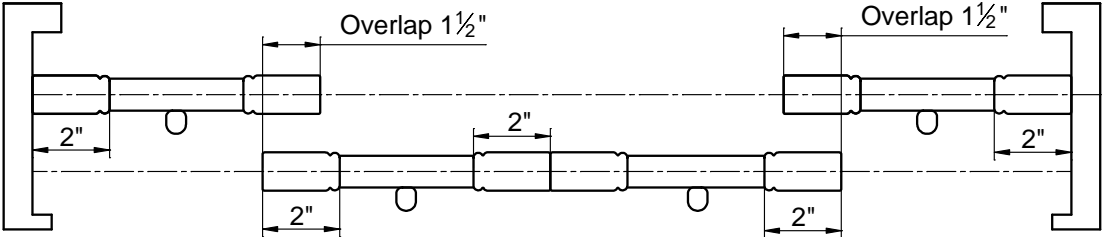

4 panels side open w/Rabbit stile

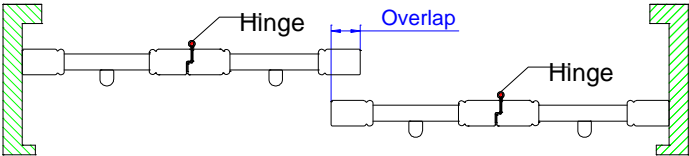

4 panels center open w/Rabbit stile

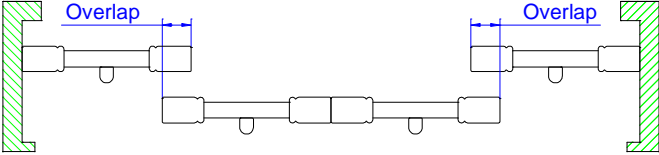

6 panels side open w/Rabbit stile

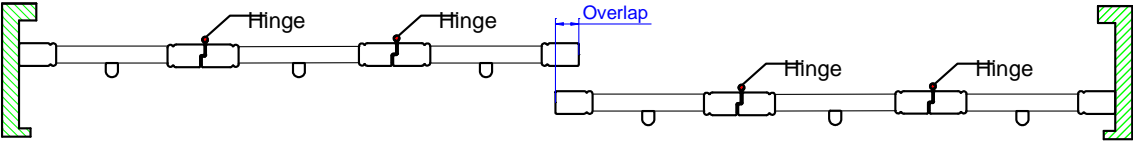

6 panels center open w/Rabbit stile

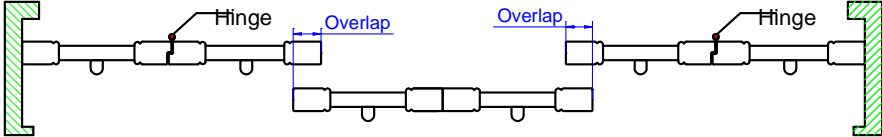

**Stile:** Only 2", 2 1/4" rabbit stiles are available,  
1 5/8" rabbit stile only used for combi-joined panels for non-waterproof option.  
Center stile is not available.

# WOODLORE® PLUS

## Track Shutters—Bypass

### Size Definition

For Semi-Inside/OM without side boards

For IM without side boards

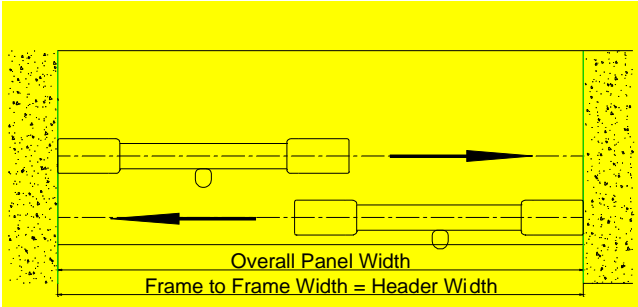
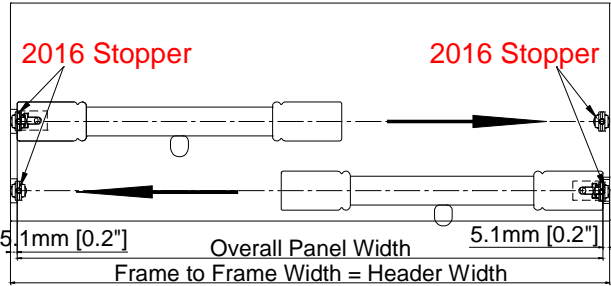

Note: For Semi-Inside/OM bypass without side boards, 2016 Stopper will be supplied.

### Mounting Options (Closed Bypass)

#### Side View

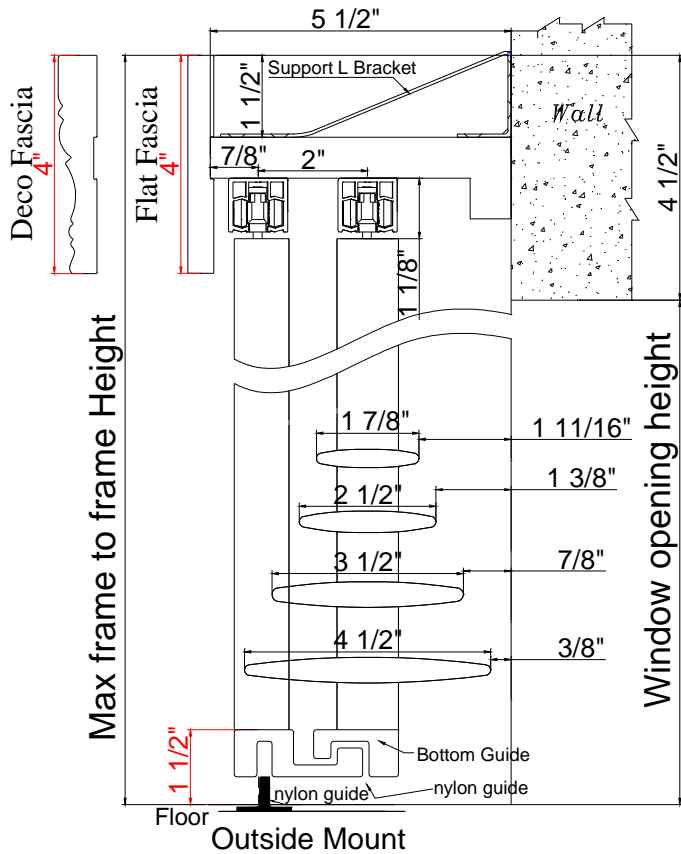

#### Bottom Guide For non-waterproof

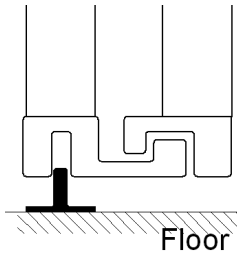

#### Bottom Guide For Waterproof option

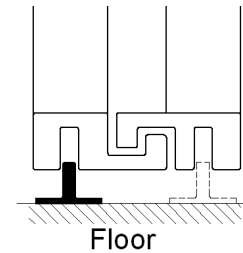

# Track Shutters—Bypass

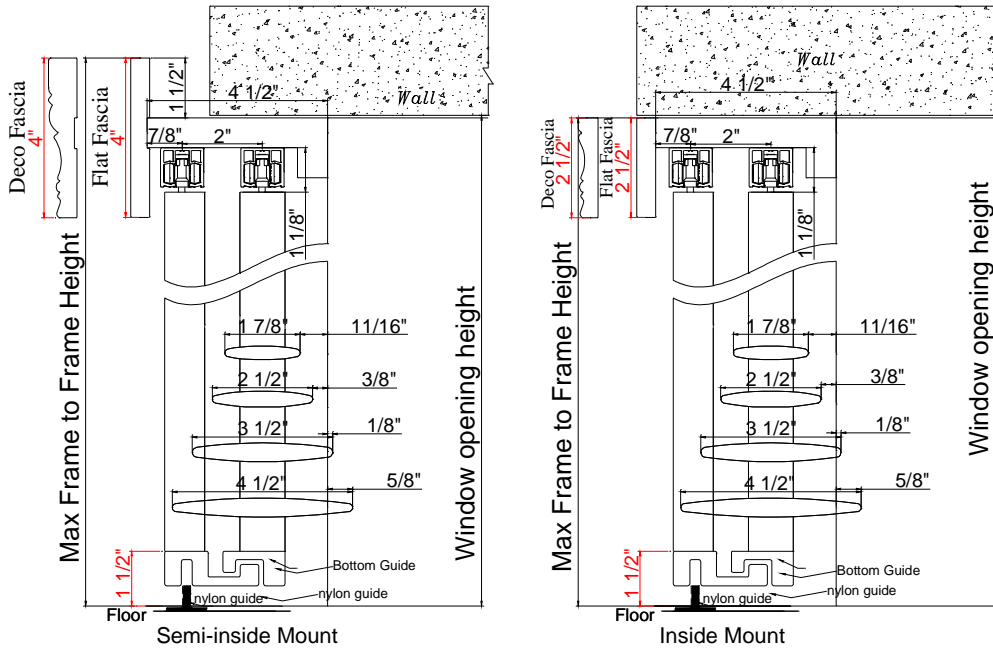

## Mounting Options (Closed Bypass with 3 Tracks):

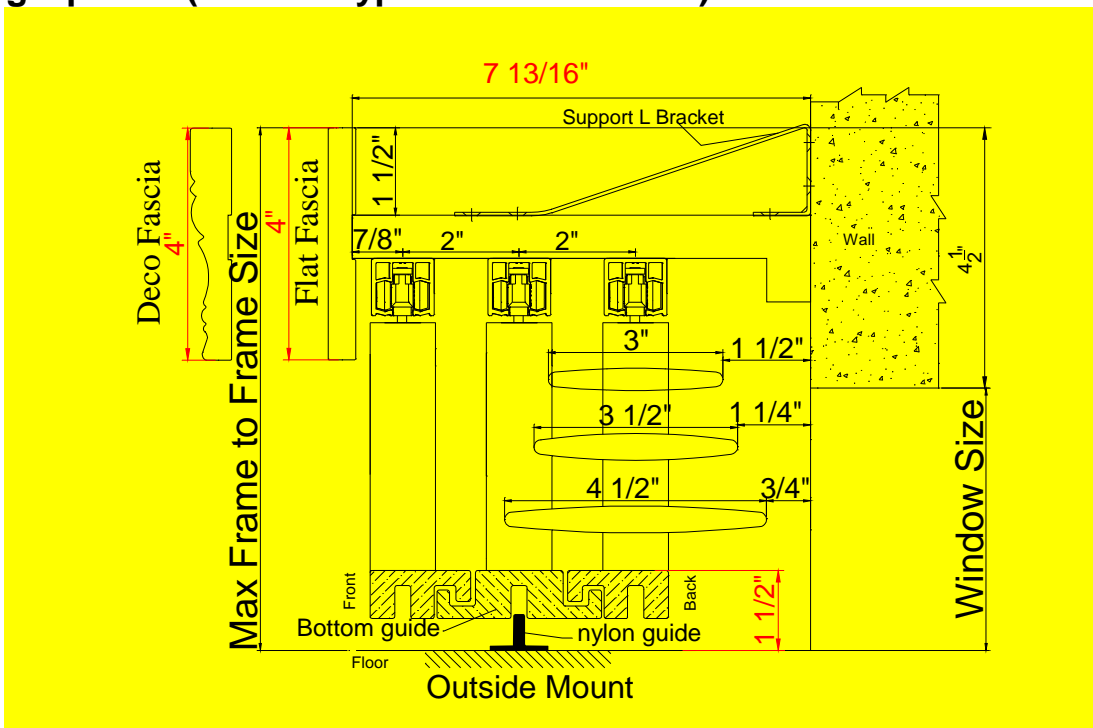

Track Shutters—Bypass

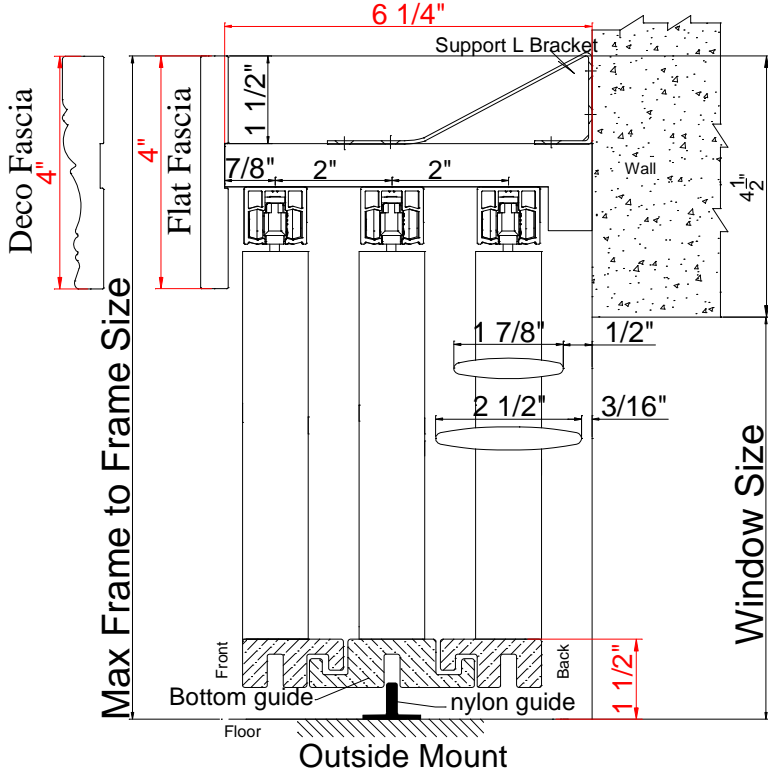
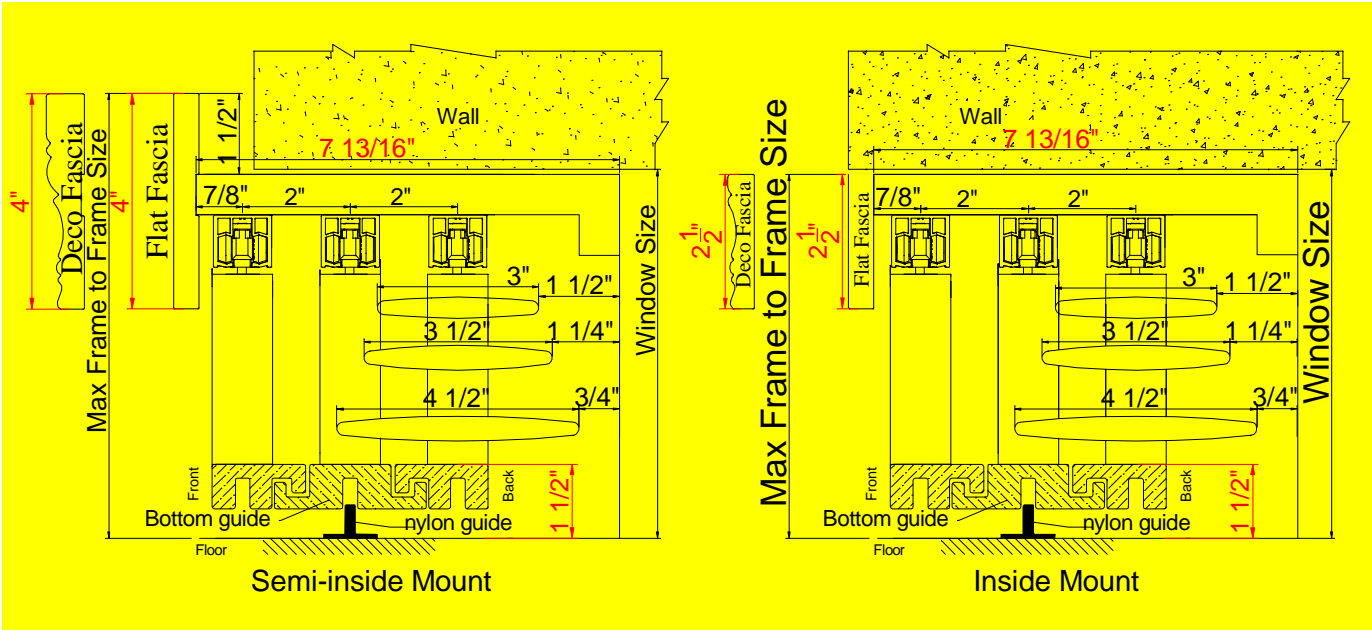



# Track Shutters—Bypass

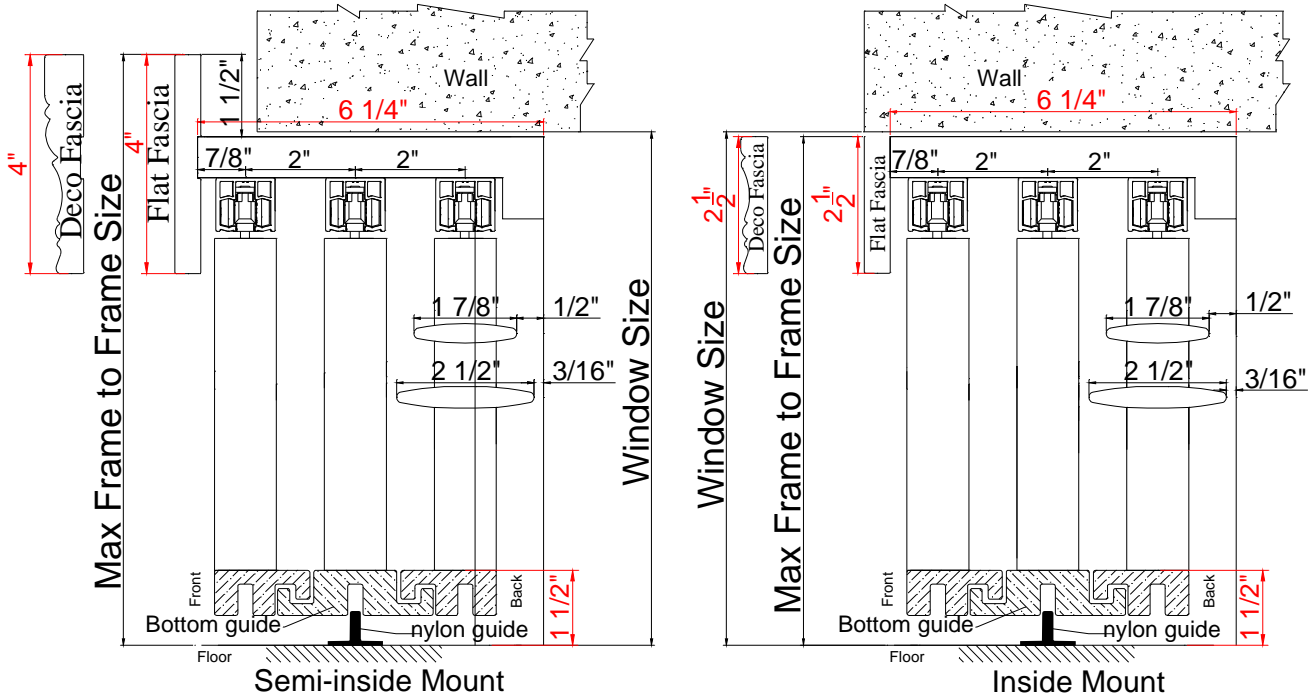

## Mounting Options (Opened Bypass)

Only available in 2 1/2", 3" and 3 1/2" louver sizes

### 2 1/2" Louver

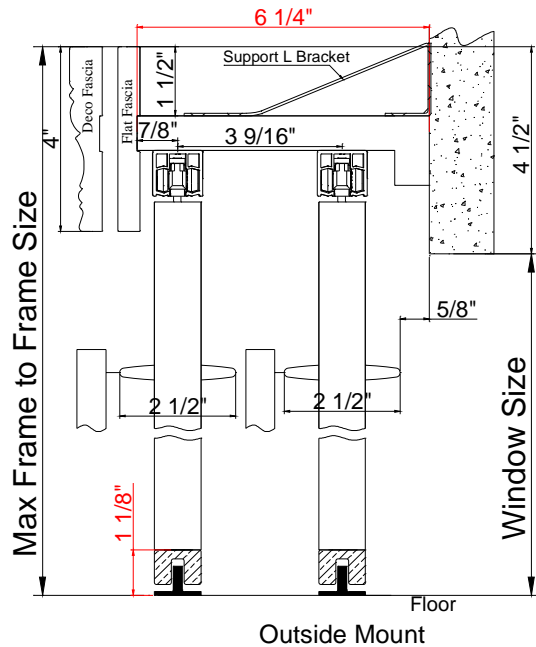

# Track Shutters—Bypass

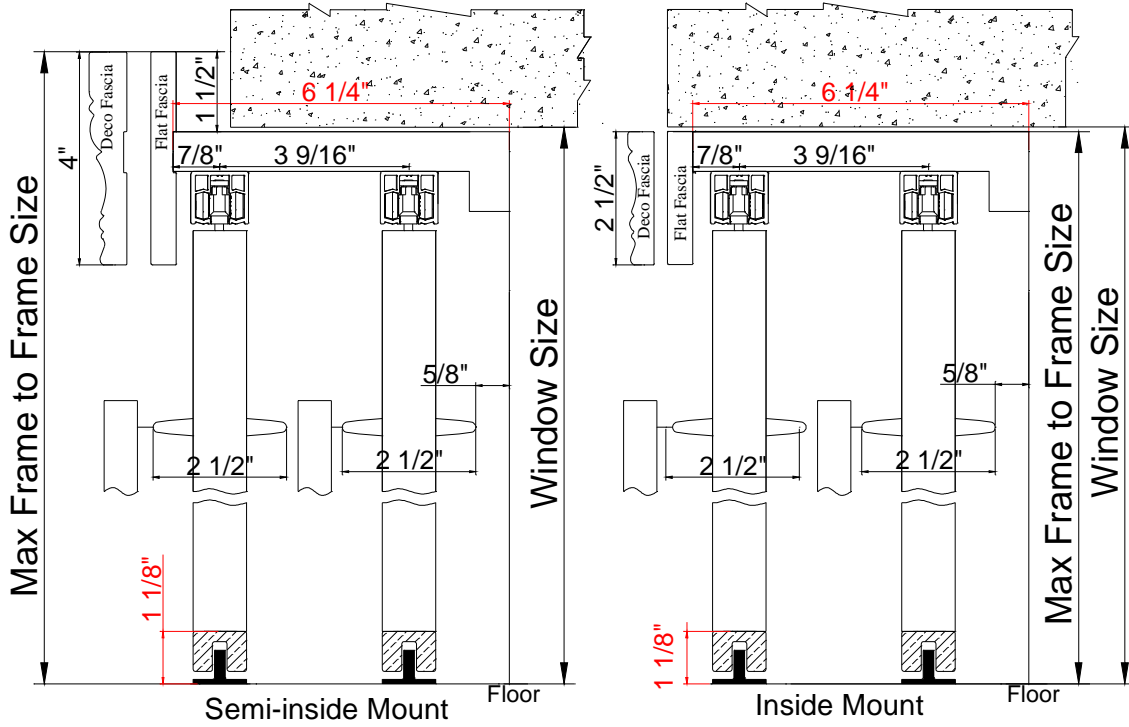

## 3" / 3 1/2" Louver

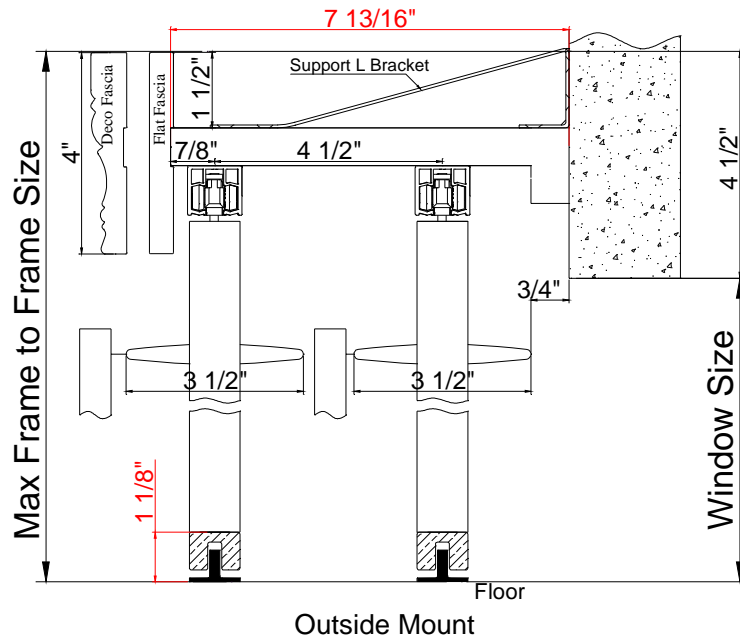

# Track Shutters—Bypass

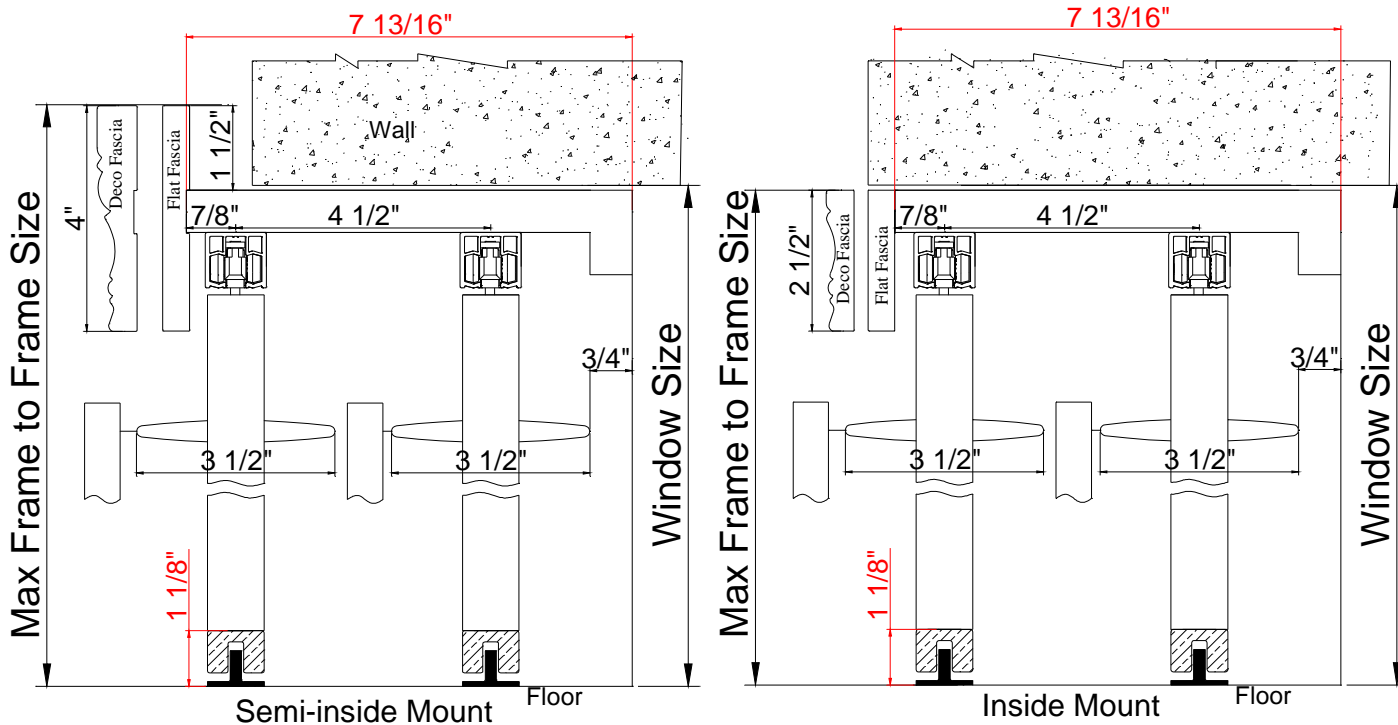

Open By Pass: has 2 kinds of bottom guide

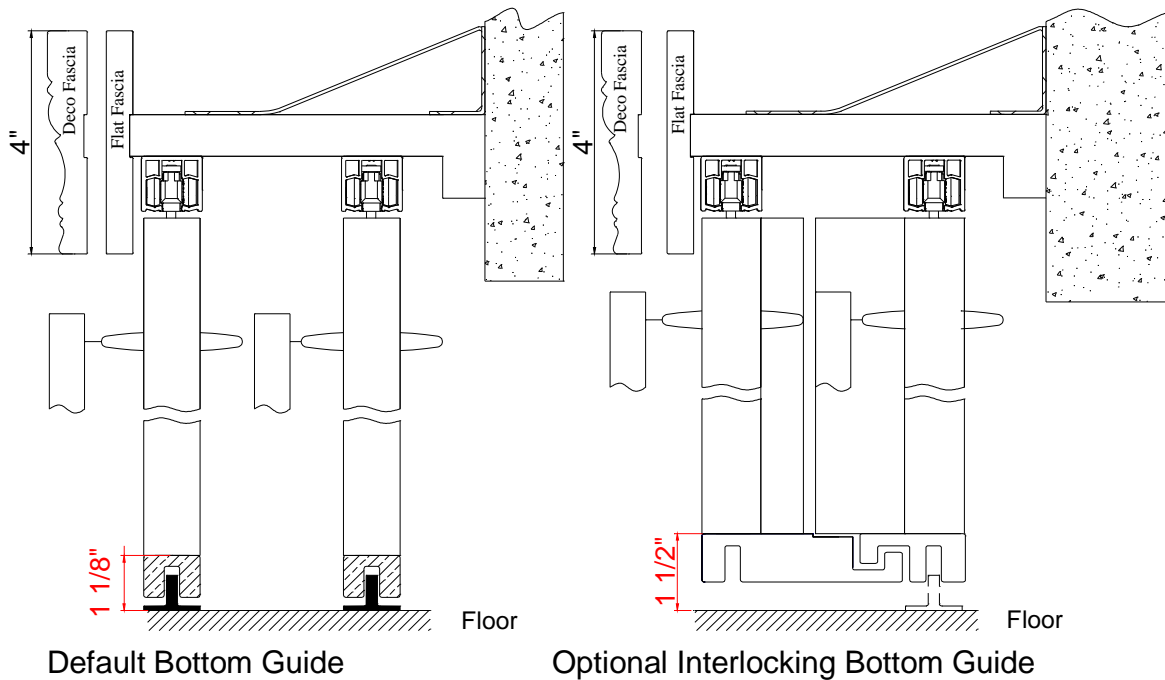

# Track Shutters—Bypass

## Opened Bypass

Top View

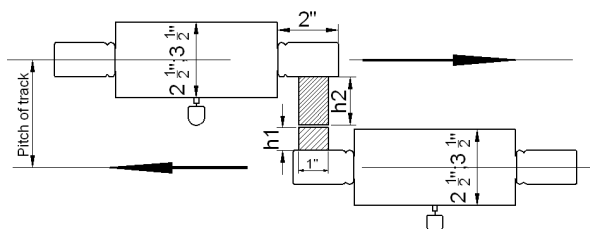

Note: The light block for open bypass will be changed to use screws with wood plugs instead of current dowels.

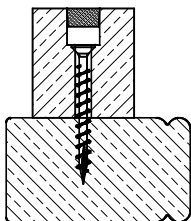

### Separation of track

Louver	U shape bottom guide		Interlocking bottom guide	
	Regular Tilt Rod	Invisible tilt	Regular Tilt Rod	Invisible tilt
2.5"	3 9/16"	2 3/4"	3 9/16"	3 9/16"
3" / 3.5"	4 1/2"	3 5/8"	4 1/2"	4 1/2"

### Light block thickness for panel

Louver		U shape bottom guide		Interlocking bottom guide	
		Regular Tilt Rod	Invisible tilt	Regular Tilt Rod	Invisible tilt
2.5"	h1	3/4"	3/4"	3/4"	1 9/16"
	h2	1 9/16"	3/4"	1 9/16"	3/4"
3" / 3.5"	h1	1 3/16"	1 3/16"	1 3/16"	1 15/16"
	h2	1 15/16"	1 3/16"	1 15/16"	1 3/16"

**Nylon Guide:** The nylon guide is composed by 2 parts and will supplied as a whole set by default (bottom part 16mm and top part 5mm), please remove the top part if necessary.

# Track Shutters—Bypass

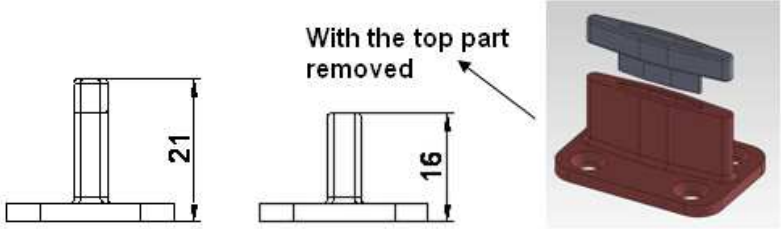

## The 2016 Stopper

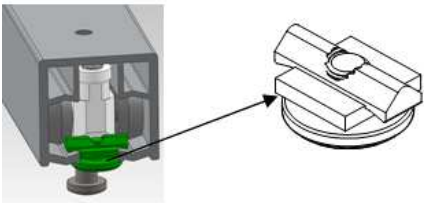

For outside mount/semi-inside mount bypass without side boards, the 2016 Stopper will be supplied by default. The gap between the fascia return / end of top track and the panel is 5mm each side. The 2016 stopper can also be used in the center or any position of the top track as an option. Please see drawing below to show the gap.

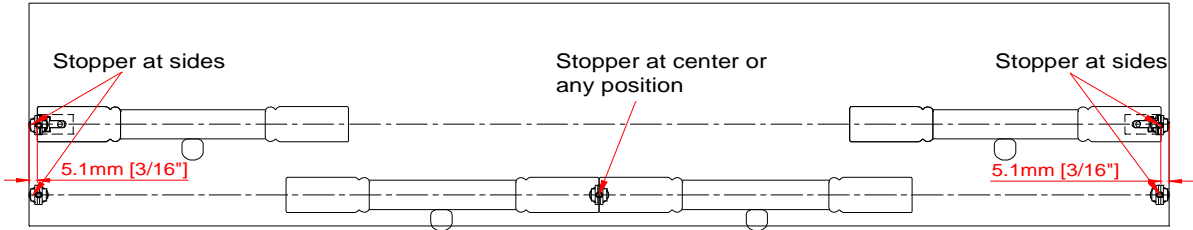

# Track Shutters—Bypass

**Track Shutters Framing Materials (For waterproof option, only plain fascia is available)**

Framing	Size				Pc(s)
<b>L Shape Header</b>	<b>Header (Closed Bypass)</b>	<b>Header (Opened Bypass)</b>	<b>Supporting Strip</b>		1 pc
<b>(2 in 1)</b>	$\frac{3}{4}$ " x $5\frac{1}{2}$ "* (Default for Outside Mount; Optional for Semi-Inside and Inside Mount)	$\frac{3}{4}$ " x $6\frac{1}{4}$ "* ( $2\frac{1}{2}$ " Louver)	$\frac{3}{4}$ " x $\frac{3}{4}$ "		
Header with Supporting Strip	$\frac{3}{4}$ " x $4\frac{1}{2}$ "* (Default for Semi-Inside and Inside Mount; Optional for Outside Mount)	$\frac{3}{4}$ " x $7\frac{13}{16}$ "* ( $3\frac{1}{2}$ " Louver)			
	Custom * $\leq 8$ "	Custom * $\leq 8$ "			
<b>U Shape Side Frame</b>	<b>Side Frame (Closed Bypass)</b>	<b>Side Frame (Opened Bypass)</b>	<b>Supporting Strip</b>	<b>Side Fascia</b>	2 pcs
<b>(3 in 1)</b>	$\frac{3}{4}$ " x $5\frac{7}{8}$ "* (Default for Outside Mount; Optional for Semi-Inside and Inside Mount)	$\frac{3}{4}$ " x $6\frac{5}{8}$ "* ( $2\frac{1}{2}$ " Louver)	$\frac{3}{4}$ " x $\frac{3}{4}$ "	$\frac{3}{8}$ " x $1\frac{1}{4}$ "	
Side Frame with Supporting Strip & Side Fascia	$\frac{3}{4}$ " x $4\frac{7}{8}$ "* (Default for Semi-Inside and Inside Mount; Optional for Outside Mount)	$\frac{3}{4}$ " x $8\frac{1}{4}$ "* ( $3\frac{1}{2}$ " Louver)			
	Custom * $\leq 8$ "	Custom * $\leq 8$ "			
Top Fascia (Plain/Deco)	4" (Semi-inside and Outside Mount)				1 pc
	$\frac{1}{2}$ " x $2\frac{1}{2}$ " (Inside Mount)				
Top Fascia Return	4" (Semi-inside and Outside Mount)				2 pcs
	N/A (Inside Mount)				

## Track Shutters Framing Materials

Note:

- When the header size is  $4\frac{1}{2}$ "\*,  $5\frac{1}{2}$ "\*,  $6\frac{1}{4}$ "\* or  $7\frac{13}{16}$ "\*, the L Shape header and the U Shape Side Frame will be sent integrally. That is:
  1. The header and the supporting strip will be sent integrally as L Shape Header;
  2. The side frame, supporting strip and the side fascia will be sent integrally as U Shape Side Frame.
- For any custom header sizes other than  $4\frac{1}{2}$ "\*,  $5\frac{1}{2}$ "\*,  $6\frac{1}{4}$ "\* or  $7\frac{13}{16}$ "\*, the L Shape Header and the U Shape Side Frame will be sent separately. That is:

# Track Shutters—Bypass

1. The header and the supporting strip will be sent separately for L Shape Header;
2. The side frame, supporting strip and the side fascia will be sent separately for U Shape Side Frame.

➤ The way to connect the bypass header & Fascia: Use the L Bracket to connect the fascia returns, fascia and header. This applies for Inside Mount, Semi-Inside Mount & Outside Mount. Please refer to the drawings below.

Outside Mount:

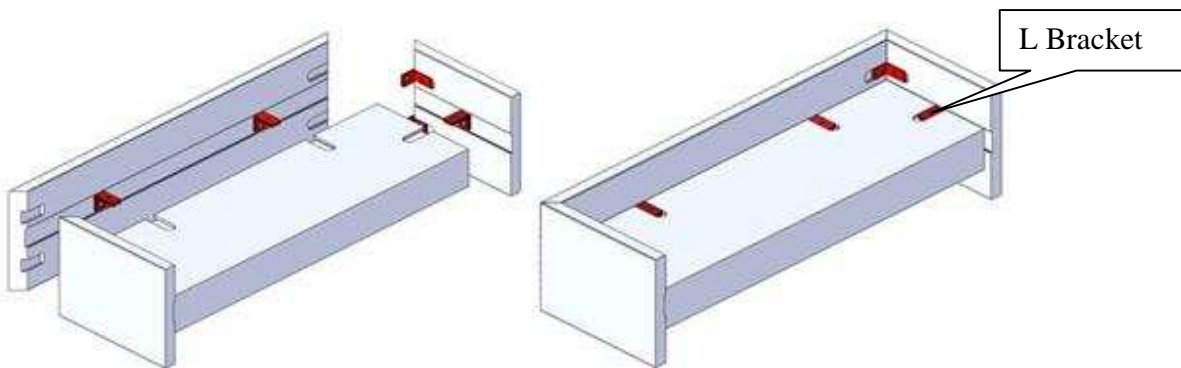

Inside Mount

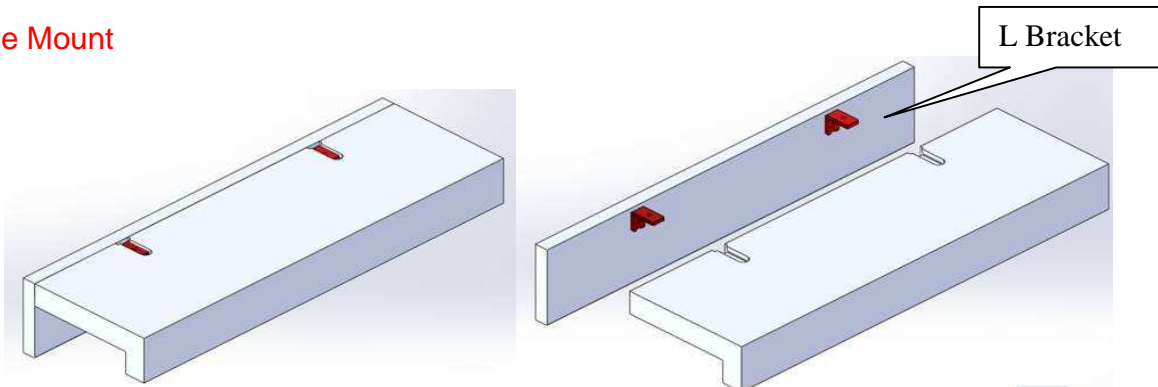

Semi-Inside Mount

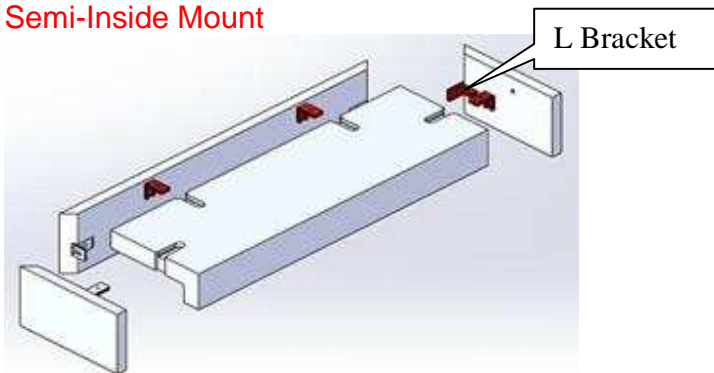

# Track Shutters—Bypass

## Hardware Box

Hardware Box
<b>Part</b>
Wrench
Nylon Guide
¾ " screws for Nylon Guide
Support L Bracket (based on the length of header)
2 ½ " screws for support L bracket
¾ " screws for support L bracket

### Keystone for Fascia of the Track Shutter

When fascia length exceeds the limitation and needs to split, keystone design fascia will be supplied without surcharge for track shutters.

For fascia length within the split limitation, keystone can also be supplied as an option with surcharge.

For Deco Fascia:

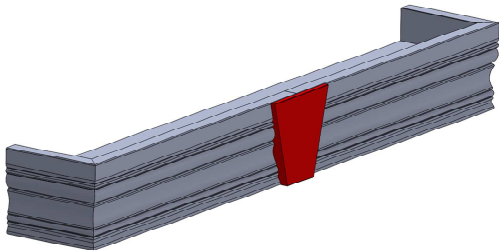

For Plain Fascia:

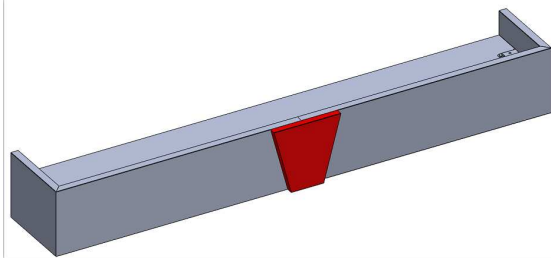

The keystone will be installed by screws. We will pre-drill the screw holes and the screws will be packed in hardware box.



# Track Shutters—Bypass

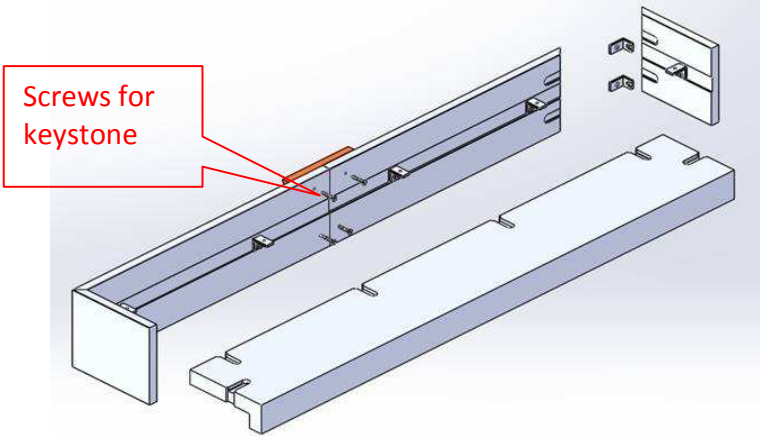

## Plastic L Bracket to Connect the Header, Fascia & Fascia Returns



L Bracket will be used to connect the header, fascia and fascia returns for Bypass shutter. This applies for Inside Mount, Semi-Inside Mount & Outside Mount.

### OM & Semi-IM

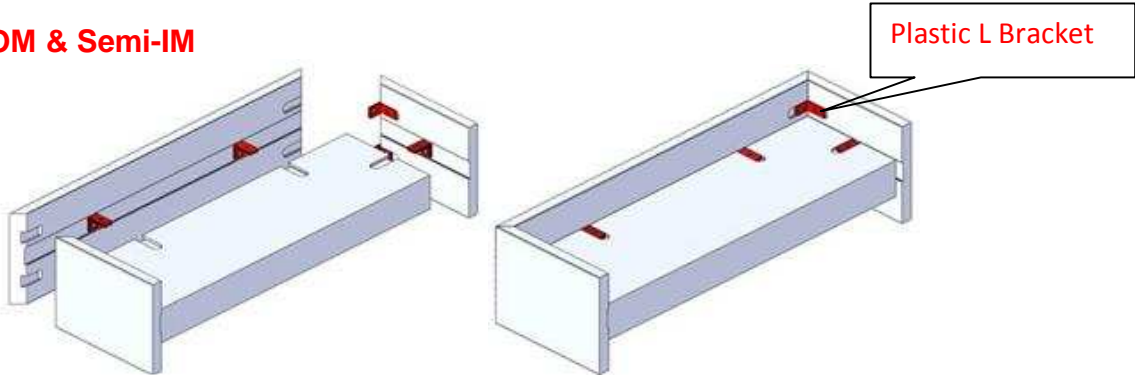

### IM

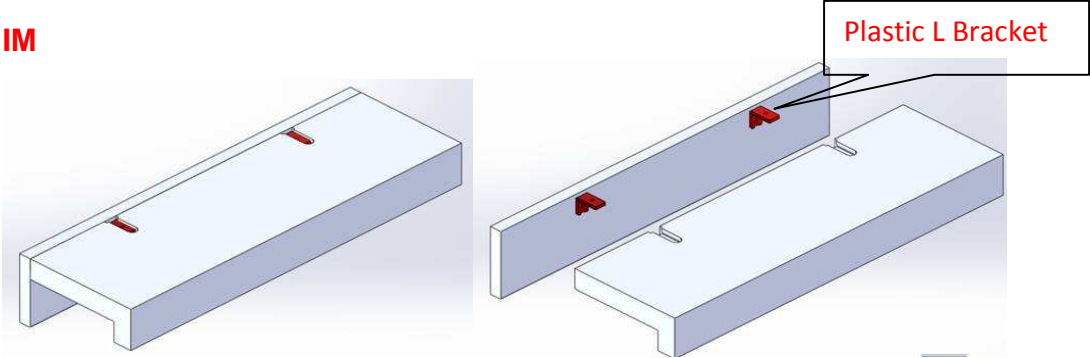

WOODLORE® PLUS

# Track Shutters—Bypass

# WOODLORE® PLUS

## Bi-fold 180™

### Guidelines and Specs:

<u>Description</u>	<u>Minimum</u>	<u>Maximum</u>	
		1 $\frac{7}{8}$ "	2 $\frac{1}{2}$ " ; 3" ; 3 $\frac{1}{2}$ " ; 4 $\frac{1}{2}$ "
Single-Panel Width (Bi-fold Track) for Non-Waterproof option	6"	24"	24"
Single-Panel Width (Bi-fold Track) for Waterproof option	6"	24"	26"
Single-Panel Width (LLL/RRR)	N/A	N/A	N/A
Single-Panel Height	10"	120"	120"

#### Outside Mount

Max frame-to-frame width: window width + 3 1/2"

Max frame-to-frame height: window height + 4 1/2"

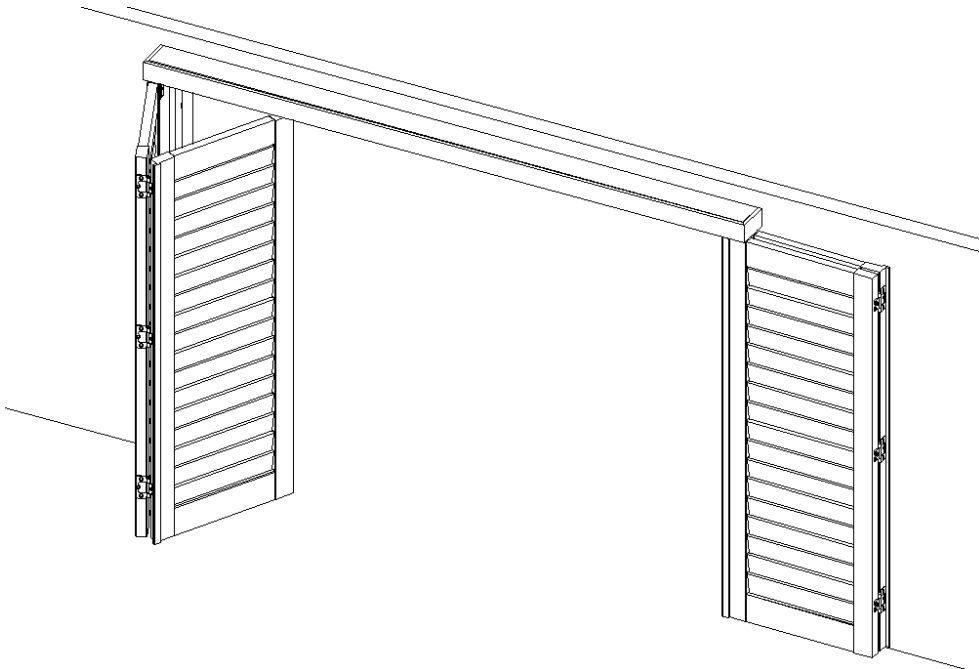

- Track is pre-installed on the header; standard 1 track only.

# WOODLORE® PLUS

## Mounting Options: Outside Mount only

### Side View

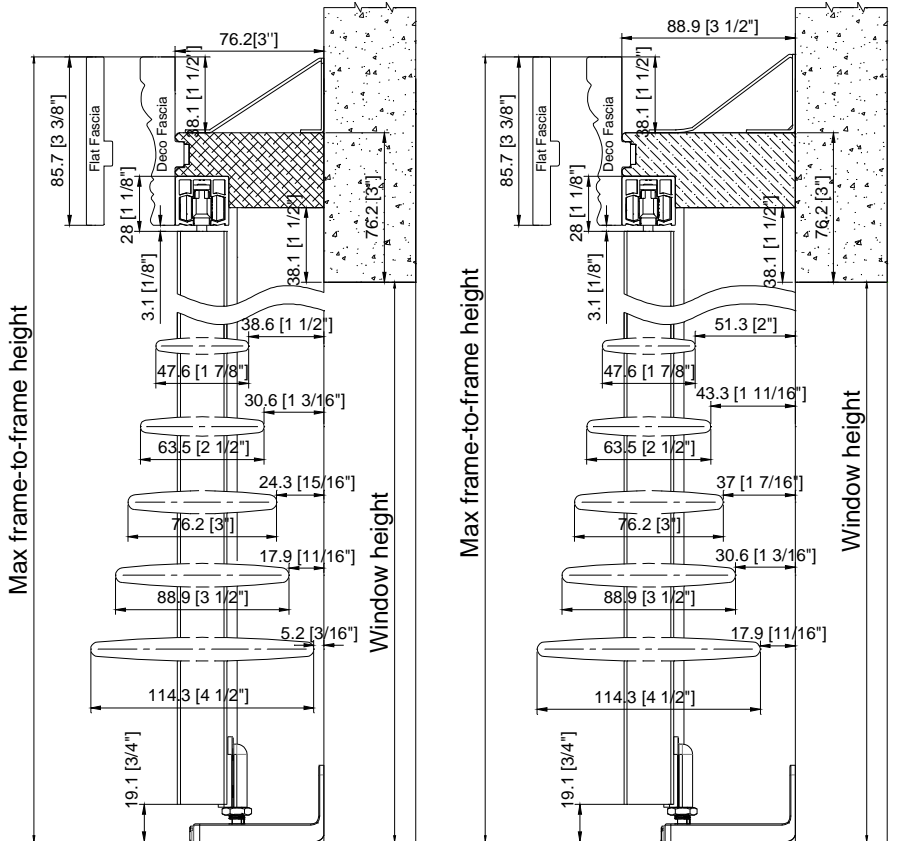

### Top View

#### Without Casing:

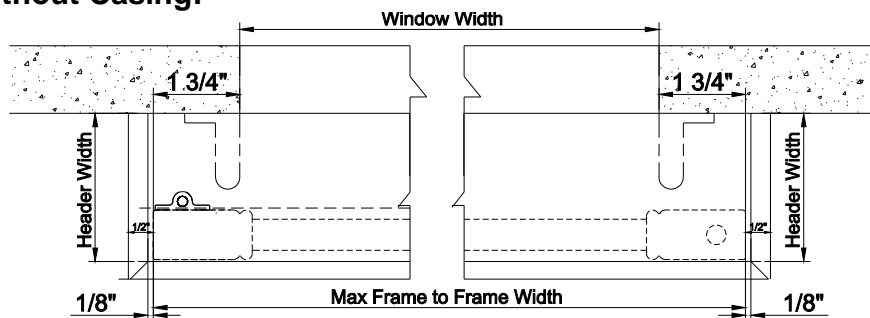

#### Note:

- ◇ Fascia return will protrude the panel about 1/2" for each side.
- ◇ The header will protrude the panel about 1/8" for each side.
- ◇ Header, light blocks, and bottom pivot bracket(s) must be installed on a flat surface.

# WOODLORE® PLUS

## With Existing Casing:

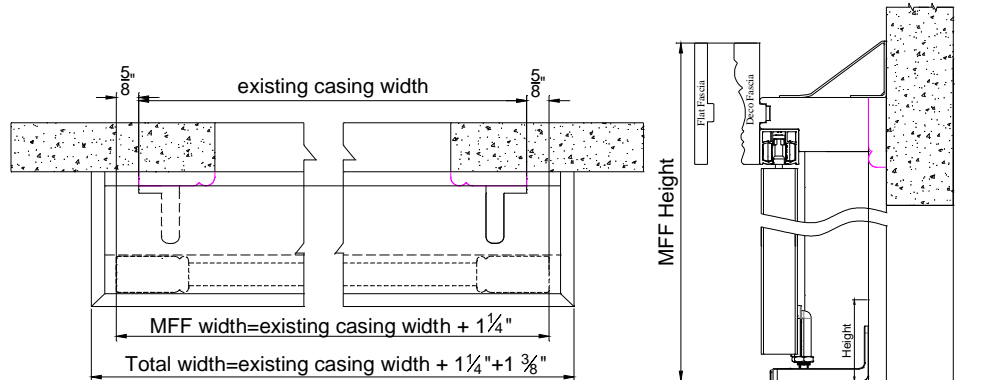

- ✧ Header Extension: Optional
- ✧ Custom extension up to 2" for Header
- ✧ When extension is needed, the header will protrude the panel 5/16" for each side and the fascia return will protrude the panel 11/16" for each side.

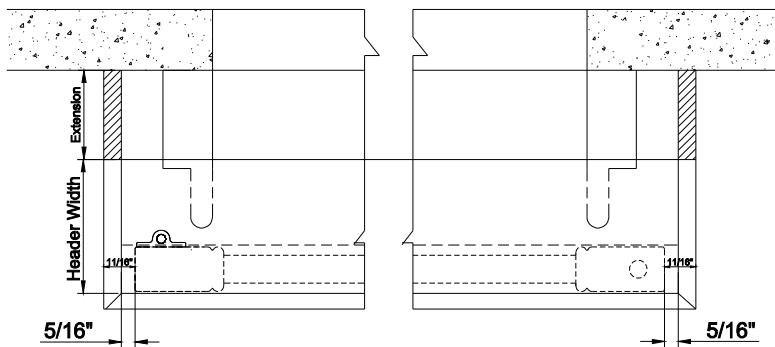

- ✧ The extension will be pre-attached.

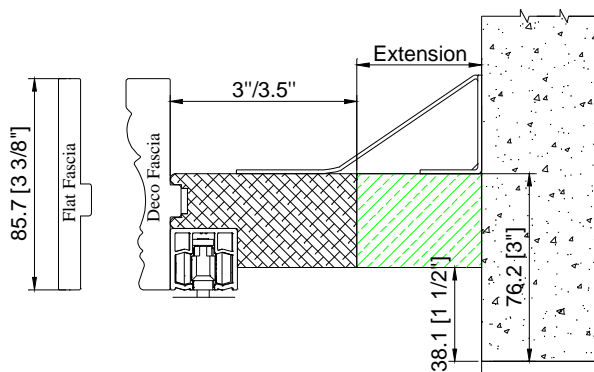

# WOODLORE® PLUS

For 180 Bi-fold, if Bottom Pivot L Bracket is required, the extension for the L shape light block will be  $1\frac{3}{4}$ " in width. Please see picture below:

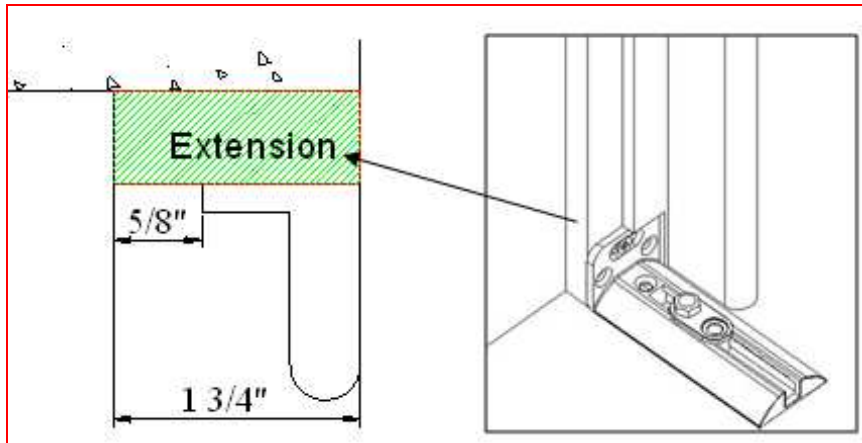

**Panel Configuration: Only 2", 2 1/4" rabbet and butt stiles are available for non-waterproof option.  
Only 2" rabbet and butt stiles are available for waterproof option.  
Center stile is not available.**

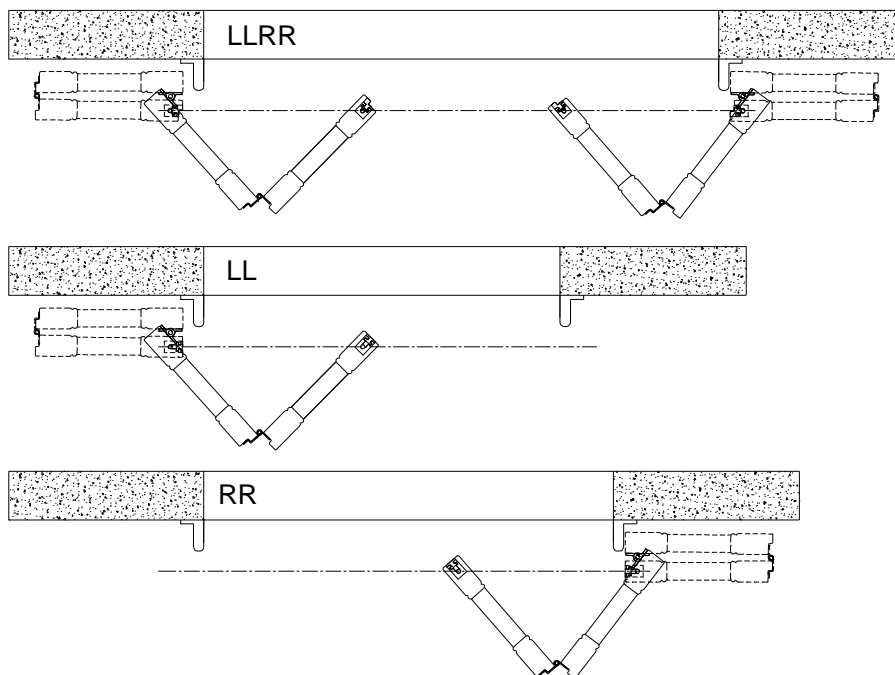

## Notes:

If there is no baseboard to the wall, 3" header can be used.

If there is baseboard to the wall, then it should be as below:

1. If base board thickness is less or equal to  $\frac{5}{8}$ ", 3 1/2" header can be used.
2. If base board thickness is over  $\frac{5}{8}$ ", it is suggest using the 3" header with build out. And the build out thickness=base board thickness- $\frac{1}{8}$ ".

# WOODLORE® PLUS

Please see the drawing below:

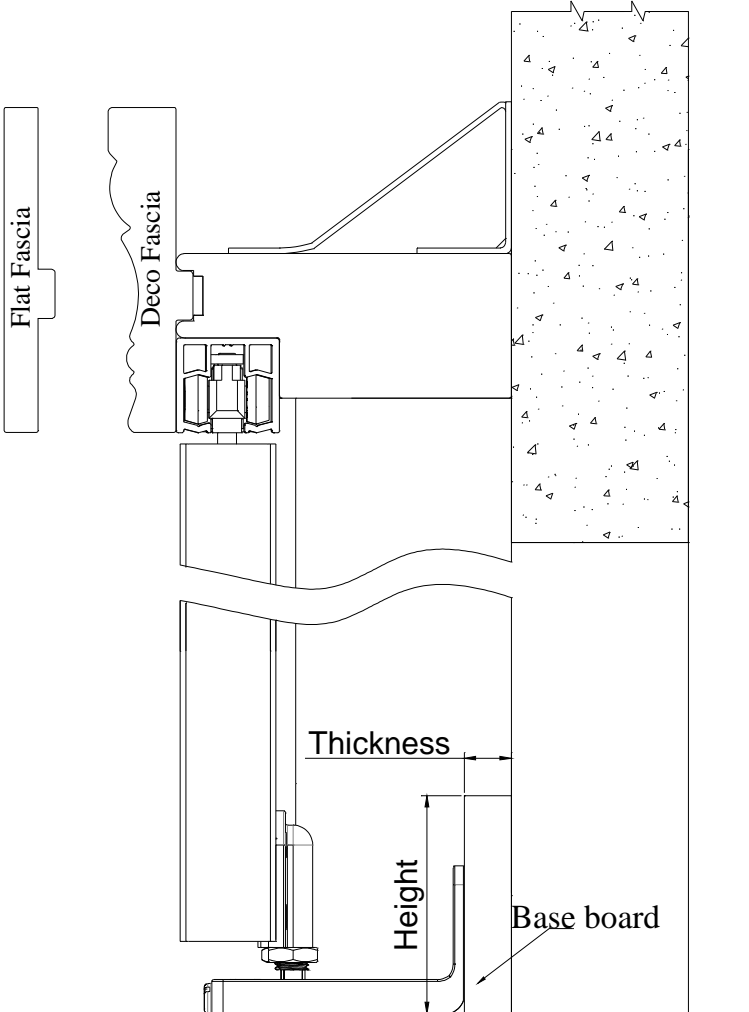

**180° Bi-fold Track Shutters Framing Materials**

Type	Header Dimension	Top Fascia Dimension	L Shape Light Block Strip Dimension
Header & Top Fascia & Light Block Strip	3"	3 3/8"	1 9/16"
	3 1/2"		2 1/16"

# WOODLORE® PLUS

## 180° Bi-fold Track Shutters Hardware Box

<b>Parts</b>
Wrench
Hinge Pin
Support L Bracket (based on the length of header)
2 ½ " screws for support L bracket
¾ " screws for support L bracket
Bottom Pivot Bracket
1 ½ " screws for bottom pivot bracket
2 ½ " screws for Frame with predrilled screw holes



# WOODLORE® PLUS

## Bi-fold 90

### Guidelines and Specs:

<u>Description</u>	<u>Minimum</u>	<u>Maximum</u>	
		1 7/8"	2 1/2" ; 3" ; 3 1/2" ; 4 1/2"
Single-Panel Width (Bi-fold Track) for Non-Waterproof option	6"	24"	24"
Single-Panel Width (Bi-fold Track) for Waterproof option	6"	24"	26"
Single-Panel Width (Multifold track up to 4 panels)	N/A	N/A	N/A
Single-Panel Height	10"	120"	120"

#### Outside Mount

Max frame-to-frame width: window width + 3 1/2"

Max frame-to-frame height: window height + 4 1/2"

#### Semi-Inside Mount

Max frame-to-frame width: window width - 1/8"

Max frame-to-frame height: window height + 1 3/8"

#### Inside Mount

Max frame-to-frame width: window width - 1/8"

Max frame-to-frame height: window height - 1/8"

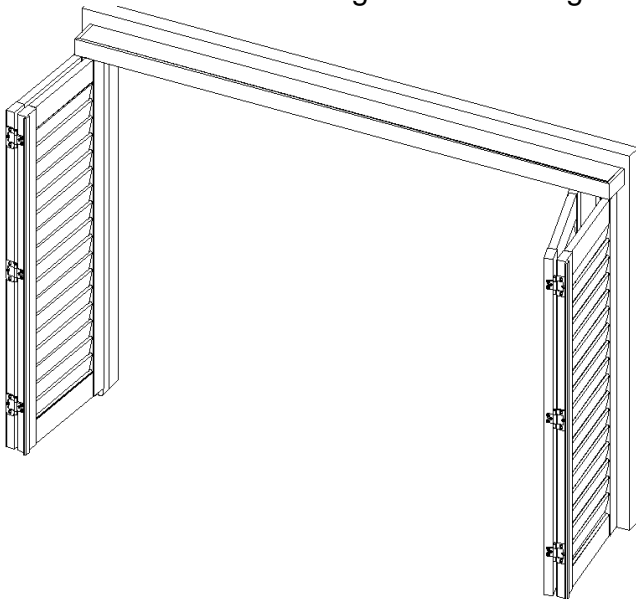

Track is pre-installed on the header; standard 1 track only.

# WOODLORE® PLUS

## Mounting Options: Outside Mount

### Side View

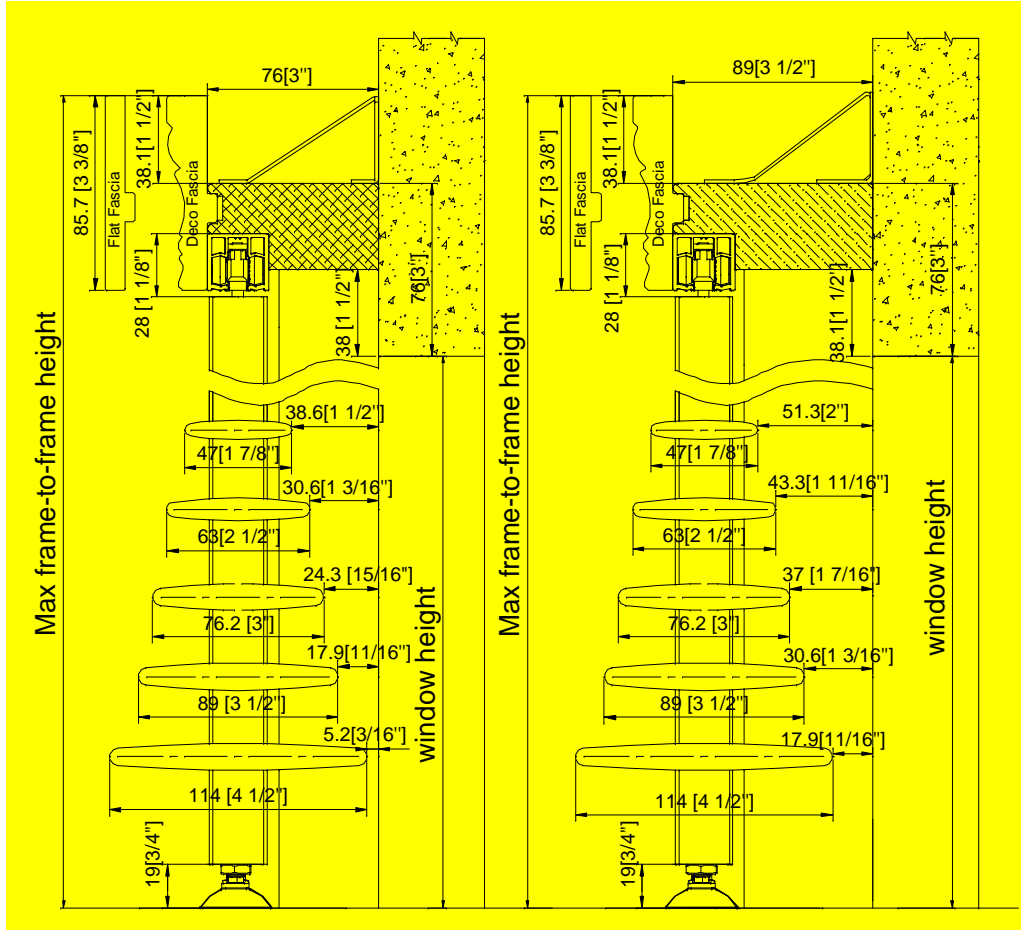

### Top View

#### Without Casing:

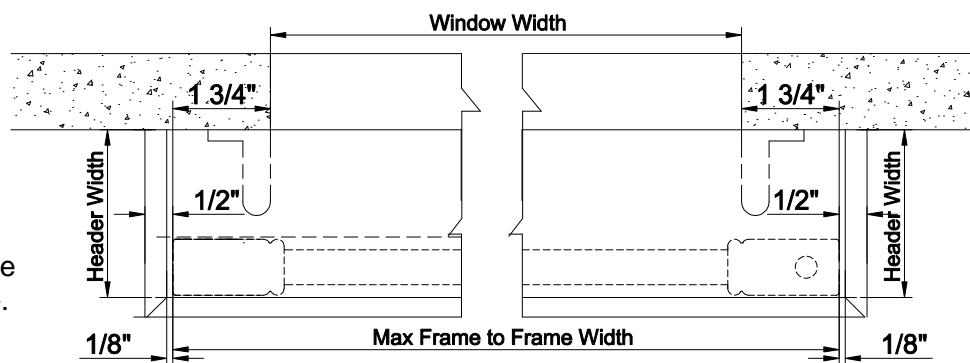

#### Note:

- ◇ Fascia return will protrude the panel about 1/2" for each side.
- ◇ The header will protrude the panel about 1/8" for each side.
- ◇ Header, light blocks, and bottom pivot bracket(s) must be installed on a flat surface.

# WOODLORE® PLUS

With Existing Casing:

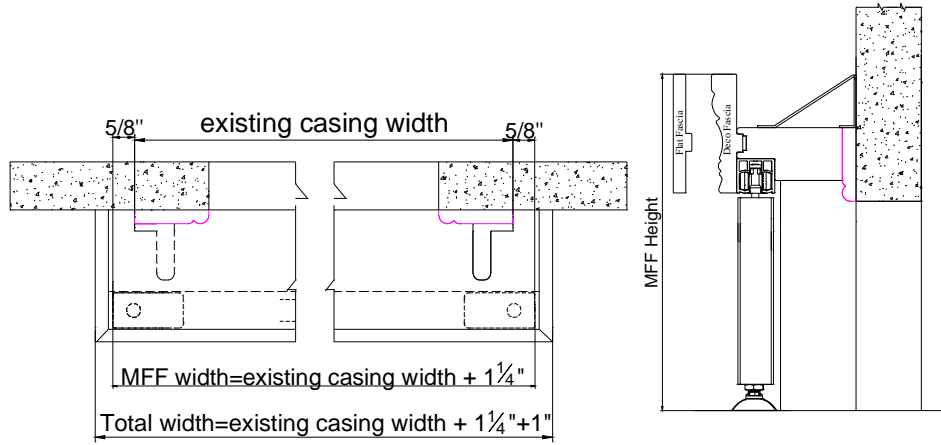

## Semi-Inside/Inside Mount

Side View

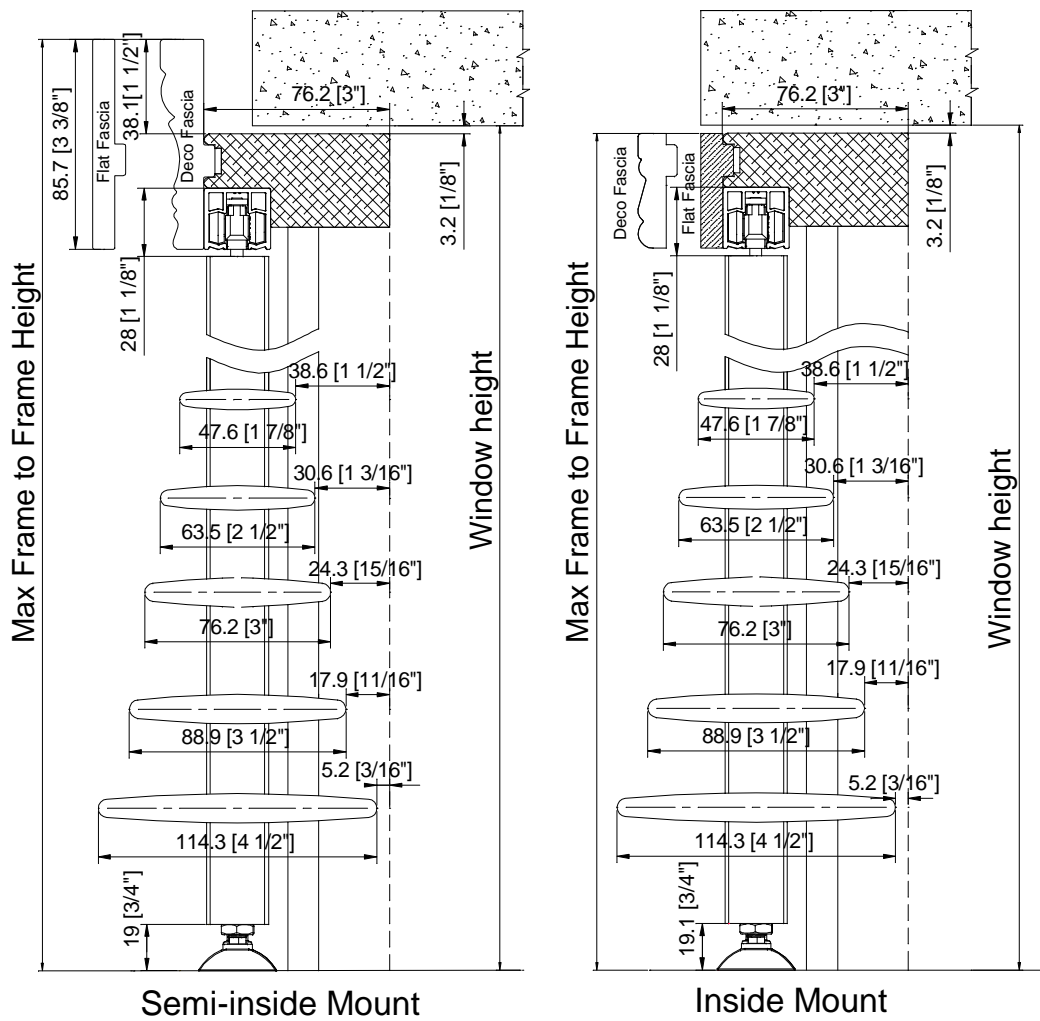

# WOODLORE® PLUS

## Semi-Inside Mount Top View

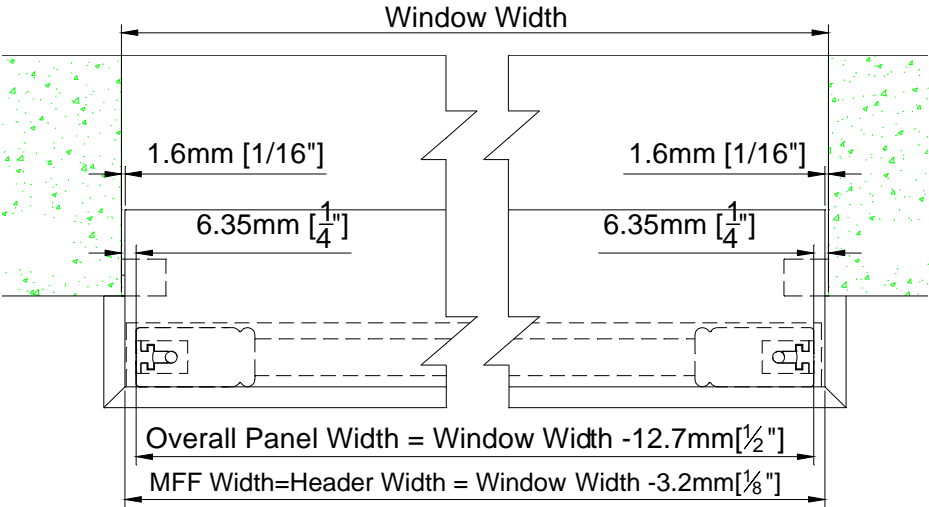

## Inside Mount Top View

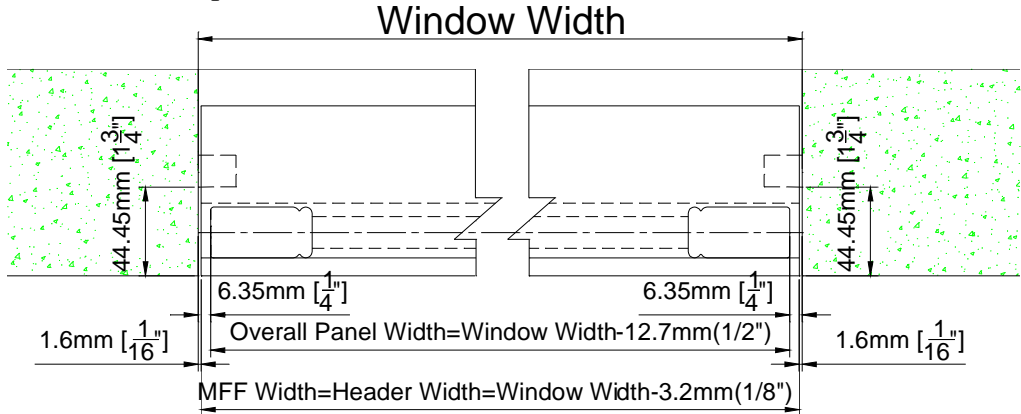

- ✧ Header Extension: Optional.
- ✧ Custom extension up to 2" for Header
- ✧ The extension will be pre-attached.

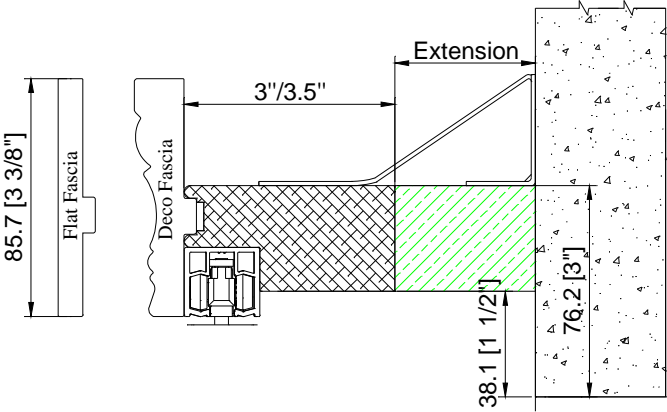

# WOODLORE® PLUS

**Panel Configuration :** Only 2", 2 1/4" rabbet and butt stiles are available for non-waterproof option.  
Only 2" rabbet and butt stiles are available for waterproof option.  
Center stile is not available.

LL or RR

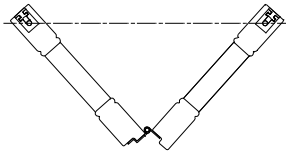

LLRR

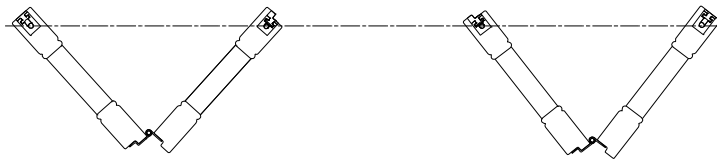

## 90° Floating Panels

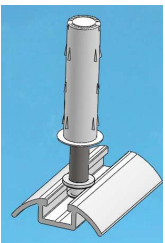
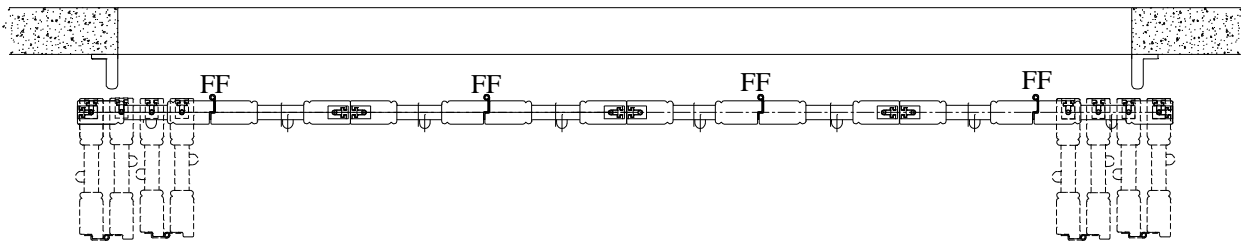

- Two panels can be hinged together, fold and slide to either direction
- Application comes with wheel carrier, spring loaded guide and floor track
- Can be used on large window

### Note:

1. For 90° Floating Panels outside mount/semi-inside mount without side boards, the 2016 Stopper will be supplied by default. The gap between the fascia return / end of top track and the panel is 5mm each side.

The 2016 stopper can also be used in the center or any position of the top track as an option.

### 2016 Stopper

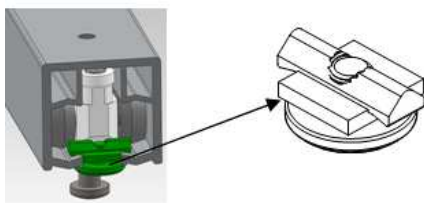

# WOODLORE® PLUS

Please see drawing below to show the gap.

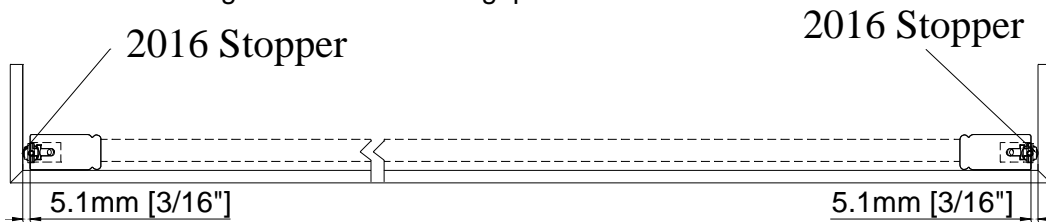

2. When rabbet stile required, the meeting stile of unHINGED stile will be butt stile by default.

## Optional (Hang Strip for Inside Mount Only, not available for Waterproof option)

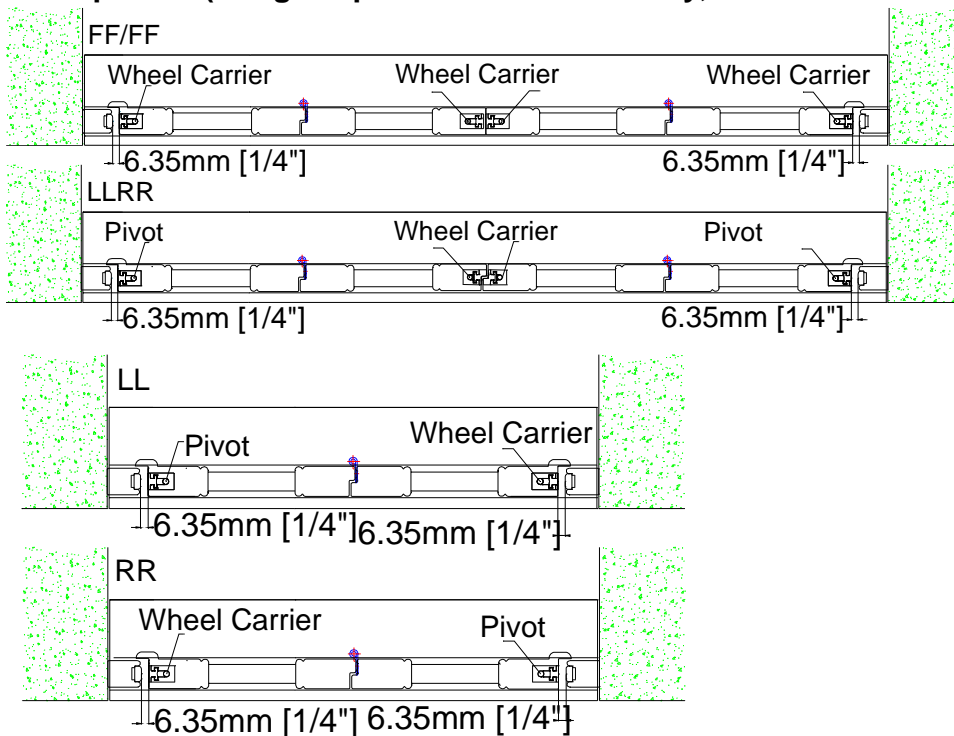

Note: When Butt/rabbet Stile is required, the stile next to the hang strip will be astragal stile.

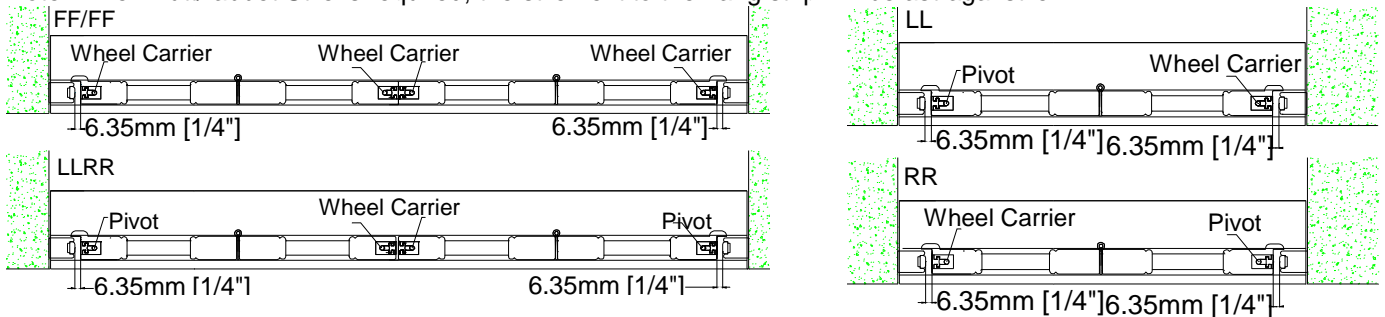

# WOODLORE® PLUS

## 90 degree Bi Fold Track Shutters Framing Materials (For Waterproof option, only plain fascia is available)

Type		Header Dimension	Top Fascia Dimension	Light Block Strip Dimension	Hang Strip Dimension
Header & Top Fascia & Light Block Strip	OM	3"	3 3/8"	1 9/16"	
		3 1/2"		2 1/16"	
	Semi-IM	3"	5/8"x3/4"		
	IM	3"	5/8"x3/4"		1.08"x0.875"

Note: It will be L shape light block strip for outside mount.

## Frame Hinged Bifold (Not available for Waterproof option)

Available Stile: Rabbet Stile Only

Available Frame type

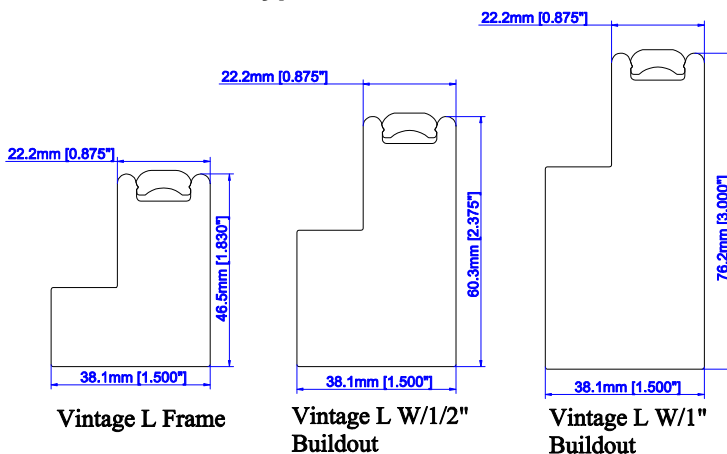

**Vintage Hang Strip with 13mm light block:** For single direction shutter with even panel qty, the frame on the unhinged side will be Vintage Hang Strip with 13mm [0.512"] light block, the height of the Vintage Hang Strip will match with that of the hinged side frame. The Vintage Hang Strip will be made in wood with surcharge.

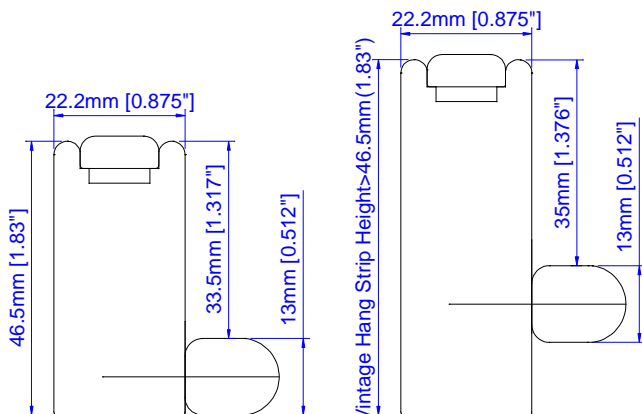

# WOODLORE® PLUS

**Top View**

Hinged at Left or Right with wheel assembly at top;

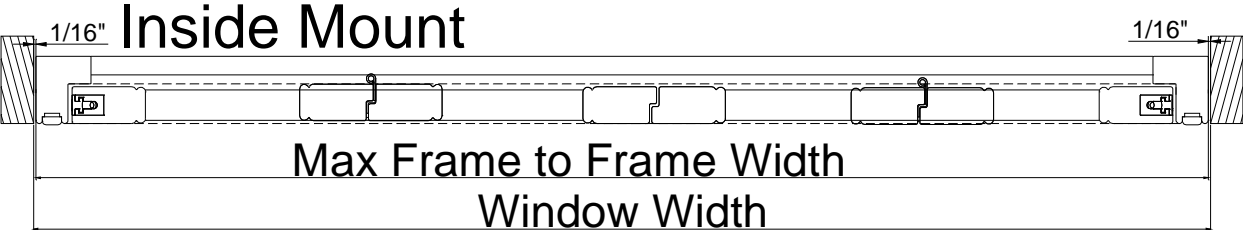
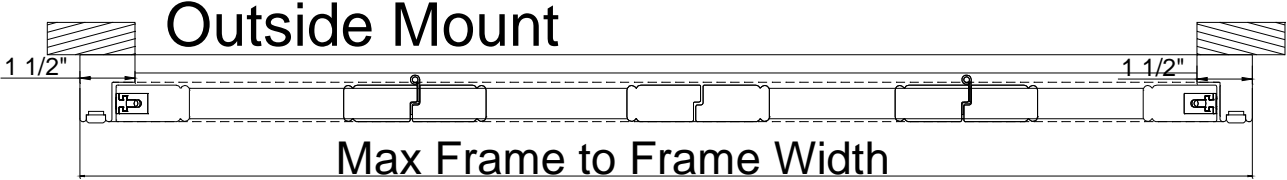

**Side View**

Outside Mount

3-Sides + bottom light block

3-Sides + 3" Deco Sill Frame

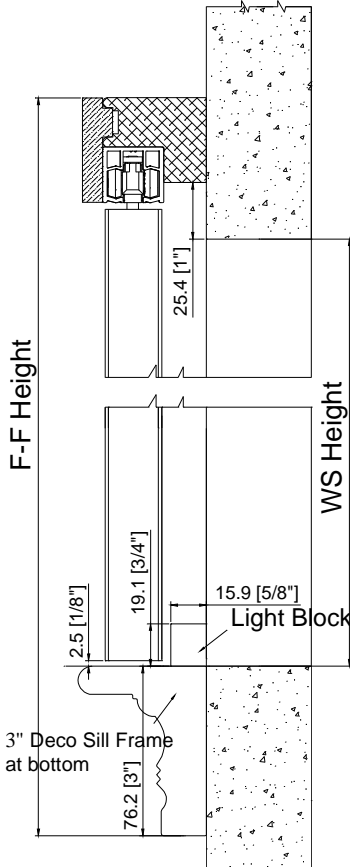
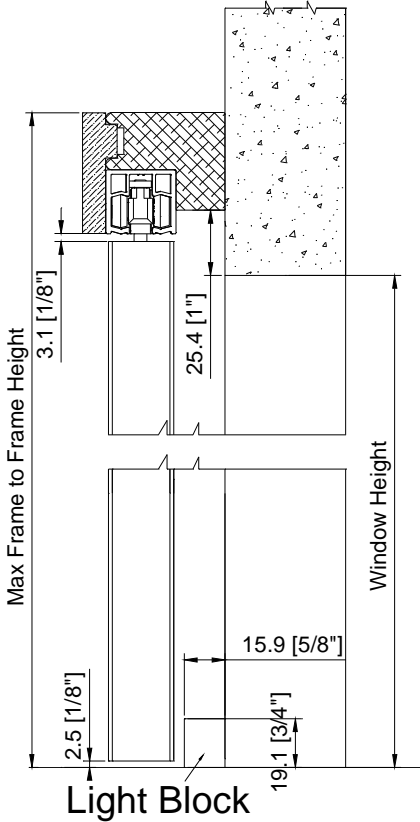



# WOODLORE® PLUS

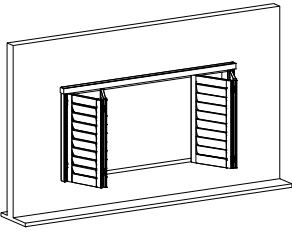

Note: For OM Frame Hinged Bifold shutter not to use as a door, if there is no existing sill at the bottom of the window opening, it is recommended to have the 3" Deco Sill Frame at the bottom.

Semi-Inside

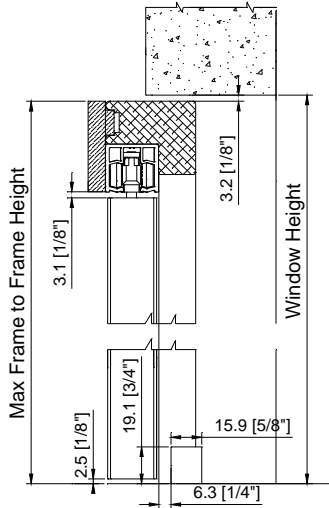

Inside Mount

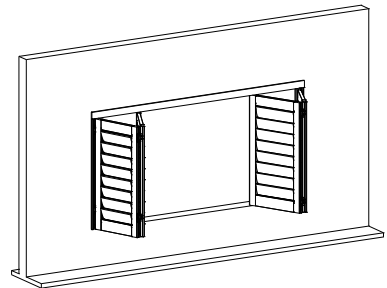
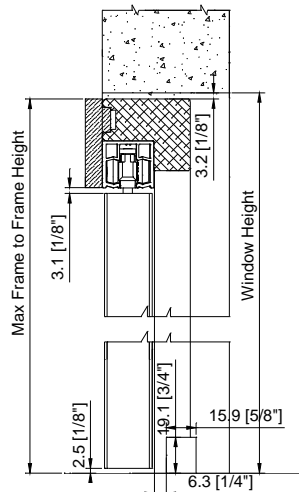

**For frame hinged bifold track shutter used as door, the bottom gap will be 19mm by default. Please specify "Used As Door" on the order form.**

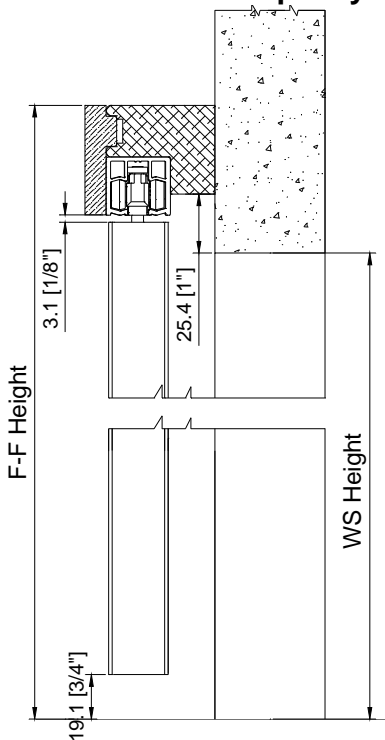

# WOODLORE® PLUS

## Panel Configuration (uneven panel width)

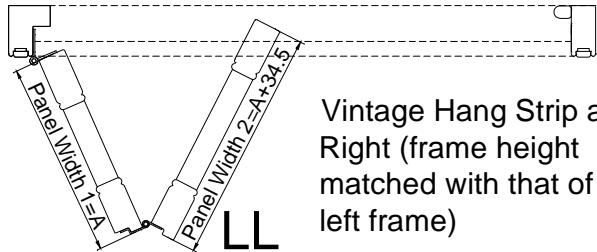

Vintage Hang Strip at Right (frame height matched with that of the left frame)

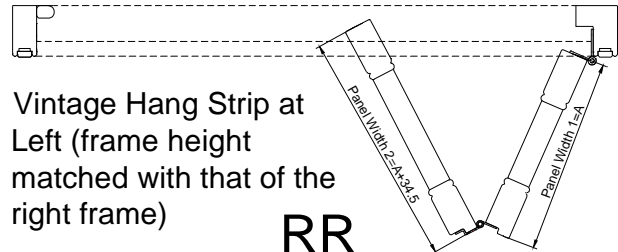

Vintage Hang Strip at Left (frame height matched with that of the right frame)

RR

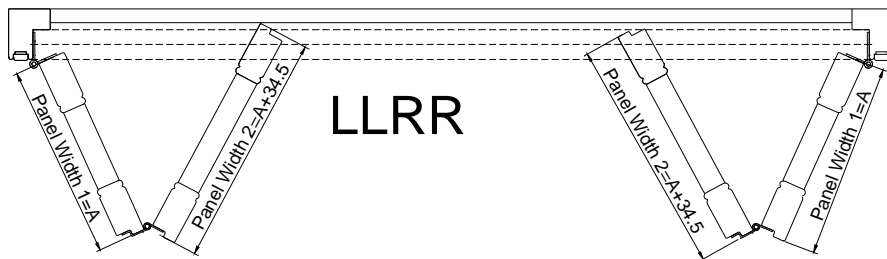

LLRR

### Notes:

1. Only available for 3-Sides + bottom light block or 3-Sides + 3" Deco Sill Frame (4-sides is not available); Panels can be folded and open at 90 degree;

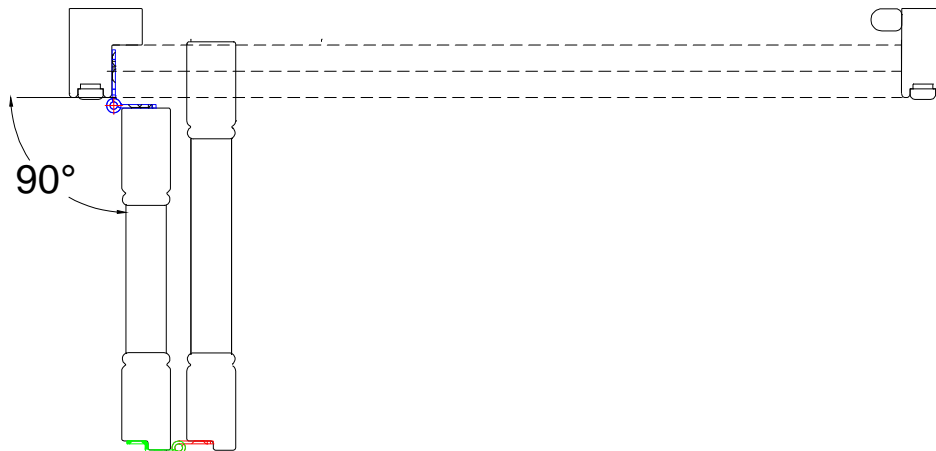

### 2. Frames available: Only Vintage L Frame

- 1) For top frame, the insert will be replaced by top fascia;
- 2) Top track will be pre-attached to the top frame;
- 3) Frame will be pre-drilled with screw holes same as regular shutters.

# WOODLORE® PLUS

**Ring Pull:** The ring pull will be provided as option; and for frame hinged bi-fold, the ring pull will be supplied as default; Customer need specify ring pull location on the order form. Ring pull location is measured from the floor to center of the ring pull in height direction.

Ring pull color will match the hinge color.

Please refer to below drawing of ring pull position for all shutter type:

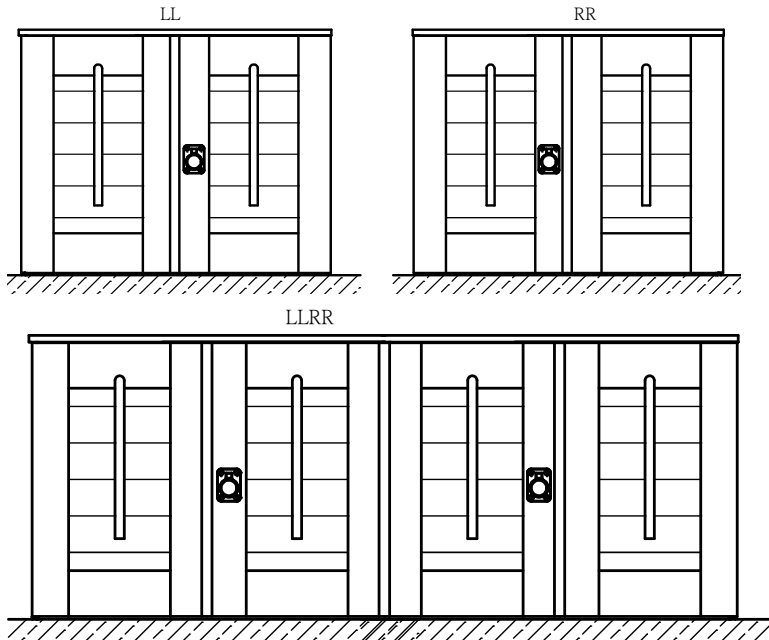

## Bottom Pivot Bracket for 90 degree bifold:

For 90° Bifold Track Shutter, there will be 2 types of Bottom Pivot Brackets available.

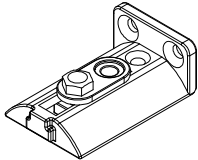

For Inside Mount, Bottom Pivot L Bracket will be supplied as default;

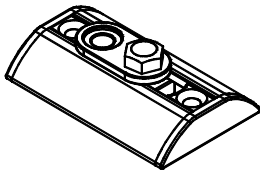

For Semi-Inside or Outside Mount, bottom pivot bracket will be supplied as default.

For 180° Bifold Track Shutter, 81mm Bottom Pivot L Bracket will be supplied as default.

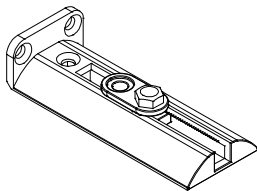

# WOODLORE® PLUS

**Track Dimension:**

Top Track

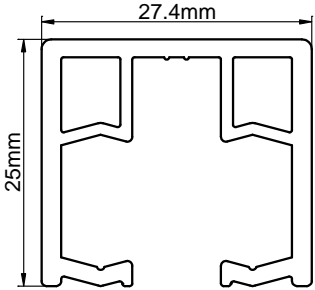

**Extra Magnets will be supplied for Bifold hinges: (only for the most top and bottom hinges, not available for Waterproof option)**

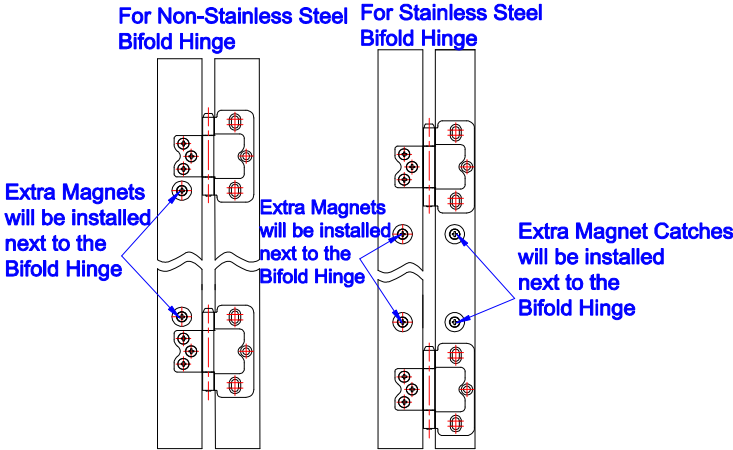

**Side Magnet:** applied to the meeting stiles of LR panels, not available for Waterproof option

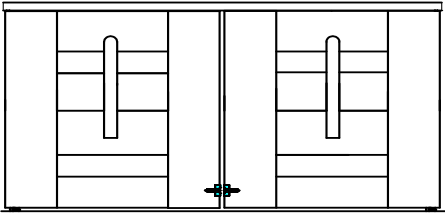

**Extra magnet and Side Magnet (Not available for Waterproof option)**



# WOODLORE® PLUS

## 90° Bi Fold Track Shutters Hardware Box

Parts
Wrench
Hinge Pin
Support L Bracket (based on the length of header)
2 ½ " screws for support L bracket
¾ " screws for support L bracket
Bottom Pivot Bracket
38.1mm screws for bottom pivot bracket
63.5mm screws for Frame with predrilled screw holes

### Notes:

1. for all bifold track shutter Outside Mount, the header will be pre-drilled with screw holes in the insert and screws will be supplied by default;
2. for all bifold track shutter Inside/Semi-Inside Mount, the header will be pre-drilled with holes for screws and wood plug and screws and wood plug will be supplied by default

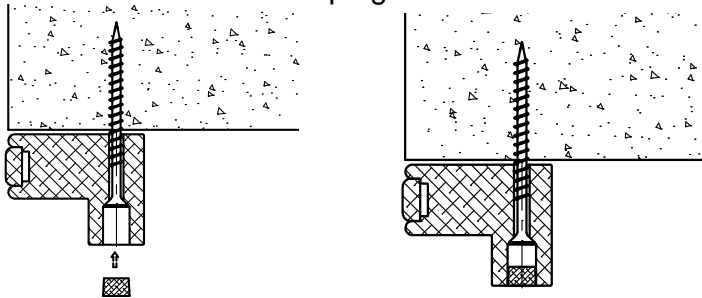

3. For both 90° & 180° bi-fold track, for waterproof option, when 3" header is selected, the header will make as 2 3/8" (Vintage L frame for waterproof option) + 5/8" extension.

When 3 1/2" header is selected, the header will make as 2 3/8" (Vintage L frame for waterproof option) + 1 1/8" extension.

The extension for both header sizes will be pre-attached.

4. For waterproof option, only plain fascia is available.

# WOODLORE® PLUS

## Keystone for Fascia of the Track Shutter

When fascia length exceeds the limitation and needs to split, keystone design fascia will be supplied without surcharge for track shutters.

For fascia length within the split limitation, keystone can also be supplied as an option with surcharge.

For Deco Fascia:

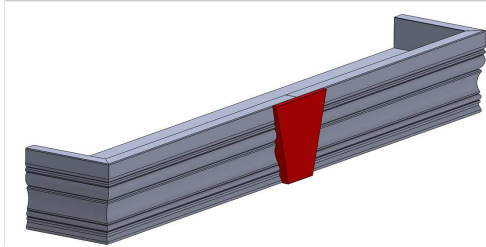

For Flat Fascia:

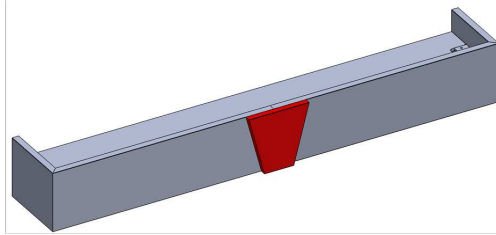

The keystone will be installed by screws. We will pre-drill the screw holes and the screws will be packed in hardware box.

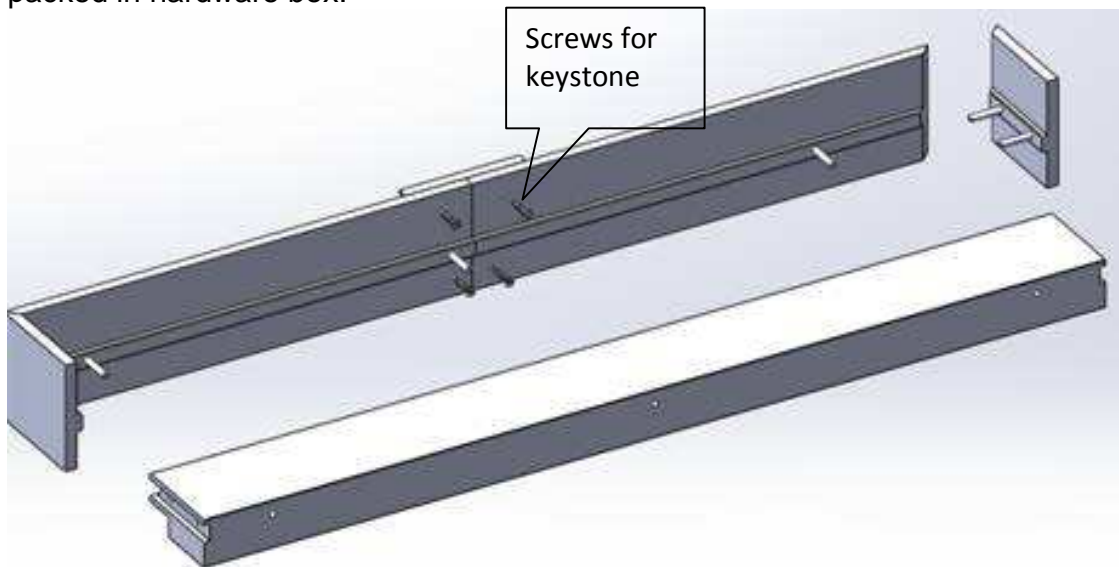

## Special Options

### Café Shutters\*

- The top of the panel requires a special finish. Please indicate “café shutter” when placing orders.
- The shutter does not come with recessed magnet on top.
- **When the height of the framing material (including t-posts) exceeds the panel height, by more than 5", a surcharge will apply.**

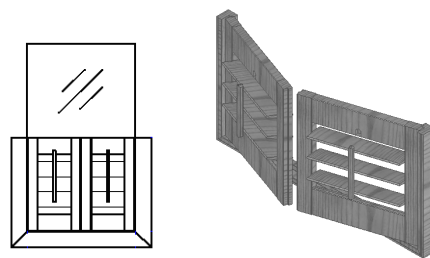

### Double-Hung Shutters\*

- For total number of panels, please include panels in both rows.
- Bifold panel is not available under this option.
- For panel configuration, please provide panel fold for one row.
- The default location for the division point is the center unless specified otherwise.
- Horizontal T Post\* can be added for increased structural integrity.
- Warranty needs to be waived for the horizontal T post length exceeds 48”.

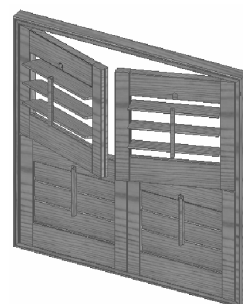
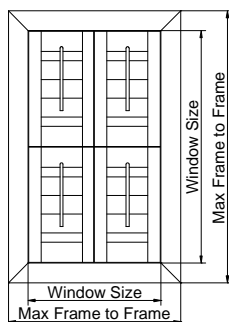

### Fixed Louvers

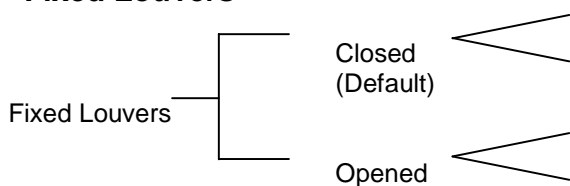

Dress Down  
Dress Up  
Dress Down  
Dress Up

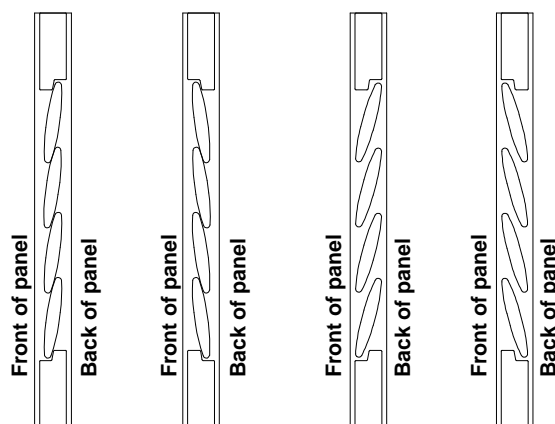

\*Some surcharges apply

# WOODLORE® PLUS

## Special Options (continued)

### French Door Cut-out Collection\*

- Flush and offset cutout options are available in both curved and square French door cutout.
  - ◊ Offset cutout is good option for French Door with molding around the glass.
- All French door cutouts are only available in L frame except Type E and F. The batten is placed behind the Type E/F panel to block light.

Louver size	Batten Width	Batten thickness
1 7/8" & 2 1/2"	3/4"	1"
3" & 3 1/2"	3/4"	1 3/8"
4 1/2"	3/4"	1 7/8"

- For measurement details please refer to Form section.
- French Door cutouts with Arch/Quarter Arch at the top are also available except Type E and F

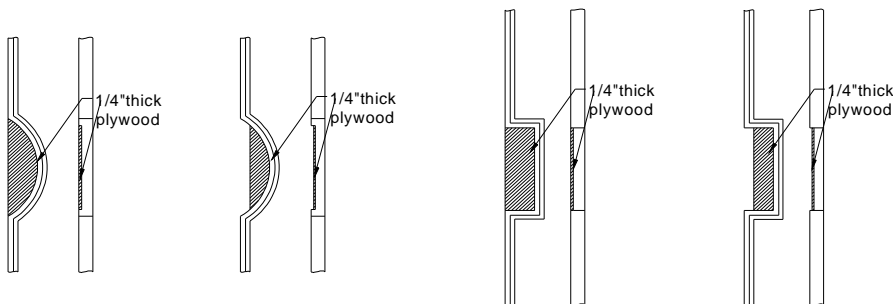

Type A

Type B

Type C

Type D

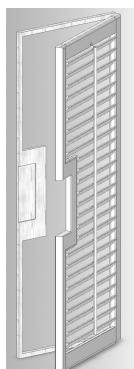

Type E

Type F

**Type E & Type F are Not available for Waterproof woodlore plus.**

\*Some surcharges apply



# WOODLORE® PLUS

## Special Options (continued)

### Custom Colors \*

Available in Woodlore® plus, Woodlore® plus Waterproof shutters.

Option (Color Code)	Sample Size	<u>Confirmation Process</u>
<b>Custom Solid (C01)</b>	A least 4"x4" on a clean, flat surface, such as wood or cardboard (please do not send anything critical as the sample will not be returned)	All orders require customer's confirmation via <b>digital photo OR actual swatch</b> in the mail before production. An additional shipping and Custom handling fee applies.

Note:

- 1) All custom colors will be finished with the standard gloss used on all Norman products.
- 2) Please be aware that we will only be able to match the tone and not the texture or finish of the sample you submit.
- 3) Only one color revision will be allowed during the color confirmation process.
- 4) Customer may shorten the production lead-time by opting to waive the color confirmation process or by approving a digital photo. Norman will not be responsible for any color variation on waived confirmations or approved digital photos.

Disclaimer:

Sherwin Williams ColorSnap (MWCS),  
Sherwin Williams Designer Expressions (MWDE),  
Benjamin Moore Classic (MBMC) (M2460009TL) &  
Benjamin Moore Preview (MBMP) (M2440564TL)

**Benjamin Moore, Off White Collection M2451888TL**

are registered trademarks or trademarks of their respective owners. All other trademarks mentioned herein are the property of Norman International, Inc. and/or its affiliates in the U.S. and certain other countries. Reference herein to the commercial products or service of others by trade name, trademark, manufacturer, or otherwise, does not necessarily constitute or imply its endorsement.

## Specialties

### Specialty Shutters for Waterproof option:

Specialty shutters are made from waterproof ABS co-polymer, finished to match the beauty of all Norman shutters. Templates are required if it is an imperfect specialty. Delivery time is 8 weeks from the order confirmation date for all specialty shutters. Please refer to Specialties and Template Requirement sections for details.

Continuous Arch is not available for Waterproof option.

#### Regarding frame with an insert or solid frame issue:

- 1). For Woodlore plus waterproof option, no matter which type of specialty shutters, 2" Camber deco frame will always be made as solid frame;
- 2). For Half Round Sunburst, Quarter Round Sunburst, Eyebrow Sunburst & Elongated Eyebrow Sunburst:  
All Vintage L frames & 1 1/2" Deep Bullnose Z frame & Deep Plain L frame: all top frames (curve shape frame) will be made as a solid frame but the bottom & both sided frames (straight frames) will be made as regular frames with inserts.
- 3). For Triangle, Hexagon, Octagon, Peak & Angle top: all Vintage L frames & 1 1/2" Deep Bullnose Z frame & Deep Plain L frame will be made as regular frames with inserts.
- 4). For Circle, Oval: all Vintage L frames & 1 1/2" Deep Bullnose Z frame & Deep Plain L frame will be made as solid frames (not with an insert).
- 5). For Sunburst on top with Divider strip: the top Vintage L frame & 1 1/2" Deep Bullnose Z frame & Deep Plain L frame (curve shape frame) will be made as a solid frame but the bottom & both sided frames (straight frames) will be made as regular frames with inserts.
- 6). For Louver Arch with Eyebrow curve shape:  
All Vintage L frames & 1 1/2" Deep Bullnose Z frame & Deep Plain L frame: the top frame (curve shape frame) will be made as a solid frame but the bottom & both sided frames (straight frames) will be made as regular frames with inserts;
- 7). For other Specialty Shutters when curve shape is similar as perfect arch (such as Louver Arch except Louver Arch with Eyebrow curve shape in point 6), Horizontal louvers center arch with quarter round side panels(-Standard louvered arch), Sunburst louvers center arch with quarter round side panels, Arch Top Picture Window with horizontal louvers, Arch Top Picture Window with Sunburst, Standard unit with horizontal arch center etc.):  
All Vintage L frames & 1 1/2" Deep Bullnose Z frame & Deep Plain L frame: all top frames (curve shape frame) will be made as a solid frame but the bottom & both sided frames (straight frames) will be made as regular frames with inserts.

## Hardwood Specialty Shape

### Specialty Shutters for non-waterproof option:

Specialty shutters are made of premium solid wood, finished to match the beauty of all Norman shutters. Templates are required if it is an imperfect specialty. Delivery time is 8 weeks from the order confirmation date for all specialty shutters. Please refer to Specialties and Template Requirement sections for details.

#### Regarding frame with an insert or solid frame issue:

1). For Half Round Sunburst, Quarter Round Sunburst, Eyebrow Sunburst & Elongated Eyebrow Sunburst:

- All deco frames will be made as solid frames;
- All Vintage L frames & Vintage hang strip: all top frames (curve shape frame) will be made as a solid frame but the bottom & both sided frames (straight frames) will be made as regular frames with inserts

2). For Triangle, Hexagon, Octagon, Peak & Angle top: all frames will be made as regular frames with inserts.

3). For Circle, Oval: all frames will be made as solid frames (not with an insert).

4). For Sunburst on top with Divider strip: the top frame (curve shape frame) will be made as a solid frame but the bottom & both side frames (straight frames) will be made as regular frames with inserts.

5). For Louver Arch with Eyebrow curve shape:

- All deco frames excluding 2.5" Mission deco frame: all frames will be made as solid frames (not with an insert).
- All Vintage L frames & Vintage hang strip & 2.5" Mission deco frame: the top frame (curve shape frame) will be made as a solid frame but the bottom & both sided frames (straight frames) will be made as regular frames with inserts;

6). For other Specialty Shutters when curve shape is similar as perfect arch (such as Louver Arch except Louver Arch with Eyebrow curve shape in point 5), Horizontal louvers center arch with quarter round side panels(-Standard louvered arch & Continuous arch), Sunburst louvers center arch with quarter round side panels, Arch Top Picture Window with horizontal louvers, Arch Top Picture Window with Sunburst, Standard unit with horizontal arch center etc.):

- All deco frames will be made as solid frames;
- All Vintage L frames & Vintage hang strip: all top frames (curve shape frame) will be made as a solid frame but the bottom & both sided frames (straight frames) will be made as regular frames with inserts.

# WOODLORE® PLUS

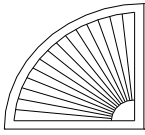

**Quarter Round Sunburst**

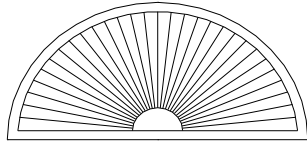

**Half Round Sunburst**

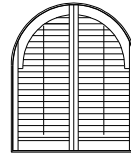

**Louvered Arch w/ Center Tilt Rod**

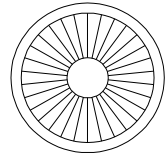

**Circle Sunburst**

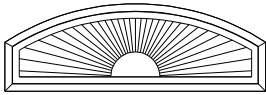

**Elongated Eyebrow Sunburst**

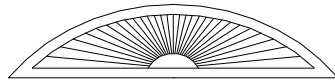

**Eyebrow Sunburst**

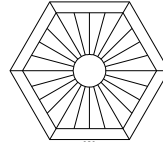

**Hexagon Sunburst**

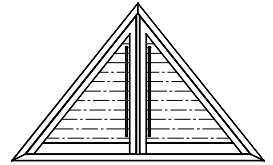

**Triangle**

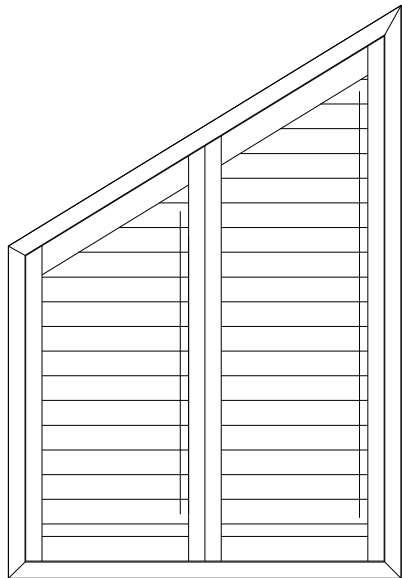

**Angle Top**

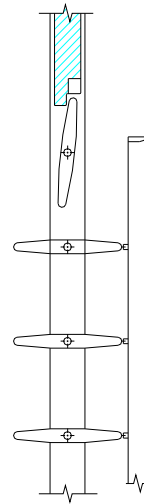

**\*Top louver of angle top might be fixed as shown**

\*Some surcharges apply

WLP I-3

# WOODLORE® PLUS

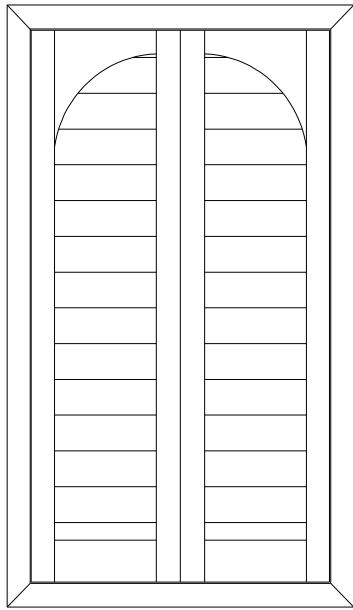

Louver Arch in a Rectangle

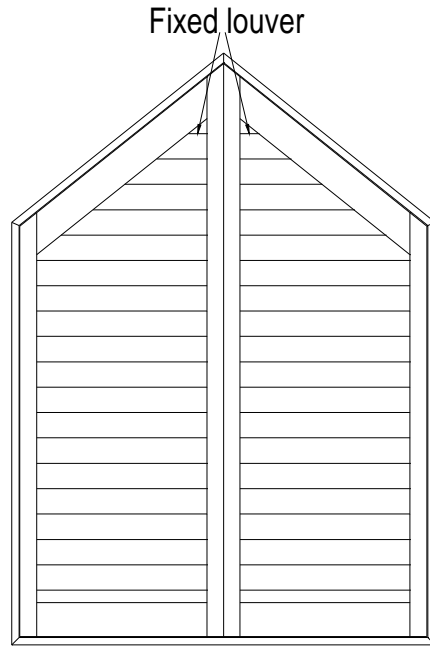

Fixed louver

Peak

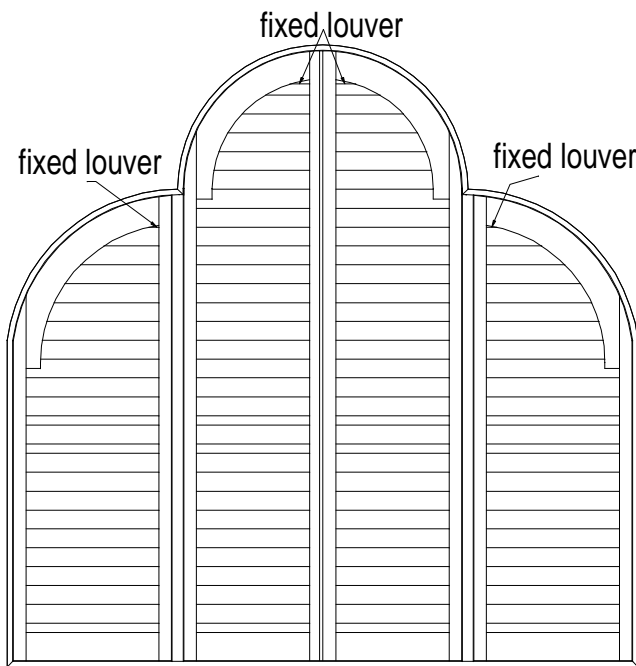

Horizontal louvers center arch with quarter round side panels  
-Standard louvered arch

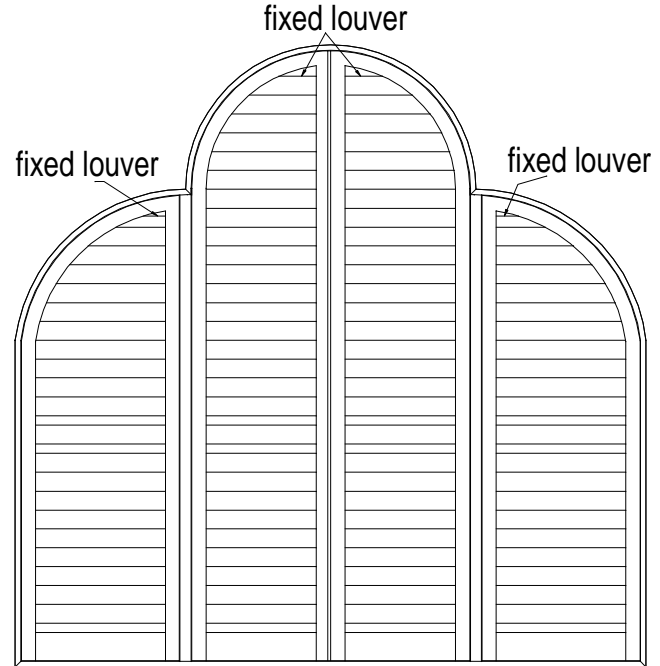

Horizontal louvers center arch with quarter round side panels  
-Continuous arch  
Not available for Waterproof option.

\*Some surcharges apply

WLP I-4

# WOODLORE® PLUS

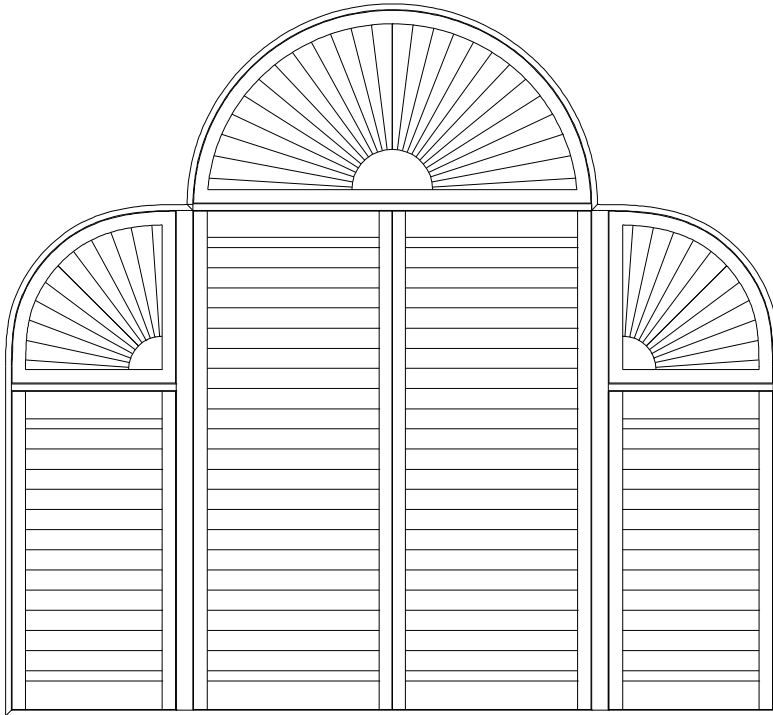

Sunburst louvers center arch with quarter round side panels

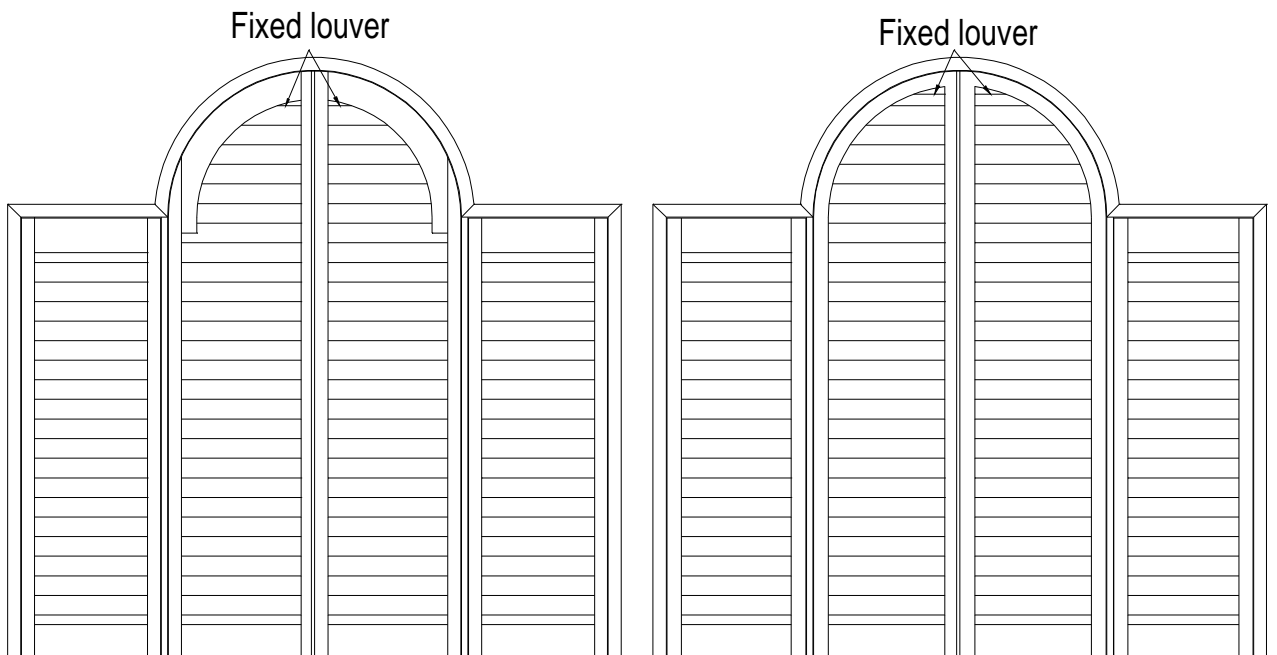

Arch Top Picture Window with horizontal louvers  
-Standard louvered arch

Arch Top Picture Window with horizontal louvers  
-Continuous arch  
Not available for Waterproof option.

\*Some surcharges apply

WLP I-5

# WOODLORE® PLUS

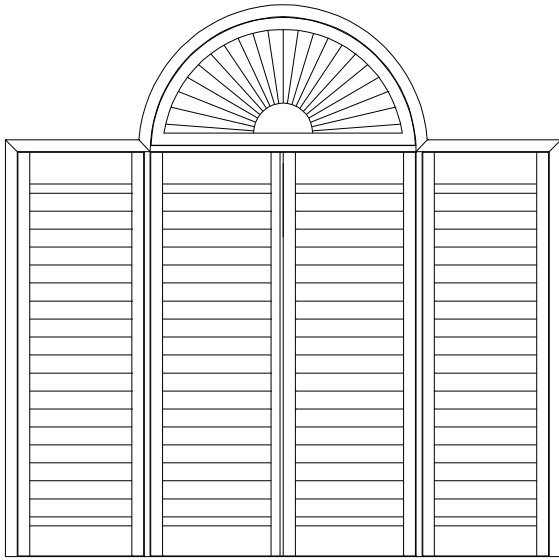

Arch Top Picture Window with Sunburst

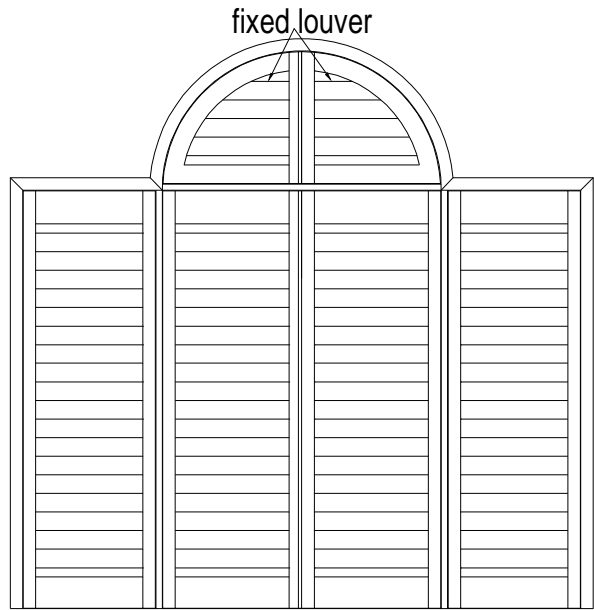

Standard unit with horizontal arch center

\*Some surcharges apply

WLP I-6

# WOODLORE® PLUS

## Pricing

<b>1) By Max Frame-to-Frame Measurement:</b>						
<b>Regular Shutter</b>						
Inside and Outside Mount	Width	x	Height	/ 144	x	\$/sq ft
<b>Track Shutter**</b>						
Inside	Width	x	Height	/ 144	x	\$/sq ft
Semi-Inside and Outside Mount	Width	x	(Height-1½")	/ 144	x	\$/sq ft
<b>2) By Net Panel Measurement:</b>						
	Width	x	Height	/ 144	x	\$/sq ft
<b>3) By Window Size:</b>						
<b>2" Camber Deco Frame</b> <b>2" Classic Deco Frame</b>	4-sided	(Width+4")	x	(Height+4")	/ 144	x \$/sq ft
	3-sided with Sill Plate	(Width+4")	x	(Height+4")	/ 144	x \$/sq ft
	3-sided	(Width+4")	x	(Height+2")	/ 144	x \$/sq ft
	2 sided with Sill Plate	(Width+4")	x	(Height+2")	/ 144	x \$/sq ft
	2-sided	(Width+4")	x	(Height)	/ 144	x \$/sq ft
<b>3" Ridge Deco Frame</b>	4-sided	(Width+6")	x	(Height+6")	/ 144	x \$/sq ft
	3-sided with Sill Plate	(Width+6")	x	(Height+6")	/ 144	x \$/sq ft
	3-sided	(Width+6")	x	(Height+3")	/ 144	x \$/sq ft
	2-sided with Sill Plate	(Width+6")	x	(Height+3")	/ 144	x \$/sq ft
	2-sided	(Width+6")	x	(Height)	/ 144	x \$/sq ft
<b>2.5" Mission deco frame</b>	4-sided	(Width+5")	x	(Height+5")	/ 144	x \$/sq ft
	3-sided	(Width+5")	x	(Height+2.5")	/ 144	x \$/sq ft
	2-sided	(Width+5")	x	(Height)	/ 144	x \$/sq ft
<b>3" Crown Z Frame</b>	4-sided	(Width+4 ½")	x	(Height+4½")	/ 144	x \$/sq ft
	3-sided with Sill Plate	(Width+4 ½")	x	(Height+4½")	/ 144	x \$/sq ft
	3-sided	(Width+4 ½")	x	(Height+2¼")	/ 144	x \$/sq ft
	2-sided with Sill Plate	(Width+4 ½")	x	(Height+2¼")	/ 144	x \$/sq ft
	2-sided	(Width+4 ½")	x	(Height)	/ 144	x \$/sq ft



# WOODLORE® PLUS

## Pricing

2" Bel Air Z Frame 2" Bullnose Z Frame	4-sided	(Width+2 ½")	x	(Height+2½")	/ 144	x	\$/sq ft
	3-sided with Sill Plate	(Width+2 ½")	x	(Height+2½")	/ 144	x	\$/sq ft
	3-sided	(Width+2 ½")	x	(Height+1¼")	/ 144	x	\$/sq ft
	2-sided with Sill Plate	(Width+2 ½")	x	(Height+1¼")	/ 144	x	\$/sq ft
	2-sided	(Width+2 ½")	x	(Height)	/ 144	x	\$/sq ft
1 1/2" Bullnose Z Frame 1 ¼" Beaded Z Frame/ Bullnose Tilt Out Z Frame	4-sided	(Width+2")	x	(Height+2")	/ 144	x	\$/sq ft
	3-sided with Sill Plate (N/A w/ Tilt out Z)	(Width+2")	x	(Height+2")	/ 144	x	\$/sq ft
	3-sided	(Width+2")	x	(Height+1")	/ 144	x	\$/sq ft
	2-sided with Sill Plate (N/A w/ Tilt out Z)	(Width+2")	x	(Height+1")	/ 144	x	\$/sq ft
	2-sided	(Width+2")	x	(Height)	/ 144	x	\$/sq ft
Vintage Hang Strip Traditional Hang Strip	Inside	Width	x	Height	/ 144	x	\$/sq ft
	Outside 4-sided	(Width+3")	x	(Height+3")	/ 144	x	\$/sq ft
	Outside 3-sided	(Width+3")	x	(Height+1½")	/ 144	x	\$/sq ft
	Outside 2-sided	(Width+3")	x	(Height)	/ 144	x	\$/sq ft
Vintage L Frame/ Beaded L Frame	Outside 4-sided	(Width+3")	x	(Height+3")	/ 144	x	\$/sq ft
	Outside 3-sided	(Width+3")	x	(Height+1½")	/ 144	x	\$/sq ft
	Outside 2-sided	(Width+3")	x	(Height)	/ 144	x	\$/sq ft
<b>Track Shutter**</b>							
Inside and Semi-Inside Mount		Width	x	Height	/144	x	\$/sq ft
Outside Mount		(Width+3")	x	(Height+3")	/144	x	\$/sq ft