



**Implementation Guide
to the
Postsecondary Electronic Standards Council
XML Standard Format
for the
Application for Admission
to
Postsecondary Institutions**

Version 1.3.0

July 2016



© PESC 2017. All Rights Reserved.

This document may be copied and furnished to others, and derivative works that comment on or otherwise explain it or assist in its implementation may be prepared, copied, published and distributed, in whole or in part, without restriction of any kind, provided that the above copyright notice and this paragraph are included on all such copies and derivative works. This document itself, however, may not be modified in any way except when expressly approved by PESC for purposes of developing standards and specifications.

Send corrections, comments and requests for the IG in MS Word format to:

info@PESC.org

PESC XML Application for Admission Implementation Guide Version 1.3.0

Table of Contents	
Page	Description
2	Organization and Format
13	Start of the Admissions Application Schema
14	TransmissionData
17	... Source
18 Organization
23 LocalOrganizationID
24 Contacts
26 Address
29 Email
30 Phone
32 URL
33 Destination
34 Organization
38 LocalOrganizationID
39 Contacts
41 Address
44 Email
45 Phone
47 URL
48	Applicant
51 Person
57 AgencyIdentifier
58 Birth
60 Name
62 AlternateName
64 PreferredName
66 Citizenship
67 Contacts
73 PermanentAddress
76 MailingAddress
79 CurrentAddress
82 BillingAddress
85 CampusAddress
88 EmergencyAddress
91 TemporaryAddress
94 OtherAddress
97 PermanentPhone
99 BusinessPhone
101 CampusPhone
103 EmergencyPhone

PESC XML Application for Admission Implementation Guide Version 1.3.0

Table of Contents	
Page	Description
105	DayPhone
107	EveningPhone
109	FaxPhone
111	MobilePhone
113	PagerPhone
115	TemporaryPhone
117	OtherPhone
119	PreferredPhone
121	PrimaryEmail
122	BillingEmail
123	CampusEmail
124	EmergencyEmail
125	OtherEmail
126	URL
127	InstantMessage
128	Gender
129	EthnicityRace
130	CanadianEthnicityRace
131	PrivacyRestriction
132	Immigration
135	AsyleeRefugee
136	PermanentResident
137	CertificateOfEligibilityDetail
139	Sponsor
141	SponsorOrganization
145	Contacts
147	Address
150	Email
151	Phone
153	URL
154	FundingSource
156	FundingSourceContact
158	Address
161	Email
162	Phone
164	URL
165	SponsorPerson
169	Birth
171	Name
173	AlternateName
175	Contacts

PESC XML Application for Admission Implementation Guide Version 1.3.0

Table of Contents	
Page	Description
177Address
180Email
181Phone
183URL
184Gender
185Citizenship
186Deceased
187OccupationDetail
188Employer
192 PassportDetail
193 VisaDetail
195 I94Detail
196 Dependent
197Name
199Birth
201Citizenship
202 OptionalPracticalTraining
203 CurricularPracticalTraining
204 AcademicTraining
205 Employment
207 Employer
211Contacts
213Address
216Email
217Phone
219URL
220 Language
222 Family
224 FamilyMember
228 Birth
230 Name
232 AlternateName
234 Contacts
236Address
239Email
241Phone
242URL
243 Gender
244 Marital
245 EthnicityRace
246 Citizenship

PESC XML Application for Admission Implementation Guide Version 1.3.0

Table of Contents	
Page	Description
247Deceased
248OccupationDetail
249Employer
253Legacy
254FamilyLegacy
255FamilyIncome
256Residency
262ResidentName
264FinancialDependency
265DriversLicense
266StateIdentification
267VoterRegistration
269VehicleRegistration
270EmploymentResidency
271EmploymentAtAppliedSchool
272IncomeTaxInformation
273PropertyOwned
274PublicAssistanceReceived
275ActiveDutyMilitary
276Application
281ApplicationDetail
283ApplicationSession
285ApplicationDegreeProgram
288ApplicationQuestion
291AllowedAnswers
292AcademicProgramDetail
293ApplicationOrganization
297LocalOrganizationID
298RecommendationReference
299RefereeName
301RefereeContacts
303Address
306Email
307Phone
309URL
310RefereeOrganizationc
314ApplicationQuestion
316AllowedAnswers
317AdditionalStudentAchievements
318Language
320OtherStudentAchievement

PESC XML Application for Admission Implementation Guide Version 1.3.0

Table of Contents	
Page	Description
323PlanToApplyFor
324DecisionToApply
325ApplyDecision
326HousingInformation
327InformationRequested
328ApplicationFee
330ActivityParticipationRequest
331PreviousApplication
332OtherCollegeApplication
333OtherCollege
334Sponsor
336ApplicationID
338ApplicationSource
340GovernmentMilitary
342SelfReportedAcademicRecord
346School
351LocalOrganizationID
352Contacts
354Address
357Email
358Phone
360URL
361StudentLevel
362AcademicAward
366AcademicHonors
367AcademicAwardProgram
370AcademicDegreeRequirement
371AcademicSummary
373GPA
377AcademicHonors
378AcademicSession
380AcademicSessionDetail
382StudentLevel
384AcademicProgram
387AcademicProgramDetail
388Course
396Requirement
398Attribute
400Proficiency
402Licensure
403Language of Instruction

PESC XML Application for Admission Implementation Guide Version 1.3.0

Table of Contents	
Page	Description
404UserDefinedExtensions
405 AcademicSummary
409GPA
411AcademicHonors
412 AdditionalStudentAchievements
413 Language
414 OtherStudentAchievement
416 HighSchoolSubjectArea
417 ClassRank
418 AcademicProgram
421 AcademicProgramDetail
422 SelfReportedTests
424 StudentLevel
425 EducationSubtest
426 ExtraCurricularActivity
432	Appendix A: State and Province Codes
435	Appendix B1: Country Codes (ISO) – Sorted by Codes
442	Appendix B2: Country Codes (ISO) – Sorted by Country Name
449	Appendix C1: Language Codes (ISO) – Sorted by Language Code
466	Appendix C2: Language Codes (ISO) – Sorted by Language Name
484	Appendix D: Relationship Codes
488	Appendix E: Religious Affiliation Codes
490	Appendix F: US Visa Type Codes – Sorted by Visa Code
494	Appendix G1: Birth Country Codes for US SEVIS Data Elements – Sorted by Birth Country Code
503	Appendix G2: Birth Country Codes for US SEVIS Data Elements – Sorted by Birth Country Name
512	Appendix H1: Citizenship and Residence Country Codes for US SEVIS Data Elements – Sorted by Country Code
520	Appendix H2: Citizenship and Residence Country Codes for US SEVIS Data Elements – Sorted by Country Name
528	Appendix J1: US Passport Issuing Country Codes for US SEVIS Data Elements – Sorted by Country Code
536	Appendix J2: US Passport Issuing Country Codes for US SEVIS Data Elements – Sorted by Country Name
544	Appendix K: US Port of Entry Codes for US SEVIS Data Elements
551	Appendix L: US Visa Issuing Post Codes for US SEVIS Data Elements
558	Appendix M1: Student Activity Codes – Sorted by Major Category, then by Activity
562	Appendix M2: Student Activity Codes – Sorted by Activity
567	Appendix N: Education Test Codes and Test Names
571	Appendix P: Education Subtest Codes and Subtest Names
574	Appendix Q: Academic Grade Scale Codes
579	Appendix S: US Exchange Visitor Position Codes for SEVIS

PESC XML Application for Admission Implementation Guide Version 1.3.0

Table of Contents	
Page	Description
583	Appendix T: Sample Instance Document
593	Appendix U: Changes Made to the PESC XML Admissions Application Schema Since Version 1.0.0
595	Appendix V: List of Members of the Original Development Workgroup

Organization and Format

The schema for the Application for Admission is made up of four main parts:

1. Transmission Data
2. Applicant
3. Note Message
4. User Defined Extensions

However, three of these main parts branch to form other parts, which in turn branch out further.

The heading for each level and sub-level indicates the position of the subsequent diagram in the larger Schema.

Following the heading, the diagram serves to illustrate its relationship with the preceding branch. All diagrams in this Guide were copied from a graphical representation of the Application for Admission Schema using a software package from Altova Corporation called XMLSpy.

Example:

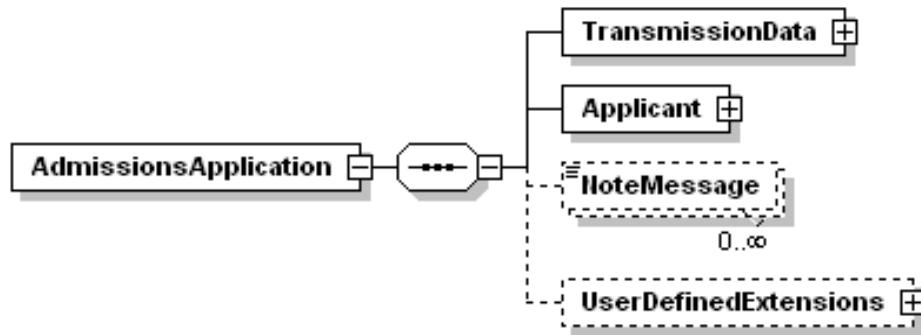

Boxes in Diagrams: The boxes in the diagrams can illustrate two separate components of the Schema. First, certain boxes show data element groupings (also called complex data elements) which branch out to form either lower-level element groupings, or the Schema's other primary component, the fields that contain actual data (also called simple data elements). A box with a solid border indicates that that particular data element or field is required. A box with a dotted line border indicates an optional data element or field.

Likewise, a solid line connecting two or more boxes indicates that the boxes to the right in the diagram are required fields and a dotted line indicates the fields in the boxes to the right are optional. A plus (+) sign at the right of a box indicates that the complex data element or field branches beyond the scope of a given diagram. The Schema and this Guide display such branching in subsequent diagrams.

Repeatability: Each diagram includes a representation of a field or data element's repeatability. Under a given box, for example, "0...∞" would indicate an optional data element or field (with a minimum number of occurrences of zero) that can be repeated an infinite number of times. On the other hand, a cardinality of "1...3" would indicate a mandatory field (with at least one required instance) that can be repeated up to 3 times.

Although most data elements that could theoretically be included an infinite number of times in the schema, they would typically only be included once or perhaps a few times. Including a high number of occurrences of a field would present problems for the receiving agency or institution.

PESC XML Application for Admission Implementation Guide

Version 1.3.0

Descriptive Tables: Under each diagram, a table will appear with five columns:

Tag Name: This is the name of the data element grouping or field that will appear in the Schema and in the instance document. "Instance document" refers to a document with real data for an actual student applicant that institutions and/or vendors would exchange. The format for the tag name is Upper Camel Case which takes a name such as "Transmission Data" and eliminates the space between the two words, retaining the capital letters of each word making up the tag name.

Schema Use: This column indicates whether the data element or field is required or optional in the instance document. If a required field is not included in the instance document, the transcript will normally be rejected by the receiving institution or agency's computer program (XML Parser). This column will also include a notation if a field can be sent multiple times.

Description: This is a brief description of the data included with a particular XML tag name. The description normally comes from the description in the Core Main Library or the Admission Sector Library for data elements.

Recommended Use: This column reflects recommendations from the developers of the Application for Admission Schema and/or ERUG. Reaching consensus on the recommended use of data elements and fields was a primary task for the PESC Admissions Application Workgroup.

Recommendations in this column generally match the standards in Schema Use, especially if Schema Use shows an element or field as "Required." However, a component listed as "Optional" in Schema Use may be listed as "Recommended" in Recommended Use if the Workgroup regards the element or field as essential and in keeping with good practices in the AACRAO community.

Required: Indicates that a sending institution must include the data element or field in its transmission.

Recommended: If the information for a field is available at the source, then 'Recommended' indicates that the field should be sent. Of course, if the information is not readily available, it would not be included.

Conditional: This recommended use does not occur often in this Guide, but it may occur when the recommendation (recommended, optional or not recommended) is dependent on another data element being sent, or even on the value of another data element that is sent.

Optional: Indicates that it is generally up to the sender to include the data or not. If a paper transcript normally includes the element or field, then the sender should probably include it. In addition, within certain states, items marked as "Optional" may be essential for intrastate exchanges. Finally, it may be the case that a destination school receives all data at a single location; in such a case, the sender may need to provide optional elements to identify the specific intended recipient.

Not Recommended: Indicates that, in the view of the Workgroup, such a data element or field should not form part of a transmission, at least at this point in the schema.

In general, the Workgroup recommends that notes or comments not be included, since most Student Information System programs cannot automatically process them.

PESC XML Application for Admission Implementation Guide

Version 1.3.0

Sending these elements could thereby slow or impede automatic processing by the receiving school.

However, exceptions to this rule-of-thumb may lie in the needs of individual states, as certain intrastate transmissions may require information that only a note or comment field can accommodate. In such cases, the Workgroup recommends that institutions in the state or region develop a protocol for maintaining and transmitting the element or field. In other cases, common practice may be to include data that is not recommended by the Workgroup.

In many cases, because of the reusability of complex data elements in XML, there are data elements included in this schema that may not be appropriate for use in the Application for Admission. Or, the data element might not be appropriate in a particular place in the schema. In these cases, the recommended use may be designated as "Not Recommended."

Format: This column shows the minimum and maximum number of occurrences of the data element. It also shows the minimum and maximum length allowable for a field, if that field does not have enumerated values and is not a special type of field, such as a date field. Unless otherwise defined for a simple data element, the format is always alpha numeric.

"**minOcc** 1" indicates a required field, since it must have at least one occurrence in the instance document. "minOcc 0" indicates an optional field.

"**maxOcc**" followed by a number or symbol specifies the maximum number of times that an element can recur in an instance document at a particular position. For example, "maxOcc 5" would indicate that the field may occur no more than 5 times in a given position of the instance document. "maxOcc ∞" indicates that a field may recur an unlimited number of times in the instance document. However, the use of an excessive number of occurrences puts a burden on the receiving agency or institution, so they should always be limited to the fewest number possible.

"**minLength**" indicates the minimum number of characters that a field must contain, while "**maxLength**" indicates the maximum number of characters that a field may contain.

"**Enumerations**" are used to list the allowable values that may be used in the instance document. They must be used exactly as shown in this column. When the values are enumerated in this column, "minLength" and "maxLength" will not be indicated and are not appropriate.

"**DateTime**" always uses the same format: ccy-mm-ddThh:ii:ss(+GMT). An example would be "2005-11-20T08:15:36(+7)". If DateTime is used, then "minLength" and "maxLength" will not be indicated.

"**Date**" always uses the format "ccyy-mm-dd". An example would be "2011-07-15". If Date is used, then "minLength" and "maxLength" will not be indicated. Alternate indications that can be used are "gYearMonth" which represents the partial date such as 2011-05, or gYear which represents only the four digit year.

"**xs:decimal**" indicates a numeric field. It has a maximum length of 18 characters including a decimal if is explicitly included. Typical values would be (1) a grade point average of "3.250"; (2) credits earned of "24"; or (3) credits included in GPA of "16".

PESC XML Application for Admission Implementation Guide

Version 1.3.0

“**minInclusive**” indicates the lowest value of a decimal type field that can be included, while “**maxInclusive**” indicates the maximum value that can be included in a decimal type field. “**totalDigits**” indicates the maximum number of digits that can be used in the specified field.

Comments: The Guide also includes comments beneath the rows of a given table and/or at the end of the table. The Workgroup intends for these comments to provide further explanation or information about the items displayed in the row or the table above.

Code Illustration: Below each table, the Guide includes a snippet of what that portion of an instance document might look like in XML format. If the data element is a required data element for the schema, then that data element will be in bold type.

If the code is illustrating a complex data element that will be further explained on a subsequent page of this Guide, then only the opening and closing tags will be included. For example:

```
<Birth>  
  
</Birth>
```

If the code is illustrating a simple data element that is not recommended for inclusion, then an empty tag will be included. For example:

```
<NoteMessage/>
```

However, it is common practice not to include an empty tag such as <NoteMessage/> in the instance document.

Order of tag names in the Instance Document: One of the requirements of the PESC XML Schema implementation is that the order of the data elements must be maintained in the instance document (the actual student’s application for admission) in the same order that they appear in the schema. Of course, many of the data elements are optional and do not need to be included in the instance document, but if they are included, they must be included in the same order that they appear in the schema (and in this Implementation Guide).

PESC XML Application for Admission Implementation Guide Version 1.3.0

AdmissionsApplication

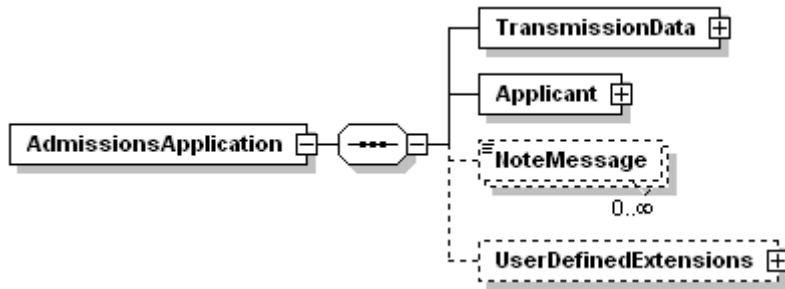

Tag Name	Schema Use	Description	Recommended Use	Format
TransmissionData	Required	Routing and header information	Required	minOcc 1 maxOcc 1
Comment: Detailed information about this complex data element to follow on page 10.				
Applicant	Required	Body of document. One segment per student. It describes the person that is applying for admission or readmission to the postsecondary school.	Required	minOcc 1 maxOcc 1
Comment: Detailed information about this complex data element to follow on page 43.				
NoteMessage	Optional Repeatable	Additional information about the application for admission	Not recommended	minOcc 0 maxOcc ∞ minLength 1 maxLength 80
Comment: In general, this Implementation Guide does not recommend the inclusion of unformatted Note Messages. When formatted and used by a predetermined set of trading partners, then these can be automatically processed by the receiving school's computer. If not formatted, they cannot be automatically processed by the recipient's computer and must be ignored or processed manually.				
UserDefinedExtensions	Optional	Additional structured information. Requires mutually defined XML schema.	Optional	minOcc 0 maxOcc 1

Code illustration:

```

<AdmApp:AdmissionsApplication
  XMLNs:AdmApp="urn:org:pescc:message:AdmissionsApplication:v1.1.0"
  XMLNs:AdmRec="urn:org:pescc:sector:AdmissionsRecord:v1.1.0"
  XMLNs:core="urn:org:pescc:core:CoreMain:v1.10.0"
  XMLNs:xsi="http://www.w3.org/2001/XMLSchema-instance"
  xsi:schemaLocation="urn:org:pescc:message:AdmissionsApplication:v1.1.0
  /AdmissionsApplication_v1.1.0.xsd">
  <TransmissionData>

  </TransmissionData>
  <Applicant>

  </Applicant>
  <NoteMessage/>
  <UserDefinedExtensions/>
</AdmApp:AdmissionsApplication>
  
```

PESC XML Application for Admission Implementation Guide Version 1.3.0

TransmissionData

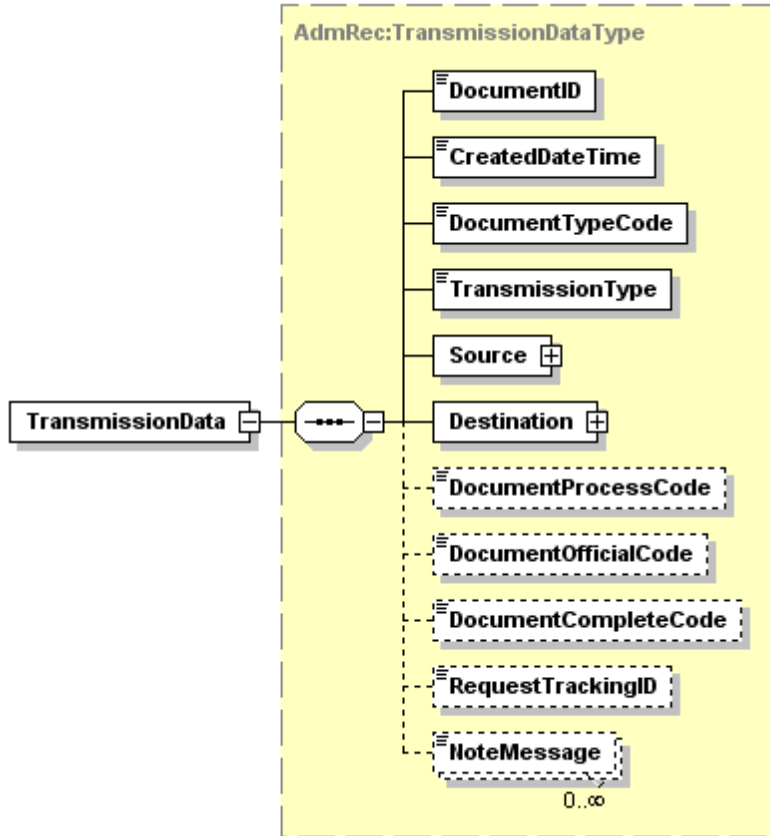

Tag Name	Schema Use	Description	Recommended Use	Format
DocumentID	Required	The File Transmission Date and Time stamp with additional unique qualifying characters	Required	minOcc 1 maxOcc 1 minLength 1 maxLength 35
CreatedDateTime	Required	The Date and Time stamp when the document was created	Required	minOcc 1 maxOcc 1 xs:datetime ccy-mm-ddThh:ii:ss{+GMT}
DocumentTypeCode	Required	Type and purpose of document being transmitted	Required	minOcc 1 maxOcc 1 Enumerations: Application Change InstitutionRequest Request StudentRequest ThirdPartyRequest
Comment: The typical value used for the Application for Admission would be "Application".				

PESC XML Application for Admission Implementation Guide

Version 1.3.0

Tag Name	Schema Use	Description	Recommended Use	Format
TransmissionType	Required	The nature of the Transmission	Required	minOcc 1 maxOcc 1 Enumerations: Duplicate MutuallyDefined Original Reissue Replace Resubmission
Comment: The typical value for the Application for Admission is "Original".				
Source	Required	This field is required and essential to indicate the agency, vendor or company that is transmitting the application for admission to the school to which the person is applying	Required	minOcc 1 maxOcc 1
Comment: This complex data element will be expanded on page 13. The source will typically be a vendor or company that is collecting applications on behalf of the institution, or perhaps a state agency collecting applications on behalf of institutions in the state.				
Destination	Required	This field is mandatory and essential to indicate the school to which the person is applying	Required	minOcc 1 maxOcc 1
Comment: This complex data element will be expanded on page 28. The destination will typically be an individual postsecondary institution, or it could be a major state university acting on behalf of its subsidiary institutions.				
DocumentProcessCode	Optional	This element indicates a TEST or PRODUCTION document	Required if "TEST"; "PRODUCTION" implied, not recommended	minOcc 0 maxOcc 1 Enumerations: TEST PRODUCTION
Comment: During initial testing with a new school, the value "TEST" would be included. After the testing phase is completed, then this optional data element would not be included.				
DocumentOfficialCode	Optional	This element indicates if the document is unofficial. Unofficial documents may be produced for reference purposes, but may not be binding.	Required if Unofficial; "Official" implied, not recommended	minOcc 0 maxOcc 1 Enumerations: Official Unofficial
Comment: Since all transmissions of this type are considered official, this optional data element would not normally be included.				
DocumentCompleteCode	Optional	This element indicates whether the document conveys a complete record. Partial documents may be produced for information that is recorded in multiple media or formats.	Required if not complete; "Complete" is implied, not recommended	minOcc 0 maxOcc 1 Enumerations: Partial Complete
Comment: Since all transmissions of this type are considered complete, this optional data element would not normally be included.				
RequestTrackingID	Optional	The unique ID associated with a request action that is returned to the requestor for document matching and tracking.	Optional	minOcc 0 maxOcc 1 minLength 1 maxLength 35
Comment: This is a number created by the source vendor so that the application that is received can be easily matched with this transmission. It is not normally a part of the Application for Admission.				

PESC XML Application for Admission Implementation Guide Version 1.3.0

Tag Name	Schema Use	Description	Recommended Use	Format
NoteMessage	Optional Repeatable	Additional information about transmission	Not recommended	minOcc 0 maxOcc ∞ minLength 1 maxLength 80
<p>Comment: Since a note message cannot be easily processed by the computer that receives this application, it is recommended that note messages not be included in the transmission, unless there is prior agreement by the sender and the recipient.</p>				

TransmissionData (Continued)

Code illustration:

```

<TransmissionData>
  <DocumentID>2011-04-04-2316139</DocumentID>
  <CreatedDateTime>2011-04-04T09:30:47-05:00</CreatedDateTime>
  <DocumentTypeCode>Application</DocumentTypeCode>
  <TransmissionType>Original</TransmissionType>
  <Source>

  </Source>
  <Destination>

  </Destination>
  <DocumentProcessCode/>
  <DocumentOfficialCode/>
  <DocumentCompleteCode/>
  <RequestTrackingID/>
  <NoteMessage/>
</TransmissionData>

```

PESC XML Application for Admission Implementation Guide Version 1.3.0

TransmissionData.Source

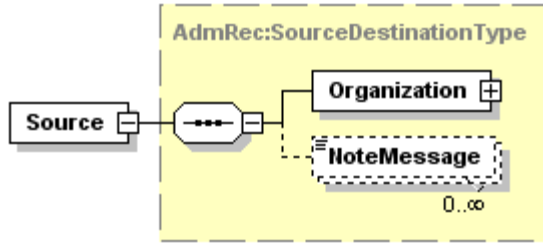

Tag Name	Schema Use	Description	Recommended Use	Format
Organization	Required	Non-person entity such as Organization, Institution, Agency or Business.	Required	minOcc 1 maxOcc 1
Comment: Expanded information about the Organization will be provided on page 14. The Source Organization is the company or possibly the state agency or possibly a postsecondary institution that is responsible for collecting applications and distributing them to subsidiary institutions.				
NoteMessage	Optional Repeatable	Additional information about Organization	Not recommended	minOcc 0 maxOcc ∞ minLength 1 maxLength 80
Comment: This gives additional information about the sending or source vendor or agency. Since it cannot be easily and automatically processed by the receiving school, note messages are not recommended for inclusion in the instance document.				

Code illustration:

```

<Source>
  <Organization>

  </Organization>
  <NoteMessage/>
</Source>

```

PESC XML Application for Admission Implementation Guide Version 1.3.0

TransmissionData.Source.Organization

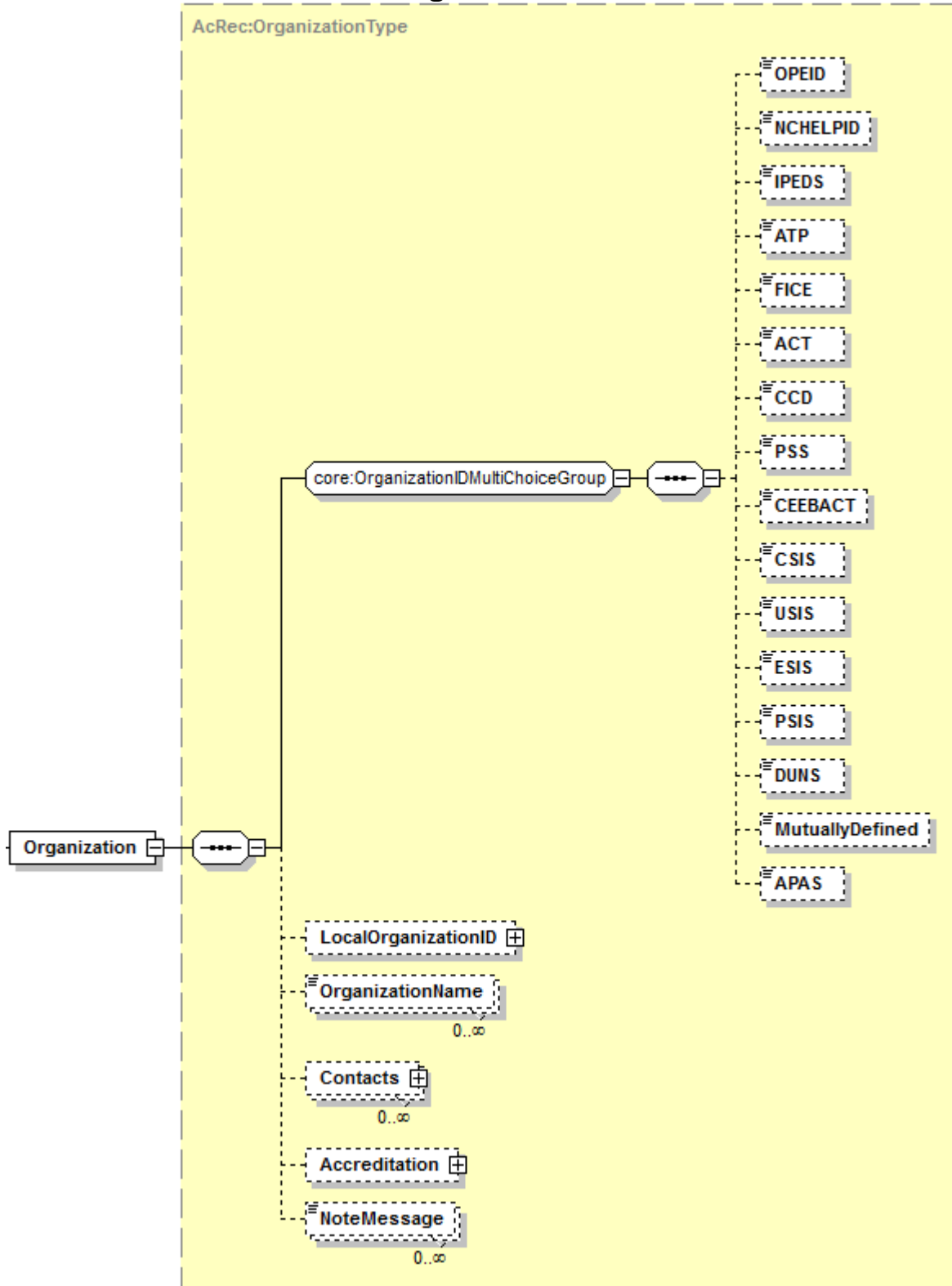

PESC XML Application for Admission Implementation Guide

Version 1.3.0

TransmissionData.Source.Organization (Continued)

Tag Name	Schema Use	Description	Recommended Use	Format
[OrganizationIDGroup]	Required	Allowable Organization IDs - Exclusive choice	Required	minOcc 1 maxOcc 1
<p>Comment: [OrganizationIDGroup] is not an XML tag and does not appear in an instance document. It is required and It requires the choice of one, and only one, of the following 15 code set tags to identify the source organization for this Application for Admission.</p>				
OPEID	Required choice	The unique identifier assigned by the Office of Postsecondary Education for each data exchange partner. Includes all postsecondary schools that are eligible to participate in US Title IV federal financial aid programs.	Not Recommended	minOcc 0 maxOcc 1 minLength 3 maxLength 8
<p>Comment: The OPEID would not normally be an appropriate choice in this case since applications for admission are not normally generated by postsecondary institutions. However, if this is one postsecondary institution collecting applications to forward to a subsidiary institution, then it could be a valid choice.</p>				
NHELPIID	Required choice	The unique identifier assigned by National Council on Higher Education Loan Programs for each data exchange partner.	Not Recommended	minOcc 0 maxOcc 1 minLength 3 maxLength 8
<p>Comment: The NHELPIID would not normally be an appropriate choice in this case since applications for admission are not normally generated by the financial aid world.</p>				
IPEDS	Required choice	The unique identifier for Integrated Postsecondary Education Data System assigned by the National Center for Education Statistics for each postsecondary data exchange partner. Also called the Unit ID.	Not Recommended	minOcc 0 maxOcc 1 minLength 6 maxLength 6
<p>Comment: The IPEDS would not normally be an appropriate choice in this case since applications for admission are not normally generated by postsecondary institutions. However, if this is one postsecondary institution collecting applications to forward to a subsidiary institution, then it could be a valid choice.</p>				
ATP	Required choice	The unique identifier for the Admissions Testing Program assigned by the College Board for each data exchange partner.	Not Recommended	minOcc 0 maxOcc 1 minLength 6 maxLength 6
<p>Comment: The ATP would not normally be an appropriate choice in this case since applications for admission are not normally generated by postsecondary institutions. However, if this is one postsecondary institution collecting applications to forward to a subsidiary institution, then it could be a valid choice.</p>				
FICE	Required choice	The unique identifier once maintained for the Federal Interagency Committee on Education by the National Center for Education Statistics for each postsecondary data exchange partner.	Not Recommended	minOcc 0 maxOcc 1 minLength 6 maxLength 6
<p>Comment: The FICE would not normally be an appropriate choice in this case since applications for admission are not normally generated by postsecondary institutions. In addition, the FICE number was originally maintained by the US Department of Education's National Center for Education Statistics (NCES), but has not been maintained by NCES since late in the last century. However, if this is one postsecondary institution collecting applications to forward to a subsidiary institution, then it could be a valid choice.</p>				

PESC XML Application for Admission Implementation Guide

Version 1.3.0

Tag Name	Schema Use	Description	Recommended Use	Format
ACT	Required choice	The unique identifier for postsecondary educational institutions assigned by American College Testing available at www.act.org	Not Recommended	minOcc 0 maxOcc 1 minLength 4 maxLength 4
Comment: The ACT would not normally be an appropriate choice in this case since applications for admission are not normally generated by postsecondary institutions. However, if this is one postsecondary institution collecting applications to forward to a subsidiary institution, then it could be a valid choice.				
CCD	Required choice	The unique identifier assigned by National Center for Education Statistics as the Common Core of Data for each data exchange partner.	Not Recommended	minOcc 0 maxOcc 1 minLength 12 maxLength 12
Comment: The CCD would not normally be an appropriate choice in this case since applications for admission are not normally generated by secondary schools.				
PSS	Required choice	The unique identifier assigned by National Center for Education Statistics for private K12 schools in the US for each data exchange partner.	Not Recommended	minOcc 0 maxOcc 1 minLength 8 maxLength 8
Comment: The PSS would not normally be an appropriate choice in this case since applications for admission are not normally generated by secondary schools.				
CEEBACT	Required choice	The unique identifier assigned by the College Entrance Examining Board and ACT for each K-12 data exchange partner.	Not Recommended	minOcc 0 maxOcc 1 minLength 6 maxLength 6
Comment: The CEEBACT would not normally be an appropriate choice in this case since applications for admission are not normally generated by secondary schools.				
CSIS	Required choice	The unique identifier assigned by the Statistics Canada Canadian College Student Information System for each postsecondary data exchange partner.	Not Recommended	minOcc 0 maxOcc 1 minLength 6 maxLength 6
Comment: Since this code set is used to identify postsecondary schools in Canada, it is not a recommended choice for US schools. Since it is now being replaced by the PSIS code set in Canada, it would no longer be a valid choice for schools in Canada.				
USIS	Required choice	The unique identifier assigned by the Statistics Canada University Student Information System for each data postsecondary exchange partner.	Not Recommended	minOcc 0 maxOcc 1 minLength 6 maxLength 6
Comment: Since this code set is used to identify postsecondary schools in Canada, it is not a recommended choice for schools in the US. Since it is now being replaced by the PSIS code set, it would no longer be a valid choice for schools in Canada.				
ESIS	Required choice	The unique identifier assigned by the Statistics Canada Enhanced Student Information System for each data postsecondary exchange partner.	Not Recommended	minOcc 0 maxOcc 1 minLength 8 maxLength 8
Comment: Since the ESIS code set is used to identify postsecondary schools in Canada, it is not a recommended choice for schools in the US. And, it is being replaced by the PSIS code set which follows.				
PSIS	Required choice	The unique identifier assigned by the Statistics Canada Postsecondary Student Information System for each data postsecondary exchange partner.	Recommended choice	minOcc 0 maxOcc 1 minLength 8 maxLength 8
Comment: Since this code set is used to identify postsecondary schools in Canada, it is a recommended choice for postsecondary schools in Canada that are collecting applications for admission to send to other agencies or colleges.				

PESC XML Application for Admission Implementation Guide

Version 1.3.0

Tag Name	Schema Use	Description	Recommended Use	Format
DUNS	Required choice	Data Universal Numbering System (DUNS), unique nine character company identification number issued by Dun and Bradstreet Corporation.	Recommended choice	minOcc 0 maxOcc 1 minLength 9 maxLength 9
Comment: The DUNS number would be an appropriate choice to identify a company or other agency that has collected and is forwarding an application for admission to a postsecondary school.				
MutuallyDefined	Required choice	A special code set agreed upon in advance by trading partners in the exchange to identify selected trading partners	Recommended choice	minOcc 0 maxOcc 1 minLength 1 maxLength 60
Comment: MutuallyDefined would be an appropriate choice to identify a company or other agency that has collected and is forwarding an application for admission to a postsecondary school, especially if it does not have a DUNS number. However, it must be interpreted correctly by the destination school or agency.				
APAS	Optional choice	Identification codes used by the Alberta Post-Secondary Application Systems.	Optional choice	minOcc 0 maxOcc 1 minLength 2 maxLength 12
Comment: This is an appropriate choice for institutions in Canada.				
Comment: End of OrganizationIDGroup choice set tags				
LocalOrganizationID	Optional	A code set typically used by a state, province or region to more specifically identify the sending vendor, agency or school.	Not Recommended	minOcc 0 maxOcc 1
Comment: Additional information about the complex data element Local Organization ID will be shown on page 18.				
OrganizationName	Optional Repeatable	Name of Non-person entity such as Organization, Institution, Agency or Business.	Recommended	minOcc 0 maxOcc ∞ minLength 1 maxLength 60
Comment: This is the name of the sending company, vendor, school or agency. It is repeatable so that either a longer name can be included, or more specific parts of the organization can be included.				
Contacts	Optional Repeatable	To identify a person or an office at the sending vendor, company, agency or school to which administrative communications should be directed	Recommended	minOcc 0 maxOcc ∞
Comment: Additional information about the complex data element Contacts will be shown on page 19.				
NoteMessage	Optional Repeatable	Additional information about the organization	Not recommended	minOcc 0 maxOcc ∞ minLength 1 maxLength 80
Comment: Since an unformatted NoteMessage cannot be automatically processed by the receiving school's computer, the use of unformatted NoteMessage data elements are not recommended. However, if the sending and receiving schools or agencies have a prior agreement on the format of a NoteMessage, then it can sometimes be useful within a group of users with common interests.				

PESC XML Application for Admission Implementation Guide Version 1.3.0

Code illustration:

```
<Organization>  
  <DUNS>123456789</DUNS>  
  <LocalOrganizationID>  
  
  </LocalOrganizationID>  
  <OrganizationName>Xap Corporation</OrganizationName>  
  <Contacts>  
  
  </Contacts>  
  <NoteMessage/>  
</Organization>
```

PESC XML Application for Admission Implementation Guide Version 1.3.0

TransmissionData.Source.Organization.LocalOrganizationID

Note: Although the complex data element *LocalOrganizationID* is an optional data element, if you choose to send *LocalOrganizationID*, then you must send both *LocalOrganizationIDCode* and *LocalOrganizationIDQualifier*.

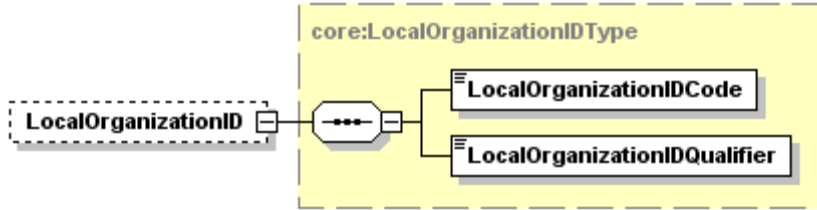

Tag Name	Schema Use	Description	Recommended Use	Format
LocalOrganizationIDCode	Required	The code assigned for the sending company, vendor or agency by the state or province specified in the LocalOrganizationIDQualifier that follows.	Required	minOcc 1 maxOcc 1 minLength 1 maxLength 35
Comment: This is a required data element only if the Local Organization ID complex data element is sent. This is typically the administrative school code assigned by a state or province to specifically identify the sending company, agency or vendor in that state or province.				
LocalOrganizationIDQualifier	Required	This is the state or province that assigned the LocalOrganizationIDCode above.	Required	minOcc 1 maxOcc 1 Enumerations: See Code Set in Appendix A.
Comment: This is a required data element only if the LocalOrganizationID data element is sent. This is typically the state or province that assigned the code to specifically identify the sending entity in that state				

Code illustration:

```
<LocalOrganizationID>
  <LocalOrganizationIDCode>2237901002</LocalOrganizationIDCode>
  <LocalOrganizationIDQualifier>TX</LocalOrganizationIDQualifier>
</LocalOrganizationID>
```

PESC XML Application for Admission Implementation Guide Version 1.3.0

TransmissionData.Source.Organization.Contacts

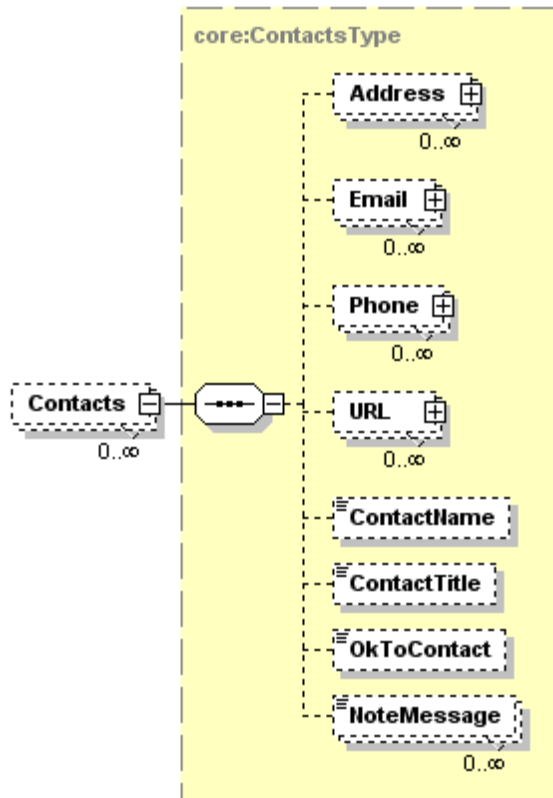

Tag Name	Schema Use	Description	Recommended Use	Format
Address	Optional Repeatable	This is a combined Address Group for a choice between Domestic or International	Recommended	minOcc 0 maxOcc ∞
Comment: Additional information about the complex data element Address will be shown on page 21. This is the address of the source (company, agency or institution) of this application for admission.				
Email	Optional Repeatable	Email address of source company, agency, vendor or institution contact	Recommended	minOcc 0 maxOcc ∞
Comment: Additional information about the complex data element Email will be shown on page 24.				
Phone	Optional Repeatable	Complete phone number of source company, agency, vendor or institution contact	Recommended	minOcc 0 maxOcc ∞
Comment: Additional information about the complex data element Phone will be shown on page 25.				
URL	Optional Repeatable	The Uniform Resource Locator of source company, agency or vendor	Optional	minOcc 0 maxOcc ∞
Comment: Additional information about the complex data element URL for the source of this application for admission will be shown on page 27.				
ContactName	Optional	This is the name of the contact at the source for this transmission.	Optional	minOcc 0 maxOcc 1 minLength 0 maxLength 60

PESC XML Application for Admission Implementation Guide Version 1.3.0

Tag Name	Schema Use	Description	Recommended Use	Format
ContactTitle	Optional	This is the job or position title of the contact at the source for this transmission.	Optional	minOcc 0 maxOcc 1 minLength 0 maxLength 60
OkToContact	Optional	This is information provided by the applicant that indicates if it is OK to contact this individual at the source institution, company or agency.	Optional	minOcc 0 maxOcc 1 Enumerations: No Yes
NoteMessage	Optional Repeatable	Additional information about the contacts at the source company, agency or vendor	Not recommended	minOcc 0 maxOcc ∞ minLength 1 maxLength 80
<p>Comment: This is contact information included by the sending company, agency or vendor to indicate the preferred means for the receiving school to contact it in case there is a need for further communication.</p>				

Code illustration:

```

<Contacts>
  <Address>

  </Address>
  <Email>

  </Email>
  <Phone>

  </Phone>
  <URL>

  </URL>
  <ContactName>Tim Nasr</ContactName>
  <ContactTitle>Manager of Client Services</ContactTitle>
  <OkToContact>Yes<OkToContact>
  <NoteMessage/>
</Contacts>

```

PESC XML Application for Admission Implementation Guide Version 1.3.0

TransmissionData.Source.Organization.Contacts.Address

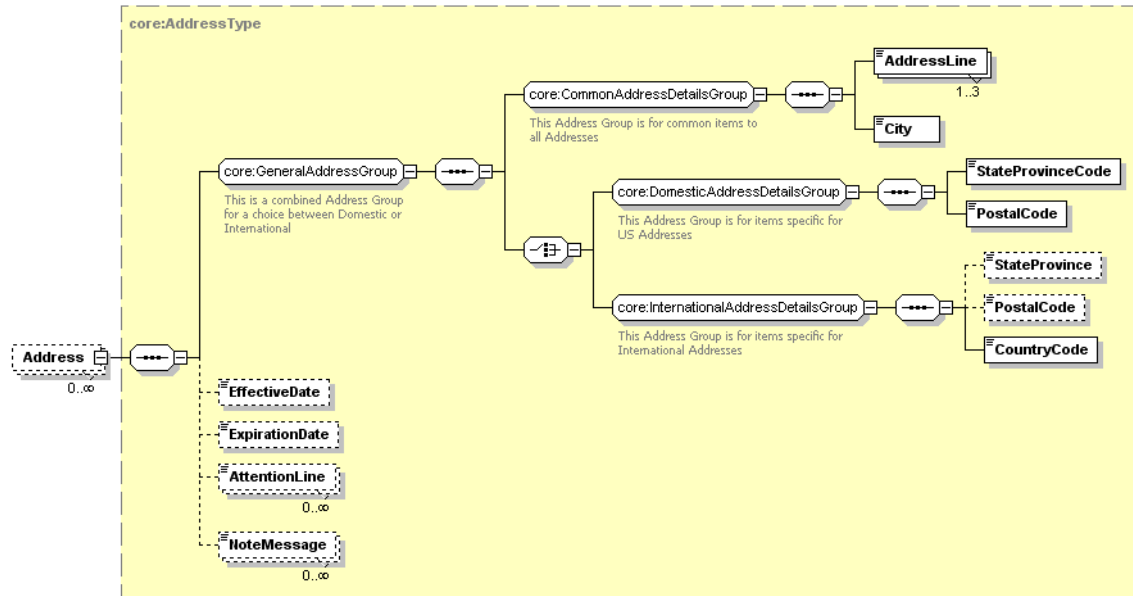

Tag Name	Schema Use	Description	Recommended Use	Format
<i>GeneralAddressGroup</i>	Required	This Address Group is for items common to all Addresses	Required	minOcc 1 maxOcc 1
Comment: [<i>GeneralAddressGroup</i>] does not appear in the instance document. It requires the use of <i>CommonAddressDetailsGroup</i> and the choice of one of either <i>DomesticAddressDetailsGroup</i> or <i>InternationalAddressDetailsGroup</i> . This group is required in the schema only if you choose to send the address of the contact at the sending (source) company, agency or school.				
<i>CommonAddressDetails Group</i>	Required	This Address Group is for items common to all Addresses	Required	minOcc 1 maxOcc 1
Comment: [<i>CommonAddressDetailsGroup</i>] does not appear in the instance document. If the address of a contact is included In the Application for Admission, then this must be sent. It is required and must be paired with one of either <i>DomesticAddressDetailsGroup</i> or <i>InternationalAddressDetailsGroup</i> .				
AddressLine	Required Repeatable	Local delivery information such as street, building number, PO box, or apartment portion of a postal address of a Contact at the Sending (Source) Company, Agency or Vendor.	Required	minOcc 1 maxOcc 3 minLength 1 maxLength 40
City	Required	The city portion of the Address of a Contact at the Sending (Source) Company, Agency or Vendor.	Required	minOcc 1 maxOcc 1 minLength 2 maxLength 30
<i>DomesticAddressDetails Group</i>	Required choice	This Address Group is for items specific for US and Canadian Addresses	Required for US and Canadian addresses	minOcc 1 maxOcc 1
Comment: [<i>DomesticAddressDetailsGroup</i>] does not appear in the instance document. If the complex data element address has a United States or Canadian Postal Code and a US State or Canadian Province Code, then this should be the required choice.				
StateProvinceCode	Required	Code for US states, etc., and Canadian provinces.	Required	minOcc 1 maxOcc 1 Enumerations: See Appendix A

PESC XML Application for Admission Implementation Guide

Version 1.3.0

Tag Name	Schema Use	Description	Recommended Use	Format
PostalCode	Required	The postal code portion of the Address.	Required	minOcc 1 maxOcc 1 minLength 1 maxLength 17
<i>InternationalAddressDetailsGroup</i>	Required choice	This Address Group is for items specific for International Addresses	Required for international addresses	minOcc 1 maxOcc 1
Comment: [InternationalAddressDetailsGroup] does not appear in the instance document. This choice is for addresses that do not have a US or Canadian postal code.				
StateProvince	Optional	The literal name of the state, province or territory of a postal address of the source of this document. Use for addresses outside US or Canada.	Recommended Refer to common postal practices of the source country	minOcc 0 maxOcc 1 minLength 2 maxLength 30
Comment: For an internet resource of states or other geographical subdivisions in countries other than the US and Canada, you might choose to refer to the website of the Universal Postal Union at http://www.upu.int				
PostalCode	Optional	The postal code portion of the Address.	Recommended Refer to common postal practices of the source country	minOcc 0 maxOcc 1 minLength 1 maxLength 17
Comment: For an internet resource of states or other geographical subdivisions in countries other than the US and Canada, you might choose to refer to the website of the Universal Postal Union at http://www.upu.int				
CountryCode	Required	Code indicating Country. Use ISO 3166-1 alpha-2 standard.	Required	minOcc 1 maxOcc 1 Enumerations: See Appendix B
EffectiveDate	Optional	The date on which the address became (or will become) effective	Optional	minOcc 0 maxOcc 1 Date format: CCYY-MM-DD
ExpirationDate	Optional	The date on which the address will (or did) expire	Optional	minOcc 0 maxOcc 1 Date format: CCYY-MM-DD
AttentionLine	Optional Repeatable	The individual or office name within the postal address where inquiries should be directed.	Optional	minOcc 0 maxOcc ∞ minLength 1 maxLength 45
NoteMessage	Optional Repeatable	Additional information about the addresses of the contacts at the source school	Not recommended	minOcc 0 maxOcc ∞ minLength 1 maxLength 80

PESC XML Application for Admission Implementation Guide Version 1.3.0

TransmissionData.Source.Organization.Contacts.Address

Code illustration 1 (Domestic Address):

```
<Address>  
  <AddressLine>1715 W Cesar Chavez</AddressLine>  
  <City>Austin</City>  
  <StateProvinceCode>TX</StateProvinceCode>  
  <PostalCode>78703</PostalCode>  
  <EffectiveDate/>  
  <ExpirationDate/>  
  <AttentionLine/>  
  <NoteMessage/>  
</Address>
```

Code illustration 2 (International Address):

```
<Address>  
  <AddressLine>Altova Corporation</AddressLine>  
  <AddressLine>Rudolfsplatz 13a/9</AddressLine>  
  <City>Wien</City>  
  <StateProvince/>  
  <PostalCode>A-1010</PostalCode>  
  <CountryCode>AT</CountryCode>  
  <EffectiveDate/>  
  <ExpirationDate/>  
  <AttentionLine/>  
  <NoteMessage/>  
</Address>
```

PESC XML Application for Admission Implementation Guide Version 1.3.0

TransmissionData.Source.Organization.Contacts.Email

Note: Although the complex data element *Email* is an optional data element, if you choose to send the *Email Address* for the source of the electronic application, then you must send the data element *EmailAddress*.

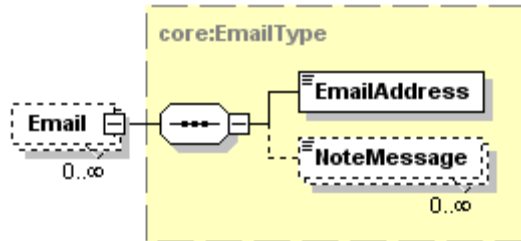

Tag Name	Schema Use	Description	Recommended Use	Format
EmailAddress	Required	The numbers, letters, and symbols used to identify an electronic mail (Email) user within a network.	Required	minOcc 1 maxOc 1 minLength 1 maxLength 128
NoteMessage	Optional Repeatable	Additional information about the email addresses of the contacts at the source school	Not recommended	minOcc 0 maxOcc ∞ minLength 1 maxLength 80

Code illustration:

```
<Email>
  <EmailAddress>farella@cua.edu</EmailAddress>
  <NoteMessage/>
</Email>
```

PESC XML Application for Admission Implementation Guide Version 1.3.0

TransmissionData.Source.Organization.Contacts.Phone

Note: Although the complex data element Phone is an optional data element, if you choose to send the Phone of a Contact at the Sending (Source) Company, Agency or Institution, then you must send a phone number.

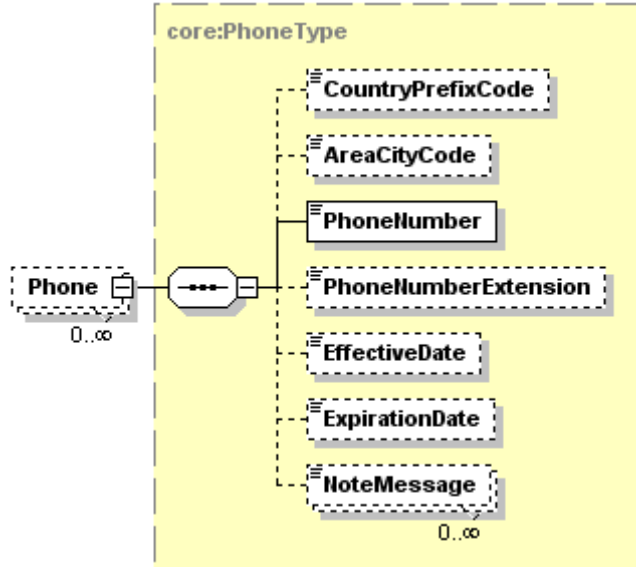

Tag Name	Schema Use	Description	Recommended Use	Format
CountryPrefixCode	Optional	International dialing code	Recommended	minOcc 0 maxOcc 1 minLength 1 maxLength 3
Comment: This data element is not normally included for phone calls within the US..				
AreaCityCode	Optional	Regional dialing code	Recommended	minOcc 0 maxOcc 1 minLength 1 maxLength 5
PhoneNumber	Required	Telephone number	Required	minOcc 1 maxOcc 1 minLength 1 maxLength 11
Comment: The phone number will typically be sent as a string of numbers with no spaces, periods nor dashes.				
PhoneNumberExtension	Optional	The extended telephone addressing information used in addition to phone number such as a PBX extension, a pager PIN, or FAX sub-address	Optional	minOcc 0 maxOcc 1 minLength 1 maxLength 5
EffectiveDate	Optional	The date on which the phone number became (or will become) effective	Optional	minOcc 0 maxOcc 1 Date format: CCYY-MM-DD
ExpirationDate	Optional	The date on which the phone number will (or did) expire	Optional	minOcc 0 maxOcc 1 Date format: CCYY-MM-DD
NoteMessage	Optional Repeatable	Additional information about the phone numbers of the contacts at the source school	Not recommended	minOcc 0 maxOcc ∞ minLength 1 maxLength 80

PESC XML Application for Admission Implementation Guide Version 1.3.0

TransmissionData.Source.Organization.Contacts.Phone (Continued)

Code illustration:

```
<Phone>
  <CountryPrefixCode/>
  <AreaCityCode>512</AreaCityCode>
  <PhoneNumber>4142505</PhoneNumber>
  <PhoneNumberExtension/>
  <EffectiveDate>2009-10-10</EffectiveDate>
  <ExpirationDate/>
  <NoteMessage/>
</Phone>

<Phone>
  <CountryPrefixCode/>
  <AreaCityCode>512</AreaCityCode>
  <PhoneNumber>4747935</PhoneNumber>
  <PhoneNumberExtension/>
  <EffectiveDate/>
  <ExpirationDate/>
  <NoteMessage>Fax Phone</NoteMessage>
</Phone>
```

PESC XML Application for Admission Implementation Guide Version 1.3.0

TransmissionData.Source.Organization.Contacts.URL

Note: Although the complex data element *URL* is an optional data element, if you choose to send the URL of the Source of the Electronic Application, then you must send the *URLAddress*.

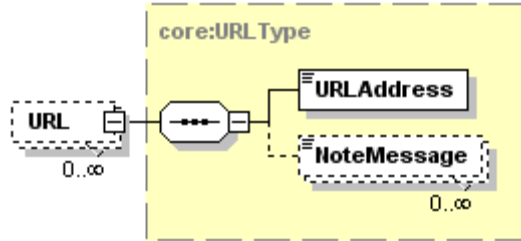

Tag Name	Schema Use	Description	Recommended Use	Format
URLAddress	Required	The Uniform Resource Locator (URL) address of the sending company, agency or vendor, or of a contact at the sending company, agency or vendor	Required	minOcc 1 maxOcc 1 minLength 1 maxLength 512
NoteMessage	Optional Repeatable	Additional information about the URL address of the source institution	Not recommended	minOcc 0 maxOcc ∞ minLength 1 maxLength 80

Code illustration:

```
<URL>
  <URLAddress>www.Xap.com</URLAddress>
  <NoteMessage/>
</URL>
```

PESC XML Application for Admission Implementation Guide Version 1.3.0

TransmissionData.Destination

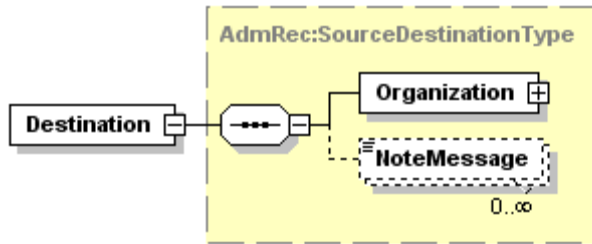

Tag Name	Schema Use	Description	Recommended Use	Format
Organization	Required	Non-person entity such as Organization, Institution, Agency or Business.	Required	minOcc 1 maxOcc 1
Comment: The Destination Organization is normally the postsecondary institution to which the applicant is applying. It is also possible that this postsecondary institution collects electronic applications for subsequent forwarding to another subsidiary institution. This complex data element will be further expanded on page 29.				
NoteMessage	Optional Repeatable	Additional information about Organization	Not recommended	minOcc 0 maxOcc ∞ minLength 1 maxLength 80
Comment: This gives information about the destination of the electronic application for admission.				

Code illustration:

```

<Destination>
  <Organization>

  </Organization>
  <NoteMessage/>
</Destination>

```

PESC XML Application for Admission Implementation Guide Version 1.3.0

TransmissionData.Destination.Organization

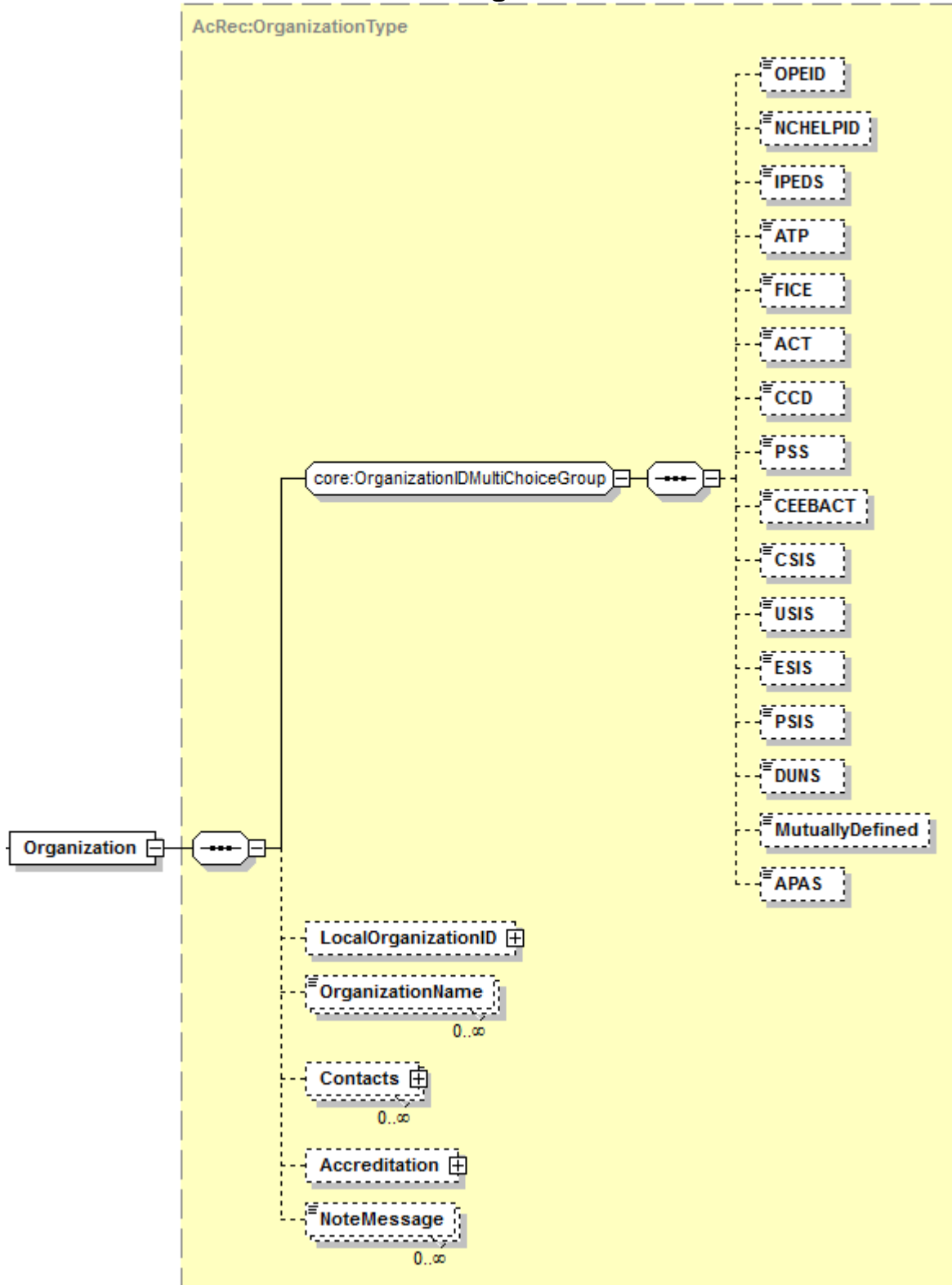

PESC XML Application for Admission Implementation Guide Version 1.3.0

TransmissionData.Destination.Organization (Continued)

Tag Name	Schema Use	Description	Recommended Use	Format
[OrganizationIDGroup]	Required	Allowable Organization IDs - Exclusive choice	Required	minOcc 1 maxOcc 1
Comment: [OrganizationIDGroup] is not an XML tag and does not appear in an instance document. However, this data group is required and it requires the choice of one, and only one, of the following 15 code set tags to identify the destination organization for this Application for Admission.				
OPEID	Required choice	The unique identifier assigned by the Office of Postsecondary Education for each data exchange partner. Includes all postsecondary schools that are eligible to participate in US Title IV federal financial aid programs.	Recommended choice	minOcc 0 maxOcc 1 minLength 3 maxLength 8
Comment: The OPEID would be an appropriate choice for a destination postsecondary institution.				
NCHELPID	Required choice	The unique identifier assigned by National Council on Higher Education Loan Programs for each data exchange partner.	Not Recommended	minOcc 0 maxOcc 1 minLength 3 maxLength 8
Comment: The NCHELPID would not normally be an appropriate choice in this case since applications for admission are not normally sent to the financial aid world.				
IPEDS	Required choice	The unique identifier for Integrated Postsecondary Education Data System assigned by the National Center for Education Statistics for each postsecondary data exchange partner. Also called the Unit ID.	Recommended choice	minOcc 0 maxOcc 1 minLength 6 maxLength 6
Comment: The IPEDS would be an appropriate choice for the postsecondary school receiving the application for admission.				
ATP	Required choice	The unique identifier for the Admissions Testing Program assigned by the College Board for each data exchange partner.	Recommended choice	minOcc 0 maxOcc 1 minLength 6 maxLength 6
Comment: The ATP would normally be an appropriate choice for the postsecondary school receiving the application for admission.				
FICE	Required choice	The unique identifier once maintained for the Federal Interagency Committee on Education by the National Center for Education Statistics for each postsecondary data exchange partner.	Recommended choice	minOcc 0 maxOcc 1 minLength 6 maxLength 6
Comment: The FICE would normally be an appropriate choice. Although it would be a common choice, the FICE number was originally maintained by the US Department of Education's National Center for Education Statistics (NCES), but has not been maintained by NCES since late in the last century.				
ACT	Required choice	The unique identifier for postsecondary educational institutions assigned by American College Testing available at www.act.org	Recommended choice	minOcc 0 maxOcc 1 minLength 4 maxLength 4
Comment: The ACT would normally be an appropriate choice for the postsecondary school receiving the application for admission..				
CCD	Required choice	The unique identifier assigned by National Center for Education Statistics as the Common Core of Data for each K12 data exchange partner.	Not Recommended	minOcc 0 maxOcc 1 minLength 12 maxLength 12
Comment: The CCD would not normally be an appropriate choice in this case since applications for admission are not normally sent to secondary schools.				

PESC XML Application for Admission Implementation Guide

Version 1.3.0

Tag Name	Schema Use	Description	Recommended Use	Format
PSS	Required choice	The unique identifier assigned by National Center for Education Statistics for private K12 schools in the US	Not Recommended	minOcc 0 maxOcc 1 minLength 8 maxLength 8
Comment: The PSS would not normally be an appropriate choice in this case since applications for admission are not normally sent to secondary schools.				
CEEBACT	Required choice	The unique identifier assigned by the College Entrance Examining Board and ACT for each K12 data exchange partner.	Not Recommended	minOcc 0 maxOcc 1 minLength 6 maxLength 6
Comment: The CEEBACT would not normally be an appropriate choice in this case since applications for admission are not normally sent to secondary schools.				
CSIS	Required choice	The unique identifier assigned by the Statistics Canada Canadian College Student Information System for each postsecondary data exchange partner.	Not Recommended	minOcc 0 maxOcc 1 minLength 6 maxLength 6
Comment: Since this code set is used to identify postsecondary schools in Canada, it is not a recommended choice for electronic applications to be sent to schools in the US. Since it is now being replaced by the PSIS code set, it would no longer be an appropriate choice if the application is to be sent to a postsecondary school in Canada.				
USIS	Required choice	The unique identifier assigned by the Statistics Canada University Student Information System for each data postsecondary exchange partner.	Not Recommended	minOcc 0 maxOcc 1 minLength 6 maxLength 6
Comment: Since this code set is used to identify postsecondary schools in Canada, it is not a recommended choice for applications to be sent to schools in the US. Since it is now being replaced by the PSIS code set, it would no longer be an appropriate choice if the application is to be sent to a postsecondary school in Canada.				
ESIS	Required choice	The unique identifier assigned by the Statistics Canada Enhanced Student Information System for each data postsecondary exchange partner.	Not recommended	minOcc 0 maxOcc 1 minLength 8 maxLength 8
Comment: Since this code set is used to identify postsecondary schools in Canada, it is not a recommended choice for applications to be sent to schools in the US. However, it would be an appropriate choice if the application is to be sent to a postsecondary school in Canada, although it is now being replaced by the newer PSIS code set.				
PSIS	Required choice	The unique identifier assigned by the Statistics Canada Enhanced Student Information System for each data postsecondary exchange partner.	Optional choice	minOcc 0 maxOcc 1 minLength 8 maxLength 8
Comment: Since this code set is used to identify postsecondary schools in Canada, it is not a recommended choice for schools in the US. However, it would be the preferred and valid choice for postsecondary schools in Canada who are receiving an application for admission.				
DUNS	Required choice	Data Universal Numbering System (DUNS), unique nine character company identification number issued by Dun and Bradstreet Corporation.	Not Recommended	minOcc 0 maxOcc 1 minLength 9 maxLength 9
Comment: The DUNS number would not normally be an appropriate choice to identify a destination postsecondary school.				
MutuallyDefined	Required choice	A code set that is agreed upon in advance by trading partners in a state or region or consortium, etc. to be used for trading partners that have no code in any of the other code sets.	Optional choice	minOcc 0 maxOcc 1 minLength 9 maxLength 9
Comment: MutuallyDefined would not be an appropriate choice to identify a destination postsecondary school, unless it has been previously agreed upon by both partners in the exchange.				

PESC XML Application for Admission Implementation Guide

Version 1.3.0

Tag Name	Schema Use	Description	Recommended Use	Format
APAS	Optional choice	Identification codes used by the Alberta Post-Secondary Application Systems.	Optional choice	minOcc 0 maxOcc 1 minLength 2 maxLength 12
Comment: This is an appropriate choice for institutions in Canada.				
Comment: End of OrganizationIDGroup choice set tags				
LocalOrganizationID	Optional	A code set typically used by a state, province or region to further identify the destination school.	Optional	minOcc 0 maxOcc 1
Comment: Additional information about the complex data element Local Organization ID will be shown on page 33.				
OrganizationName	Optional Repeatable	Name of Non-person entity such as Organization, Institution, Agency or Business.	Recommended	minOcc 0 maxOcc ∞ minLength 1 maxLength 60
Comment: This is the name of the destination school to which the student is applying.				
Contacts	Optional Repeatable	To identify contact information at the destination school to which administrative communications should be directed	Recommended	minOcc 0 maxOcc ∞
Comment: Additional information about the complex data element Contacts will be shown on page 34 which follows in this Guide.				
NoteMessage	Optional Repeatable	Additional information about the organization	Not recommended	minOcc 0 maxOcc ∞ minLength 1 maxLength 80

TransmissionData.Destination.Organization (Continued)

Code illustration:

```

<Organization>
  <FICE>001234</FICE>
  <LocalOrganizationID>

  </LocalOrganizationID>
  <OrganizationName>Great College</OrganizationName>
  <Contacts>

  </Contacts>
  <NoteMessage/>
</Organization>

```

PESC XML Application for Admission Implementation Guide Version 1.3.0

TransmissionData.Destination.Organization.LocalOrganizationID

Note: Although the complex data element *LocalOrganizationID* is an optional data element, if you choose to send *LocalOrganizationID*, then you must also send both *LocalOrganizationIDCode* and also *LocalOrganizationIDQualifier*.

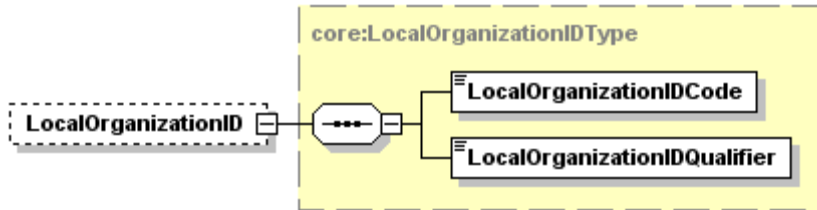

Tag Name	Schema Use	Description	Recommended Use	Format
LocalOrganizationIDCode	Required	The code assigned for the destination postsecondary institution by the state or province in the LocalIDQualifier that follows.	Required	minOcc 1 maxOcc 1 minLength 1 maxLength 35
Comment: This is a required data element only if the Local Organization ID complex data element is sent. This is typically the administrative school code assigned by a state or province to specifically identify the postsecondary institution in that state or province.				
LocalOrganizationIDQualifier	Required	This is the state or province that assigned the Local ID Code above.	Required	minOcc 1 maxOcc 1 Enumeration: See Code Set in Appendix A.
Comment: This is a required data element only if the Local Organization ID data element is sent. This is typically the state or province that assigned the code to specifically identify the school in that state or province.				

Code illustration:

```
<LocalOrganizationID>
  <LocalOrganizationIDCode>2237901002</LocalOrganizationIDCode>
  <LocalOrganizationIDQualifier>TX</LocalOrganizationIDQualifier>
</LocalOrganizationID>
```

PESC XML Application for Admission Implementation Guide Version 1.3.0

TransmissionData.Destination.Organization.Contacts

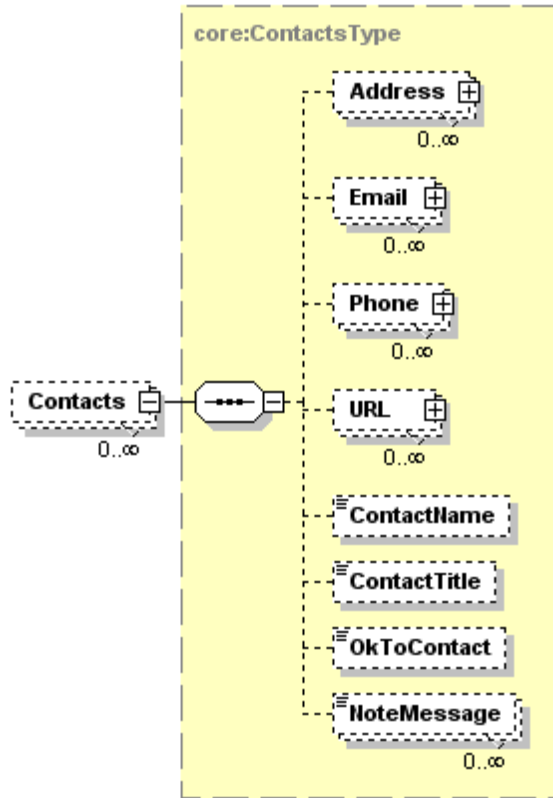

Tag Name	Schema Use	Description	Recommended Use	Format
Address	Optional Repeatable	This is a combined Address Group for a choice between Domestic or International	Optional	minOcc 0 maxOcc ∞
Comment: Additional information about the complex data element Address will be shown on page 36. This is the address of the destination institution for this application for admission.				
Email	Optional Repeatable	Email address of destination institutional contact	Optional	minOcc 0 maxOcc ∞
Comment: Additional information about the complex data element Email will be shown on page 39.				
Phone	Optional Repeatable	Complete phone number of destination institutional contact	Optional	minOcc 0 maxOcc ∞
Comment: Additional information about the complex data element Phone will be shown on page 40.				
URL	Optional Repeatable	The Uniform Resource Locator of the destination school	Optional	minOcc 0 maxOcc ∞
Comment: Additional information about the complex data element URL for the destination of this application for admission will be shown on page 42. However, it would be quite unusual for the sender of the application for admission to include the URL of the school receiving the application for admission.				
ContactName	Optional	This is the name of the contact at the destination school that is receiving this application for admission.	Optional	minOcc 0 maxOcc 1 minLength 1 maxLength 60

PESC XML Application for Admission Implementation Guide

Version 1.3.0

Tag Name	Schema Use	Description	Recommended Use	Format
ContactTitle	Optional	This is the job title or position of the contact at the destination school that is receiving this application for admission.	Optional	minOcc 0 maxOcc 1 minLength 1 maxLength 60
OkToContact	Optional	This is an indicator that it is OK or not OK to contact the person at the destination institution	Optional	minOcc 0 maxOcc 1 Enumerations: No Yes
NoteMessage	Optional Repeatable	Additional information about the contacts at the destination company, agency or vendor	Not recommended	minOcc 0 maxOcc ∞ minLength 1 maxLength 80

Code illustration:

```

<Contacts>
  <Address>

  </Address>
  <Email>

  </Email>
  <Phone>

  </Phone>
  <URL>

  </URL>
  <ContactName>Cheryl Rich</ContactName>
  <ContactTitle>Associate Director of Admissions</ContactTitle>
  <OkToContact>Yes</OkToContact>
  <NoteMessage/>
</Contacts>

```

PESC XML Application for Admission Implementation Guide Version 1.3.0

TransmissionData.Destination.Organization.Contacts.Address

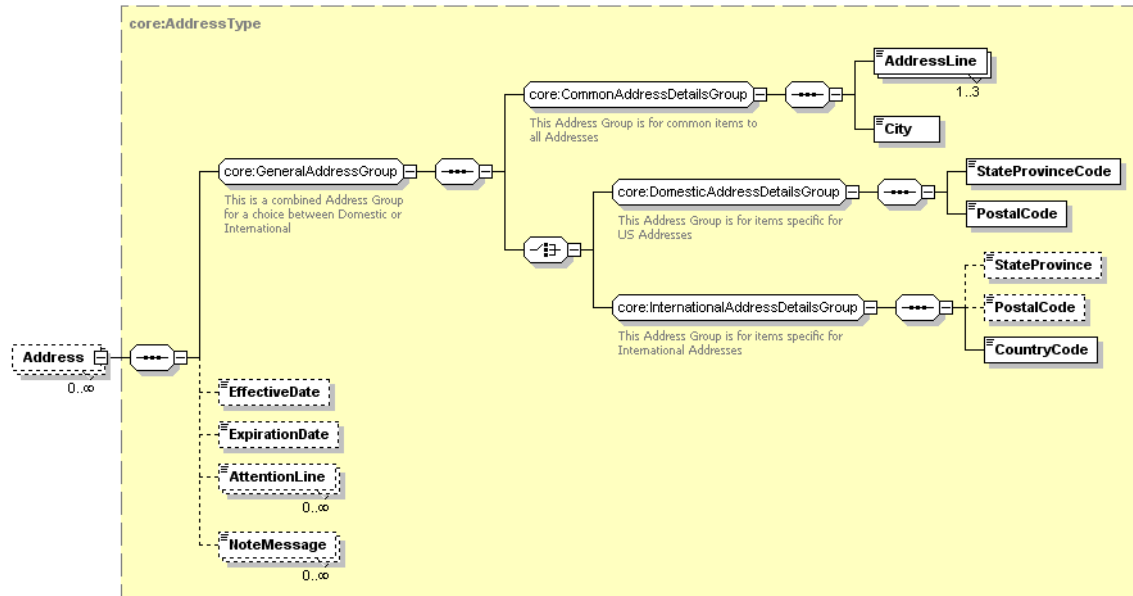

Tag Name	Schema Use	Description	Recommended Use	Format
<i>GeneralAddressGroup</i>	Required	This Address Group is for items common to all Addresses	Required	minOcc 1 maxOcc 1
Comment: [<i>GeneralAddressGroup</i>] does not appear in the instance document. It requires the use of <i>CommonAddressDetailsGroup</i> and the choice of one of either <i>DomesticAddressDetailsGroup</i> or <i>InternationalAddressDetailsGroup</i> . This group is required in the schema only if you choose to send the address of the contact at the destination school.				
<i>CommonAddressDetails Group</i>	Required	This Address Group is for items common to all Addresses	Required	minOcc 1 maxOcc 1
Comment: [<i>CommonAddressDetailsGroup</i>] does not appear in the instance document. If the address of a contact is included In the Application for Admission, then this must be sent. It is required and must be paired with one of either <i>DomesticAddressDetailsGroup</i> or <i>InternationalAddressDetailsGroup</i> .				
AddressLine	Required Repeatable	Local delivery information such as street, building number, PO box, or apartment portion of a postal address of a Contact at the Destination School.	Required	minOcc 1 maxOcc 3 minLength 1 maxLength 40
City	Required	The city portion of the Address of a Contact at the Destination School.	Required	minOcc 1 maxOcc 1 minLength 2 maxLength 30
<i>DomesticAddressDetails Group</i>	Required choice	This Address Group is for items specific for US and Canadian Addresses	Required for domestic addresses	minOcc 1 maxOcc 1
Comment: [<i>DomesticAddressDetailsGroup</i>] does not appear in the instance document. If the complex data element address has a United States or Canadian Postal Code and a US State or Canadian Province Code, then this should be the required choice.				
StateProvinceCode	Required	Code for US states, etc., and Canadian provinces.	Required	minOcc 1 maxOcc 1 Enumeration: See Appendix A

PESC XML Application for Admission Implementation Guide Version 1.3.0

Tag Name	Schema Use	Description	Recommended Use	Format
PostalCode	Required	The postal code portion of the Address.	Required	minOcc 1 maxOcc 1 minLength 1 maxLength 17
<i>InternationalAddressDetailsGroup</i>	Required choice	This Address Group is for items specific for International Addresses	Required for international addresses	minOcc 1 maxOcc 1
Comment: [InternationalAddressDetailsGroup] does not appear in the instance document. This choice is for addresses that do not have a US or Canadian postal code.				
StateProvince	Optional	The literal name of the state, province or territory of a postal address of the destination of this document. Use for addresses outside US or Canada.	Recommended Refer to common postal practices of the source country	minOcc 0 maxOcc 1 minLength 2 maxLength 30
Comment: For an internet resource of states or other geographical subdivisions in countries other than the US and Canada, you might choose to refer to the website of the Universal Postal Union at http://www.upu.int				
PostalCode	Optional	The postal code portion of the Address.	Recommended Refer to common postal practices of the source country	minOcc 0 maxOcc 1 minLength 1 maxLength 17
Comment: For an internet resource of states or other geographical subdivisions in countries other than the US and Canada, you might choose to refer to the website of the Universal Postal Union at http://www.upu.int				
CountryCode	Required	Code indicating Country. Use ISO 3166-1 alpha-2 standard.	Required	minOcc 1 maxOcc 1 Enumerations: See Appendix B
EffectiveDate	Optional	The date on which the address became (or will become) effective	Optional	minOcc 0 maxOcc 1 Date format: CCYY-MM-DD
ExpirationDate	Optional	The date on which the address will (or did) expire	Optional	minOcc 0 maxOcc 1 Date format: CCYY-MM-DD
AttentionLine	Optional Repeatable	The individual or office name within the postal address where inquiries should be directed.	Optional	minOcc 0 maxOcc ∞ minLength 1 maxLength 45
NoteMessage	Optional Repeatable	Additional information about the addresses of the contacts at the destination school	Not recommended	minOcc 0 maxOcc ∞ minLength 1 maxLength 80

PESC XML Application for Admission Implementation Guide Version 1.3.0

TransmissionData.Destination.Organization.Contacts.Address (Continued)

Code illustration 1 (Domestic Address):

```
<Address>  
  <AddressLine>1715 W Cesar Chavez</AddressLine>  
  <City>Austin</City>  
  <StateProvinceCode>TX</StateProvinceCode>  
  <PostalCode>78703</PostalCode>  
  <EffectiveDate/>  
  <ExpirationDate/>  
  <AttentionLine/>  
  <NoteMessage/>  
</Address>
```

Code illustration 2 (International Address):

```
<Address>  
  <AddressLine>Altova Corporation</AddressLine>  
  <AddressLine>Rudolfsplatz 13a/9</AddressLine>  
  <City>Wien</City>  
  <StateProvince/>  
  <PostalCode>A-1010</PostalCode>  
  <CountryCode>AT</CountryCode>  
  <EffectiveDate/>  
  <ExpirationDate/>  
  <AttentionLine/>  
</Address>
```

PESC XML Application for Admission Implementation Guide Version 1.3.0

TransmissionData.Destination.Organization.Contacts.Email

Note: Although the complex data element Email is an optional data element, if you choose to send the Email Address for the destination of the electronic application, then you must send the data element EmailAddress.

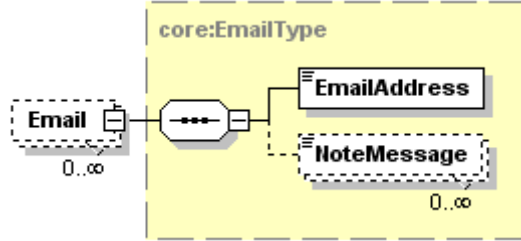

Tag Name	Schema Use	Description	Recommended Use	Format
EmailAddress	Required	The numbers, letters, and symbols used to identify an electronic mail (Email) user within a network.	Required	minOcc 1 maxOc 1 minLength 1 maxLength 128
NoteMessage	Optional Repeatable	Additional information about the email addresses of the contacts at the destination school	Not recommended	minOcc 0 maxOcc ∞ minLength 1 maxLength 80

Code illustration:

```
<Email>
  <EmailAddress>crich@oar.tamu.edu</EmailAddress>
  <NoteMessage/>
</Email>
```

PESC XML Application for Admission Implementation Guide Version 1.3.0

TransmissionData.Destination.Organization.Contacts.Phone

Note: Although the complex data element Phone is an optional data element, if you choose to send the Phone of a Contact at the Destination Institution, then you must send a phone number and the Phone Category Attribute.

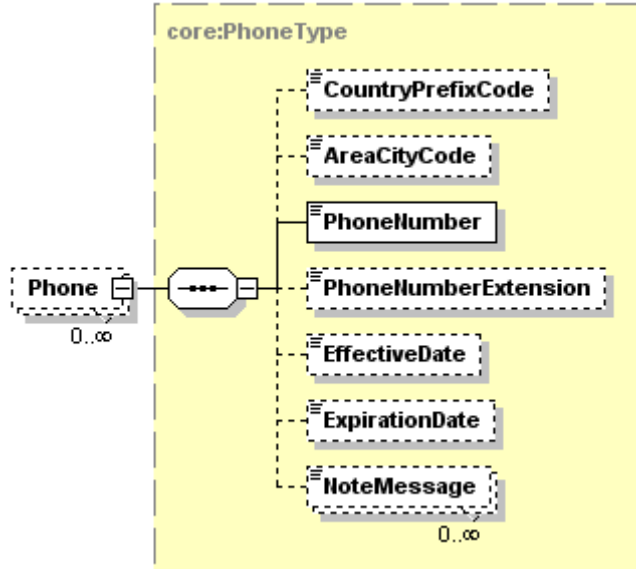

Tag Name	Schema Use	Description	Recommended Use	Format
CountryPrefixCode	Optional	International dialing code	Optional	minOcc 0 maxOcc 1 minLength 1 maxLength 3
AreaCityCode	Optional	Regional dialing code	Recommended	minOcc 0 maxOcc 1 minLength 1 maxLength 5
PhoneNumber	Required	Telephone number	Required	minOcc 1 maxOcc 1 minLength 1 maxLength 11
Comment: The phone number will typically be sent as a string of numbers with no spaces, periods nor dashes.				
PhoneNumberExtension	Optional	The extended telephone addressing information used in addition to phone number such as a PBX extension, a pager PIN, or FAX sub-address	Optional	minOcc 0 maxOcc 1 minLength 1 maxLength 5
EffectiveDate	Optional	The date on which the phone number became (or will become) effective	Optional	minOcc 0 maxOcc 1 Date format: CCYY-MM-DD
ExpirationDate	Optional	The date on which the phone number will (or did) expire	Optional	minOcc 0 maxOcc 1 Date format: CCYY-MM-DD
NoteMessage	Optional Repeatable	Additional information about the phone numbers of the contacts at the destination school	Not recommended	minOcc 0 maxOcc ∞ minLength 1 maxLength 80

PESC XML Application for Admission Implementation Guide Version 1.3.0

TransmissionData.Destination.Organization.Contacts.Phone (Continued)

Code illustration:

```
<Phone>
  <CountryPrefixCode/>
  <AreaCityCode>512</AreaCityCode>
  <PhoneNumber>4142505</PhoneNumber>
  <PhoneNumberExtension/>
  <EffectiveDate>2008-11-10</EffectiveDate>
  <ExpirationDate/>
  <NoteMessage/>
</Phone>

<Phone>
  <CountryPrefixCode/>
  <AreaCityCode>512</AreaCityCode>
  <PhoneNumber>4747935</PhoneNumber>
  <PhoneNumberExtension/>
  <EffectiveDate/>
  <ExpirationDate/>
  <NoteMessage>Fax Number</NoteMessage>
</Phone>
```

PESC XML Application for Admission Implementation Guide Version 1.3.0

TransmissionData.Destination.Organization.Contacts.URL

Note: Although the complex data element URL is an optional data element, if you choose to send the URL of the Destination for the Electronic Application, then you must send the URLAddress.

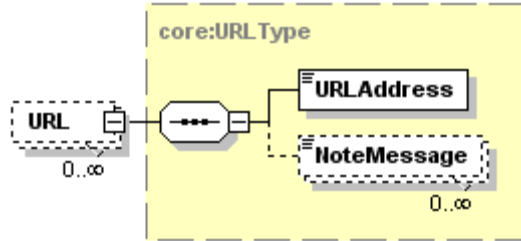

Tag Name	Schema Use	Description	Recommended Use	Format
URLAddress	Required	The Uniform Resource Locator (URL) address of the sending company, agency or vendor, or of a contact at the destination school.	Required	minOcc 1 maxOcc 1 minLength 1 maxLength 512
NoteMessage	Optional Repeatable	Additional information about the URL address of the destination institution	Not recommended	minOcc 0 maxOcc ∞ minLength 1 maxLength 80

Code illustration:

```
<URL>
  <URLAddress>www.TAMU.edu</URLAddress>
  <NoteMessage/>
</URL>
```

PESC XML Application for Admission Implementation Guide Version 1.3.0

Applicant

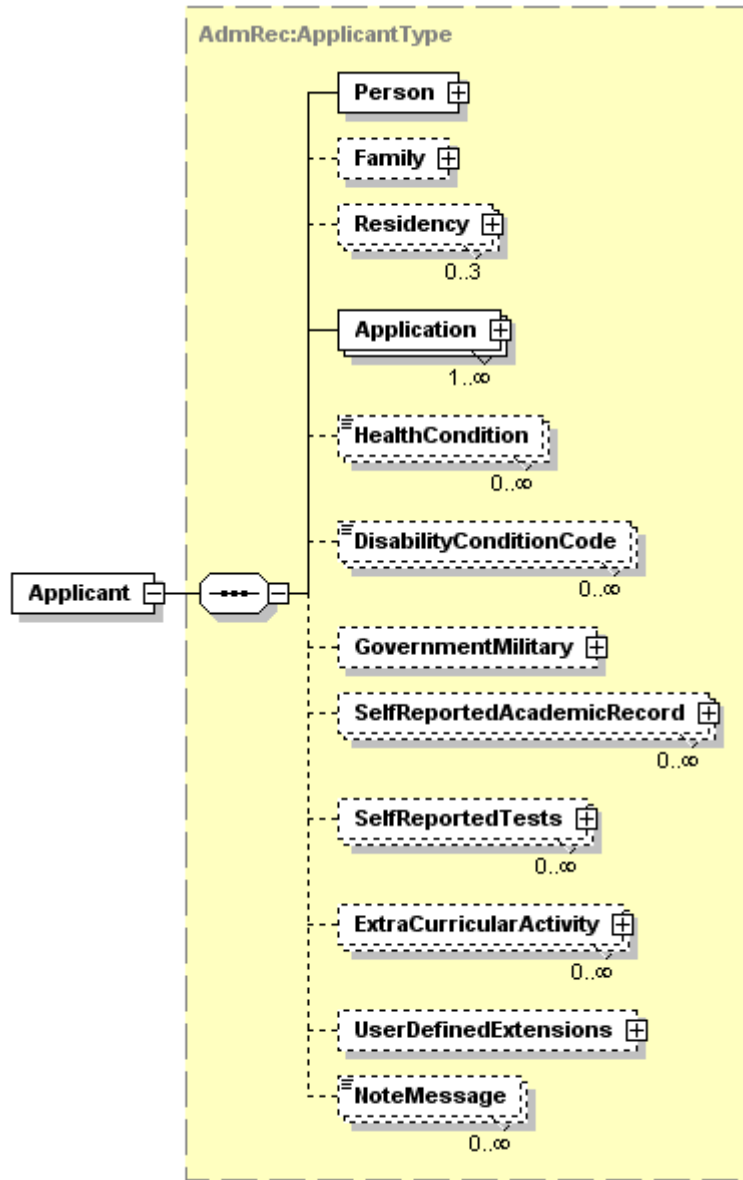

Tag Name	Schema Use	Description	Recommended Use	Format
Person	Required	Information about the person who is submitting the Application for Admission	Required	minOcc 1 maxOcc 1
Comment: Additional information about the person will be shown on page 46.				
Family	Optional	Information about the family of the applicant	Recommended	minOcc 0 maxOcc 1
Comment: Additional information about the family of the applicant will be shown on page 215.				
Residency	Optional Repeatable	Information about the residency status and location of the applicant and/or the family of the applicant	Recommended	minOcc 0 maxOcc 3
Comment: Additional information about the residency of the applicant will be shown on page 249.				

PESC XML Application for Admission Implementation Guide

Version 1.3.0

Tag Name	Schema Use	Description	Recommended Use	Format
Application	Required Repeatable	Information about the specifics of one or more particular applications to specific programs, terms and campuses from the applicant	Required	minOcc 1 maxOcc ∞
Comment: Additional information about the application being submitted at this time will be shown on page 269.				
HealthCondition	Optional Repeatable	Information about the health of the applicant	Optional	minOcc 0 maxOcc ∞ minLength 0 maxLength 500
Comment: It would be unusual for an applicant for admission to be asked to submit information about his or her health at the time of submission of the application. However, since it was found on one or more actual applications, it is included here.				
DisabilityConditionCode	Optional Repeatable	Information about the type of disability the applicant would like to bring to the attention of the school to which the applicant is applying	Optional	minOcc 0 maxOcc ∞ Enumerations: CerebralPalsy ChronicIllness DrugAlcoholAddiction EmotionalPsychological EpilepsySeizure Hearing Learning MentalRetardation None OrthopedicPhysical Other SpeechLanguage Visual
Comment: It would be unusual for an applicant for admission to be asked to submit information about his or her health at the time of submission of the application. However, since it was found on one or more actual applications, it is included here.				
GovernmentMilitary	Optional	Additional information about the prior or current history of government or military affiliations	Recommended	minOcc 0 maxOcc 1
Comment: This complex data element will be expanded on page 329.				
SelfReportedAcademicRecord	Optional Repeatable	Information about the applicant's previous educational experiences that the applicant relates as part of the application	Optional	minOcc 0 maxOcc ∞
Comment: This complex data element will be expanded on page 331.				
SelfReportedTests	Optional Repeatable	Information about the standardized tests that the applicant has taken or plans to take	Optional	minOcc 0 maxOcc ∞
Comment: This complex data element will be expanded on page 410.				
ExtraCurricularActivity	Optional Repeatable	Information reported by the applicant about participation in extra curricular activities	Optional	minOcc 0 maxOcc ∞
Comment: This complex data element will be expanded on page 414.				
UserDefinedExtensions	Optional	Additional information about the applicant that has been put into a mini schema. It is intended for use within a predetermined state or region.	Optional	minOcc 0 maxOcc 1
Comment: The use of a mini-schema called UserDefinedExtensions can be helpful to a specific group of users who would like to include coded data that is pre-defined and can be interpreted by the recipient of the instance document. Others not in that group would simply ignore the UDE.				

PESC XML Application for Admission Implementation Guide

Version 1.3.0

Tag Name	Schema Use	Description	Recommended Use	Format
NoteMessage	Optional Repeatable	Additional information about the Applicant	Not recommended	minOcc 0 maxOcc ∞ minLength 1 maxLength 80
<p>Comment: In general, the use of Note Messages is not recommended, since they cannot normally be automatically processed by the receiving school's computer system. However, they are provided for throughout the schema in case the developers of this schema may have unintentionally left out something that is needed by the users of the schema. If it is some brief information that is used by several schools in a state or region, then it would be helpful to code the information in the NoteMessage. For example, if a state needs to collect information about the weight of all applicants, then the message could be structured as follows (where XX refers to the state): XX-Weight-123. For more complicated coded information, then the use of a UDE is suggested.</p>				

Applicant (Continued)

Code illustration:

```

<Applicant>
  <Person>

    </Person>
    <Family>

      </Family>
      <Residency>

        </Residency>
        <Application>

          </Application>
          <HealthCondition>l'd like to report an allergy to penicillin.</HealthCondition>
          <DisabilityConditionCode>Learning</DisabilityConditionCode>
          <GovernmentMilitary>

            </GovernmentMilitary>
            <SelfReportedAcademicRecord>

              </SelfReportedAcademicRecord>
              <SelfReportedTests>

                </SelfReportedTests>
                <ExtraCurricularActivity>

                  </ExtraCurricularActivity>
                  <UserDefinedExtensions/>
                  <NoteMessage/>
                </Applicant>

```

PESC XML Application for Admission Implementation Guide Version 1.3.0

Applicant.Person

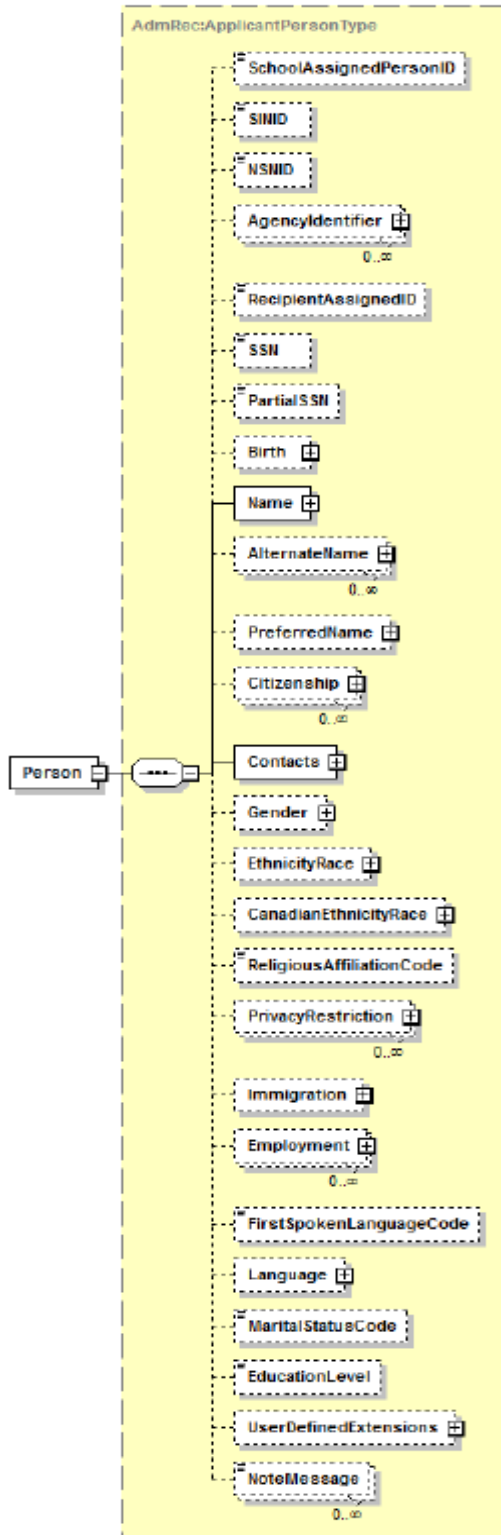

PESC XML Application for Admission Implementation Guide Version 1.3.0

Applicant.Person (Continued)

Tag Name	Schema Use	Description	Recommended Use	Format
SchoolAssignedPersonID	Optional	School assigned identifier	Not Recommended	minOcc 0 maxOcc 1 minLength 1 maxLength 20
Comment: This would typically be the student ID at the school the applicant is now attending or has previously attended. However, since there is no way of knowing which school that is, in this context, it is not recommended that it be included here.				
SINID	Optional	The person's Canadian Social Insurance Number	Optional	minOcc 0 maxOcc 1 minLength 9 maxLength 9
NSNID	Optional	Canadian National Student Number	Optional	minOcc 0 maxOcc 1 minLength 1 maxLength 30
Comment: The NSN is typically assigned by the first Canadian postsecondary school that has contact with the student. The NSN includes the date the number is assigned, the PSIS code for the school assigning the number and the number assigned by that postsecondary school in Canada. It is used by Statistics Canada for tracking the student throughout the student's educational career in Canada.				
AgencyIdentifier	Optional Repeatable	The means used by a specified organization to specify one specific person	Optional	minOcc 0 maxOcc ∞
Comment: This complex data element will be expanded on page 52 which follows in this Guide.				
RecipientAssignedID	Optional	Recipient assigned identifier	Recommended	minOcc 0 maxOcc 1 minLength 1 maxLength 20
Comment: This is the place to provide the ID assigned by the school to which the student is applying if it is known at the time this application is being submitted. Normally, this would only be known if this is a readmission application or an updated application for admission. This field is alpha numeric. All fields in this Implementation Guide are alpha numeric fields unless otherwise specified.				
SSN	Optional	Social Security Number assigned to the US student by the United States Social Security Administration	Recommended	minOcc 0 maxOcc 1 Pattern \d{9}
Comment: The inclusion of the SSN is important to include in the US school's data base. The application for admission is an important and preferred place for the student to provide this information. It is required for students who receive federal financial aid from the US government. It must be optional since this schema will also be used for the application for admission of non US citizens who may not have been assigned this number, and US students cannot be required to provide it. This number should be included without any dashes.				
PartialSSN	Optional	The last four digits of the US Social Security Number assigned to the US student by the United States Social Security Administration	Conditional	minOcc 0 maxOcc 1 Pattern \d{4}
Comment: The inclusion of the SSN is important to include in the US school's data base. Although the FERPA regulations allow the SSN to be included, some schools prefer not to ask for the entire 9 digits and have decided to only transmit the last four of the nine digits. This number should be included without any dashes. It is recommended to send the 9 digit number and if not to send the last four, but do not include both data elements.				
Birth	Optional	Information about the birth of the applicant	Recommended	minOcc 0 maxOcc 1
Comment: Additional information about birth will be shown on page 53 which follows in this Guide.				
Name	Required	The name of the applicant	Required	minOcc 1 maxOcc 1
Comment: Additional information about the applicant's name will be shown on page 55 which follows in this Guide.				
AlternateName	Optional Repeatable	Other names by which the applicant is (or has previously been) known	Recommended	minOcc 0 maxOcc ∞
Comment: Additional information about alternate names will be shown on page 57 which follows in this Guide.				

PESC XML Application for Admission Implementation Guide

Version 1.3.0

Tag Name	Schema Use	Description	Recommended Use	Format
PreferredName	Optional	This is the name the applicant prefers in future communications from the school	Optional	minOcc 0 maxOcc 1
Comment: An applicant, whose name is John Thomas Student, may preferred to be called "Tom", or "JT" or "Mr. Student". Additional information about the Preferred Name of the applicant will be shown on page 59 which follows in this Guide.				
Citizenship	Optional Repeatable	Information about the citizenship status of the applicant	Recommended	minOcc 0 maxOcc ∞
Comment: Additional information about citizenship will be shown on page 61 which follows in this Guide.				
Contacts	Required	Information about how the applicant may be contacted	Required	minOcc 1 maxOcc 1
Comment: Additional information about contacts will be shown on page 62 which follows in this Guide. This includes multiple addresses, phone numbers, emails, URLs, etc.				
Gender	Optional	The sex or gender of the applicant	Recommended	minOcc 0 maxOcc 1
Comment: Additional information about gender will be shown on page 121. This is an important piece of information that the school to which the student is applying must collect for later reporting.				
EthnicityRace	Optional	The ethnicity and/or race information provided by the applicant to US postsecondary schools	Recommended	minOcc 0 maxOcc 1
Comment: Additional information about ethnicity and race will be shown on page 122 which follows in this Guide. This is an important piece of information that the US school to which the person is applying must collect for later reporting. However, there may be rules or regulations that prohibit the collection of this information on the application for admission, unless disclaimers are provided to the applicant.				
CanadianEthnicityRace	Optional	The ethnicity and/or race information provided by the applicant to Canadian postsecondary schools	Optional	minOcc 0 maxOcc 1
Comment: This optional data element is included in the schema for applicants to Canadian postsecondary schools. If none of the values of CanadianEthnicityCode is appropriate, then this data element would not be included. Additional information about this complex data element will be provided on page 132.				
ReligiousAffiliationCode	Optional	This is the primary religious affiliation declared by the applicant	Optional	minOcc 0 maxOcc 1 See code set in Appendix E
PrivacyRestriction	Optional Repeatable	Request by the applicant to restrict access to certain data that may normally be released under the US Family Educational Rights and Privacy Act	Optional	minOcc 0 maxOcc ∞
Comment: Additional information about PrivacyRestriction will be shown on page 124 which follows in this Guide. It is understood that FERPA only applies to those who become students at the school to which the applicant is applying. The applicant has no rights under FERPA. However, some schools may wish to allow the applicant to specify certain options at the time of application that will then take effect upon enrollment.				
Immigration	Optional	This is the current (or requested) immigration status, in the US or Canada, of the applicant as determined by the US or Canadian immigration authorities	Optional	minOcc 0 maxOcc 1
Comment: Additional information about immigration will be shown on page 125 which follows in this Guide.				
Employment	Optional Repeatable	This is all the previous and current employment reported by the applicant	Optional	minOcc 0 maxOcc ∞
Comment: Additional information about employment will be shown on page 198 which follows in this Guide.				

PESC XML Application for Admission Implementation Guide

Version 1.3.0

Tag Name	Schema Use	Description	Recommended Use	Format
FirstSpokenLanguageCode	Optional	The first language spoken by the person at home	Optional	minOcc 0 maxOcc 1 minLength 3 maxLength 3 This three digit ISO code set of languages of the world is found in Appendix C
Language	Optional	Information about the ability of the person to speak, read and understand languages other than the primary one used in his or her country	Optional	minOcc 0 maxOcc 1
Comment: Additional information about language will be shown on page 213 which follows in this Guide.				
MaritalStatusCode	Optional	The marital status of the applicant	Optional	minOcc 0 maxOcc 1 Enumerations: CommonLaw Divorced LegallySeparated Married RegisteredPartnership Separated Single Unknown Unmarried Unreported Widowed
EducationLevel	Optional	The amount of formal education which the applicant has received	Optional	minOcc 0 maxOcc 1 Enumerations: AssociateDegree BaccalaureateDegree CollegeAttended CollegeCertificate CollegeDiploma DoctoralDegree Elementary FourYearCollegeGraduate HighSchoolAttended HighSchoolGraduate JuniorHighSchool MastersDegree MiddleSchool NoHighSchool None PostGraduateStudy ProfessionalAttended ProfessionalCertification ProfessionalDegree SecondarySchool TwoYearCollegeGraduate VocationalSchool
UserDefinedExtensions	Optional	A mini-schema defined by a specific group of users to transmit coded data about the person	Not recommended	minOcc 0 maxOcc 1
Comment: Because User Defined Extensions are normally used by only a small subset of users, it is not recommended for all users. However, if there is a prior agreement between the sender and the recipient, it could be included as previously agreed between the affected parties and therefore might assist in the application processing.				

PESC XML Application for Admission Implementation Guide

Version 1.3.0

Tag Name	Schema Use	Description	Recommended Use	Format
NoteMessage	Optional Repeatable	Additional information about the Applicant as a Person	Not recommended	minOcc 0 maxOcc ∞ minLength 1 maxLength 80
<p>Comment: Because note information is not normally coded, it cannot be automatically processed by a computer. Therefore, its use in an XML application for admission is discouraged. However, if there is a prior agreement between the sender and the recipient, it could be formatted in a previously agreed upon manner between the two parties and therefore might assist in the application processing.</p>				

PESC XML Application for Admission Implementation Guide Version 1.3.0

Applicant.Person (Continued)

Code illustration:

```
<Person>
  <SchoolAssignedPersonID>123456789</SchoolAssignedPersonID>
  <SINID/>
  <NSNID/>
  <AgencyIdentifier>

  </AgencyIdentifier>
  <RecipientAssignedID/>
  <SSN>987654321</SSN>
  <PartialSSN/>
  <Birth>

  </Birth>
  <Name>

  </Name>
  <AlternateName>

  </AlternateName>
  <PreferredName>

  </PreferredName>
  <Citizenship>

  </Citizenship>
  <Contacts>

  </Contacts>
  <Gender>

  </Gender>
  <EthnicityRace>

  </EthnicityRace>
  <CanadianEthnicityRace>

  </CanadianEthnicityRace>
  <ReligiousAffiliationCode>Catholic</ReligiousAffiliationCode>
  <PrivacyRestriction>

  </PrivacyRestriction>
  <Immigration>

  </Immigration>
  <Employment>

  </Employment>
  <FirstSpokenLanguageCode>FRE</FirstSpokenLanguageCode>
  <Language>

  </Language>
  <MaritalStatusCode>Single</MaritalStatusCode>
  <EducationLevel>TwoYearCollegeGraduate</EducationLevel>
  <UserDefinedExtensions/>
  <NoteMessage/>
</Person>
```

PESC XML Application for Admission Implementation Guide Version 1.3.0

Applicant.Person.AgencyIdentifier

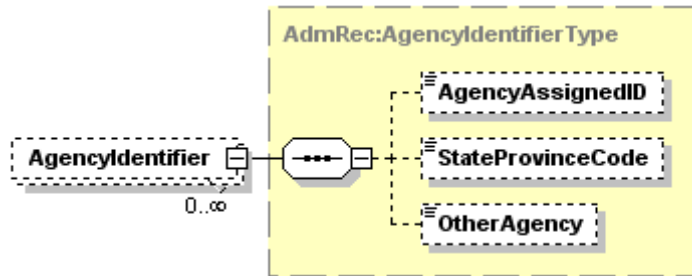

Tag Name	Schema Use	Description	Recommended Use	Format
AgencyAssignedID	Optional	The unique alpha numeric string assigned by an organization to identify a person	Recommended	minOcc 0 maxOcc 1 minLength 1 maxLength 30
StateProvinceCode	Optional	The state or province that assigned the "AgencyAssignedID"	Conditional	minOcc 0 maxOcc 1 See Appendix A for state and province codes.
Comment: Use this data element if a state or province assigned the ID. Otherwise, use the next data element "OtherAgency". But do not use both a "StateCode" and "OtherAgency".				
OtherAgency	Optional	The name of another agency that assigned "AgencyAssignedID".	Conditional	minOcc 0 maxOcc 1 minLength 1 maxLength 30
Comment: Use this data element if an agency other than a state or province assigned the ID. Otherwise, use the previous data element "StateCode". But do not use both a "StateCode" and "OtherAgency".				

Code illustration:

```

<AgencyIdentifier>
  <AgencyAssignedID>RB012345</AgencyAssignedID>
  <StateProvinceCode>FL</StateProvinceCode>
  <OtherAgency/>
</AgencyIdentifier>

```

PESC XML Application for Admission Implementation Guide Version 1.3.0

Applicant.Person.Birth

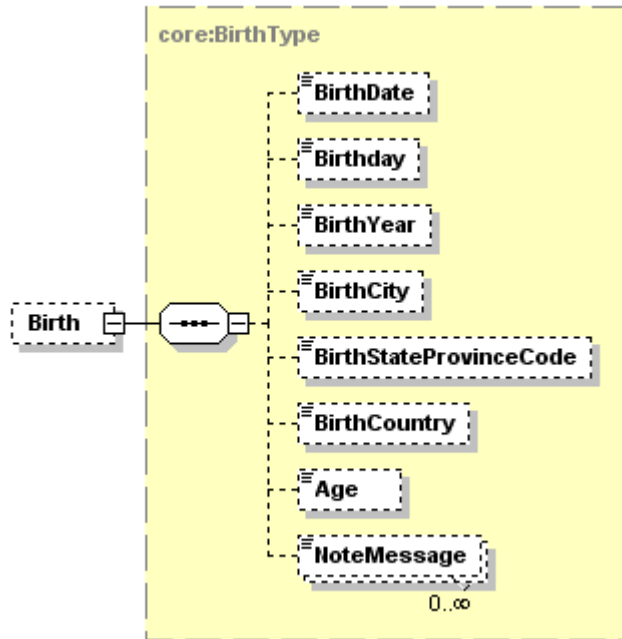

Tag Name	Schema Use	Description	Recommended Use	Format
BirthDate	Optional	Date of Birth	Recommended	minOcc 0 maxOcc 1 xs:date Format is ccyy-mm-dd
Comment: It is strongly recommended by the Workgroup that the complete date of birth be included with the application for admission.				
Birthday	Optional	Month and Day of Birth	Not Recommended	minOcc 0 maxOcc 1 xs:gMonthDay Format is --mm-dd
Comment: Use instead of BirthDate when it is desirable to withhold the student's age. Although possibly appropriate on a student transcript, it would not be appropriate on the Application for Admission.				
BirthYear	Optional	Year of Birth	Not Recommended	minOcc 0 maxOcc 1 gYear - Format is ccyy
Comment: Use instead of BirthDate when the complete date of birth is not known. Although appropriate for a family member, it would not be appropriate for the applicant.				
BirthCity	Optional	The city in which the person was born.	Optional	minOcc 0 maxOcc 1 minLength 1 maxLength 25
BirthStateProvinceCode	Optional	The state, province, or extra-state jurisdiction in which the person was born	Optional	minOcc 0 maxOcc 1 Enumerations: See Appendix A
BirthCountry	Optional	The name of the country in which the person was born. Use ISO 3 155-1 alpha-2 standard.	Optional	minOcc 0 maxOcc 1 Enumerations: See Appendix B

PESC XML Application for Admission Implementation Guide Version 1.3.0

Tag Name	Schema Use	Description	Recommended Use	Format
Age	Optional	An integer that specifies how old a person is	Not Recommended	minOcc 0 maxOcc 1 Format is an integer
<i>Comment: We don't recommend the use of this data element since it can always be derived from the birthday at any time in the future.</i>				
NoteMessage	Optional Repeatable	Additional information about the birth of the applicant	Not Recommended	minOcc 0 maxOcc ∞ minLength 1 maxLength 80

Applicant.Person.Birth (Continued)

Code illustration:

```

<Birth>
  <BirthDate>1987-07-20</BirthDate>
  <Birthday/>
  <BirthYear/>
  <BirthCity>Miami</BirthCity>
  <BirthStateProvinceCode>FL</BirthStateProvinceCode>
  <BirthCountry>US</BirthCountry>
  <Age/>
  <NoteMessage/>
</Birth>

```

PESC XML Application for Admission Implementation Guide Version 1.3.0

Applicant.Person.Name

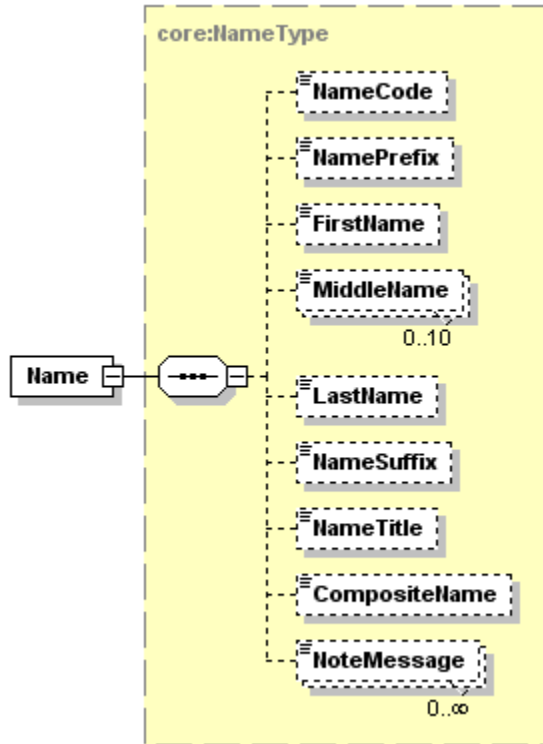

Tag Name	Schema Use	Description	Recommended Use	Format
NameCode	Optional	A code that indicates the type of name that is being described	Recommended	minOcc 0 maxOcc 1 Enumerations: Casual Formal Former LawSchoolApplication Source Legal MedicalSchoolApplicat ion Source Nickname Other
NamePrefix	Optional	An honorific, title or form of address that precedes the name.	Not Recommended	minOcc 0 maxOcc 1 minLength 1 maxLength 30
Comment: The honorific includes such data as "Dr.", "Professor", "Miss", etc. The Workgroup felt that it could do more harm than good to include this information and make it available to the school.				
FirstName	Optional	The first name of the person, usually given at birth, baptism, or during another ceremony, or through legal change	Recommended	minOcc 0 maxOcc 1 minLength 1 maxLength 35
MiddleName	Optional Repeatable	A secondary name of the person, usually given at birth, baptism, or during another naming ceremony or through legal change	Recommended	minOcc 0 maxOcc 10 minLength 1 maxLength 35

PESC XML Application for Admission Implementation Guide

Version 1.3.0

Tag Name	Schema Use	Description	Recommended Use	Format
LastName	Optional	The last name or surname by which a person is legally known	Recommended	minOcc 0 maxOcc 1 minLength 1 maxLength 35
Comment: It is extremely important to collect the name, and especially the last name of the applicant. Most schools would not be able to process the application for admission into the school's data base if the last name is not provided. However, in the rare case of a student who has no last name, it would be essential to provide the first name.				
NameSuffix	Optional	The expression of an individual's generation within a family.	Recommended	minOcc 0 maxOcc 1 Enumerations: I II III IV V VI VII VIII IX X JR SR
NameTitle	Optional	An honorific, title or credential that follows the name.	Not Recommended	minOcc 0 maxOcc 1 minLength 1 maxLength 30
CompositeName	Optional	The full name of the person in Last Name (space) Suffix (comma) First Name (space) Middle Names (spaces). A comma would be included after last name or NameSuffix	Not Recommended	minOcc 0 maxOcc 1 minLength 1 maxLength 45
Comment: The use of the composite format for student name is discouraged. It is much easier for the receiving school to process the individual name parts into its data base than to process a composite name. This data element is scheduled to be deleted in a future major release of the standard.				
NoteMessage	Optional Repeatable	Additional information about the applicant's name	Not Recommended	minOcc 0 maxOcc ∞ minLength 1 maxLength 80

Code illustration:

```

<Name>
  <NameCode>Legal</NameCode>
  <NamePrefix>
  <FirstName>John</FirstName>
  <MiddleName>Billy</MiddleName>
  <MiddleName>Bob</MiddleName>
  <LastName>Thornton</LastName>
  <NameSuffix>JR</NameSuffix>
  <NameTitle/>
  <CompositeName/>
  <NoteMessage/>
</Name>

```

PESC XML Application for Admission Implementation Guide Version 1.3.0

Applicant.Person.AlternateName

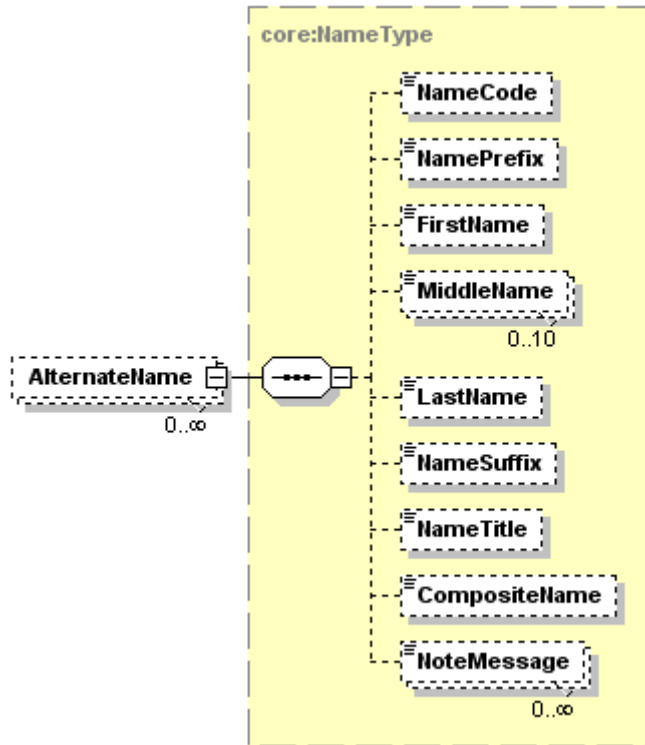

Tag Name	Schema Use	Description	Recommended Use	Format
NameCode	Optional	A code that indicates the type of alternate name that is being described	Recommended	minOcc 0 maxOcc 1 Enumerations: Casual Formal Former LawSchoolApplicationSource Legal MedicalSchoolApplicationSource Nickname Other
NamePrefix	Optional	An honorific, title or form of address that precedes the name.	Not Recommended	minOcc 0 maxOcc 1 minLength 1 maxLength 30
FirstName	Optional	The first name of the person, usually given at birth, baptism, or during another ceremony, or through legal change	Recommended	minOcc 0 maxOcc 1 minLength 1 maxLength 35
MiddleName	Optional Repeatable	A secondary Name of the person, usually given at birth, baptism, or during another naming ceremony or through legal change	Recommended	minOcc 0 maxOcc 10 minLength 1 maxLength 35
LastName	Optional	The last name or surname by which a person is legally known	Recommended	minOcc 1 maxOcc 1 minLength 1 maxLength 35

PESC XML Application for Admission Implementation Guide

Version 1.3.0

Tag Name	Schema Use	Description	Recommended Use	Format
NameSuffix	Optional	The expression of an individual's generation within a family.	Recommended	minOcc 0 maxOcc 1 Enumeration: I II III IV V VI VII VIII IX X JR SR
NameTitle	Optional	An honorific, title or credential that follows the name.	Not Recommended	minOcc 0 maxOcc 1 minLength 1 maxLength 30
CompositeName	Optional	The full name of the person in Last, First Middle order, comma after last name	Not Recommended	minOcc 0 maxOcc 1 minLength 1 maxLength 45
Comment: The use of the composite format for student name is discouraged. It is much easier for the receiving school to process the individual name parts into its data base than to process a composite name. This data element is scheduled to be deleted in a future release of the standard.				
NoteMessage	Optional Repeatable	Additional information about the alternate name	Not Recommended	minOcc 0 maxOcc ∞ minLength 1 maxLength 80
Comment: Alternate names may include former names, nicknames, or other names by which the student may now be (or have been) known.				

Code illustration:

```

<AlternateName>
  <NameCode>Former</NameCode>
  <NamePrefix/>
  <FirstName>Test</FirstName>
  <MiddleName>Record</MiddleName>
  <MiddleName>Test</MiddleName>
  <LastName>Speede</LastName>
  <NameSuffix/>
  <NameTitle/>
  <CompositeName/>
  <NoteMessage/>
</AlternateName>

```

PESC XML Application for Admission Implementation Guide Version 1.3.0

Applicant.Person.PreferredName

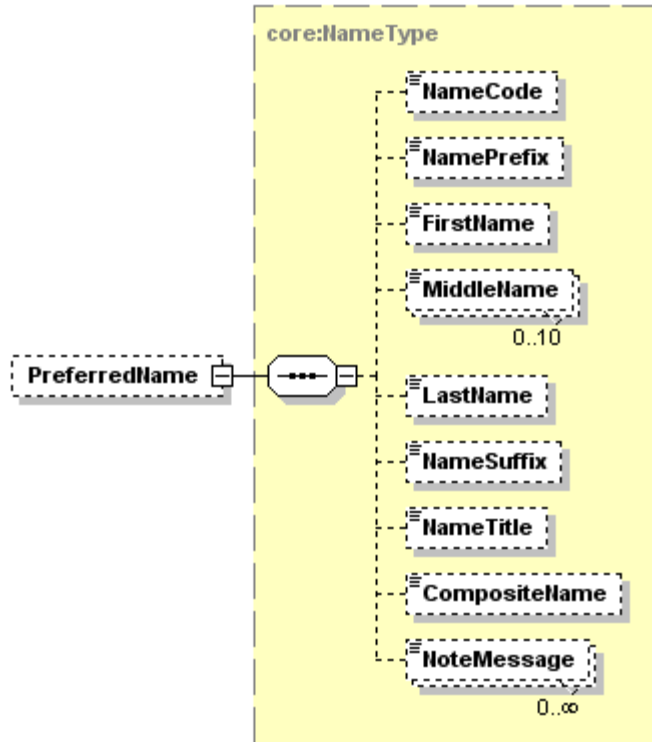

Tag Name	Schema Use	Description	Recommended Use	Format
NameCode	Optional	A code that indicates the type of preferred name that is being described	Recommended	minOcc 0 maxOcc 1 Enumerations: Casual Formal Former LawSchoolApplicationSource Legal MedicalSchoolApplicationSource Nickname Other
NamePrefix	Optional	An honorific, title or form of address that precedes the name.	Not Recommended	minOcc 0 maxOcc 1 minLength 1 maxLength 30
FirstName	Optional	The first name of the person, usually given at birth, baptism, or during another ceremony, or through legal change	Recommended	minOcc 0 maxOcc 1 minLength 1 maxLength 35
MiddleName	Optional Repeatable	A secondary Name of the person, usually given at birth, baptism, or during another naming ceremony or through legal change	Recommended	minOcc 0 maxOcc 10 minLength 1 maxLength 35
LastName	Optional	The last name or surname by which a person is legally known	Recommended	minOcc 1 maxOcc 1 minLength 1 maxLength 35

PESC XML Application for Admission Implementation Guide

Version 1.3.0

Tag Name	Schema Use	Description	Recommended Use	Format
NameSuffix	Optional	The expression of an individual's generation within a family.	Recommended	minOcc 0 maxOcc 1 Enumeration: I II III IV V VI VII VIII IX X JR SR
NameTitle	Optional	An honorific, title or credential that follows the name.	Not Recommended	minOcc 0 maxOcc 1 minLength 1 maxLength 30
CompositeName	Optional	The full name of the person in Last, First Middle order, comma after last name	Not Recommended	minOcc 0 maxOcc 1 minLength 1 maxLength 45
Comment: The use of the composite format for student name is discouraged. It is much easier for the receiving school to process the individual name parts into its data base than to process a composite name. This data element is scheduled to be deleted in a future release of the standard.				
NoteMessage	Optional Repeatable	Additional information about the alternate name	Not Recommended	minOcc 0 maxOcc ∞ minLength 1 maxLength 80
Comment: Preferred name may include former names, nicknames, or other names by which the student may now be (or have been) known as. This is the name by which the applicant may designate as the preferred way to communicate with the applicant for future contacts.				

Code illustration:

```

<PreferredName>
  <NameCode>Casual</NameCode>
  <NamePrefix/>
  <FirstName/>
  <MiddleName>Tom</MiddleName>
  <LastName/>
  <NameSuffix/>
  <NameTitle/>
  <CompositeName/>
  <NoteMessage/>
</PreferredName>

```

PESC XML Application for Admission Implementation Guide Version 1.3.0

Applicant.Person.Citizenship

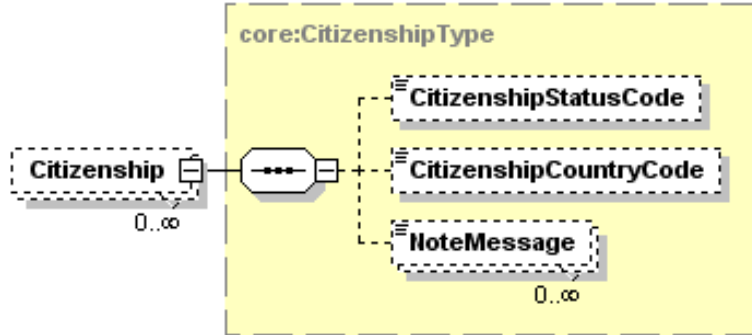

Tag Name	Schema Use	Description	Recommended Use	Format
CitizenshipStatusCode	Optional	Citizenship status of the applicant	Recommended	minOcc 0 maxOcc 1 Enumerations: Asylee Citizen EligibleNonCitizen IllegalAlien LandedImmigrant MinistersPermit NonCitizen NonPermanentResidentAlien NonResidentAlien NonResidentCitizen NotEligible PermanentVisa Refugee ResidentAlien StudentAuthorization StudentVisa TemporaryVisa UndocumentedAlien VisitorVisa WorkVisa
CitizenshipCountryCode	Optional	The country in which the applicant holds the status represented by the Citizenship Status Code above.	Recommended	minOcc 0 maxOcc 1 See Appendix B for ISO codes for 2 digit codes of countries of the world
NoteMessage	Optional Repeatable	Additional information about the citizenship status of the applicant	Not Recommended	minOcc 0 maxOcc ∞ minLength 1 maxLength 80
Comment: This allows for the transmission of citizenship statuses for applicants with dual citizenship, as well as allowing for the identification of the country of citizenship and the immigration status in the US or Canada.				

Code illustration:

```

<Citizenship>
  <CitizenshipStatusCode>Citizen</CitizenshipStatusCode>
  <CitizenshipCountryCode>BR</CitizenshipCountryCode>
  <NoteMessage/>
</Citizenship>
<Citizenship>
  <CitizenshipStatusCode>ResidentAlien</CitizenshipStatusCode>
  <CitizenshipCountryCode>US</CitizenshipCountryCode>
  <NoteMessage/>
</Citizenship>
    
```

PESC XML Application for Admission Implementation Guide Version 1.3.0

Applicant.Person.Contacts

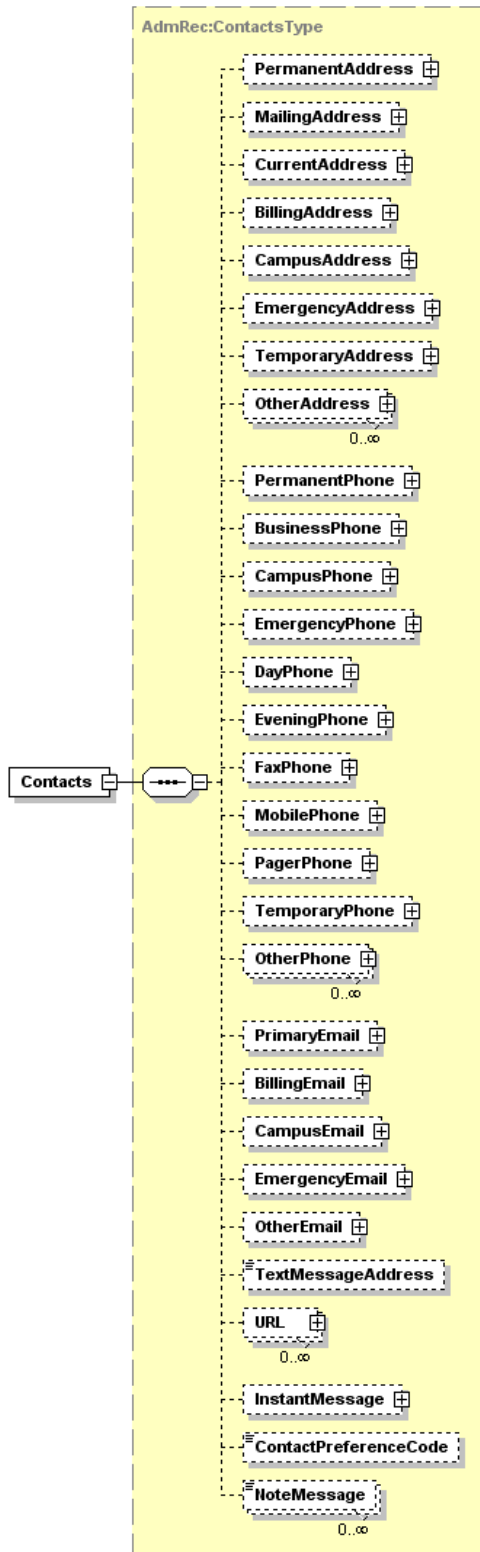

PESC XML Application for Admission Implementation Guide Version 1.3.0

Applicant.Person.Contacts (Continued)

Tag Name	Schema Use	Description	Recommended Use	Format
PermanentAddress	Optional	This is a combined Address Group for a choice between Domestic or International	Recommended	minOcc 0 maxOcc 1
Comment: This is the one address that is strongly recommended for the applicant. Additional information about the complex data element PermanentAddress will be shown on page 68.				
MailingAddress	Optional	This is a combined Address Group for a choice between Domestic or International	Optional	minOcc 0 maxOcc 1
Comment: Additional information about this complex data element will be shown on page 71.				
CurrentAddress	Optional	This is a combined Address Group for a choice between Domestic or International	Recommended	minOcc 0 maxOcc 1
Comment: Additional information about this complex data element will be shown on page 74.				
BillingAddress	Optional	This is a combined Address Group for a choice between Domestic or International	Optional	minOcc 0 maxOcc 1
Comment: This is the billing address that may be provided by the applicant and includes the effective and expiration dates. Additional information about the complex data element Billing Address will be shown on page 77.				
CampusAddress	Optional	This is a combined Address Group for a choice between Domestic or International	Optional	minOcc 0 maxOcc 1
Comment: This is the campus address that may be provided by the applicant. Additional information about the complex data element CampusAddress will be shown on page 80.				
EmergencyAddress	Optional	This is a combined Address Group for a choice between Domestic or International	Recommended	minOcc 0 maxOcc 1
Comment: This is an emergency address that may be provided by the applicant. Additional information about the complex data element EmergencyAddress will be shown on page 83.				
TemporaryAddress	Optional	This is a combined Address Group for a choice between Domestic or International	Optional	minOcc 0 maxOcc 1
Comment: This is a temporary address that may be provided by the applicant. Additional information about the complex data element TemporaryAddress will be shown on page 86.				
OtherAddress	Optional Repeatable	This is a combined Address Group for a choice between Domestic or International	Optional	minOcc 0 maxOcc ∞
Comment: This allows for the applicant to specify other addresses that might be appropriate. Additional information about the complex data element OtherAddress will be shown on page 89.				
PermanentPhone	Optional	Permanent Contact Phone number for the applicant	Recommended	minOcc 0 maxOcc 1
Comment: Additional information about the complex data element PermanentPhone will be shown on page 92.				
BusinessPhone	Optional	Phone number for the applicant at the applicant's place of work	Optional	minOcc 0 maxOcc 1
Comment: Additional information about this complex data element will be shown on page 94.				

PESC XML Application for Admission Implementation Guide

Version 1.3.0

Tag Name	Schema Use	Description	Recommended Use	Format
CampusPhone	Optional	Phone number for the applicant on campus	Optional	minOcc 0 maxOcc 1
Comment: Additional information about this complex data element will be shown on page 96.				
EmergencyPhone	Optional	An emergency phone number for the applicant	Recommended	minOcc 0 maxOcc 1
Comment: Additional information about this complex data element will be shown on page 98.				
DayPhone	Optional	A phone number where the applicant can normally be contacted during normal daytime hours	Recommended	minOcc 0 maxOcc 1
Comment: Additional information about this complex data element will be shown on page 100.				
EveningPhone	Optional	A phone number where the applicant can normally be contacted during evening and weekend hours	Optional	minOcc 0 maxOcc 1
Comment: Additional information about this complex data element will be shown on page 102.				
FaxPhone	Optional	A Fax number for the applicant	Optional	minOcc 0 maxOcc 1
Comment: Additional information about this complex data element will be shown on page 104.				
MobilePhone	Optional	Mobile or cell phone number for the applicant	Recommended	minOcc 0 maxOcc 1
Comment: Additional information about this complex data element will be shown on page 106.				
PagerPhone	Optional	A phone number for the applicant's pager	Optional	minOcc 0 maxOcc 1
Comment: Additional information about this complex data element will be shown on page 108.				
TemporaryPhone	Optional	A temporary phone number for the applicant	Optional	minOcc 0 maxOcc 1
Comment: Additional information about this complex data element will be shown on page 110.				
OtherPhone	Optional Repeatable	A temporary phone number for the applicant	Optional	minOcc 0 maxOcc ∞
Comment: Additional information about the complex data element will be shown on page 112.				
PrimaryEmail	Optional	Primary Preferred Email address for the applicant	Recommended	minOcc 0 maxOcc 1
Comment: Additional information about the complex data element PrimaryEmail will be shown on page 114				
BillingEmail	Optional	Email address preferred by the applicant for billing purposes	Optional	minOcc 0 maxOcc 1
Comment: Additional information about this complex data element will be shown on page 115.				
CampusEmail	Optional	Email address for the applicant on campus	Optional	minOcc 0 maxOcc 1
Comment: Additional information about this complex data element will be shown on page 116.				
EmergencyEmail	Optional	Email address provided by the applicant in case of an emergency	Optional	minOcc 0 maxOcc 1
Comment: Additional information about the complex data element OtherEmail will be shown on page 117.				

PESC XML Application for Admission Implementation Guide

Version 1.3.0

Tag Name	Schema Use	Description	Recommended Use	Format
OtherEmail	Optional	Email address(es) for the applicant	Optional	minOcc 0 maxOcc 1
Comment: Additional information about the complex data element OtherEmail will be shown on page 118.				
TextMessageAddress	Optional	The address to which a text message may be sent to the applicant	Optional	minOcc 0 maxOcc 1 minLength 1 maxLength 80
URL	Optional Repeatable	Personal URL(s) for the applicant	Optional	minOcc 0 maxOcc ∞
Comment: Additional information about the complex data element Uniform Resource Locator (URL) will be shown on page 119.				
InstantMessage	Optional	Information that will allow an instant message to be sent to the applicant	Optional	minOcc 0 maxOcc 1
Comment: Additional information about the complex data element Instant Message will be shown on page 120.				
ContactPreferenceCode	Optional	The preferred method by which the applicant would like to receive further communication from the postsecondary institution to which the applicant is applying	Recommended	minOcc 0 maxOcc 1 Enumerations: Email InstantMessage Phone PostalMail TextMessage
NoteMessage	Optional Repeatable	Additional information about the Contacts	Not Recommended	minOcc 0 maxOcc ∞ minLength 1 maxLength 80
Comment: The inclusion of contact information about the applicant is essential for creating and updating a school's student information system for the applicant.				

PESC XML Application for Admission Implementation Guide Version 1.3.0

Applicant.Person.Contacts (Continued)

Code illustration:

```
<Contacts>
  <PermanentAddress>

    </PermanentAddress>
  <MailingAddress>

    </MailingAddress>
  <CurrentAddress>

    </CurrentAddress>
  <BillingAddress>

    </BillingAddress>
  <CampusAddress>

    </CampusAddress>
  <EmergencyAddress>

    </EmergencyAddress>
  <TemporaryAddress>

    </TemporaryAddress>
  <OtherAddress>

    </OtherAddress>
  <PermanentPhone>

    </PermanentPhone>
  <BusinessPhone>

    </BusinessPhone>
  <CampusPhone>

    </CampusPhone>
  <EmergencyPhone>

    </EmergencyPhone>
  <DayPhone>

    </DayPhone>
  <EveningPhone>

    </EveningPhone>
  <FaxPhone>

    </FaxPhone>
  <MobilePhone>

    </MobilePhone>
  <PagerPhone>

    </PagerPhone>
  <TemporaryPhone>

    </TemporaryPhone>
  <OtherPhone>

    </OtherPhone>
  <PrimaryEmail>

    </PrimaryEmail>
  <BillingEmail>

    </BillingEmail>
```

PESC XML Application for Admission Implementation Guide Version 1.3.0

```
<CampusEmail>  
</CampusEmail>  
<EmergencyEmail>  
  
</EmergencyEmail>  
<OtherEmail>  
  
</OtherEmail>  
<TextMessageAddress>XXXXXXXXX</TextMessageAddress>  
<URL>  
  
</URL>  
<InstantMessage>  
  
</InstantMessage>  
<ContactPreferenceCode>Email</ContactPreferenceCode>  
<NoteMessage/>  
</Contacts>
```

PESC XML Application for Admission Implementation Guide Version 1.3.0

Applicant.Person.Contacts.PermanentAddress

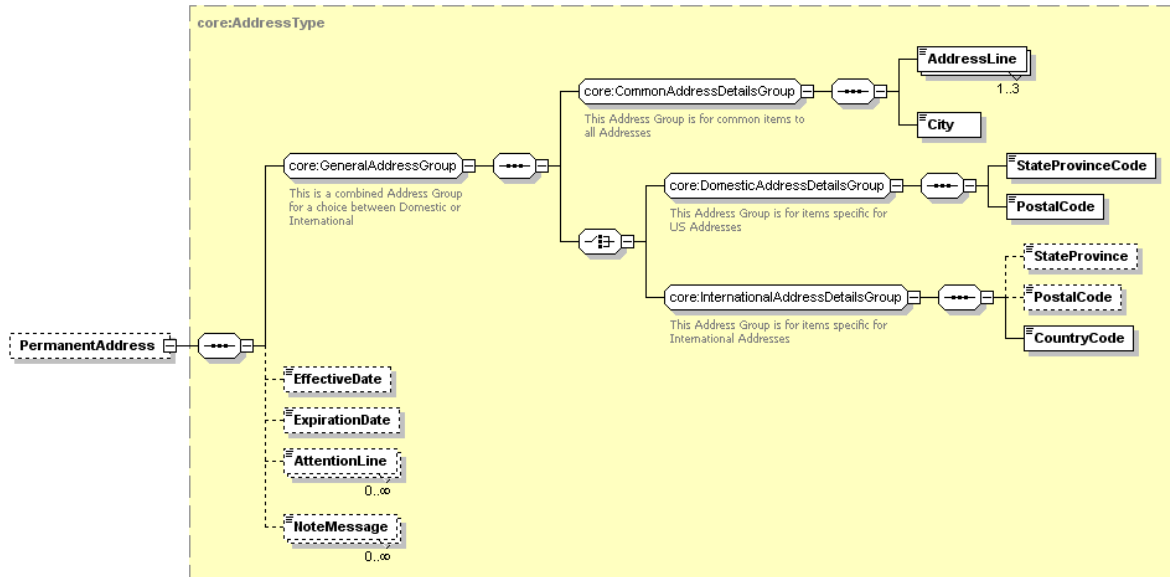

Tag Name	Schema Use	Description	Recommended Use	Format
<i>GeneralAddressGroup</i>	Required	This Address Group is for items common to all Addresses	Required	minOcc 1 maxOcc 1
Comment: [<i>GeneralAddressGroup</i>] does not appear as such in the instance document. It requires the use of <i>CommonAddressDetailsGroup</i> and the choice of one of either <i>DomesticAddressDetailsGroup</i> or <i>InternationalAddressDetailsGroup</i> .				
<i>CommonAddressDetailsGroup</i>	Required	This Address Group is for items common to all Addresses	Required	minOcc 1 maxOcc 1
Comment: [<i>CommonAddressDetailsGroup</i>] does not appear in the instance document. It is required and must be paired with one of either <i>DomesticAddressDetailsGroup</i> or <i>InternationalAddressDetailsGroup</i> .				
AddressLine	Required Repeatable	Local delivery information such as street, building number, PO box, or apartment portion of a postal address of the applicant	Required	minOcc 1 maxOcc 3 minLength 1 maxLength 40
City	Required	The city portion of the Address of the applicant	Required	minOcc 1 maxOcc 1 minLength 2 maxLength 30
<i>DomesticAddressDetailsGroup</i>	Required choice	This Address Group is for items specific for US and Canadian Addresses	Required for domestic addresses	minOcc 1 maxOcc 1
Comment: [<i>DomesticAddressDetailsGroup</i>] does not appear in the instance document. If the complex data element address has a United States or Canadian Postal Code and a US State or Canadian Province Code, then this must be the required choice.				
StateProvinceCode	Required	Code for US states, etc., and Canadian provinces.	Required for domestic addresses	minOcc 1 maxOcc 1 Enumeration: See Appendix A
PostalCode	Required	The postal code portion of the Address.	Required for domestic addresses	minOcc 1 maxOcc 1 minLength 1 maxLength 17

PESC XML Application for Admission Implementation Guide

Version 1.3.0

Tag Name	Schema Use	Description	Recommended Use	Format
<i>InternationalAddressDetailsGroup</i>	Required choice	This Address Group is for items specific for International Addresses	Required for international addresses	minOcc 1 maxOcc 1
Comment: [InternationalAddressDetailsGroup] does not appear in the instance document. This choice is for addresses that do not have a US or Canadian postal code.				
StateProvince	Optional	The literal name of the state, province or territory of a postal address of the source of this document. Use for addresses outside US or Canada.	Recommended Refer to common postal practices of the source country	minOcc 0 maxOcc 1 minLength 2 maxLength 30
Comment: For an internet resource of states or other geographical subdivisions in countries other than the US and Canada, you might choose to refer to the website of the Universal Postal Union at http://www.upu.int				
PostalCode	Optional	The postal code portion of the Address.	Recommended Refer to common postal practices of the source country	minOcc 0 maxOcc 1 minLength 1 maxLength 17
Comment: For an internet resource of states or other geographical subdivisions in countries other than the US and Canada, you might choose to refer to the website of the Universal Postal Union at http://www.upu.int				
CountryCode	Required	Code indicating Country. Use ISO 3166-1 alpha-2 standard.	Required for international addresses	minOcc 1 maxOcc 1 Enumerations: See Appendix B1 or B2
EffectiveDate	Optional	The date on which the address became (or will become) effective	Optional	minOcc 0 maxOcc 1 Date format: CCYY-MM-DD
ExpirationDate	Optional	The date on which the address will (or did) expire	Not Recommended	minOcc 0 maxOcc 1 Date format: CCYY-MM-DD
AttentionLine	Optional	The individual or office name within the postal address where inquiries should be directed.	Not Recommended	minOcc 0 maxOcc ∞ minLength 1 maxLength 45
NoteMessage	Optional Repeatable	Additional information about the addresses of the applicant	Not recommended	minOcc 0 maxOcc ∞ minLength 1 maxLength 80

PESC XML Application for Admission Implementation Guide Version 1.3.0

Applicant.Person.Contacts.PermanentAddress (Continued)

Code illustration 1 (Domestic Address):

```
<PermanentAddress>  
  <AddressLine>1715 W Cesar Chavez</AddressLine>  
  <City>Austin</City>  
  <StateProvinceCode>TX</StateProvinceCode>  
  <PostalCode>78703</PostalCode>  
  <EffectiveDate/>  
  <ExpirationDate/>  
  <AttentionLine/>  
  <NoteMessage/>  
</PermanentAddress>
```

Code illustration 2 (International Address):

```
<PermanentAddress>  
  <AddressLine>Altova Corporation</AddressLine>  
  <AddressLine>Rudolfsplatz 13a/9</AddressLine>  
  <City>Wien</City>  
  <StateProvince/>  
  <PostalCode>A-1010</PostalCode>  
  <CountryCode>AT</CountryCode>  
  <EffectiveDate/>  
  <ExpirationDate/>  
  <AttentionLine/>  
  <NoteMessage/>  
</PermanentAddress>
```

PESC XML Application for Admission Implementation Guide Version 1.3.0

Applicant.Person.Contacts.MailingAddress

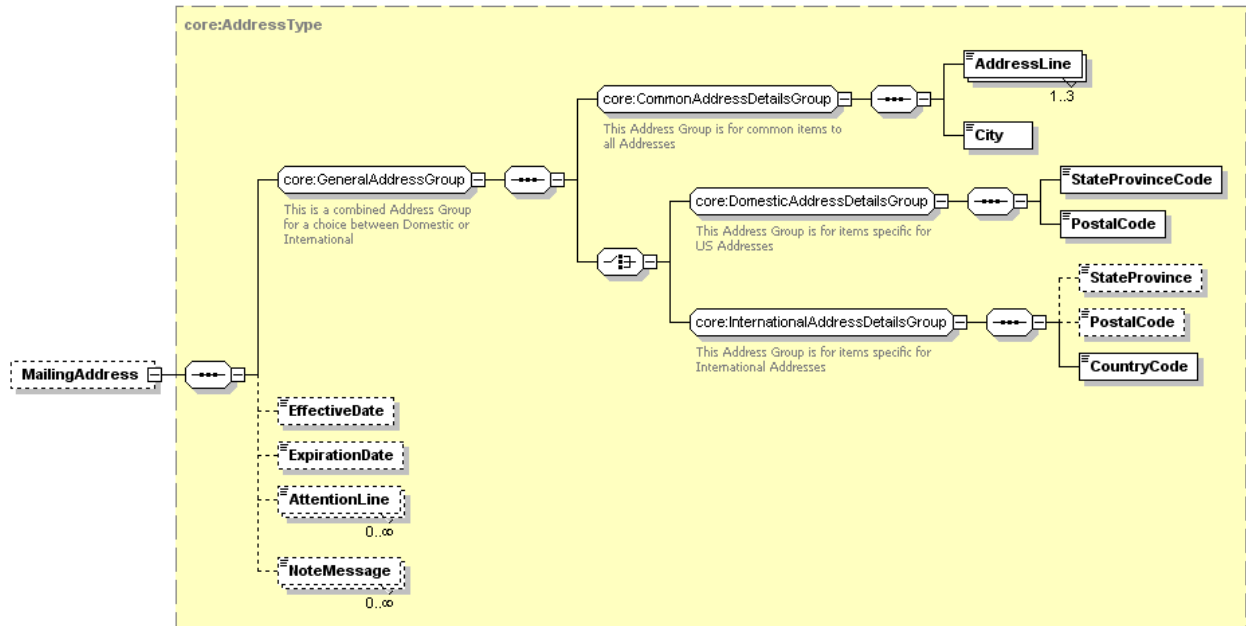

Tag Name	Schema Use	Description	Recommended Use	Format
<i>GeneralAddressGroup</i>	Required	This Address Group is for items common to all Addresses	Required	minOcc 1 maxOcc 1
Comment: [<i>GeneralAddressGroup</i>] does not appear as such in the instance document. It requires the use of <i>CommonAddressDetailsGroup</i> and the choice of one of either <i>DomesticAddressDetailsGroup</i> or <i>InternationalAddressDetailsGroup</i> .				
<i>CommonAddressDetailsGroup</i>	Required	This Address Group is for items common to all Addresses	Required	minOcc 1 maxOcc 1
Comment: [<i>CommonAddressDetailsGroup</i>] does not appear in the instance document. It is required and must be paired with one of either <i>DomesticAddressDetailsGroup</i> or <i>InternationalAddressDetailsGroup</i> .				
AddressLine	Required Repeatable	Local delivery information such as street, building number, PO box, or apartment portion of a postal address of the applicant	Required	minOcc 1 maxOcc 3 minLength 1 maxLength 40
City	Required	The city portion of the address of the applicant	Required	minOcc 1 maxOcc 1 minLength 2 maxLength 30
<i>DomesticAddressDetailsGroup</i>	Required choice	This Address Group is for items specific for US and Canadian Addresses	Required for domestic addresses	minOcc 1 maxOcc 1
Comment: [<i>DomesticAddressDetailsGroup</i>] does not appear in the instance document. If the complex data element address has a United States or Canadian Postal Code and a US State or Canadian Province Code, then this must be the required choice.				
StateProvinceCode	Required	Code for US states, etc., and Canadian provinces.	Required for domestic addresses	minOcc 1 maxOcc 1 Enumeration: See Appendix A

PESC XML Application for Admission Implementation Guide

Version 1.3.0

Tag Name	Schema Use	Description	Recommended Use	Format
PostalCode	Required	The postal code portion of the Address.	Required for domestic addresses	minOcc 1 maxOcc 1 minLength 1 maxLength 17
<i>InternationalAddressDetailsGroup</i>	Required choice	This Address Group is for items specific for International Addresses	Required for international addresses	minOcc 1 maxOcc 1
Comment: [InternationalAddressDetailsGroup] does not appear in the instance document. This choice is for addresses that do not have a US or Canadian postal code.				
StateProvince	Optional	The literal name of the state, province or territory of a postal address of the source of this document. Use for addresses outside US or Canada.	Recommended Refer to common postal practices of the source country	minOcc 0 maxOcc 1 minLength 2 maxLength 30
Comment: For an internet resource of states or other geographical subdivisions in countries other than the US and Canada, you might choose to refer to the website of the Universal Postal Union at http://www.upu.int				
PostalCode	Optional	The postal code portion of the Address.	Recommended Refer to common postal practices of the source country	minOcc 0 maxOcc 1 minLength 1 maxLength 17
Comment: For an internet resource of states or other geographical subdivisions in countries other than the US and Canada, you might choose to refer to the website of the Universal Postal Union at http://www.upu.int				
CountryCode	Required	Code indicating Country. Use ISO 3166-1 alpha-2 standard.	Required for international addresses	minOcc 1 maxOcc 1 Enumerations: See Appendix B1 or B2
EffectiveDate	Optional	The date on which the address became (or will become) effective	Optional	minOcc 0 maxOcc 1 Date format: CCYY-MM-DD
ExpirationDate	Optional	The date on which the address will (or did) expire	Optional	minOcc 0 maxOcc 1 Date format: CCYY-MM-DD
AttentionLine	Optional	The individual or office name within the postal address where inquiries should be directed.	Not Recommended	minOcc 0 maxOcc ∞ min length 1 maxLength 45
NoteMessage	Optional Repeatable	Additional information about the addresses of the applicant	Not recommended	minOcc 0 maxOcc ∞ minLength 1 maxLength 80

PESC XML Application for Admission Implementation Guide Version 1.3.0

Applicant.Person.Contacts.MailingAddress (Continued)

Code illustration 1 (Domestic Address):

```
<MailingAddress>  
  <AddressLine>1715 W Cesar Chavez</AddressLine>  
  <City>Austin</City>  
  <StateProvinceCode>TX</StateProvinceCode>  
  <PostalCode>78703</PostalCode>  
  <EffectiveDate>2008-09-01</EffectiveDate>  
  <ExpirationDate/>  
  <AttentionLine/>  
  <NoteMessage/>  
</MailingAddress>
```

Code illustration 2 (International Address):

```
<MailingAddress>  
  <AddressLine>Altova Corporation</AddressLine>  
  <AddressLine>Rudolfsplatz 13a/9</AddressLine>  
  <City>Wien</City>  
  <StateProvince/>  
  <PostalCode>A-1010</PostalCode>  
  <CountryCode>AT</CountryCode>  
  <EffectiveDate>2008-09-01</EffectiveDate>  
  <ExpirationDate/>  
  <AttentionLine/>  
  <NoteMessage/>  
</MailingAddress>
```

PESC XML Application for Admission Implementation Guide Version 1.3.0

Applicant.Person.Contacts.CurrentAddress

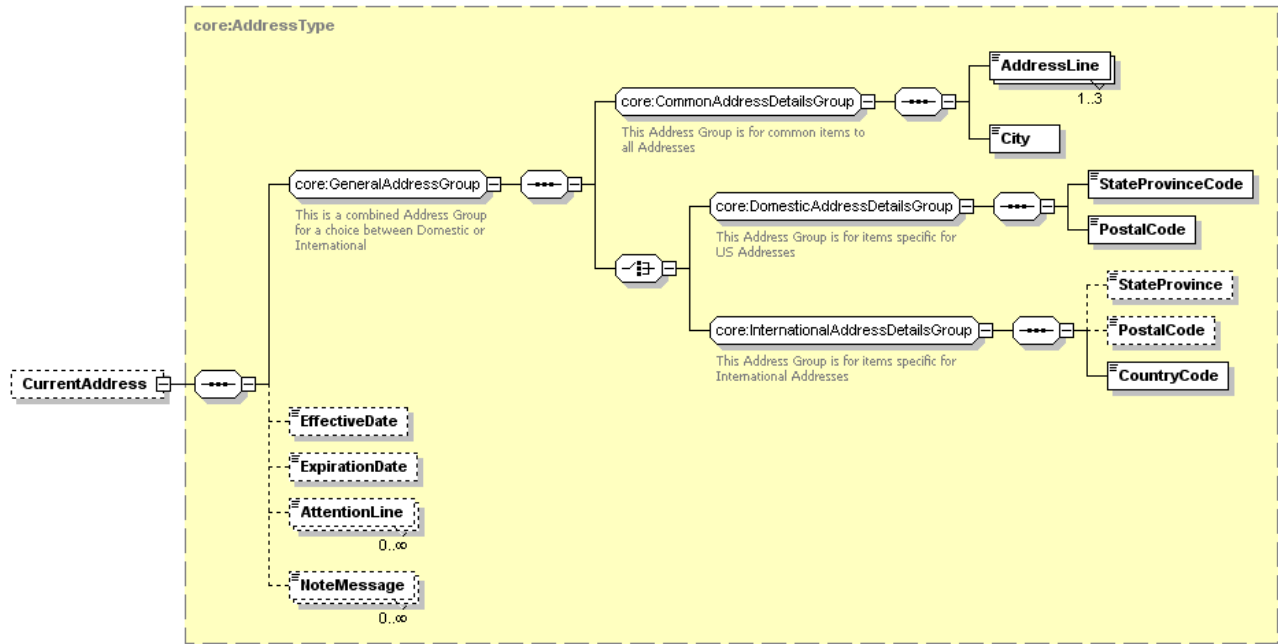

Tag Name	Schema Use	Description	Recommended Use	Format
<i>GeneralAddressGroup</i>	Required	This Address Group is for items common to all Addresses	Required	minOcc 1 maxOcc 1
Comment: [<i>GeneralAddressGroup</i>] does not appear as such in the instance document. It requires the use of <i>CommonAddressDetailsGroup</i> and the choice of one of either <i>DomesticAddressDetailsGroup</i> or <i>InternationalAddressDetailsGroup</i> .				
<i>CommonAddressDetailsGroup</i>	Required	This Address Group is for items common to all Addresses	Required	minOcc 1 maxOcc 1
Comment: [<i>CommonAddressDetailsGroup</i>] does not appear in the instance document. It is required and must be paired with one of either <i>DomesticAddressDetailsGroup</i> or <i>InternationalAddressDetailsGroup</i> .				
AddressLine	Required Repeatable	Local delivery information such as street, building number, PO box, or apartment portion of a postal address of the applicant	Required	minOcc 1 maxOcc 3 minLength 1 maxLength 40
City	Required	The city portion of the Address of the applicant	Required	minOcc 1 maxOcc 1 minLength 2 maxLength 30
<i>DomesticAddressDetailsGroup</i>	Required choice	This Address Group is for items specific for US and Canadian Addresses	Required for domestic addresses	minOcc 1 maxOcc 1
Comment: [<i>DomesticAddressDetailsGroup</i>] does not appear in the instance document. If the complex data element address has a United States or Canadian Postal Code and a US State or Canadian Province Code, then this must be the required choice.				
StateProvinceCode	Required	Code for US states, etc., and Canadian provinces.	Required for domestic addresses	minOcc 1 maxOcc 1 Enumeration: See Appendix A

PESC XML Application for Admission Implementation Guide

Version 1.3.0

Tag Name	Schema Use	Description	Recommended Use	Format
PostalCode	Required	The postal code portion of the Address.	Required for domestic addresses	minOcc 1 maxOcc 1 minLength 1 maxLength 17
<i>InternationalAddressDetailsGroup</i>	Required choice	This Address Group is for items specific for International Addresses	Required for international addresses	minOcc 1 maxOcc 1
Comment: [InternationalAddressDetailsGroup] does not appear in the instance document. This choice is for addresses that do not have a US or Canadian postal code.				
StateProvince	Optional	The literal name of the state, province or territory of a postal address of the source of this document. Use for addresses outside US or Canada.	Recommended Refer to common postal practices of the source country	minOcc 0 maxOcc 1 minLength 2 maxLength 30
Comment: For an internet resource of states or other geographical subdivisions in countries other than the US and Canada, you might choose to refer to the website of the Universal Postal Union at http://www.upu.int				
PostalCode	Optional	The postal code portion of the Address.	Recommended Refer to common postal practices of the source country	minOcc 0 maxOcc 1 minLength 1 maxLength 17
Comment: For an internet resource of states or other geographical subdivisions in countries other than the US and Canada, you might choose to refer to the website of the Universal Postal Union at http://www.upu.int				
CountryCode	Required	Code indicating Country. Use ISO 3166-1 alpha-2 standard.	Required for international addresses	minOcc 1 maxOcc 1 Enumerations: See Appendix B1 or B2
EffectiveDate	Optional	The date on which the address became (or will become) effective	Optional	minOcc 0 maxOcc 1 Date format: CCYY-MM-DD
ExpirationDate	Optional	The date on which the address will (or did) expire	Optional	minOcc 0 maxOcc 1 Date format: CCYY-MM-DD
AttentionLine	Optional	The individual or office name within the postal address where inquiries should be directed.	Not Recommended	minOcc 0 maxOcc ∞ minLength 1 maxLength 45
NoteMessage	Optional Repeatable	Additional information about the addresses of the applicant	Not recommended	minOcc 0 maxOcc ∞ minLength 1 maxLength 80

PESC XML Application for Admission Implementation Guide Version 1.3.0

Applicant.Person.Contacts.CurrentAddress (Continued)

Code illustration 1 (Domestic Address):

```
<CurrentAddress>  
  <AddressLine>1715 W Cesar Chavez</AddressLine>  
  <City>Austin</City>  
  <StateProvinceCode>TX</StateProvinceCode>  
  <PostalCode>78703</PostalCode>  
  <EffectiveDate/>  
  <ExpirationDate>2009-10-07</ExpirationDate>  
  <AttentionLine/>  
  <NoteMessage/>  
</CurrentAddress>
```

Code illustration 2 (International Address):

```
<CurrentAddress>  
  <AddressLine>Altova Corporation</AddressLine>  
  <AddressLine>Rudolfsplatz 13a/9</AddressLine>  
  <City>Wien</City>  
  <StateProvince/>  
  <PostalCode>A-1010</PostalCode>  
  <CountryCode>AT</CountryCode>  
  <EffectiveDate/>  
  <ExpirationDate>2009-10-07</ExpirationDate>  
  <AttentionLine/>  
  <NoteMessage/>  
</CurrentAddress>
```

PESC XML Application for Admission Implementation Guide Version 1.3.0

Applicant.Person.Contacts.BillingAddress

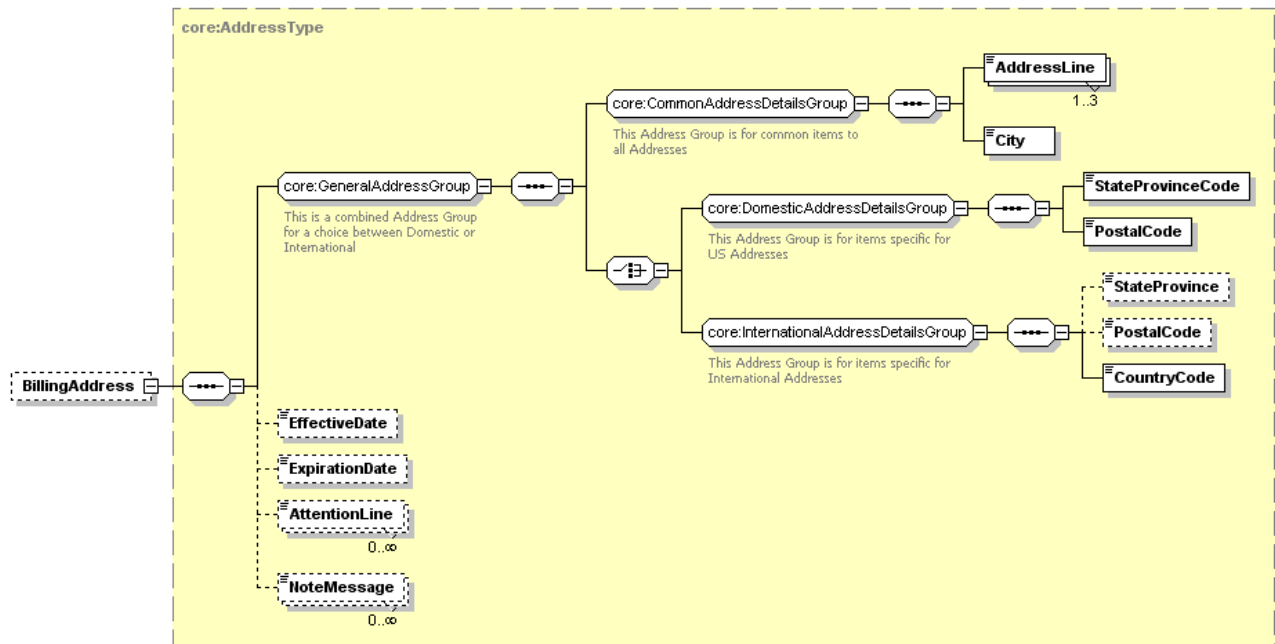

Tag Name	Schema Use	Description	Recommended Use	Format
<i>GeneralAddressGroup</i>	Required	This Address Group is for items common to all Addresses	Required	minOcc 1 maxOcc 1
Comment: [<i>GeneralAddressGroup</i>] does not appear as such in the instance document. It requires the use of <i>CommonAddressDetailsGroup</i> and the choice of one of either <i>DomesticAddressDetailsGroup</i> or <i>InternationalAddressDetailsGroup</i> .				
<i>CommonAddressDetailsGroup</i>	Required	This Address Group is for items common to all Addresses	Required	minOcc 1 maxOcc 1
Comment: [<i>CommonAddressDetailsGroup</i>] does not appear in the instance document. It is required and must be paired with one of either <i>DomesticAddressDetailsGroup</i> or <i>InternationalAddressDetailsGroup</i> .				
AddressLine	Required Repeatable	Local delivery information such as street, building number, PO box, or apartment portion of a postal address of the applicant	Required	minOcc 1 maxOcc 3 minLength 1 maxLength 40
City	Required	The city portion of the Address of the applicant	Required	minOcc 1 maxOcc 1 minLength 2 maxLength 30
<i>DomesticAddressDetailsGroup</i>	Required choice	This Address Group is for items specific for US and Canadian Addresses	Required for domestic addresses	minOcc 1 maxOcc 1
Comment: [<i>DomesticAddressDetailsGroup</i>] does not appear in the instance document. If the complex data element address has a United States or Canadian Postal Code and a US State or Canadian Province Code, then this must be the required choice.				
StateProvinceCode	Required	Code for US states, etc., and Canadian provinces.	Required for domestic addresses	minOcc 1 maxOcc 1 Enumeration: See Appendix A

PESC XML Application for Admission Implementation Guide

Version 1.3.0

Tag Name	Schema Use	Description	Recommended Use	Format
PostalCode	Required	The postal code portion of the Address.	Required for domestic addresses	minOcc 1 maxOcc 1 minLength 1 maxLength 17
<i>InternationalAddressDetailsGroup</i>	Required choice	This Address Group is for items specific for International Addresses	Required for international addresses	minOcc 1 maxOcc 1
Comment: [InternationalAddressDetailsGroup] does not appear in the instance document. This choice is for addresses that do not have a US or Canadian postal code.				
StateProvince	Optional	The literal name of the state, province or territory of a postal address of the source of this document. Use for addresses outside US or Canada.	Recommended Refer to common postal practices of the source country	minOcc 0 maxOcc 1 minLength 2 maxLength 30
Comment: For an internet resource of states or other geographical subdivisions in countries other than the US and Canada, you might choose to refer to the website of the Universal Postal Union at http://www.upu.int				
PostalCode	Optional	The postal code portion of the Address.	Recommended Refer to common postal practices of the source country	minOcc 0 maxOcc 1 minLength 1 maxLength 17
Comment: For an internet resource of states or other geographical subdivisions in countries other than the US and Canada, you might choose to refer to the website of the Universal Postal Union at http://www.upu.int				
CountryCode	Required	Code indicating Country. Use ISO 3166-1 alpha-2 standard.	Required for international addresses	minOcc 1 maxOcc 1 Enumerations: See Appendix B1 or B2
EffectiveDate	Optional	The date on which the address became (or will become) effective	Optional	minOcc 0 maxOcc 1 Date format: CCYY-MM-DD
ExpirationDate	Optional	The date on which the address will (or did) expire	Optional	minOcc 0 maxOcc 1 Date format: CCYY-MM-DD
AttentionLine	Optional	The individual or office name within the postal address where inquiries should be directed.	Optional	minOcc 0 maxOcc ∞ minLength 1 maxLength 45
NoteMessage	Optional Repeatable	Additional information about the addresses of the applicant	Not recommended	minOcc 0 maxOcc ∞ minLength 1 maxLength 80

PESC XML Application for Admission Implementation Guide Version 1.3.0

Applicant.Person.Contacts.BillingAddress (Continued)

Code illustration 1 (Domestic Address):

```
<BillingAddress>  
  <AddressLine>1715 W Cesar Chavez</AddressLine>  
  <City>Austin</City>  
  <StateProvinceCode>TX</StateProvinceCode>  
  <PostalCode>78703</PostalCode>  
  <EffectiveDate>2008-08-01<EffectiveDate>  
  <ExpirationDate/>  
  <AttentionLine>Mr. Moneybags</AttentionLine>  
  <NoteMessage/>  
</BillingAddress>
```

Code illustration 2 (International Address):

```
<BillingAddress>  
  <AddressLine>Altova Corporation</AddressLine>  
  <AddressLine>Rudolfsplatz 13a/9</AddressLine>  
  <City>Wien</City>  
  <StateProvince/>  
  <PostalCode>A-1010</PostalCode>  
  <CountryCode>AT</CountryCode>  
  <EffectiveDate>2008-08-01<EffectiveDate>  
  <ExpirationDate/>  
  <AttentionLine>Mr. Moneybags</AttentionLine>  
  <NoteMessage/>  
</BillingAddress>
```

PESC XML Application for Admission Implementation Guide Version 1.3.0

Applicant.Person.Contacts.CampusAddress

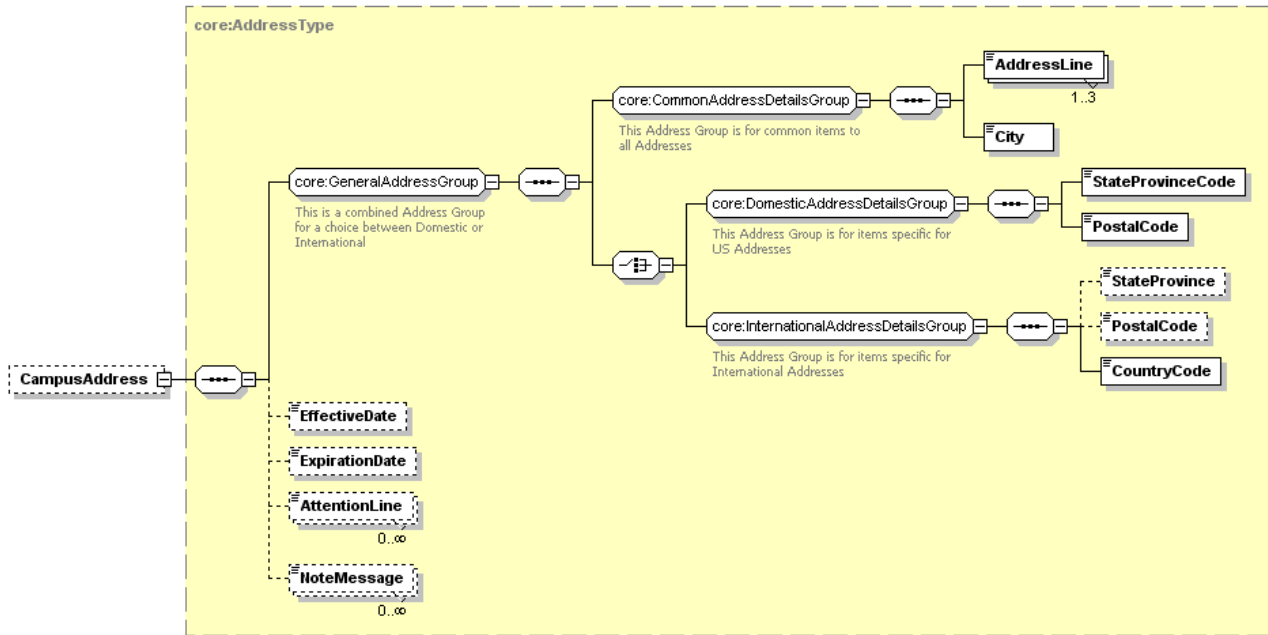

Tag Name	Schema Use	Description	Recommended Use	Format
<i>GeneralAddressGroup</i>	Required	This Address Group is for items common to all Addresses	Required	minOcc 1 maxOcc 1
Comment: [<i>GeneralAddressGroup</i>] does not appear as such in the instance document. It requires the use of <i>CommonAddressDetailsGroup</i> and the choice of one of either <i>DomesticAddressDetailsGroup</i> or <i>InternationalAddressDetailsGroup</i> .				
<i>CommonAddressDetailsGroup</i>	Required	This Address Group is for items common to all Addresses	Required	minOcc 1 maxOcc 1
Comment: [<i>CommonAddressDetailsGroup</i>] does not appear in the instance document. It is required and must be paired with one of either <i>DomesticAddressDetailsGroup</i> or <i>InternationalAddressDetailsGroup</i> .				
AddressLine	Required Repeatable	Local delivery information such as street, building number, PO box, or apartment portion of a postal address of the applicant	Required	minOcc 1 maxOcc 3 minLength 1 maxLength 40
City	Required	The city portion of the Address of the applicant	Required	minOcc 1 maxOcc 1 minLength 2 maxLength 30
<i>DomesticAddressDetailsGroup</i>	Required choice	This Address Group is for items specific for US and Canadian Addresses	Required for domestic addresses	minOcc 1 maxOcc 1
Comment: [<i>DomesticAddressDetailsGroup</i>] does not appear in the instance document. If the complex data element address has a United States or Canadian Postal Code and a US State or Canadian Province Code, then this must be the required choice.				
StateProvinceCode	Required	Code for US states, etc., and Canadian provinces.	Required for domestic addresses	minOcc 1 maxOcc 1 Enumeration: See Appendix A

PESC XML Application for Admission Implementation Guide

Version 1.3.0

Tag Name	Schema Use	Description	Recommended Use	Format
PostalCode	Required	The postal code portion of the Address.	Required for domestic addresses	minOcc 1 maxOcc 1 minLength 1 maxLength 17
<i>InternationalAddressDetailsGroup</i>	Required choice	This Address Group is for items specific for International Addresses	Required for international addresses	minOcc 1 maxOcc 1
Comment: [InternationalAddressDetailsGroup] does not appear in the instance document. This choice is for addresses that do not have a US or Canadian postal code.				
StateProvince	Optional	The literal name of the state, province or territory of a postal address of the source of this document. Use for addresses outside US or Canada.	Recommended Refer to common postal practices of the source country	minOcc 0 maxOcc 1 minLength 2 maxLength 30
Comment: For an internet resource of states or other geographical subdivisions in countries other than the US and Canada, you might choose to refer to the website of the Universal Postal Union at http://www.upu.int				
PostalCode	Optional	The postal code portion of the Address.	Recommended Refer to common postal practices of the source country	minOcc 0 maxOcc 1 minLength 1 maxLength 17
Comment: For an internet resource of states or other geographical subdivisions in countries other than the US and Canada, you might choose to refer to the website of the Universal Postal Union at http://www.upu.int				
CountryCode	Required	Code indicating Country. Use ISO 3166-1 alpha-2 standard.	Required for international addresses	minOcc 1 maxOcc 1 Enumerations: See Appendix B1 or B2
EffectiveDate	Optional	The date on which the address became (or will become) effective	Optional	minOcc 0 maxOcc 1 Date format: CCYY-MM-DD
ExpirationDate	Optional	The date on which the address will (or did) expire	Optional	minOcc 0 maxOcc 1 Date format: CCYY-MM-DD
AttentionLine	Optional	The individual or office name within the postal address where inquiries should be directed.	Optional	minOcc 0 maxOcc ∞ minLength 1 maxLength 45
NoteMessage	Optional Repeatable	Additional information about the addresses of the applicant	Not recommended	minOcc 0 maxOcc ∞ minLength 1 maxLength 80

PESC XML Application for Admission Implementation Guide Version 1.3.0

Applicant.Person.Contacts.CampusAddress (Continued)

Code illustration 1 (Domestic Address):

```
<CampusAddress>  
  <AddressLine>1715 W Cesar Chavez</AddressLine>  
  <City>Austin</City>  
  <StateProvinceCode>TX</StateProvinceCode>  
  <PostalCode>78703</PostalCode>  
  <EffectiveDate>2008-09-01</EffectiveDate>  
  <ExpirationDate/>  
  <AttentionLine/>  
  <NoteMessage/>  
</CampusAddress>
```

Code illustration 2 (International Address):

```
<CampusAddress>  
  <AddressLine>Altova Corporation</AddressLine>  
  <AddressLine>Rudolfsplatz 13a/9</AddressLine>  
  <City>Wien</City>  
  <StateProvince/>  
  <PostalCode>A-1010</PostalCode>  
  <CountryCode>AT</CountryCode>  
  <EffectiveDate>2008-09-01</EffectiveDate>  
  <ExpirationDate/>  
  <AttentionLine/>  
  <NoteMessage/>  
</CampusAddress>
```

PESC XML Application for Admission Implementation Guide Version 1.3.0

Applicant.Person.Contacts.EmergencyAddress

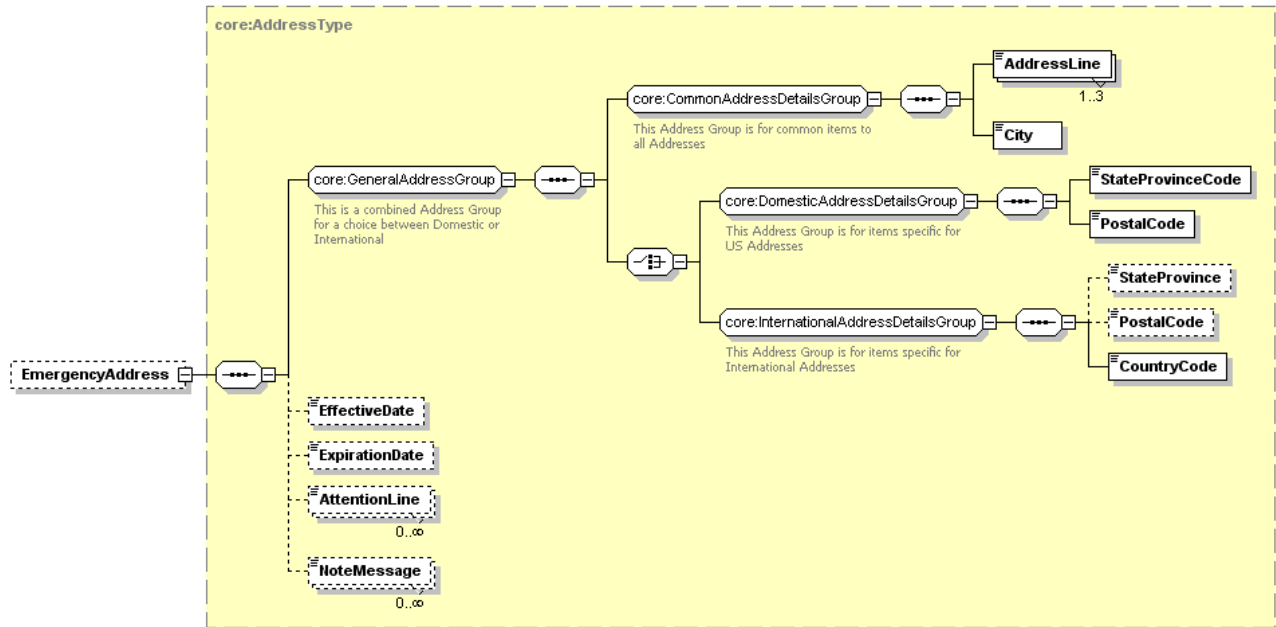

Tag Name	Schema Use	Description	Recommended Use	Format
<i>GeneralAddressGroup</i>	Required	This Address Group is for items common to all Addresses	Required	minOcc 1 maxOcc 1
Comment: [<i>GeneralAddressGroup</i>] does not appear as such in the instance document. It requires the use of <i>CommonAddressDetailsGroup</i> and the choice of either <i>DomesticAddressDetailsGroup</i> or <i>InternationalAddressDetailsGroup</i> .				
<i>CommonAddressDetailsGroup</i>	Required	This Address Group is for items common to all Addresses	Required	minOcc 1 maxOcc 1
Comment: [<i>CommonAddressDetailsGroup</i>] does not appear in the instance document. It is required and must be paired with one of either <i>DomesticAddressDetailsGroup</i> or <i>InternationalAddressDetailsGroup</i> .				
AddressLine	Required Repeatable	Local delivery information such as street, building number, PO box, or apartment portion of a postal address of the applicant	Required	minOcc 1 maxOcc 3 minLength 1 maxLength 40
City	Required	The city portion of the Address of the applicant	Required	minOcc 1 maxOcc 1 minLength 2 maxLength 30
<i>DomesticAddressDetailsGroup</i>	Required choice	This Address Group is for items specific for US and Canadian Addresses	Required for domestic addresses	minOcc 1 maxOcc 1
Comment: [<i>DomesticAddressDetailsGroup</i>] does not appear in the instance document. If the complex data element address has a United States or Canadian Postal Code and a US State or Canadian Province Code, then this must be the required choice.				
StateProvinceCode	Required	Code for US states, etc., and Canadian provinces.	Required for domestic addresses	minOcc 1 maxOcc 1 Enumeration: See Appendix A

PESC XML Application for Admission Implementation Guide

Version 1.3.0

Tag Name	Schema Use	Description	Recommended Use	Format
PostalCode	Required	The postal code portion of the Address.	Required for domestic addresses	minOcc 1 maxOcc 1 minLength 1 maxLength 17
<i>InternationalAddressDetailsGroup</i>	Required choice	This Address Group is for items specific for International Addresses	Required for international addresses	minOcc 1 maxOcc 1
Comment: [InternationalAddressDetailsGroup] does not appear in the instance document. This choice is for addresses that do not have a US or Canadian postal code.				
StateProvince	Optional	The literal name of the state, province or territory of a postal address of the source of this document. Use for addresses outside US or Canada.	Recommended Refer to common postal practices of the source country	minOcc 0 maxOcc 1 minLength 2 maxLength 30
Comment: For an internet resource of states or other geographical subdivisions in countries other than the US and Canada, you might choose to refer to the website of the Universal Postal Union at http://www.upu.int				
PostalCode	Optional	The postal code portion of the Address.	Recommended Refer to common postal practices of the source country	minOcc 0 maxOcc 1 minLength 1 maxLength 17
Comment: For an internet resource of states or other geographical subdivisions in countries other than the US and Canada, you might choose to refer to the website of the Universal Postal Union at http://www.upu.int				
CountryCode	Required	Code indicating Country. Use ISO 3166-1 alpha-2 standard.	Required for international addresses	minOcc 1 maxOcc 1 Enumerations: See Appendix B1 or B2
EffectiveDate	Optional	The date on which the address became (or will become) effective	Optional	minOcc 0 maxOcc 1 Date format: CCYY-MM-DD
ExpirationDate	Optional	The date on which the address will (or did) expire	Optional	minOcc 0 maxOcc 1 Date format: CCYY-MM-DD
AttentionLine	Optional	The individual or office name within the postal address where inquiries should be directed.	Optional	minOcc 0 maxOcc ∞ minLength 1 maxLength 45
NoteMessage	Optional Repeatable	Additional information about the addresses of the applicant	Not recommended	minOcc 0 maxOcc ∞ minLength 1 maxLength 80

PESC XML Application for Admission Implementation Guide Version 1.3.0

Applicant.Person.Contacts.EmergencyAddress (Continued)

Code illustration 1 (Domestic Address):

```
<EmergencyAddress>  
  <AddressLine>1715 W Cesar Chavez</AddressLine>  
  <City>Austin</City>  
  <StateProvinceCode>TX</StateProvinceCode>  
  <PostalCode>78703</PostalCode>  
  <EffectiveDate/>  
  <ExpirationDate/>  
  <AttentionLine/>  
  <NoteMessage/>  
</EmergencyAddress>
```

Code illustration 2 (International Address):

```
<EmergencyAddress>  
  <AddressLine>Altova Corporation</AddressLine>  
  <AddressLine>Rudolfplatz 13a/9</AddressLine>  
  <City>Wien</City>  
  <StateProvince/>  
  <PostalCode>A-1010</PostalCode>  
  <CountryCode>AT</CountryCode>  
  <EffectiveDate/>  
  <ExpirationDate/>  
  <AttentionLine/>  
  <NoteMessage/>  
</EmergencyAddress>
```

PESC XML Application for Admission Implementation Guide Version 1.3.0

Applicant.Person.Contacts.TemporaryAddress

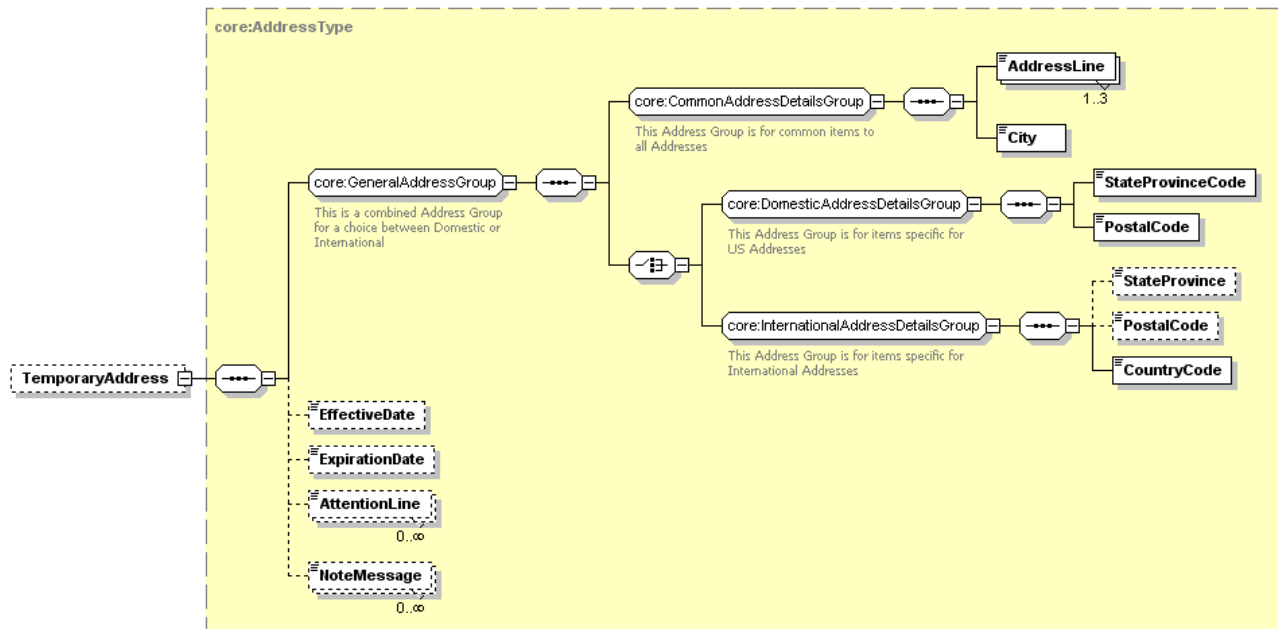

Tag Name	Schema Use	Description	Recommended Use	Format
<i>GeneralAddressGroup</i>	Required	This Address Group is for items common to all Addresses	Required	minOcc 1 maxOcc 1
Comment: [<i>GeneralAddressGroup</i>] does not appear as such in the instance document. It requires the use of <i>CommonAddressDetailsGroup</i> and the choice of one of either <i>DomesticAddressDetailsGroup</i> or <i>InternationalAddressDetailsGroup</i> .				
<i>CommonAddressDetailsGroup</i>	Required	This Address Group is for items common to all Addresses	Required	minOcc 1 maxOcc 1
Comment: [<i>CommonAddressDetailsGroup</i>] does not appear in the instance document. It is required and must be paired with one of either <i>DomesticAddressDetailsGroup</i> or <i>InternationalAddressDetailsGroup</i> .				
AddressLine	Required Repeatable	Local delivery information such as street, building number, PO box, or apartment portion of a postal address of the applicant	Required	minOcc 1 maxOcc 3 minLength 1 maxLength 40
City	Required	The city portion of the Address of the applicant	Required	minOcc 1 maxOcc 1 minLength 2 maxLength 30
<i>DomesticAddressDetails Group</i>	Required choice	This Address Group is for items specific for US and Canadian Addresses	Required for domestic addresses	minOcc 1 maxOcc 1
Comment: [<i>DomesticAddressDetailsGroup</i>] does not appear in the instance document. If the complex data element address has a United States or Canadian Postal Code and a US State or Canadian Province Code, then this must be the required choice.				
StateProvinceCode	Required	Code for US states, etc., and Canadian provinces.	Required for domestic addresses	minOcc 1 maxOcc 1 Enumeration: See Appendix A

PESC XML Application for Admission Implementation Guide

Version 1.3.0

Tag Name	Schema Use	Description	Recommended Use	Format
PostalCode	Required	The postal code portion of the Address.	Required for domestic addresses	minOcc 1 maxOcc 1 minLength 1 maxLength 17
<i>InternationalAddressDetailsGroup</i>	Required choice	This Address Group is for items specific for International Addresses	Required for international addresses	minOcc 1 maxOcc 1
Comment: [InternationalAddressDetailsGroup] does not appear in the instance document. This choice is for addresses that do not have a US or Canadian postal code.				
StateProvince	Optional	The literal name of the state, province or territory of a postal address of the source of this document. Use for addresses outside US or Canada.	Recommended Refer to common postal practices of the source country	minOcc 0 maxOcc 1 minLength 2 maxLength 30
Comment: For an internet resource of states or other geographical subdivisions in countries other than the US and Canada, you might choose to refer to the website of the Universal Postal Union at http://www.upu.int				
PostalCode	Optional	The postal code portion of the Address.	Recommended Refer to common postal practices of the source country	minOcc 0 maxOcc 1 minLength 1 maxLength 17
Comment: For an internet resource of states or other geographical subdivisions in countries other than the US and Canada, you might choose to refer to the website of the Universal Postal Union at http://www.upu.int				
CountryCode	Required	Code indicating Country. Use ISO 3166-1 alpha-2 standard.	Required for international addresses	minOcc 1 maxOcc 1 Enumerations: See Appendix B1 or B2
EffectiveDate	Optional	The date on which the address became (or will become) effective	Recommended	minOcc 0 maxOcc 1 Date format: CCYY-MM-DD
ExpirationDate	Optional	The date on which the address will (or did) expire	Recommended	minOcc 0 maxOcc 1 Date format: CCYY-MM-DD
AttentionLine	Optional	The individual or office name within the postal address where inquiries should be directed.	Optional	minOcc 0 maxOcc ∞ minLength 1 maxLength 45
NoteMessage	Optional Repeatable	Additional information about the addresses of the applicant	Not recommended	minOcc 0 maxOcc ∞ minLength 1 maxLength 80

PESC XML Application for Admission Implementation Guide Version 1.3.0

Applicant.Person.Contacts.TemporaryAddress (Continued)

Code illustration 1 (Domestic Address):

```
<TemporaryAddress>  
  <AddressLine>1715 W Cesar Chavez</AddressLine>  
  <City>Austin</City>  
  <StateProvinceCode>TX</StateProvinceCode>  
  <PostalCode>78703</PostalCode>  
  <EffectiveDate>2008-08-12<EffectiveDate>  
  <ExpirationDate>2008-08-15<ExpirationDate>  
  <AttentionLine/>  
  <NoteMessage/>  
</TemporaryAddress>
```

Code illustration 2 (International Address):

```
<TemporaryAddress>  
  <AddressLine>Altova Corporation</AddressLine>  
  <AddressLine>Rudolfsplatz 13a/9</AddressLine>  
  <City>Wien</City>  
  <StateProvince/>  
  <PostalCode>A-1010</PostalCode>  
  <CountryCode>AT</CountryCode>  
  <EffectiveDate>2006-08-12<EffectiveDate>  
  <ExpirationDate>2007-08-15<ExpirationDate>  
  <AttentionLine/>  
  <NoteMessage/>  
</TemporaryAddress>
```

PESC XML Application for Admission Implementation Guide Version 1.3.0

Applicant.Person.Contacts.OtherAddress

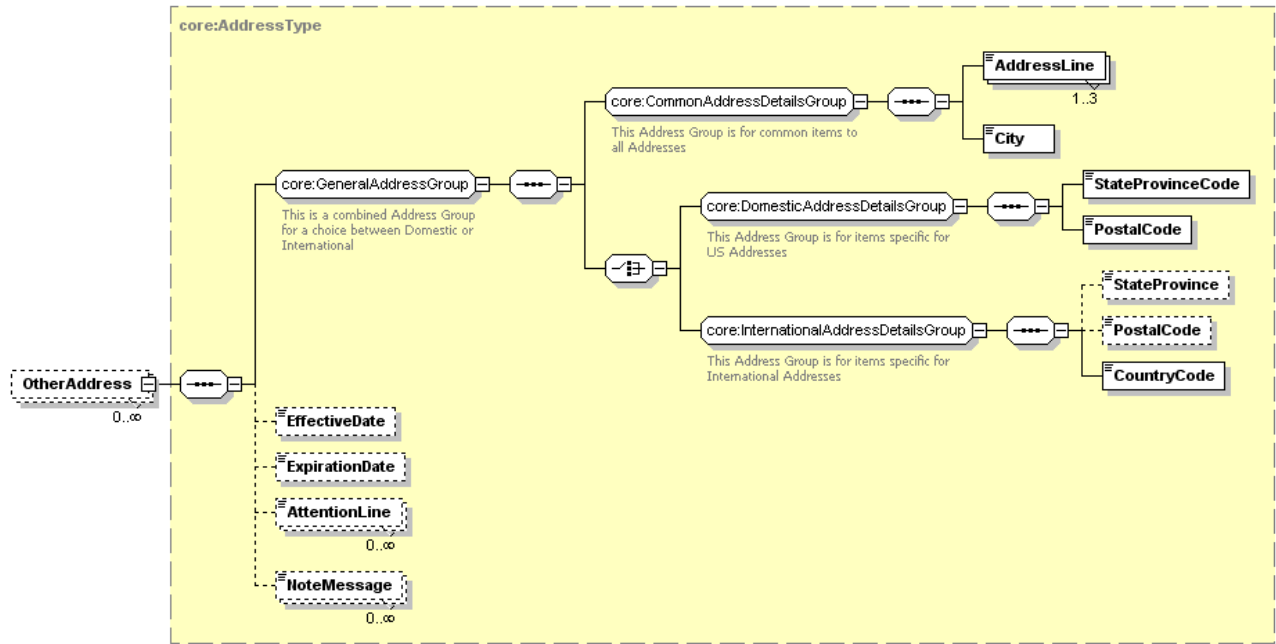

Tag Name	Schema Use	Description	Recommended Use	Format
<i>GeneralAddressGroup</i>	Required	This Address Group is for items common to all Addresses	Required	minOcc 1 maxOcc 1
Comment: [<i>GeneralAddressGroup</i>] does not appear as such in the instance document. It requires the use of <i>CommonAddressDetailsGroup</i> and the choice of one of either <i>DomesticAddressDetailsGroup</i> or <i>InternationalAddressDetailsGroup</i> .				
<i>CommonAddressDetailsGroup</i>	Required	This Address Group is for items common to all Addresses	Required	minOcc 1 maxOcc 1
Comment: [<i>CommonAddressDetailsGroup</i>] does not appear in the instance document. It is required and must be paired with one of either <i>DomesticAddressDetailsGroup</i> or <i>InternationalAddressDetailsGroup</i> .				
AddressLine	Required Repeatable	Local delivery information such as street, building number, PO box, or apartment portion of a postal address of the applicant	Required	minOcc 1 maxOcc 3 minLength 1 maxLength 40
City	Required	The city portion of the Address of the applicant	Required	minOcc 1 maxOcc 1 minLength 2 maxLength 30
<i>DomesticAddressDetailsGroup</i>	Required choice	This Address Group is for items specific for US and Canadian Addresses	Required for domestic addresses	minOcc 1 maxOcc 1
Comment: [<i>DomesticAddressDetailsGroup</i>] does not appear in the instance document. If the complex data element address has a United States or Canadian Postal Code and a US State or Canadian Province Code, then this must be the required choice.				
StateProvinceCode	Required	Code for US states, etc., and Canadian provinces.	Required for domestic addresses	minOcc 1 maxOcc 1 Enumeration: See Appendix A

PESC XML Application for Admission Implementation Guide

Version 1.3.0

Tag Name	Schema Use	Description	Recommended Use	Format
PostalCode	Required	The postal code portion of the Address.	Required for domestic addresses	minOcc 1 maxOcc 1 minLength 1 maxLength 17
<i>InternationalAddressDetailsGroup</i>	Required choice	This Address Group is for items specific for International Addresses	Required for international addresses	minOcc 1 maxOcc 1
Comment: [InternationalAddressDetailsGroup] does not appear in the instance document. This choice is for addresses that do not have a US or Canadian postal code.				
StateProvince	Optional	The literal name of the state, province or territory of a postal address of the source of this document. Use for addresses outside US or Canada.	Recommended Refer to common postal practices of the source country	minOcc 0 maxOcc 1 minLength 2 maxLength 30
Comment: For an internet resource of states or other geographical subdivisions in countries other than the US and Canada, you might choose to refer to the website of the Universal Postal Union at http://www.upu.int				
PostalCode	Optional	The postal code portion of the Address.	Recommended Refer to common postal practices of the source country	minOcc 0 maxOcc 1 minLength 1 maxLength 17
Comment: For an internet resource of states or other geographical subdivisions in countries other than the US and Canada, you might choose to refer to the website of the Universal Postal Union at http://www.upu.int				
CountryCode	Required	Code indicating Country. Use ISO 3166-1 alpha-2 standard.	Required for international addresses	minOcc 1 maxOcc 1 Enumerations: See Appendix B1 or B2
EffectiveDate	Optional	The date on which the address became (or will become) effective	Recommended	minOcc 0 maxOcc 1 Date format: CCYY-MM-DD
ExpirationDate	Optional	The date on which the address will (or did) expire	Recommended	minOcc 0 maxOcc 1 Date format: CCYY-MM-DD
AttentionLine	Optional	The individual or office name within the postal address where inquiries should be directed.	Optional	minOcc 0 maxOcc ∞ minLength 1 maxLength 45
NoteMessage	Optional Repeatable	Additional information about the other addresses of the applicant	Optional	minOcc 0 maxOcc ∞ minLength 1 maxLength 80
Comment: If you choose to include an occurrence of OtherAddress, it is suggested that you also include a NoteMessage to describe the type of OtherAddress being included.				

PESC XML Application for Admission Implementation Guide Version 1.3.0

Applicant.Person.Contacts.OtherAddress (Continued)

Code illustration 1 (Domestic Address):

```
<OtherAddress>  
  <AddressLine>1715 W Cesar Chavez</AddressLine>  
  <City>Austin</City>  
  <StateProvinceCode>TX</StateProvinceCode>  
  <PostalCode>78703</PostalCode>  
  <EffectiveDate>2008-08-12</EffectiveDate>  
  <ExpirationDate>2009-08-15</ExpirationDate>  
  <AttentionLine/>  
  <NoteMessage/>  
</OtherAddress>
```

Code illustration 2 (International Address):

```
<OtherAddress>  
  <AddressLine>Altova Corporation</AddressLine>  
  <AddressLine>Rudolfsplatz 13a/9</AddressLine>  
  <City>Wien</City>  
  <StateProvince/>  
  <PostalCode>A-1010</PostalCode>  
  <CountryCode>AT</CountryCode>  
  <EffectiveDate>2008-08-12</EffectiveDate>  
  <ExpirationDate>2009-08-15</ExpirationDate>  
  <AttentionLine/>  
  <NoteMessage/>  
</OtherAddress>
```

PESC XML Application for Admission Implementation Guide Version 1.3.0

Applicant.Person.Contacts.PermanentPhone

Note: Although the complex data element *PermanentPhone* is an optional data element, if you choose to send the *PermanentPhone* of the Applicant, then you must send the data element *PhoneNumber*.

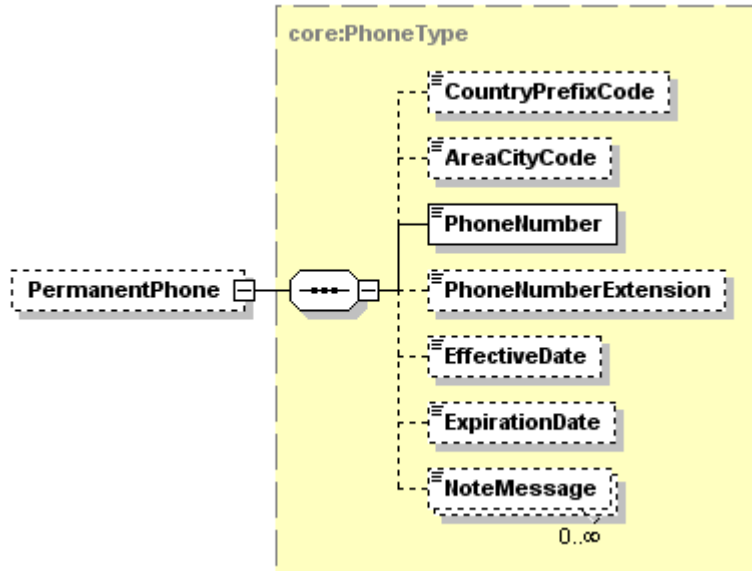

Tag Name	Schema Use	Description	Recommended Use	Format
CountryPrefixCode	Optional	International dialing code.	Optional	minOcc 0 maxOcc 1 minLength 1 maxLength 3
AreaCityCode	Optional	Regional dialing code.	Recommended	minOcc 0 maxOcc 1 minLength 1 maxLength 5
Comment: For phone numbers in the United States and Canada, this is the normal three digit area code.				
PhoneNumber	Required	Telephone number.	Required	minOcc 1 maxOcc 1 minLength 1 maxLength 11
PhoneNumberExtension	Optional	The extended telephone addressing information used in addition to phone number such as a PBX extension, a pager PIN, or FAX sub-address.	Optional	minOcc 0 maxOcc 1 minLength 1 maxLength 5
EffectiveDate	Optional	The date on which the permanent phone became (or will become) effective	Recommended	minOcc 0 maxOcc 1 Date format: CCYY-MM-DD
ExpirationDate	Optional	The date on which the permanent phone will (or did) expire	Recommended	minOcc 0 maxOcc 1 Date format: CCYY-MM-DD
NoteMessage	Optional Repeatable	Additional information about the other addresses of the applicant	Optional	minOcc 0 maxOcc ∞ minLength 1 maxLength 80

PESC XML Application for Admission Implementation Guide Version 1.3.0

Applicant.Person.Contacts.PermanentPhone (Continued)

Code illustration:

```
<PermanentPhone>  
  <CountryPrefixCode/>  
  <AreaCityCode>512</AreaCityCode>  
  <PhoneNumber>8888888</PhoneNumber>  
  <PhoneNumberExtension/>  
  <EffectiveDate>2006-04-06</EffectiveDate>  
  <ExpirationDate/>  
  <NoteMessage/>  
</PermanentPhone>
```

PESC XML Application for Admission Implementation Guide Version 1.3.0

Applicant.Person.Contacts.BusinessPhone

Note: Although the complex data element *BusinessPhone* is an optional data element, if you choose to send the *BusinessPhone* of the Applicant, then you must send the data element *PhoneNumber*.

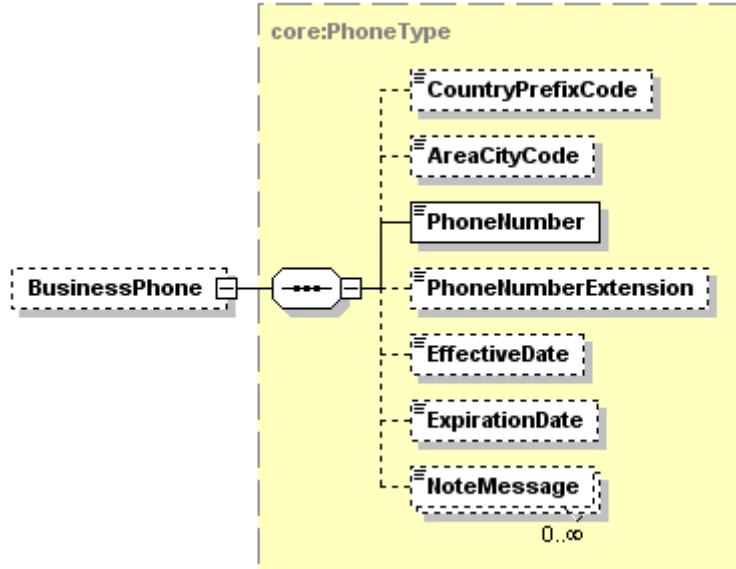

Tag Name	Schema Use	Description	Recommended Use	Format
CountryPrefixCode	Optional	International dialing code.	Optional	minOcc 0 maxOcc 1 minLength 1 maxLength 3
AreaCityCode	Optional	Regional dialing code.	Recommended	minOcc 0 maxOcc 1 minLength 1 maxLength 5
Comment: For phone numbers in the United States and Canada, this is the normal three digit area code.				
PhoneNumber	Required	Telephone number.	Required	minOcc 1 maxOcc 1 minLength 1 maxLength 11
PhoneNumberExtension	Optional	The extended telephone addressing information used in addition to phone number such as a PBX extension, a pager PIN, or FAX sub-address.	Optional	minOcc 0 maxOcc 1 minLength 1 maxLength 5
EffectiveDate	Optional	The date on which the business phone became (or will become) effective	Recommended	minOcc 0 maxOcc 1 Date format: CCYY-MM-DD
ExpirationDate	Optional	The date on which the business phone will (or did) expire	Recommended	minOcc 0 maxOcc 1 Date format: CCYY-MM-DD
NoteMessage	Optional Repeatable	Additional information about the business phone of the applicant	Optional	minOcc 0 maxOcc ∞ minLength 1 maxLength 80

PESC XML Application for Admission Implementation Guide Version 1.3.0

Applicant.Person.Contacts.BusinessPhone (Continued)

Code illustration:

```
<BusinessPhone>  
  <CountryPrefixCode/>  
  <AreaCityCode>512</AreaCityCode>  
  <PhoneNumber>8888888</PhoneNumber>  
  <PhoneNumberExtension/>  
  <EffectiveDate>2006-04-06</EffectiveDate>  
  <ExpirationDate/>  
  <NoteMessage/>  
</BusinessPhone>
```

PESC XML Application for Admission Implementation Guide Version 1.3.0

Applicant.Person.Contacts.CampusPhone

Note: Although the complex data element Campus Phone is an optional data element, if you choose to send the CampusPhone of the Applicant, then you must send the data element PhoneNumber.

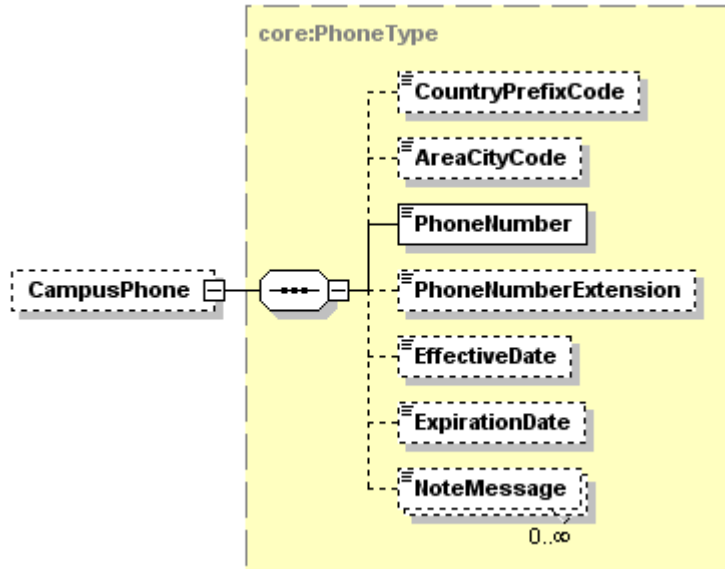

Tag Name	Schema Use	Description	Recommended Use	Format
CountryPrefixCode	Optional	International dialing code.	Optional	minOcc 0 maxOcc 1 minLength 1 maxLength 3
AreaCityCode	Optional	Regional dialing code.	Recommended	minOcc 0 maxOcc 1 minLength 1 maxLength 5
Comment: For phone numbers in the United States and Canada, this is the normal three digit area code.				
PhoneNumber	Required	Telephone number.	Required	minOcc 1 maxOcc 1 minLength 1 maxLength 11
PhoneNumberExtension	Optional	The extended telephone addressing information used in addition to phone number such as a PBX extension, a pager PIN, or FAX sub-address.	Optional	minOcc 0 maxOcc 1 minLength 1 maxLength 5
EffectiveDate	Optional	The date on which the campus phone became (or will become) effective	Recommended	minOcc 0 maxOcc 1 Date format: CCYY-MM-DD
ExpirationDate	Optional	The date on which the campus phone will (or did) expire	Recommended	minOcc 0 maxOcc 1 Date format: CCYY-MM-DD
NoteMessage	Optional Repeatable	Additional information about the campus phone of the applicant	Optional	minOcc 0 maxOcc ∞ minLength 1 maxLength 80

PESC XML Application for Admission Implementation Guide Version 1.3.0

Applicant.Person.Contacts.CampusPhone (Continued)

Code illustration:

```
<CampusPhone>  
  <CountryPrefixCode/>  
  <AreaCityCode>512</AreaCityCode>  
  <PhoneNumber>8888888</PhoneNumber>  
  <PhoneNumberExtension/>  
  <EffectiveDate>2006-04-06</EffectiveDate>  
  <ExpirationDate/>  
  <NoteMessage/>  
</CampusPhone>
```

PESC XML Application for Admission Implementation Guide Version 1.3.0

Applicant.Person.Contacts.EmergencyPhone

Note: Although the complex data element Emergency Phone is an optional data element, if you choose to send the EmergencyPhone of the Applicant, then you must send the data element PhoneNumber.

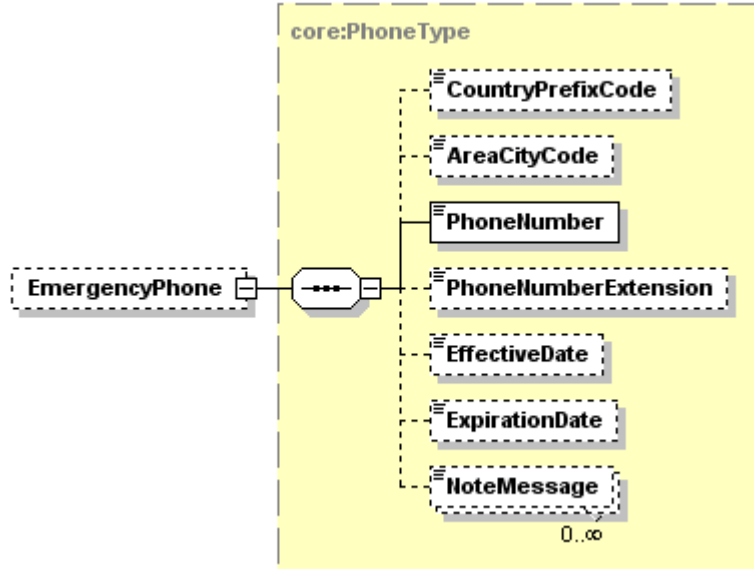

Tag Name	Schema Use	Description	Recommended Use	Format
CountryPrefixCode	Optional	International dialing code.	Optional	minOcc 0 maxOcc 1 minLength 1 maxLength 3
AreaCityCode	Optional	Regional dialing code.	Recommended	minOcc 0 maxOcc 1 minLength 1 maxLength 5
Comment: For phone numbers in the United States and Canada, this is the normal three digit area code.				
PhoneNumber	Required	Telephone number.	Required	minOcc 1 maxOcc 1 minLength 1 maxLength 11
PhoneNumberExtension	Optional	The extended telephone addressing information used in addition to phone number such as a PBX extension, a pager PIN, or FAX sub-address.	Optional	minOcc 0 maxOcc 1 minLength 1 maxLength 5
EffectiveDate	Optional	The date on which the emergency phone became (or will become) effective	Recommended	minOcc 0 maxOcc 1 Date format: CCYY-MM-DD
ExpirationDate	Optional	The date on which the emergency phone will (or did) expire	Recommended	minOcc 0 maxOcc 1 Date format: CCYY-MM-DD
NoteMessage	Optional Repeatable	Additional information about the emergency phone of the applicant	Optional	minOcc 0 maxOcc ∞ minLength 1 maxLength 80

PESC XML Application for Admission Implementation Guide Version 1.3.0

Applicant.Person.Contacts.EmergencyPhone (Continued)

Code illustration:

```
<EmergencyPhone>  
  <CountryPrefixCode/>  
  <AreaCityCode>512</AreaCityCode>  
  <PhoneNumber>8888888</PhoneNumber>  
  <PhoneNumberExtension/>  
  <EffectiveDate>2006-04-06</EffectiveDate>  
  <ExpirationDate/>  
  <NoteMessage/>  
</EmergencyPhone>
```

PESC XML Application for Admission Implementation Guide Version 1.3.0

Applicant.Person.Contacts.DayPhone

Note: Although the complex data element DayPhone is an optional data element, if you choose to send the DayPhone of the Applicant, then you must send the data element PhoneNumber.

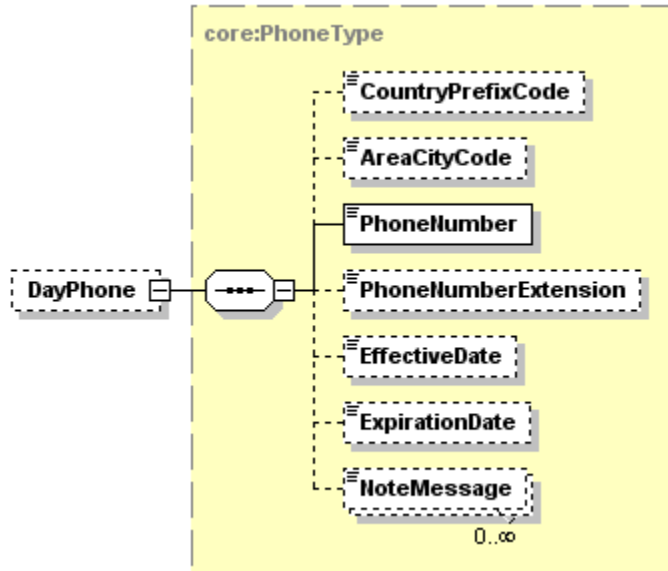

Tag Name	Schema Use	Description	Recommended Use	Format
CountryPrefixCode	Optional	International dialing code.	Optional	minOcc 0 maxOcc 1 minLength 1 maxLength 3
AreaCityCode	Optional	Regional dialing code.	Recommended	minOcc 0 maxOcc 1 minLength 1 maxLength 5
Comment: For phone numbers in the United States and Canada, this is the normal three digit area code.				
PhoneNumber	Required	Telephone number.	Required	minOcc 1 maxOcc 1 minLength 1 maxLength 11
PhoneNumberExtension	Optional	The extended telephone addressing information used in addition to phone number such as a PBX extension, a pager PIN, or FAX sub-address.	Optional	minOcc 0 maxOcc 1 minLength 1 maxLength 5
EffectiveDate	Optional	The date on which the day phone became (or will become) effective	Recommended	minOcc 0 maxOcc 1 Date format: CCYY-MM-DD
ExpirationDate	Optional	The date on which the day phone will (or did) expire	Recommended	minOcc 0 maxOcc 1 Date format: CCYY-MM-DD
NoteMessage	Optional Repeatable	Additional information about the day phone of the applicant	Optional	minOcc 0 maxOcc ∞ minLength 1 maxLength 80

PESC XML Application for Admission Implementation Guide Version 1.3.0

Applicant.Person.Contacts.DayPhone (Continued)

Code illustration:

```
<DayPhone>  
  <CountryPrefixCode/>  
  <AreaCityCode>512</AreaCityCode>  
  <PhoneNumber>8888888</PhoneNumber>  
  <PhoneNumberExtension/>  
  <EffectiveDate>2006-04-06</EffectiveDate>  
  <ExpirationDate/>  
  <NoteMessage/>  
</DayPhone>
```

PESC XML Application for Admission Implementation Guide Version 1.3.0

Applicant.Person.Contacts.EveningPhone

Note: Although the complex data element *EveningPhone* is an optional data element, if you choose to send the *EveningPhone* of the Applicant, then you must send the data element *PhoneNumber*.

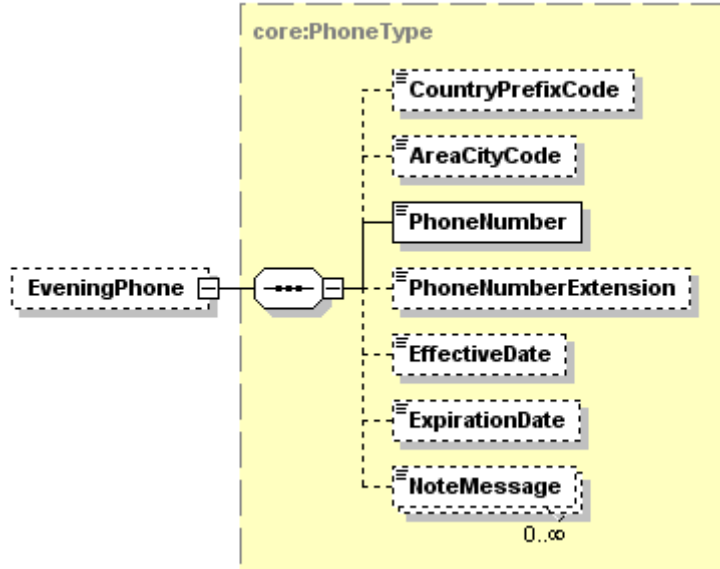

Tag Name	Schema Use	Description	Recommended Use	Format
CountryPrefixCode	Optional	International dialing code.	Optional	minOcc 0 maxOcc 1 minLength 1 maxLength 3
AreaCityCode	Optional	Regional dialing code.	Recommended	minOcc 0 maxOcc 1 minLength 1 maxLength 5
Comment: For phone numbers in the United States and Canada, this is the normal three digit area code.				
PhoneNumber	Required	Telephone number.	Required	minOcc 1 maxOcc 1 minLength 1 maxLength 11
PhoneNumberExtension	Optional	The extended telephone addressing information used in addition to phone number such as a PBX extension, a pager PIN, or FAX sub-address.	Optional	minOcc 0 maxOcc 1 minLength 1 maxLength 5
EffectiveDate	Optional	The date on which the evening phone became (or will become) effective	Recommended	minOcc 0 maxOcc 1 Date format: CCYY-MM-DD
ExpirationDate	Optional	The date on which the evening phone will (or did) expire	Recommended	minOcc 0 maxOcc 1 Date format: CCYY-MM-DD
NoteMessage	Optional Repeatable	Additional information about the evening phone of the applicant	Optional	minOcc 0 maxOcc ∞ minLength 1 maxLength 80

PESC XML Application for Admission Implementation Guide Version 1.3.0

Applicant.Person.Contacts.EveningPhone (Continued)

Code illustration:

```
<EveningPhone>  
  <CountryPrefixCode/>  
  <AreaCityCode>512</AreaCityCode>  
  <PhoneNumber>8888888</PhoneNumber>  
  <PhoneNumberExtension/>  
  <EffectiveDate>2006-04-06</EffectiveDate>  
  <ExpirationDate/>  
  <NoteMessage/>  
</EveningPhone>
```

PESC XML Application for Admission Implementation Guide Version 1.3.0

Applicant.Person.Contacts.FaxPhone

Note: Although the complex data element Fax Phone is an optional data element, if you choose to send the Fax Phone of the Applicant, then you must send the data element PhoneNumber.

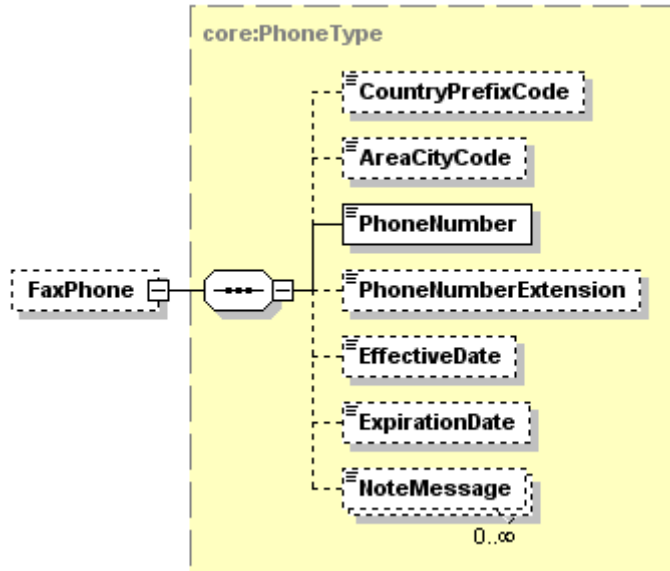

Tag Name	Schema Use	Description	Recommended Use	Format
CountryPrefixCode	Optional	International dialing code.	Optional	minOcc 0 maxOcc 1 minLength 1 maxLength 3
AreaCityCode	Optional	Regional dialing code.	Recommended	minOcc 0 maxOcc 1 minLength 1 maxLength 5
Comment: For phone numbers in the United States and Canada, this is the normal three digit area code.				
PhoneNumber	Required	Telephone number.	Required	minOcc 1 maxOcc 1 minLength 1 maxLength 11
PhoneNumberExtension	Optional	The extended telephone addressing information used in addition to phone number such as a PBX extension, a pager PIN, or FAX sub-address.	Optional	minOcc 0 maxOcc 1 minLength 1 maxLength 5
EffectiveDate	Optional	The date on which the fax phone became (or will become) effective	Recommended	minOcc 0 maxOcc 1 Date format: CCYY-MM-DD
ExpirationDate	Optional	The date on which the fax phone will (or did) expire	Recommended	minOcc 0 maxOcc 1 Date format: CCYY-MM-DD
NoteMessage	Optional Repeatable	Additional information about the fax phone of the applicant	Optional	minOcc 0 maxOcc ∞ minLength 1 maxLength 80

PESC XML Application for Admission Implementation Guide Version 1.3.0

Applicant.Person.Contacts.FaxPhone (Continued)

Code illustration:

```
<FaxPhone>  
  <CountryPrefixCode/>  
  <AreaCityCode>512</AreaCityCode>  
  <PhoneNumber>8888888</PhoneNumber>  
  <PhoneNumberExtension/>  
  <EffectiveDate>2006-04-06</EffectiveDate>  
  <ExpirationDate/>  
  <NoteMessage/>  
</FaxPhone>
```

PESC XML Application for Admission Implementation Guide Version 1.3.0

Applicant.Person.Contacts.MobilePhone

Note: Although the complex data element MobilePhone is an optional data element, if you choose to send a MobilePhone of the Applicant, then you must send the data element PhoneNumber.

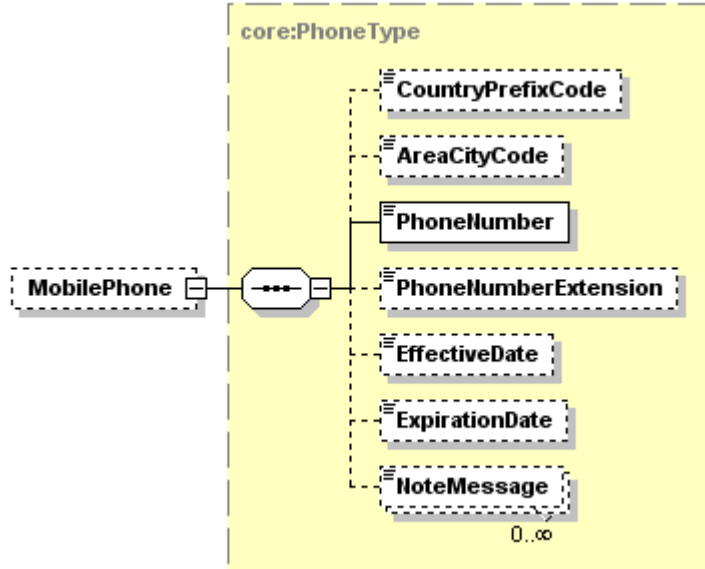

Tag Name	Schema Use	Description	Recommended Use	Format
CountryPrefixCode	Optional	International dialing code.	Optional	minOcc 0 maxOcc 1 minLength 1 maxLength 3
AreaCityCode	Optional	Regional dialing code.	Recommended	minOcc 0 maxOcc 1 minLength 1 maxLength 5
Comment: For phone numbers in the United States and Canada, this is the normal three digit area code.				
PhoneNumber	Required	Telephone number.	Required	minOcc 1 maxOcc 1 minLength 1 maxLength 11
PhoneNumberExtension	Optional	The extended telephone addressing information used in addition to phone number such as a PBX extension, a pager PIN, or FAX sub-address.	Optional	minOcc 0 maxOcc 1 minLength 1 maxLength 5
EffectiveDate	Optional	The date on which the mobile or cell phone became (or will become) effective	Recommended	minOcc 0 maxOcc 1 Date format: CCYY-MM-DD
ExpirationDate	Optional	The date on which the mobile or cell phone will (or did) expire	Recommended	minOcc 0 maxOcc 1 Date format: CCYY-MM-DD
NoteMessage	Optional Repeatable	Additional information about the mobile or cell phone of the applicant	Optional	minOcc 0 maxOcc ∞ minLength 1 maxLength 80

PESC XML Application for Admission Implementation Guide Version 1.3.0

Applicant.Person.Contacts.MobilePhone (Continued)

Code illustration:

```
<MobilePhone>  
  <CountryPrefixCode/>  
  <AreaCityCode>512</AreaCityCode>  
  <PhoneNumber>8888888</PhoneNumber>  
  <PhoneNumberExtension/>  
  <EffectiveDate>2006-04-06</EffectiveDate>  
  <ExpirationDate/>  
  <NoteMessage/>  
</MobilePhone>
```

PESC XML Application for Admission Implementation Guide Version 1.3.0

Applicant.Person.Contacts.PagerPhone

Note: Although the complex data element Pager Phone is an optional data element, if you choose to send the PagerPhone of the Applicant, then you must send the data element PhoneNumber.

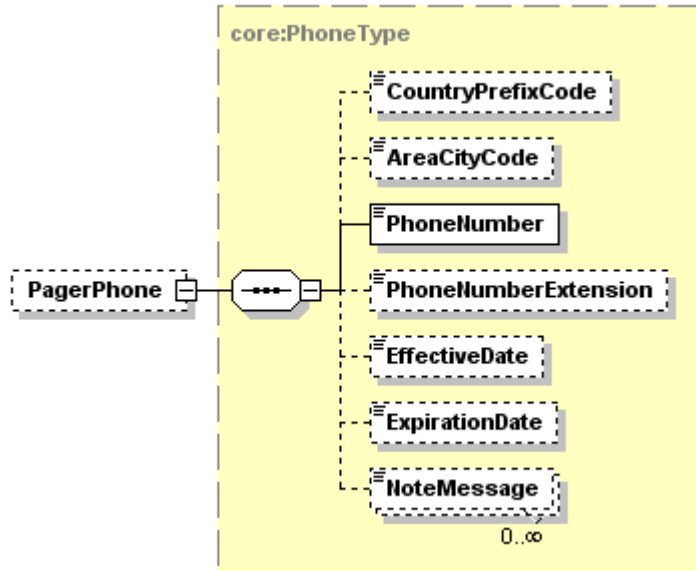

Tag Name	Schema Use	Description	Recommended Use	Format
CountryPrefixCode	Optional	International dialing code.	Optional	minOcc 0 maxOcc 1 minLength 1 maxLength 3
AreaCityCode	Optional	Regional dialing code.	Recommended	minOcc 0 maxOcc 1 minLength 1 maxLength 5
Comment: For phone numbers in the United States and Canada, this is the normal three digit area code.				
PhoneNumber	Required	Telephone number.	Required	minOcc 1 maxOcc 1 minLength 1 maxLength 11
PhoneNumberExtension	Optional	The extended telephone addressing information used in addition to phone number such as a PBX extension, a pager PIN, or FAX sub-address.	Optional	minOcc 0 maxOcc 1 minLength 1 maxLength 5
EffectiveDate	Optional	The date on which the pager became (or will become) effective	Recommended	minOcc 0 maxOcc 1 Date format: CCYY-MM-DD
ExpirationDate	Optional	The date on which the pager will (or did) expire	Recommended	minOcc 0 maxOcc 1 Date format: CCYY-MM-DD
NoteMessage	Optional Repeatable	Additional information about the pager of the applicant	Optional	minOcc 0 maxOcc ∞ minLength 1 maxLength 80

PESC XML Application for Admission Implementation Guide Version 1.3.0

Applicant.Person.Contacts.PagerPhone (Continued)

Code illustration:

```
<PagerPhone>  
  <CountryPrefixCode/>  
  <AreaCityCode>512</AreaCityCode>  
  <PhoneNumber>8888888</PhoneNumber>  
  <PhoneNumberExtension/>  
  <EffectiveDate>2006-04-06</EffectiveDate>  
  <ExpirationDate/>  
  <NoteMessage/>  
</PagerPhone>
```

PESC XML Application for Admission Implementation Guide Version 1.3.0

Applicant.Person.Contacts.TemporaryPhone

Note: Although the complex data element Temporary Phone is an optional data element, if you choose to send the TemporaryPhone of the Applicant, then you must send the data element PhoneNumber.

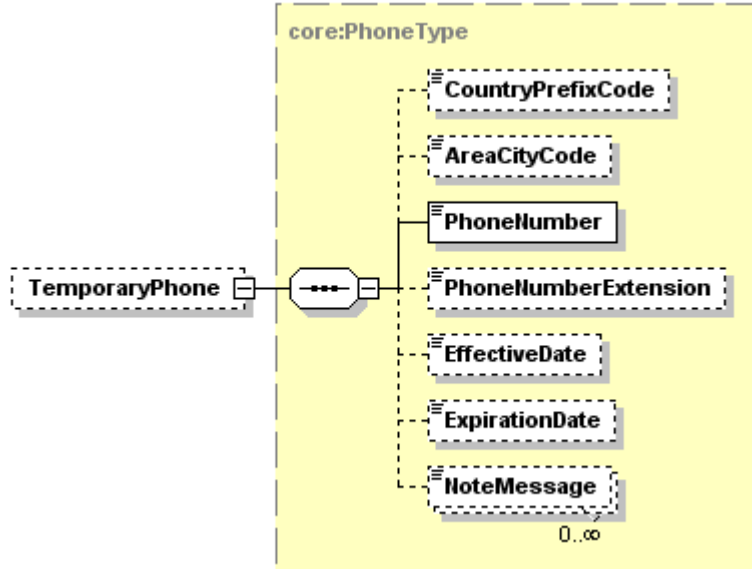

Tag Name	Schema Use	Description	Recommended Use	Format
CountryPrefixCode	Optional	International dialing code.	Optional	minOcc 0 maxOcc 1 minLength 1 maxLength 3
AreaCityCode	Optional	Regional dialing code.	Recommended	minOcc 0 maxOcc 1 minLength 1 maxLength 5
Comment: For phone numbers in the United States and Canada, this is the normal three digit area code.				
PhoneNumber	Required	Telephone number.	Required	minOcc 1 maxOcc 1 minLength 1 maxLength 11
PhoneNumberExtension	Optional	The extended telephone addressing information used in addition to phone number such as a PBX extension, a pager PIN, or FAX sub-address.	Optional	minOcc 0 maxOcc 1 minLength 1 maxLength 5
EffectiveDate	Optional	The date on which the temporary phone became (or will become) effective	Recommended	minOcc 0 maxOcc 1 Date format: CCYY-MM-DD
ExpirationDate	Optional	The date on which the temporary phone will (or did) expire	Recommended	minOcc 0 maxOcc 1 Date format: CCYY-MM-DD
NoteMessage	Optional Repeatable	Additional information about the temporary phone of the applicant	Not Recommended	minOcc 0 maxOcc ∞ minLength 1 maxLength 80

PESC XML Application for Admission Implementation Guide Version 1.3.0

Applicant.Person.Contacts.TemporaryPhone (Continued)

Code illustration:

```
<TemporaryPhone>  
  <CountryPrefixCode/>  
  <AreaCityCode>512</AreaCityCode>  
  <PhoneNumber>8888888</PhoneNumber>  
  <PhoneNumberExtension/>  
  <EffectiveDate>2007-10-20</EffectiveDate>  
  <ExpirationDate>2007-12-28<ExpirationDate>  
  <NoteMessage/>  
</TemporaryPhone>
```

PESC XML Application for Admission Implementation Guide Version 1.3.0

Applicant.Person.Contacts.OtherPhone

Note: Although the complex data element Other Phone is an optional data element, if you choose to send the Other Phone of the Applicant, then you must send the data element PhoneNumber.

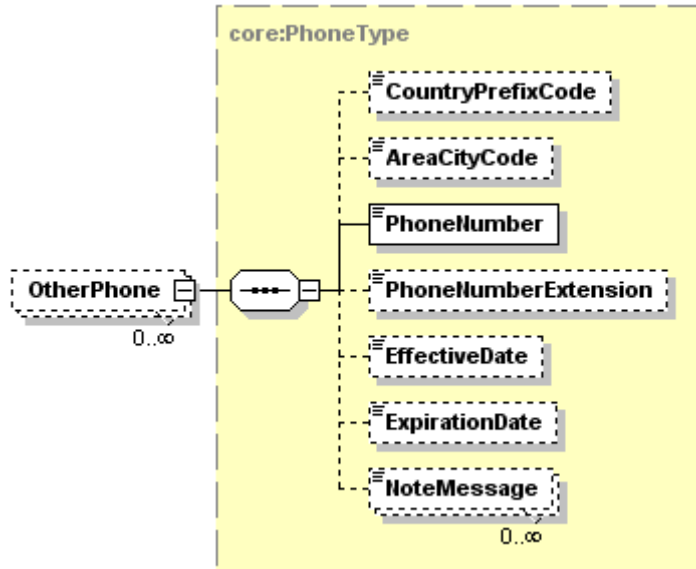

Tag Name	Schema Use	Description	Recommended Use	Format
CountryPrefixCode	Optional	International dialing code.	Optional	minOcc 0 maxOcc 1 minLength 1 maxLength 3
AreaCityCode	Optional	Regional dialing code.	Recommended	minOcc 0 maxOcc 1 minLength 1 maxLength 5
Comment: For phone numbers in the United States and Canada, this is the normal three digit area code.				
PhoneNumber	Required	Telephone number.	Required	minOcc 1 maxOcc 1 minLength 1 maxLength 11
PhoneNumberExtension	Optional	The extended telephone addressing information used in addition to phone number such as a PBX extension, a pager PIN, or FAX sub-address.	Optional	minOcc 0 maxOcc 1 minLength 1 maxLength 5
EffectiveDate	Optional	The date on which this other phone number becomes effective	Optional	minOcc 0 maxOcc 1 Date format CCYY-MM-DD
ExpirationDate	Optional	The date on which this temporary phone number expires	Optional	minOcc 0 maxOcc 1 Date format CCYY-MM-DD
NoteMessage	Optional Repeatable	Additional information about the temporary phone number	Optional	minOcc 0 maxOcc ∞ minLength 1 maxLength 80
Comment: If you do include OtherPhone in the instance document, it is suggested that you also include a NoteMessage to describe the type of this other phone.				

PESC XML Application for Admission Implementation Guide Version 1.3.0

Applicant.Person.Contacts.OtherPhone (Continued)

Code illustration:

```
<OtherPhone>  
  <CountryPrefixCode/>  
  <AreaCityCode>512</AreaCityCode>  
  <PhoneNumber>8888888</PhoneNumber>  
  <PhoneNumberExtension/>  
  <EffectiveDate>2008-04-01</EffectiveDate>  
  <ExpirationDate>2009-12-31</ExpirationDate>  
  <NoteMessage>This is the phone of my benefactor who will be looking out for me.</NoteMessage>  
</OtherPhone>
```

PESC XML Application for Admission Implementation Guide Version 1.3.0

Applicant.Person.Contacts.PreferredPhone

Note: Although the complex data element Other Phone is an optional data element, if you choose to send the Other Phone of the Applicant, then you must send the data element PhoneNumber.

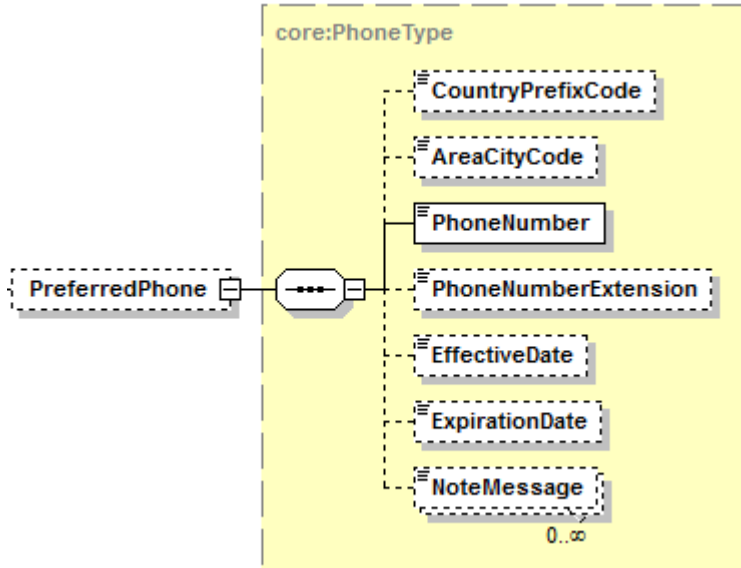

Tag Name	Schema Use	Description	Recommended Use	Format
CountryPrefixCode	Optional	International dialing code.	Optional	minOcc 0 maxOcc 1 minLength 1 maxLength 3
AreaCityCode	Optional	Regional dialing code.	Recommended	minOcc 0 maxOcc 1 minLength 1 maxLength 5
Comment: For phone numbers in the United States and Canada, this is the normal three digit area code.				
PhoneNumber	Required	Telephone number.	Required	minOcc 1 maxOcc 1 minLength 1 maxLength 11
PhoneNumberExtension	Optional	The extended telephone addressing information used in addition to phone number such as a PBX extension, a pager PIN, or FAX sub-address.	Optional	minOcc 0 maxOcc 1 minLength 1 maxLength 5
EffectiveDate	Optional	The date on which this other phone number becomes effective	Optional	minOcc 0 maxOcc 1 Date format CCYY-MM-DD
ExpirationDate	Optional	The date on which this temporary phone number expires	Optional	minOcc 0 maxOcc 1 Date format CCYY-MM-DD
NoteMessage	Optional Repeatable	Additional information about the temporary phone number	Optional	minOcc 0 maxOcc ∞ minLength 1 maxLength 80
Comment: If you do include OtherPhone in the instance document, it is suggested that you also include a NoteMessage to describe the type of this other phone.				

PESC XML Application for Admission Implementation Guide Version 1.3.0

Applicant.Person.Contacts.PreferredPhone (Continued)

Code illustration:

```
<PreferredPhone>  
  <CountryPrefixCode/>  
  <AreaCityCode>512</AreaCityCode>  
  <PhoneNumber>8888888</PhoneNumber>  
  <PhoneNumberExtension/>  
  <EffectiveDate>2008-04-01</EffectiveDate>  
  <ExpirationDate>2009-12-31</ExpirationDate>  
  <NoteMessage>This is the phone of my benefactor who will be looking out for me.</NoteMessage>  
</PreferredPhone>
```

PESC XML Application for Admission Implementation Guide Version 1.3.0

Applicant.Person.Contacts.PrimaryEmail

Note: Although the complex data element PrimaryEmail is an optional data element, if you choose to send the PrimaryEmail of the Applicant, then you must send the data element EmailAddress.

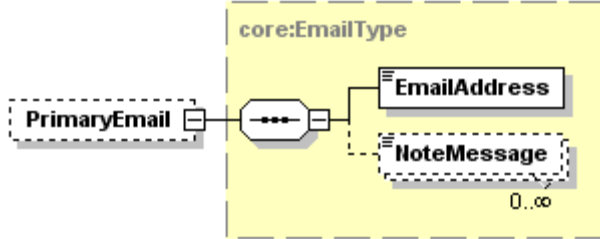

Tag Name	Schema Use	Description	Recommended Use	Format
EmailAddress	Required	The numbers, letters, and symbols used to identify an electronic mail (Email) user within a network.	Required	minOcc 1 maxOcc 1 minLength 1 maxLength 128
NoteMessage	Optional Repeatable	Additional information about the primary email	Not recommended	minOcc 0 maxOcc ∞ minLength 1 maxLength 80

Code illustration:

```
<PrimaryEmail>
  <EmailAddress>stewartj@aol.com</EmailAddress>
  <NoteMessage/>
</PrimaryEmail>
```

PESC XML Application for Admission Implementation Guide Version 1.3.0

Applicant.Person.Contacts.BillingEmail

Note: Although the complex data element *BillingEmail* is an optional data element, if you choose to send the *BillingEmail* of the Applicant, then you must send the data element *EmailAddress*.

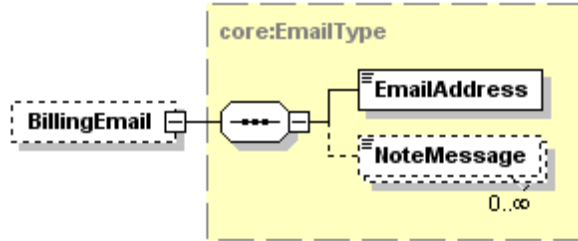

Tag Name	Schema Use	Description	Recommended Use	Format
EmailAddress	Required	The numbers, letters, and symbols used to identify an electronic mail (Email) user within a network.	Required	minOcc 1 maxOcc 1 minLength 1 maxLength 128
NoteMessage	Optional Repeatable	Additional information about the billing email	Not recommended	minOcc 0 maxOcc ∞ minLength 1 maxLength 80

Code illustration:

```
<BillingEmail>
  <EmailAddress>jtstewart@aol.com</EmailAddress>
  <NoteMessage/>
</BillingEmail>
```

PESC XML Application for Admission Implementation Guide Version 1.3.0

Applicant.Person.Contacts.CampusEmail

Note: Although the complex data element CampusEmail is an optional data element, if you choose to send the CampusEmail of the Applicant, then you must send the data element EmailAddress.

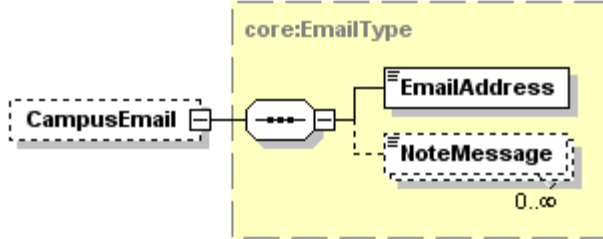

Tag Name	Schema Use	Description	Recommended Use	Format
EmailAddress	Required	The numbers, letters, and symbols used to identify an electronic mail (Email) user within a network.	Required	minOcc 1 maxOcc 1 minLength 1 maxLength 128
NoteMessage	Optional Repeatable	Additional information about the campus email	Not recommended	minOcc 0 maxOcc ∞ minLength 1 maxLength 80

Code illustration:

```
<CampusEmail>
  <EmailAddress>stewartj@aol.com</EmailAddress>
  <NoteMessage/>
</CampusEmail>
```

PESC XML Application for Admission Implementation Guide Version 1.3.0

Applicant.Person.Contacts.EmergencyEmail

Note: Although the complex data element *EmergencyEmail* is an optional data element, if you choose to send the *EmergencyEmail* of the Applicant, then you must send the data element *EmailAddress*.

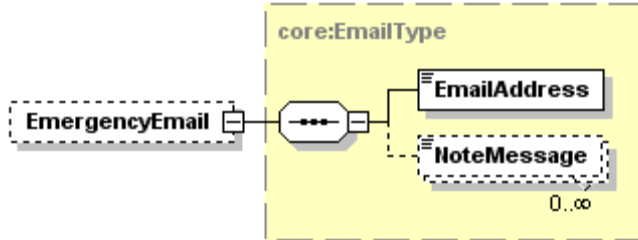

Tag Name	Schema Use	Description	Recommended Use	Format
EmailAddress	Required	The numbers, letters, and symbols used to identify an electronic mail (Email) user within a network.	Required	minOcc 1 maxOcc 1 minLength 1 maxLength 128
NoteMessage	Optional Repeatable	Additional information about the emergency email	Not recommended	minOcc 0 maxOcc ∞ minLength 1 maxLength 80

Code illustration:

```
<EmergencyEmail>
  <EmailAddress>jtstewart@aol.com</EmailAddress>
  <NoteMessage/>
</EmergencyEmail>
```

PESC XML Application for Admission Implementation Guide Version 1.3.0

Applicant.Person.Contacts.OtherEmail

Note: Although the complex data element *OtherEmail* is an optional data element, if you choose to send the *OtherEmail* of the Applicant, then you must send the data element *EmailAddress*.

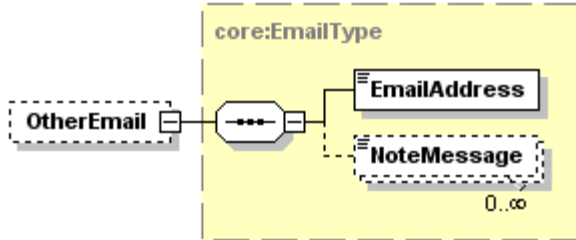

Tag Name	Schema Use	Description	Recommended Use	Format
EmailAddress	Required	The numbers, letters, and symbols used to identify an electronic mail (Email) user within a network.	Required	minOcc 1 maxOcc 1 minLength 1 maxLength 128
NoteMessage	Optional Repeatable	Additional information about the other email	Not recommended	minOcc 0 maxOcc ∞ minLength 1 maxLength 80

Code illustration:

```
<OtherEmail>
  <EmailAddress>stewartj@aol.com</EmailAddress>
  <NoteMessage/>
</OtherEmail>
```

PESC XML Application for Admission Implementation Guide Version 1.3.0

Applicant.Person.Contacts.URL

Note: Although the complex data element URL is an optional data element, if you choose to send the URL of the Applicant, then you must send the data element URLAddress.

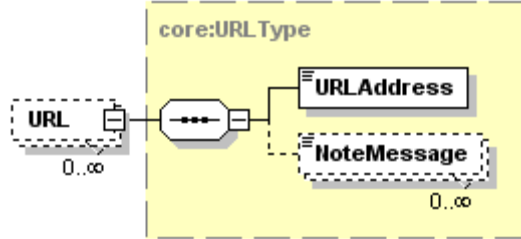

Tag Name	Schema Use	Description	Recommended Use	Format
URLAddress	Required	The Uniform Resource Locator (URL) address associated with an applicant	Required	minOcc 1 maxOcc 1 minLength 0 maxLength 512
NoteMessage	Optional Repeatable	Additional information about the URL of the applicant	Not recommended	minOcc 0 maxOcc ∞ minLength 1 maxLength 80

Code illustration:

```
<URL>
  <URLAddress>www.John.Appleseed.com</URLAddress>
  <NoteMessage/>
</URL>
```

PESC XML Application for Admission Implementation Guide Version 1.3.0

Applicant.Person.Contacts.InstantMessage

Note: Although the complex data element *InstantMessage* is an optional data element, if you choose to send the *InstantMessage* complex data element of the Applicant, then you must send both *InstantMessageAddress* and *InstantMessageProviderName*.

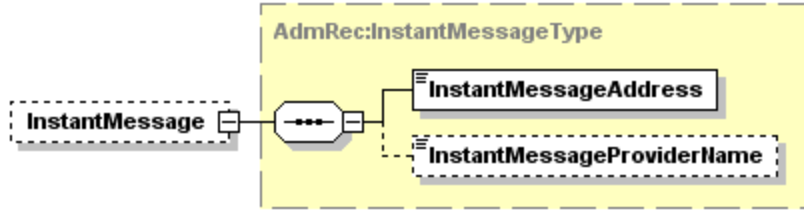

Tag Name	Schema Use	Description	Recommended Use	Format
InstantMessageAddress	Required	The address to which the applicant may be sent an Instant Message (IM)	Required	minOcc 1 maxOcc 1 minLength 0 maxLength 128
InstantMessageProviderName	Optional	The name of the provider of the IM messaging service by which the applicant may be sent an Instant Message (IM)	Required	minOcc 0 maxOcc 1 minLength 1 maxLength 60

Code illustration:

```
<InstantMessage>
  <InstantMessageAddress>John.Appleseed.com</InstantMessageAddress>
  <InstantMessageProviderName>GoogleTalk</InstantMessageProviderName>
</InstantMessage>
```

PESC XML Application for Admission Implementation Guide Version 1.3.0

Applicant.Person.Gender

Note: Although the complex data element Gender is an optional data element, if you choose to send the Gender of the Applicant, then you must send the data element GenderCode.

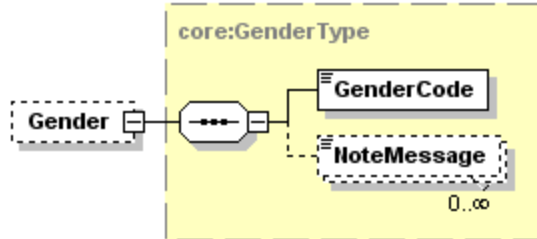

Tag Name	Schema Use	Description	Recommended Use	Format
GenderCode	Required	The gender of the Applicant	Required	minOcc 1 maxOcc 1 Enumerations: Female Male Unreported
NoteMessage	Optional Repeatable	Additional information about the Gender of the Applicant	Not Recommended	minOcc 0 maxOcc ∞ minLength 1 maxLength 80

Code illustration:

```

<Gender>
  <GenderCode>Male</GenderCode>
  <NoteMessage/>
</Gender>
    
```

PESC XML Application for Admission Implementation Guide Version 1.3.0

Applicant.Person.EthnicityRace

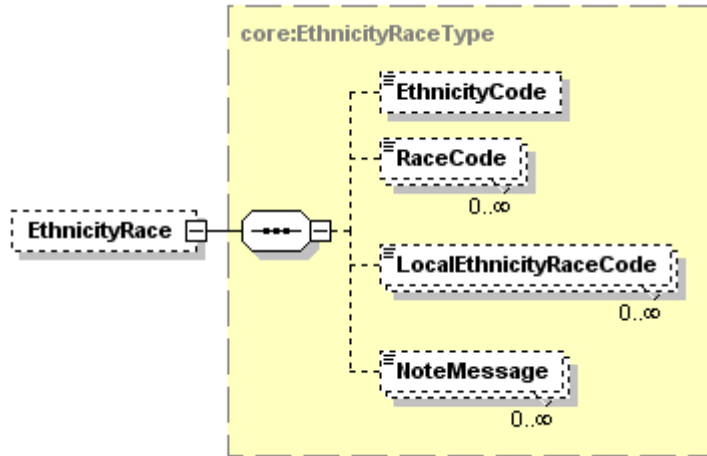

Tag Name	Schema Use	Description	Recommended Use	Format
EthnicityCode	Optional	This is the ethnicity code as determined by the US Department of Education's National Center for Education Statistics	Recommended	minOcc 0 maxOcc 1 Enumerations: Hispanic NonHispanic
RaceCode	Optional Repeatable	The applicant's race code(s) as submitted by the applicant	Recommended	minOcc 0 maxOcc ∞ Enumerations: AmericanIndianAlaskaNative Asian BlackAfricanAmerican NativeHawaiianPacificIslander White
Comment: These are codes recognized by the US Department of Education's National Center for Education Statistics. It is essential that these data be included in the school's database and requesting these data on the application for admission is probably the most common way of collecting these data. This version of the RaceEthnicity codes has now been approved by NCES				
LocalEthnicityRaceCode	Optional Repeatable	The student's race and ethnicity code as defined by the sending school's state, province or region.	Optional	minOcc 0 maxOcc ∞ minLength 1 maxLength 30
Comment: Individual states may ask for more specific race and/or ethnicity information. This data element is provided for those states.				
NoteMessage	Optional Repeatable	Additional information about the applicant's race or ethnicity	Not Recommended	minOcc 0 maxOcc ∞ minLength 1 maxLength 80

Code illustration:

```

<EthnicityRace>
  <Ethnicity>NonHispanic</Ethnicity>
  <RaceCode>AmericanIndianAlaskaNative</RaceCode>
  <RaceCode>BlackAfricanAmerican</RaceCode>
  <LocalEthnicityRaceCode>Seminole</LocalEthnicityRaceCode>
  <LocalEthnicityRaceCode>Black</LocalEthnicityRaceCode>
  <NoteMessage/>
</EthnicityRace>

```

PESC XML Application for Admission Implementation Guide Version 1.3.0

Applicant.Person.CanadianEthnicityRace

Note: Although CanadianEthnicityRace is an optional data element, if it is included in the instance document, then CanadianEthnicityCode must be included.

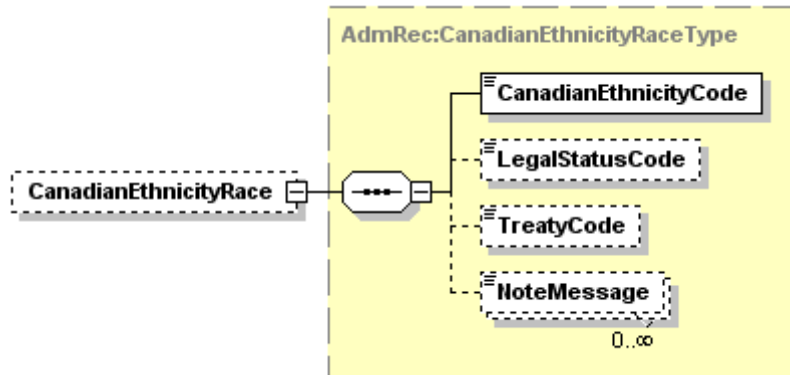

Tag Name	Schema Use	Description	Recommended Use	Format
CanadianEthnicityCode	Required	This is the ethnicity code as determined by Canadian schools	Required	minOcc 0 maxOcc 1 Enumerations: BillC31 FirstNations FrenchAncestry Inuit Metis
LegalStatusCode	Optional	A status code to determine legal status in Canada	Recommended	minOcc 0 maxOcc 1 Enumerations: NonStatus Status
TreatyCode	Optional	The applicant's declaration of determination of treaty status	Optional	minOcc 0 maxOcc 1 Enumerations: NonTreaty Treaty
NoteMessage	Optional Repeatable	Additional information about the applicant's Canadian ethnicity	Not Recommended	minOcc 0 maxOcc ∞ minLength 1 maxLength 80

Code illustration:

```

<CanadianEthnicityRace>
  <CanadianEthnicityCode>FirstNations</CanadianEthnicityCode>
  <LegalStatusCode>NonStatus</LegalStatusCode>
  <TreatyCode>Treaty</TreatyCode>
  <NoteMessage/>
</CanadianEthnicityRace>

```

PESC XML Application for Admission Implementation Guide Version 1.3.0

Applicant.Person.PrivacyRestriction

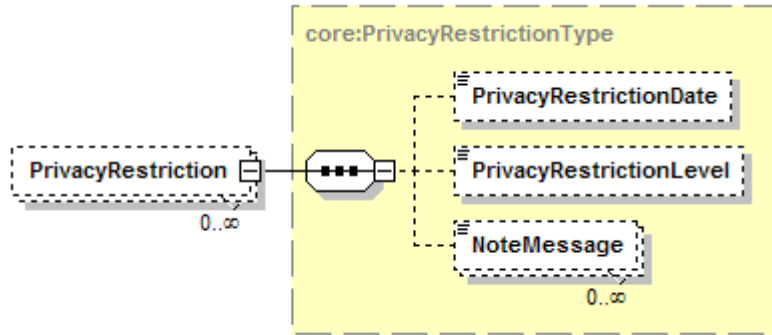

Tag Name	Schema Use	Description	Recommended Use	Format
PrivacyRestrictionDate	Optional	The date upon which the requested restriction to the allowable release of FERPA directory information takes effect after the applicant has become a student	Optional	minOcc 0 maxOcc 1 g:date in format ccyy-mm-dd
PrivacyRestrictionLevel	Optional	The type of restriction placed on the release of information. 00 No restrictions have been placed on the release of information 01 Student has requested that no directory information be released without prior consent 02 Student has requested nonrelease of specific information items 03 Student has requested nonrelease of information in specific formats (book, electronic, etc.) 04 Student has requested nonrelease of information to specific people, entities 99 Other (to be specified in the NoteMessage)	Recommended	minOcc 0 maxOcc 1 Enumerations: 00 01 02 03 04 99
NoteMessage	Optional Repeatable	Additional information about the requested privacy restriction	Optional	minOcc 0 maxOcc ∞ minLength 1 maxLength 80

Code illustration:

```

<PrivacyRestriction>
  <PrivacyRestrictionDate>2008-09-05</PrivacyRestrictionDate>
  <PrivacyRestrictionLevel>01</PrivacyRestrictionLevel>
  <NoteMessage/>
</PrivacyRestriction>
  
```

PESC XML Application for Admission Implementation Guide Version 1.3.0

Applicant.Person.Immigration

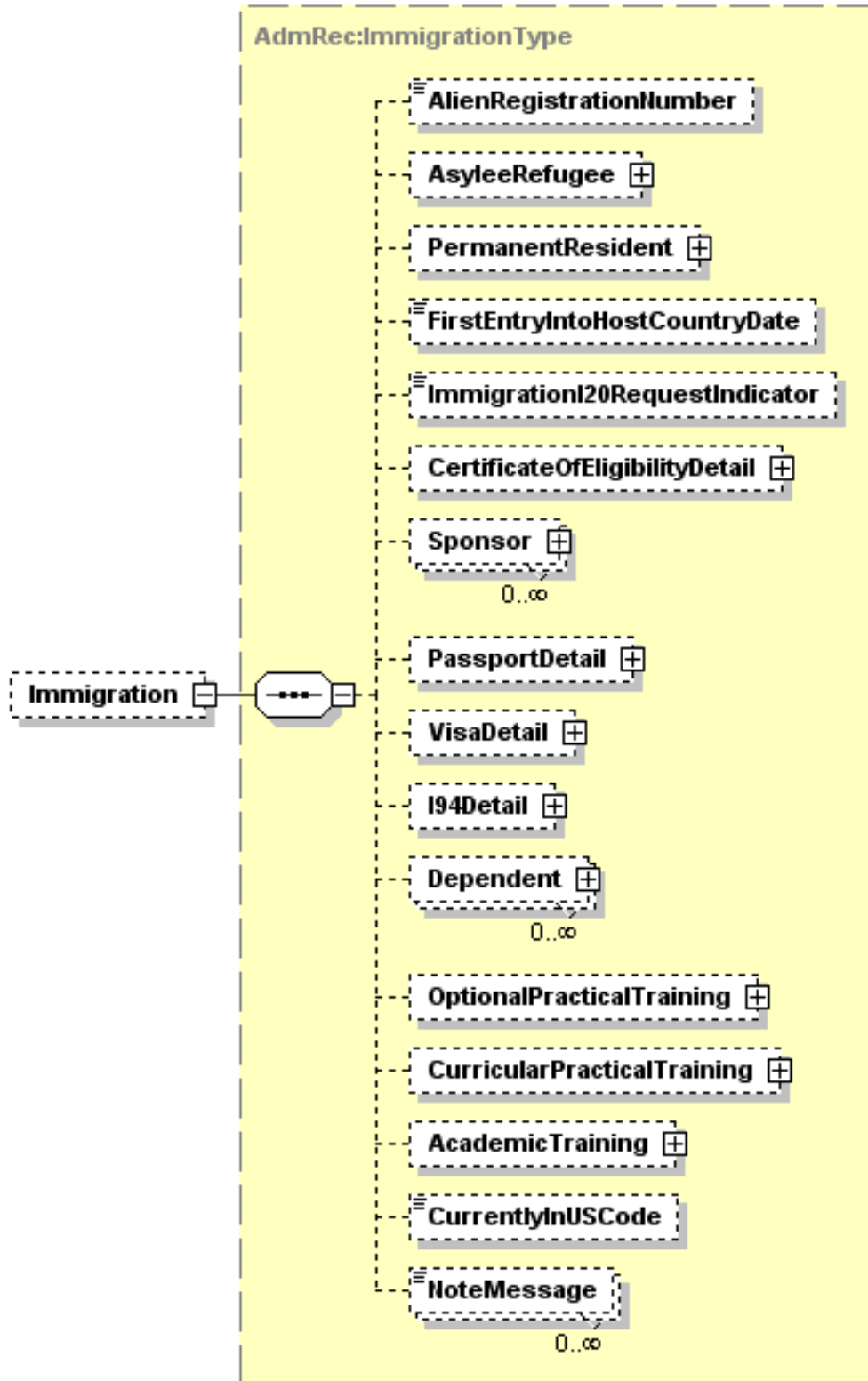

PESC XML Application for Admission Implementation Guide Version 1.3.0

Applicant.Person.Immigration (Continued)

Tag Name	Schema Use	Description	Recommended Use	Format
AlienRegistrationNumber	Optional	Alien Registration Number	Recommended	minOcc 0 maxOcc 1 minLength 1 maxLength 20
AsyleeRefugee	Optional	Information about the asylee or refugee status of the applicant	Optional	minOcc 0 maxOcc 1
Comment: This complex data element will be expanded on Page 128.				
PermanentResident	Optional	Information about the permanent resident status of the applicant	Optional	minOcc 0 maxOcc 1
Comment: This complex data element will be expanded on Page 129.				
FirstEntryIntoHostCountryDate	Optional	The date the applicant first entered or plans to enter into the host country	Recommended	minOcc 0 maxOcc 1 xs:date Format is ccyy-mm-dd
ImmigrationI20RequestIndicator	Optional	An indicator as to whether or not the applicant has already requested a US Immigration Form I-20	Recommended	minOcc 0 maxOcc 1 Boolean: Allowable values are True or False
Comment: The only value that would ever be sent is "true". If false, the data element would not be included.				
CertificateOfEligibilityDetail	Optional	Information about request for and issuing of US Immigration I-20 Forms and other similar Canadian forms	Recommended	minOcc 0 maxOcc 1
Comment: Further information about the details of Certificate of Eligibility requests and issuance will be provided on page 130.				
Sponsor	Optional Repeatable	Information relating to the sponsor of the applicant while in the country of the school	Recommended	minOcc 0 maxOcc ∞
Comment: Further information about the details of the sponsor(s) for the international applicant will be provided on page 132.				
PassportDetail	Optional	Information about the passport held by or being applied for by the international applicant	Recommended	minOcc 0 maxOcc 1
Comment: Further information about the passport detail will be provided on page 185.				
VisaDetail	Optional	Information about the visa held by or being applied for by the international applicant	Recommended	minOcc 0 maxOcc 1
Comment: Further information about the visa details will be provided on page 186.				
I94Detail	Optional	Information about the I-94 issued to a non US citizen upon the last entry into the United States	Recommended	minOcc 0 maxOcc 1
Comment: Further information about the I94 details will be provided on page 188.				
Dependent	Optional Repeatable	Information about dependents of the applicant that would accompany the applicant to the host country	Recommended	minOcc 0 maxOcc ∞
Comment: Further information about the details of dependents of the applicant will be provided on page 189.				
OptionalPracticalTraining	Optional	Information about the optional practical training being applied for (or received) by the international applicant	Recommended	minOcc 0 maxOcc 1

PESC XML Application for Admission Implementation Guide

Version 1.3.0

Tag Name	Schema Use	Description	Recommended Use	Format
Comment: Further information about the details of optional practical training will be provided on page 194.				
CurricularPracticalTraining	Optional	Information about the curricular practical training being applied for (or received) by the international applicant	Recommended	minOcc 0 maxOcc 1
Comment: Further information about the details of curricular practical training will be provided on page 195.				
AcademicTraining	Optional	Details about academic training available for J1 Exchange Visitors	Recommended	minOcc 0 maxOcc 1
Comment: Further information about the details of the academic training will be provided on page 196.				
CurrentlyInUSCode	Optional	An indication that the applicant is currently located in the United States, or not.	Recommended	minOcc 0 maxOcc 1 Enumerations: No Yes
NoteMessage	Optional Repeatable	Additional information about Immigration	Not Recommended	minOcc 0 maxOcc ∞ minLength 1 maxLength 80

Code illustration:

```

<Immigration>
  <AlienRegistrationNumber>12345678900</AlienRegistrationNumber>
  <AsyleeRefugee>

  </AsyleeRefugee>
  <PermanentResident>

  </PermanentResident>
  <FirstEntryIntoHostCountryDate>2006-12-22</FirstEntryIntoHostCountryDate>
  <ImmigrationI20RequestIndicator>true</ ImmigrationI20RequestIndicator >
  <CertificateOfEligibilityDetail>

  </CertificateOfEligibilityDetail>
  <Sponsor>

  </Sponsor>
  <PassportDetail>

  </PassportDetail>
  <VisaDetail>

  </VisaDetail>
  <I94Detail>

  </I94Detail>
  <Dependent>

  </Dependent>
  <OptionalPracticalTraining>

  </OptionalPracticalTraining>
  <CurricularPracticalTraining>

  </CurricularPracticalTraining>
  <AcademicTraining>

  </AcademicTraining>
  <CurrentlyInUSCode>No</CurrentlyInUSCode>
  <NoteMessage/>
</Immigration>

```

PESC XML Application for Admission Implementation Guide Version 1.3.0

Applicant.Person.Immigration.AsyleeRefugee

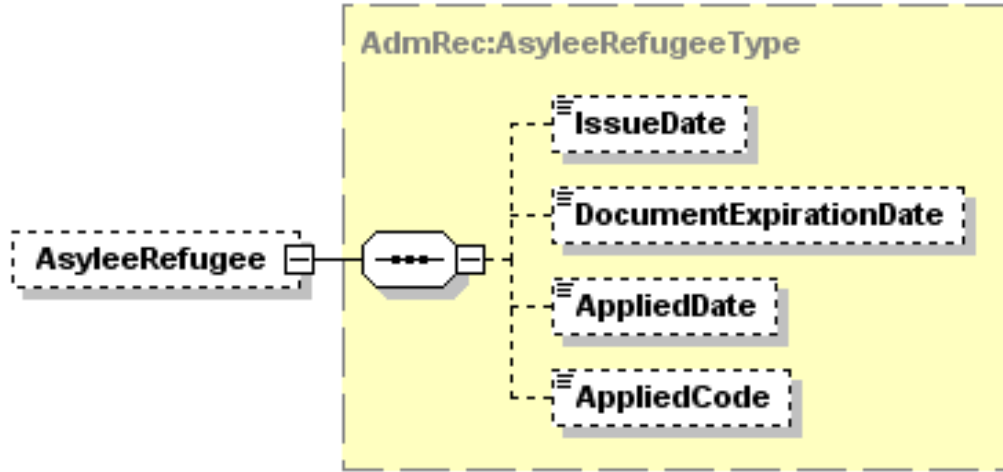

Tag Name	Schema Use	Description	Recommended Use	Format
IssueDate	Optional	The date of issue of the asylee or refugee document that gave the applicant the asylee or refugee status	Recommended	minOcc 0 maxOcc 1 g: Date where the format is ccyymm-dd
DocumentExpirationDate	Optional	The date that the asylee or refugee status is no longer valid	Recommended	minOcc 0 maxOcc 1 Date format is ccyymm-dd
AppliedDate	Optional	The date on which the applicant stated that the application was submitted to apply for this status	Recommended	minOcc 0 maxOcc 1 Date format is ccyymm-dd
AppliedCode	Optional	An indication that the applicant has applied for asylee or refugee status	Recommended	minOcc 0 maxOcc 1 Enumerations: No Yes

Code illustration:

```

<AsyleeRefugee>
  <IssueDate>2008-01-15</IssueDate>
  <DocumentExpirationDate>2009-01-15</DocumentExpirationDate>
  <AppliedDate>2004-04-01</AppliedDate>
  <AppliedCode>Yes</AppliedCode>
</AsyleeRefugee>
  
```

PESC XML Application for Admission Implementation Guide Version 1.3.0

Applicant.Person.Immigration.PermanentResident

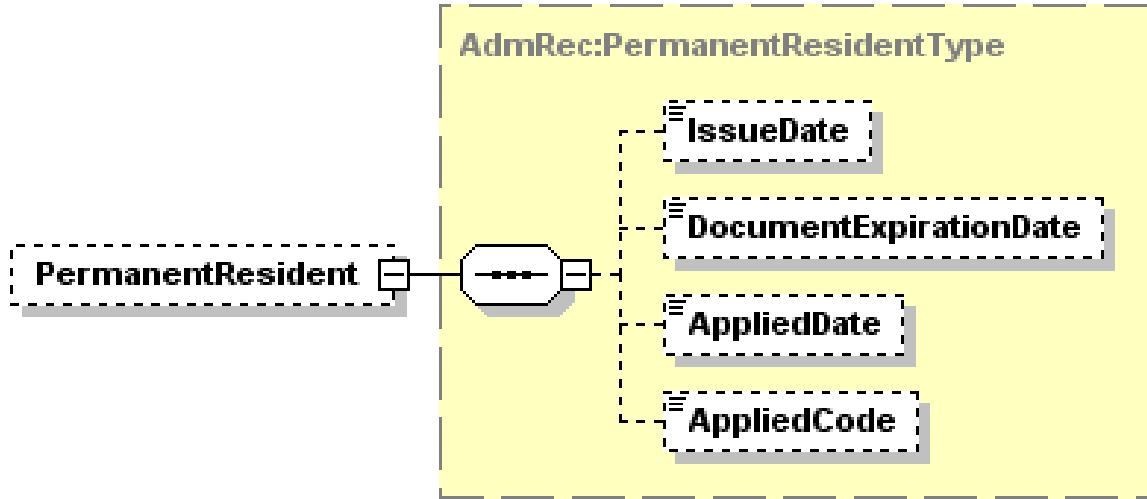

Tag Name	Schema Use	Description	Recommended Use	Format
IssueDate	Optional	The date of issue of the permanent resident document that gave the applicant the permanent resident status	Recommended	minOcc 0 maxOcc 1 Date where the format is ccyy-mm-dd
DocumentExpirationDate	Optional	The date after which the permanent resident status is no longer valid	Recommended	minOcc 0 maxOcc 1 Date where the format is ccyy-mm-dd
AppliedDate	Optional	The date on which the applicant stated that the application was submitted to apply for this status	Recommended	minOcc 0 maxOcc 1 Date where the format is ccyy-mm-dd
AppliedCode	Optional	An indication that the applicant has applied for permanent resident status	Recommended	minOcc 0 maxOcc 1 Enumerations: No Yes

Code illustration:

```

<PermanentResident>
  <IssueDate>2008-01-15</IssueDate>
  <DocumentExpirationDate>2009-01-15</DocumentExpirationDate>
  <AppliedDate>2004-04-01</AppliedDate>
  <AppliedCode>Yes</AppliedCode>
</PermanentResident>
  
```

PESC XML Application for Admission Implementation Guide Version 1.3.0

Applicant.Person.Immigration.CertificateOfEligibilityDetail

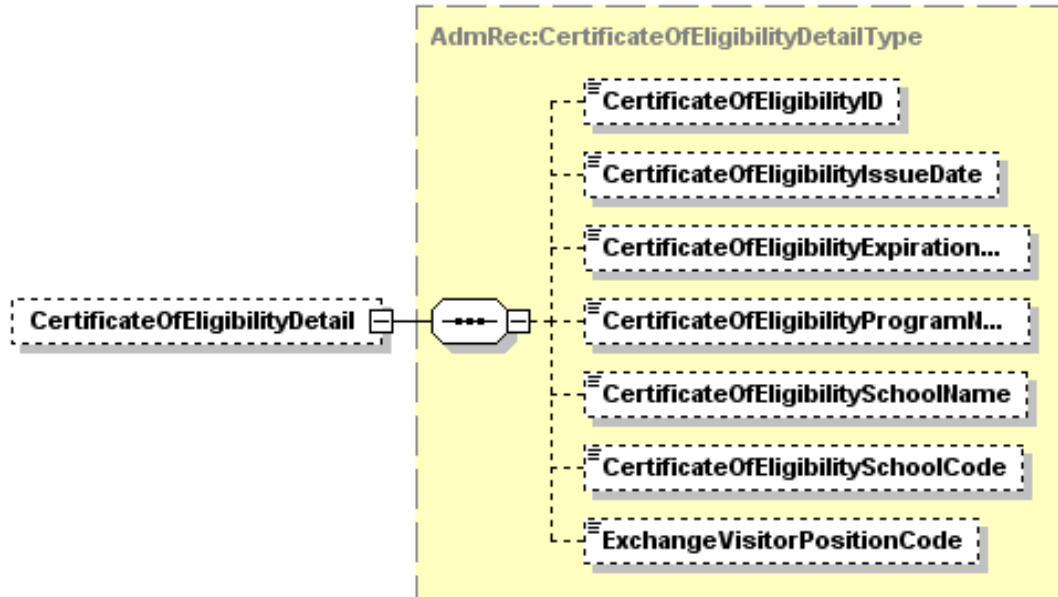

Tag Name	Schema Use	Description	Recommended Use	Format
CertificateOfEligibilityID	Optional	The number that is assigned by the Immigration Service that identifies the international applicant	Recommended	minOcc 0 maxOcc 1 minLength 0 maxLength 11
CertificateOfEligibilityIssueDate	Optional	The date this Certificate of Eligibility (I20 form in the US) form was issued	Recommended	minOcc 0 maxOcc 1 Date format is ccyymm-dd
CertificateOfEligibilityExpirationDate	Optional	The date this Certificate of Eligibility Form (I20 form in the US) expires	Recommended	minOcc 0 maxOcc 1 Date format is ccyymm-dd
CertificateOfEligibilityProgramName	Optional	The name used by SEVIS in the US to identify the educational program for which the applicant is applying or has been approved	Recommended	minOcc 0 maxOcc 1 minLength 1 maxLength 60
CertificateOfEligibilitySchoolName	Optional	The name of the school issuing the Certificate of Eligibility (I20 form in the US) form	Optional	minOcc 0 maxOcc 1 minLength 1 maxLength 80
CertificateOfEligibilitySchoolCode	Optional	The code assigned by SEVIS in the US to the school issuing the Certificate of Eligibility (I20 form in the US)	Recommended	minOcc 0 maxOcc 1 minLength 1 maxLength 20
Comment: An example of a school code would be WAS214F12345123.				
ExchangeVisitorPositionCode	Optional	The code assigned to the position held (or being applied for) by the international exchange visitor applicant	Recommended	minOcc 0 maxOcc 1 minLength 3 maxLength 3 See Appendix S for acceptable values

PESC XML Application for Admission Implementation Guide Version 1.3.0

Applicant.Person.Immigration.CertificateOfEligibilityDetail (Continued)

Code illustration:

```
<CertificateOfEligibilityDetail>  
  <CertificateOfEligibilityID>1234567</CertificateOfEligibilityID>  
  <CertificateOfEligibilityIssueDate>2007-04-02</CertificateOfEligibilityIssueDate>  
  <CertificateOfEligibilityExpirationDate>2009-04-01</CertificateOfEligibilityExpirationDate>  
  <CertificateOfEligibilityProgramName>Liberal Arts</CertificateOfEligibilityProgramName>  
  <CertificateOfEligibilitySchoolName>Texas A&M University</CertificateOfEligibilitySchoolName>  
  <CertificateOfEligibilitySchoolCode>334455</CertificateOfEligibilitySchoolCode>  
  <ExchangeVisitorPositionCode>116</ExchangeVisitorPositionCode>  
</CertificateOfEligibilityDetail>
```

PESC XML Application for Admission Implementation Guide Version 1.3.0

Applicant.Person.Immigration.Sponsor

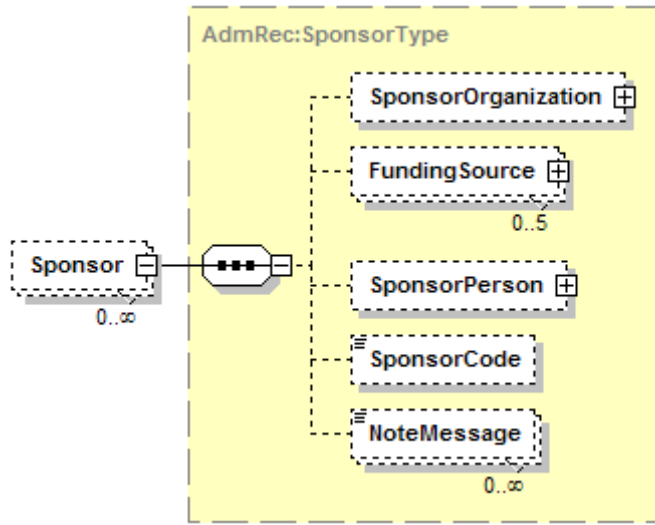

Tag Name	Schema Use	Description	Recommended Use	Format
SponsorOrganization	Optional	Information about the organization that has offered to sponsor the international applicant	Recommended	minOcc 0 maxOcc 1
Comment: More detailed information about the SponsorOrganization will be presented on page 134.				
FundingSource	Optional Repeatable	The source of the funds being provided for the international applicant	Recommended	minOcc 0 maxOcc 5
Comment: More detailed information about the FundingSource will be presented on page 147.				
SponsorPerson	Optional	Information about the person that has offered to sponsor the international applicant	Recommended	minOcc 0 maxOcc 1
Comment: More detailed information about the SponsorPerson will be presented on page 158.				
SponsorCode	Optional	The type of sponsor being described	Optional	minOcc 0 maxOcc 1 Enumerations: ForeignCompany ForeignGovernment Institution Organization Other Parent Relative Self Spouse Unknown USCompany USGovernment
NoteMessage	Optional Repeatable	Additional information about the sponsor for the international applicant	Not recommended	minOcc 0 maxOcc ∞ minLength 1 maxLength 80

PESC XML Application for Admission Implementation Guide Version 1.3.0

Applicant.Person.Immigration.Sponsor (Continued)

Code illustration:

```
<Sponsor>  
  <SponsorOrganization>  
  
    </SponsorOrganization>  
    <FundingSource>  
  
      </FundingSource>  
      <SponsorPerson>  
  
        </SponsorPerson>  
        <SponsorCode>Parent</SponsorCode>  
        <NoteMessage/>  
      </Sponsor>
```

PESC XML Application for Admission Implementation Guide Version 1.3.0

Applicant.Person.Immigration.Sponsor.SponsorOrganization

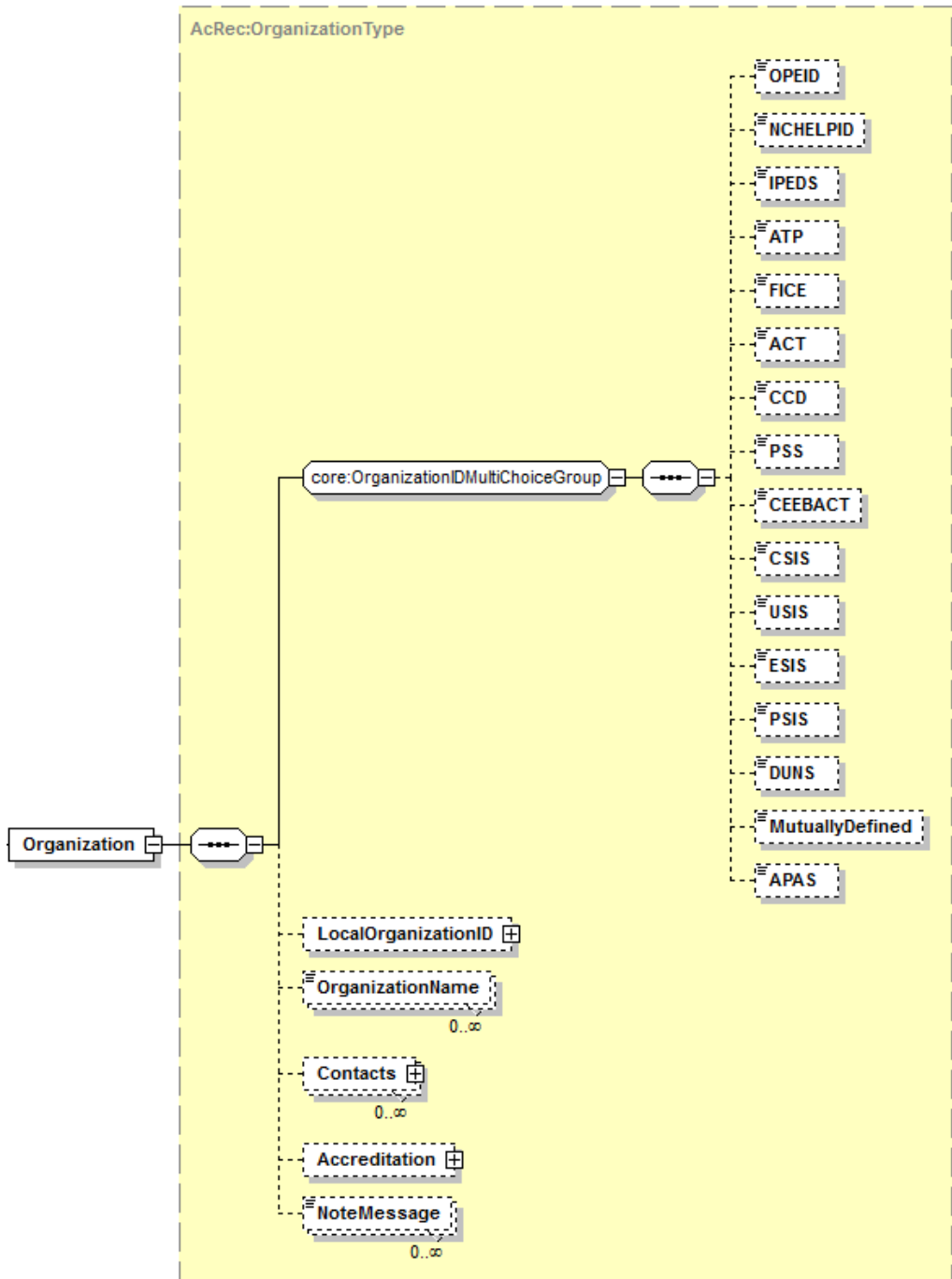

Tag Name	Schema Use	Description	Recommended Use	Format
[OrganizationIDGroup]	Optional	Allowable Organization IDs - Exclusive choice	Optional	minOcc 0 maxOcc 1

Comment: [OrganizationIDGroup] is not an XML tag and does not appear in an instance document. It allows the choice of one and only one of the following code set tags to identify the sponsoring organization for this International Applicant.

PESC XML Application for Admission Implementation Guide

Version 1.3.0

Tag Name	Schema Use	Description	Recommended Use	Format
OPEID	Optional choice	The unique identifier assigned by the Office of Postsecondary Education for each data exchange partner. Includes all postsecondary schools that are eligible to participate in US Title IV federal financial aid programs.	Optional	minOcc 0 maxOcc 1 minLength 3 maxLength 8
Comment: The OPEID would not normally be an appropriate choice in this case unless a postsecondary institution is the sponsor of an international applicant.				
NCHELPID	Optional choice	The unique identifier assigned by National Council on Higher Education Loan Programs for each data exchange partner.	Not Recommended	minOcc 0 maxOcc 1 minLength 3 maxLength 8
Comment: The NCHELPID would not normally be an appropriate choice in this case since the organizations in the financial aid world would not normally be sponsors of an international applicant.				
IPEDS	Optional choice	The unique identifier for Integrated Postsecondary Education Data System assigned by the National Center for Education Statistics for each postsecondary data exchange partner. Also called the Unit ID.	Optional	minOcc 0 maxOcc 1 minLength 6 maxLength 6
Comment: The IPEDS would not normally be an appropriate choice in this case unless a postsecondary institution was sponsoring the international applicant.				
ATP	Optional choice	The unique identifier for the Admissions Testing Program assigned by the College Board for each data exchange partner.	Optional	minOcc 0 maxOcc 1 minLength 6 maxLength 6
Comment: The ATP would not normally be an appropriate choice in this case unless a postsecondary institution was sponsoring the international applicant.				
FICE	Optional choice	The unique identifier once maintained for the Federal Interagency Committee on Education by the National Center for Education Statistics for each postsecondary data exchange partner.	Optional	minOcc 0 maxOcc 1 minLength 6 maxLength 6
Comment: The FICE would not normally be an appropriate choice in this case unless a postsecondary institution was sponsoring the international applicant.				
ACT	Optional choice	The unique identifier for postsecondary educational institutions assigned by American College Testing available at www.act.org	Optional	minOcc 0 maxOcc 1 minLength 4 maxLength 4
Comment: The ACT would not normally be an appropriate choice in this case unless a postsecondary institution was sponsoring the international applicant.				
CCD	Optional choice	The unique identifier assigned by National Center for Education Statistics as the Common Core of Data for each data exchange partner.	Not Recommended	minOcc 0 maxOcc 1 minLength 12 maxLength 12
Comment: The CCD would not normally be an appropriate choice in this case since secondary schools would not normally sponsor an international applicant.				
PSS	Optional choice	The unique identifier assigned by National Center for Education Statistics for private K12 schools in the US for each secondary data exchange partner.	Not Recommended	minOcc 0 maxOcc 1 minLength 8 maxLength 8

PESC XML Application for Admission Implementation Guide

Version 1.3.0

Tag Name	Schema Use	Description	Recommended Use	Format
Comment: The PSS would not normally be an appropriate choice in this case since secondary schools would not normally sponsor an international applicant.				
CEEBACT	Optional choice	The unique identifier assigned by the College Entrance Examining Board and ACT for each K-12 data exchange partner.	Not Recommended	minOcc 0 maxOcc 1 minLength 6 maxLength 6
Comment: The CEEBACT would not normally be an appropriate choice in this case since secondary schools would not normally sponsor an international applicant.				
CSIS	Optional choice	The unique identifier assigned by the Statistics Canada Canadian College Student Information System for each postsecondary data exchange partner.	Optional	minOcc 0 maxOcc 1 minLength 6 maxLength 6
Comment: Since this code set is used to identify postsecondary schools in Canada, it is not a recommended choice for US schools. However, this code set is being phased out in favor of the newer code set PSIS.				
USIS	Optional choice	The unique identifier assigned by the Statistics Canada University Student Information System for each data postsecondary exchange partner.	Optional	minOcc 0 maxOcc 1 minLength 6 maxLength 6
Comment: Since this code set is used to identify postsecondary schools in Canada, it is not a recommended choice for schools in the US. However, this code set is being phased out in favor of the newer code set PSIS.				
ESIS	Optional choice	The unique identifier assigned by the Statistics Canada Enhanced Student Information System for each data postsecondary exchange partner.	Optional	minOcc 0 maxOcc 1 minLength 8 maxLength 8
Comment: Since this code set is used to identify postsecondary schools in Canada, it is not a recommended choice for schools in the US. However, it would be a valid choice for schools in Canada.				
PSIS	Optional choice	The unique identifier assigned by the Statistics Canada Postsecondary Student Information System for each data postsecondary exchange partner.	Optional	minOcc 0 maxOcc 1 minLength 8 maxLength 8
Comment: Since this code set is used to identify postsecondary schools in Canada, it is not a recommended choice for schools in the US. However, it would be the preferred and a valid choice for schools in Canada.				
DUNS	Optional choice	Data Universal Numbering System (DUNS), unique nine character company identification number issued by Dun and Bradstreet Corporation.	Recommended	minOcc 0 maxOcc 1 minLength 9 maxLength 9
Comment: The DUNS number would be an appropriate choice to identify a company or other agency that might sponsor an international applicant.				
MutuallyDefined	Optional choice	A code set that is agreed upon by the sender and the recipient of the instance document	Optional	minOcc 0 maxOcc 1 minLength 1 maxLength 60
Comment: MutuallyDefined would be an appropriate choice to identify a company or other agency that might sponsor an international applicant and no code is available in any of the other choice code sets.				
APAS	Optional choice	Identification codes used by the Alberta Post-Secondary Application System.	Optional	minOcc 0 maxOcc 1 minLength 2 maxLength 12
Comment: This is an appropriate choice for institutions in Canada.				

PESC XML Application for Admission Implementation Guide Version 1.3.0

Tag Name	Schema Use	Description	Recommended Use	Format
<i>Comment: End of OrganizationIDGroup choice set tags.</i>				
LocalOrganizationID	Optional	The identifying number assigned to an organization by a state or other agency	Not Recommended	minOcc 0 maxOcc 1
OrganizationName	Required Repeatable	Name of Non-person entity such as Organization, Institution, Agency or Business.	Required	minOcc 1 maxOcc ∞ minLength 1 maxLength 60
<i>Comment: This is the name of the company, vendor, school or agency that is sponsoring the international applicant</i>				
Contacts	Optional Repeatable	To identify a person or an office at the vendor, company, association, agency or school to which administrative communications should be directed	Recommended	minOcc 0 maxOcc ∞
<i>Comment: Additional information about the complex data element Contacts will be shown on page 138.</i>				
NoteMessage	Optional Repeatable	Additional information about the sponsoring organization	Not recommended	minOcc 0 maxOcc ∞ minLength 1 maxLength 80

Applicant.Person.Immigration.Sponsor.SponsorOrganization (Continued)

Code illustration:

```

<SponsorOrganization>
  <DUNS>123456789</DUNS>
  <LocalOrganizationID/>
  <OrganizationName>Xap Corporation</OrganizationName>
  <Contacts>

    </Contacts>
  <NoteMessage/>
</SponsorOrganization>

```

PESC XML Application for Admission Implementation Guide Version 1.3.0

Applicant.Person.Immigration.Sponsor.SponsorOrganization.Contacts

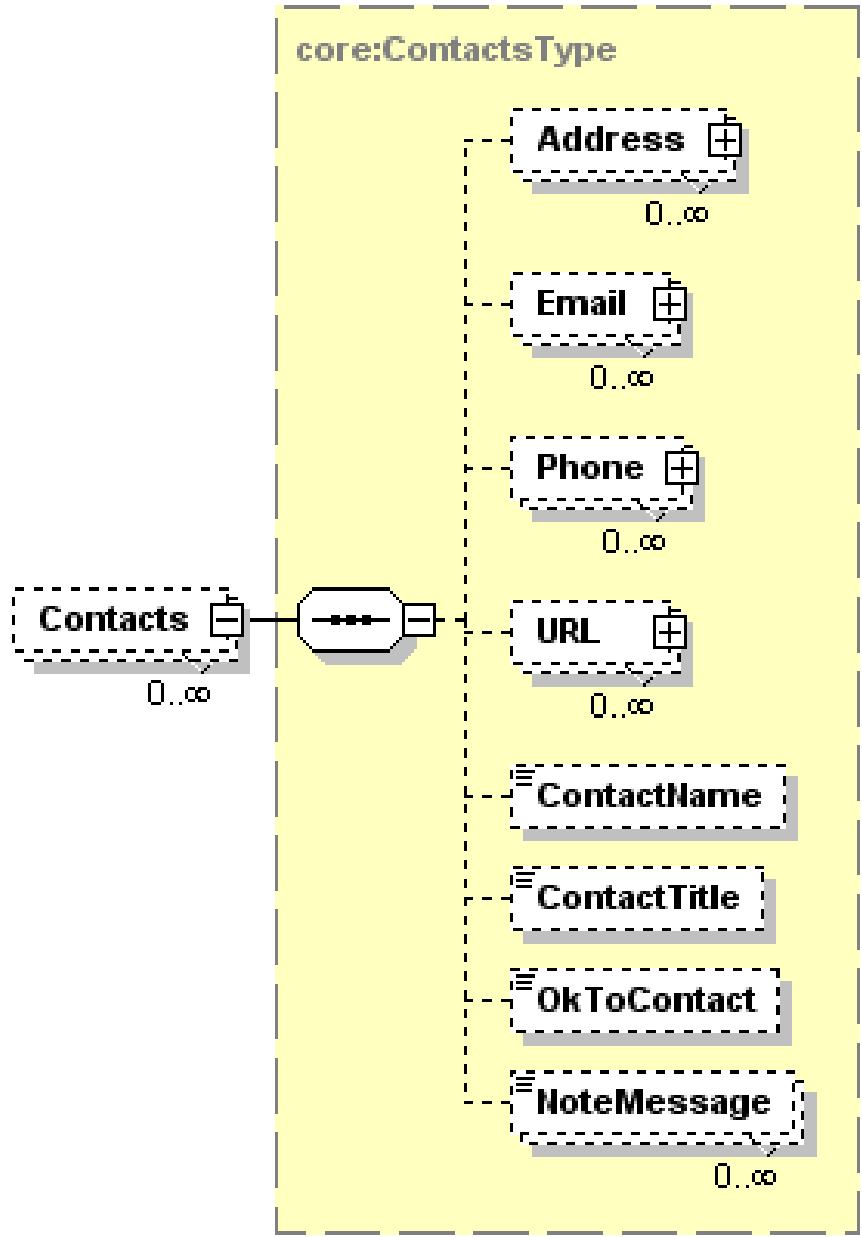

Tag Name	Schema Use	Description	Recommended Use	Format
Address	Optional Repeatable	This is a combined Address Group for a choice between Domestic or International	Optional	minOcc 0 maxOcc ∞

Comment: Additional information about the complex data element Address will be shown on page 140. This is the address of the company, agency or institution that is the sponsor of this international applicant for admission.

PESC XML Application for Admission Implementation Guide

Version 1.3.0

Tag Name	Schema Use	Description	Recommended Use	Format
Email	Optional Repeatable	Email address of sponsoring company, agency, vendor or institution contact	Recommended	minOcc 0 maxOcc ∞
Comment: Additional information about the complex data element Email will be shown on page 143.				
Phone	Optional Repeatable	Phone number of sponsoring company, agency, vendor or institution contact	Recommended	minOcc 0 maxOcc ∞
Comment: Additional information about the complex data element Phone will be shown on page 144.				
URL	Optional Repeatable	The Uniform Resource Locator of sponsoring company, agency or vendor	Optional	minOcc 0 maxOcc ∞
Comment: Additional information about the complex data element URL for the source of this application for admission will be shown on page 146.				
ContactName	Optional	The name of the contact at the sponsoring organization	Optional	minOcc 0 maxOcc 1 minLength 0 maxLength 60
ContactTitle	Optional	The job title or position of the contact at the sponsoring organization	Recommended	minOcc 0 maxOcc ∞ minLength 0 maxLength 60
OkToContact	Optional	If known, this is the information that the applicant has provided that it is OK to contact the person at the sponsoring organization about additional information	Optional	minOcc 0 maxOcc ∞ Enumerations: No Yes
NoteMessage	Optional Repeatable	Additional information about the contacts at the sponsor company, agency or vendor	Not recommended	minOcc 0 maxOcc ∞ minLength 1 maxLength 80
Comment: This is contact information included by the sponsoring company, agency or vendor to indicate the preferred means for the school to use to contact it in case there is a need for further communication.				

Code illustration:

```

<Contacts>
  <Address>

  </Address>
  <Email>

  </Email>
  <Phone>

  </Phone>
  <URL>

  </URL>
  <ContactName>Mr. Moneybags</ContactName>
  <ContactTitle>Resource Manager</ContactTitle>
  <OkToContact>Yes</OkToContact>
  <NoteMessage/>
</Contacts>

```

PESC XML Application for Admission Implementation Guide Version 1.3.0

Applicant.Person.Immigration.Sponsor.SponsorOrganization.Contacts.Address

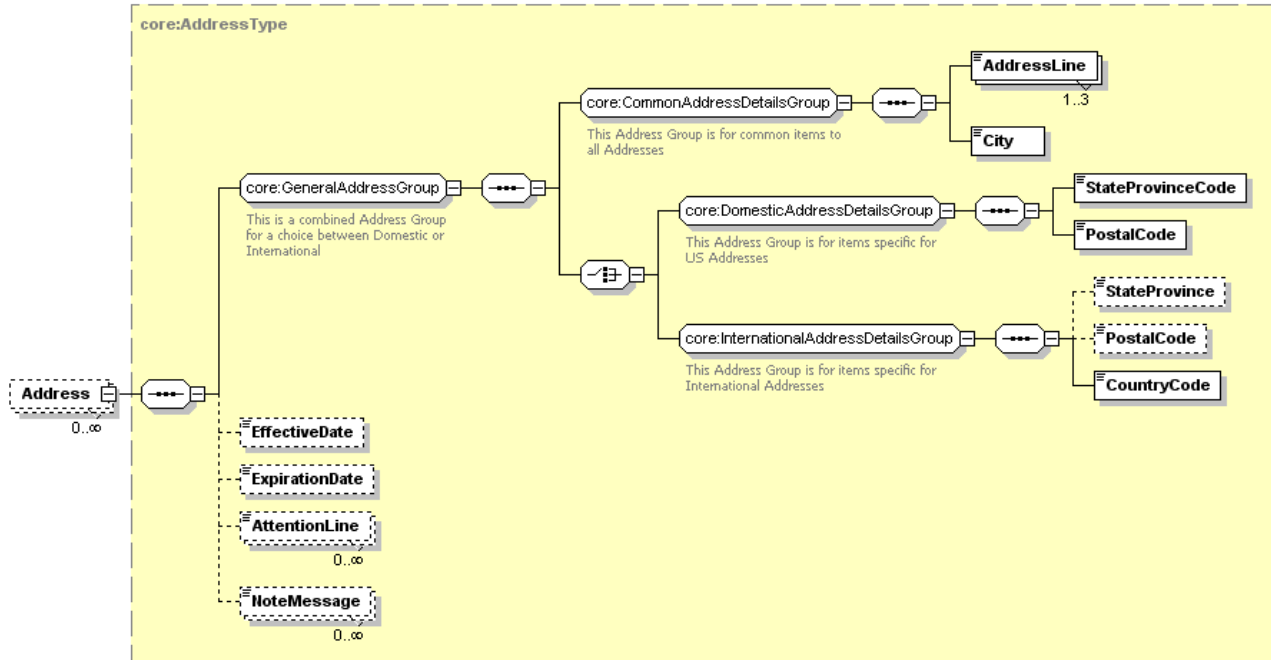

Tag Name	Schema Use	Description	Recommended Use	Format
<i>GeneralAddressGroup</i>	Required	This Address Group is for items common to all Addresses	Required	minOcc 1 maxOcc 1
Comment: [<i>GeneralAddressGroup</i>] does not appear in the instance document. It requires the use of <i>CommonAddressDetailsGroup</i> and the choice of one of either <i>DomesticAddressDetailsGroup</i> or <i>InternationalAddressDetailsGroup</i> . This group is required in the schema only if you choose to send the address of the contact at the sponsoring company, agency or school.				
<i>CommonAddressDetailsGroup</i>	Required	This Address Group is for items common to all Addresses	Required	minOcc 1 maxOcc 1
Comment: [<i>CommonAddressDetailsGroup</i>] does not appear in the instance document. If the address of a contact is included in the Application for Admission, then this must be sent. It is required and must be paired with one of either <i>DomesticAddressDetailsGroup</i> or <i>InternationalAddressDetailsGroup</i> .				
AddressLine	Required Repeatable	Local delivery information such as street, building number, PO box, or apartment portion of a postal address of a Contact at the Sponsoring Company, Agency or Vendor.	Required	minOcc 1 maxOcc 3 minLength 1 maxLength 40
City	Required	The city portion of the Address of a Contact at the Sponsoring Company, Agency or Vendor.	Required	minOcc 1 maxOcc 1 minLength 2 maxLength 30

PESC XML Application for Admission Implementation Guide

Version 1.3.0

Tag Name	Schema Use	Description	Recommended Use	Format
<i>DomesticAddressDetailsGroup</i>	Required choice	This Address Group is for items specific for US and Canadian Addresses	Required for domestic addresses	minOcc 1 maxOcc 1
Comment: [<i>DomesticAddressDetailsGroup</i>] does not appear in the instance document. If the complex data element address has a United States or Canadian Postal Code and a US State or Canadian Province Code, then this should be the required choice.				
StateProvinceCode	Required	Code for US states, etc., and Canadian provinces	Required	minOcc 1 maxOcc 1 Enumeration: See Appendix A
PostalCode	Required	The postal code portion of the Address.	Required	minOcc 1 maxOcc 1 minLength 1 maxLength 17
<i>InternationalAddressDetailsGroup</i>	Required choice	This Address Group is for items specific for International Addresses	Required for international addresses	minOcc 1 maxOcc 1
Comment: [<i>InternationalAddressDetailsGroup</i>] does not appear in the instance document. This choice is for addresses that do not have a US or Canadian postal code.				
StateProvince	Optional	The literal name of the state, province or territory of a postal address of the sponsor of the international applicant. Use for addresses outside US or Canada.	Recommended Refer to common postal practices of the source country	minOcc 0 maxOcc 1 minLength 2 maxLength 30
Comment: For an internet resource of states or other geographical subdivisions in countries other than the US and Canada, you might choose to refer to the website of the Universal Postal Union at http://www.upu.int				
PostalCode	Optional	The postal code portion of the Address.	Recommended Refer to common postal practices of the source country	minOcc 0 maxOcc 1 minLength 1 maxLength 17
Comment: For an internet resource of states or other geographical subdivisions in countries other than the US and Canada, you might choose to refer to the website of the Universal Postal Union at http://www.upu.int				
CountryCode	Required	Code indicating Country. Use ISO 3166-1 alpha-2 standard.	Required	minOcc 1 maxOcc 1 Enumerations: See Appendix B1 or B2
EffectiveDate	Optional	The date on which the address became (or will become) effective	Optional	minOcc 0 maxOcc 1 Date format: CCYY-MM-DD
ExpirationDate	Optional	The date on which the address will (or did) expire	Optional	minOcc 0 maxOcc 1 Date format: CCYY-MM-DD
AttentionLine	Optional	The individual or office name within the postal address where inquiries should be directed.	Optional	minOcc 0 maxOcc ∞ minLength 1 maxLength 45
NoteMessage	Optional Repeatable	Additional information about the addresses of the sponsoring organization	Not recommended	minOcc 0 maxOcc ∞ minLength 1 maxLength 80

PESC XML Application for Admission Implementation Guide Version 1.3.0

Applicant.Person.Immigration.Sponsor.SponsorOrganization.Contacts. Address (Continued)

Code illustration 1 (Domestic Address):

```
<Address>  
  <AddressLine>1715 W Cesar Chavez</AddressLine>  
  <City>Austin</City>  
  <StateProvinceCode>TX</StateProvinceCode>  
  <PostalCode>78703</PostalCode>  
  <EffectiveDate/>  
  <ExpirationDate/>  
  <AttentionLine/>  
  <NoteMessage/>  
</Address>
```

Code illustration 2 (International Address):

```
<Address>  
  <AddressLine>Altova Corporation</AddressLine>  
  <AddressLine>Rudolfsplatz 13a/9</AddressLine>  
  <City>Wien</City>  
  <StateProvince/>  
  <PostalCode>A-1010</PostalCode>  
  <CountryCode>AT</CountryCode>  
  <EffectiveDate/>  
  <ExpirationDate/>  
  <AttentionLine/>  
  <NoteMessage/>  
</Address>
```

PESC XML Application for Admission Implementation Guide Version 1.3.0

Applicant.Person.Immigration.Sponsor.SponsorOrganization.Contacts. Email

Note: Although the complex data element *Email* is an optional data element, if you choose to send the *Email Address* for the sponsor of the international applicant, then you must send the data element *EmailAddress*.

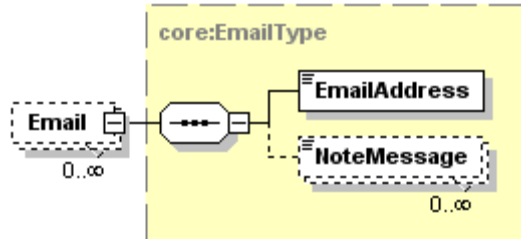

Tag Name	Schema Use	Description	Recommended Use	Format
EmailAddress	Required	The numbers, letters, and symbols used to identify an electronic mail (Email) user within a network.	Required	minOcc 1 maxOc 1 minLength 1 maxLength 128
NoteMessage	Optional Repeatable	Additional information about the email address of the sponsoring organization	Not recommended	minOcc 0 maxOcc ∞ minLength 1 maxLength 80

Code illustration:

```
<Email>
  <EmailAddress>adrianafarella@aol.com</EmailAddress>
  <NoteMessage/>
</Email>
```

PESC XML Application for Admission Implementation Guide Version 1.3.0

Applicant.Person.Immigration.Sponsor.SponsorOrganization.Contacts. Phone

Note: Although the complex data element Phone, is an optional data element, if you choose to send the Phone of a Contact at the sponsoring Company, Agency or Institution, then you must send a phone number.

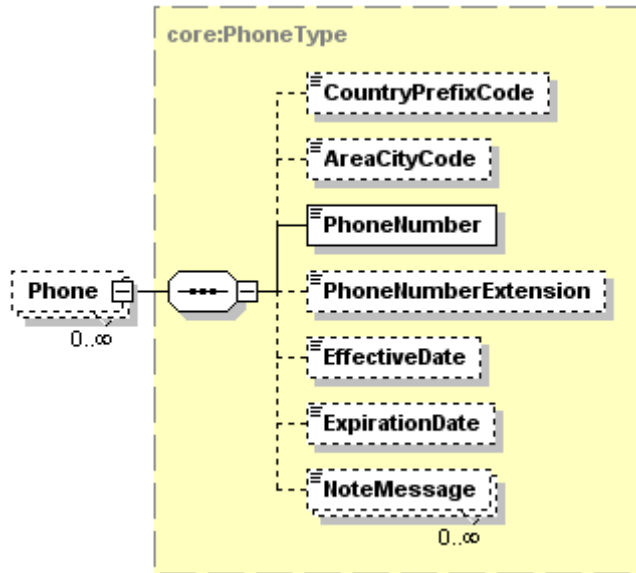

Tag Name	Schema Use	Description	Recommended Use	Format
CountryPrefixCode	Optional	International dialing code	Recommended	minOcc 0 maxOcc 1 minLength 1 maxLength 3
AreaCityCode	Optional	Regional dialing code	Recommended	minOcc 0 maxOcc 1 minLength 1 maxLength 5
PhoneNumber	Required	Telephone number	Required	minOcc 1 maxOcc 1 minLength 1 maxLength 11
Comment: The phone number will typically be sent as a string of numbers with no spaces, periods nor dashes.				
PhoneNumberExtension	Optional	The extended telephone addressing information used in addition to phone number such as a PBX extension, a pager PIN, or FAX sub-address	Optional	minOcc 0 maxOcc 1 minLength 1 maxLength 5
EffectiveDate	Optional	The date on which the phone number became (or will become) effective	Optional	minOcc 0 maxOcc 1 Date format: CCYY-MM-DD
ExpirationDate	Optional	The date on which the phone number will (or did) expire	Optional	minOcc 0 maxOcc 1 Date format: CCYY-MM-DD
NoteMessage	Optional Repeatable	Additional information about the phone numbers of the contacts at the source school	Not recommended	minOcc 0 maxOcc ∞ minLength 1 maxLength 80

PESC XML Application for Admission Implementation Guide Version 1.3.0

Applicant.Person.Immigration.Sponsor.SponsorOrganization.Contacts. Phone (Continued)

Code illustration:

```
<Phone>
  <CountryPrefixCode/>
  <AreaCityCode>512</AreaCityCode>
  <PhoneNumber>4142505</PhoneNumber>
  <PhoneNumberExtension/>
  <EffectiveDate/>
  <ExpirationDate/>
  <NoteMessage/>
</Phone>

<Phone>
  <CountryPrefixCode/>
  <AreaCityCode>512</AreaCityCode>
  <PhoneNumber>4747935</PhoneNumber>
  <PhoneNumberExtension/>
  <EffectiveDate/>
  <ExpirationDate/>
  <NoteMessage/>
</Phone>
```

PESC XML Application for Admission Implementation Guide Version 1.3.0

Applicant.Person.Immigration.Sponsor.SponsorOrganization.Contacts. URL

Note: Although the complex data element URL is an optional data element, if you choose to send the URL of the Sponsor of the international applicant, then you must send the URLAddress.

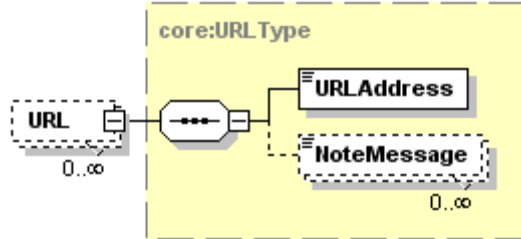

Tag Name	Schema Use	Description	Recommended Use	Format
URLAddress	Required	The Uniform Resource Locator (URL) address of the sponsor of the international applicant	Required	minOcc 1 maxOcc 1 minLength 1 maxLength 512
NoteMessage	Optional Repeatable	Additional information about the URL address of the sponsor of the international applicant	Not recommended	minOcc 0 maxOcc ∞ minLength 1 maxLength 80

Code illustration:

```
<URL>
  <URLAddress>www.Xap.com</URLAddress>
  <NoteMessage/>
</URL>
```

PESC XML Application for Admission Implementation Guide Version 1.3.0

Applicant.Person.Immigration.Sponsor.FundingSource

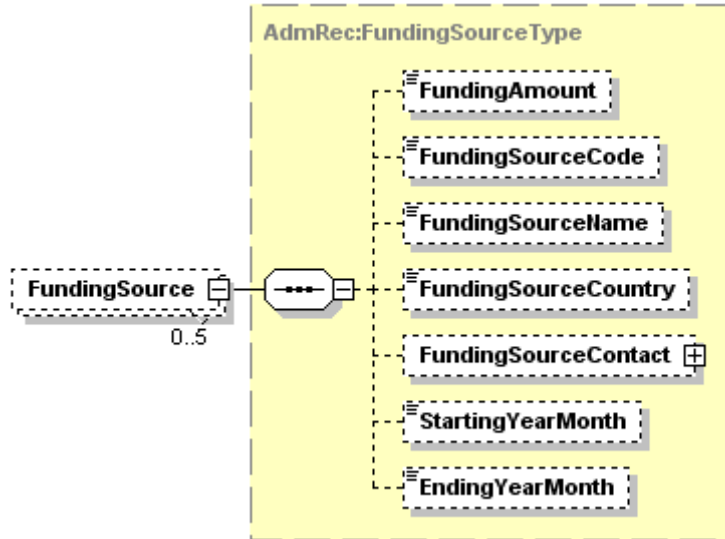

Tag Name	Schema Use	Description	Recommended Use	Format
FundingAmount	Optional	The amount of funding being provided in the currency of the host country where the school is located	Recommended	minOcc 0 maxOcc 1 Format is an integer
FundingSourceCode	Optional	This is the coded type of the source of the funds for the International Applicant	Recommended	minOcc 0 maxOcc 1 Enumerations: BiNationalCommission Employment ExchangeVisitorGovernment InternationalOrganization Other Personal ProgramSponsorFunds School USGovernmentFunds
FundingSourceName	Optional	This is the name of the funding source	Optional	minOcc 0 maxOcc 1 minLength 0 maxLength 60
FundingSourceCountry	Optional	The Country where the funds are located	Optional	minOcc 0 maxOcc 1 See ISO Country List in Appendix B
FundingSourceContact	Optional	Contact information for the source of funds for the international applicant	Optional	minOcc 0 maxOcc 1
Comment: Additional information about this complex data element will be shown on page 149.				
StartingYearMonth	Optional	The starting date when funding from this source is anticipated	Optional	minOcc 0 maxOcc 1 Format will be date with specific format of CCYY-MM
EndingYearMonth	Optional	The ending date when funding from this source is anticipated	Optional	minOcc 0 maxOcc 1 Format will be date with specific format of CCYY-MM

PESC XML Application for Admission Implementation Guide Version 1.3.0

Applicant.Person.Immigration.Sponsor.FundingSource (Continued)

Code illustration:

```
<FundingSource>  
  <FundingAmount>2300</FundingAmount>  
  <FundingSourceCode>ProgramSponsorFunds</FundingSourceCode>  
  <FundingSourceName>My Benefactor</FundingSourceName>  
  <FundingSourceCountry>BR</FundingSourceCountry>  
  <FundingSourceContact>  
  
    </FundingSourceContact>  
  <StartingYearMonth>2008-05</StartingYearMonth>  
  <EndingYearMonth>2010-04</EndingYearMonth>  
</FundingSource>
```

PESC XML Application for Admission Implementation Guide Version 1.3.0

Applicant.Person.Immigration.Sponsor.FundingSource. FundingSourceContact

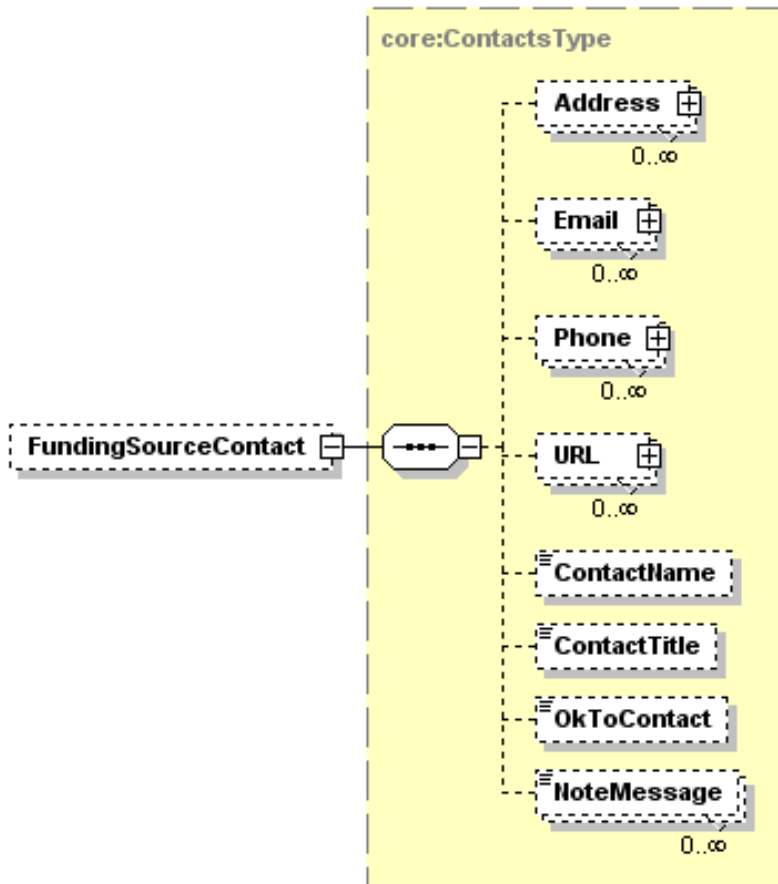

Tag Name	Schema Use	Description	Recommended Use	Format
Address	Optional Repeating	This is a combined Address Group for a choice between Domestic or International	Optional	minOcc 0 maxOcc ∞
Comment: Additional information about the complex data element Address will be shown on page 151. This is the address of the company, agency or institution that is the funding source of this international applicant for admission.				
Email	Optional Repeating	Email address of sponsoring company, agency, vendor or institution contact	Recommended	minOcc 0 maxOcc ∞
Comment: Additional information about the complex data element Email will be shown on page 154.				
Phone	Optional Repeating	Phone number of funding source	Recommended	minOcc 0 maxOcc ∞
Comment: Additional information about the complex data element Phone will be shown on page 155.				

PESC XML Application for Admission Implementation Guide

Version 1.3.0

Tag Name	Schema Use	Description	Recommended Use	Format
URL	Optional Repeatable	The Uniform Resource Locator of the funding source	Optional	minOcc 0 maxOcc ∞
Comment: Additional information about the complex data element URL for the source of this application for admission will be shown on page 157.				
ContactName	Optional	The name of the contact at the sponsoring organization	Optional	minOcc 0 maxOcc 1 minLength 0 maxLength 60
ContactTitle	Optional	The job title of the funding source contact	Optional	minOcc 0 maxOcc 1 minLength 0 maxLength 60
OkToContact	Optional	The permission from the applicant to contact the funding source	Optional	minOcc 0 maxOcc 1 Enumerations: No Yes
NoteMessage	Optional Repeatable	Additional information about the contacts at the sponsor company, agency or vendor	Not recommended	minOcc 0 maxOcc ∞ minLength 1 maxLength 80
Comment: This is contact information included by the funding source to indicate the preferred means for the school to use to contact it in case there is a need for further communication.				

Code illustration:

```

<FundingSourceContact>
  <Address>
    </Address>
  <Email>
    </Email>
  <Phone>
    </Phone>
  <URL>
    </URL>
  <ContactName>Mr. Moneybags</ContactName>
  <ContactTitle>Bursar</ContactTitle>
  <OkToContact>Yes</OkToContact>
  <NoteMessage/>
</FundingSourceContact>

```

PESC XML Application for Admission Implementation Guide Version 1.3.0

Applicant.Person.Immigration.Sponsor.FundingSource. FundingSourceContact.Address

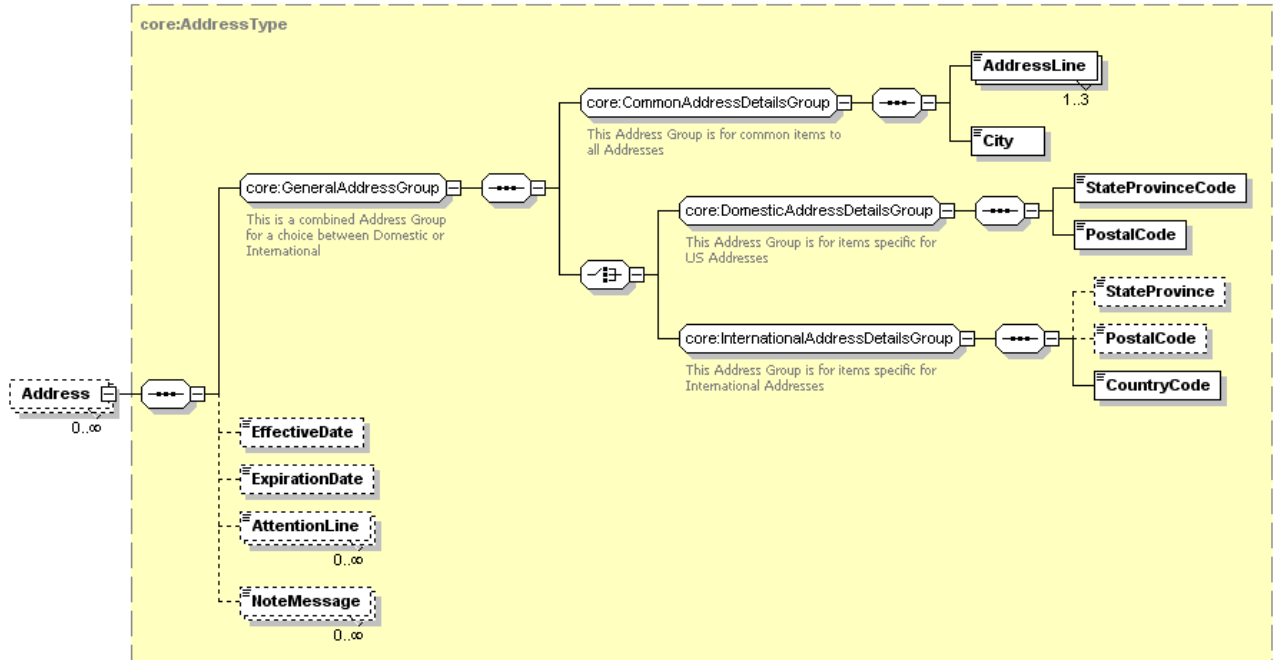

Tag Name	Schema Use	Description	Recommended Use	Format
<i>GeneralAddressGroup</i>	Required	This Address Group is for items common to all Addresses	Required	minOcc 1 maxOcc 1
Comment: [<i>GeneralAddressGroup</i>] does not appear in the instance document. It requires the use of <i>CommonAddressDetailsGroup</i> and the choice of one of either <i>DomesticAddressDetailsGroup</i> or <i>InternationalAddressDetailsGroup</i> . This group is required in the schema only if you choose to send the address of the contact at the funding source.				
<i>CommonAddressDetailsGroup</i>	Required	This Address Group is for items common to all Addresses	Required	minOcc 1 maxOcc 1
Comment: [<i>CommonAddressDetailsGroup</i>] does not appear in the instance document. If the address of a contact is included in the Application for Admission, then this must be sent. It is required and must be paired with one of either <i>DomesticAddressDetailsGroup</i> or <i>InternationalAddressDetailsGroup</i> .				
AddressLine	Required Repeatable	Local delivery information such as street, building number, PO box, or apartment portion of a postal address of a Contact at the funding source	Required	minOcc 1 maxOcc 3 minLength 1 maxLength 40
City	Required	The city portion of the Address of a Contact at the funding source	Required	minOcc 1 maxOcc 1 minLength 2 maxLength 30

PESC XML Application for Admission Implementation Guide

Version 1.3.0

Tag Name	Schema Use	Description	Recommended Use	Format
<i>DomesticAddressDetailsGroup</i>	Required choice	This Address Group is for items specific for US and Canadian Addresses	Required for domestic addresses	minOcc 1 maxOcc 1
Comment: [<i>DomesticAddressDetailsGroup</i>] does not appear in the instance document. If the complex data element address has a United States or Canadian Postal Code and a US State or Canadian Province Code, then this should be the required choice.				
StateProvinceCode	Required	Code for US states, etc., and Canadian provinces	Required	minOcc 1 maxOcc 1 Enumeration: See Appendix A
PostalCode	Required	The postal code portion of the Address.	Required	minOcc 1 maxOcc 1 minLength 1 maxLength 17
<i>InternationalAddressDetailsGroup</i>	Required choice	This Address Group is for items specific for International Addresses	Required for international addresses	minOcc 1 maxOcc 1
Comment: [<i>InternationalAddressDetailsGroup</i>] does not appear in the instance document. This choice is for addresses that do not have a US or Canadian postal code.				
StateProvince	Optional	The literal name of the state, province or territory of a postal address of the sponsor of the international applicant. Use for addresses outside US or Canada.	Recommended Refer to common postal practices of the source country	minOcc 0 maxOcc 1 minLength 2 maxLength 30
Comment: For an internet resource of states or other geographical subdivisions in countries other than the US and Canada, you might choose to refer to the website of the Universal Postal Union at http://www.upu.int				
PostalCode	Optional	The postal code portion of the Address.	Recommended Refer to common postal practices of the source country	minOcc 0 maxOcc 1 minLength 1 maxLength 17
Comment: For an internet resource of states or other geographical subdivisions in countries other than the US and Canada, you might choose to refer to the website of the Universal Postal Union at http://www.upu.int				
CountryCode	Required	Code indicating Country. Use ISO 3166-1 alpha-2 standard.	Required for international addresses	minOcc 1 maxOcc 1 Enumerations: See Appendix B1 or B2
EffectiveDate	Optional	The date on which the address became (or will become) effective	Not Recommended	minOcc 0 maxOcc 1 Date format: CCYY-MM-DD
ExpirationDate	Optional	The date on which the address will (or did) expire	Not Recommended	minOcc 0 maxOcc 1 Date format: CCYY-MM-DD
AttentionLine	Optional	The individual or office name within the postal address where inquiries should be directed.	Not Recommended	minOcc 0 maxOcc ∞ minLength 1 maxLength 45
NoteMessage	Optional Repeatable	Additional information about the addresses of the applicant	Not recommended	minOcc 0 maxOcc ∞ minLength 1 maxLength 80

PESC XML Application for Admission Implementation Guide Version 1.3.0

Applicant.Person.Immigration.Sponsor.FundingSource. FundingSourceContact.Address (Continued)

Code illustration 1 (Domestic Address):

```
<Address>  
  <AddressLine>1715 W Cesar Chavez</AddressLine>  
  <City>Austin</City>  
  <StateProvinceCode>TX</StateProvinceCode>  
  <PostalCode>78703</PostalCode>  
  <EffectiveDate/>  
  <ExpirationDate/>  
  <AttentionLine/>  
  <NoteMessage/>  
</Address>
```

Code illustration 2 (International Address):

```
<Address>  
  <AddressLine>Altova Corporation</AddressLine>  
  <AddressLine>Rudolfsplatz 13a/9</AddressLine>  
  <City>Wien</City>  
  <StateProvince/>  
  <PostalCode>A-1010</PostalCode>  
  <CountryCode>AT</CountryCode>  
  <EffectiveDate/>  
  <ExpirationDate/>  
  <AttentionLine/>  
  <NoteMessage/>  
</Address>
```

PESC XML Application for Admission Implementation Guide Version 1.3.0

Applicant.Person.Immigration.Sponsor.FundingSource. FundingSourceContact.Email

Note: Although the complex data element *Email* is an optional data element, if you choose to send the *Email Address* for the sponsor of the international applicant, then you must send the data element *EmailAddress*.

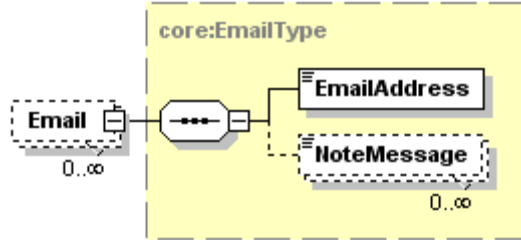

Tag Name	Schema Use	Description	Recommended Use	Format
EmailAddress	Required	The numbers, letters, and symbols used to identify an electronic mail (Email) user within a network.	Required	minOcc 1 maxOc 1 minLength 1 maxLength 128
NoteMessage	Optional Repeatable	Additional information about the addresses of the applicant	Not recommended	minOcc 0 maxOcc ∞ minLength 1 maxLength 80

Code illustration:

```
<Email>
  <EmailAddress>adrianafarella@aol.com</EmailAddress>
  <NoteMessage/>
</Email>
```

PESC XML Application for Admission Implementation Guide Version 1.3.0

Applicant.Person.Immigration.Sponsor.FundingSource. FundingSourceContact.Phone

Note: Although the complex data element Phone is an optional data element, if you choose to send the Phone of a Contact at the funding source, then you must send a phone number.

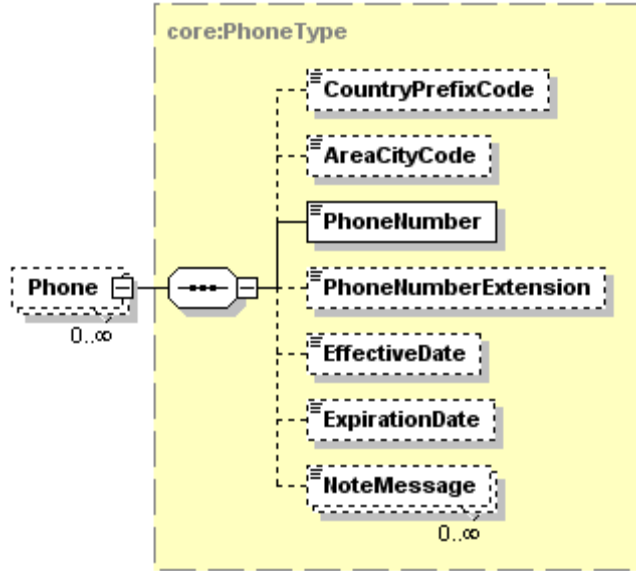

Tag Name	Schema Use	Description	Recommended Use	Format
CountryPrefixCode	Optional	International dialing code	Recommended	minOcc 0 maxOcc 1 minLength 1 maxLength 3
AreaCityCode	Optional	Regional dialing code	Recommended	minOcc 0 maxOcc 1 minLength 1 maxLength 5
PhoneNumber	Required	Telephone number	Required	minOcc 1 maxOcc 1 minLength 1 maxLength 11
Comment: The phone number will typically be sent as a string of numbers with no spaces, periods nor dashes.				
PhoneNumberExtension	Optional	The extended telephone addressing information used in addition to phone number such as a PBX extension, a pager PIN, or FAX sub-address	Optional	minOcc 0 maxOcc 1 minLength 1 maxLength 5
EffectiveDate	Optional	The date on which the phone number became (or will become) effective	Optional	minOcc 0 maxOcc 1 Date format: CCYY-MM-DD
ExpirationDate	Optional	The date on which the phone number will (or did) expire	Optional	minOcc 0 maxOcc 1 Date format: CCYY-MM-DD
NoteMessage	Optional Repeatable	Additional information about the phone numbers of the contacts at the destination school	Not recommended	minOcc 0 maxOcc ∞ minLength 1 maxLength 80

PESC XML Application for Admission Implementation Guide Version 1.3.0

Applicant.Person.Immigration.Sponsor.FundingSource. FundingSourceContact.Phone (Continued)

Code illustration:

```
<Phone>  
  <CountryPrefixCode/>  
  <AreaCityCode>512</AreaCityCode>  
  <PhoneNumber>4142505</PhoneNumber>  
  <PhoneNumberExtension/>  
  <EffectiveDate>2008-06-20</EffectiveDate>  
  <ExpirationDate/>  
  <NoteMessage/>  
</Phone>
```

PESC XML Application for Admission Implementation Guide Version 1.3.0

Applicant.Person.Immigration.Sponsor.FundingSource. FundingSourceContact.URL

Note: Although the complex data element URL is an optional data element, if you choose to send the URL of the funding source for the international applicant, then you must send the URLAddress.

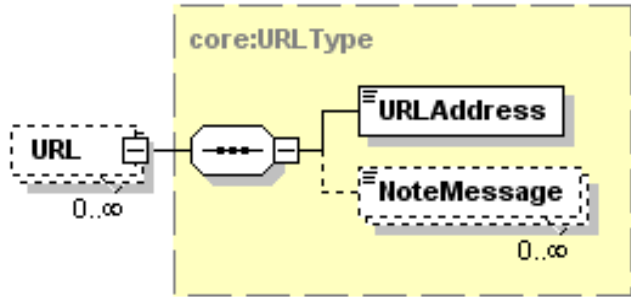

Tag Name	Schema Use	Description	Recommended Use	Format
URLAddress	Required	The Uniform Resource Locator (URL) address of the sponsor of the international applicant	Required	minOcc 1 maxOcc 1 minLength 1 maxLength 512
NoteMessage	Optional Repeatable	Additional information about the URL address of the sponsor of the international applicant	Not recommended	minOcc 0 maxOcc ∞ minLength 1 maxLength 80

Code illustration:

```

<URL>
  <URLAddress>www.Xap.com</URLAddress>
  <NoteMessage/>
</URL>
  
```

PESC XML Application for Admission Implementation Guide Version 1.3.0

Applicant.Person.Immigration.Sponsor.SponsorPerson

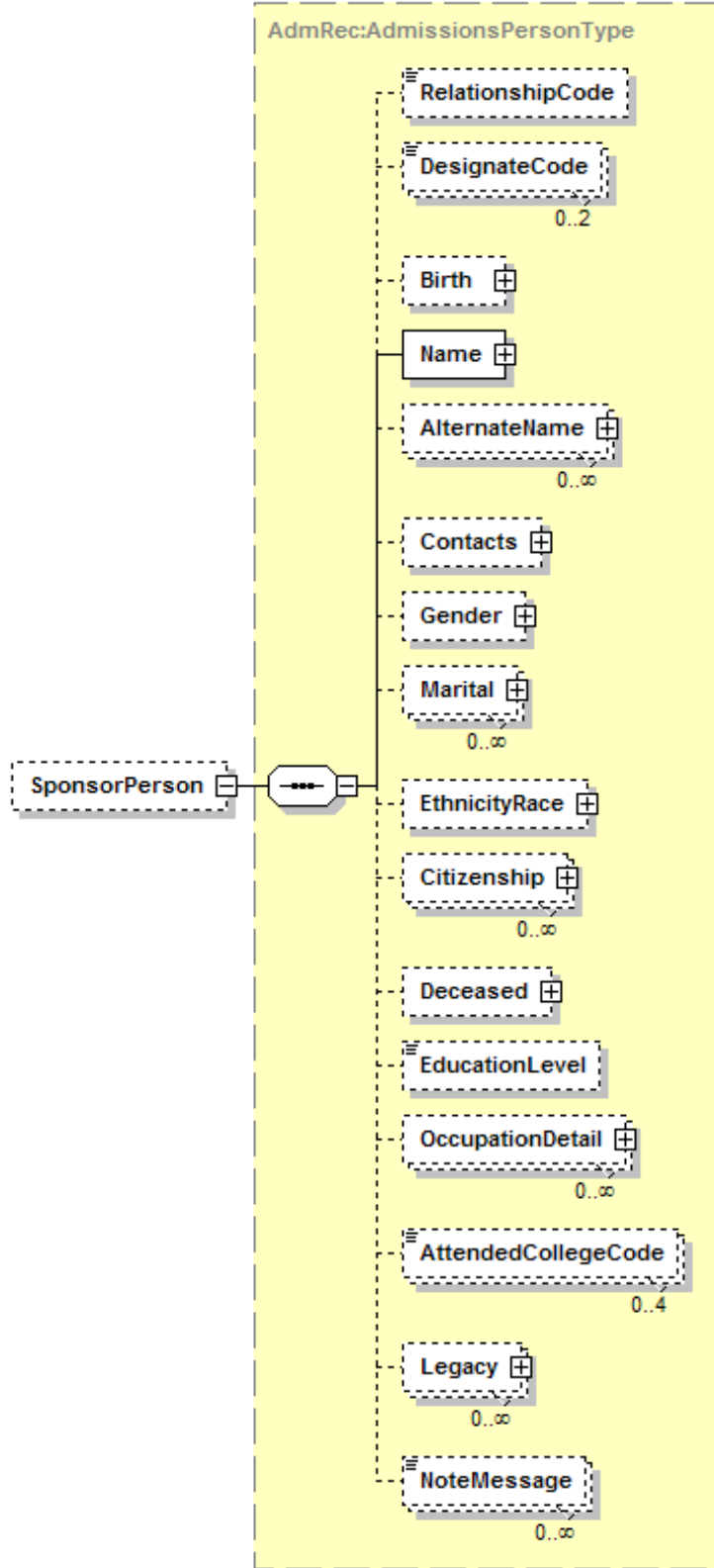

PESC XML Application for Admission Implementation Guide Version 1.3.0

Applicant.Person.Immigration.Sponsor.SponsorPerson (Continued)

Tag Name	Schema Use	Description	Recommended Use	Format
RelationshipCode	Optional	The relationship of the sponsoring person to the international applicant	Recommended	minOcc 0 maxOcc 1 Enumerations: See Appendix D
DesignateCode	Optional Repeatable	A decision made by a person that another specified person would be appointed to act on the person's behalf	Not Recommended	minOcc 0 maxOcc 2 Enumerations: AuthorizedDesignate EmergencyContact
Birth	Optional	Information about the birth of the sponsoring person	Recommended	minOcc 0 maxOcc 1
Comment: Additional information about birth will be shown on page 162.				
Name	Required	The name of the sponsoring person	Required	minOcc 1 maxOcc 1
Comment: Additional information about the sponsoring person's name will be shown on page 164.				
AlternateName	Optional Repeatable	Other names associated with the sponsor person	Recommended	minOcc 0 maxOcc ∞
Comment: Additional information about the sponsoring person's alternate name will be shown on page 166.				
Contacts	Optional Repeatable	Information about how the sponsoring person may be contacted	Recommended	minOcc 0 maxOcc ∞
Comment: Additional information about contacts will be shown on page 167. This includes multiple addresses, phone numbers, emails, URLs, faxes, etc. It is recommended that only one iteration of Contacts be included in the instance document.				
Gender	Optional	The sex or gender of the sponsoring person	Recommended	minOcc 0 maxOcc 1
Comment: Additional information about gender will be shown on page 177.				
Marital	Optional Repeatable	Information about the marital status of the sponsor	Not Recommended	minOcc 0 maxOcc ∞
EthnicityRace	Optional	The ethnicity and/or race information provided by the applicant for the sponsoring person in the new format	Not Recommended	minOcc 0 maxOcc 1
Citizenship	Optional Repeatable	Information about the citizenship of the person sponsoring the international applicant	Recommended	minOcc 0 maxOcc ∞
Comment: Additional information about this complex data element will be shown on page 178.				
Deceased	Optional	This is information provided that indicates that the sponsoring person is deceased	Optional	minOcc 0 maxOcc 1
Comment: Additional information about the deceased status of the sponsoring person will be shown on page 179. In the context of an admissions application, it would be unusual to have such information available. However, if the source of funds is from an estate of a deceased person, it is possible.				

PESC XML Application for Admission Implementation Guide

Version 1.3.0

Tag Name	Schema Use	Description	Recommended Use	Format
EducationLevel	Optional	Information about the education level of the person sponsoring the international applicant	Not Recommended	minOcc 0 maxOcc 1 Enumerations: AssociateDegree BaccalaureateDegree CollegeAttended CollegeCertificate CollegeDiploma DoctoralDegree Elementary FourYearCollegeGraduate HighSchoolAttended HighSchoolGraduate JuniorHighSchool MastersDegree MiddleSchool NoHighSchool None PostGraduateStudy ProfessionalAttended ProfessionalCertification ProfessionalDegree SecondarySchool TwoYearCollegeGraduate VocationalSchool
OccupationDetail	Optional Repeatable	The current occupation or profession of the sponsoring person	Optional	minOcc 0 maxOcc ∞
Comment: Additional information about this complex data element will be shown on page 180.				
AttendedCollegeCode	Optional Repeatable	Information about which close relatives have enrolled in a postsecondary school	Not Recommended	minOcc 0 maxOcc 4 Enumerations: EitherParent GrandParent Siblings Spouse
Legacy	Optional Repeatable	Legacy information about the sponsor person	Not recommended	minOcc 0 maxOcc ∞
NoteMessage	Optional Repeatable	Additional information about the Sponsoring Person	Not recommended	minOcc 0 maxOcc ∞ minLength 1 maxLength 80
Comment: Because note information is not normally coded, it cannot be automatically processed by a computer. Therefore, its use in an XML application for admission is discouraged. However, if there is a prior agreement between the sender and the recipient, it could be formatted in a previously agreed upon manner between the two parties and therefore might assist in the processing of the application.				

PESC XML Application for Admission Implementation Guide Version 1.3.0

Applicant.Person.Immigration.Sponsor.SponsorPerson (Continued)

Code illustration:

```
<SponsorPerson>
  <RelationshipCode>Sponsor</RelationshipCode>
  <DesignateCode/>
  <Birth>

  </Birth>
  <Name>

  </Name>
  <AlternateName>

  </AlternateName>
  <Contacts>

  </Contacts>
  <Gender>

  </Gender>
  <Marital/>
  <EthnicityRace/>
  <Citizenship>

  </Citizenship>
  <Deceased>

  </Deceased>
  <EducationLevel/>
  <OccupationDetail>

  </OccupationDetail>
  <AttendedCollegeCode/>
  <Legacy/>
  <NoteMessage/>
</SponsorPerson>
```

PESC XML Application for Admission Implementation Guide Version 1.3.0

Applicant.Person.Immigration.Sponsor.SponsorPerson.Birth

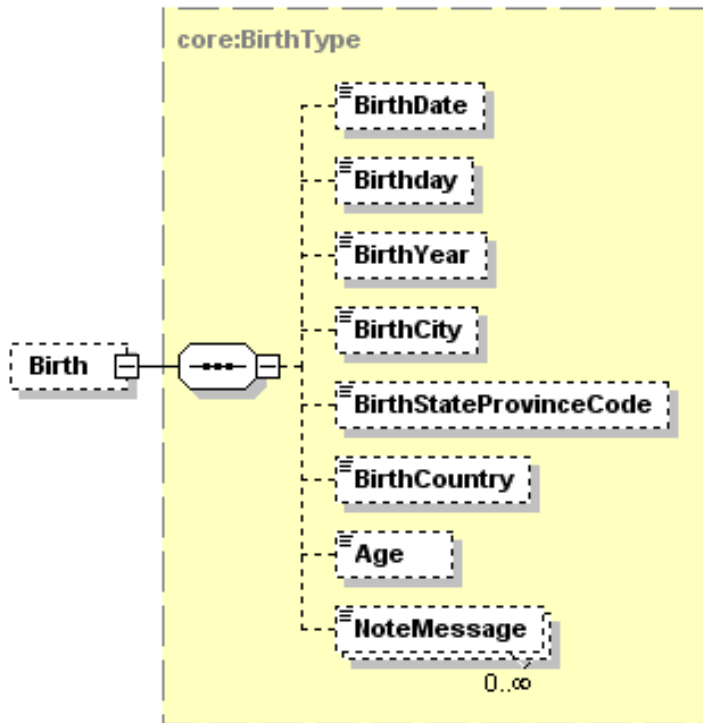

Tag Name	Schema Use	Description	Recommended Use	Format
BirthDate	Optional	Date of Birth	Recommended	minOcc 0 maxOcc 1 xs:date Format is ccyy-mm-dd
Birthday	Optional	Month and Day of Birth	Not Recommended	minOcc 0 maxOcc 1 xs:gMonthDay Format is --mm-dd
BirthYear	Optional	Year of Birth	Optional	minOcc 0 maxOcc 1 xs:gYear Format is CCYY
BirthCity	Optional	The city in which the sponsoring person was born	Optional	minOcc 0 maxOcc 1 minLength 1 maxLength 25
BirthStateProvinceCode	Optional	The state or province in which the sponsoring person was born	Optional	minOcc 0 maxOcc 1 Enumerations: See code set of states and provinces in Appendix A
BirthCountry	Optional	The country in which the sponsoring person was born	Recommended	minOcc 0 maxOcc 1 Enumerations: See code set of countries

PESC XML Application for Admission Implementation Guide Version 1.3.0

Tag Name	Schema Use	Description	Recommended Use	Format
Age	Optional	The age of the person	Not Recommended	minOcc 0 maxOcc 1 Format is positive integer
NoteMessage	Optional Repeatable	Additional information about Birth	Not Recommended	minOcc 0 maxOcc ∞ minLength 1 maxLength 80

Code illustration:

```

<Birth>
  <BirthDate>1970-02-04</BirthDate>
  <Birthday/>
  >BirthYear/>
  <BirthCity>Chicago</BirthCity>
  <BirthStateProvinceCode>IL</BirthStateProvinceCode>
  <BirthCountry>US</BirthCountry>
  <Age/>
  <NoteMessage/>
</Birth>

```

PESC XML Application for Admission Implementation Guide Version 1.3.0

Applicant.Person.Immigration.Sponsor.SponsorPerson.Name

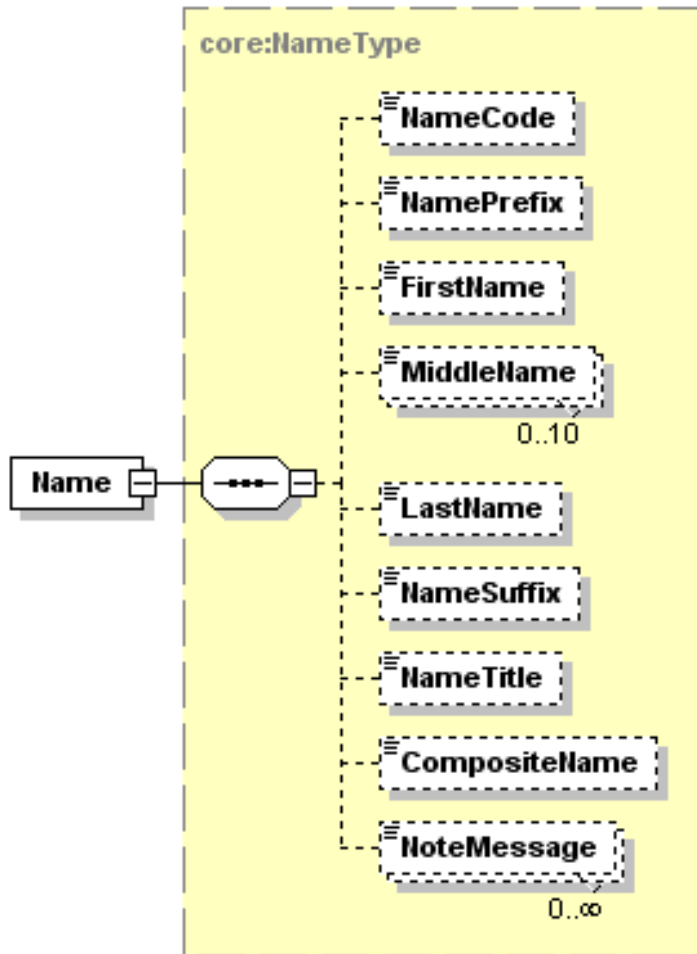

Tag Name	Schema Use	Description	Recommended Use	Format
NameCode	Optional	A code that indicates the type of alternate name that is being described	Recommended	minOcc 0 maxOcc 1 Enumerations: Casual Formal Former LawSchoolApplication Source Legal MedicalSchoolApplicat ion Source Nickname Other
NamePrefix	Optional	An honorific, title or form of address that precedes the name.	Not Recommended	minOcc 0 maxOcc 1 minLength 1 maxLength 30
Comment: <i>The honorific includes such data as "Dr.", "Professor", "Miss", etc. The Workgroup felt that it could do more harm than good to include this information and make it available to the school.</i>				
FirstName	Optional	The first name of the person, usually given at birth, baptism, or during, another ceremony, or through legal change	Recommended	minOcc 0 maxOcc 1 minLength 1 maxLength 35

PESC XML Application for Admission Implementation Guide Version 1.3.0

Tag Name	Schema Use	Description	Recommended Use	Format
MiddleName	Optional Repeatable	A secondary name of the person, usually given at birth, baptism, or during another naming ceremony or through legal change	Recommended	minOcc 0 maxOcc 10 minLength 1 maxLength 35
LastName	Optional	The last name or surname by which a person is legally known	Optional	minOcc 0 maxOcc 1 minLength 1 maxLength 35
NameSuffix	Optional	The expression of an individual's generation within a family.	Recommended	minOcc 0 maxOcc 1 Enumerations: I II III IV V VI VII VIII IX X JR SR
NameTitle	Optional	An honorific, title or credential that follows the name.	Not Recommended	minOcc 0 maxOcc 1 minLength 1 maxLength 30
CompositeName	Optional	The full name of the person in Last Name (space) Suffix (comma) First Name (space) Middle Names (spaces). A comma would be included after last name or NameSuffix	Not Recommended	minOcc 0 maxOcc 1 minLength 1 maxLength 45
NoteMessage	Optional Repeatable	Additional information about the family member's name	Not Recommended	minOcc 0 maxOcc ∞ minLength 1 maxLength 80

Code illustration:

```

<Name>
  <NameCode>Formal</NameCode>
  <NamePrefix>
  <FirstName>John</FirstName>
  <MiddleName>Billy</MiddleName>
  <MiddleName>Bob</MiddleName>
  <LastName>Thornton</LastName>
  <NameSuffix>JR</NameSuffix>
  <NameTitle/>
  <CompositeName/>
  <NoteMessage/>
</Name>

```

PESC XML Application for Admission Implementation Guide Version 1.3.0

Applicant.Person.Immigration.Sponsor.SponsorPerson.AlternateName

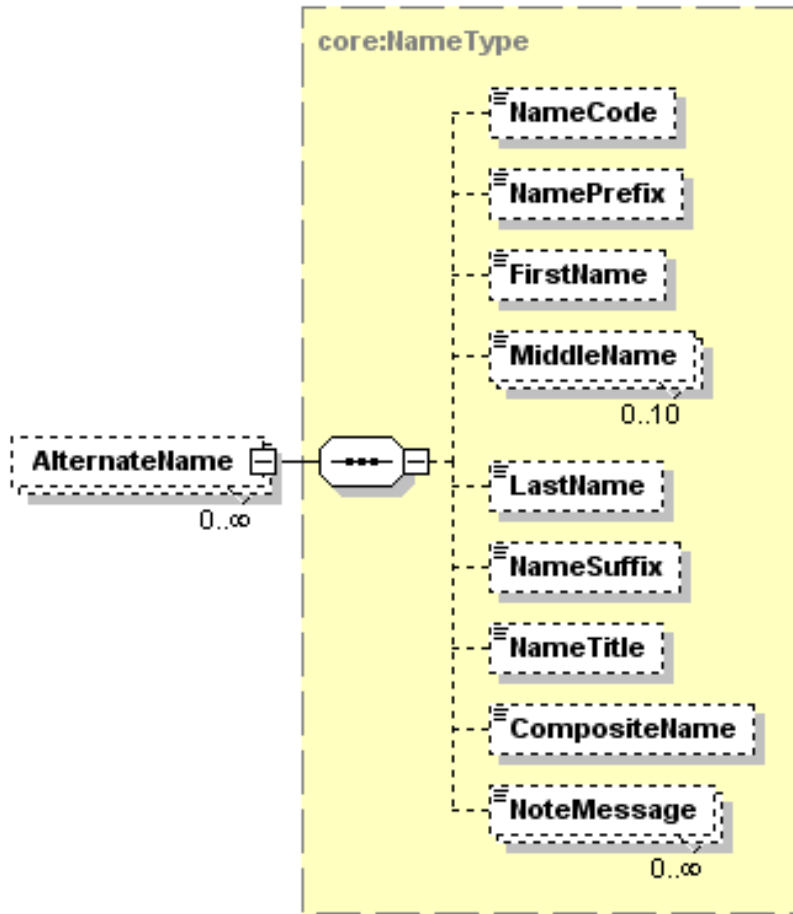

Tag Name	Schema Use	Description	Recommended Use	Format
NameCode	Optional	A code that indicates the type of alternate name that is being described	Recommended	minOcc 0 maxOcc 1 Enumerations: Casual Formal Former LawSchoolApplicationSource Legal MedicalSchoolApplicationSource Nickname Other
NamePrefix	Optional	An honorific, title or form of address that precedes the name.	Not Recommended	minOcc 0 maxOcc 1 minLength 1 maxLength 30
FirstName	Optional	The first name of the person, usually given at birth, baptism, or during, another ceremony, or through legal change	Recommended	minOcc 0 maxOcc 1 minLength 1 maxLength 35

PESC XML Application for Admission Implementation Guide

Version 1.3.0

Tag Name	Schema Use	Description	Recommended Use	Format
MiddleName	Optional Repeatable	A secondary Name of the person, usually given at birth, baptism, or during another naming ceremony or through legal change	Recommended	minOcc 0 maxOcc 10 minLength 1 maxLength 35
LastName	Optional	The last name or surname by which a person is legally known	Recommended	minOcc 1 maxOcc 1 minLength 1 maxLength 35
NameSuffix	Optional	The expression of an individual's generation within a family.	Recommended	minOcc 0 maxOcc 1 Enumerations: I II III IV V VI VII VIII IX X JR SR
NameTitle	Optional	An honorific, title or credential that follows the name.	Not Recommended	minOcc 0 maxOcc 1 minLength 1 maxLength 30
CompositeName	Optional	The full name of the person in Last, First Middle order, comma after last name	Not Recommended	minOcc 0 maxOcc 1 minLength 1 maxLength 45
Comment: The use of the composite format for student name is discouraged. It is much easier for the receiving school to process the individual name parts into its data base than to process a composite name. This data element is scheduled to be deleted in a future release of the standard.				
NoteMessage	Optional Repeatable	Additional information about the alternate name	Not Recommended	minOcc 0 maxOcc ∞ minLength 1 maxLength 80
Comment: Alternate names may include former names, nicknames, or other names by which the student may now be (or have been) known.				

Code illustration:

```

<AlternateName>
  <NameCode>Nickname</NameCode>
  <NamePrefix/>
  <FirstName>Test</FirstName>
  <MiddleName>Record</MiddleName>
  <MiddleName>Test</MiddleName>
  <LastName>Speede</LastName>
  <NameSuffix/>
  <NameTitle/>
  <CompositeName/>
  <NoteMessage/>
</AlternateName>

```

PESC XML Application for Admission Implementation Guide Version 1.3.0

Applicant.Person.Immigration.Sponsor.SponsorPerson.Contacts

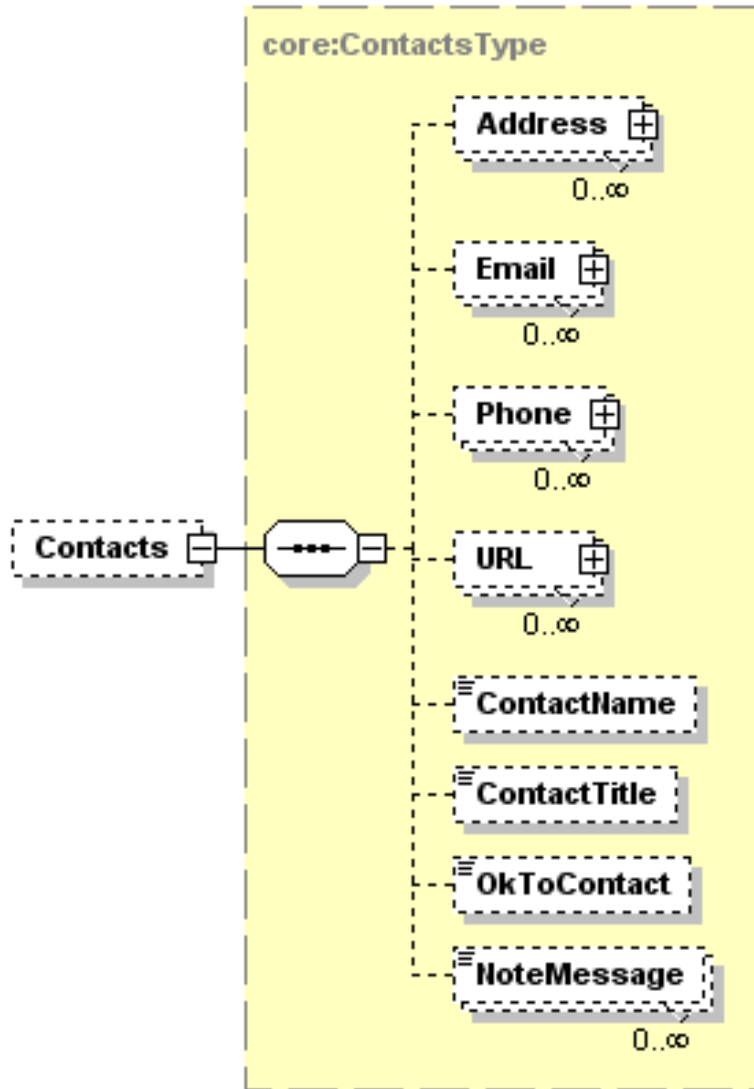

Tag Name	Schema Use	Description	Recommended Use	Format
Address	Optional Repeatable	This is a combined Address Group for a choice between Domestic or International	Recommended	minOcc 0 maxOcc ∞
Comment: Additional information about the complex data element Address for the SponsorPerson will be shown on page 170.				
Email	Optional Repeatable	Email address(es) for the sponsoring person	Recommended	minOcc 0 maxOcc ∞
Comment: Additional information about the complex data element Email will be shown on page 173.				
Phone	Optional Repeatable	Phone number(s) for the sponsoring person	Recommended	minOcc 0 maxOcc ∞
Comment: Additional information about the complex data element Phone will be shown on page 174.				

PESC XML Application for Admission Implementation Guide

Version 1.3.0

Tag Name	Schema Use	Description	Recommended Use	Format
URL	Optional Repeatable	Personal URL(s) for the sponsoring person	Optional	minOcc 0 maxOcc ∞
Comment: Additional information about the complex data element URL will be shown on page 176.				
ContactName	Optional	The name of the contact that is sponsoring the international applicant	Optional	minOcc 0 maxOcc 1 minLength 0 maxLength 60
ContactTitle	Optional	This is the job or position title of the contact	Optional	minOcc 0 maxOcc ∞ minLength 0 maxLength 60
OkToContact	Optional	An indicator that it is OK to contact this person	Optional	minOcc 0 maxOcc 1 Enumerations: No Yes
NoteMessage	Optional Repeatable	Additional information about the contacts for the sponsoring person	Not Recommended	minOcc 0 maxOcc ∞ minLength 1 maxLength 80

Code illustration:

```

<Contacts>
  <Address>
    </Address>
  <Email>
    </Email>
  <Phone>
    </Phone>
  <URL>
    </URL>
  <ContactName>Mr. Sugar Daddy</ContactName>
  <ContactTitle>The Boss</ContactTitle>
  <OkToContact>Yes</OkToContact>
  <NoteMessage/>
</Contacts>

```

PESC XML Application for Admission Implementation Guide Version 1.3.0

Applicant.Person.Immigration.Sponsor.SponsorPerson.Contacts. Address

Note: Although the complex data element Address is an optional data element, if you choose to send the Address of the Sponsoring Person, then you must send AddressLine and City and also StateProvinceCode, and PostalCode OR CountryCode.

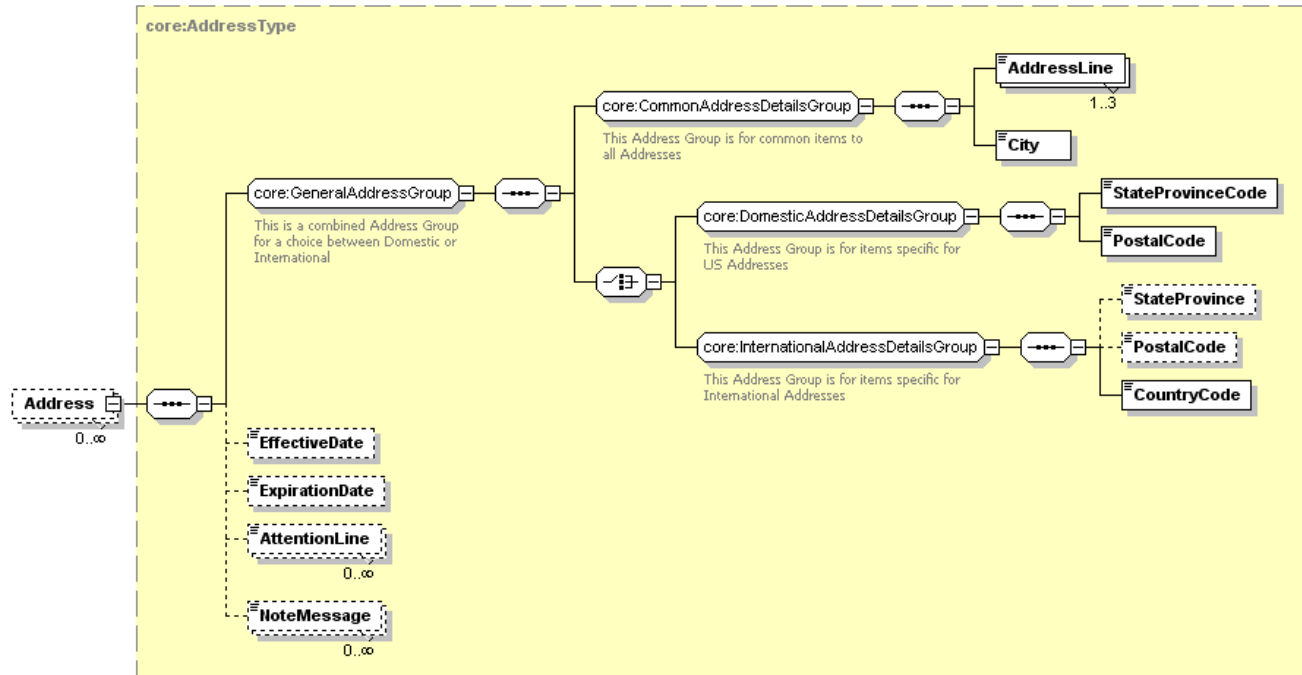

Tag Name	Schema Use	Description	Recommended Use	Format
<i>GeneralAddressGroup</i>	Required	This Address Group is for items common to all Addresses	Required	minOcc 1 maxOcc 1
Comment: [<i>GeneralAddressGroup</i>] does not appear in the instance document. It requires the use of <i>CommonAddressDetailsGroup</i> and the choice of one of either <i>DomesticAddressDetailsGroup</i> or <i>InternationalAddressDetailsGroup</i> . This group is required in the schema only if you choose to send the address of the person sponsoring the applicant.				
<i>CommonAddressDetailsGroup</i>	Required	This Address Group is for items common to all Addresses	Required	minOcc 1 maxOcc 1
Comment: [<i>CommonAddressDetailsGroup</i>] does not appear in the instance document. If the address of the family member is included, then this must be sent. It is required and must be paired with one of either <i>DomesticAddressDetailsGroup</i> or <i>InternationalAddressDetailsGroup</i> .				
AddressLine	Required Repeatable	Local delivery information such as street, building number, PO box, or apartment portion of a postal address of the sponsoring person	Required	minOcc 1 maxOcc 3 minLength 1 maxLength 40
City	Required	The city portion of the Address of the sponsoring person	Required	minOcc 1 maxOcc 1 minLength 2 maxLength 30

PESC XML Application for Admission Implementation Guide

Version 1.3.0

Tag Name	Schema Use	Description	Recommended Use	Format
<i>DomesticAddressDetailsGroup</i>	Required choice	This Address Group is for items specific for US and Canadian Addresses	Required for domestic addresses	minOcc 1 maxOcc 1
Comment: [<i>DomesticAddressDetailsGroup</i>] and does not appear in the instance document. If the complex data element address has a United States or Canadian Postal Code and a US State or Canadian Province Code, then this should be the required choice.				
StateProvinceCode	Required	Code for US states, etc., and Canadian provinces.	Required	minOcc 1 maxOcc 1 Enumeration: See Appendix A
PostalCode	Required	The postal code portion of the Address.	Required	minOcc 1 maxOcc 1 minLength 1 maxLength 17
<i>InternationalAddressDetailsGroup</i>	Required choice	This Address Group is for items specific for International Addresses	Required for international addresses	minOcc 1 maxOcc 1
Comment: [<i>InternationalAddressDetailsGroup</i>] does not appear in the instance document. This choice is for addresses that do not have a US or Canadian postal code.				
StateProvince	Optional	The literal name of the state, province or territory of a postal address of the person sponsoring this international applicant. Use for addresses outside US or Canada.	Recommended Refer to common postal practices of the source country	minOcc 0 maxOcc 1 minLength 2 maxLength 30
Comment: For an internet resource of states or other geographical subdivisions in countries other than the US and Canada, you might choose to refer to the website of the Universal Postal Union at http://www.upu.int				
PostalCode	Optional	The postal code portion of the Address.	Recommended Refer to common postal practices of the source country	minOcc 0 maxOcc 1 minLength 1 maxLength 17
Comment: For an internet resource of states or other geographical subdivisions in countries other than the US and Canada, you might choose to refer to the website of the Universal Postal Union at http://www.upu.int				
CountryCode	Required	Code indicating Country. Use ISO 3166-1 alpha-2 standard.	Required	minOcc 1 maxOcc 1 Enumerations: See Appendix B1 or B2
EffectiveDate	Optional	The date on which the address became (or will become) effective	Optional	minOcc 0 maxOcc 1 Date format: CCYY-MM-DD
ExpirationDate	Optional	The date on which the address will (or did) expire	Optional	minOcc 0 maxOcc 1 Date format: CCYY-MM-DD
AttentionLine	Optional	The individual or office name within the postal address where inquiries should be directed.	Optional	minOcc 0 maxOcc ∞ minLength 1 maxLength 45
NoteMessage	Optional Repeatable	Additional information about the addresses of the contacts at the source school	Not recommended	minOcc 0 maxOcc ∞ minLength 1 maxLength 80

PESC XML Application for Admission Implementation Guide Version 1.3.0

Applicant.Person.Immigration.Sponsor.SponsorPerson.Contacts. Address (Continued)

Code illustration 1 (Domestic Address):

```
<Address>  
  <AddressLine>1715 W Cesar Chavez</AddressLine>  
  <City>Austin</City>  
  <StateProvinceCode>TX</StateProvinceCode>  
  <PostalCode>78703</PostalCode>  
  <EffectiveDate/>  
  <ExpirationDate/>  
  <AttentionLine/>  
  <NoteMessage/>  
</Address>
```

Code illustration 2 (International Address):

```
<Address>  
  <AddressLine>Altova Corporation</AddressLine>  
  <AddressLine>Rudolfsplatz 13a/9</AddressLine>  
  <City>Wien</City>  
  <StateProvince/>  
  <PostalCode>A-1010</PostalCode>  
  <CountryCode>AT</CountryCode>  
  <EffectiveDate/>  
  <ExpirationDate/>  
  <AttentionLine/>  
  <NoteMessage/>  
</Address>
```

PESC XML Application for Admission Implementation Guide Version 1.3.0

Applicant.Person.Immigration.Sponsor.SponsorPerson.Contacts.Email

Note: Although the complex data element Email is an optional data element, if you choose to send the Email of the FamilyMember, then you must send the data element EmailAddress.

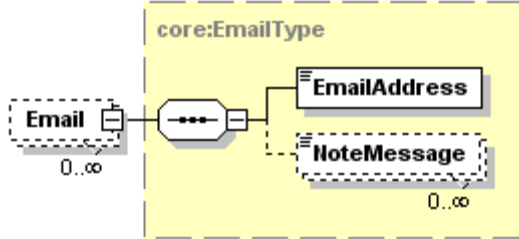

Tag Name	Schema Use	Description	Recommended Use	Format
EmailAddress	Required	The numbers, letters, and symbols used to identify an electronic mail (Email) user within a network.	Required	minOcc 1 maxOcc 1 minLength 1 maxLength 128
NoteMessage	Optional Repeatable	Additional information about the addresses of the contacts at the source school	Not recommended	minOcc 0 maxOcc ∞ minLength 1 maxLength 80

Code illustration:

```
<Email>
  <EmailAddress>stewartj@aol.com</EmailAddress>
  <NoteMessage/>
</Email>
```

PESC XML Application for Admission Implementation Guide Version 1.3.0

Applicant.Person.Immigration.Sponsor.SponsorPerson.Contacts.Phone

Note: Although the complex data element Phone is an optional data element, if you choose to send the Phone of the Sponsoring Person,, then you must send the data element PhoneNumber.

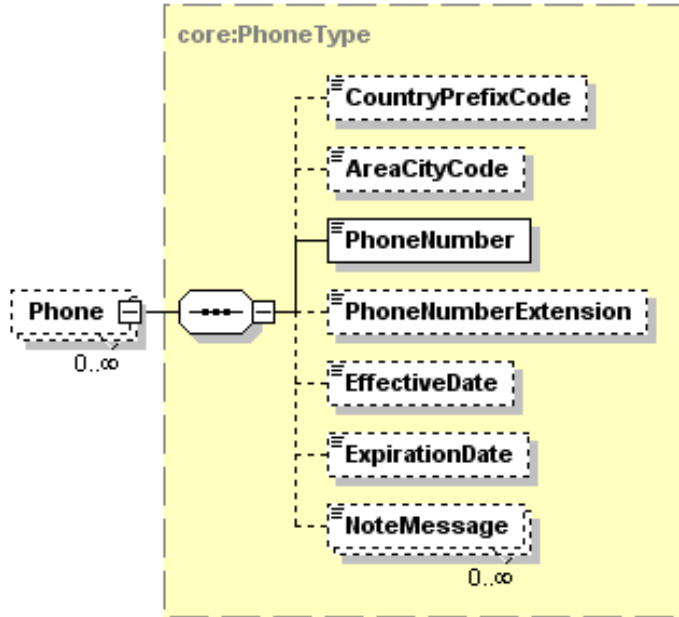

Tag Name	Schema Use	Description	Recommended Use	Format
CountryPrefixCode	Optional	International dialing code.	Optional	minOcc 0 maxOcc 1 minLength 1 maxLength 3
AreaCityCode	Optional	Regional dialing code.	Recommended	minOcc 0 maxOcc 1 minLength 1 maxLength 5
Comment: For phone numbers in the United States and Canada, this is the normal three digit area code.				
PhoneNumber	Required	Telephone number.	Required	minOcc 1 maxOcc 1 minLength 1 maxLength 11
PhoneNumberExtension	Optional	The extended telephone addressing information used in addition to phone number such as a PBX extension, a pager PIN, or FAX sub-address.	Optional	minOcc 0 maxOcc 1 minLength 1 maxLength 5
EffectiveDate	Optional	The date on which the phone became (or will become) effective	Recommended	minOcc 0 maxOcc 1 Date format: CCYY-MM-DD
ExpirationDate	Optional	The date on which the phone will (or did) expire	Recommended	minOcc 0 maxOcc 1 Date format: CCYY-MM-DD
NoteMessage	Optional Repeatable	Additional information about the phone of the sponsor person	Optional	minOcc 0 maxOcc ∞ minLength 1 maxLength 80

PESC XML Application for Admission Implementation Guide Version 1.3.0

Applicant.Person.Immigration.Sponsor.SponsorPerson.Contacts.Phone (Continued)

Code illustration:

```
<Phone>  
  <CountryPrefixCode/>  
  <AreaCityCode>512</AreaCityCode>  
  <PhoneNumber>8888888</PhoneNumber>  
  <PhoneNumberExtension/>  
  <EffectiveDate/>  
  <ExpirationDate/>  
  <NoteMessage/>  
</Phone>
```

PESC XML Application for Admission Implementation Guide Version 1.3.0

Applicant.Person.Immigration.Sponsor.SponsorPerson.Contacts.URL

Note: Although the complex data element URL is an optional data element, if you choose to send the URL of the FamilyMember, then you must send the data element URLAddress.

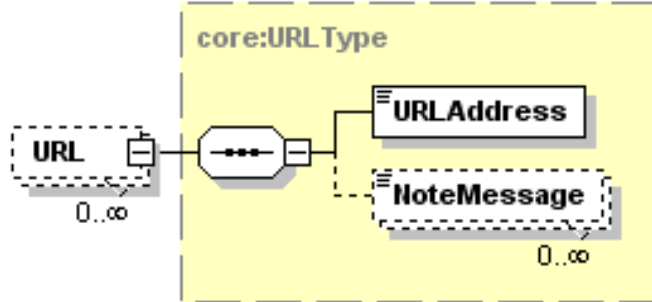

Tag Name	Schema Use	Description	Recommended Use	Format
URLAddress	Required	The Uniform Resource Locator (URL) address associated with a person	Required	minOcc 1 maxOcc 1 minLength 0 maxLength 512
NoteMessage	Optional Repeatable	Additional information about the URL	Not recommended	minOcc 0 maxOcc ∞ minLength 1 maxLength 80

Code illustration:

```

<URL>
  <URLAddress>www.JohnAppleseed.com</URLAddress>
  <NoteMessage/>
</URL>

```

PESC XML Application for Admission Implementation Guide Version 1.3.0

Applicant.Person.Immigration.Sponsor.SponsorPerson.Gender

Note: Although the complex data element Gender is an optional data element, if you choose to send the Gender of the Sponsoring Person, then you must send the data element GenderCode.

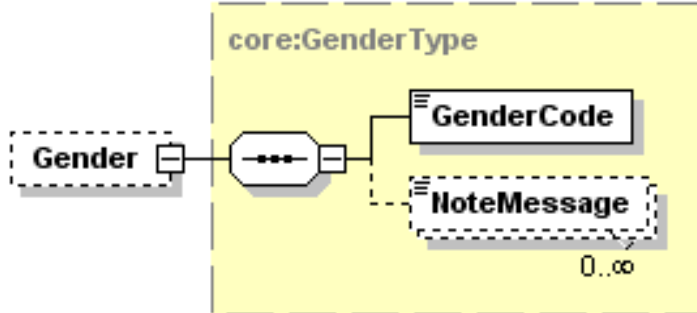

Tag Name	Schema Use	Description	Recommended Use	Format
GenderCode	Required	The gender of the sponsoring person of the applicant	Required	minOcc 1 maxOcc 1 Enumerations: Female Male Unreported
NoteMessage	Optional Repeatable	Additional information about Gender	Not Recommended	minOcc 0 maxOcc ∞ minLength 1 maxLength 80

Code illustration:

```
<Gender>
  <GenderCode>Male</GenderCode>
  <NoteMessage/>
</Gender>
```

PESC XML Application for Admission Implementation Guide Version 1.3.0

Applicant.Person.Immigration.Sponsor.SponsorPerson.Citizenship

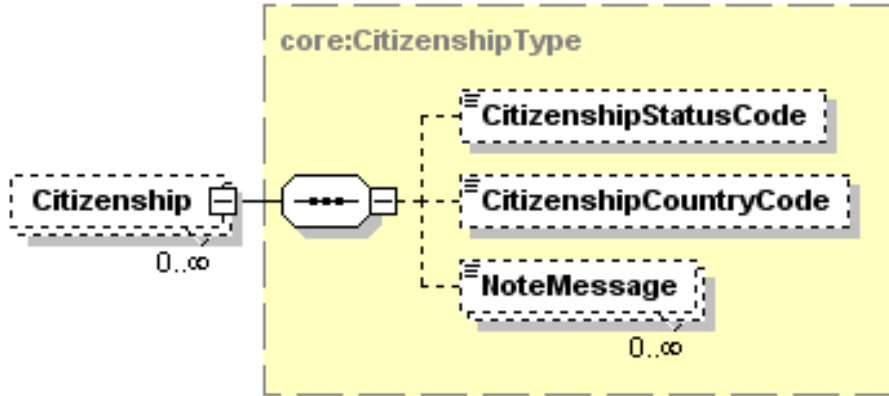

Tag Name	Schema Use	Description	Recommended Use	Format
CitizenshipStatusCode	Optional	Citizenship status of the person sponsoring the international applicant	Optional	minOcc 0 maxOcc 1 Enumerations: Asylee Citizen EligibleNonCitizen IllegalAlien LandedImmigrant MinistersPermit NonCitizen NonPermanentResidentAlien NonResidentAlien NonResidentCitizen NotEligible PermanentVisa Refugee ResidentAlien StudentAuthorization StudentVisa TemporaryVisa UndocumentedAlien VisitorVisa WorkVisa
CitizenshipCountryCode	Optional	Code for the country of citizenship of the person sponsoring the international applicant	Optional	minOcc 0 maxOcc 1 Enumerations: See Appendix B1 or B2
NoteMessage	Optional Repeatable	Additional information about the citizenship of the sponsoring person of an international applicant	Not Recommended	minOcc 0 maxOcc ∞ minLength 1 maxLength 80
Comment: This information would not normally be captured for the sponsor of an international applicant.				

Code illustration:

```

<Citizenship>
  <CitizenshipStatusCode>Citizen</CitizenshipStatusCode>
  <CitizenshipCountryCode>US</CitizenshipCountryCode>
  <NoteMessage/>
</Citizenship>
    
```

PESC XML Application for Admission Implementation Guide Version 1.3.0

Applicant.Person.Immigration.Sponsor.SponsorPerson.Deceased

Note: Although the complex data element *Deceased* is an optional data element, if you choose to send the *Deceased Status of the Sponsoring Person*, then you must send the data element *DeceasedIndicator*.

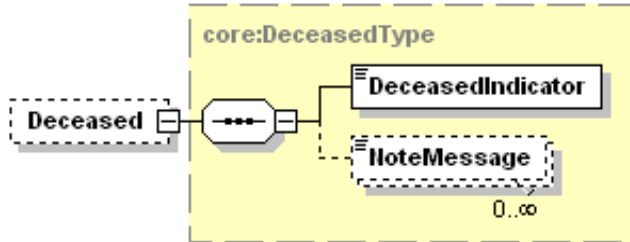

Tag Name	Schema Use	Description	Recommended Use	Format
DeceasedIndicator	Required	An indicator that this sponsor of the applicant is now deceased	Required	minOcc 1 maxOcc 1 The values are either true or false
Comments: If the value were false, then the complex data element "Deceased" would not be included in the document.				
NoteMessage	Optional Repeatable	Additional information about the deceased status of this sponsor of the applicant	Not recommended	minOcc 0 maxOcc ∞ minLength 1 maxLength 80
Comments: It would be very unusual for the sponsoring person to be included in the document if that person were deceased.				

Code Illustration:

```
<Deceased>
  <DeceasedIndicator>true</DeceasedIndicator>
  <NoteMessage/>
</Deceased>
```

PESC XML Application for Admission Implementation Guide Version 1.3.0

Applicant.Person.Immigration.Sponsor.SponsorPerson. OccupationDetail

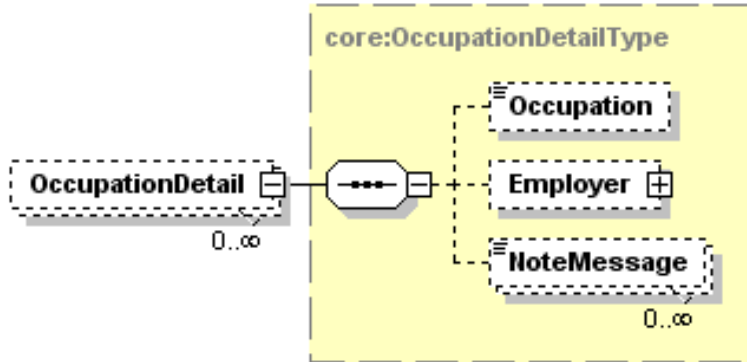

Tag Name	Schema Use	Description	Recommended Use	Format
Occupation	Optional	The name of the occupation of the sponsor person	Optional	minOcc 0 maxOcc 1 minLength 2 maxLength 20
Employer	Optional	Information about the name of the employer (person or company, etc.) of this sponsor person of the applicant	Optional	minOcc 0 maxOcc 1
Comments: This complex data element will be expanded on page 181 which follows.				
NoteMessage	Optional Repeatable	Additional information about the occupation of the sponsor person of the applicant	Not Recommended	minOcc 0 maxOcc ∞ minLength 1 maxLength 80

Code illustration:

```

<Occupation>
  <Occupation>Lawyer</Occupation>
  <Employer>

  </Employer>
  <NoteMessage/>
</Occupation>

```

PESC XML Application for Admission Implementation Guide Version 1.3.0

Applicant.Person.Immigration.Sponsor.SponsorPerson. OccupationDetail.Employer

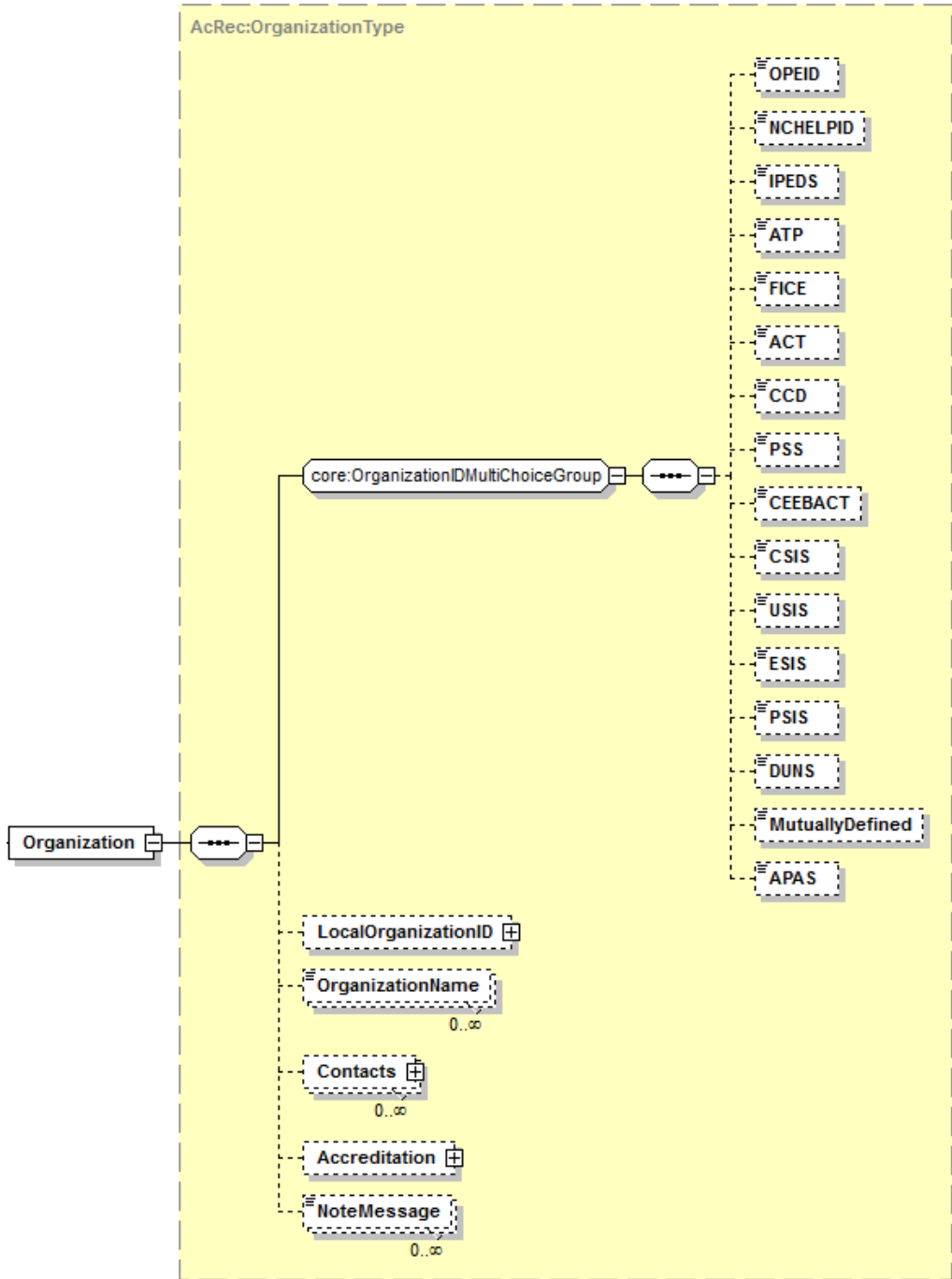

Applicant.Person.Immigration.Sponsor.SponsorPerson. OccupationDetail.Employer (Continued)

PESC XML Application for Admission Implementation Guide

Version 1.3.0

Tag Name	Schema Use	Description	Recommended Use	Format
[OrganizationIDGroup]	Optional	Allowable Organization IDs - Exclusive choice	Not Recommended	minOcc 0 maxOcc 1
Comment: [OrganizationIDGroup] is not an XML tag and does not appear in an instance document. It allows the choice of one and only one of the following code set tags to identify the sponsoring organization for this International Applicant.				
OPEID	Required choice	The unique identifier assigned by the Office of Postsecondary Education for each data exchange partner. Includes all postsecondary schools that are eligible to participate in US Title IV federal financial aid programs.	Not Recommended	minOcc 0 maxOcc 1 minLength 3 maxLength 8
Comment: The OPEID would not normally be an appropriate choice in this case unless a postsecondary institution is the sponsor of an international applicant.				
NCHELPID	Required choice	The unique identifier assigned by National Council on Higher Education Loan Programs for each data exchange partner.	Not Recommended	minOcc 0 maxOcc 1 minLength 3 maxLength 8
Comment: The NCHELPID would not normally be an appropriate choice in this case since the organizations in the financial aid world would not normally be sponsors of an international applicant.				
IPEDS	Required choice	The unique identifier for Integrated Postsecondary Education Data System assigned by the National Center for Education Statistics for each postsecondary data exchange partner. Also called the Unit ID.	Not Recommended	minOcc 0 maxOcc 1 minLength 6 maxLength 6
Comment: The IPEDS would not normally be an appropriate choice in this case unless a postsecondary institution was sponsoring the international applicant.				
ATP	Required choice	The unique identifier for the Admissions Testing Program assigned by the College Board for each data exchange partner.	Not Recommended	minOcc 0 maxOcc 1 minLength 6 maxLength 6
Comment: The ATP would not normally be an appropriate choice in this case unless a postsecondary institution was sponsoring the international applicant.				
FICE	Required choice	The unique identifier once maintained for the Federal Interagency Committee on Education by the National Center for Education Statistics for each postsecondary data exchange partner.	Not Recommended	minOcc 0 maxOcc 1 minLength 6 maxLength 6
Comment: The FICE would not normally be an appropriate choice in this case unless a postsecondary institution was sponsoring the international applicant.				
ACT	Required choice	The unique identifier for postsecondary educational institutions assigned by American College Testing available at www.act.org	Not Recommended	minOcc 0 maxOcc 1 minLength 4 maxLength 4
Comment: The ACT would not normally be an appropriate choice in this case unless a postsecondary institution was sponsoring the international applicant.				
CCD	Required choice	The unique identifier assigned by National Center for Education Statistics as the Common Core of Data for each data exchange partner.	Not Recommended	minOcc 0 maxOcc 1 minLength 12 maxLength 12
Comment: The CCD would not normally be an appropriate choice in this case since secondary schools would not normally sponsor an international applicant.				

PESC XML Application for Admission Implementation Guide

Version 1.3.0

Tag Name	Schema Use	Description	Recommended Use	Format
PSS	Required choice	The unique identifier assigned by National Center for Education Statistics for private K12 schools in the US for each data exchange partner.	Not Recommended	minOcc 0 maxOcc 1 minLength 8 maxLength 8
Comment: The CCD would not normally be an appropriate choice in this case since secondary schools would not normally sponsor an international applicant.				
CEEBACT	Required choice	The unique identifier assigned by the College Entrance Examining Board and ACT for each K-12 data exchange partner.	Not Recommended	minOcc 0 maxOcc 1 minLength 6 maxLength 6
Comment: The CEEBACT would not normally be an appropriate choice in this case since secondary schools would not normally sponsor an international applicant.				
CSIS	Required choice	The unique identifier assigned by the Statistics Canada Canadian College Student Information System for each postsecondary data exchange partner.	Not Recommended	minOcc 0 maxOcc 1 minLength 6 maxLength 6
Comment: Since this code set is used to identify postsecondary schools in Canada, it is not a recommended choice for US schools. However, this code set is being phased out in Canada and the new code set is PSIS, which would be a valid choice if the school were the employer.				
USIS	Required choice	The unique identifier assigned by the Statistics Canada University Student Information System for each data postsecondary exchange partner.	Not Recommended	minOcc 0 maxOcc 1 minLength 6 maxLength 6
Comment: Since this code set is used to identify postsecondary schools in Canada, it is not a recommended choice for schools in the US. However, this code set is being phased out in Canada and the new code set is PSIS, which would be a valid choice if the school were the employer.				
ESIS	Required choice	The unique identifier assigned by the Statistics Canada Enhanced Student Information System for each data postsecondary exchange partner.	Not Recommended	minOcc 0 maxOcc 1 minLength 8 maxLength 8
Comment: Since this code set is used to identify postsecondary schools in Canada, it is not a recommended choice for schools in the US. However, it would be a valid choice for schools in Canada, if the school were an employer.				
PSIS	Required choice	The unique identifier assigned by the Statistics Canada Postsecondary Student Information System for each data postsecondary exchange partner.	Optional	minOcc 0 maxOcc 1 minLength 8 maxLength 8
Comment: Since this code set is used to identify postsecondary schools in Canada, it is not a recommended choice for schools in the US. However, it would be a valid choice for postsecondary schools in Canada, if the school were an employer.				
DUNS	Required choice	Data Universal Numbering System (DUNS), unique nine character company identification number issued by Dun and Bradstreet Corporation.	Recommended	minOcc 0 maxOcc 1 minLength 9 maxLength 9
Comment: The DUNS number would be an appropriate choice to identify a company or other agency that might be an employer.				
MutuallyDefined	Required choice	A code set that is agreed upon by the sender and the recipient of the instance document	Optional	minOcc 0 maxOcc 1 minLength 1 maxLength 60
Comment: MutuallyDefined would be an appropriate choice to identify a company or other agency that might employ the person sponsoring an international applicant and no code is available in any of the other choice code sets.				
APAS	Optional choice	Identification codes used by the Alberta Post-Secondary System.	Optional	minOcc 0 maxOcc 1 minLength 2 maxLength 12

PESC XML Application for Admission Implementation Guide Version 1.3.0

Tag Name	Schema Use	Description	Recommended Use	Format
<i>Comment: This is an appropriate choice for institutions in Canada.</i>				
<i>Comment: End of OrganizationIDGroup choice set tags.</i>				
LocalOrganizationID	Optional	A code set typically used by a state, province or region to further identify the sending vendor, agency or school.	Not Recommended	minOcc 0 maxOcc 1
OrganizationName	Required Repeatable	Name of Non-person entity such as Organization, Institution, Agency or Business.	Required	minOcc 1 maxOcc ∞ minLength 1 maxLength 60
<i>Comment: This is the name of the company, vendor, school or agency that is sponsoring the international applicant</i>				
Contacts	Optional Repeatable	To identify a person or an office at the vendor, company, association, agency or school to which administrative communications should be directed	Not Recommended	minOcc 0 maxOcc ∞
NoteMessage	Optional Repeatable	Additional information about the sponsoring organization	Not recommended	minOcc 0 maxOcc ∞ minLength 1 maxLength 80

Applicant.Person.Immigration.Sponsor.SponsorPerson. OccupationDetail.Employer (Continued)

Code illustration:

```

<Employer>
  <DUNS>123456789</DUNS>
  <LocalOrganizationID/>
  <OrganizationName>Xap Corporation</OrganizationName>
  <Contacts/>
  <NoteMessage/>
</Employer>

```

PESC XML Application for Admission Implementation Guide Version 1.3.0

Applicant.Person.Immigration.PassportDetail

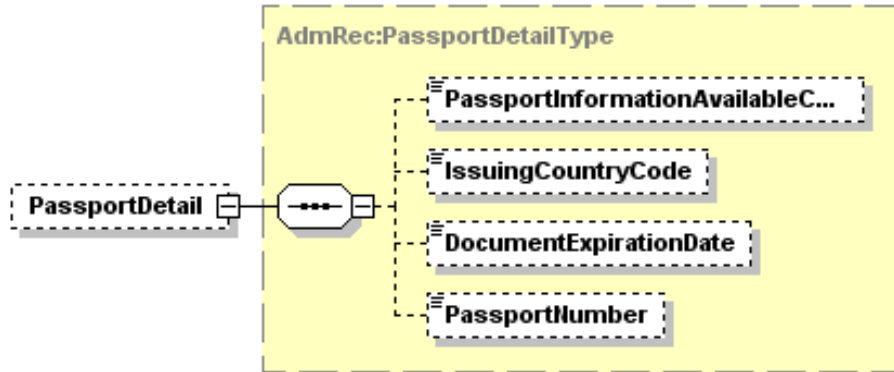

Tag Name	Schema Use	Description	Recommended Use	Format
PassportInformationAvailableCode	Optional	Information provided if the detailed information about the applicant's passport is not available	Recommended	minOcc 0 maxOcc 1 Enumerations: InformationNotAvailable NotYetIssued
IssuingCountryCode	Optional	The SEVIS code for the country that issued the applicant's passport	Recommended	minOcc 0 maxOcc 1 minLength 2 maxLength 2 See Appendix J for the list of acceptable values.
DocumentExpirationDate	Optional	The date the international applicant's passport expires	Recommended	minOcc 0 maxOcc 1 Date format is cyy-mm-dd
PassportNumber	Optional	The number assigned by the issuing country	Recommended	minOcc 0 maxOcc 1 minLength 0 maxLength 25

Code illustration:

```

<PassportDetail>
  <PassportInformationAvailableCode>InformationNotAvailable</PassportInformationAvailableCode>
  <IssuingCountryCode>AM</IssuingCountryCode>
  <DocumentExpirationDate>2009-04-01</DocumentExpirationDate>
  <PassportNumber>11223344</PassportNumber>
</PassportDetail>
  
```

PESC XML Application for Admission Implementation Guide Version 1.3.0

Applicant.Person.Immigration.VisaDetail

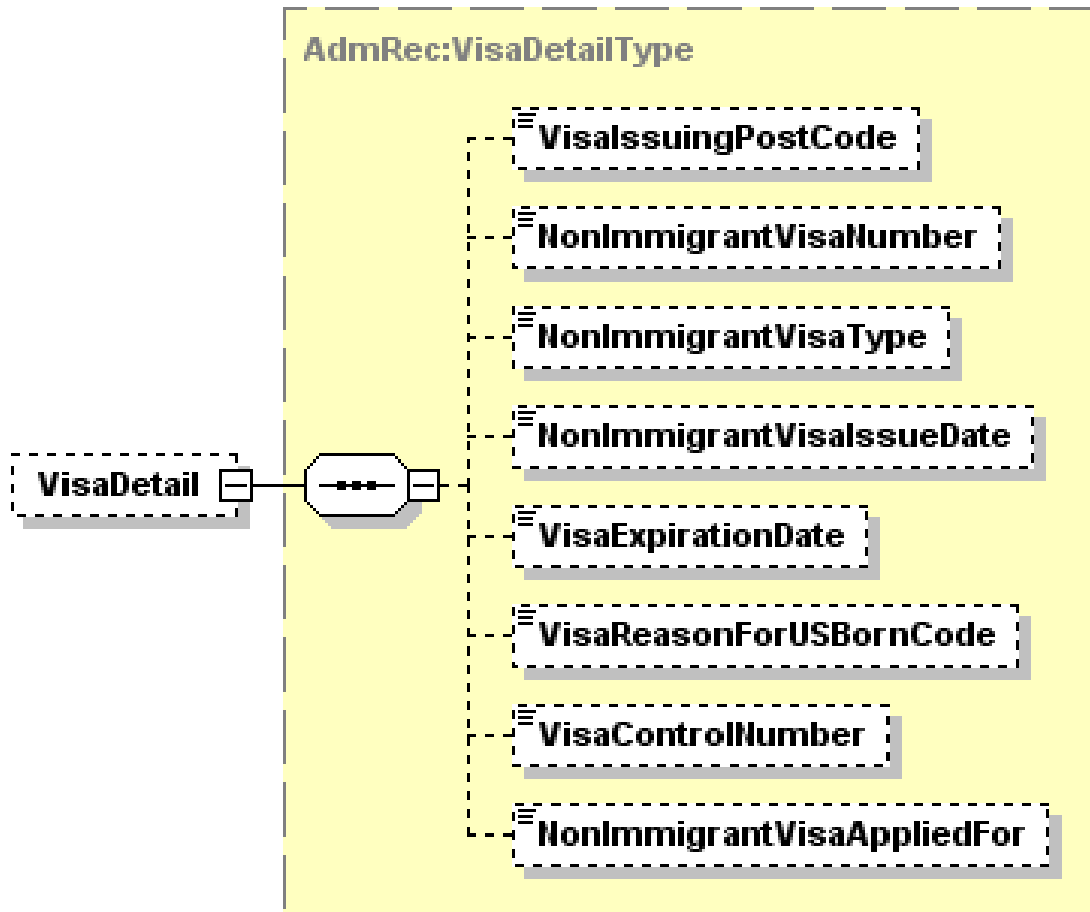

Tag Name	Schema Use	Description	Recommended Use	Format
VisalssuingPostCode	Optional	The SEVIS code for the country that issued the international applicant's visa	Recommended	minOcc 0 maxOcc 1 minLength 3 maxLength 3 See Appendix L for values of this code set.
NonImmigrantVisaNumber	Optional	The number assigned by the issuing post for this visa for this international applicant once the application is approved	Recommended	minOcc 0 maxOcc 1 minLength 3 maxLength 20
Comment: Length of visa numbers in Canada is 10. Canadian Study Permits are 9 characters in length (4 digits followed by a dash and then 4 more digits).				
NonImmigrantVisaType	Optional	The type of visa currently held by the international applicant	Recommended	minOcc 0 maxOcc 1 minLength 3 maxLength 20 See Appendix F
NonImmigrantVisalssueDate	Optional	The date the applicant's current visa was issued	Recommended	minOcc 0 maxOcc 1 Date format is ccyy-mm-dd

PESC XML Application for Admission Implementation Guide Version 1.3.0

Tag Name	Schema Use	Description	Recommended Use	Format
VisaExpirationDate	Optional	The date the applicant's current visa will expire	Recommended	minOcc 0 maxOcc 1 Date format is cyy-mm-dd
VisaReasonForUSBornCode	Optional	The reason that the international applicant holds a visa from another country if the applicant was born in the US	Recommended	minOcc 0 maxOcc 1 Enumerations: BornInUSToForeignDiplomat Expatriated
VisaControlNumber	Optional	The number assigned by the issuing post for this visa application during the processing for this international applicant	Recommended	minOcc 0 maxOcc 1 minLength 1 maxLength 50
NonImmigrantVisaAppliedFor	Optional	The specific visa for which the applicant has applied	Recommended	minOcc 0 maxOcc 1 minLength 3 maxLength 20
Comment: See Appendix F for a list of visas issued by the US government				

Applicant.Person.Immigration.VisaDetail (Continued)

Code illustration:

```

<VisaDetail>
  <VisalssuingPostCode>SWE</ VisalssuingPostCode>
  <NonImmigrantVisaNumber>998877</NonImmigrantVisaNumber>
  <NonImmigrantVisaType>E1</NonImmigrantVisaType>
  <NonImmigrantVisalssueDate>2005-12-01</NonImmigrantVisalssueDate>
  <VisaExpirationDate>2010-12-31</VisaExpirationDate>
  <VisaReasonForUSBornCode>Expatriated</VisaReasonForUSBornCode>
  <VisaControlNumber>11223344</VisaControlNumber>
  <NonImmigrantVisaAppliedFor>F1</NonImmigrantVisaAppliedFor>
</VisaDetail>

```

PESC XML Application for Admission Implementation Guide Version 1.3.0

Applicant.Person.Immigration.I94Detail

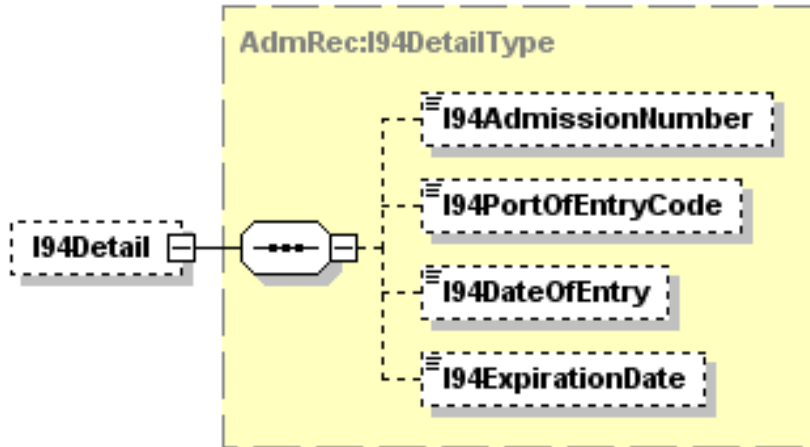

Tag Name	Schema Use	Description	Recommended Use	Format
I94AdmissionNumber	Optional	The number on the I94 form issued when the non-citizen entered the US	Recommended	minOcc 0 maxOcc 1 minLength 1 maxLength 30
I94PortOfEntryCode	Optional	The port where the non-citizen entered the US	Recommended	minOcc 0 maxOcc 1 minLength 3 maxLength 3 Enumerations: See SEVIS code set for ports of entry in Appendix K
I94DateOfEntry	Optional	The date when the non-citizen entered the US	Recommended	minOcc 0 maxOcc 1 Date format is ccyy-mm-dd
I94ExpirationDate	Optional	The date on which the entry permit expires and the non-citizen is no longer in the US in a legal status. Duration of status is another condition and the non-citizen remains in a legal status as long as the conditions of the entry remain valid.	Recommended	minOcc 0 maxOcc ∞ This can be a date, or a code indicating DS for duration of status. Enter the date here with format ccyy-mm-dd. Leave blank if approved for Duration of Status.

Comment: The I94 is a document provided to each non-US citizen upon entering the US. A new document is issued for each entry into the US. It indicates which visa is used for the entry and if there is a specific date by which the person must leave the US or have his or her status changed. If no date is specified, then a code of DS (Duration of Status) is indicated on the I94 document.

Code illustration:

```
<I94Detail>
  <I94AdmissionNumber >1234567</I94AdmissionNumber >
  <I94PortOfEntryCode>MIA</I94PortOfEntryCode>
  <I94DateOfEntry>2007-04-02</I94DateOfEntry>
  <I94ExpirationDate>2009-04-01</I94ExpirationDate>
</I94Detail>
```

PESC XML Application for Admission Implementation Guide Version 1.3.0

Applicant.Person.Immigration.Dependent

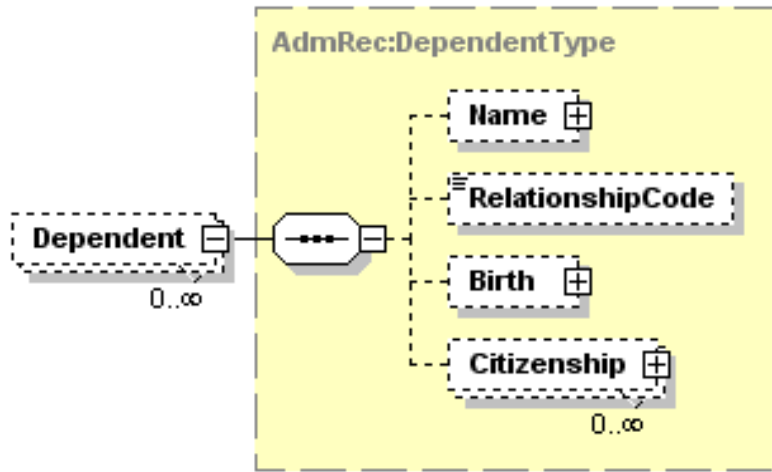

Tag Name	Schema Use	Description	Recommended Use	Format
Name	Optional	The name of the dependent who plans to accompany the applicant to the host country	Recommended	minOcc 0 maxOcc 1
Comment: This complex data element will be expanded on page 190 which follows.				
RelationshipCode	Optional	The relationship of the dependent to the applicant	Recommended	minOcc 0 maxOcc 1 Enumerations: See Appendix D for the Relationship Codes
Birth	Optional	Information about the birth place and date of the dependent of the applicant	Recommended	minOcc 0 maxOcc 1
Comment: This complex data element will be expanded on page 192 which follows.				
Citizenship	Optional	Information about the citizenship status of the dependent of the applicant	Recommended	minOcc 0 maxOcc ∞
Comment: This complex data element will be expanded on page 194 which follows.				

Code illustration:

```

<Dependent>
  <Name>
    </Name >
    <RelationshipCode>Son</RelationshipCode>
    <Birth>
      </Birth>
    <Citizenship>
      </Citizenship>
    </Citizenship>
  </Dependent>

```

PESC XML Application for Admission Implementation Guide Version 1.3.0

Applicant.Person.Immigration.Dependent.Name

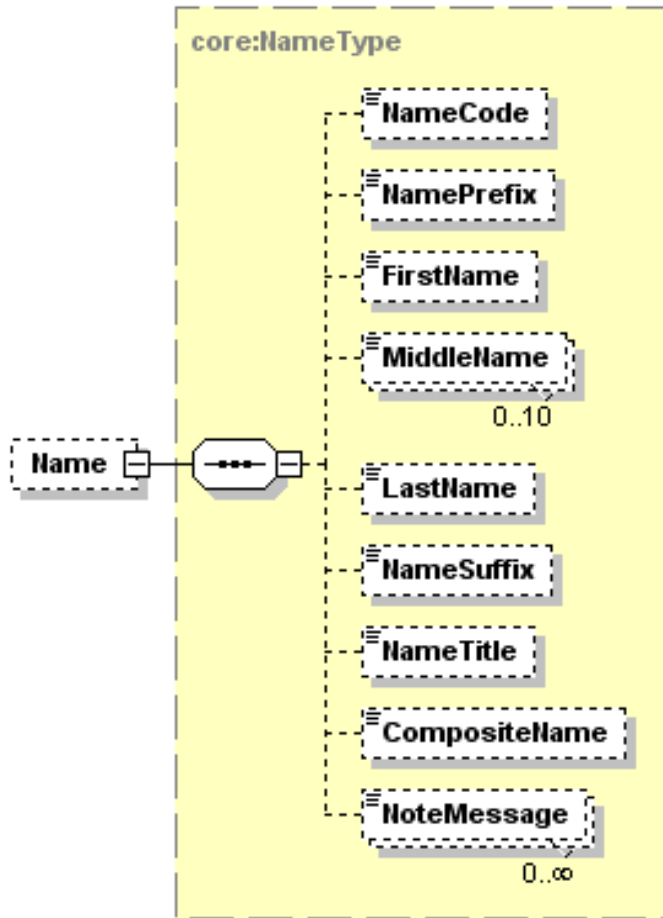

Tag Name	Schema Use	Description	Recommended Use	Format
NameCode	Optional	A code that indicates the type of name that is being described for the dependent of the applicant	Recommended	minOcc 0 maxOcc 1 Enumeration: Casual Formal Former LawSchoolApplication Source Legal MedicalSchoolApplicat ion Source Nickname Other
NamePrefix	Optional	An honorific, title or form of address that precedes the name.	Not Recommended	minOcc 0 maxOcc 1 minLength 1 maxLength 30
Comment: The honorific includes such data as "Dr.", "Professor", "Miss", etc. The Workgroup felt that it could do more harm than good to include this information and make it available to the school.				
FirstName	Optional	The first name of the person, usually given at birth, baptism, or during, another ceremony, or through legal change	Recommended	minOcc 0 maxOcc 1 minLength 1 maxLength 35

PESC XML Application for Admission Implementation Guide

Version 1.3.0

Tag Name	Schema Use	Description	Recommended Use	Format
MiddleName	Optional Repeatable	A secondary name of the person, usually given at birth, baptism, or during another naming ceremony or through legal change	Recommended	minOcc 0 maxOcc 10 minLength 1 maxLength 35
LastName	Optional	The last name or surname by which a person is legally known	Recommended	minOcc 0 maxOcc 1 minLength 1 maxLength 35
Comment: It is important to collect the name, and especially the last name of the dependent				
NameSuffix	Optional	The expression of an individual's generation within a family.	Recommended	minOcc 0 maxOcc 1 Enumerations: I II III IV V VI VII VIII IX X JR SR
NameTitle	Optional	An honorific, title or credential that follows the name.	Not Recommended	minOcc 0 maxOcc 1 minLength 1 maxLength 30
CompositeName	Optional	The full name of the person in Last Name (space) Suffix (comma) First Name (space) Middle Names (spaces). A comma would be included after last name or NameSuffix	Not Recommended	minOcc 0 maxOcc 1 minLength 1 maxLength 45
Comment: The use of the composite format for student name is discouraged. It is much easier for the receiving school to process the individual name parts into its data base than to process a composite name. This data element is scheduled to be deleted in a future release of the standard.				
NoteMessage	Optional Repeatable	Additional information about the dependent's name	Not Recommended	minOcc 0 maxOcc ∞ minLength 1 maxLength 80

Code illustration:

```

<Name>
  <NameCode>Legal</NameCode>
  <NamePrefix/>
  <FirstName>John</FirstName>
  <MiddleName>Billy</MiddleName>
  <MiddleName>Bob</MiddleName>
  <LastName>Thornton</LastName>
  <NameSuffix>JR</NameSuffix>
  <NameTitle/>
  <CompositeName/>
  <NoteMessage/>
</Name>

```

PESC XML Application for Admission Implementation Guide Version 1.3.0

Applicant.Person.Immigration.Dependent.Birth

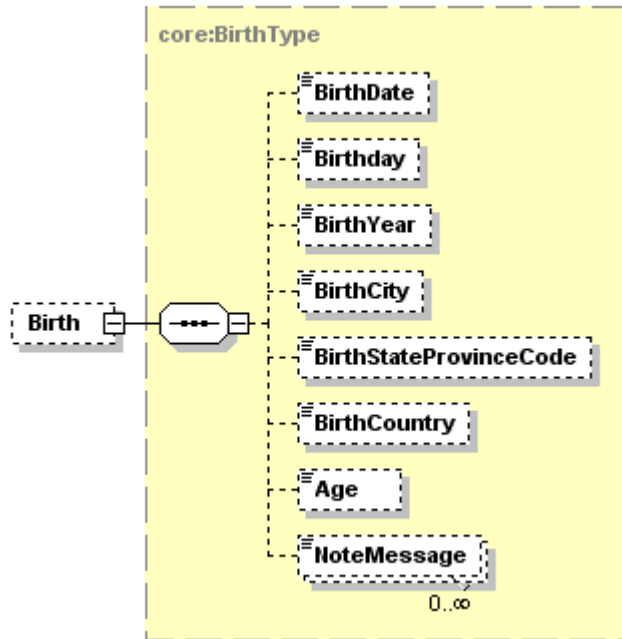

Tag Name	Schema Use	Description	Recommended Use	Format
BirthDate	Optional	Date of Birth	Recommended	minOcc 0 maxOcc 1 xs:date Format is ccyy-mm-dd
Comment: It is strongly recommended by the Workgroup that the complete date of birth be included for the dependent of the applicant.				
Birthday	Optional	Month and Day of Birth	Not Recommended	minOcc 0 maxOcc 1 xs:gMonthDay Format is --mm-dd
BirthYear	Optional	Year of Birth	Not Recommended	minOcc 0 maxOcc 1 Format is ccyy
BirthCity	Optional	The city in which the person was born.	Optional	minOcc 0 maxOcc 1 minLength 1 maxLength 25
BirthStateProvinceCode	Optional	The state, province, or extra-state jurisdiction in which the person was born	Optional	minOcc 0 maxOcc 1 Enumerations: See Appendix A
BirthCountry	Optional	The name of the country in which the person was born. Use ISO 3 155-1 alpha-2 standard.	Optional	minOcc 0 maxOcc 1 Enumerations: See Appendix B
Age	Optional	The age of the dependent of the international applicant	Not Recommended	minOcc 0 maxOcc 1 Format is a decimal
NoteMessage	Optional Repeatable	Additional information about the birth of the dependent	Not Recommended	minOcc 0 maxOcc ∞ minLength 1 maxLength 80

PESC XML Application for Admission Implementation Guide Version 1.3.0

Applicant.Person.Immigration.Dependent.Birth (Continued)

Code illustration:

```
<Birth>  
  <BirthDate>1987-07-20</BirthDate>  
  <BirthDay/>  
  <BirthYear/>  
  <BirthCity>Miami</BirthCity>  
  <BirthStateProvinceCode>FL</BirthStateProvinceCode>  
  <BirthCountry>US</BirthCountry>  
  <Age/>  
  <NoteMessage/>  
</Birth>
```

PESC XML Application for Admission Implementation Guide Version 1.3.0

Applicant.Person.Immigration.Dependent.Citizenship

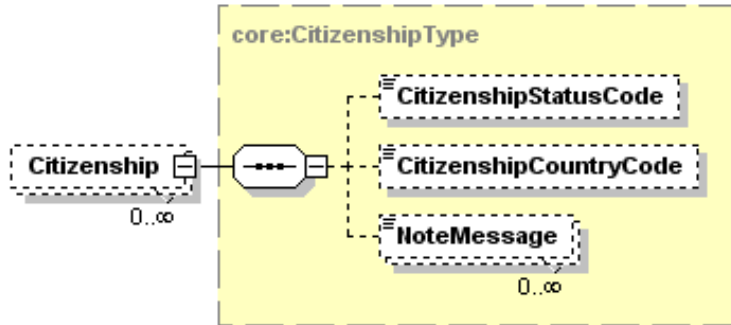

Tag Name	Schema Use	Description	Recommended Use	Format
CitizenshipStatusCode	Optional	Citizenship status of the dependent	Recommended	minOcc 0 maxOcc 1 Enumerations: Citizen EligibleNonCitizen IllegalAlien LandedImmigrant MinistersPermit NonCitizen NonPermanentResidentAlien NonResidentAlien NonResidentCitizen NotEligible PermanentVisa Refugee ResidentAlien StudentAuthorization StudentVisa UndocumentedAlien VisitorVisa WorkVisa
CitizenshipCountryCode	Optional	The country in which the dependent holds the status represented by the Citizenship Status Code above.	Recommended	minOcc 0 maxOcc 1 See Appendix B1 or B2 for ISO codes for countries of the world
Comment: This allows for the transmission of citizenship statuses for dependents with dual citizenship, as well as allowing for the identification of the country of citizenship and the immigration status in the US or Canada.				
NoteMessage	Optional Repeatable	Additional information about the citizenship status of the dependent	Not Recommended	minOcc 0 maxOcc ∞ minLength 1 maxLength 80

Code illustration:

```

<Citizenship>
  <CitizenshipStatusCode>Citizen</CitizenshipStatusCode>
  <CitizenshipCountryCode>BR</CitizenshipCountryCode>
  <NoteMessage/>
</Citizenship>
<Citizenship>
  <CitizenshipStatusCode>ResidentAlien</CitizenshipStatusCode>
  <CitizenshipCountryCode>US</CitizenshipCountryCode>
  <NoteMessage/>
</Citizenship>
    
```

PESC XML Application for Admission Implementation Guide Version 1.3.0

Applicant.Person.Immigration.OptionalPracticalTraining

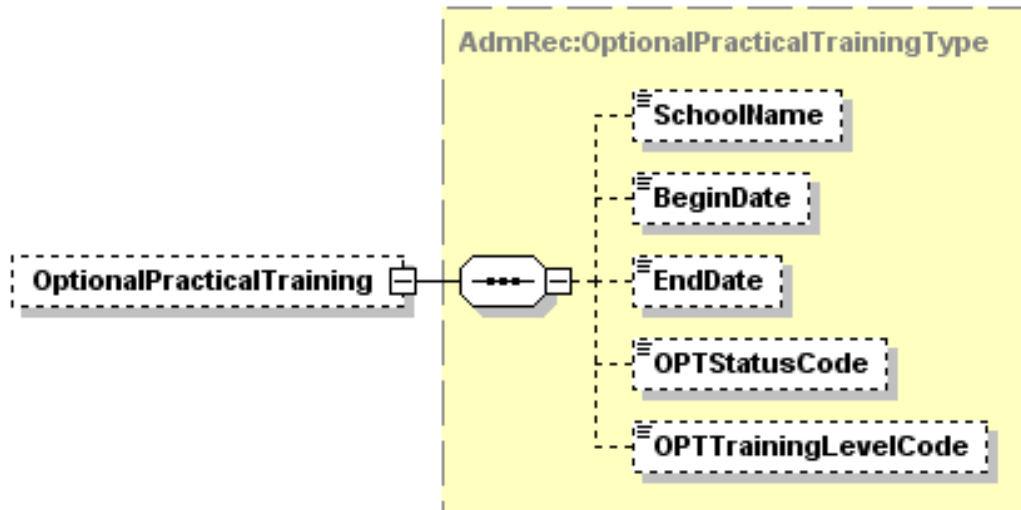

Tag Name	Schema Use	Description	Recommended Use	Format
SchoolName	Optional	The name of the school where the Optional Practical Training is administered	Recommended	minOcc 0 maxOcc 1 minLength 0 maxLength 60
BeginDate	Optional	The date the Optional Practical Training is or was scheduled to begin	Recommended	minOcc 0 maxOcc 1 Date format is ccyymm-dd
EndDate	Optional	The date the Optional Practical Training is or was scheduled to end	Recommended	minOcc 0 maxOcc 1 Date format is ccyymm-dd
OPTStatusCode	Optional	The code used by SEVIS to identify the current status of the Optional Practical Training	Recommended	minOcc 0 maxOcc ∞ Enumerations: FullTime PartTime
OPTTrainingLevelCode	Optional	This is the level of training approved for this OPT.	Recommended	minOcc 0 maxOcc 1 Enumerations: Associate Bachelors Doctorate Graduate HighSchool Professional
<p>Comment: If the student has or had more than one approved period of OPT, then this will be the current or latest level of OPT that was approved for the student.</p>				

Code illustration:

```

<OptionalPracticalTraining>
  <SchoolName>University of Ohio</SchoolName >
  <BeginDate>2007-04-02</BeginDate>
  <EndDate>2009-04-01</EndDate>
  <OPTStatusCode>FullTime</OPTStatusCode>
  <OPTTrainingLevelCode>Bachelors</OPTTrainingLevelCode>
</OptionalPracticalTraining>

```

PESC XML Application for Admission Implementation Guide Version 1.3.0

Applicant.Person.Immigration.CurricularPracticalTraining

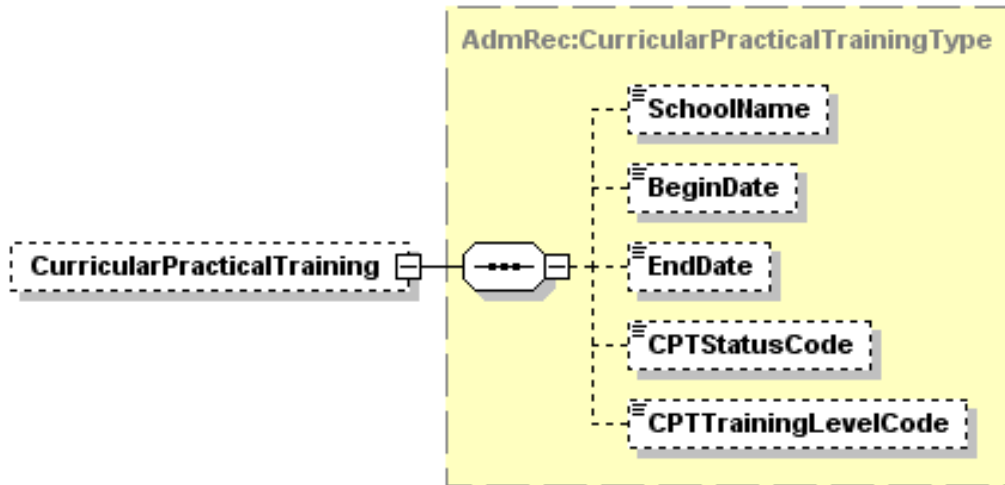

Tag Name	Schema Use	Description	Recommended Use	Format
SchoolName	Optional	The name of the school that will administer the Curricular Practical Training	Recommended	minOcc 0 maxOcc 1 minLength 0 maxLength 60
BeginDate	Optional	The date the Curricular Practical Training is or was scheduled to begin	Recommended	minOcc 0 maxOcc 1 Date format is ccyy-mm-dd
EndDate	Optional	The date the Curricular Practical Training is or was scheduled to end	Recommended	minOcc 0 maxOcc 1 Date format is ccyy-mm-dd
CPTStatusCode	Optional	The code used by SEVIS to identify the current status of the Curricular Practical Training	Recommended	minOcc 0 maxOcc ∞ Enumerations: FullTime PartTime
CPTTrainingLevelCode	Optional	This is the level of training approved for this CPT.	Recommended	minOcc 0 maxOcc 1 Enumerations: Associate Bachelors Doctorate Graduate HighSchool Professional
<p>Comment: If the student has, or had, more than one approved period of CPT, then this will be the current or latest CPT that was approved for the student.</p>				

Code illustration:

```

<CurricularPracticalTraining>
  <SchoolName>University of Florida</SchoolName>
  <BeginDate>2007-04-02</BeginDate >
  <EndDate>2009-04-01</EndDate>
  <CPTStatusCode>FullTime</CPTStatusCode>
  <CPTTrainingLevelCode>Doctorate</CPTTrainingLevelCode>
</CurricularPracticalTraining>

```

PESC XML Application for Admission Implementation Guide Version 1.3.0

Applicant.Person.Immigration.AcademicTraining

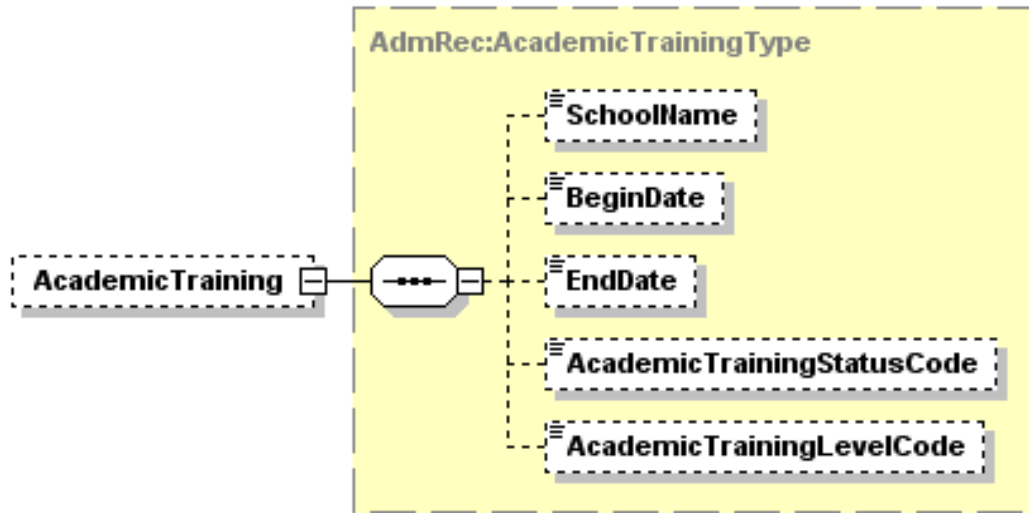

Tag Name	Schema Use	Description	Recommended Use	Format
SchoolName	Optional	The name of the school that will administer the Academic Training for J1 Exchange Visitors	Recommended	minOcc 0 maxOcc 1 minLength 1 maxLength 60
BeginDate	Optional	The date the Academic Training is or was scheduled to begin	Recommended	minOcc 0 maxOcc 1 Date format is ccyy-mm-dd
EndDate	Optional	The date the AcademicTraining is or was scheduled to end	Recommended	minOcc 0 maxOcc 1 Date format is ccyy-mm-dd
AcademicTrainingStatusCode	Optional	The code used by SEVIS to identify the current status of the Academic Training	Recommended	minOcc 0 maxOcc ∞ Enumerations: FullTime PartTime
AcademicTrainingLevelCode	Optional	This is the level of training approved for this Academic Training for international students on a J Visitors visa.	Recommended	minOcc 0 maxOcc 1 Enumerations: Associate Bachelors Doctorate Graduate HighSchool Professional

Comment: If the student has or had more than one approved period of Academic Training, then this will be the current or latest Academic Training that was approved for the student.

Comment: This complex data element is used in conjunction with J1 visitors.

Code illustration:

```

<AcademicTraining>
  <SchoolName>University of Florida</SchoolName>
  <BeginDate>2007-04-02</BeginDate >
  <EndDate>2009-04-01</EndDate>
  <AcademicTrainingStatusCode>PartTime</AcademicTrainingStatusCode>
  <AcademicTrainingLevelCode>Graduate</AcademicTrainingLevelCode>
</AcademicTraining>
  
```

PESC XML Application for Admission Implementation Guide Version 1.3.0

Applicant.Person.Employment



Tag Name	Schema Use	Description	Recommended Use	Format
Employer	Optional	Information about the applicant's previous or current employer	Recommended	minOcc 0 maxOcc 1
Comment: This complex data element will be expanded on page 200.				
EmploymentBeginYearMonth	Optional	Date this employment began or is scheduled to begin	Recommended	minOcc 0 maxOcc 1 xs:date in format CCYY-MM
EmploymentEndYearMonth	Optional	Date this employment ended or is scheduled to end	Recommended	minOcc 0 maxOcc 1 xs:date in format CCYY-MM
PositionTitle	Optional	Title of this employment position	Recommended	minOcc 0 maxOcc 1 minLength 1 maxLength 26

PESC XML Application for Admission Implementation Guide

Version 1.3.0

Tag Name	Schema Use	Description	Recommended Use	Format
SchoolAppliedEmployedCode	Optional Repeatable	An indication of current or previous employment at the school to which the applicant is applying, by the applicant or a family member	Recommended	minOcc 0 maxOcc 4 Enumerations: Applicant FamilyMember Father Mother
StateProvinceEmployedCode	Optional Repeatable	An indication of current or previous employment by the applicant or a family member in the state or province, where the school to which the applicant is applying, is located,	Recommended	minOcc 0 maxOcc 4 Enumerations: Applicant FamilyMember Father Mother
EmploymentStatusCode	Optional	An indication whether the employment is full time or part time	Recommended	minOcc 0 maxOcc 1 Enumerations: FullTime PartTime
EmploymentWeeklyHours	Optional	The average or typical number of hours per week that the person worked	Recommended	minOcc 0 maxOcc 1 The format is an integer
JobDescription	Optional Repeatable	A description of the work performed	Optional	minOcc 0 maxOcc ∞ minLength 0 maxLength 80
NoteMessage	Optional Repeatable	Additional information about the employment	Not Recommended	minOcc 0 maxOcc ∞ minLength 1 maxLength 80

Code illustration:

```

<Employment>
  <Employer>

    </Employer>
    <EmploymentBeginYearMonth>2006-06</EmploymentBeginYearMonth>
    <EmploymentEndYearMonth>2006-09</EmploymentEndYearMonth>
    <PositionTitle>Manager</PositionTitle>
    <SchoolEmployedCode>Applicant</SchoolAppliedEmployedCode>
    <StateProvinceEmployedCode>Applicant</StateProvinceEmployedCode>
    <EmploymentStatusCode>FullTime</EmploymentStatusCode>
    <EmploymentWeeklyHours>45</EmploymentWeeklyHours>
    <JobDescription>Managed the department</JobDescription>
    <NoteMessage/>
  </Employment>

```

PESC XML Application for Admission Implementation Guide Version 1.3.0

Applicant.Person.Employment.Employer

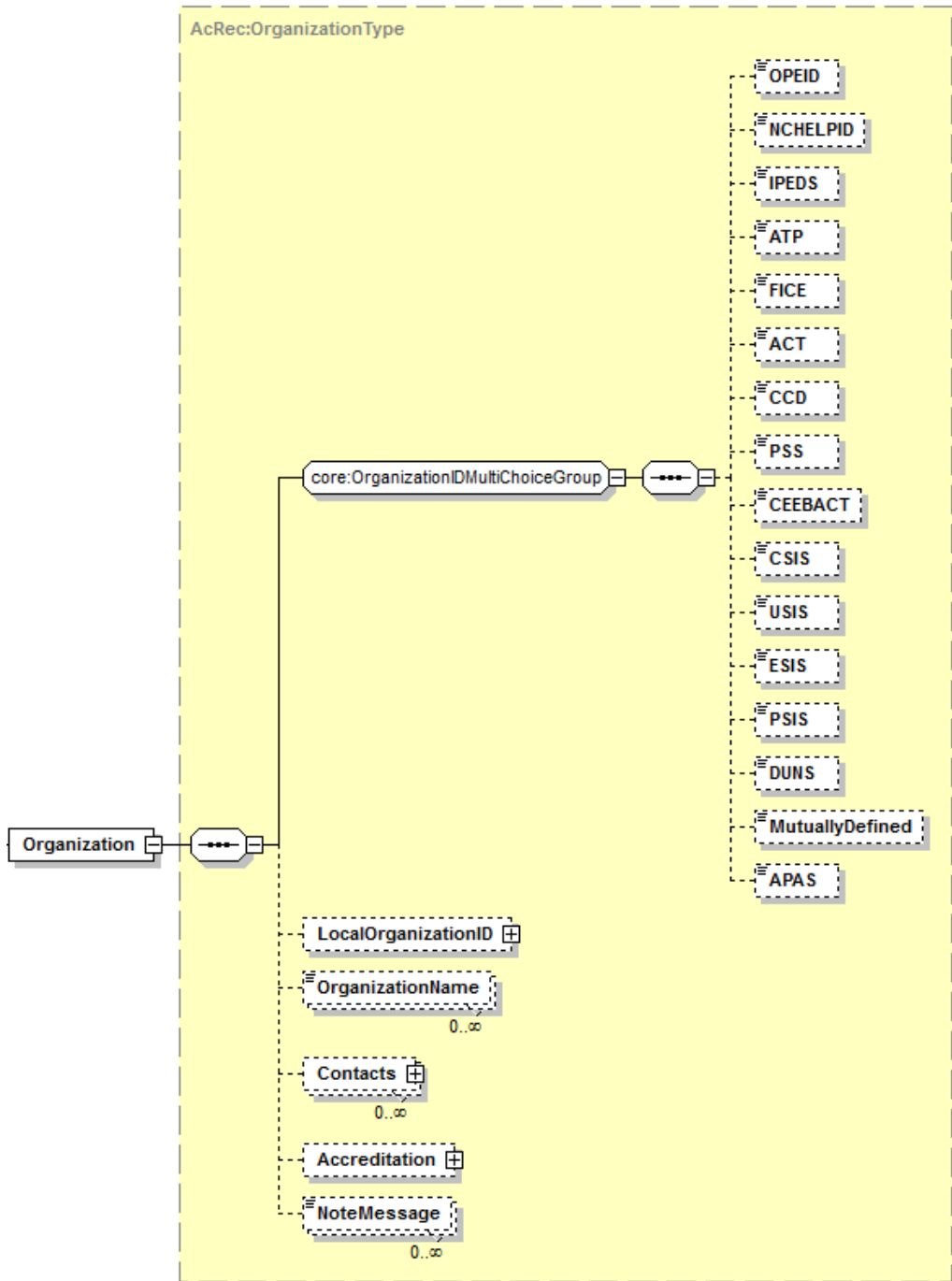

Applicant.Person.Employment.Employer (Continued)

PESC XML Application for Admission Implementation Guide

Version 1.3.0

Tag Name	Schema Use	Description	Recommended Use	Format
[OrganizationIDGroup]	Optional	Allowable Organization IDs - Exclusive choice	Optional	minOcc 0 maxOcc 1
Comment: [OrganizationIDGroup] is not a tag and does not appear in the instance document. It requires the choice of one, and only one, of the following code set tags to identify the institution/organization.				
OPEID	Optional choice	The unique identifier assigned by the Office of Postsecondary Education for each data exchange partner. Includes all postsecondary schools that are eligible to participate in US Title IV federal financial aid programs.	Optional choice	minOcc 0 maxOcc 1 minLength 3 maxLength 8
Comment: The OPEID would be an appropriate choice if the applicant worked for a school.				
NCHelpID	Optional choice	The unique identifier assigned by National Council on Higher Education Loan Programs for each data exchange partner.	Optional choice	minOcc 0 maxOcc 1 minLength 3 maxLength 8
Comment: The NCHelpID would be an appropriate choice if the applicant was employed by a lending agency.				
IPEDS	Optional choice	The unique identifier for Integrated Postsecondary Education Data System assigned by the National Center for Education Statistics for postsecondary data exchange partners. Also called the Unit ID.	Optional choice	minOcc 0 maxOcc 1 minLength 6 maxLength 6
Comment: The IPEDS would be an appropriate choice if the applicant was employed by a school				
ATP	Optional choice	The unique identifier for the Admissions Testing Program assigned by the College Board for each data exchange partner.	Optional choice	minOcc 0 maxOcc 1 minLength 6 maxLength 6
Comment: The ATP would be an appropriate choice if the applicant was employed by a school				
FICE	Optional choice	The unique identifier once maintained for the Federal Interagency Committee on Education by the National Center for Education Statistics for each postsecondary data exchange partner.	Optional choice	minOcc 0 maxOcc 1 minLength 6 maxLength 6
Comment: Although the FICE code set is still widely used by many postsecondary institutions, it has not been maintained by NCES or anyone else since late in the last century. Therefore, codes for new institutions created since then, have been locally assigned and cannot be relied upon. However, if the applicant knows this code and was employed by a school, then this would be an acceptable choice.				
ACT	Optional choice	The unique identifier for postsecondary educational institutions assigned by American College Testing available at www.act.org	Optional choice	minOcc 0 maxOcc 1 minLength 4 maxLength 4
Comment: The ACT would be an appropriate choice if this Application for Admission is being sent to a postsecondary institution and the ACT number for that institution is known.				
CCD	Optional choice	The unique identifier assigned by the United States Department of Education's National Center for Education Statistics as the Common Core of Data for each data exchange partner.	Optional choice	minOcc 0 maxOcc 1 minLength 12 maxLength 12
Comment: The CCD is primarily a code set used by K12 and would be an option for this choice if the applicant worked for a school.				

PESC XML Application for Admission Implementation Guide

Version 1.3.0

Tag Name	Schema Use	Description	Recommended Use	Format
PSS	Optional choice	The unique identifier assigned by the United States Department of Education's National Center for Education Statistics for private secondary schools	Optional choice	minOcc 0 maxOcc 1 minLength 8 maxLength 8
Comment: The PSS is primarily a code set used by K12 and would be an option for this choice if the applicant worked for a school. It is updated every two years by NCES.				
CEEBACT	Optional choice	The unique identifier assigned by the College Entrance Examining Board and ACT for each K-12 data exchange partner.	Optional choice	minOcc 0 maxOcc 1 minLength 6 maxLength 6
Comment: The CEEBACT code set primarily includes K12 institutions and would be an option if the applicant worked for a school.				
CSIS	Optional choice	The unique identifier assigned by the Statistics Canada Canadian College Student Information System for each postsecondary data exchange partner.	Optional choice	minOcc 0 maxOcc 1 minLength 6 maxLength 6
Comment: The CSIS would be an appropriate choice if the applicant worked for a school in Canada. However, it is now being replaced by the PSIS code set for postsecondary schools in Canada.				
USIS	Optional choice	The unique identifier assigned by the Statistics Canada University Student Information System for each data postsecondary exchange partner.	Optional choice	minOcc 0 maxOcc 1 minLength 6 maxLength 6
Comment: The USIS would be an appropriate choice if the applicant worked for a postsecondary school in Canada. However, it is now being replaced by the PSIS code set for postsecondary schools in Canada.				
ESIS	Optional choice	The unique identifier assigned by the Statistics Canada Enhanced Student Information System for each data postsecondary exchange partner.	Optional choice	minOcc 0 maxOcc 1 minLength 8 maxLength 8
Comment: The ESIS would be an appropriate choice if this applicant was employed by a school in Canada.				
PSIS	Optional choice	The unique identifier assigned by the Statistics Canada Postsecondary Student Information System for each data postsecondary exchange partner.	Optional choice	minOcc 0 maxOcc 1 minLength 8 maxLength 8
Comment: The PSIS would be an appropriate choice if this applicant was employed by a postsecondary school in Canada.				
DUNS	Optional choice	Data Universal Numbering System (DUNS), unique nine character company identification number issued by Dun and Bradstreet Corporation.	Optional choice	minOcc 0 maxOcc 1 minLength 9 maxLength 9
Comment: The DUNS number would be an acceptable choice for an employer.				
MutuallyDefined	Optional choice	Mutually defined by the trading partners.	Optional choice	minOcc 0 maxOcc 1 minLength 1 maxLength 60
Comment: MutuallyDefined would be an acceptable choice for an employer if it were agreed upon in advance by the trading partners.				
APAS	Optional choice	Identification codes used by the Alberta Post-Secondary Application Systems.	Optional choice	minOcc 0 maxOcc 1 minLength 2 maxLength 12
Comment: This is an appropriate choice for institutions in Canada.				

PESC XML Application for Admission Implementation Guide Version 1.3.0

Tag Name	Schema Use	Description	Recommended Use	Format
Comment: End of OrganizationIDGroup optional choice set tags				
LocalOrganizationID	Optional	An identifier that is assigned by a state or other agency	Not Recommended	minOcc 0 maxOcc 1
Comment: The applicant would not typically know this ID.				
OrganizationName	Required	Name of Non-person entity such as Organization, Institution, Agency or Business.	Required	minOcc 1 maxOcc ∞ minLength 1 maxLength 60
Comment: Use repeated OrganizationName to indicate multiple names of the organization, or to include the specific department or area within the organization where the employment occurred.				
Contacts	Optional Repeatable	To identify a person or an office at the receiving school or agency to which administrative communications should be directed	Optional	minOcc 0 maxOcc ∞
Comment: Use Contacts to provide additional information about contacting current or previous employers. This complex data element will be expanded on page 204.				
NoteMessage	Optional Repeatable	Additional information about the employer	Not recommended	minOcc 0 maxOcc ∞ minLength 1 maxLength 80

Code illustration:

```

<Employer>
  <DUNS>123456789</DUNS>
  <LocalOrganizationID/>
  <OrganizationName>Starbucks</OrganizationName>
  <Contacts>

    </Contacts>
  <NoteMessage/>
</Employer>

```

PESC XML Application for Admission Implementation Guide Version 1.3.0

Applicant.Person.Employment.Employer.Contacts

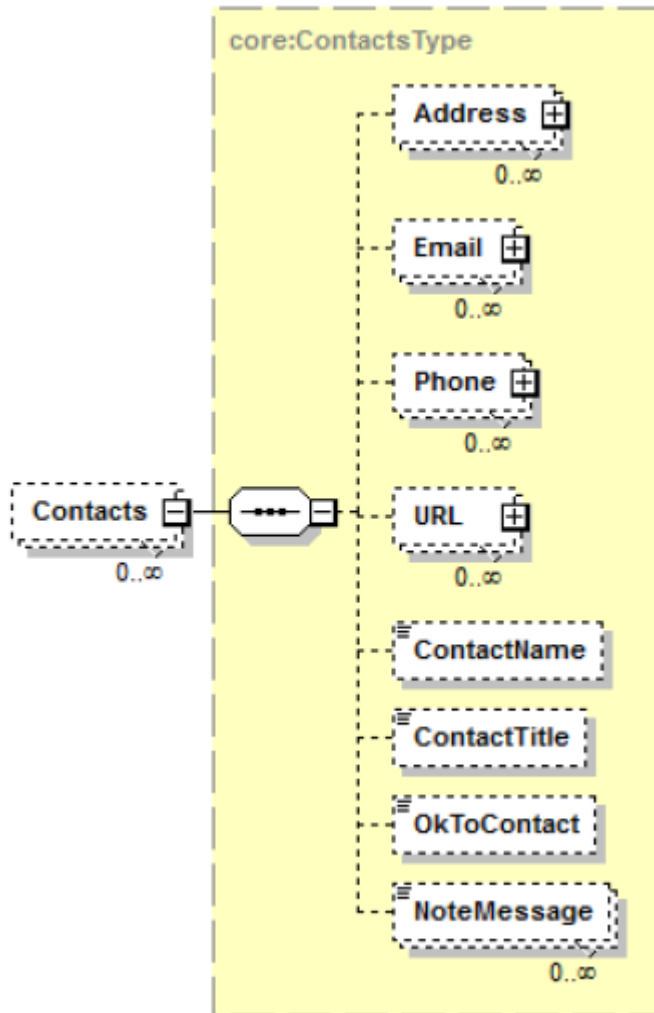

Tag Name	Schema Use	Description	Recommended Use	Format
Address	Optional Repeatabe	This is a combined Address Group for a choice between Domestic or International	Recommended	minOcc 0 maxOcc ∞
Comment: Additional information about the complex data element Address will be shown on page 206.				
Email	Optional Repeatabe	Email address of source company, agency or vendor contact	Optional	minOcc 0 maxOcc ∞
Comment: Additional information about the complex data element Email will be shown on page 209.				
Phone	Optional Repeatabe	Phone number of source company, agency or vendor contact	Recommended	minOcc 0 maxOcc ∞
Comment: Additional information about the complex data element Phone will be shown on page 210.				
URL	Optional Repeatabe	The Uniform Resource Locator of source company, agency or vendor	Optional	minOcc 0 maxOcc ∞
Comment: Additional information about the complex data element URL will be shown on page 212.				

PESC XML Application for Admission Implementation Guide

Version 1.3.0

Tag Name	Schema Use	Description	Recommended Use	Format
ContactName	Optional	The name of the contact at the place of employment	Optional	minOcc 0 maxOcc 1 minLength 0 maxLength 60
ContactTitle	Optional	The title of the contact at the place of employment.	Optional	minOcc 0 maxOcc 1 minLength 0 maxLength 60
OkToContact	Optional	An indication that it is OK to contact the employer about this application for admission	Optional	minOcc 0 maxOcc 1 Enumerations: No Yes
NoteMessage	Optional Repeatable	Additional information about the contacts at the employer (or former employer) of the applicant	Not recommended	minOcc 0 maxOcc ∞ minLength 1 maxLength 80

Code illustration:

```

<Contacts>
  <Address>
    </Address>
  <Email>
    </Email>
  <Phone>
    </Phone>
  <URL>
    </URL>
  <ContactName>Mr. Former Boss</ContactName>
  <ContactTitle>In Charge of Everything</ContactTitle>
  <OkToContact>Yes</OkToContact>
  <NoteMessage/>
</Contacts>

```

PESC XML Application for Admission Implementation Guide Version 1.3.0

Applicant.Person.Employment.Employer.Contacts.Address

Note: Although the complex data element Address is an optional data element, if you choose to send the Address of Contacts at the Source Company, Agency or Vendor, then you must send AddressLine and City and also StateProvinceCode, and PostalCode OR CountryCode.

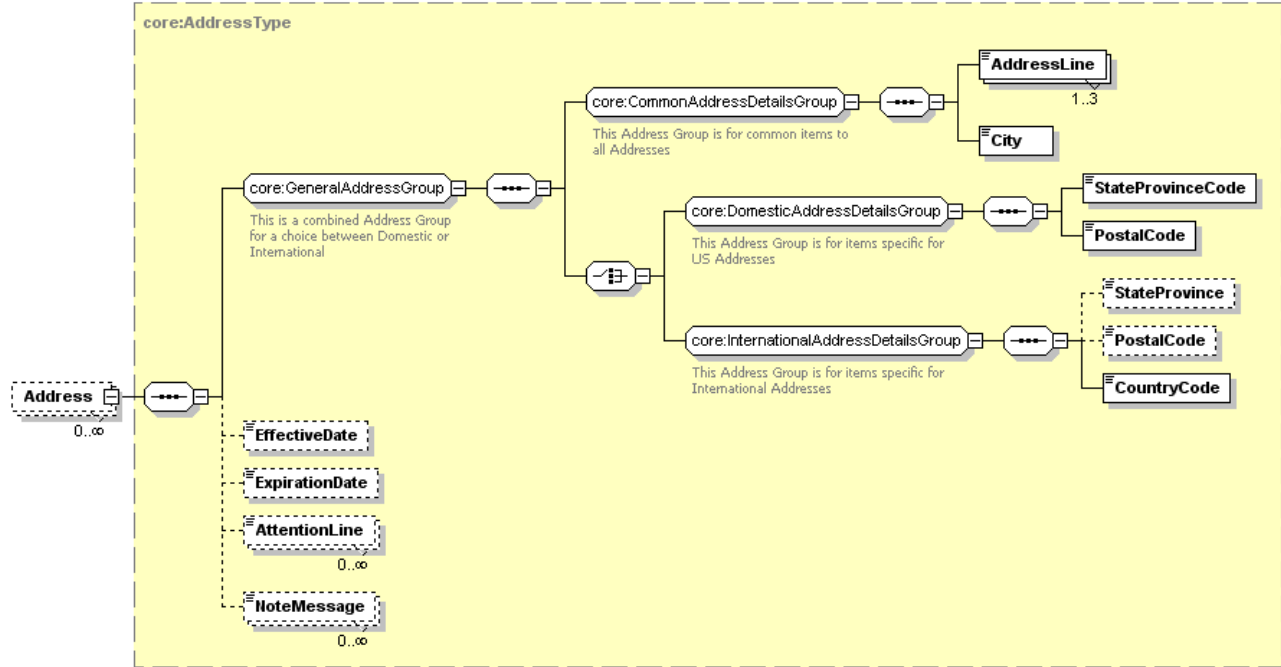

Tag Name	Schema Use	Description	Recommended Use	Format
GeneralAddressGroup	Required	This Address Group is for items common to all Addresses	Required	minOcc 1 maxOcc 1
Comment: [GeneralAddressGroup] does not appear in the instance document. It requires the use of CommonAddressDetailsGroup and the choice of one of either DomesticAddressDetailsGroup or InternationalAddressDetailsGroup. This group is required in the schema only if you choose to send the address of the contact.				
CommonAddressDetailsGroup	Required	This Address Group is for items common to all Addresses	Required	minOcc 1 maxOcc 1
Comment: [CommonAddressDetailsGroup] does not appear in the instance document. If the address of a contact is included in the Application for Admission, then this must be sent. It is required and must be paired with one of either DomesticAddressDetailsGroup or InternationalAddressDetailsGroup.				
AddressLine	Required Repeatable	Local delivery information such as street, building number, PO box, or apartment portion of a postal address of a Contact at the Sending (Source) Company, Agency or Vendor.	Required	minOcc 1 maxOcc 3 minLength 1 maxLength 40
City	Required	The city portion of the Address of a Contact at the Sending (Source) Company, Agency or Vendor.	Required	minOcc 1 maxOcc 1 minLength 2 maxLength 30

PESC XML Application for Admission Implementation Guide

Version 1.3.0

Tag Name	Schema Use	Description	Recommended Use	Format
<i>DomesticAddressDetails Group</i>	Required choice	This Address Group is for items specific for US and Canadian Addresses	Required for domestic addresses	minOcc 1 maxOcc 1
Comment: [DomesticAddressDetailsGroup] does not appear in the instance document. If the complex data element address has a United States or Canadian Postal Code and a US State or Canadian Province Code, then this should be the required choice.				
StateProvinceCode	Required	Code for US states, etc., and Canadian provinces.	Required	minOcc 1 maxOcc 1 Enumeration: See Appendix A
PostalCode	Required	The postal code portion of the Address.	Required	minOcc 1 maxOcc 1 minLength 1 maxLength 17
<i>InternationalAddressDetailsGroup</i>	Required choice	This Address Group is for items specific for International Addresses	Required for international addresses	minOcc 1 maxOcc 1
Comment: [InternationalAddressDetailsGroup] does not appear in the instance document. This choice is for addresses that do not have a US or Canadian postal code.				
StateProvince	Optional	The literal name of the state, province or territory of a postal address of the source of this document. Use for addresses outside US or Canada.	Recommended Refer to common postal practices of the source country	minOcc 0 maxOcc 1 minLength 2 maxLength 30
Comment: For an internet resource of states or other geographical subdivisions in countries other than the US and Canada, you might choose to refer to the website of the Universal Postal Union at http://www.upu.int				
PostalCode	Optional	The postal code portion of the Address.	Recommended Refer to common postal practices of the source country	minOcc 0 maxOcc 1 minLength 1 maxLength 17
Comment: For an internet resource of states or other geographical subdivisions in countries other than the US and Canada, you might choose to refer to the website of the Universal Postal Union at http://www.upu.int				
CountryCode	Required	Code indicating Country. Use ISO 3166-1 alpha-2 standard.	Required	minOcc 1 maxOcc 1 Enumerations: See Appendix B1 or B2
EffectiveDate	Optional	The date on which the address became (or will become) effective	Optional	minOcc 0 maxOcc 1 Date format: CCYY-MM-DD
ExpirationDate	Optional	The date on which the address will (or did) expire	Optional	minOcc 0 maxOcc 1 Date format: CCYY-MM-DD
AttentionLine	Optional Repeatable	The individual or office name within the postal address where inquiries should be directed.	Optional	minOcc 0 maxOcc ∞ minLength 1 maxLength 45
NoteMessage	Optional Repeatable	Additional information about the addresses of the employer	Not recommended	minOcc 0 maxOcc ∞ minLength 1 maxLength 80

PESC XML Application for Admission Implementation Guide Version 1.3.0

Applicant.Person.Employment.Employer.Contacts.Address (Continued)

Code illustration 1 (Domestic Address):

```
<Address>  
  <AddressLine>1715 W Cesar Chavez</AddressLine>  
  <City>Austin</City>  
  <StateProvinceCode>TX</StateProvinceCode>  
  <PostalCode>78703</PostalCode>  
  <EffectiveDate/>  
  <ExpirationDate/>  
  <AttentionLine/>  
  <NoteMessage/>  
</Address>
```

Code illustration 2 (International Address):

```
<Address>  
  <AddressLine>Altova Corporation</AddressLine>  
  <AddressLine>Rudolfsplatz 13a/9</AddressLine>  
  <City>Wien</City>  
  <StateProvince/>  
  <PostalCode>A-1010</PostalCode>  
  <CountryCode>AT</CountryCode>  
  <EffectiveDate/>  
  <ExpirationDate/>  
  <AttentionLine/>  
  <NoteMessage/>  
</Address>
```

PESC XML Application for Admission Implementation Guide Version 1.3.0

Applicant.Person.Employment.Employer.Contacts.Email

Note: Although the complex data element Email is an optional data element, if you choose to send the Email of an employer then you must send the data element EmailAddress.

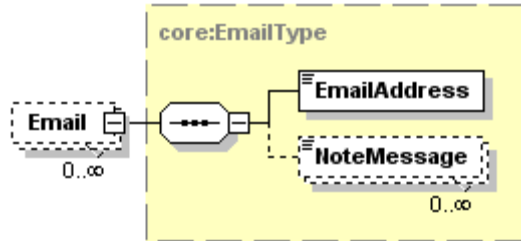

Tag Name	Schema Use	Description	Recommended Use	Format
EmailAddress	Required	The numbers, letters, and symbols used to identify an electronic mail (Email) user within a network.	Required	minOcc 1 maxOc 1 minLength 1 maxLength 128
NoteMessage	Optional Repeatable	Additional information about the email addresses of the employer	Not recommended	minOcc 0 maxOcc ∞ minLength 1 maxLength 80

Code illustration:

```
<Email>
  <EmailAddress>engineer@dowchemical.com</EmailAddress>
  <NoteMessage/>
</Email>
```

PESC XML Application for Admission Implementation Guide Version 1.3.0

Applicant.Person.Employment.Employer.Contacts.Phone

Note: Although the complex data element Phone is an optional data element, if you choose to send the Phone of a Contact at the employer, then you must send a phone number.

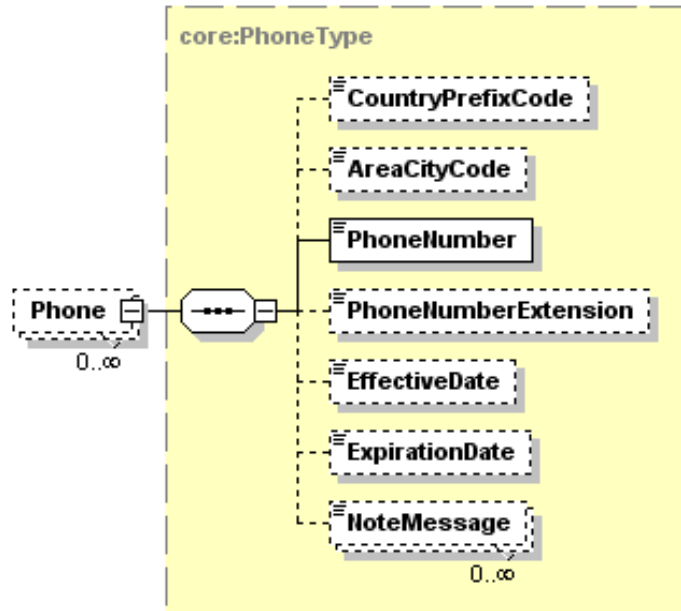

Tag Name	Schema Use	Description	Recommended Use	Format
CountryPrefixCode	Optional	International dialing code	Recommended	minOcc 0 maxOcc 1 minLength 1 maxLength 3
AreaCityCode	Optional	Regional dialing code	Recommended	minOcc 0 maxOcc 1 minLength 1 maxLength 5
PhoneNumber	Required	Telephone number	Required	minOcc 1 maxOcc 1 minLength 1 maxLength 11
<i>Comment: The phone number will typically be sent as a string of numbers with no spaces, periods nor dashes.</i>				
PhoneNumberExtension	Optional	The extended telephone addressing information used in addition to phone number such as a PBX extension, a pager PIN, or FAX sub-address	Optional	minOcc 0 maxOcc 1 minLength 1 maxLength 5
EffectiveDate	Optional	The date on which the phone number became (or will become) effective	Optional	minOcc 0 maxOcc 1 Date format: CCYY-MM-DD
ExpirationDate	Optional	The date on which the phone number will (or did) expire	Optional	minOcc 0 maxOcc 1 Date format: CCYY-MM-DD
NoteMessage	Optional Repeatable	Additional information about the phone numbers of the contacts at the source school	Not recommended	minOcc 0 maxOcc ∞ minLength 1 maxLength 80

PESC XML Application for Admission Implementation Guide Version 1.3.0

Applicant.Person.Employment.Employer.Contacts.Phone (Continued)

Code illustration:

```
<Phone>  
  <CountryPrefixCode/>  
  <AreaCityCode>512</AreaCityCode>  
  <PhoneNumber>4142505</PhoneNumber>  
  <PhoneNumberExtension/>  
  <EffectiveDate/>  
  <ExpirationDate/>  
  <NoteMessage/>  
</Phone>
```

PESC XML Application for Admission Implementation Guide Version 1.3.0

Applicant.Person.Employment.Employer.Contacts.URL

Note: Although the complex data element URL is an optional data element, if you choose to send the URL of the employer, then you must send the URLAddress.

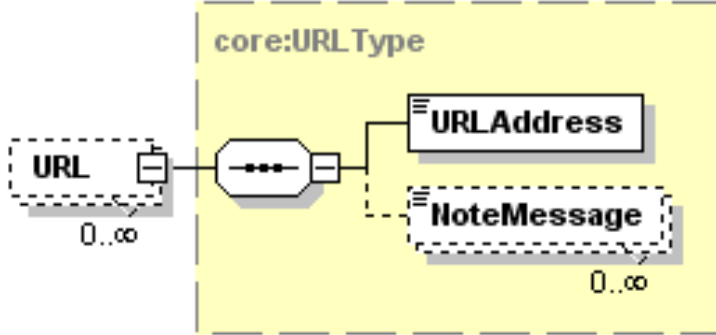

Tag Name	Schema Use	Description	Recommended Use	Format
URLAddress	Required	The Uniform Resource Locator (URL) address of the sending company, agency or vendor, or of a contact at the sending company, agency or vendor	Required	minOcc 1 maxOcc 1 minLength 1 maxLength 512
NoteMessage	Optional Repeatable	Additional information about the URL address of the employer	Not recommended	minOcc 0 maxOcc ∞ minLength 1 maxLength 80

Code illustration:

```
<URL>
  <URLAddress>www.anyhighschool.edu</URLAddress>
  <NoteMessage/>
</URL>
```

PESC XML Application for Admission Implementation Guide Version 1.3.0

Applicant.Person.Language

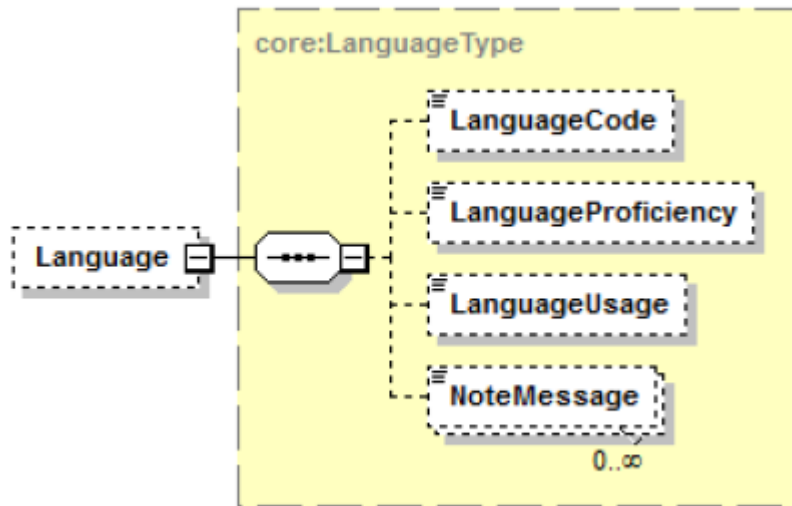

Tag Name	Schema Use	Description	Recommended Use	Format
LanguageCode	Optional	Information about the applicant's achievements in languages	Recommended	minOcc 0 maxOcc 1 minLength 3 maxLength 3 See Appendix C
LanguageProficiency	Optional	The proficiency level of the applicant in this language	Optional	minOcc 0 maxOcc 1 Enumerations: EnglishOnly Excellent Fair FullyEnglishProficient Good LimitedEnglishProficiency NonEnglishSpeaking Poor RedesignatedFluentEnglishProficient Unacceptable Unknown
LanguageUsage	Optional	The type of use of this language in which the student claims proficiency	Optional	minOcc 0 maxOcc 1 Enumerations: FirstSpokenLanguage Native Reading Speaking SpokenAtHome Writing WrittenCommunication
NoteMessage	Optional Repeatable	Additional information about the proficiency of the applicant in this language	Not Recommended	minOcc 0 maxOcc ∞ minLength 1 maxLength 80

PESC XML Application for Admission Implementation Guide Version 1.3.0

Applicant.Person.Language (Continued)

Code illustration:

```
<Language>  
  <LanguageCode>FRE</LanguageCode>  
  </LanguageProficiency>Excellent</LanguageProficiency>  
  <LanguageUsage>Native</LanguageUsage>  
  <NoteMessage/>  
</Language>
```

PESC XML Application for Admission Implementation Guide Version 1.3.0

Applicant.Family

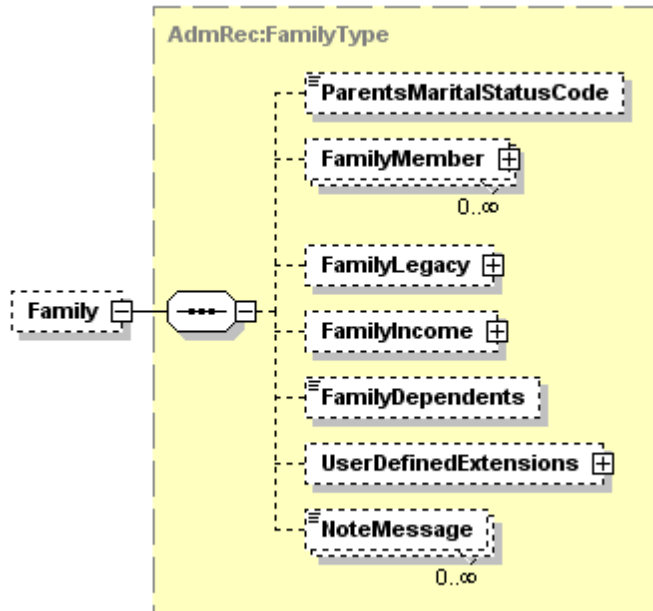

Tag Name	Schema Use	Description	Recommended Use	Format
ParentsMaritalStatusCode	Optional	Information about the marital status of the applicant's family	Optional	minOcc 0 maxOcc 1 Enumerations: CommonLaw Divorced LegallySeparated Married NeverMarried RegisteredDomesticPartners Separated Single Unknown Unmarried Unreported Widowed
Comment: It is intended that the above marital status code would describe the status of the marriage of the applicants original parents.				
FamilyMember	Optional Repeatable	Information about the applicant's family member	Optional	minOcc 0 maxOcc ∞
Comments: Additional information about the complex data element FamilyMember will be shown on page 217.				
FamilyLegacy	Optional	Information about the applicant's family who might have legacy ties to the school to which the applicant is applying	Optional	minOcc 0 maxOcc 1
Comments: Additional information about the complex data element FamilyLegacy will be shown on page 247.				
FamilyIncome	Optional	Information about the applicant's parents' or guardian's net earnings in a year	Optional	minOcc 0 maxOcc 1
Comments: Additional information about this complex data element will be shown on page 248.				
FamilyDependents	Optional	The number of members of the applicant's family that are dependents of the family	Optional	minOcc 0 maxOcc 1 An integer

PESC XML Application for Admission Implementation Guide

Version 1.3.0

Tag Name	Schema Use	Description	Recommended Use	Format
UserDefinedExtensions	Optional	A mini schema that can be inserted that will be used by selected partners. Others that are not interested in it can ignore it.	Optional	minOcc 0 maxOcc 1
NoteMessage	Optional Repeatable	Additional information about the family of the applicant	Not recommended	minOcc 0 maxOcc ∞ minLength 1 maxLength 80

Applicant.Family (Continued)

Code illustration:

```

<Family>
  <ParentsMaritalStatusCode>Married</ParentsMaritalStatusCode>
  <FamilyMember>

    </FamilyMember>
    <FamilyLegacy>

      </FamilyLegacy>
      <FamilyIncome>

        </FamilyIncome>
        <FamilyDependents>2</FamilyDependents>
        <UserDefinedExtensions/>
        <NoteMessage/>
      </Family>
    </Family>
  
```

PESC XML Application for Admission Implementation Guide Version 1.3.0

Applicant.Family.FamilyMember

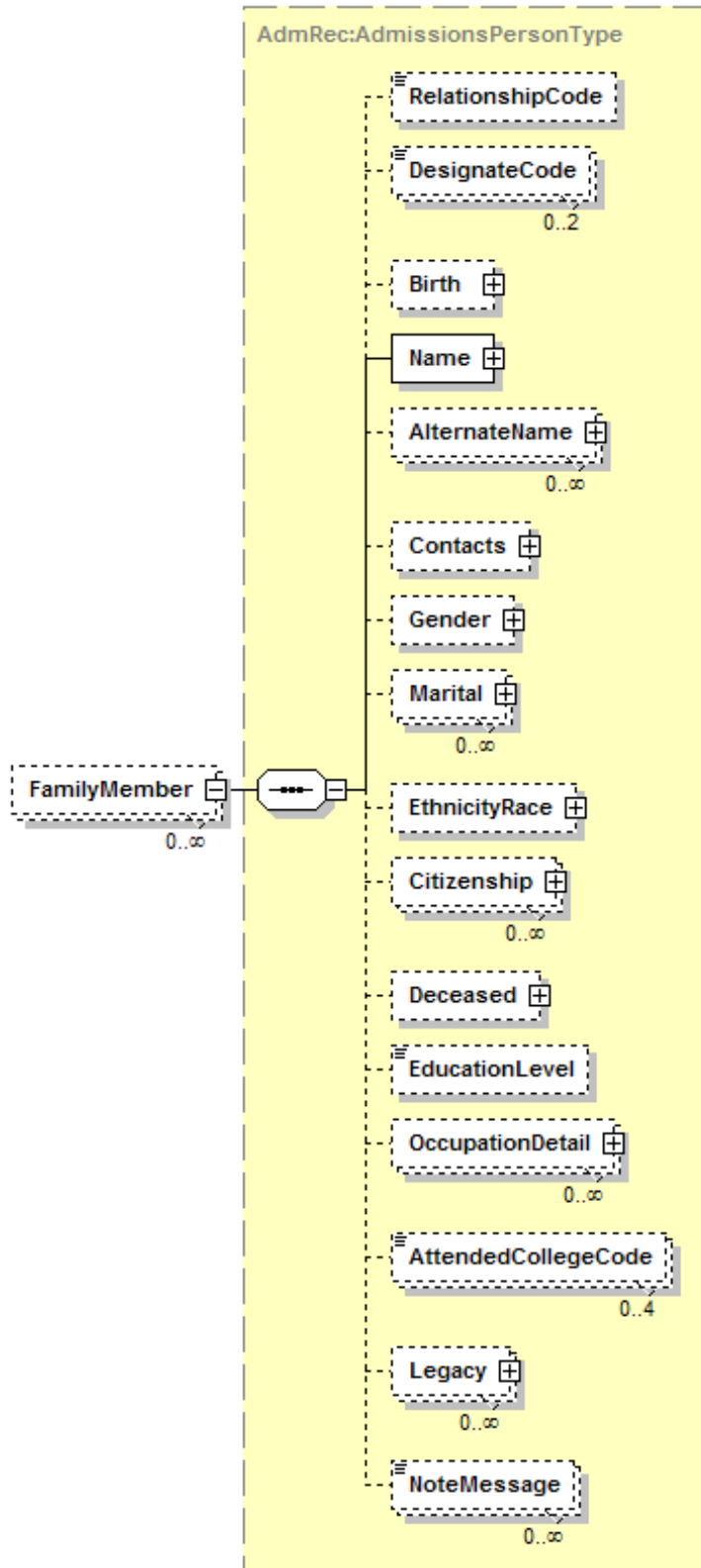

PESC XML Application for Admission Implementation Guide Version 1.3.0

Applicant.Family.FamilyMember (Continued)

Tag Name	Schema Use	Description	Recommended Use	Format
RelationshipCode	Optional	Relationship of this family member to the applicant	Optional	minOcc 0 maxOcc 1 See codes in Appendix D
DesignateCode	Optional Repeatable	An indication that this person has been designated with special authority by the applicant	Optional	minOcc 0 maxOcc 2 Enumerations: AuthorizedDesignate EmergencyContact
Birth	Optional	Information related to the birth of the family member of the applicant	Optional	minOcc 0 maxOcc 1
Comments: This complex data element will be expanded on page 221.				
Name	Required	The name of the family member of the applicant	Required	minOcc 1 maxOcc 1
Comments: This complex data element will be expanded on page 223.				
AlternateName	Optional Repeatable	Alternate names for the family member of the applicant	Optional	minOcc 0 maxOcc ∞
Comments: This complex data element will be expanded on page 225.				
Contacts	Optional Repeatable	Information about the contacts for the family member of the applicant	Optional	minOcc 0 maxOcc ∞
Comments: This complex data element will be expanded on page 227. It is strongly recommended that only one iteration of this data element be included in the instance document.				
Gender	Optional	The gender of the family member of the applicant	Optional	minOcc 0 maxOcc 1
Comments: This complex data element will be expanded on page 236.				
Marital	Optional Repeatable	The marital status of the family member of the applicant	Optional	minOcc 0 maxOcc ∞
Comments: This complex data element will be expanded on page 237.				
EthnicityRace	Optional	The race and/or ethnicity of the family member of the applicant using the new values now being used by the US Department of Education's National Center for Education Statistics	Optional	minOcc 0 maxOcc 1
Comments: This complex data element will be expanded on page 238.				
Citizenship	Optional Repeatable	The citizenship information about the family member of the applicant	Optional	minOcc 0 maxOcc ∞
Comments: This complex data element will be expanded on page 239.				
Deceased	Optional	Information about the deceased status of the family member of the applicant	Optional	minOcc 0 maxOcc 1
Comments: This complex data element will be expanded on page 240.				

PESC XML Application for Admission Implementation Guide

Version 1.3.0

Tag Name	Schema Use	Description	Recommended Use	Format
EducationLevel	Optional	The highest level of education already attained by the family member of the applicant	Recommended	minOcc 0 maxOcc 1 Enumerations: AssociateDegree BaccalaureateDegree CollegeAttended CollegeCertificate CollegeDiploma DoctoralDegree Elementary FourYearCollegeGraduate HighSchoolAttended HighSchoolGraduate JuniorHighSchool MastersDegree MiddleSchool NoHighSchool None PostGraduateStudy ProfessionalAttended ProfessionalCertification ProfessionalDegree SecondarySchool TwoYearCollegeGraduate VocationalSchool
OccupationDetail	Optional Repeatable	The occupation(s) of the family member of the applicant	Optional	minOcc 0 maxOcc ∞
Comments: This complex data element will be expanded on page 241. This complex data element may be used to provide the name of the occupation and the employer of the family member.				
AttendedCollegeCode	Optional Repeatable	An indication of which family members attended college	Optional	minOcc 0 maxOcc 4 Enumerations: EitherParent GrandParent Siblings Spouse
Legacy	Optional Repeatable	Information about this family member's current or previous enrollment at the school to which the applicant is applying	Optional	minOcc 0 maxOcc ∞
Comments: This complex data element will be expanded on page 246.				
NoteMessage	Optional Repeatable	Additional information about the family member of the applicant	Not Recommended	minOcc 0 maxOcc ∞ minLength 1 maxLength 80

PESC XML Application for Admission Implementation Guide Version 1.3.0

Applicant.Family.FamilyMember (Continued)

Code illustration:

```
<FamilyMember>
  <RelationshipCode>Father</RelationshipCode>
  <DesignateCode>EmergencyContact</DesignateCode>
  <DesignateCode>AuthorizedDesignate</DesignateCode>
  <Birth>

  </Birth>
  <Name>

  </Name>
  <AlternateName>

  </AlternateName>
  <Contacts>

  </Contacts>
  <Gender>

  </Gender>
  <Marital>

  </Marital>
  <EthnicityRace>

  </EthnicityRace>
  <Citizenship>

  </Citizenship>
  <Deceased>

  </Deceased>
  <EducationLevel>CollegeDiploma</EducationLevel>
  <OccupationDetail>

  </OccupationDetail>
  <AttendedCollegeCode>EitherParent</AttendedCollegeCode>
  <Legacy>

  </Legacy>
  <NoteMessage/>
</FamilyMember>
```

PESC XML Application for Admission Implementation Guide Version 1.3.0

Applicant.Family.FamilyMember.Birth

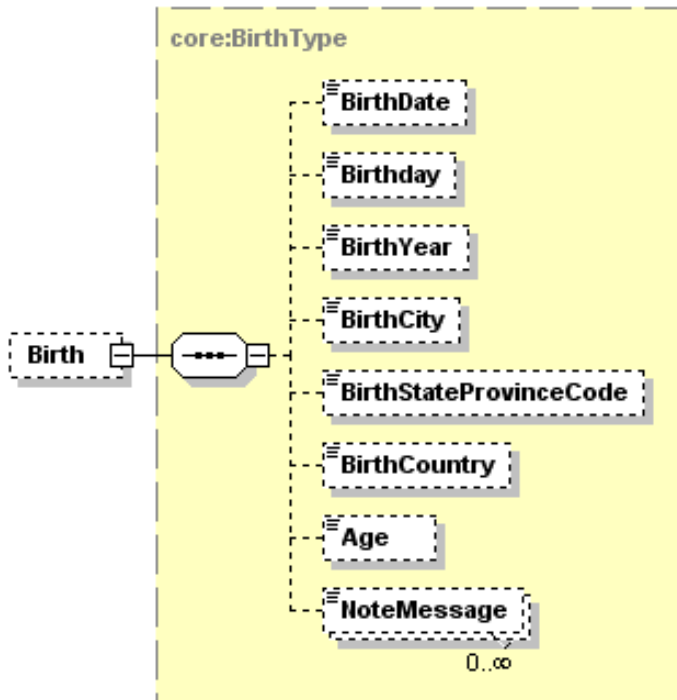

Tag Name	Schema Use	Description	Recommended Use	Format
BirthDate	Optional	Date of Birth	Recommended	minOcc 0 maxOcc 1 xs:date Format is ccyy-mm-dd
Comment: It is recommended by the Workgroup that the family member's complete date of birth be included with the application for admission, if any information about the birth of the family member is included.				
Birthday	Optional	Month and Day of Birth	Not Recommended	minOcc 0 maxOcc 1 xs:gMonthDay Format is --mm-dd
Comment: Use instead of BirthDate when it is desirable to withhold the person's age. It would not be appropriate for the family member.				
BirthYear	Optional	The year of birth of the family member	Optional	minOcc 0 maxOcc 1 Use year as ccyy
Comment: The use of the entire birth date above is recommended. However, if the entire date of birth is not available, then it would be recommended to at least supply the year of birth if it is available.				
BirthCity	Optional	The city in which the family member was born	Optional	minOcc 0 maxOcc 1 minLength 1 maxLength 25

PESC XML Application for Admission Implementation Guide

Version 1.3.0

Tag Name	Schema Use	Description	Recommended Use	Format
BirthStateProvinceCode	Optional	The state or province in which the family member was born	Optional	minOcc 0 maxOcc 1 Enumerations: See code set of states and provinces in Appendix A
BirthCountry	Optional	The country in which the family member was born	Recommended	minOcc 0 maxOcc 1 Enumerations: See code sets of countries in Appendix B1 or B2
Age	Optional	The age of the person	Not Recommended	minOcc 0 maxOcc 1 Format is positive integer
NoteMessage	Optional Repeatable	Additional information about the birth of the family member	Not Recommended	minOcc 0 maxOcc ∞ minLength 1 maxLength 80

Code illustration:

```

<Birth>
  <BirthDate>1944-05-23</BirthDate>
  <BirthDay/>
  <BirthYear/>
  <BirthCity>Boca Raton</BirthCity>
  <BirthStateProvinceCode>FL</BirthStateProvinceCode>
  <BirthCountry>US</BirthCountry>
  <Age/>
  <NoteMessage/>
</Birth>

```

PESC XML Application for Admission Implementation Guide Version 1.3.0

Applicant.Family.FamilyMember.Name

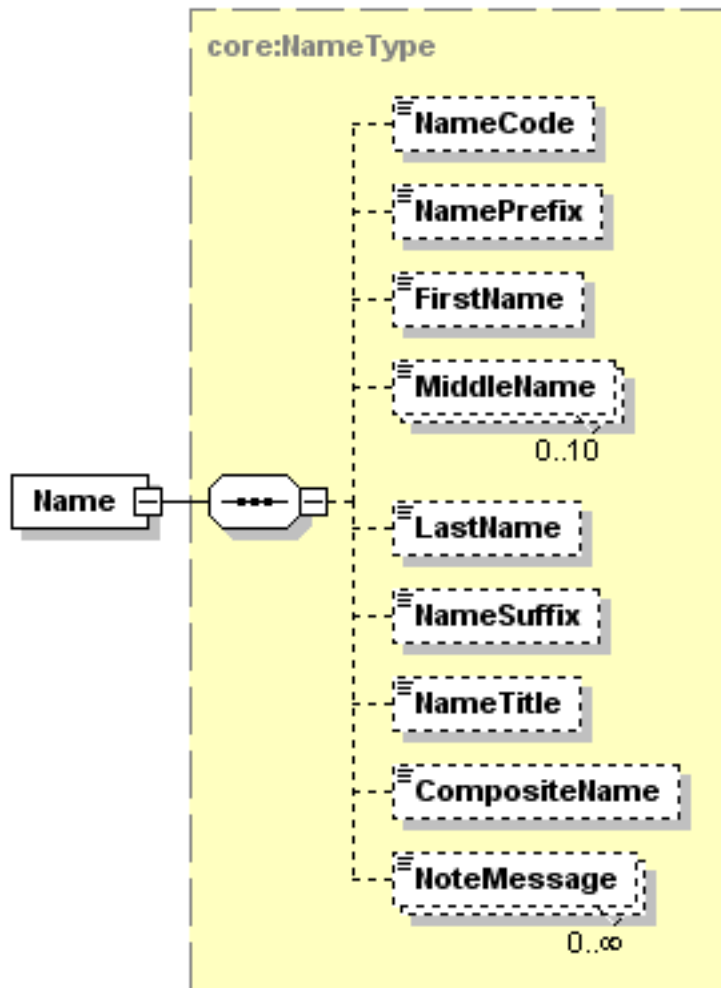

Tag Name	Schema Use	Description	Recommended Use	Format
NameCode	Optional	The type of name being included	Recommended	minOcc 0 maxOcc 1 Enumerations: Casual Formal Former LawSchoolApplicationSource Legal MedicalSchoolApplicationSource Nickname Other
NamePrefix	Optional	An honorific, title or form of address that precedes the name.	Not Recommended	minOcc 0 maxOcc 1 minLength 1 maxLength 30

Comment: The honorific includes such data as “Dr.,” “Professor,” “Miss”, etc. The Workgroup felt that it could do more harm than good to include this information and make it available to the school.

PESC XML Application for Admission Implementation Guide

Version 1.3.0

Tag Name	Schema Use	Description	Recommended Use	Format
FirstName	Optional	The first name of the person, usually given at birth, baptism, or during, another ceremony, or through legal change	Recommended	minOcc 0 maxOcc 1 minLength 1 maxLength 35
MiddleName	Optional Repeatable	A secondary name of the person, usually given at birth, baptism, or during another naming ceremony or through legal change	Recommended	minOcc 0 maxOcc 10 minLength 1 maxLength 35
LastName	Optional	The last name or surname by which a person is legally known	Recommended	minOcc 0 maxOcc 1 minLength 1 maxLength 35
NameSuffix	Optional	The expression of an individual's generation within a family.	Recommended	minOcc 0 maxOcc 1 Enumeration: I II III IV V VI VII VIII IX X JR SR
NameTitle	Optional	An honorific, title or credential that follows the name.	Not Recommended	minOcc 0 maxOcc 1 minLength 1 maxLength 30
CompositeName	Optional	The full name of the person in Last Name (space) Suffix (comma) First Name (space) Middle Names (spaces). A comma would be included after last name or NameSuffix.	Not Recommended	minOcc 0 maxOcc 1 minLength 1 maxLength 45
NoteMessage	Optional Repeatable	Additional information about the family member's name	Not Recommended	minOcc 0 maxOcc ∞ minLength 1 maxLength 80

Code illustration:

```

<Name>
  <NameCode>Formal</NameCode>
  <NamePrefix/>
  <FirstName>John</FirstName>
  <MiddleName>Billy</MiddleName>
  <MiddleName>Bob</MiddleName>
  <LastName>Thornton</LastName>
  <NameSuffix>JR</NameSuffix>
  <NameTitle/>
  <CompositeName/>
  <NoteMessage/>
</Name>

```

PESC XML Application for Admission Implementation Guide Version 1.3.0

Applicant.Family.FamilyMember.AlternateName

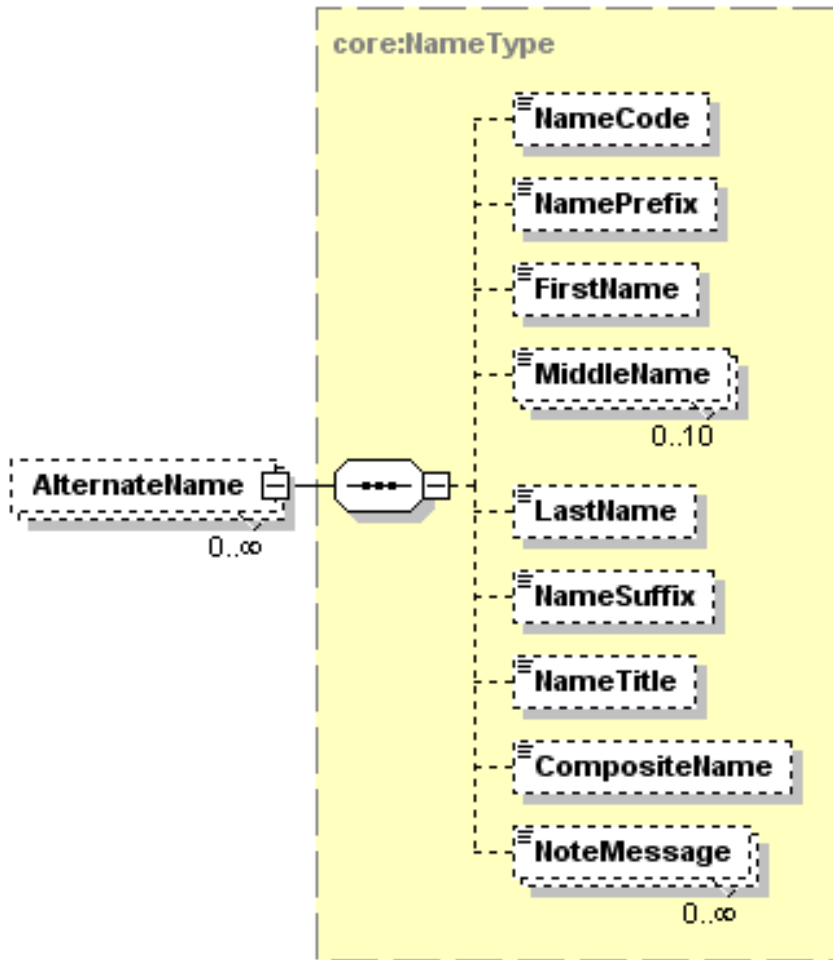

Tag Name	Schema Use	Description	Recommended Use	Format
NameCode	Optional	A code that indicates the type of alternate name that is being described	Recommended	minOcc 0 maxOcc 1 Enumeration: Casual Formal Former LawSchoolApplicationSource Legal MedicalSchoolApplicationSource Nickname Other
NamePrefix	Optional	An honorific, title or form of address that precedes the name.	Not Recommended	minOcc 0 maxOcc 1 minLength 1 maxLength 30
FirstName	Optional	The first name of the person, usually given at birth, baptism, or during, another ceremony, or through legal change	Recommended	minOcc 0 maxOcc 1 minLength 1 maxLength 35

PESC XML Application for Admission Implementation Guide

Version 1.3.0

Tag Name	Schema Use	Description	Recommended Use	Format
MiddleName	Optional Repeatable	A secondary Name of the person, usually given at birth, baptism, or during another naming ceremony or through legal change	Recommended	minOcc 0 maxOcc 10 minLength 1 maxLength 35
LastName	Optional	The last name or surname by which a person is legally known	Recommended	minOcc 1 maxOcc 1 minLength 1 maxLength 35
NameSuffix	Optional	The expression of an individual's generation within a family.	Recommended	minOcc 0 maxOcc 1 Enumeration: I II III IV V VI VII VIII IX X JR SR
NameTitle	Optional	An honorific, title or credential that follows the name.	Not Recommended	minOcc 0 maxOcc 1 minLength 1 maxLength 30
CompositeName	Optional	The full name of the person in Last, First Middle order, comma after last name	Not Recommended	minOcc 0 maxOcc 1 minLength 1 maxLength 45
Comment: The use of the composite format for student name is discouraged. It is much easier for the receiving school to process the individual name parts into its data base than to process a composite name. This data element is scheduled to be deleted in a future release of the standard.				
NoteMessage	Optional Repeatable	Additional information about the alternate name	Not Recommended	minOcc 0 maxOcc ∞ minLength 1 maxLength 80
Comment: Alternate names may include former names, nicknames, or other names by which the student may now be (or have been) known.				

Code illustration:

```

<AlternateName>
  <NameCode>Casual</NameCode>
  <NamePrefix/>
  <FirstName>Test</FirstName>
  <MiddleName>Record</MiddleName>
  <MiddleName>Test</MiddleName>
  <LastName>Speede</LastName>
  <NameSuffix/>
  <NameTitle/>
  <CompositeName/>
  <NoteMessage/>
</AlternateName>

```

PESC XML Application for Admission Implementation Guide Version 1.3.0

Applicant.Family.FamilyMember.Contacts

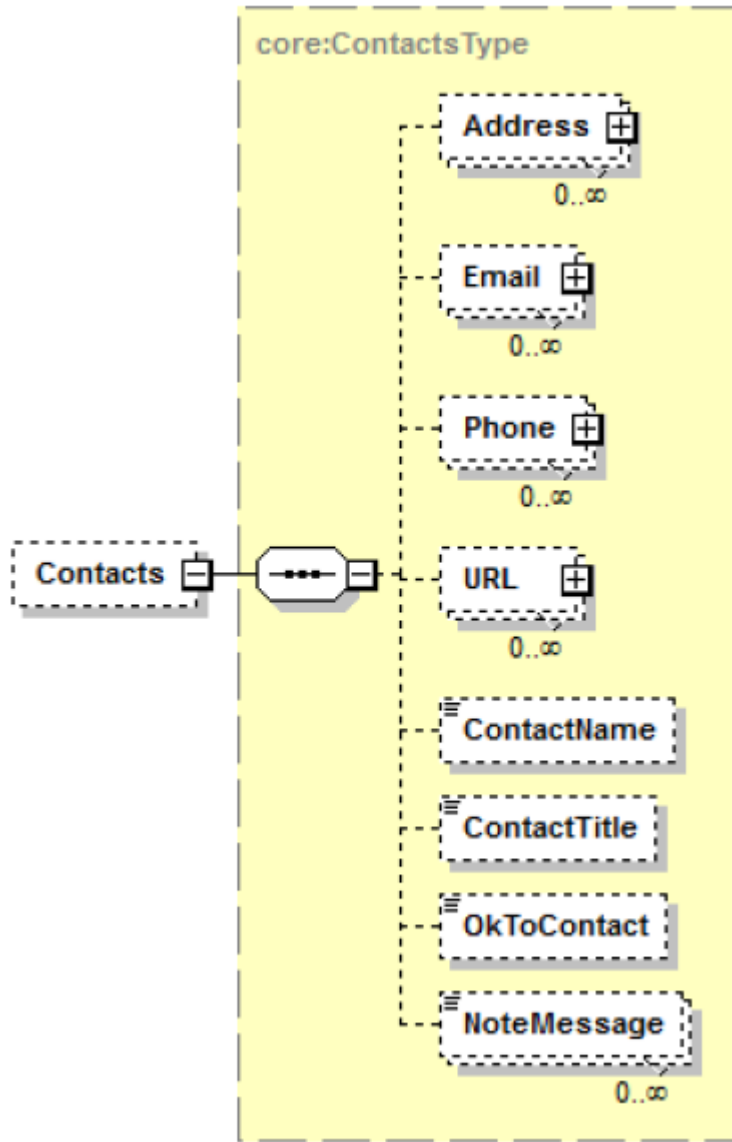

Tag Name	Schema Use	Description	Recommended Use	Format
Address	Optional Repeatable	This is a combined Address Group for a choice between Domestic or International	Recommended	minOcc 0 maxOcc ∞
Comment: Additional information about the complex data element Address for the family member will be shown on page 229.				
Email	Optional Repeatable	Email address(es) for the family member	Recommended	minOcc 0 maxOcc ∞
Comment: Additional information about the complex data element Email will be shown on page 232.				
Phone	Optional Repeatable	Phone number(s) for the family member	Recommended	minOcc 0 maxOcc ∞

PESC XML Application for Admission Implementation Guide Version 1.3.0

Tag Name	Schema Use	Description	Recommended Use	Format
Comment: Additional information about the complex data element Phone will be shown on page 234.				
URL	Optional Repeatable	Personal URL(s) for the family member	Optional	minOcc 0 maxOcc ∞
Comment: Additional information about the complex data element URL will be shown on page 235.				
ContactName	Optional	The name of the contact	Not Recommended	minOcc 0 maxOcc 1 minLength 0 maxLength 60
Comment: It is not necessary to include the contact name here since it has already been included.				
ContactTitle	Optional Repeatable	This is the title of the contact	Not Recommended	minOcc 0 maxOcc 1 minLength 0 maxLength 60
Comment: It is probably not necessary to include this at this place in the schema				
OkToContact	Optional Repeatable	An indication that it is OK to contact this person	Optional	minOcc 0 maxOcc 1 Enumerations: No Yes
NoteMessage	Optional Repeatable	Additional information about the contacts for the family member	Not Recommended	minOcc 0 maxOcc ∞ minLength 1 maxLength 80

Applicant.Family.FamilyMember.Contacts (Continued)

Code illustration:

```

<Contacts>
  <Address>

  </Address>
  <Email>

  </Email>
  <Phone>

  </Phone>
  <URL>

  </URL>
  <ContactName/>
  <ContactTitle/>
  <OkToContact>Yes</OkToContact>
  <NoteMessage/>
</Contacts>

```

PESC XML Application for Admission Implementation Guide Version 1.3.0

Applicant.Family.FamilyMember.Contacts.Address

Note: Although the complex data element Address is an optional data element, if you choose to send the Address of the Family Member, then you must send AddressLine and City and also StateProvinceCode, and PostalCode OR CountryCode.

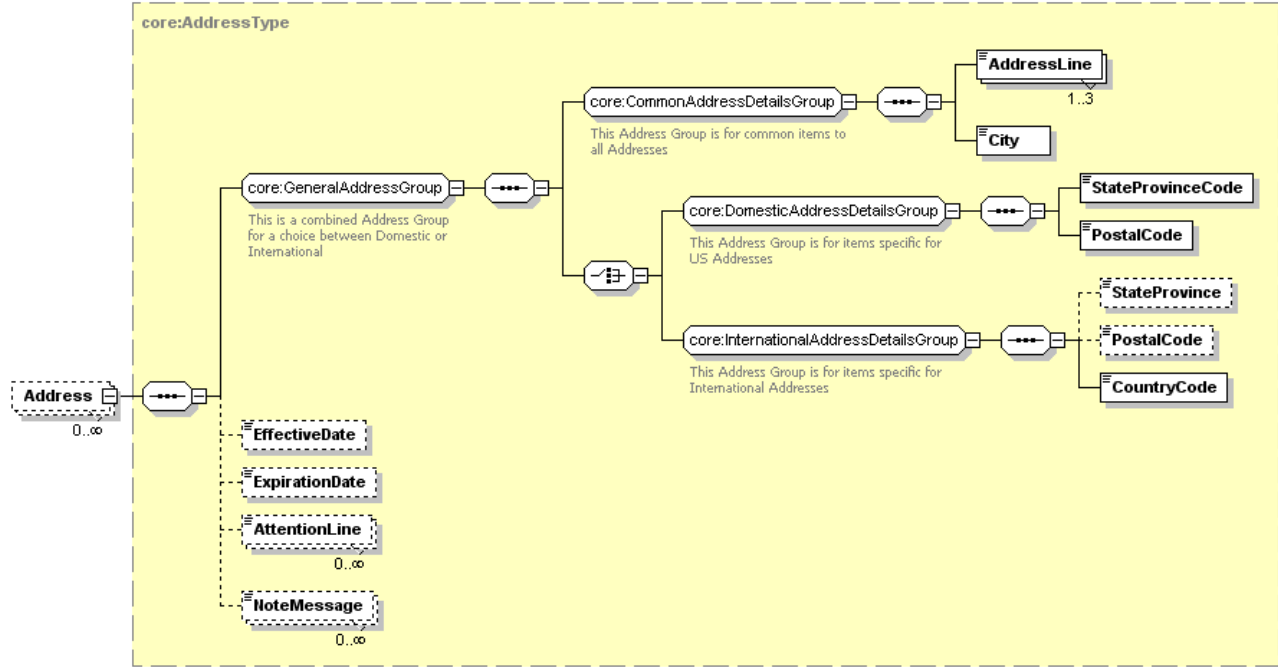

Tag Name	Schema Use	Description	Recommended Use	Format
GeneralAddressGroup	Required	This Address Group is for items common to all Addresses	Required	minOcc 1 maxOcc 1
Comment: [GeneralAddressGroup] does not appear in the instance document. It requires the use of CommonAddressDetailsGroup and the choice of one of either DomesticAddressDetailsGroup or InternationalAddressDetailsGroup. This group is required in the schema only if you choose to send the address of the family member.				
CommonAddressDetailsGroup	Required	This Address Group is for items common to all Addresses	Required	minOcc 1 maxOcc 1
Comment: [CommonAddressDetailsGroup] does not appear in the instance document. If the address of the family member is included, then this must be sent. It is required and must be paired with one of either DomesticAddressDetailsGroup or InternationalAddressDetailsGroup.				
AddressLine	Required Repeatable	Local delivery information such as street, building number, PO box, or apartment portion of a postal address of the family member	Required	minOcc 1 maxOcc 3 minLength 1 maxLength 40
City	Required	The city portion of the Address of the family member	Required	minOcc 1 maxOcc 1 minLength 2 maxLength 30

PESC XML Application for Admission Implementation Guide

Version 1.3.0

Tag Name	Schema Use	Description	Recommended Use	Format
<i>DomesticAddressDetailsGroup</i>	Required choice	This Address Group is for items specific for US and Canadian Addresses	Required for domestic addresses	minOcc 1 maxOcc 1
Comment: [<i>DomesticAddressDetailsGroup</i>] and does not appear in the instance document. If the complex data element address has a United States or Canadian Postal Code and a US State or Canadian Province Code, then this should be the required choice.				
StateProvinceCode	Required	Code for US states, etc., and Canadian provinces.	Required for US and Canadian addresses	minOcc 1 maxOcc 1 Enumerations: See Appendix A
PostalCode	Required	The postal code portion of the Address.	Required for US and Canadian addresses	minOcc 1 maxOcc 1 minLength 1 maxLength 17
<i>InternationalAddressDetailsGroup</i>	Required choice	This Address Group is for items specific for International Addresses	Required for international addresses	minOcc 1 maxOcc 1
Comment: [<i>InternationalAddressDetailsGroup</i>] does not appear in the instance document. This choice is for addresses that do not have a US or Canadian postal code.				
StateProvince	Optional	The literal name of the state, province or territory of a postal address of the source of this document. Use for addresses outside US or Canada.	Recommended Refer to common postal practices of the source country	minOcc 0 maxOcc 1 minLength 2 maxLength 30
Comment: For an internet resource of states or other geographical subdivisions in countries other than the US and Canada, you might choose to refer to the website of the Universal Postal Union at http://www.upu.int				
PostalCode	Optional	The postal code portion of the Address.	Recommended Refer to common postal practices of the source country	minOcc 0 maxOcc 1 minLength 1 maxLength 17
Comment: For an internet resource of states or other geographical subdivisions in countries other than the US and Canada, you might choose to refer to the website of the Universal Postal Union at http://www.upu.int				
CountryCode	Required	Code indicating Country. Use ISO 3166-1 alpha-2 standard.	Required	minOcc 1 maxOcc 1 Enumerations: See Appendix B1 or B2
EffectiveDate	Optional	The date on which the address became (or will become) effective	Optional	minOcc 0 maxOcc 1 Date format: CCYY-MM-DD
ExpirationDate	Optional	The date on which the address will (or did) expire	Optional	minOcc 0 maxOcc 1 Date format: CCYY-MM-DD
AttentionLine	Optional	The individual or office name within the postal address where inquiries should be directed.	Optional	minOcc 0 maxOcc ∞ minLength 1 maxLength 45
NoteMessage	Optional Repeatable	Additional information about the addresses of the family member	Not recommended	minOcc 0 maxOcc ∞ minLength 1 maxLength 80

PESC XML Application for Admission Implementation Guide Version 1.3.0

Applicant.Family.FamilyMember.Contacts.Address (Continued)

Code illustration 1 (Domestic Address):

```
<Address>  
  <AddressLine>1715 W Cesar Chavez</AddressLine>  
  <City>Austin</City>  
  <StateProvinceCode>TX</StateProvinceCode>  
  <PostalCode>78703</PostalCode>  
  <EffectiveDate/>  
  <ExpirationDate/>  
  <AttentionLine/>  
  <NoteMessage/>  
</Address>
```

Code illustration 2 (International Address):

```
<Address>  
  <AddressLine>Altova Corporation</AddressLine>  
  <AddressLine>Rudolfsplatz 13a/9</AddressLine>  
  <City>Wien</City>  
  <StateProvince/>  
  <PostalCode>A-1010</PostalCode>  
  <CountryCode>AT</CountryCode>  
  <EffectiveDate/>  
  <ExpirationDate/>  
  <AttentionLine/>  
  <NoteMessage/>  
</Address>
```

PESC XML Application for Admission Implementation Guide Version 1.3.0

Applicant.Family.FamilyMember.Contacts.Email

Note: Although the complex data element *Email* is an optional data element, if you choose to send the *Email* of the *FamilyMember*, then you must send the data element *EmailAddress*.

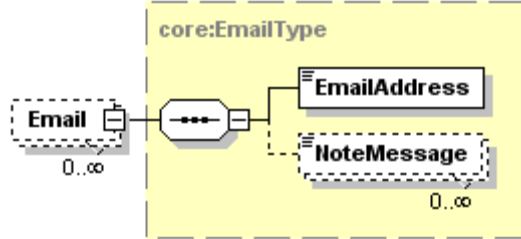

Tag Name	Schema Use	Description	Recommended Use	Format
EmailAddress	Required	The numbers, letters, and symbols used to identify an electronic mail (Email) user within a network.	Required	minOcc 1 maxOcc 1 minLength 1 maxLength 128
NoteMessage	Optional Repeatable	Additional information about the addresses of the family member	Not recommended	minOcc 0 maxOcc ∞ minLength 1 maxLength 80

Code illustration:

```
<Email>
  <EmailAddress>stewartj@aol.com</EmailAddress>
  <NoteMessage/>
</Email>
```

PESC XML Application for Admission Implementation Guide Version 1.3.0

Applicant.Family.FamilyMember.Contacts.Phone

Note: Although the complex data element Phone is an optional data element, if you choose to send the Phone of the FamilyMember, then you must send the data element PhoneNumber.

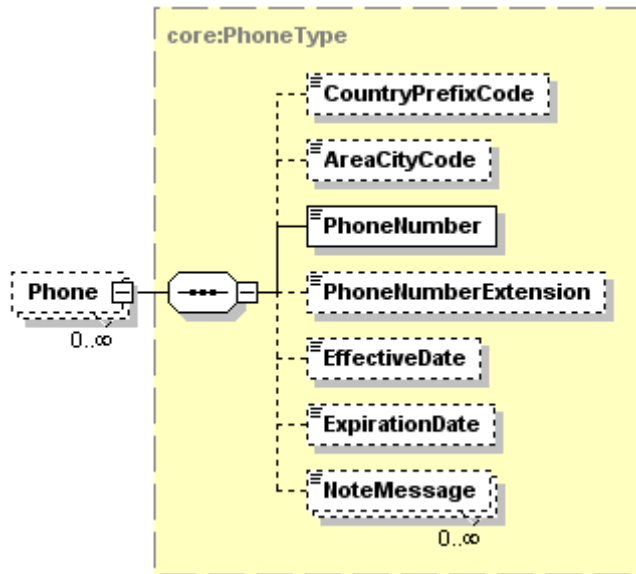

Tag Name	Schema Use	Description	Recommended Use	Format
CountryPrefixCode	Optional	International dialing code.	Optional	minOcc 0 maxOcc 1 minLength 1 maxLength 3
AreaCityCode	Optional	Regional dialing code.	Recommended	minOcc 0 maxOcc 1 minLength 1 maxLength 5
Comment: For phone numbers in the United States and Canada, this is the normal three digit area code.				
PhoneNumber	Required	Telephone number.	Required	minOcc 1 maxOcc 1 minLength 1 maxLength 11
PhoneNumberExtension	Optional	The extended telephone addressing information used in addition to phone number such as a PBX extension, a pager PIN, or FAX sub-address	Optional	minOcc 0 maxOcc 1 minLength 1 maxLength 5
EffectiveDate	Optional	The date on which the phone number became (or will become) effective	Optional	minOcc 0 maxOcc 1 Date format: CCYY-MM-DD
ExpirationDate	Optional	The date on which the phone number will (or did) expire	Optional	minOcc 0 maxOcc 1 Date format: CCYY-MM-DD
NoteMessage	Optional Repeatable	Additional information about the phone numbers of the contacts at the source school	Not recommended	minOcc 0 maxOcc ∞ minLength 1 maxLength 80

PESC XML Application for Admission Implementation Guide Version 1.3.0

Applicant.Family.FamilyMember.Contacts.Phone (Continued)

Code illustration:

```
<Phone>  
  <CountryPrefixCode/>  
  <AreaCityCode>512</AreaCityCode>  
  <PhoneNumber>8888888</PhoneNumber>  
  <PhoneNumberExtension/>  
  <EffectiveDate/>  
  <ExpirationDate/>  
  <NoteMessage/>  
</Phone>
```

PESC XML Application for Admission Implementation Guide Version 1.3.0

Applicant.Family.FamilyMember.Contacts.URL

Note: Although the complex data element URL is an optional data element, if you choose to send the URL of the FamilyMember, then you must send the data element URLAddress.

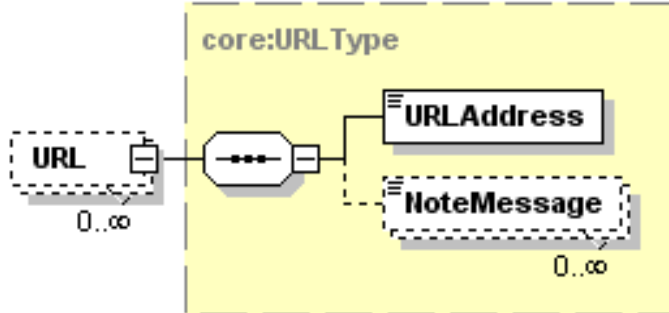

Tag Name	Schema Use	Description	Recommended Use	Format
URLAddress	Required	The Uniform Resource Locator (URL) address associated with a family member	Required	minOcc 1 maxOcc 1 minLength 0 maxLength 512
NoteMessage	Optional Repeatable	Additional information about the URL of the family member	Not recommended	minOcc 0 maxOcc ∞ minLength 1 maxLength 80

Code illustration:

```
<URL>
  <URLAddress>John.Appleseed.com</URLAddress>
  <NoteMessage/>
</URL>
```

PESC XML Application for Admission Implementation Guide Version 1.3.0

Applicant.Family.FamilyMember.Gender

Note: Although the complex data element Gender is an optional data element, if you choose to send the Gender of the FamilyMember, then you must send the data element GenderCode.

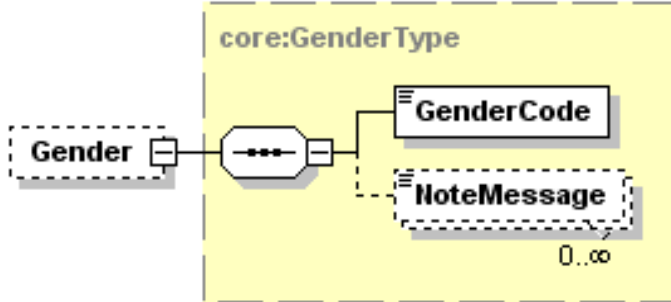

Tag Name	Schema Use	Description	Recommended Use	Format
GenderCode	Required	The gender of the family member of the applicant	Required	minOcc 1 maxOcc 1 Enumeration: Female Male Unreported
NoteMessage	Optional Repeatable	Additional information about Gender	Not Recommended	minOcc 0 maxOcc ∞ minLength 1 maxLength 80

Code illustration:

```
<Gender>
  <GenderCode>Male</GenderCode>
  <NoteMessage/>
</Gender>
```

PESC XML Application for Admission Implementation Guide Version 1.3.0

Applicant.Family.FamilyMember.Marital

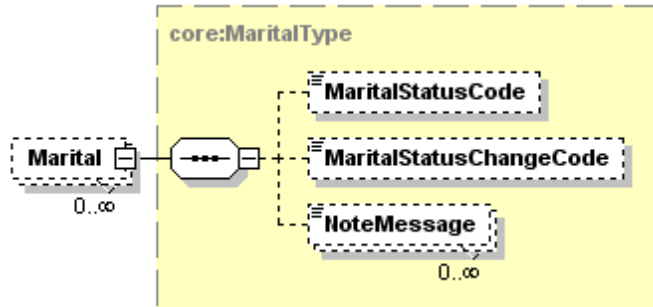

Tag Name	Schema Use	Description	Recommended Use	Format
MaritalStatusCode	Optional	A code identifying marital status of this family member	Optional	minOcc 0 maxOcc 1 Enumerations: CommonLaw Divorced LegallySeparated Married RegisteredPartnership Separated Single Unknown Unmarried Unreported Widowed
MaritalStatusChangeCode	Optional	Information related to the change in marital status of the family member of the applicant	Not Recommended	minOcc 0 maxOcc 1 Enumerations: Cohabitation Divorced DomesticPartnership LegallySeparated Married None Other Unknown Widowed
NoteMessage	Optional Repeatable	Additional information about marital information of the family member	Not Recommended	minOcc 0 maxOcc ∞ minLength 1 maxLength 80

Code illustration:

```

<Marital>
  <MaritalStatusCode>Married</MaritalStatusCode>
  <MaritalStatusChangeCode/>
  <NoteMessage/>
</Marital>
    
```

PESC XML Application for Admission Implementation Guide Version 1.3.0

Applicant.Family.FamilyMember.EthnicityRace

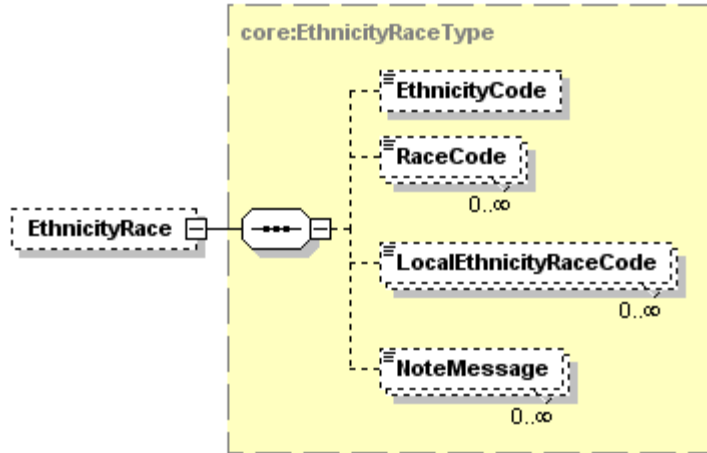

Tag Name	Schema Use	Description	Recommended Use	Format
EthnicityCode	Optional	This is the ethnicity code as determined by the US Department of Education's National Center for Education Statistics	Recommended	minOcc 0 maxOcc 1 Enumerations: Hispanic NonHispanic
RaceCode	Optional Repeatable	The applicant's race code(s) as submitted by the applicant	Recommended	minOcc 0 maxOcc ∞ Enumerations: AmericanIndianAlaskaNative Asian BlackAfricanAmerican NativeHawaiianPacificIslander White
Comment: These are codes recognized by the US Department of Education's National Center for Education Statistics. It is essential that these data be included in the school's database and requesting these data on the application for admission is probably the most common way of collecting these data. This version of the RaceEthnicity codes has now been approved by the US Department of Education's National Center for Education Statistics.				
LocalRaceEthnicityCode	Optional Repeatable	The student's race and ethnicity code as defined by the sending school's state, province or region.	Optional	minOcc 0 maxOcc ∞ minLength 1 maxLength 30
Comment: Individual states or provinces may ask for more specific race and/or ethnicity information. This data element is provided for those states and provinces..				
NoteMessage	Optional Repeatable	Additional information about the family member's race and/or ethnicity	Not Recommended	minOcc 0 maxOcc ∞ minLength 1 maxLength 80

Code illustration:

```

<EthnicityRace>
  <Ethnicity>NonHispanic</Ethnicity>
  <RaceCode>AmericanIndianAlaskaNative</RaceCode>
  <RaceCode>BlackAfricanAmerican</RaceCode>
  <LocalRaceEthnicityCode>Seminole</LocalRaceEthnicityCode>
  <LocalRaceEthnicityCode>Black</LocalRaceEthnicityCode>
  <NoteMessage/>
</EthnicityRace>

```

PESC XML Application for Admission Implementation Guide Version 1.3.0

Applicant.Family.FamilyMember.Citizenship

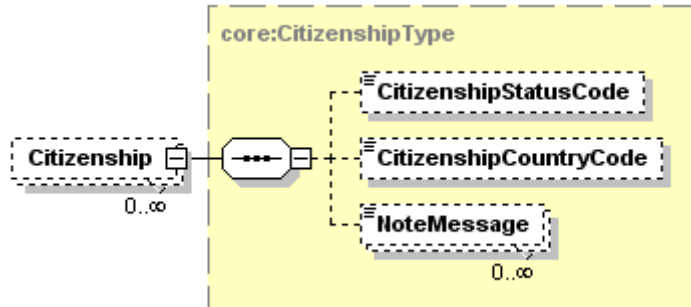

Tag Name	Schema Use	Description	Recommended Use	Format
CitizenshipStatusCode	Optional	Citizenship status of the family member of the applicant	Optional	minOcc 0 maxOcc 1 Enumerations: Asylee Citizen EligibleNonCitizen IllegalAlien LandedImmigrant MinistersPermit NonCitizen NonPermanentResidentAlien NonResidentAlien NonResidentCitizen NotEligible PermanentVisa Refugee ResidentAlien StudentAuthorization StudentVisa TemporaryVisa UndocumentedAlien VisitorVisa WorkVisa
CitizenshipCountryCode	Optional	Code for the country of citizenship of the family member of the applicant	Optional	minOcc 0 maxOcc 1 Enumerations: See Appendix B for list of ISO country codes.
NoteMessage	Optional	Additional information about the citizenship status of the family member	Not Recommended	minOcc 0 maxOcc ∞ minLength 1 maxLength 80

Code illustration:

```

<Citizenship>
  <CitizenshipStatusCode>ResidentAlien</CitizenshipStatusCode>
  <CitizenshipCountryCode>US</CitizenshipCountryCode>
  <NoteMessage/>
</Citizenship>

<Citizenship>
  <CitizenshipStatusCode>Citizen</CitizenshipStatusCode>
  <CitizenshipCountryCode>AR</CitizenshipCountryCode>
  <NoteMessage/>
</Citizenship>
    
```

PESC XML Application for Admission Implementation Guide Version 1.3.0

Applicant.Family.FamilyMember.Deceased

Note: Although the complex data element Deceased is optional, if you include this data element, then the Deceased Indicator is required.

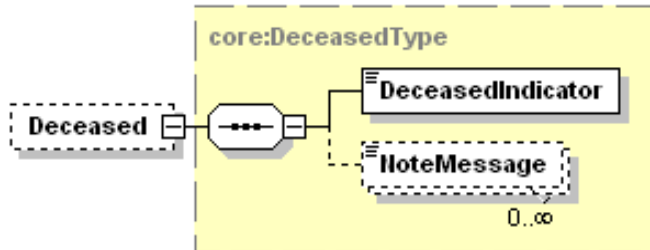

Tag Name	Schema Use	Description	Recommended Use	Format
DeceasedIndicator	Required	An indicator that this family member of the applicant is now deceased	Required	minOcc 1 maxOcc 1 The values are either true or false
Comments: If the value were false, then the complex data element "Deceased" would not be included in the document.				
NoteMessage	Optional Repeatable	Additional information about the deceased status of this family member of the applicant	Not recommended	minOcc 0 maxOcc ∞ minLength 1 maxLength 80

Code illustration:

```
<Deceased>
  <DeceasedIndicator>true</DeceasedIndicator>
  <NoteMessage/>
</Deceased>
```

PESC XML Application for Admission Implementation Guide Version 1.3.0

Applicant.Family.FamilyMember.OccupationDetail

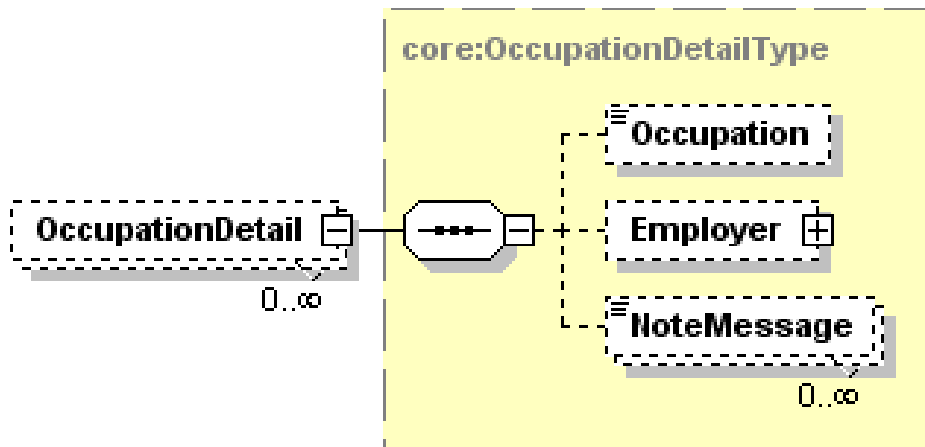

Tag Name	Schema Use	Description	Recommended Use	Format
Occupation	Optional	The name of the occupation of the family member	Optional	minOcc 0 maxOcc 1 minLength 1 maxLength 30
Employer	Optional	Information about the name of the employer (person or company, etc.) of this family member	Optional	minOcc 0 maxOcc 1
Comments: This complex data element will be expanded on page 240 which follows in this Guide.				
NoteMessage	Optional Repeatable	Additional information about the occupation of the family member	Not Recommended	minOcc 0 maxOcc ∞ minLength 1 maxLength 80

Code illustration:

```

<OccupationDetail>
  <Occupation>Lawyer</Occupation>
  <Employer>

  </Employer>
  <NoteMessage/>
</OccupationDetail>

```

PESC XML Application for Admission Implementation Guide Version 1.3.0

Applicant.Family.FamilyMember.OccupationDetail.Employer

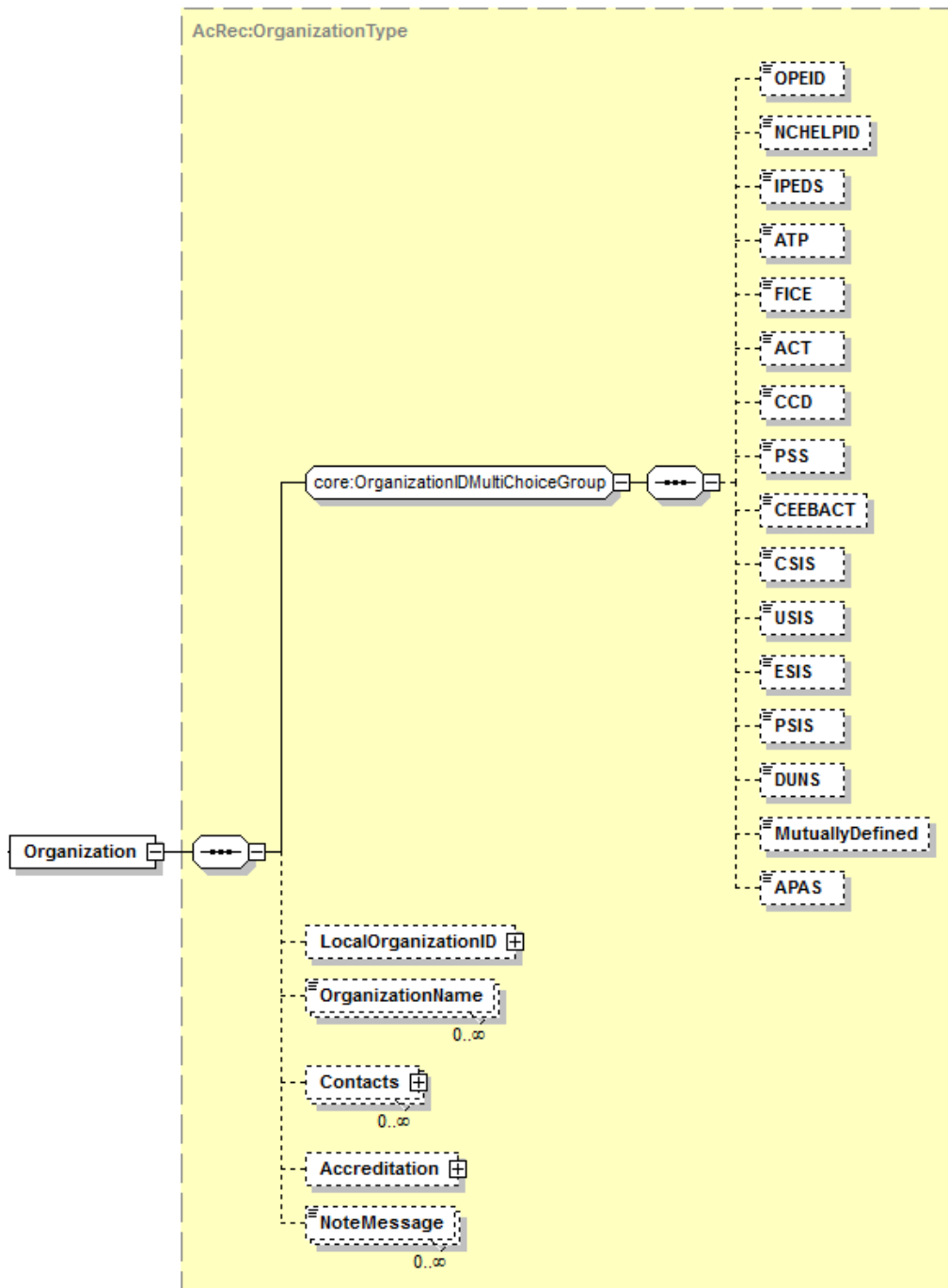

PESC XML Application for Admission Implementation Guide Version 1.3.0

Applicant.Family.FamilyMember.OccupationDetail.Employer (Continued)

Tag Name	Schema Use	Description	Recommended Use	Format
[OrganizationIDGroup]	Optional	Allowable Organization IDs - Exclusive choice	Optional	minOcc 0 maxOcc 1
Comment: [OrganizationIDGroup] is not an XML tag and does not appear in an instance document. If included, it allows the choice of one and only one of the following code set tags to identify the employer of the family member.				
OPEID	Optional choice	The unique identifier assigned by the Office of Postsecondary Education for each data exchange partner. Includes all postsecondary schools that are eligible to participate in US Title IV federal financial aid programs.	Not Recommended	minOcc 0 maxOcc 1 minLength 3 maxLength 8
Comment: The OPEID would not be an appropriate choice unless the employer were a postsecondary school.				
NHELPIID	Optional choice	The unique identifier assigned by National Council on Higher Education Loan Programs for each data exchange partner.	Not Recommended	minOcc 0 maxOcc 1 minLength 3 maxLength 8
Comment: The NHELPIID would not normally be an appropriate choice unless the employer were a financial institution.				
IPEDS	Optional choice	The unique identifier for Integrated Postsecondary Education Data System assigned by the National Center for Education Statistics for each postsecondary data exchange partner. Also called the Unit ID.	Not Recommended	minOcc 0 maxOcc 1 minLength 6 maxLength 6
Comment: The IPEDS would not be an appropriate choice unless the employer were a postsecondary school.				
ATP	Optional choice	The unique identifier for the Admissions Testing Program assigned by the College Board for each data exchange partner.	Not Recommended	minOcc 0 maxOcc 1 minLength 6 maxLength 6
Comment: The ATP would not be an appropriate choice unless the employer were a postsecondary school.				
FICE	Optional choice	The unique identifier once maintained for the Federal Interagency Committee on Education by the National Center for Education Statistics for each postsecondary data exchange partner.	Not Recommended	minOcc 0 maxOcc 1 minLength 6 maxLength 6
Comment: The FICE would not normally be an appropriate choice unless the employer were a postsecondary school. However, the FICE number was originally maintained by the US Department of Education's National Center for Education Statistics (NCES), but has not been maintained by NCES since late in the last century. It may still be an appropriate choice for schools that have been in business for more than 20 years.				
ACT	Optional choice	The unique identifier for postsecondary educational institutions assigned by American College Testing available at www.act.org	Not Recommended	minOcc 0 maxOcc 1 minLength 4 maxLength 4
Comment: The ACT would not be an appropriate choice unless the employer were a postsecondary school.				
CCD	Optional choice	The unique identifier assigned by National Center for Education Statistics as the Common Core of Data for each data exchange partner.	Not Recommended	minOcc 0 maxOcc 1 minLength 12 maxLength 12
Comment: The CCD would not be an appropriate choice to describe the employer, unless the family member was employed by a school.				

PESC XML Application for Admission Implementation Guide

Version 1.3.0

Tag Name	Schema Use	Description	Recommended Use	Format
PSS	Optional choice	The unique identifier assigned by National Center for Education Statistics to private secondary schools in the US	Not Recommended	minOcc 0 maxOcc 1 minLength 12 maxLength 12
Comment: The CCD would not be an appropriate choice to describe the employer, unless the family member was employed by a private secondary school in the US.				
CEEBACT	Optional choice	The unique identifier assigned by the College Entrance Examining Board and ACT for each K-12 data exchange partner.	Not Recommended	minOcc 0 maxOcc 1 minLength 6 maxLength 6
Comment: The CEEBACT would not normally be an appropriate choice unless the employer were a secondary school.				
CSIS	Optional choice	The unique identifier assigned by the Statistics Canada Canadian College Student Information System for each postsecondary data exchange partner.	Not Recommended	minOcc 0 maxOcc 1 minLength 6 maxLength 6
Comment: Since this code set is used to identify postsecondary schools in Canada, it is not a recommended choice unless the employer were a postsecondary school in Canada. However, this code is now being phased out and the newer PSIS code set would now be used to identify a postsecondary school in Canada.				
USIS	Optional choice	The unique identifier assigned by the Statistics Canada University Student Information System for each data postsecondary exchange partner.	Not Recommended	minOcc 0 maxOcc 1 minLength 6 maxLength 6
Comment: Since this code set is used to identify postsecondary schools in Canada, it is not a recommended choice for an employer, unless the family member were employed by a postsecondary school in Canada. However, this code is now being phased out and the newer PSIS code set would now be used to identify a postsecondary school in Canada.				
ESIS	Optional choice	The unique identifier assigned by the Statistics Canada Enhanced Student Information System for each data postsecondary exchange partner.	Not Recommended	minOcc 0 maxOcc 1 minLength 8 maxLength 8
Comment: Since this code set is used to identify postsecondary schools in Canada, it is not a recommended choice for an employer, unless the family member were employed by a postsecondary school in Canada. However, this code is now being phased out and the newer PSIS code set would now be used to identify a postsecondary school in Canada.				
PSIS	Optional choice	The unique identifier assigned by the Statistics Canada Postsecondary Student Information System for each data postsecondary exchange partner.	Optional choice	minOcc 0 maxOcc 1 minLength 8 maxLength 8
Comment: Since this code set is used to identify postsecondary schools in Canada, it is not a recommended choice for an employer, unless the family member were employed by a postsecondary school in Canada.				
DUNS	Optional choice	Data Universal Numbering System (DUNS), unique nine character company identification number issued by Dun and Bradstreet Corporation.	Recommended choice	minOcc 0 maxOcc 1 minLength 9 maxLength 9
Comment: The DUNS number would normally be an appropriate choice.				
MutuallyDefined	Optional choice	The unique identifier assigned by trading organizations for organizations that have no defined ID code in any of the other code sets.	Not Recommended	minOcc 0 maxOcc 1 minLength 1 maxLength 60
Comment: Mutually Defined would not normally be an appropriate choice.				
APAS	Optional choice	Identification codes used by the Alberta Post-Secondary Application Systems.	Optional choice	minOcc 0 maxOcc 1 minLength 1 maxLength 12

PESC XML Application for Admission Implementation Guide Version 1.3.0

Tag Name	Schema Use	Description	Recommended Use	Format
<i>Comment: This is an appropriate choice for institutions in Canada.</i>				
<i>Comment: End of OrganizationIDGroup choice set tags</i>				
LocalOrganizationID	Optional	A code set typically used by a state, province or region to further identify the sending vendor, agency or school.	Not Recommended	minOcc 0 maxOcc 1
OrganizationName	Required Repeatable	Name of Non-person entity such as Organization, Institution, Agency or Business.	Required	minOcc 1 maxOcc ∞ minLength 1 maxLength 60
Contacts	Optional Repeatable	To identify a person or an office at the sending vendor, company, agency or school to which administrative communications should be directed	Not Recommended	minOcc 0 maxOcc ∞
NoteMessage	Optional Repeatable	Additional information about the organization	Not recommended	minOcc 0 maxOcc ∞ minLength 1 maxLength 80

Applicant.Family.FamilyMember.OccupationDetail.Employer (Continued)

Code illustration:

```

<Organization>
  <DUNS>123456789</DUNS>
  <LocalOrganizationID/>
  <OrganizationName>American Red Cross</OrganizationName>
  <Contacts/>
  <NoteMessage/>
</Organization>

```

PESC XML Application for Admission Implementation Guide Version 1.3.0

Applicant.Family.FamilyMember.Legacy

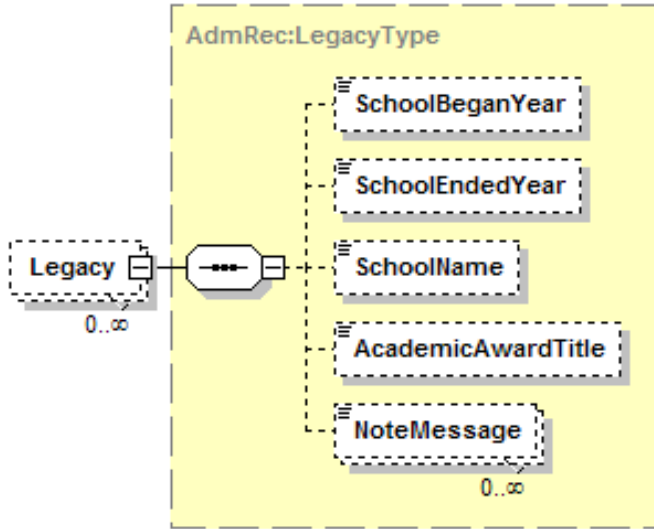

Tag Name	Schema Use	Description	Recommended Use	Format
SchoolBeganYear	Optional	The year the family member began attending the school to which the applicant is applying	Optional	minOcc 0 maxOcc 1 Format is gYear: CCYY
SchoolEndedYear	Optional	The year the family member stopped attending the school to which the applicant is applying	Optional	minOcc 0 maxOcc ∞ Format is gYear: CCYY
SchoolName	Optional	The name of the school the family member attended.	Optional	minOcc 0 maxOcc 1 minLength 1 maxLength 60
Comment: It is assumed that the school the family member attended is the school to which the applicant is applying. This data element would only be included if the family member attended another school that is part of the same college or university system, or perhaps a specialized school within the university, such as a law school.				
AcademicAwardTitle	Optional	The name of the degree or award that was earned by the family member at the school to which the applicant is applying	Optional	minOcc 0 maxOcc ∞ minLength 1 maxLength 400
NoteMessage	Optional Repeatable	Additional information about the legacy status of the family member	Not Recommended	minOcc 0 maxOcc ∞ minLength 1 maxLength 80

Code illustration:

```
<Legacy>
  <SchoolBeganYear>1975</SchoolBeganYear>
  <SchoolEndedYear>1979</SchoolEndedYear>
  <SchoolName>College of Law</SchoolName>
  <AcademicAwardTitle>Juris Doctorate</AcademicAwardTitle>
  <NoteMessage/>
</Legacy>
```

PESC XML Application for Admission Implementation Guide Version 1.3.0

Applicant.Family.FamilyLegacy

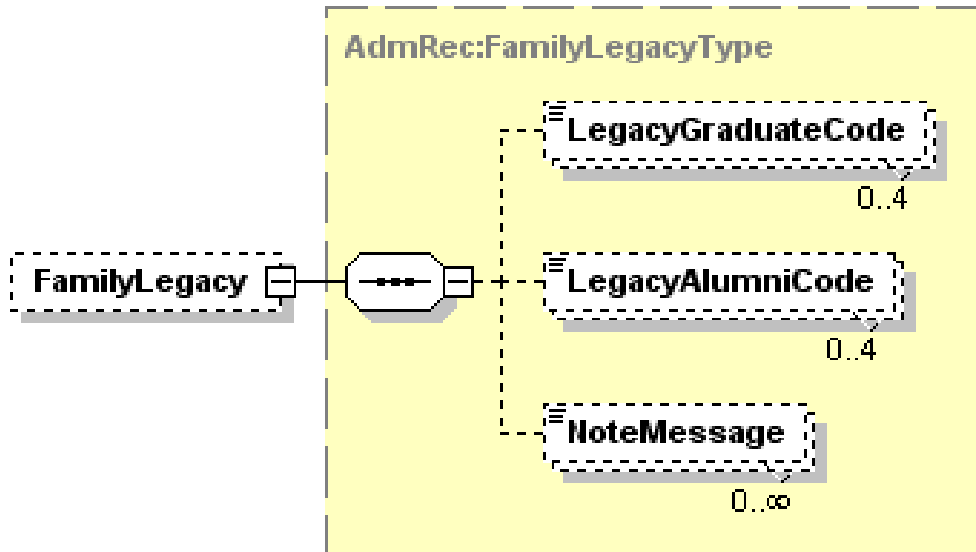

Tag Name	Schema Use	Description	Recommended Use	Format
LegacyGraduateCode	Optional Repeatable	An indication that a close family member previously graduated from the school to which the applicant is applying	Optional	minOcc 0 maxOcc 4 Enumerations: Child Father Mother Sibling Spouse
LegacyAlumniCode	Optional Repeatable	An indication that a close family member previously attended the school to which the applicant is applying	Optional	minOcc 0 maxOcc 4 Enumerations: Child Father Mother Sibling Spouse
NoteMessage	Optional Repeatable	Additional information about the legacy status of the family member	Not Recommended	minOcc 0 maxOcc ∞ minLength 1 maxLength 80

Code illustration:

```

<FamilyLegacy>
  <LegacyGraduateCode>Father</LegacyGraduateCode>
  <LegacyGraduateCode>Mother</LegacyGraduateCode>
  <LegacyAlumniCode>Spouse</LegacyAlumniCode>
  <NoteMessage/>
</FamilyLegacy>

```

PESC XML Application for Admission Implementation Guide Version 1.3.0

Applicant.Family.FamilyIncome

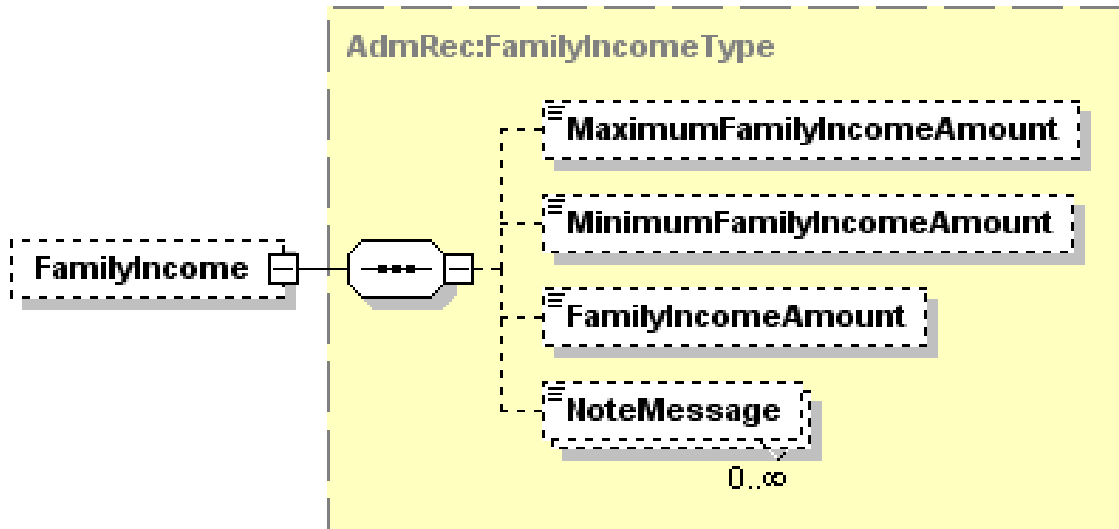

Tag Name	Schema Use	Description	Recommended Use	Format
MaximumFamilyIncomeAmount	Optional	The maximum of the range of income for the most recent year available for the applicant's family	Conditional Optional	minOcc 0 maxOcc 1 xs: Decimal
MinimumFamilyIncomeAmount	Optional	The minimum of the range of income for the most recent year available for the applicant's family	Conditional Optional	minOcc 0 maxOcc 1 xs: Decimal
Comment: If either of the above two data elements is included, they should both be included.				
FamilyIncomeAmount	Optional	Amount of income for the most recent year available for the applicant's family	Optional	minOcc 0 maxOcc ∞ xs: Decimal
Comment: It is intended that either both of the first two data elements be included, or the "FamilyIncomeAmount" data element be included, if the optional complex data element "FamilyIncome" is included.				
NoteMessage	Optional	Additional information about the family income	Not Recommended	minOcc 0 maxOcc ∞ minLength 1 maxLength 80

Code illustration:

```

<FamilyIncome>
  <MaximumFamilyIncomeAmount>40000</MaximumFamilyIncomeAmount>
  <MinimumFamilyIncomeAmount>30000</MinimumFamilyIncomeAmount>
  <FamilyIncomeAmount/>
  <NoteMessage/>
</FamilyIncome>

```

PESC XML Application for Admission Implementation Guide Version 1.3.0

Applicant.Residency

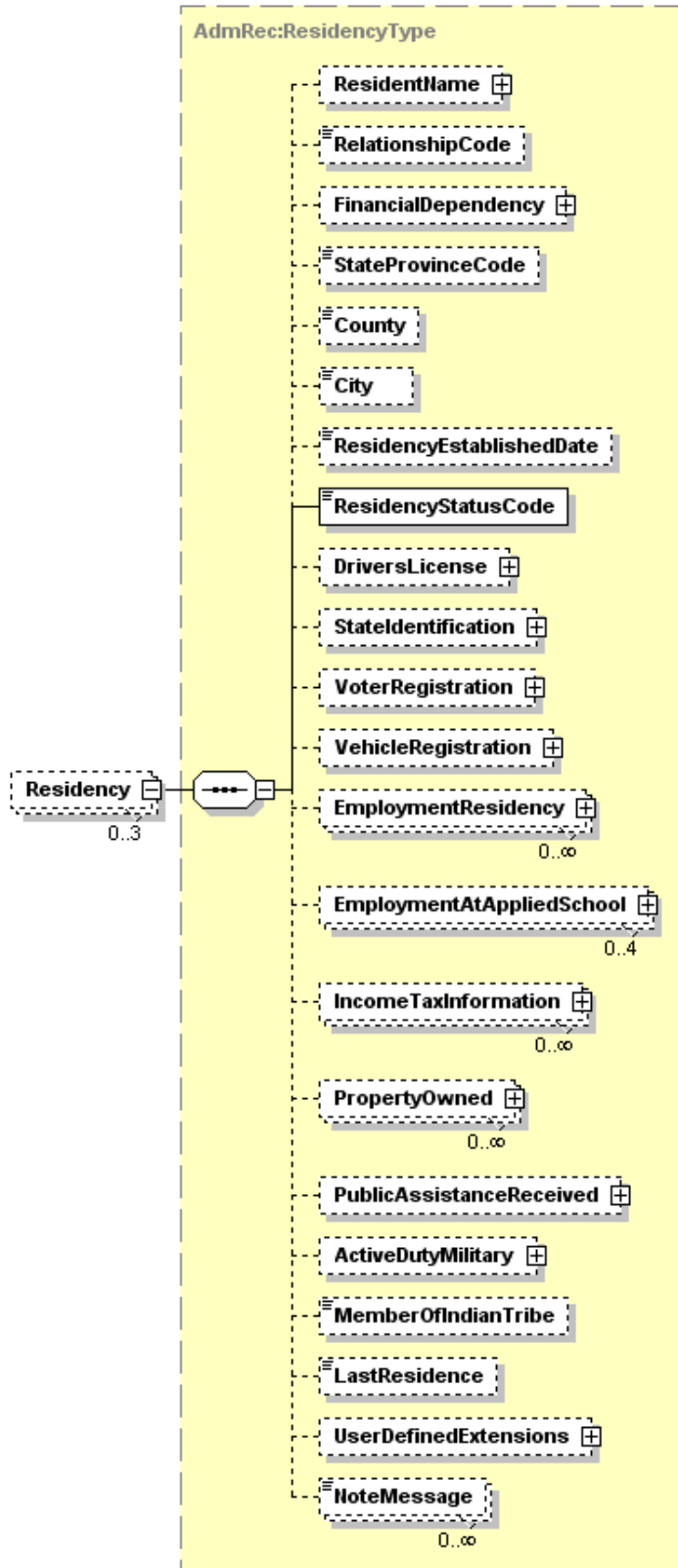

PESC XML Application for Admission Implementation Guide Version 1.3.0

Applicant.Residency (Continued)

Tag Name	Schema Use	Description	Recommended Use	Format
ResidentName	Optional	The name of the person on whom the claim of residency is based	Recommended	minOcc 0 maxOcc 1
<p>Comment: It is recommended that this data element not be included if the application indicated that the residency determination should be based on the residency status of the applicant. That is, that "Self" is the enumerated value selected in the next data element. Further information about this complex data element will be provided on page 255.</p>				
RelationshipCode	Optional	The relationship of the person indicated in ResidentName to the applicant	Optional	minOcc 0 maxOcc 1 Enumerations: AdultOther AgencyRepresentative Applicant Aunt AuthorizedDesignate Brother BrotherInLaw BusinessAssociate BusinessPartner Child ChildAdopted Cousin Daughter DaughterAdopted DaughterInLaw Dependent DependentCollateral DependentOfMinorDependent EmancipatedMinor EmergencyContact Employee Employer ExHusband ExSpouse ExWife Father FatherAdoptive FatherInLaw Fiancee Fiancee FosterChild FosterDaughter FosterFather FosterMother FosterParent FosterSon Friend GodDaughter GodFather GodParent GodSon Grandchild Granddaughter Grandfather Grandmother Grandparent Grandson GreatAunt GreatUncle Guardian GuardianCourtAppointed HalfBrother HalfSister

PESC XML Application for Admission Implementation Guide

Version 1.3.0

Tag Name	Schema Use	Description	Recommended Use	Format
				HandicappedDependent Husband LifePartner Mother MotherAdoptive MotherInLaw Neighbor Nephew Niece ParentAdoptive ParentBoth Partner RelationshipOther RelativeOther Self SignificantOther Sister SisterInLaw Son SonAdopted SonInLaw SponsoredDependent Spouse StepBrother StepChild StepDaughter StepFather StepMother StepParent StepSister StepSon Student Uncle Unknown Ward Widow Widower Wife
FinancialDependency	Optional	The declaration made by the applicant that he or she is either a dependent person or an independent person	Recommended	minOcc 0 maxOcc 1
Comment: Further information about this complex data element will be provided on page 257.				
StateProvinceCode	Optional	A code identifying the state or province which the claimant claims as the permanent residence	Optional	minOcc 0 maxOcc 1 See Appendix A for the enumerated values
County	Optional	The name of the county which the claimant states as the county of permanent residence.	Optional	minOcc 0 maxOcc 1 minLength 1 maxLength 30
Comment: County of permanent residency is not normally an issue. However, there are certain public community colleges that are supported by one or more specific counties and offer reduced fees to residents of those counties. There are also some colleges located near a state border and have reciprocal agreements with counties located near the state line in the other state and county of residence then becomes an issue.				
City	Optional	The name of the city which the claimant states as the city of permanent residence.	Optional	minOcc 0 maxOcc 1 minLength 2 maxLength 30
Comment: City of permanent residency is not normally an issue. However, there are certain public community colleges and perhaps even some public universities that are supported by one or more specific cities and offer reduced fees to residents of those cities.				

PESC XML Application for Admission Implementation Guide

Version 1.3.0

Tag Name	Schema Use	Description	Recommended Use	Format
ResidencyEstablishedDate	Optional	The date on which the applicant or other claimant became a resident of the state, province, or county.	Recommended	minOcc 0 maxOcc 1 xs.date: ccyymm-dd
Comment: Although this data element is not required, it is an essential piece of information for most public postsecondary schools when making a residency determination. When the date that the claimant specifies is recent, then the full date is essential. If, however, the claimant established permanent residency many years ago, the claimant may not know the exact date. In these cases, it is suggested that the program (web application) used to collect the data from the applicant, could insert the day as "01" if the applicant only provides year and month. Likewise, if the applicant only provides a year, then the the source program could provide the month and year as "01-01". To avoid this ambiguity, it is recommended that the source program require that a full date be provided by the applicant, even if the month and or day are only approximate.				
ResidencyStatusCode	Required	The declaration made by the claimant as to his or her permanent residency	Required	minOcc 1 maxOcc 1 Enumerations: InCity InCounty InDistrict InState NonResident NotReported OtherResident Resident
Comment: The use of the code "OtherResident" might be used when the claimant has not resided in the service area for the required amount of time, but other school policies allow the applicant to be considered a resident for fee purposes.				
DriversLicense	Optional	Information about the claimant's driver's license	Optional	minOcc 0 maxOcc 1
Comment: Further information about this complex data element will be provided on page 258.				
StateIdentification	Optional	Information about other state issued identification documents issued to the claimant	Optional	minOcc 0 maxOcc 1
Comment: Further information about this complex data element will be provided on page 259.				
VoterRegistration	Optional	Information about the claimant's status as a registered voter	Optional	minOcc 0 maxOcc 1
Comment: Further information about this complex data element will be provided on page 260.				
VehicleRegistration	Optional	Information about any registered vehicle owned by the claimant	Optional	minOcc 0 maxOcc 1
Comment: Further information about this complex data element will be provided on page 262.				
EmploymentResidency	Optional Repeatable	Information about the current or immediate past employment of the claimant	Optional	minOcc 0 maxOcc ∞
Comment: Further information about this complex data element will be provided on page 263.				
EmploymentAtAppliedSchool	Optional Repeatable	Information about the current or past employment of the claimant or relatives of the claimant at the school to which the applicant is applying	Optional	minOcc 0 maxOcc 4
Comment: Further information about this complex data element will be provided on page 264.				
IncomeTaxInformation	Optional Repeatable	Information about income taxes paid by the applicant	Optional	minOcc 0 maxOcc ∞
Comment: Further information about this complex data element will be provided on page 265.				
PropertyOwned	Optional Repeatable	Information about any real property owned by the claimant	Optional	minOcc 0 maxOcc ∞
Comment: Generally, only real property owned and in which the residency claimant has and does reside, is taken into consideration for establishing residency for tuition purposes. Further information about this complex data element will be provided on page 266.				
PublicAssistanceReceived	Optional	Information about any public assistance received or being received by the claimant	Optional	minOcc 0 maxOcc 1
Comment: Further information about this complex data element will be provided on page 267.				

PESC XML Application for Admission Implementation Guide

Version 1.3.0

Tag Name	Schema Use	Description	Recommended Use	Format
ActiveDutyMilitary	Optional	Information about the assignment location of military personnel which might allow residency status in some states	Optional	minOcc 0 maxOcc 1
Comment: Some schools or states have policies that will allow residents of other states to be considered residents for fee purposes while they are serving in the military and are temporarily or permanently assigned to a location in the school's service area while on active duty there. Further information about this complex data element will be provided on page 268.				
MemberOfIndianTribe	Optional	Information about an Indian tribe to which the claimant belongs which might qualify the claimant for resident status	Optional	minOcc 0 maxOcc 1 minLength 1 maxLength 80
LastResidence	Optional	Information about the last place of residence of the person claiming residence, immediately prior to the current claimed place of residence	Optional	minOcc 0 maxOcc 1 minLength 1 maxLength 40
Comment: This last place of residence could be a city, county, state or province, or country.				
UserDefinedExtensions	Optional	Additional information about the residency of the applicant that has been put into a mini schema. It is intended for use within a predetermined state or region.	Not recommended	minOcc 0 maxOcc 1
Comment: The use of a mini-schema called UserDefinedExtensions can be helpful to a specific group of users who would like to include coded data that is pre-defined and can be interpreted by the recipient of the instance document. Others not in that group would simply ignore the UDE.				
NoteMessage	Optional Repeatable	Additional information about the residence of the claimant	Not Recommended	minOcc 0 maxOcc ∞ minLength 1 maxLength 80

PESC XML Application for Admission Implementation Guide Version 1.3.0

Applicant.Residency (Continued)

Code illustration:

```
<Residency>
  <ResidentName>

    </ResidentName>
    <RelationshipCode>Self</RelationshipCode>
    <FinancialDependency>

      </FinancialDependency>
      <StateProvinceCode>FL</StateProvinceCode>
      <County>Brevard</County>
      <City>Titusville</City>
      <ResidencyEstablishedDate>2005-07-15</ResidencyEstablishedDate>
      <ResidencyStatusCode>InState</ResidencyStatusCode>
      <DriversLicense>

        </DriversLicense>
        <StateIdentification>

          </StateIdentification>
          <VoterRegistration>

            </VoterRegistration>
            <VehicleRegistration>

              </VehicleRegistration>
              <EmploymentResidency>

                </EmploymentResidency>
                <EmploymentAtAppliedSchool>

                  </EmploymentAtAppliedSchool>
                  <IncomeTaxInformation>

                    </IncomeTaxInformation>
                    <PropertyOwned>

                      </PropertyOwned>
                      <PublicAssistanceReceived>

                        </PublicAssistanceReceived>
                        <ActiveDutyMilitary>

                          </ActiveDutyMilitary>
                          <MemberOfIndianTribe>Chippewa</MemberOfIndianTribe>
                          <LastResidence>Miami, Florida</LastResidence>
                          <UserDefinedExtensions/>
                          <NoteMessage/>
            </Residency>
```

PESC XML Application for Admission Implementation Guide Version 1.3.0

Applicant.Residency.ResidentName

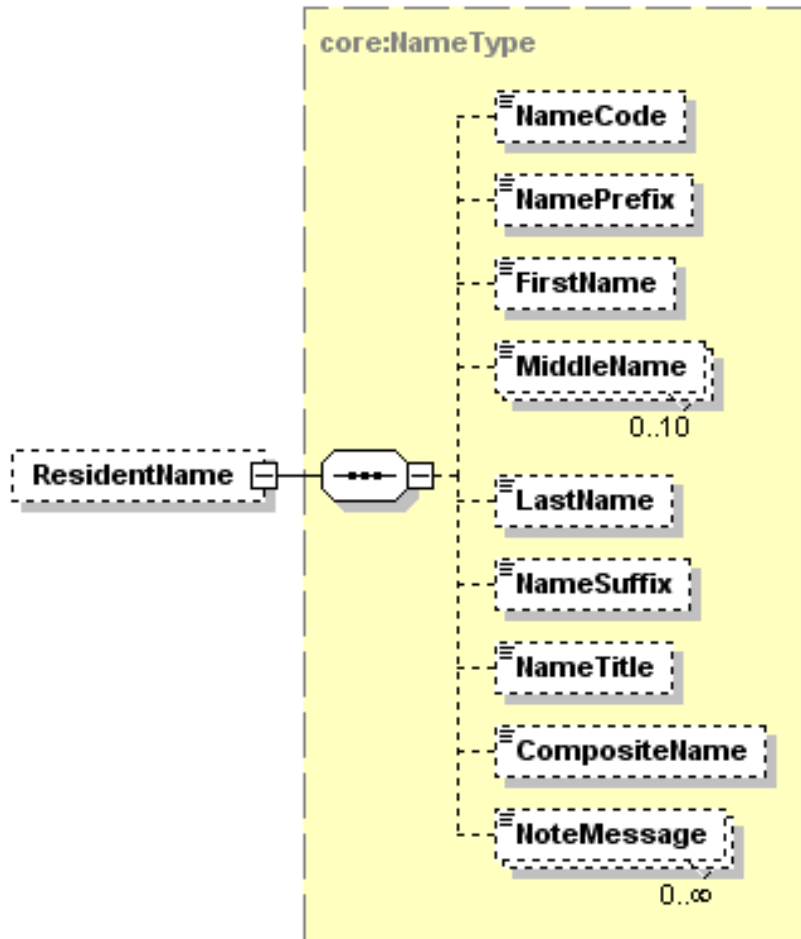

Tag Name	Schema Use	Description	Recommended Use	Format
NameCode	Optional	A code that indicates the type of name that is being described for the person claiming to be a resident	Recommended	minOcc 0 maxOcc 1 Enumerations: Casual Formal Former LawSchoolApplicationSource Legal MedicalSchoolApplicationSource Nickname Other
NamePrefix	Optional	An honorific, title or form of address that precedes the name.	Not Recommended	minOcc 0 maxOcc 1 minLength 1 maxLength 30
Comment: The honorific includes such data as “Dr.”, “Professor”, “Miss”, etc. The Workgroup felt that it could do more harm than good to include this information and make it available to the school.				
FirstName	Optional	The first name of the person, usually given at birth, baptism, or during,	Recommended	minOcc 0 maxOcc 1 minLength 1 maxLength 35

PESC XML Application for Admission Implementation Guide

Version 1.3.0

Tag Name	Schema Use	Description	Recommended Use	Format
		another ceremony, or through legal change		
MiddleName	Optional Repeatable	A secondary name of the person, usually given at birth, baptism, or during another naming ceremony or through legal change	Recommended	minOcc 0 maxOcc 10 minLength 1 maxLength 35
LastName	Optional	The last name or surname by which a person is legally known	Recommended	minOcc 1 maxOcc 1 minLength 1 maxLength 35
NameSuffix	Optional	The expression of an individual's generation within a family.	Recommended	minOcc 0 maxOcc 1 Enumerations: I II III IV V VI VII VIII IX X JR SR
NameTitle	Optional	An honorific, title or credential that follows the name.	Not Recommended	minOcc 0 maxOcc 1 minLength 1 maxLength 30
CompositeName	Optional	The full name of the person in Last Name (space) Suffix (comma) First Name (space) Middle Names (spaces). A comma would be included after last name or NameSuffix	Not Recommended	minOcc 0 maxOcc 1 minLength 1 maxLength 45
Comment: The use of the composite format for the name is discouraged. It is much easier for the receiving school to process the individual name parts into its database than to process a composite name. It is planned to delete this data element in the future.				
NoteMessage	Optional Repeatable	Additional information about the applicant's name	Not Recommended	minOcc 0 maxOcc ∞ minLength 1 maxLength 80

Code illustration:

```

<ResidentName>
  <NameCode>Legal</NameCode>
  <NamePrefix>
  <FirstName>John</FirstName>
  <MiddleName>Billy</MiddleName>
  <MiddleName>Bob</MiddleName>
  <LastName>Thornton</LastName>
  <NameSuffix>JR</NameSuffix>
  <NameTitle/>
  <CompositeName/>
  <NoteMessage/>
</ResidentName>

```

PESC XML Application for Admission Implementation Guide Version 1.3.0

Applicant.Residency.FinancialDependency

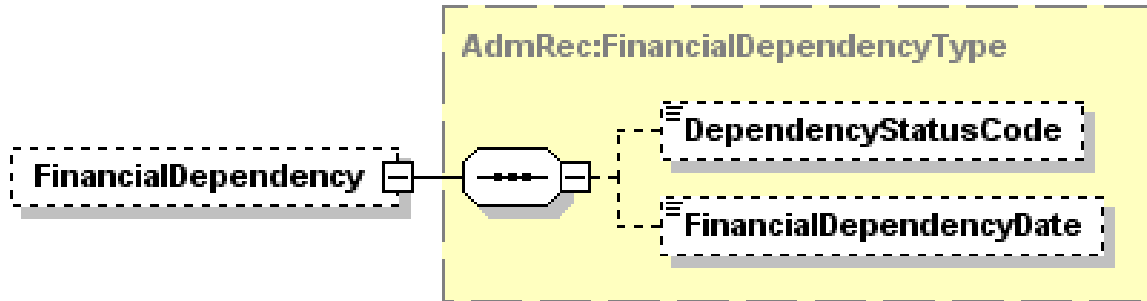

Tag Name	Schema Use	Description	Recommended Use	Format
DependencyStatusCode	Optional	A code indicating if the applicant is a dependent or independent person concerning financial status	Recommended	minOcc 0 maxOcc 1 Enumerations: Dependent Independent
FinancialDependencyDate	Optional	The date on which the applicant became either financially dependent or financially independent	Recommended	minOcc 0 maxOcc 1 Format is xs:date which is CCYY-MM-DD

Code illustration:

```

<FinancialDependency>
  <DependencyStatusCode>Dependent</DependencyStatusCode>
  <FinancialDependencyDate>1999-02-25</FinancialDependencyDate>
</FinancialDependency>
  
```

PESC XML Application for Admission Implementation Guide Version 1.3.0

Applicant.Residency.DriversLicense

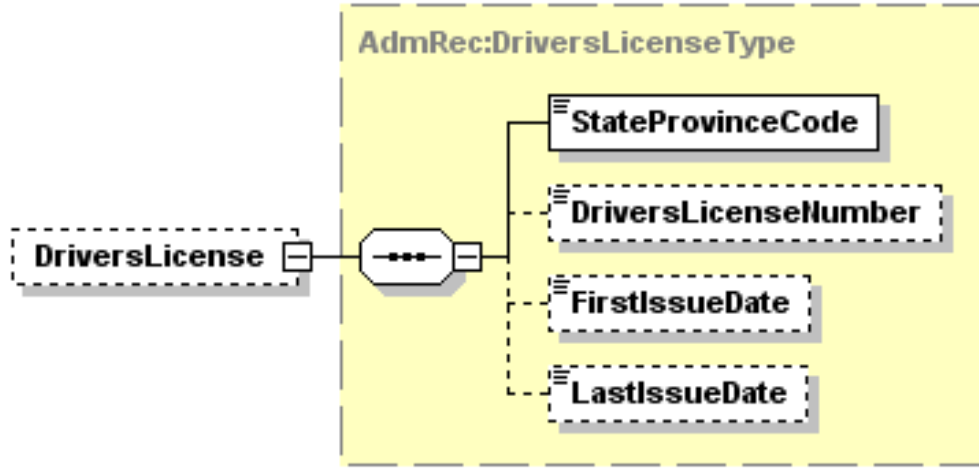

Tag Name	Schema Use	Description	Recommended Use	Format
StateProvinceCode	Required	The state or province which licensed the claimant to drive a motor vehicle	Required	minOcc 1 maxOcc 1 See Appendix A.
Comment: If the complex data element DriversLicense is included in the instance document, then State or Province must be sent. However the entire complex data element is not required.				
DriversLicenseNumber	Optional	The number assigned by the issuing state or province to the claimant to operate a motor vehicle	Required	minOcc 0 maxOcc 1 minLength 1 maxLength 20
FirstIssueDate	Optional	The date the claimant was first issued a driver's license in the state	Optional	minOcc 0 maxOcc 1 Date field with format CCYY-MM-DD
LastIssueDate	Optional	The date the claimant was most recently issued a driver's license in the state.	Optional	minOcc 0 maxOcc 1 Date field with format CCYY-MM-DD

Code illustration:

```

<DriversLicense>
  <StateProvinceCode>FL</StateProvinceCode>
  <DriversLicenseNumber>336699774411</DriversLicenseNumber>
  <FirstIssueDate>2000-01-25</FirstIssueDate>
  <LastIssueDate>2007-01-29</LastIssueDate>
</DriversLicense>
  
```

PESC XML Application for Admission Implementation Guide Version 1.3.0

Applicant.Residency.StateIdentification

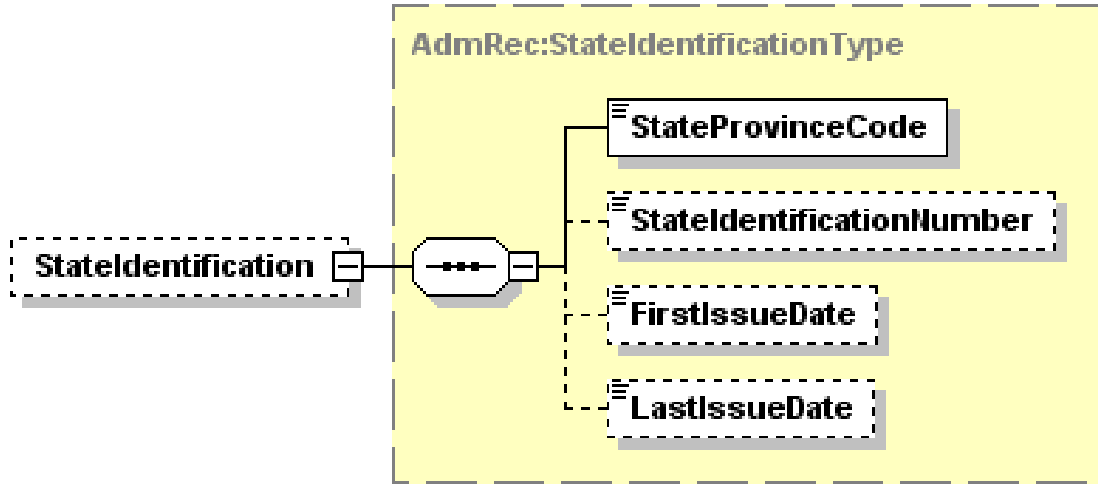

Tag Name	Schema Use	Description	Recommended Use	Format
StateProvinceCode	Required	The state or province which issued the identification document	Required	minOcc 1 maxOcc 1 See Appendix A
<i>Comment: Although the state is a required data element, if the complex data element StateIdentification is not included in the instance document, then state is not required.</i>				
StateIdentificationNumber	Optional	The number assigned by the issuing state or province to the claimant for identification purposes	Optional	minOcc 0 maxOcc 1 minLength 1 maxLength 20
FirstIssueDate	Optional	The date the claimant was first issued an identification document in the state	Optional	minOcc 0 maxOcc 1 Date field with format CCYY-MM-DD
LastIssueDate	Optional	The date the claimant was most recently issued an identification document in the state.	Optional	minOcc 0 maxOcc 1 Date field with format CCYY-MM-DD

Code illustration:

```

<StateIdentification>
  <StateProvinceCode>FL</StateProvinceCode>
  <StateIdentificationNumber>456789123</StateIdentificationNumber>
  <FirstIssueDate>1999-01-25</FirstIssueDate>
  <LastIssueDate>2006-01-29</LastIssueDate>
</StateIdentification>

```

PESC XML Application for Admission Implementation Guide Version 1.3.0

Applicant.Residency.VoterRegistration

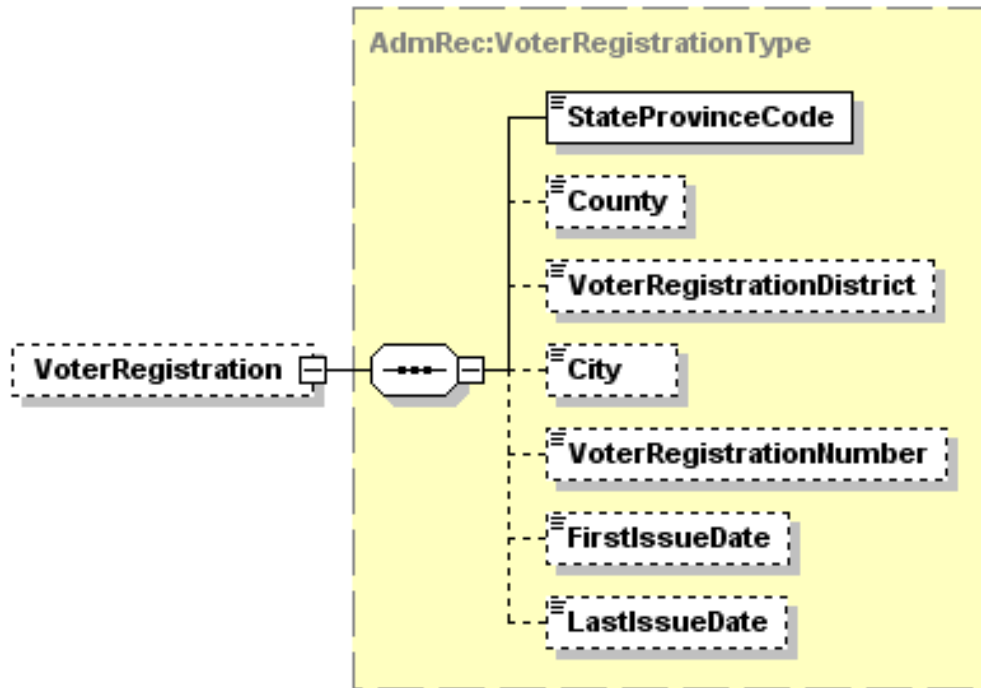

Tag Name	Schema Use	Description	Recommended Use	Format
StateProvinceCode	Required	The state or province which issued the identification document	Required	minOcc 1 maxOcc 1 See Appendix A.
Comment: Although the state or province is a required data element, if the complex data element VoterRegistration is not included in the instance document, then state is not required.				
County	Optional	The county in which the claimant is registered to vote	Optional	minOcc 0 maxOcc 1 minLength 1 maxLength 30
VoterRegistrationDistrict	Optional	The district (or precinct, or ward, etc.) in which the claimant is registered to vote	Optional	minOcc 0 maxOcc 1 minLength 0 maxLength 40
City	Optional	The city in which the claimant is registered to vote	Optional	minOcc 0 maxOcc 1 minLength 2 maxLength 30
VoterRegistrationNumber	Optional	The voter registration number assigned to the claimant	Optional	minOcc 0 maxOcc 1 minLength 1 maxLength 40
FirstIssueDate	Optional	The date the claimant was first registered to vote in the state or province and county	Optional	minOcc 0 maxOcc 1 Date field with format CCYY-MM-DD
LastIssueDate	Optional	The date the claimant was last registered to vote in the state or province and county	Optional	minOcc 0 maxOcc 1 Date field with format CCYY-MM-DD

PESC XML Application for Admission Implementation Guide Version 1.3.0

Applicant.Residency.VoterRegistration (Continued)

Code illustration:

```
<VoterRegistration>  
  <StateProvinceCode>FL</StateProvinceCode>  
  <County>Palm Beach</County>  
  <VoterRegistrationDistrict>Precinct 456</VoterRegistrationDistrict>  
  <City>West Palm Beach</City>  
  <VoterRegistrationNumber>336699774411</VoterRegistrationNumber>  
  <FirstIssueDate>2000-01-25</FirstIssueDate>  
  <LastIssueDate>2000-01-25</LastIssueDate>  
</VoterRegistration>
```

PESC XML Application for Admission Implementation Guide Version 1.3.0

Applicant.Residency.VehicleRegistration

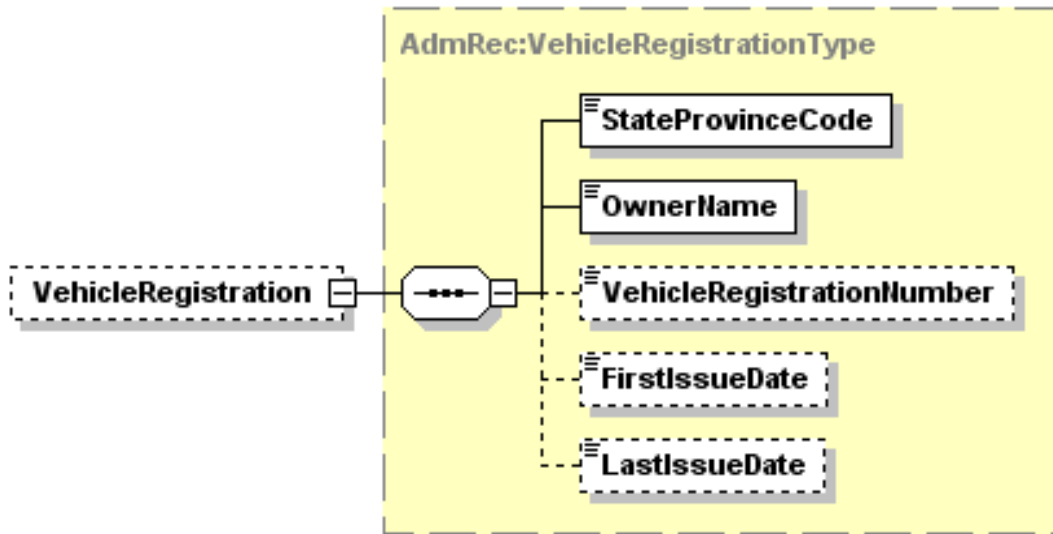

Tag Name	Schema Use	Description	Recommended Use	Format
StateProvinceCode	Required	The state or province which issued the vehicle registration document	Required	minOcc 1 maxOcc 1 See Appendix A.
Comment: Although the state or province is a required data element, if the complex data element VehicleRegistration is not included in the instance document, then state or province is not required.				
OwnerName	Required	The name of the owner (or lessee) of the vehicle that was registered	Required	minOcc 1 maxOcc 1 minLength 0 maxLength 40
Comment: Although the owner name is a required data element, if the complex data element VehicleRegistration is not included in the instance document, then owner name is not required.				
VehicleRegistrationNumber	Optional	The vehicle registration number assigned to the claimant for the vehicle registered	Optional	minOcc 0 maxOcc 1 minLength 0 maxLength 40
Comment: This is the license plate number on the primary vehicle owned or leased by the claimant.				
FirstIssueDate	Optional	The date the vehicle was first registered to the claimant	Optional	minOcc 0 maxOcc 1 Date field with format CCYY-MM-DD
LastIssueDate	Optional	The date the vehicle was last registered to the claimant	Optional	minOcc 0 maxOcc 1 Date field with format CCYY-MM-DD

Code illustration:

```

<VehicleRegistration>
  <StateProvinceCode>FL</StateProvinceCode>
  <OwnerName>Burt Reynolds</OwnerName>
  <VehicleRegistrationNumber>336699774411</VehicleRegistrationNumber>
  <FirstIssueDate>2000-01-25</FirstIssueDate>
  <LastIssueDate>2007-01-24</LastIssueDate>
</VehicleRegistration>

```

PESC XML Application for Admission Implementation Guide Version 1.3.0

Applicant.Residency.EmploymentResidency

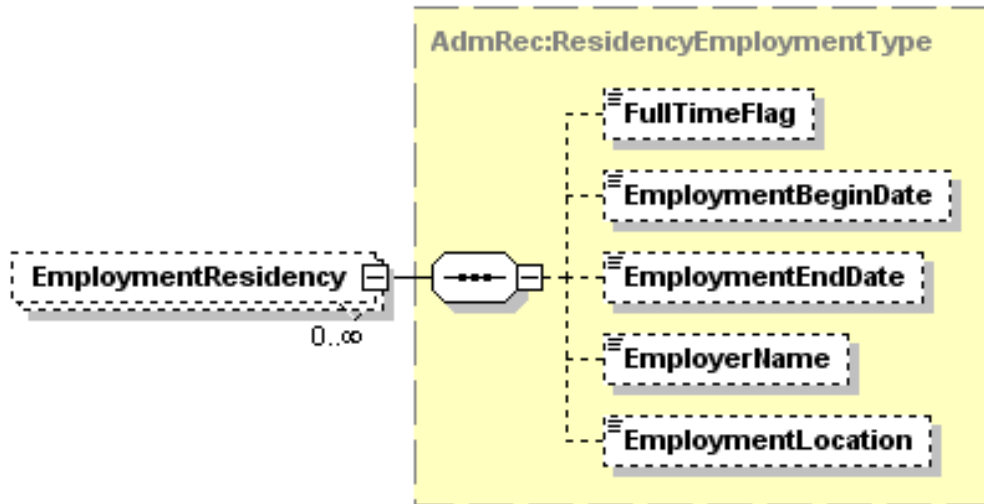

Tag Name	Schema Use	Description	Recommended Use	Format
FullTimeFlag	Optional	A flag to indicate if the claimant is or was a full-time or part-time employee	Optional	minOcc 0 maxOcc 1 Enumerations: FullTime PartTime
EmploymentBeginDate	Optional	The date that the claimant began employment	Optional	minOcc 0 maxOcc 1 Date field with format CCYY-MM-DD
EmploymentEndDate	Optional	The date that the claimant ended employment	Optional	minOcc 0 maxOcc 1 Date field with format CCYY-MM-DD
EmployerName	Optional	The name of the claimant's employer	Optional	minOcc 0 maxOcc 1 minLength 0 maxLength 40
Comment: This can include the name of the company or corporation, as well as the owner of that company or corporation at the site or approximate location of the claimant's work. Additional explanation, if desired, could be included in a note message.				
EmploymentLocation	Optional	The location of the employment	Optional	minOcc 0 maxOcc 1 minLength 0 maxLength 40
Comment: This is the primary location where the employee usually worked. This should include the city and state where the claimant performed work.				

Code illustration:

```

<EmploymentResidency>
  <FullTimeFlag>FullTime</FullTimeFlag>
  <EmploymentBeginDate>2005-03-25</EmploymentBeginDate>
  <EmploymentEndDate>2006-03-25</EmploymentEndDate>
  <EmployerName>Ben and Jerry's</EmployerName>
  <EmploymentLocation>Worth Avenue on Palm Beach</EmploymentLocation>
</EmploymentResidency>

```

PESC XML Application for Admission Implementation Guide Version 1.3.0

Applicant.Residency.EmploymentAtAppliedSchool

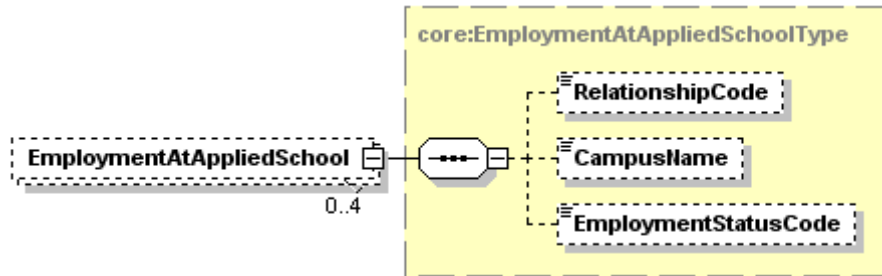

Tag Name	Schema Use	Description	Recommended Use	Format
RelationshipCode	Optional	The relationship, of the person who was or is employed at the school to which the applicant is applying, to the applicant	Recommended	minOcc 0 maxOcc 1 Enumerations: See list of relationship codes in Appendix D.
CampusName	Optional	The name of the specific campus of the school to which the applicant is applying	Optional	minOcc 0 maxOcc 1 minLength 0 maxLength 60
EmploymentStatusCode	Optional	The type of employment of the person who worked at the school to which the person is applying	Optional	minOcc 0 maxOcc 1 Enumerations: FullTime Other PartTime Retired Salary SelfEmployed SchoolYear Summer
<p>Comment: In many cases, an applicant may qualify for a special residency for fee status category if the applicant or a close relative of the applicant is or was employed at the school to which the person is applying.</p>				

Code illustration:

```

<EmploymentAtAppliedSchool>
  <RelationshipCode>Self</RelationshipCode>
  <CampusName>UC at Berkeley</CampusName>
  <EmploymentStatusCode>SchoolYear</EmploymentStatusCode>
</EmploymentAtAppliedSchool>

```

PESC XML Application for Admission Implementation Guide Version 1.3.0

Applicant.Residency.IncomeTaxInformation

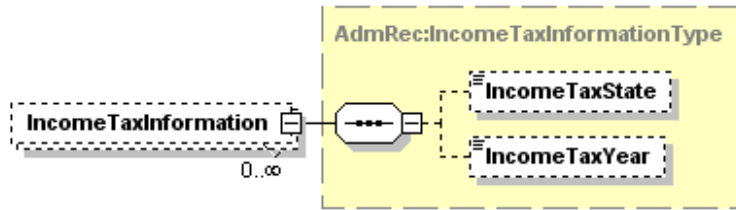

Tag Name	Schema Use	Description	Recommended Use	Format
IncomeTaxState	Optional	The state to which income taxes were paid	Optional	minOcc 0 maxOcc 1 See Appendix A
IncomeTaxYear	Optional Repeatable	The year that the claimant paid state income taxes	Optional	minOcc 0 maxOcc ∞ Date field with format CCYY

Comment: This allows the claimant to show that the employment was in the state for which residency is being claimed.

Code illustration:

```
<IncomeTaxInformation>
  <IncomeTaxState>NY</IncomeTaxState>
  <IncomeTaxYear>2006</IncomeTaxYear>
</IncomeTaxInformation>
```

PESC XML Application for Admission Implementation Guide Version 1.3.0

Applicant.Residency.PropertyOwned

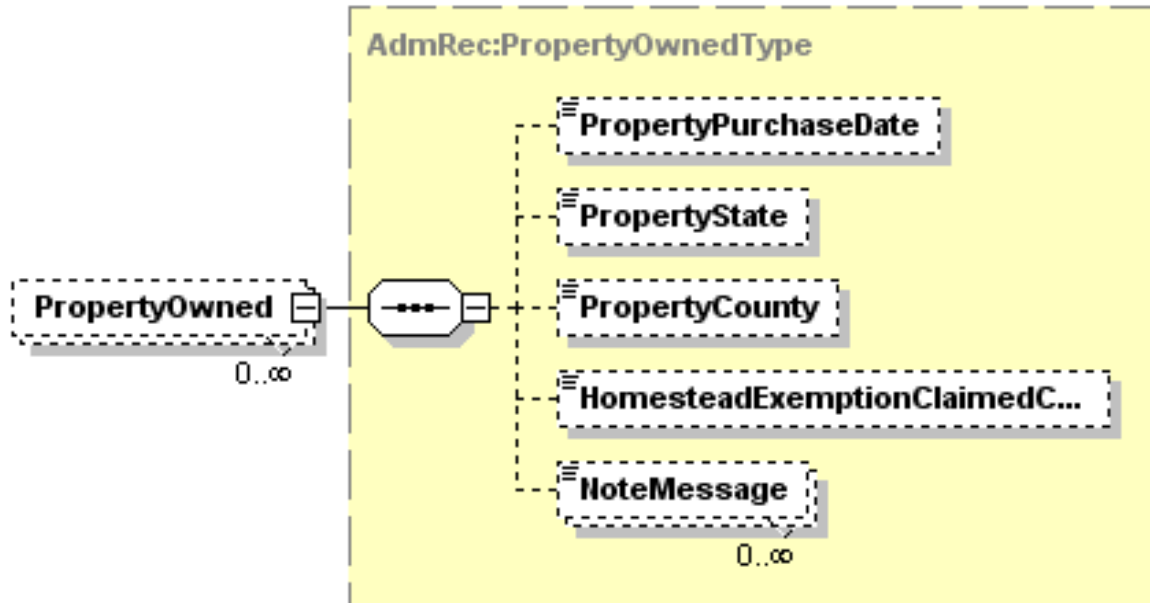

Tag Name	Schema Use	Description	Recommended Use	Format
PropertyPurchaseDate	Optional	The date that the claimant purchased real property in the state	Optional	minOcc 0 maxOcc 1 Date field with format CCYY-MM-DD
PropertyState	Optional	The state in which the real property owned by the claimant is located	Optional	minOcc 0 maxOcc 1 See Appendix A
PropertyCounty	Optional	The county in which the real property owned by the claimant is located	Optional	minOcc 0 maxOcc 1 minLength 1 maxLength 30
HomesteadExemptionClaimedCode	Optional	An indication that the claimant has been granted a homestead exemption by the state for the owned property	Optional	minOcc 0 maxOcc 1 Enumerations: No Pending Yes
NoteMessage	Optional Repeatable	Additional information about the real property owned by the claimant	Not Recommended	minOcc 0 maxOcc ∞ minLength 1 maxLength 80

Comment: Generally, only real property owned (and lived in) by the claimant for residency is considered in making a determination of residency for fee purposes.

Code illustration:

```

<PropertyOwned>
  <PropertyPurchaseDate>1980-01-01</PropertyPurchaseDate>
  <PropertyState>FL</PropertyState>
  <PropertyCounty>Duval</PropertyCounty>
  <HomesteadExemptionClaimedCode>Yes</HomesteadExemptionClaimedCode>
  <NoteMessage/>
</PropertyOwned>

```

PESC XML Application for Admission Implementation Guide Version 1.3.0

Applicant.Residency.PublicAssistanceReceived

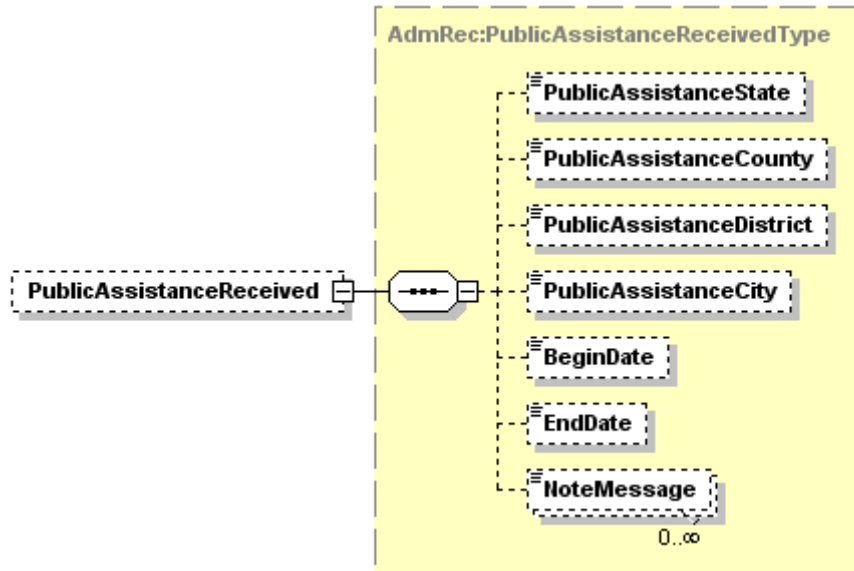

Tag Name	Schema Use	Description	Recommended Use	Format
PublicAssistanceState	Optional	The state or province in which the claimant receives public financial assistance	Optional	minOcc 0 maxOcc 1 See Appendix A
PublicAssistanceCounty	Optional	The county in which the claimant receives public financial assistance	Optional	minOcc 0 maxOcc 1 minLength 1 maxLength 30
PublicAssistanceDistrict	Optional	The district in which the claimant receives public financial assistance	Optional	minOcc 0 maxOcc 1 minLength 1 maxLength 30
PublicAssistanceCity	Optional	The city in which the claimant receives public financial assistance	Optional	minOcc 0 maxOcc 1 minLength 2 maxLength 30
BeginDate	Optional	The date on which the claimant began receiving public financial assistance in the state or province	Optional	minOcc 0 maxOcc 1 Date field with format CCYY-MM-DD
EndDate	Optional	The date on which the claimant stopped receiving public financial assistance in the state or province	Optional	minOcc 0 maxOcc Date field with format CCYY-MM-DD
NoteMessage	Optional Repeatable	Additional information about the claimant's receipt of public financial assistance	Not Recommended	minOcc 0 maxOcc ∞ minLength 1 maxLength 80

Code illustration:

```

<PublicAssistanceReceived>
  <PublicAssistanceState>FL</PublicAssistanceState>
  <PublicAssistanceCounty>Escambia</PublicAssistanceCounty>
  <PublicAssistanceDistrict>My Neighborhood</PublicAssistanceDistrict>
  <PublicAssistanceCity>My City</PublicAssistanceCity>
  <BeginDate>2003-10-05</BeginDate>
  <EndDate>2005-10-31</EndDate>
  <NoteMessage/>
</PublicAssistanceReceived>

```

PESC XML Application for Admission Implementation Guide Version 1.3.0

Applicant.Residency.ActiveDutyMilitary

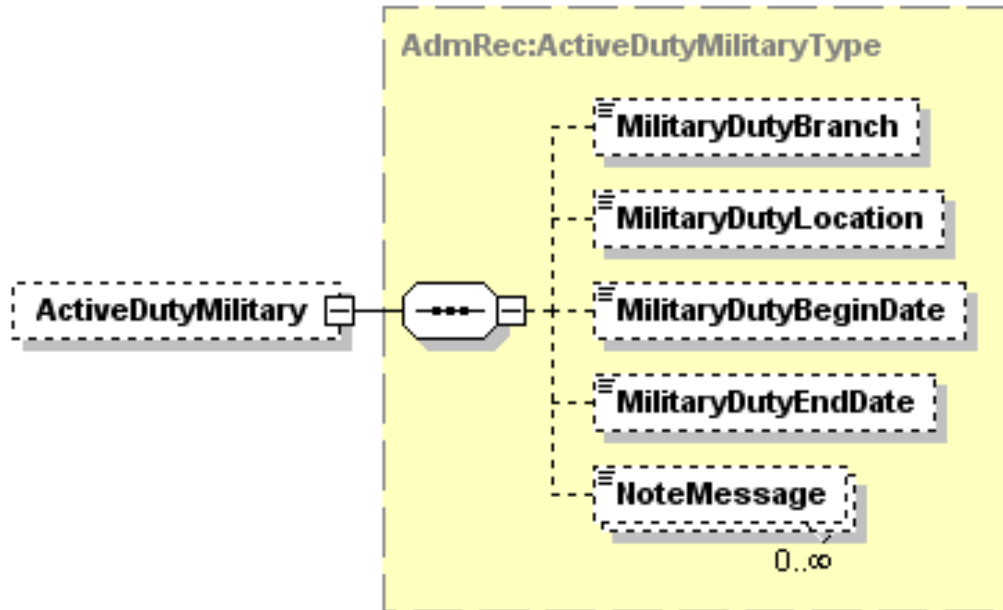

Tag Name	Schema Use	Description	Recommended Use	Format
MilitaryDutyBranch	Optional	The branch of the military in which the claimant is serving on active duty	Optional	minOcc 0 maxOcc 1 minLength 0 maxLength 40
MilitaryDutyLocation	Optional	The location where the claimant is serving on active duty	Optional	minOcc 0 maxOcc 1 minLength 0 maxLength 40
MilitaryDutyBeginDate	Optional	The date the claimant began serving in the branch of the military on active duty	Optional	minOcc 0 maxOcc 1 Date in format ccyy-mm-dd
MilitaryDutyEndDate	Optional	The date the claimant ceased serving on active duty in this branch of the military	Optional	minOcc 0 maxOcc 1 Date in format ccyy-mm-dd
NoteMessage	Optional Repeatable	Additional information about the active duty military experience of the claimant	Not Recommended	minOcc 0 maxOcc ∞ minLength 1 maxLength 80

Code illustration:

```

<ActiveDutyMilitary>
  <MilitaryDutyBranch>US Air Force</MilitaryDutyBranch>
  <MilitaryDutyLocation>Hurlbut Field at Ft. Walton Beach</MilitaryDutyLocation>
  <MilitaryDutyBeginDate>2003-10-05</MilitaryDutyBeginDate>
  <MilitaryDutyEndDate>2005-10-31</MilitaryDutyEndDate>
  <NoteMessage/>
</ActiveDutyMilitary>
  
```

PESC XML Application for Admission Implementation Guide Version 1.3.0

Applicant.Application

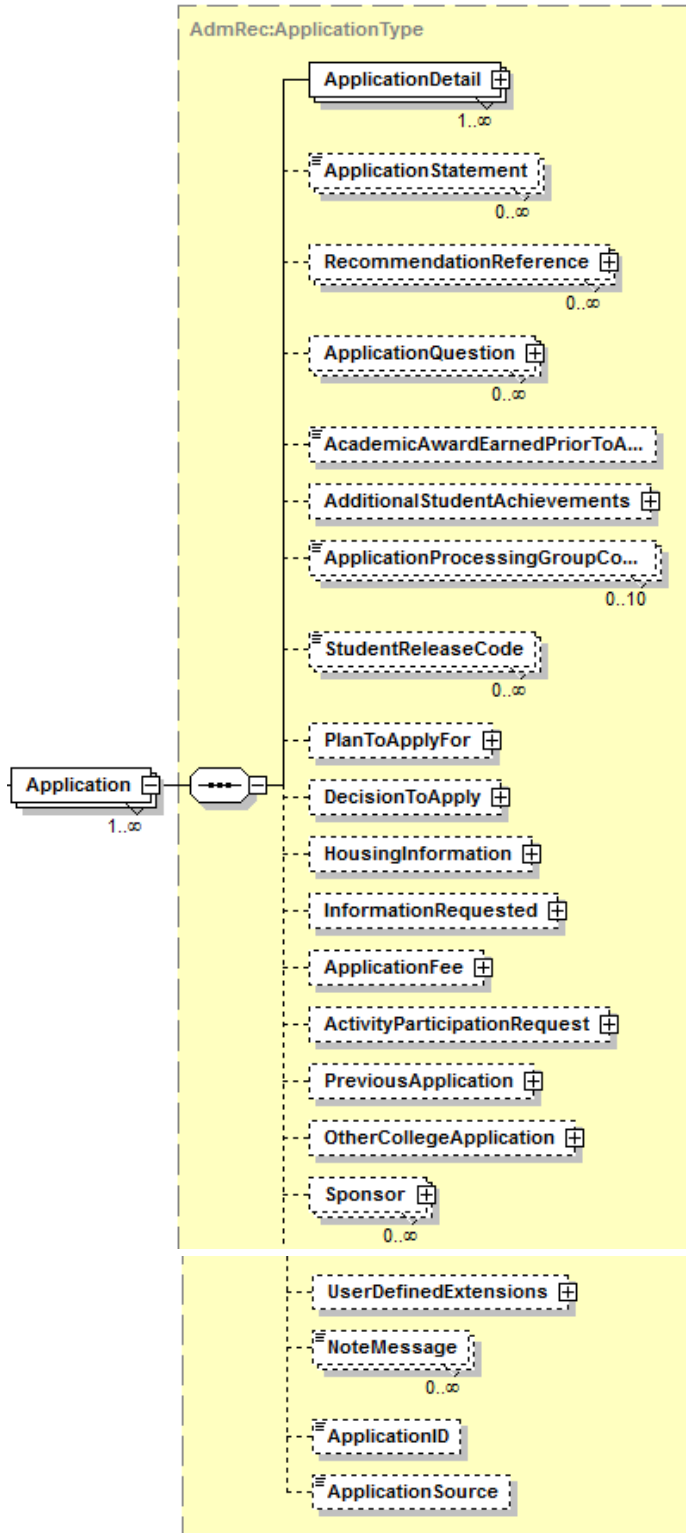

PESC XML Application for Admission Implementation Guide Version 1.3.0

Applicant.Application (Continued)

Tag Name	Schema Use	Description	Recommended Use	Format
ApplicationDetail	Required Repeatable	Details related to the specific application being created or modified by the applicant	Required	minOcc 1 maxOcc ∞
Comment: More detail will be presented about the complex data element ApplicationDetail on page 274.				
ApplicationStatement	Optional Repeatable	A statement submitted by the applicant	Optional	minOcc 0 maxOcc ∞ minLength 1 maxLength 500
RecommendationReference	Optional Repeatable	Information about recommendations to be provided in support of this application	Optional	minOcc 0 maxOcc ∞
Comment: More detail will be presented about this complex data element on page 291.				
ApplicationQuestion	Optional Repeatable	Pre-defined questions with answers submitted by the applicant	Optional	minOcc 0 maxOcc ∞
Comment: More detail will be presented about this complex data element on page 307. This is sometimes called "Shoe Box Questions" since these are a variety of questions typically asked only by one or a few schools and not enough to justify a specific data element for the question.				
AcademicAwardEarnedPriorToAdmission	Optional	Other achievements and accomplishments submitted by the applicant	Optional	minOcc 0 maxOcc ∞ Enumerations: AssociateDegree BaccalaureateDegree Doctorate MastersDegree ProfessionalDegree TwoYearCollegeDiploma
AdditionalStudentAchievements	Optional Repeatable	Other achievements and accomplishments submitted by the applicant	Optional	minOcc 0 maxOcc 1
Comment: More detail will be presented about this complex data element on page 310.				

PESC XML Application for Admission Implementation Guide

Version 1.3.0

Tag Name	Schema Use	Description	Recommended Use	Format
ApplicationProcessingGroup Code	Optional Repeatable	Type of matriculation that the applicant is seeking which determines the process by which the application is handled	Optional	minOcc 0 maxOcc 10 Enumerations: ContinuingEducation FirstTimeStudent GraduateLevel HighSchool HighSchoolDual International MatureStudent NonDegree Other PostBaccalaureate PostDoctoral PostGraduate Professional Readmit Special Transfer Transient Undergraduate VisitingExchangeStudent
<p>Comment: The purpose of this data element is to indicate the processing flow for the application. In many schools, the means of processing the application, or the office that may process it, is different for some or all of the enumerated values.</p> <p>The intent of this data element is to determine the one (and normally only one) processing group into which the applicant will fall so that the application will be processed correctly at the school to which the person is applying.</p> <p>At some schools, this may be done as part of the process during which the person applies. Then the one group (among all those that apply for the applicant) is determined by that program that interacts with the applicant. In this case, only one enumerated value would be included in the instance document.</p> <p>At other schools, the applicant provides all the categories that apply among the enumerated values in the Application Processing Group. All the applicable values are then included in the instance document. When the instance document is received by the school to which the student applied, that school then makes the determination of which one (or possibly more than one) processing group takes priority.</p>				
StudentReleaseCode	Optional Repeatable	Type of certification made by the applicant about the application being submitted and permission given by the student to obtain or release information about the applicant	Optional	minOcc 0 maxOcc ∞ Enumerations: AllValuesIncluded AllTrue HonorCode ObtainTestScores ObtainTranscripts ReleaseTestScores ReleaseTranscripts
<p>Comment: For example, the enumerated values can be used to convey questions asked on the application like: AllValuesIncluded: Have you listed all previous schools in which you were ever enrolled? AllTrue: Is all the information you have provided on this application both accurate and complete? HonorCode: If admitted as a student to this school, do you agree to abide by all the rules of the school's Honor Code? ObtainTestScores: Do you agree to allow the school to request test scores from all the national testing agencies? ObtainTranscripts: Do you agree to allow the school to request transcripts from all schools in which you previously enrolled? ReleaseTestScores: Do you give this school permission to release test scores when requested by other accredited colleges? ReleaseTranscripts: Do you give this school permission to release your academic record (transcript) when requested from other accredited schools to which you may later apply?</p>				
PlanToApplyFor	Optional	Specific programs or aid for which the applicant is applying	Optional	minOcc 0 maxOcc 1
<p>Comment: More detail will be presented about this complex data element on page 316.</p>				
DecisionToApply	Optional	Factors that affected the applicant's decision to apply to this institution	Optional	minOcc 0 maxOcc 1
<p>Comment: More detail will be presented about this complex data element on page 317.</p>				

PESC XML Application for Admission Implementation Guide

Version 1.3.0

Tag Name	Schema Use	Description	Recommended Use	Format
HousingInformation	Optional	Additional info being requested about student housing	Optional	minOcc 0 maxOcc 1
<i>Comment: More detail will be presented about this complex data element on page 319.</i>				
InformationRequested	Optional	Additional programs or activities that the applicant is interested in that might be offered at the school	Optional	minOcc 0 maxOcc 1
<i>Comment: More detail will be presented about this complex data element on page 320.</i>				
ApplicationFee	Optional	Information about the application fee being paid or waived and provided by the applicant	Optional	minOcc 0 maxOcc 1
<i>Comment: More detail will be presented about this complex data element on page 321.</i>				
ActivityParticipationRequest	Optional	Information about the activities in which the applicant has indicated a desire to participate	Optional	minOcc 0 maxOcc 1
<i>Comment: More detail will be presented about this complex data element on page 323.</i>				
PreviousApplication	Optional	Information about a previous application submitted to this school	Optional	minOcc 0 maxOcc 1
<i>Comment: More detail will be presented about this complex data element on page 324.</i>				
OtherCollegeApplication	Optional	Information about applications previously (or soon to be) submitted to other postsecondary schools	Optional	minOcc 0 maxOcc 1
<i>Comment: More detail will be presented about this complex data element on page 325.</i>				
Sponsor	Optional Repeatable	Information about an individual, school, company, agency or other entity that is supporting the applicant	Optional	minOcc 0 maxOcc ∞
<i>Comment: More detail will be presented about this complex data element on page 327.</i>				
UserDefinedExtensions	Optional	A mini schema that can be inserted that will be used by selected partners. Others that are not interested in it can ignore it.	Optional	minOcc 0 maxOcc 1
NoteMessage	Optional Repeatable	Additional information about the application	Not Recommended	minOcc 0 maxOcc ∞ minLength 1 maxLength 80

PESC XML Application for Admission Implementation Guide Version 1.3.0

Applicant.Application (Continued)

Code illustration:

```
<Application>
  <ApplicationDetail>

    </ApplicationDetail>
    <ApplicationStatement>I agree that everything I've sent is true and complete. </ApplicationStatement>
    <RecommendationReference>

      </RecommendationReference>
      <ApplicationQuestion>

        </ApplicationQuestion>
        <AcademicAwardEarnedPriorToAdmission>AssociateDegree</AcademicAwardEarnedPriorToAdmission>
        <AdditionalStudentAchievements>

          </AdditionalStudentAchievements>
          <ApplicationProcessingGroupCode>FirstTimeStudent</ApplicationProcessingGroupCode>
          <StudentReleaseCode>AllTrue</StudentReleaseCode>
          <PlanToApplyFor>

            </PlanToApplyFor>
            <DecisionToApply>

              </DecisionToApply>
              <HousingInformation>

                </HousingInformation>
                <InformationRequested>

                  </InformationRequested>
                  <ApplicationFee>

                    </ApplicationFee>
                    <ActivityParticipationRequest>

                      </ActivityParticipationRequest>
                      <PreviousApplication>

                        </PreviousApplication>
                        <OtherCollegeApplication>

                          </OtherCollegeApplication>
                          <Sponsor>

                            </Sponsor>
                            <UserDefinedExtensions/>
                            <NoteMessage/>
                          </Application>

```

PESC XML Application for Admission Implementation Guide Version 1.3.0

Applicant.Application.ApplicationDetail

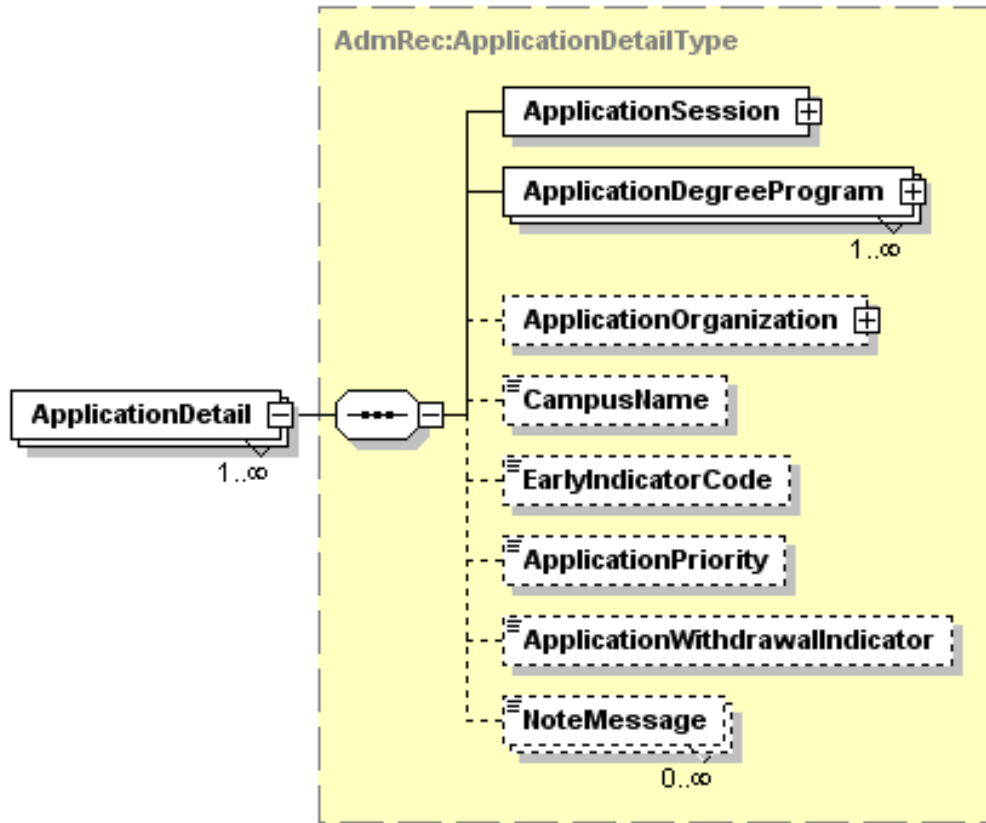

Tag Name	Schema Use	Description	Recommended Use	Format
ApplicationSession	Required	The specific term or session for which the applicant is applying	Required	minOcc 1 maxOcc 1
Comment: Additional information about this complex data element will be presented on page 276.				
ApplicationDegreeProgram	Required Repeatable	The specific academic program for which the applicant is applying	Required	minOcc 1 maxOcc ∞
Comment: Additional information about the complex data element ApplicationDegreeProgram will be presented on page 278.				
ApplicationOrganization	Optional	The specific organization within the system to which the applicant is applying	Optional	minOcc 0 maxOcc 1
Comment: Additional information about this complex data element will be presented on page 286. This would not normally be included in the instance document, unless the applicant was specifically applying to a special entity within the school. For example, if the law school processes the application in a system other than the main one used by the university or college.				

PESC XML Application for Admission Implementation Guide

Version 1.3.0

Tag Name	Schema Use	Description	Recommended Use	Format
CampusName	Optional	The campus that the applicant indicates is the preferred campus for this application	Optional	minOcc 0 maxOcc 1 minLength 1 maxLength 60
Comment: Of course, if the postsecondary institution does not have a choice of campuses, this data element would not be included in the instance document. And, if the degree program is only offered on one campus, that may be assumed in the "ApplicationDegreeProgram" above.				
EarlyIndicatorCode	Optional	If this is an early application for admission, this can indicate the type of early action to be taken on the application	Optional	minOcc 0 maxOcc 1 Enumerations: EarlyAction EarlyAdmission EarlyDecision RestrictedEarlyAction
ApplicationPriority	Optional	The priority to be given to processing this particular application for this campus, term and program.	Optional	minOcc 0 maxOcc 1 Format is an integer
Comment: If this is the only application, then this data element would not be included in the instance document. If, however, the student was submitting a first (and other choices) of term, program, or campus, then the first choice would be indicated with a "1", the second choice with a "2", etc.				
ApplicationWithdrawalIndicator	Optional	An indication that the student is requesting the application is to be withdrawn	Optional	minOcc 0 maxOcc 1 boolean
Comment: If the student is not requesting the withdrawal of the application, then this data element would not be included in the instance document. If the student is requesting the withdrawal of the application, then the value of this data element would be "true".				
NoteMessage	Optional	Uncoded text information about this application	Not recommended	minOcc 0 maxOcc ∞ minLength 1 maxLength 80
Comment: Because this information is not normally coded, it cannot be automatically processed by a computer. Therefore, its use in an XML application for admission is discouraged. However, if there is a prior agreement between the sender and the recipient, it could be formatted in a previously agreed upon manner between the two parties and therefore might assist in the processing of the application.				

Code illustration:

```

<ApplicationDetail>
  <ApplicationSession>

    </ApplicationSession>
    <ApplicationDegreeProgram>

      </ApplicationDegreeProgram>
      <ApplicationOrganization>

        </ApplicationOrganization>
        <CampusName>Main</CampusName>
        <EarlyIndicatorCode>EarlyAction</EarlyIndicatorCode>
        <ApplicationPriority>1</ApplicationPriority>
        <ApplicationWithdrawalIndicator/>
        <NoteMessage/>
      </ApplicationDetail>

```

PESC XML Application for Admission Implementation Guide Version 1.3.0

Applicant.Application.ApplicationDetail.ApplicationSession

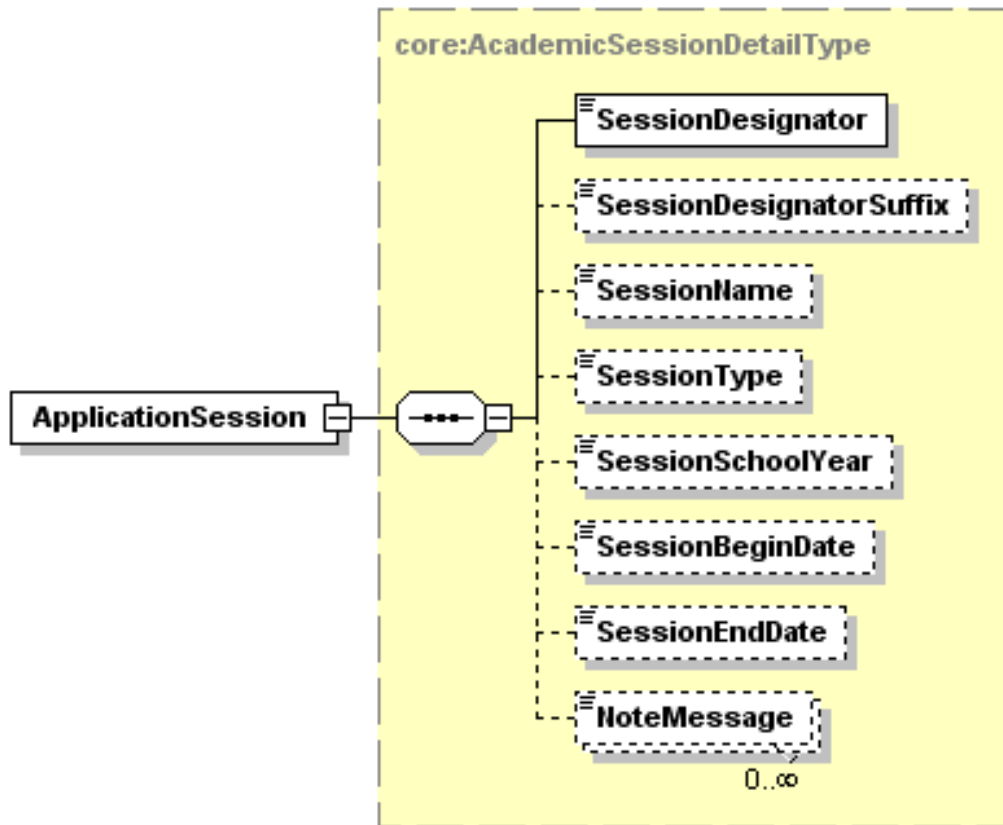

Tag Name	Schema Use	Description	Recommended Use	Format
SessionDesignator	Required	The academic session for which the applicant is applying.	Required	minOcc 1 maxOcc 1 YearMonth (ccyy-mm)
Comment: The Session Designator is used to indicate the starting year and month of major academic terms within the school's calendar. For example, a typical fall term would begin in August or September. So, for a fall term that begins in August of the year 2007, the value of this field would be "2007-08".				
SessionDesignatorSuffix	Optional	A free form extension to the session ID to differentiate discreet sub-sessions within the same session	Optional	minOcc 0 maxOcc 1 minLength 1 maxLength 10
Comment: If you have a mini term or short term within the major term, you can use this field to identify those specific classes for which the applicant is applying. Typical entries in this field might be "Mini Term", "Term A", "Term B", "Session 1".				
SessionName	Optional	Free-form name of session.	Recommended	minOcc 0 maxOcc 1 minLength 1 maxLength 30
Comment: For example, "Fall Semester 2007" or "Fall Semester 2008" or "Fall Semester 2007-2008".				

PESC XML Application for Admission Implementation Guide

Version 1.3.0

Tag Name	Schema Use	Description	Recommended Use	Format
SessionType	Optional	Indicates the type of academic session at an educational institution.	Recommended	minOcc 0 maxOcc 1 Enumerations: Continuous DiffersByProgram FallSession FourOneFourPlan FullYear Intersession LongSession MiniTerm Other Quarter Quinmester Semester SummerSession Trimester TwelveMonth
Comment: This is the type of calendar used by the sending school. It does not refer to the type of units of credit awarded.				
SessionSchoolYear	Optional	This is the range of years that are considered to be a school year.	Optional	minOcc 0 maxOcc 1 xs:date with pattern \d{4}-\d{4} in format ccyy-ccyy
Comment: The appropriate values are a range of years. The format would be ccyy-ccyy. A typical example would be the school year "2010-2011".				
SessionBeginDate	Optional	Actual calendar date when session begins.	Optional	minOcc 0 maxOcc 1 xs:date where format is ccyy-mm-dd
Comment: An example for a fall term might be "2009-08-22". The date format is ccyy-mm-dd.				
SessionEndDate	Optional	Actual calendar date when session ends.	Optional	minOcc 0 maxOcc 1 xs:date where format is ccyy-mm-dd
Comment: An example for a fall term might be "2009-12-16" or "2010-01-18". However, it would be unusual to include this in an application for admission.				
NoteMessage	Optional Repeatable	Additional information about the Academic Session	Not Recommended	minOcc 0 maxOcc ∞ minLength 1 maxLength 80

Code illustration:

```

<ApplicationSession>
  <SessionDesignator>2007-08</SessionDesignator>
  <SessionDesignatorSuffix/>
  <SessionName>Fall Term 2007-2008</SessionName>
  <SessionType>Semester</SessionType>
  <SessionSchoolYear/>
  <SessionBeginDate>2007-08-27</SessionBeginDate>
  <SessionEndDate>2007-12-21</SessionEndDate>
  <NoteMessage/>
</ApplicationSession>

```

PESC XML Application for Admission Implementation Guide Version 1.3.0

Applicant.Application.ApplicationDetail.ApplicationDegreeProgram

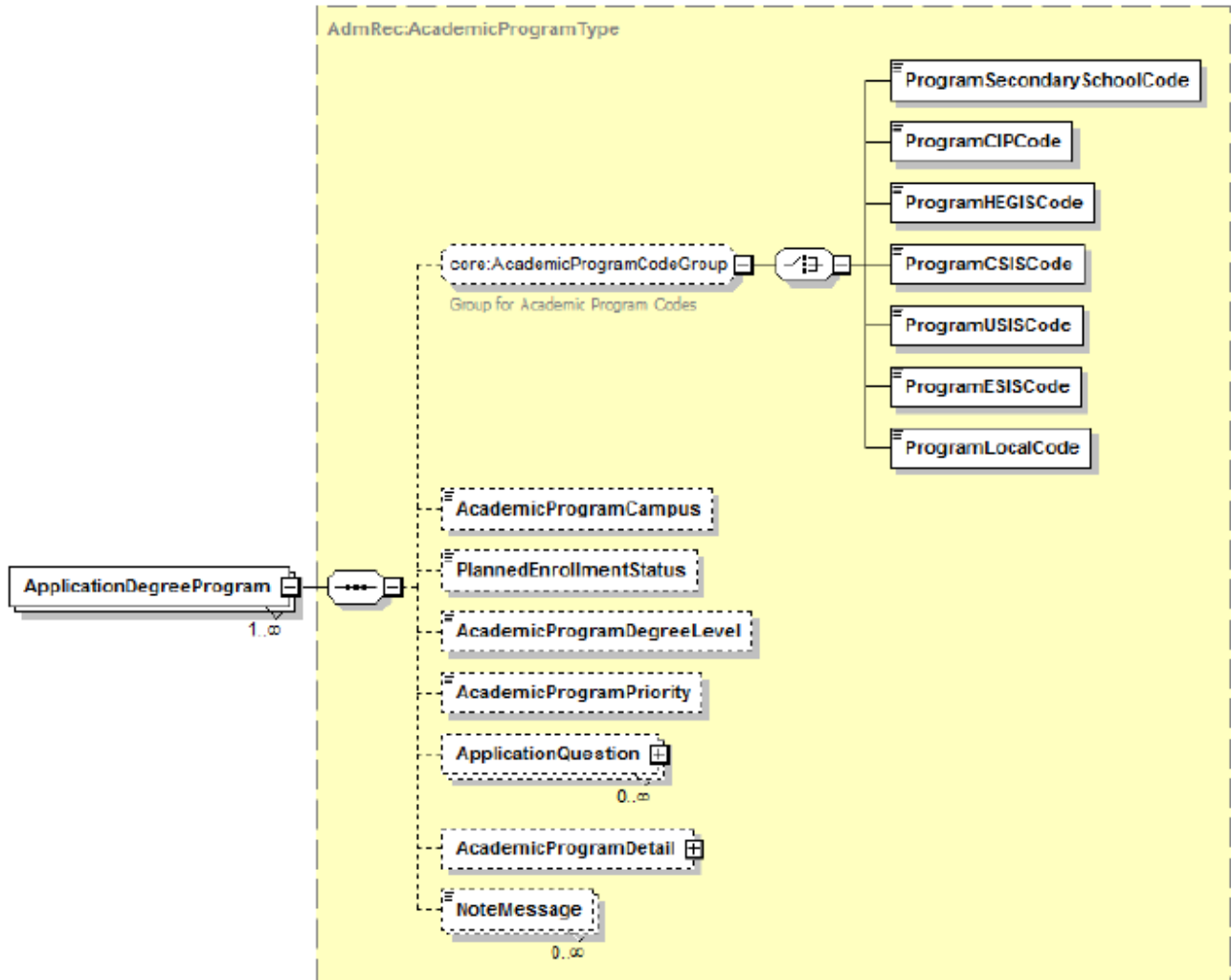

Tag Name	Schema Use	Description	Recommended Use	Format
ProgramSecondarySchoolCode	Optional exclusive choice	Code indicating a discipline or field of study pursued by a secondary school student	Optional	minOcc 0 maxOcc 1 Enumerations: CareerPrep CollegePrep CollegePrepOrCollegeTechPrep hPrep CollegeTechPrep General Occupational Vocational
ProgramCIPCode	Optional exclusive choice	Code indicating a discipline or field of study assigned by the Classification of Instructional Programs	Optional	minOcc 0 maxOcc 1 minLength 6 maxLength 20
ProgramHEGISCode	Optional exclusive choice	Code indicating a discipline or field of study assigned by Higher Education General Information Survey	Not Recommended	minOcc 0 maxOcc 1 minLength 6 maxLength 20

PESC XML Application for Admission Implementation Guide

Version 1.3.0

Tag Name	Schema Use	Description	Recommended Use	Format
ProgramCSISCode	Optional exclusive choice	Code indicating a discipline or field of study assigned by Statistics Canada Canadian College Student Information System	Not Recommended	minOcc 0 maxOcc 1 minLength 5 maxLength 5
ProgramUSISCode	Optional exclusive choice	Code indicating a discipline or field of study assigned by the Statistics Canada University Student Information System.	Not Recommended	minOcc 0 maxOcc 1 minLength 5 maxLength 5
ProgramESISCode	Optional exclusive choice	Code indicating a discipline or field of study assigned by the Statistics Canada Enhanced Student Information System.	Optional	minOcc 0 maxOcc 1 minLength 1 maxLength 20
ProgramLocalCode	Optional exclusive choice	Code indicating a the specific program (with options, if any) that the student selects from a list of available programs	Recommended	minOcc 0 maxOcc 1 minLength 1 maxLength 20
<p>Comment: Although the above 7 choices for program codes are optional, the last choice is probably the most appropriate to describe the specific academic programs at the specific school to which the applicant is applying. For later state and federal reporting, the local code would be linked to one or more of the other codes in the school's data base.</p>				
AcademicProgramCampus	Optional	The preferred campus specified by the applicant for this particular program.	Optional	minOcc 0 maxOcc 1 minLength 1 maxLength 60
PlannedEnrollmentStatus	Optional	The anticipated enrollment level of the applicant	Optional	minOcc 0 maxOcc 1 Enumerations: FullTime PartTime
AcademicProgramDegreeLevel	Optional	The level of the degree for which the applicant is applying	Optional	minOcc 0 maxOcc 1 Enumerations: AssociateDegree BaccalaureateDegree Certificate Doctorate GraduateDegree HighSchool MastersDegree NonDegree PostsecondaryDiploma ProfessionalDegree
AcademicProgramPriority	Optional	The priority ranking for this program with relation to other programs requested in the application for admission (First, second, etc.)	Optional	minOcc 0 maxOcc 1 Format is an integer
<p>Comment: If this is the only program for which the person is applying, then this data element would not be included in the instance document. If, however, the student was submitting a first (and other choices) of term, program, or campus, then the first choice would be indicated with a "1", the second choice with a "2", etc.</p>				
ApplicationQuestion	Optional Repeatable	Specific questions that a school might ask the applicant that relate to the academic program for which the student is applying	Optional	minOcc 0 maxOcc ∞
<p>Comment: This complex data element will be expanded on page 281 which follows.</p>				

PESC XML Application for Admission Implementation Guide Version 1.3.0

Tag Name	Schema Use	Description	Recommended Use	Format
AcademicProgramDetail	Optional	Additional information about the academic program for which the person has applied	Optional	minOcc 0 maxOcc 1
Comment: This complex data element will be expanded on page 285 which follows.				
NoteMessage	Optional Repeatable	Additional information about the Academic Program for which the applicant is applying	Not Recommended	minOcc 0 maxOcc ∞ minLength 1 maxLength 80

Applicant.Application.ApplicationDetail.ApplicationDegreeProgram (Continued)

Code illustration:

```

<ApplicationDegreeProgram>
  <ProgramLocalCode>BA Music</ProgramLocalCode>
  <AcademicProgramCampus>Main</AcademicProgramCampus>
  <PlannedEnrollmentStatus>FullTime</PlannedEnrollmentStatus>
  <AcademicProgramDegreeLevel>BaccalaureateDegree</AcademicProgramDegreeLevel>
  <AcademicProgramPriority>1</AcademicProgramPriority>
  <ApplicationQuestion>

  </ApplicationQuestion>
  <AcademicProgramDetail>

  </AcademicProgramDetail>
  <NoteMessage/>
</ApplicationDegreeProgram>

```

PESC XML Application for Admission Implementation Guide Version 1.3.0

Applicant.Application.ApplicationDetail.ApplicationDegreeProgram. ApplicationQuestion

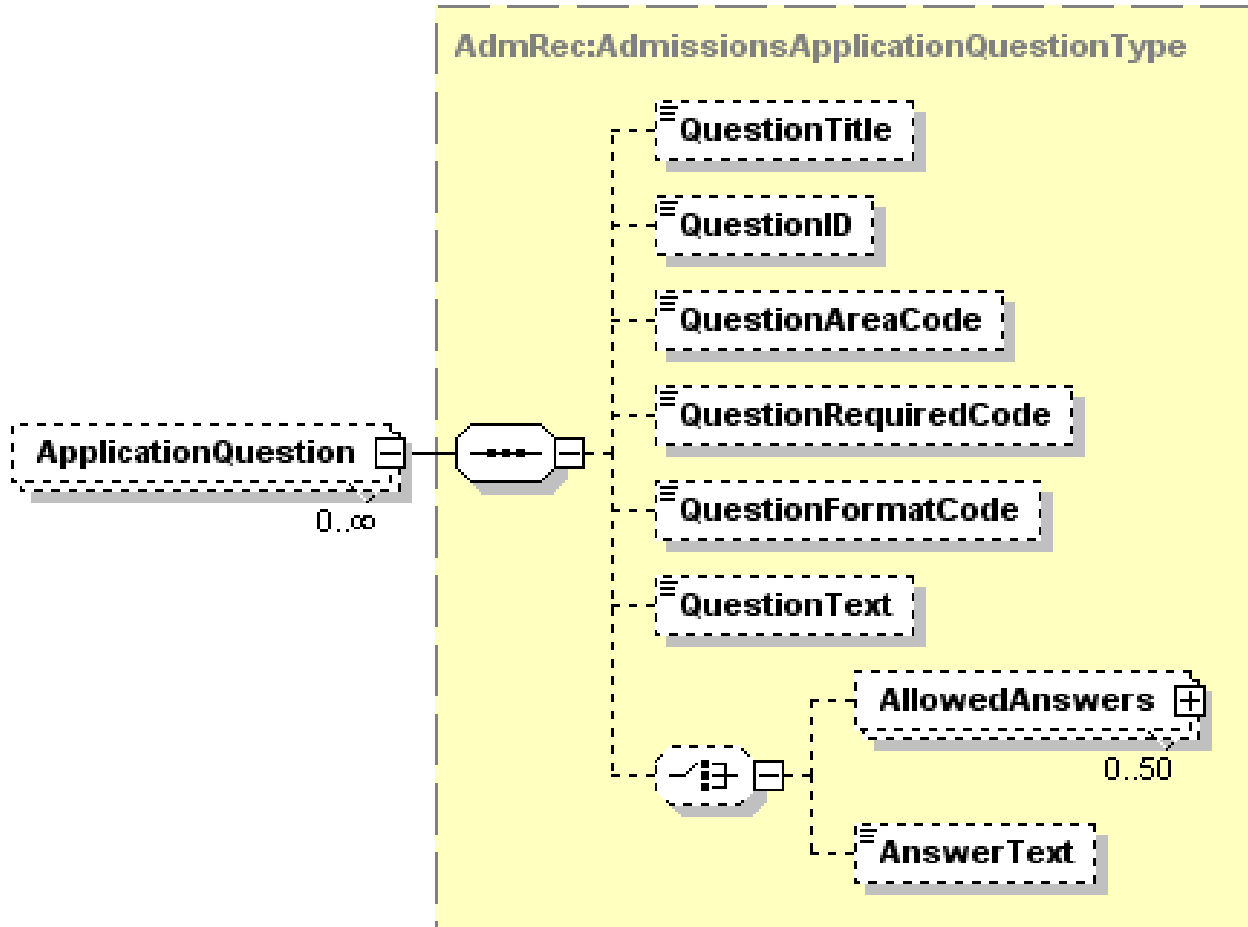

Tag Name	Schema Use	Description	Recommended Use	Format
QuestionTitle	Optional	A short title of the specific question asked of the applicant	Optional	minOcc 0 maxOcc 1 minLength 1 maxLength 30
QuestionID	Optional	An identifier that distinguishes this question from all other questions that might be asked	Optional	minOcc 0 maxOcc 1 minLength 0 maxLength 15
Comment: This ID could be just a unique number, or it could include portions that identify the type of question, the area at the school that is asking the question, etc.				

PESC XML Application for Admission Implementation Guide

Version 1.3.0

Tag Name	Schema Use	Description	Recommended Use	Format
QuestionAreaCode	Optional	This would identify the subject area of the question	Optional	minOcc 0 maxOcc 1 Enumerations: AcademicRecord Admissions Biographical Education Employment Essay ExtraCurricularActivities Family FinancialAid General Health HonorsAwards Housing Immigration Other Personal References Residency Scholarship Tests
QuestionRequiredCode	Optional	This would indicate whether or not this was a question that the applicant was required to answer	Optional	minOcc 0 maxOcc 1 Enumerations: Optional Required
Comment: Since the applications for admission at any given school are modified on a fairly regular basis, this would allow an historical record of whether or not this question was required at the time the applicant was presented with the question.				
QuestionFormatCode	Optional	This would indicate the format of the question asked	Optional	minOcc 0 maxOcc 1 Enumerations: CheckBox DropDownMenu NoInput OneLineText RadioButton TextArea
Comment: The types of questions would be: Check Box: The applicant was provided with a list of answers and the applicant could check as many as were applicable. DropDownMenu: No Input: Information was provided to the applicant, but no response was allowed. This would be a record that the student was provided with the information. One Line Text: A question was asked and the student was allowed to enter a single line of text as a response. Radio Button: A question was asked and the student was required to choose one, and only one, of the responses provided. Text Area: A question was asked and the student was provided a large block of space to provide a response.				
QuestionText	Optional	This would indicate the actual text of the question that the applicant was asked	Optional	minOcc 0 maxOcc 1 minLength 1 maxLength ∞
Comment: In the instance document, there is no limit to the number of characters that can be used for QuestionText. However, users should still try to limit the size so that it can be processed more reliably and efficiently by the recipient of the XML document.				
AllowedAnswers	Optional Choice Repeatable	This would specify the allowed responses from which the applicant must choose	Optional	minOcc 0 maxOcc 50
Comment: This complex data element will be expanded on page 284 which follows in this Guide.				

PESC XML Application for Admission Implementation Guide

Version 1.3.0

Tag Name	Schema Use	Description	Recommended Use	Format
AnswerText	Optional Choice	This would indicate the actual text of the question that the applicant was asked	Optional	minOcc 0 maxOcc 1 minLength 1 maxLength ∞
Comment: <i>Although this data element has no maximum length, the users should attempt to limit the length for easier processing by the recipient.</i>				

Applicant.Application.ApplicationDetail.ApplicationDegreeProgram. ApplicationQuestion (Continued)

Code illustration:

```

<ApplicationQuestion>
  <QuestionTitle>Southern Regional Education Board's Grad Student</QuestionTitle>
  <QuestionID>UGRes123456789</QuestionID>
  <QuestionAreaCode>Residency</QuestionAreaCode>
  <QuestionRequiredCode>Optional</QuestionRequiredCode>
  <QuestionFormatCode>CheckBox</QuestionFormatCode>
  <QuestionText>I am a Southern Regional Education Boards's Academic Common Market graduate student.
  (Required: Certification letter from State Coordinator.) </QuestionText>
  <AllowedAnswers>

  </AllowedAnswers>
  <AnswerText/>
</ApplicationQuestion>

```

PESC XML Application for Admission Implementation Guide Version 1.3.0

Applicant.Application.ApplicationDetail.ApplicationDegreeProgram. ApplicationQuestion.AllowedAnswers

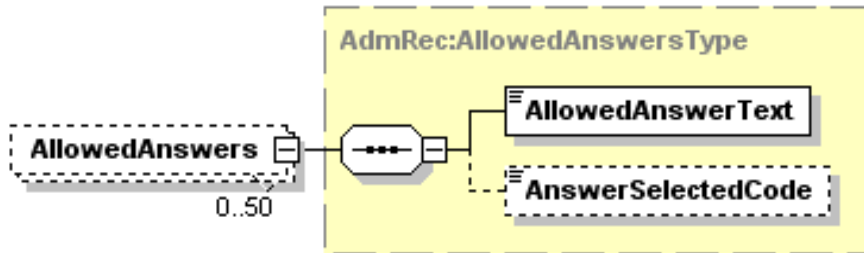

Tag Name	Schema Use	Description	Recommended Use	Format
AllowedAnswerText	Required	An answer that the applicant was provided and allowed to select	Required	minOcc 1 maxOcc 1 minLength 1 maxLength ∞
Comment: Although there is no specified maximum length for this data element, users should still try to minimize the length to make it more practical for the recipient of the instance document to process it.				
AnswerSelectedCode	Optional	An indication that the student did or did not select this answer	Optional	minOcc 0 maxOcc 1 Enumerations: NotSelected Selected

Code illustration:

```

<AllowedAnswers>
  <AllowedAnswerText>I have not applied to any other postsecondary school in this state.
</AllowedAnswerText>
  <AnswerSelectedCode>Selected</AnswerSelectedCode>
</AllowedAnswers>

<AllowedAnswers>
  <AllowedAnswerText>I don't plan to apply to any other postsecondary school in the US.
</AllowedAnswerText>
  <AnswerSelectedCode>NotSelected</AnswerSelectedCode>
</AllowedAnswers>

```

PESC XML Application for Admission Implementation Guide Version 1.3.0

Applicant.Application.ApplicationDetail.ApplicationDegreeProgram. AcademicProgramDetail

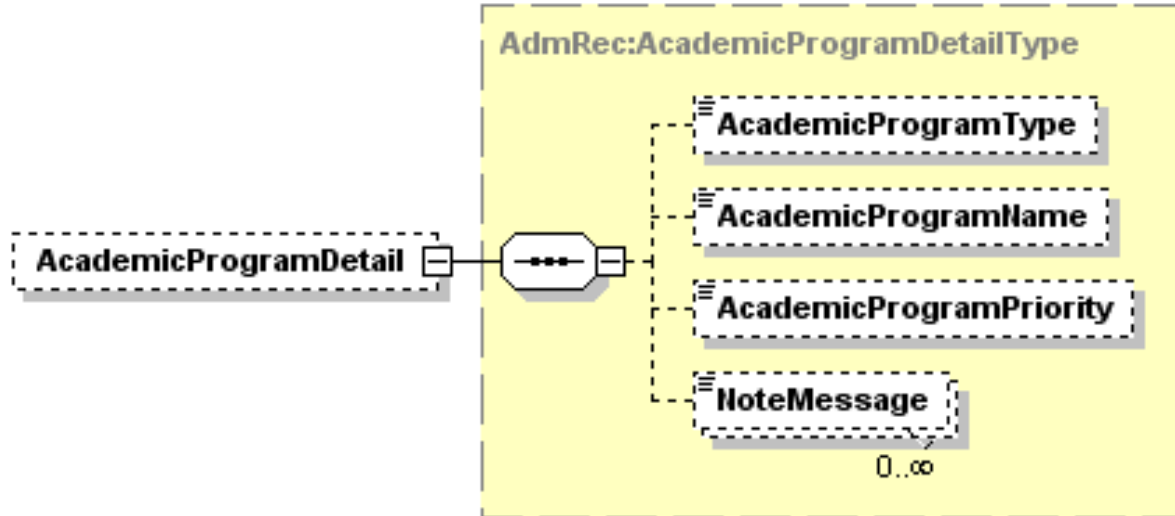

Tag Name	Schema Use	Description	Recommended Use	Format
AcademicProgramType	Optional	The specific category of the academic program for which the person is applying	Optional	minOcc 0 maxOcc 1 Enumerations: Concentration Focus Major Minor SecondMajor Specialization
AcademicProgramName	Optional	The specific name of the academic program for which the person is applying	Optional	minOcc 0 maxOcc 1 minLength 1 maxLength 60
AcademicProgramPriority	Optional	The priority that the applicant has given this particular program among all the programs to which the applicant is applying	Optional	minOcc 0 maxOcc 1 Data type is an integer
Comment: <i>If the applicant has applied for six programs and this program is the second choice, then this value would be "2".</i>				
NoteMessage	Optional	Additional information about the details of the Academic Program	Not Recommended	minOcc 0 maxOcc ∞ minLength 1 maxLength 80

Code illustration:

```

<AcademicProgramDetail>
  <AcademicProgramType>Major</AcademicProgramType>
  <AcademicProgramName>Bachelor of Fine Arts</AcademicProgramName>
  <AcademicProgramPriority>1</AcademicProgramPriority>
  <NoteMessage/>
</AcademicProgramDetail>
  
```

PESC XML Application for Admission Implementation Guide Version 1.3.0

Applicant.Application.ApplicationDetail.ApplicationOrganization

Note: If the complex data element ApplicationOrganization is included in the instance document, then OrganizationName must be included.

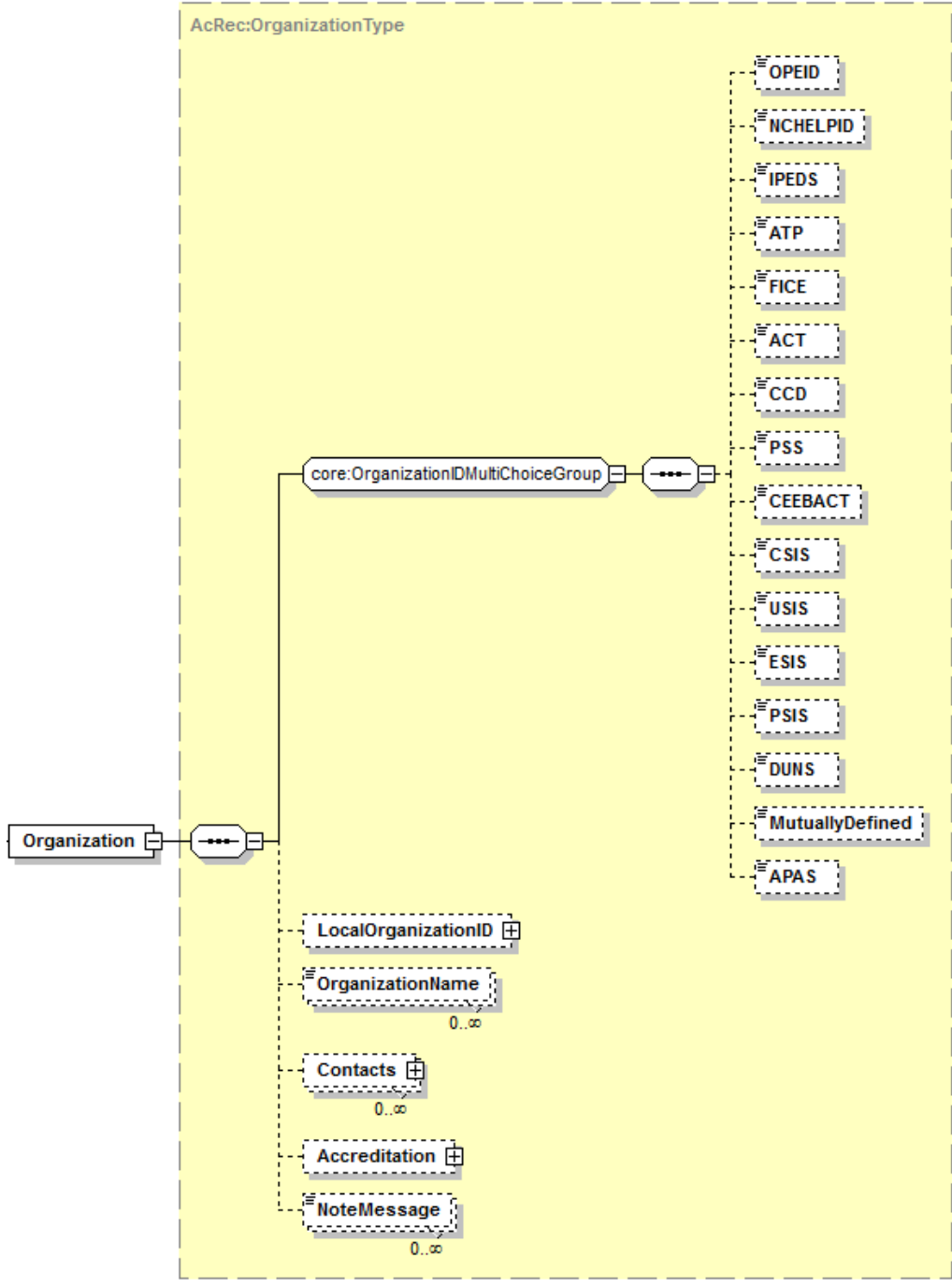

PESC XML Application for Admission Implementation Guide Version 1.3.0

Applicant.Application.ApplicationDetail.ApplicationOrganization (Continued)

Tag Name	Schema Use	Description	Recommended Use	Format
[OrganizationIDGroup]	Optional	Allowable Organization IDs - Exclusive choice	Optional	minOcc 0 maxOcc 1
Comment: [OrganizationIDGroup] is not an XML tag and does not appear in an instance document. If included, it allows the choice of one and only one of the following code set tags to identify the source school of the academic record being reported.				
OPEID	Optional choice	The unique identifier assigned by the Office of Postsecondary Education for each data exchange partner. Includes all postsecondary schools that are eligible to participate in US Title IV federal financial aid programs.	Recommended	minOcc 0 maxOcc 1 minLength 3 maxLength 8
Comment: The OPEID could be an appropriate choice.				
NCHELPID	Optional choice	The unique identifier assigned by National Council on Higher Education Loan Programs for each data exchange partner.	Not Recommended	minOcc 0 maxOcc 1 minLength 3 maxLength 8
Comment: The NCHELPID would not normally be an appropriate choice.				
IPEDS	Optional choice	The unique identifier for Integrated Postsecondary Education Data System assigned by the National Center for Education Statistics for each postsecondary data exchange partner. Also called the Unit ID.	Recommended	minOcc 0 maxOcc 1 minLength 6 maxLength 6
Comment: The IPEDS would be an appropriate choice.				
ATP	Optional choice	The unique identifier for the Admissions Testing Program assigned by the College Board for each data exchange partner.	Recommended	minOcc 0 maxOcc 1 minLength 6 maxLength 6
Comment: The ATP would be an appropriate choice.				
FICE	Optional choice	The unique identifier once maintained for the Federal Interagency Committee on Education by the National Center for Education Statistics for each postsecondary data exchange partner.	Recommended	minOcc 0 maxOcc 1 minLength 6 maxLength 6
Comment: The FICE would normally be an appropriate choice. However, the FICE number was originally maintained by the US Department of Education's National Center for Education Statistics (NCES), but has not been maintained by NCES since late in the last century. It may still be an appropriate choice for schools that have been in business for more than 20 years.				
ACT	Optional choice	The unique identifier for postsecondary educational institutions assigned by American College Testing available at www.act.org	Recommended	minOcc 0 maxOcc 1 minLength 4 maxLength 4
Comment: The ACT would be an appropriate choice.				
CCD	Optional choice	The unique identifier assigned by National Center for Education Statistics as the Common Core of Data for each data exchange partner.	Not Recommended	minOcc 0 maxOcc 1 minLength 12 maxLength 12
Comment: The CCD would not be an appropriate choice to describe the entity to which the applicant is applying for admission.				

PESC XML Application for Admission Implementation Guide

Version 1.3.0

Tag Name	Schema Use	Description	Recommended Use	Format
PSS	Optional choice	The unique identifier assigned by National Center for Education Statistics for private secondary schools in the US.	Not Recommended	minOcc 0 maxOcc 1 minLength 8 maxLength 8
Comment: The PSS would not be an appropriate choice to describe the entity to which the applicant is applying for admission.				
CEEBACT	Optional choice	The unique identifier assigned by the College Entrance Examining Board and ACT for each K-12 data exchange partner.	Not Recommended	minOcc 0 maxOcc 1 minLength 6 maxLength 6
Comment: The CEEBACT would not normally be an appropriate choice.				
CSIS	Optional choice	The unique identifier assigned by the Statistics Canada Canadian College Student Information System for each postsecondary data exchange partner.	Not Recommended	minOcc 0 maxOcc 1 minLength 6 maxLength 6
Comment: Since this code set is used to identify postsecondary schools in Canada, it is not a recommended choice for US schools. However, it would be a valid choice for schools in Canada, except that this code set is being phased out in Canada and is being replaced with the PSIS code set.				
USIS	Optional choice	The unique identifier assigned by the Statistics Canada University Student Information System for each data postsecondary exchange partner.	Not Recommended	minOcc 0 maxOcc 1 minLength 6 maxLength 6
Comment: Since this code set is used to identify postsecondary schools in Canada, it is not a recommended choice for schools in the US. However, it would be a valid choice for schools in Canada, except that this code set is being phased out in Canada and is being replaced with the PSIS code set.				
ESIS	Optional choice	The unique identifier assigned by the Statistics Canada Enhanced Student Information System for each data postsecondary exchange partner.	Optional	minOcc 0 maxOcc 1 minLength 8 maxLength 8
Comment: Since this code set is used to identify postsecondary schools in Canada, it is not a recommended choice for schools in the US. However, it would be a valid choice for schools in Canada, although the newer PSIS code set is preferred..				
PSIS	Optional choice	The unique identifier assigned by the Statistics Canada Postsecondary Student Information System for each data postsecondary exchange partner.	Optional	minOcc 0 maxOcc 1 minLength 8 maxLength 8
Comment: Since this code set is used to identify postsecondary schools in Canada, it is not a recommended choice for schools in the US. However, it would be the preferred choice for postsecondary schools in Canada.				
DUNS	Optional choice	Data Universal Numbering System (DUNS), unique nine character company identification number issued by Dun and Bradstreet Corporation.	Not Recommended	minOcc 0 maxOcc 1 minLength 9 maxLength 9
Comment: The DUNS number would not normally be an appropriate choice.				
MutuallyDefined	Optional choice	The unique identifier assigned by trading organizations for institutions that have no defined ID	Optional	minOcc 0 maxOcc 1 minLength 1 maxLength 60
Comment: MutuallyDefined would not normally be an appropriate choice.				
APAS	Optional choice	Identification codes used by the Alberta Post-Secondary Application Systems.	Optional	minOcc 0 maxOcc 1 minLength 2 maxLength 12
Comment: This is an appropriate choice for institutions in Canada.				

PESC XML Application for Admission Implementation Guide Version 1.3.0

Tag Name	Schema Use	Description	Recommended Use	Format
<i>Comment: End of OrganizationIDGroup choice set tags</i>				
LocalOrganizationID	Optional	A code set typically used by a state, province or region to further identify the sending vendor, agency or school.	Optional	minOcc 0 maxOcc 1
<i>Comment: Additional information about the complex data element Local Organization ID will be shown on page 290.</i>				
OrganizationName	Required Repeatable	Name of Non-person entity such as Organization, Institution, Agency or Business.	Required	minOcc 1 maxOcc ∞ minLength 1 maxLength 60
<i>Comment: This is the name of the school or department within the university where the applicant is applying.</i>				
Contacts	Optional Repeatable	To identify a person or an office at the entity at the school to which administrative communications should be directed	Not Recommended	minOcc 0 maxOcc ∞
NoteMessage	Optional Repeatable	Additional information about the organization	Not recommended	minOcc 0 maxOcc ∞ minLength 1 maxLength 80

Applicant.Application.ApplicationDetail.Organization (Continued)

Code illustration:

```

<Organization>
  <ACT>123456</ACT>
  <LocalOrganizationID>

  </LocalOrganizationID>
  <OrganizationName>University of Great Expectations</OrganizationName>
  <OrganizationName>School of Journalism</OrganizationName>
  <Contacts/>
  <NoteMessage/>
</Organization>

```

PESC XML Application for Admission Implementation Guide Version 1.3.0

Applicant.Application.ApplicationDetail.ApplicationOrganization. LocalOrganizationID

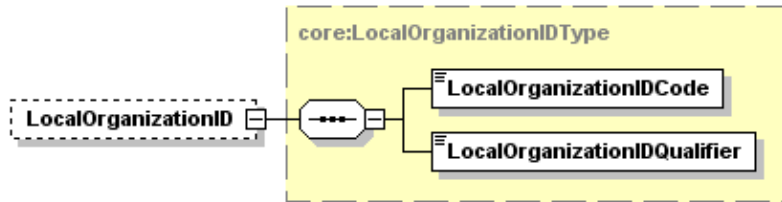

Tag Name	Schema Use	Description	Recommended Use	Format
LocalOrganizationIDCode	Required	The code assigned for the school by the state, province or other mutually defined agency specified in the LocalOrganizationIDQualifier that follows.	Required	minOcc 1 maxOcc 1 minLength 1 maxLength 35
Comment: This is a required data element only if the Local Organization ID complex data element is sent. This is typically the administrative school code assigned by a state or province to specifically identify the school in that state				
LocalOrganizationIDQualifier	Required	This is the state or province that assigned the LocalOrganizationID Code above.	Required	minOcc 1 maxOcc 1 Enumeration: See Code Set in Appendix A.
Comment: This is a required data element only if the Local Organization ID data element is sent. This is typically the state or province that assigned the code to specifically identify the school in that state.				

Code illustration:

```
<LocalOrganizationID>
  <LocalOrganizationIDCode>13001212</LocalOrganizationIDCode>
  <LocalOrganizationIDQualifier>FL</LocalOrganizationIDQualifier>
</LocalOrganizationID>
```

PESC XML Application for Admission Implementation Guide Version 1.3.0

Applicant.Application.RecommendationReference

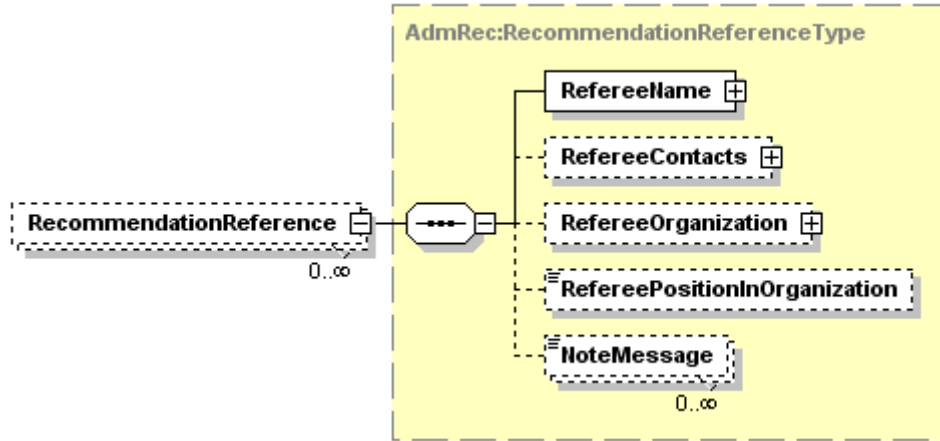

Tag Name	Schema Use	Description	Recommended Use	Format
RefereeName	Required	The name of the person who is expected to provide a recommendation for the applicant	Required	minOcc 1 maxOcc 1
Comment: The name of the person expected to provide a reference will be expanded on page 292.				
RefereeContacts	Optional	Contact information for the person who is expected to provide a recommendation for the applicant	Recommended	minOcc 0 maxOcc 1
Comment: The contact information for the person expected to provide a reference will be expanded on page 294.				
RefereeOrganization	Optional	The organization of the person who is expected to provide a recommendation	Optional	minOcc 0 maxOcc 1
Comment: The organization of the person expected to provide a reference will be expanded on page 303.				
RefereePositionInOrganization	Optional	The position in the organization of the person who is expected to provide a reference for the applicant	Optional	minOcc 0 maxOcc 1 minLength 1 maxLength 26
NoteMessage	Optional Repeatable	Additional information about the person who is expected to provide a recommendation for the applicant	Not recommended	minOcc 0 maxOcc ∞ minLength 1 maxLength 80

Code illustration:

```

<RecommendationReference>
  <RefereeName>

  </RefereeName>
  <RefereeContacts>

  </RefereeContacts>
  <RefereeOrganization>

  </RefereeOrganization>
  <RefereePositionInOrganization>Top Dog</RefereePositionInOrganization>
  <NoteMessage/>
</RecommendationReference>

```

PESC XML Application for Admission Implementation Guide Version 1.3.0

Applicant.Application.RecommendationReference.RefereeName

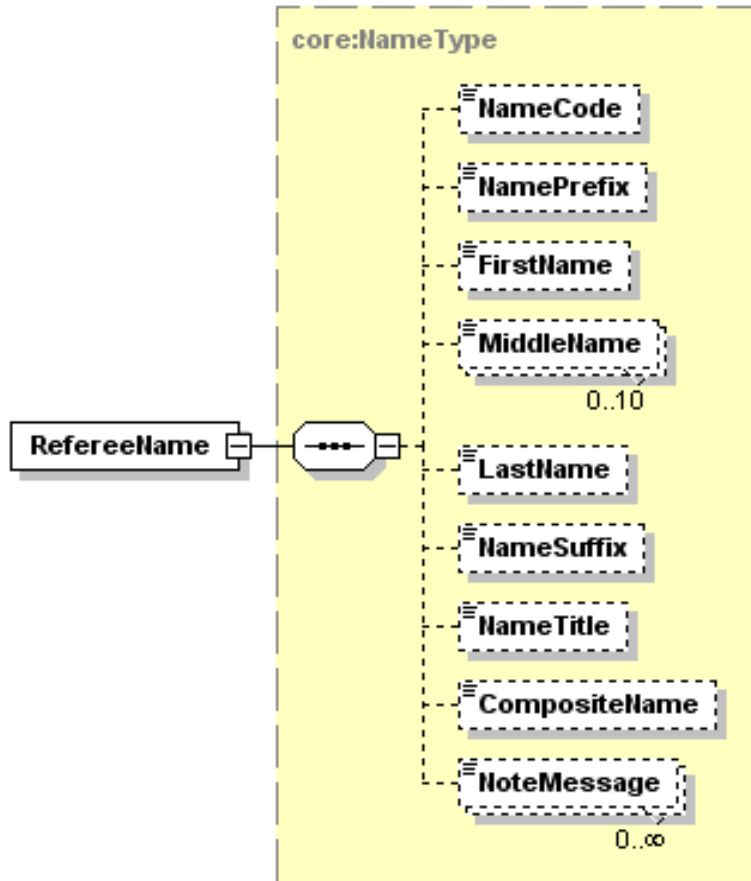

Tag Name	Schema Use	Description	Recommended Use	Format
NameCode	Optional	A code that indicates the type of name that is being described	Recommended	minOcc 0 maxOcc 1 Enumerations: Casual Formal Former LawSchoolApplication Source Legal MedicalSchoolApplicat ion Source Nickname Other
NamePrefix	Optional	An honorific, title or form of address that precedes the name.	Not Recommended	minOcc 0 maxOcc 1 minLength 1 maxLength 30
Comment: The honorific includes such data as "Dr.", "Professor", "Miss", etc. The Workgroup felt that it could do more harm than good to include this information and make it available to the school.				
FirstName	Optional	The first name of the person, usually given at birth, baptism, or during,	Recommended	minOcc 0 maxOcc 1 minLength 1 maxLength 35

PESC XML Application for Admission Implementation Guide

Version 1.3.0

Tag Name	Schema Use	Description	Recommended Use	Format
		another ceremony, or through legal change		
MiddleName	Optional Repeatable	A secondary name of the person, usually given at birth, baptism, or during another naming ceremony or through legal change	Recommended	minOcc 0 maxOcc 10 minLength 1 maxLength 35
LastName	Optional	The last name or surname by which a person is legally known	Recommended	minOcc 1 maxOcc 1 minLength 1 maxLength 35
NameSuffix	Optional	The expression of an individual's generation within a family.	Recommended	minOcc 0 maxOcc 1 Enumerations: I II III IV V VI VII VIII IX X JR SR
NameTitle	Optional	An honorific, title or credential that follows the name.	Not Recommended	minOcc 0 maxOcc 1 minLength 1 maxLength 30
CompositeName	Optional	The full name of the person in Last Name (space) Suffix (comma) First Name (space) Middle Names (spaces). A comma would be included after last name or NameSuffix	Not Recommended	minOcc 0 maxOcc 1 minLength 1 maxLength 45
Comment: The use of the composite format for name is discouraged. It is much easier for the receiving school to process the individual name parts into its data base than to process a composite name. This data element is scheduled to be deleted in a future release of the standard.				
NoteMessage	Optional Repeatable	Additional information about the applicant's name	Not Recommended	minOcc 0 maxOcc ∞ minLength 1 maxLength 80

Code illustration:

```

<RefereeName>
  <NameCode>Legal</NameCode/>
  <FirstName>John</FirstName>
  <MiddleName>Billy</MiddleName>
  <MiddleName>Bob</MiddleName>
  <LastName>Thornton</LastName>
  <NameSuffix>JR</NameSuffix>
  <NameTitle/>
  <CompositeName/>
  <NoteMessage/>
</RefereeName>

```

PESC XML Application for Admission Implementation Guide Version 1.3.0

Applicant.Application.RecommendationReference.RefereeContacts

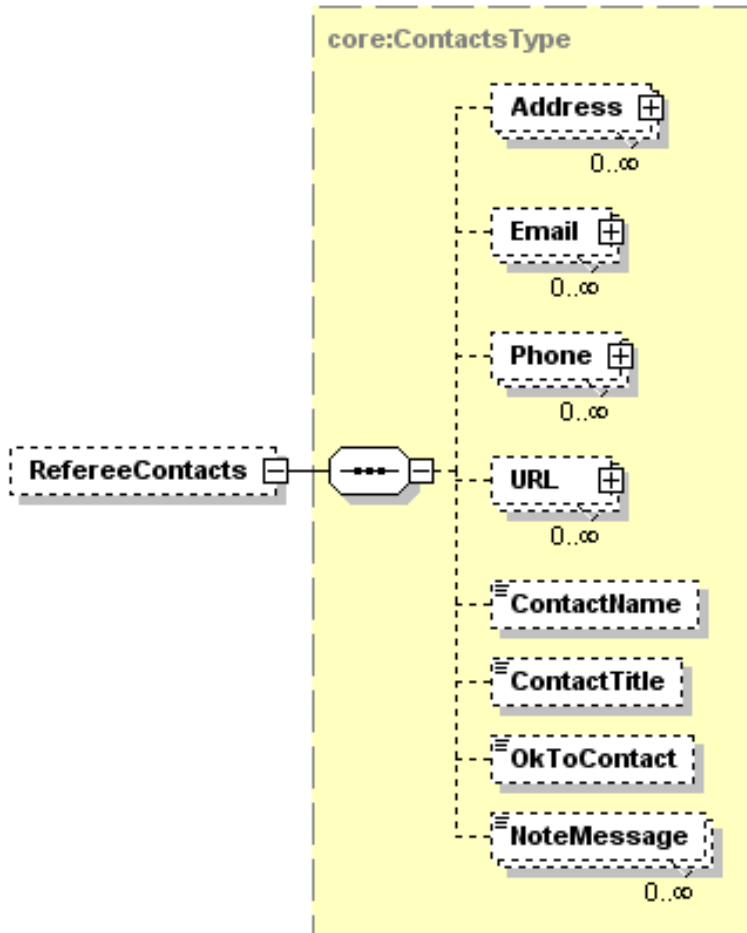

Tag Name	Schema Use	Description	Recommended Use	Format
Address	Required Repeatable	This is a combined Address Group for a choice between Domestic or International	Required	minOcc 0 maxOcc ∞
Comment: Additional information about the complex data element Address will be shown on page 296. This is the address of the source (company, agency or institution) of this application for admission.				
Email	Optional Repeatable	Email address of referee	Recommended	minOcc 0 maxOcc ∞
Comment: Additional information about the complex data element Email will be shown on page 299.				
Phone	Optional Repeatable	Phone number of referee	Recommended	minOcc 0 maxOcc ∞
Comment: Additional information about the complex data element Phone will be shown on page 300.				
URL	Optional Repeatable	The Uniform Resource Locator of referee	Optional	minOcc 0 maxOcc ∞
Comment: Additional information about the complex data element URL for the source of this application for admission will be shown on page 299.				

PESC XML Application for Admission Implementation Guide Version 1.3.0

Tag Name	Schema Use	Description	Recommended Use	Format
ContactName	Optional	This is the name of the contact at the referee organization.	Optional	minOcc 0 maxOcc 1 minLength 0 maxLength 60
ContactTitle	Optional Repeatable	The position title of the contact	Optional	minOcc 0 maxOcc 1 minLength 0 maxLength 60
OkToContact	Optional	An indication that the person has given permission to be contacted for the reference	Optional	minOcc 0 maxOcc 1 Enumerations: No Yes
NoteMessage	Optional Repeatable	Additional information about the contacts at the company, agency or vendor	Not recommended	minOcc 0 maxOcc ∞ minLength 1 maxLength 80

Comment: This is contact information included for the referee to indicate the preferred means for the receiving school to contact it in case there is a need for further communication.

Code illustration:

```

<RefereeContacts>
  <Address>

  </Address>
  <Email>

  </Email>
  <Phone>

  </Phone>
  <URL>

  </URL>
  <ContactName>Tim Nasr</ContactName>
  <ContactTitle>Product Manager</ContactTitle>
  <OkToContact>Yes</OkToContact>
  <NoteMessage/>
</RefereeContacts>

```

PESC XML Application for Admission Implementation Guide Version 1.3.0

Applicant.Application.RecommendationReference.RefereeContacts. Address

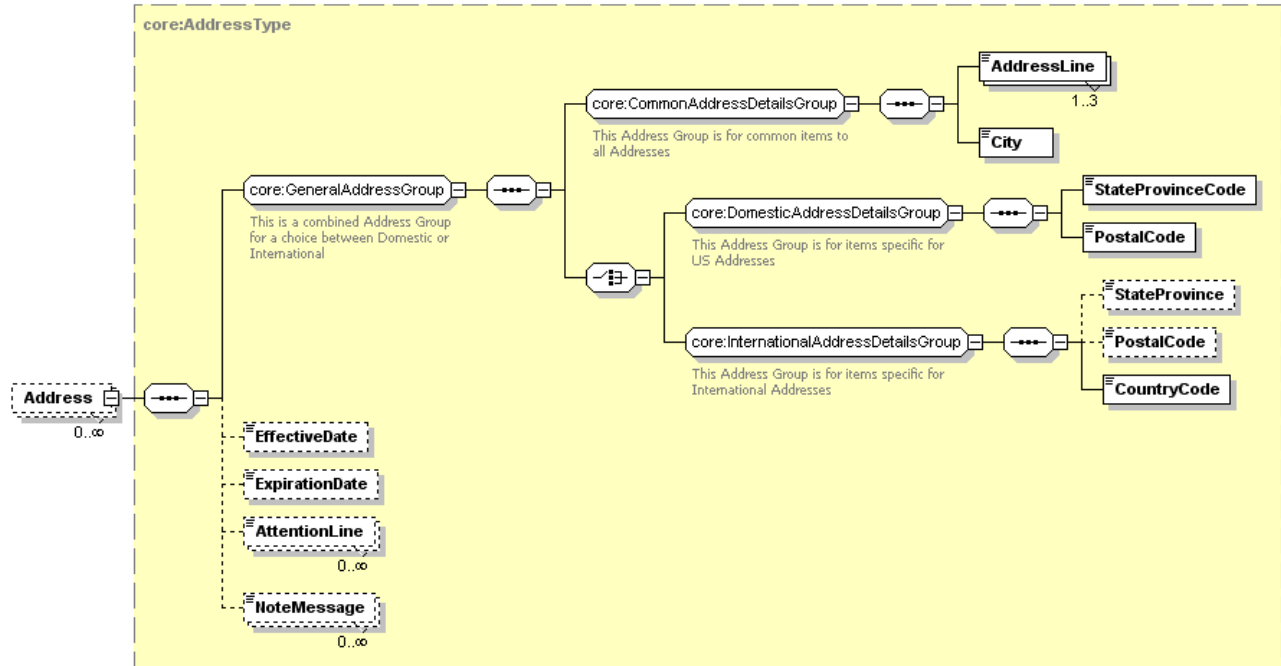

Tag Name	Schema Use	Description	Recommended Use	Format
<i>GeneralAddressGroup</i>	Required	This Address Group is for items common to all Addresses	Required	minOcc 1 maxOcc 1
Comment: [<i>GeneralAddressGroup</i>] does not appear in the instance document. It requires the use of <i>CommonAddressDetailsGroup</i> and the choice of one of either <i>DomesticAddressDetailsGroup</i> or <i>InternationalAddressDetailsGroup</i> . This group is required in the schema only if you choose to send the address of the contact at the sending (source) company, agency or school.				
<i>CommonAddressDetailsGroup</i>	Required	This Address Group is for items common to all Addresses	Required	minOcc 1 maxOcc 1
Comment: [<i>CommonAddressDetailsGroup</i>] does not appear in the instance document. If the address of a contact is included in the Application for Admission, then this must be sent. It is required and must be paired with one of either <i>DomesticAddressDetailsGroup</i> or <i>InternationalAddressDetailsGroup</i> .				
<i>AddressLine</i>	Required Repeatable	Local delivery information such as street, building number, PO box, or apartment portion of a postal address of a Contact of the referee	Required	minOcc 1 maxOcc 3 minLength 1 maxLength 40
<i>City</i>	Required	The city portion of the Address of the referee	Required	minOcc 1 maxOcc 1 minLength 2 maxLength 30
<i>DomesticAddressDetailsGroup</i>	Required choice	This Address Group is for items specific for US and Canadian Addresses	Required for domestic addresses	minOcc 1 maxOcc 1
Comment: [<i>DomesticAddressDetailsGroup</i>] does not appear in the instance document. If the complex data element address has a United States or Canadian Postal Code and a US State or Canadian Province Code, then this should be the required choice.				

PESC XML Application for Admission Implementation Guide

Version 1.3.0

Tag Name	Schema Use	Description	Recommended Use	Format
StateProvinceCode	Required	Code for US states, etc., and Canadian provinces.	Required	minOcc 1 maxOcc 1 Enumeration: See Appendix A
PostalCode	Required	The postal code portion of the Address.	Required	minOcc 1 maxOcc 1 minLength 1 maxLength 17
<i>InternationalAddressDetailsGroup</i>	Required choice	This Address Group is for items specific for International Addresses	Required for international addresses	minOcc 1 maxOcc 1
Comment: [InternationalAddressDetailsGroup] does not appear in the instance document. This choice is for addresses that do not have a US or Canadian postal code.				
StateProvince	Optional	The literal name of the state, province or territory of a postal address of the source of this document. Use for addresses outside US or Canada.	Recommended Refer to common postal practices of the source country	minOcc 0 maxOcc 1 minLength 2 maxLength 30
Comment: For an internet resource of states or other geographical subdivisions in countries other than the US and Canada, you might choose to refer to the website of the Universal Postal Union at http://www.upu.int				
PostalCode	Optional	The postal code portion of the Address.	Recommended Refer to common postal practices of the source country	minOcc 0 maxOcc 1 minLength 1 maxLength 17
Comment: For an internet resource of states or other geographical subdivisions in countries other than the US and Canada, you might choose to refer to the website of the Universal Postal Union at http://www.upu.int				
CountryCode	Required	Code indicating Country. Use ISO 3166-1 alpha-2 standard.	Required	minOcc 1 maxOcc 1 Enumerations: See Appendix B1 or B2
EffectiveDate	Optional	The date on which the address became (or will become) effective	Optional	minOcc 0 maxOcc 1 Date format: CCYY-MM-DD
ExpirationDate	Optional	The date on which the address will (or did) expire	Optional	minOcc 0 maxOcc 1 Date format: CCYY-MM-DD
AttentionLine	Optional Repeatable	The individual or office name at the postal address where inquiries should be directed.	Optional	minOcc 0 maxOcc ∞ minLength 1 maxLength 45
NoteMessage	Optional Repeatable	Additional information about the addresses of the referee	Not recommended	minOcc 0 maxOcc ∞ minLength 1 maxLength 80

PESC XML Application for Admission Implementation Guide Version 1.3.0

Applicant.Application.RecommendationReference.RefereeContacts. Address (Continued)

Code illustration 1 (Domestic Address):

```
<Address>  
  <AddressLine>1715 W Cesar Chavez</AddressLine>  
  <City>Austin</City>  
  <StateProvinceCode>TX</StateProvinceCode>  
  <PostalCode>78703</PostalCode>  
  <EffectiveDate/>  
  <ExpirationDate/>  
  <AttentionLine/>  
  <NoteMessage/>  
</Address>
```

Code illustration 2 (International Address):

```
<Address>  
  <AddressLine>Altova Corporation</AddressLine>  
  <AddressLine>Rudolfplatz 13a/9</AddressLine>  
  <City>Wien</City>  
  <StateProvince/>  
  <PostalCode>A-1010</PostalCode>  
  <CountryCode>AT</CountryCode>  
  <EffectiveDate/>  
  <ExpirationDate/>  
  <AttentionLine/>  
  <NoteMessage/>  
</Address>
```

PESC XML Application for Admission Implementation Guide Version 1.3.0

Applicant.Application.RecommendationReference.RefereeContacts. Email

Note: Although the complex data element *Email* is an optional data element, if you choose to send the *Email Address* for the referee, then you must send the data element *EmailAddress*.

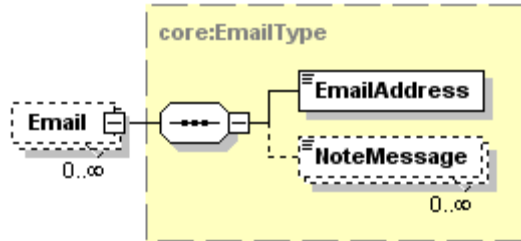

Tag Name	Schema Use	Description	Recommended Use	Format
EmailAddress	Required	The numbers, letters, and symbols used to identify an electronic mail (Email) user within a network.	Required	minOcc 1 maxOc 1 minLength 1 maxLength 128
NoteMessage	Optional Repeatable	Additional information about the email addresses of the referee	Not recommended	minOcc 0 maxOcc ∞ minLength 1 maxLength 80

Code illustration:

```

<Email>
  <EmailAddress>afarella@collegeboard.org</EmailAddress>
  <NoteMessage/>
</Email>
  
```

PESC XML Application for Admission Implementation Guide Version 1.3.0

Applicant.Application.RecommendationReference.RefereeContacts. Phone

Note: Although the complex data element Phone is an optional data element, if you choose to send the Phone of the referee, then you must send a phone number.

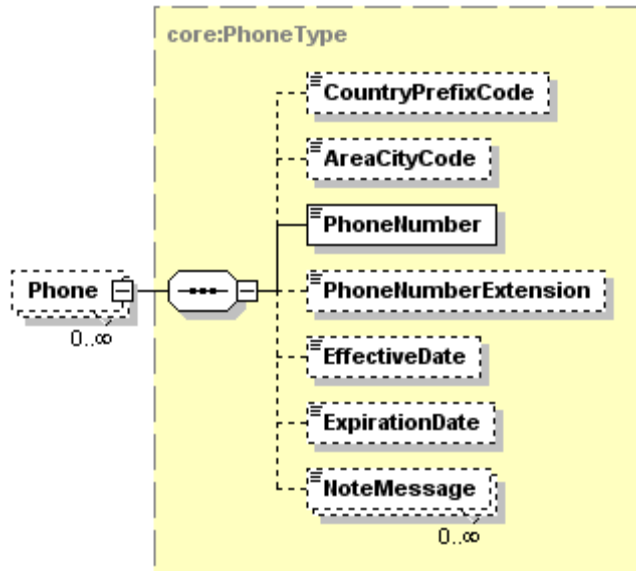

Tag Name	Schema Use	Description	Recommended Use	Format
CountryPrefixCode	Optional	International dialing code	Recommended	minOcc 0 maxOcc 1 minLength 1 maxLength 3
AreaCityCode	Optional	Regional dialing code	Recommended	minOcc 0 maxOcc 1 minLength 1 maxLength 5
PhoneNumber	Required	Telephone number	Required	minOcc 1 maxOcc 1 minLength 1 maxLength 11
Comment: The phone number will typically be sent as a string of numbers with no spaces, periods nor dashes.				
PhoneNumberExtension	Optional	The extended telephone addressing information used in addition to phone number such as a PBX extension, a pager PIN, or FAX sub-address.	Optional	minOcc 0 maxOcc 1 minLength 1 maxLength 5
EffectiveDate	Optional	The date on which the permanent phone became (or will become) effective	Recommended	minOcc 0 maxOcc 1 Date format: CCYY-MM-DD
ExpirationDate	Optional	The date on which the permanent phone will (or did) expire	Recommended	minOcc 0 maxOcc 1 Date format: CCYY-MM-DD
NoteMessage	Optional Repeatable	Additional information about the other addresses of the applicant	Optional	minOcc 0 maxOcc ∞ minLength 1 maxLength 80

PESC XML Application for Admission Implementation Guide Version 1.3.0

Applicant.Application.RecommendationReference.RefereeContacts. Phone (Continued)

Code illustration:

```
<Phone>  
  <CountryPrefixCode/>  
  <AreaCityCode>512</AreaCityCode>  
  <PhoneNumber>4142505</PhoneNumber>  
  <PhoneNumberExtension/>  
  <EffectiveDate/>  
  <ExpirationDate/>  
  <NoteMessage/>  
</Phone>
```

PESC XML Application for Admission Implementation Guide Version 1.3.0

Applicant.Application.RecommendationReference.RefereeContacts.URL

Note: Although the complex data element URL is an optional data element, if you choose to send the URL of referee, then you must send the URLAddress.

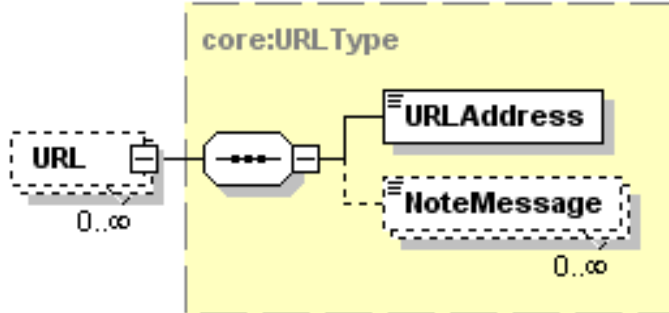

Tag Name	Schema Use	Description	Recommended Use	Format
URLAddress	Required	The Uniform Resource Locator (URL) address of the referee	Required	minOcc 1 maxOcc 1 minLength 1 maxLength 512
NoteMessage	Optional Repeatable	Additional information about the URL address of the referee	Not recommended	minOcc 0 maxOcc ∞ minLength 1 maxLength 80

Code illustration:

```
<URL>
  <URLAddress>www.Xap.com</URLAddress>
  <NoteMessage/>
</URL>
```

PESC XML Application for Admission Implementation Guide Version 1.3.0

Applicant.Application.RecommendationReference.RefereeOrganization

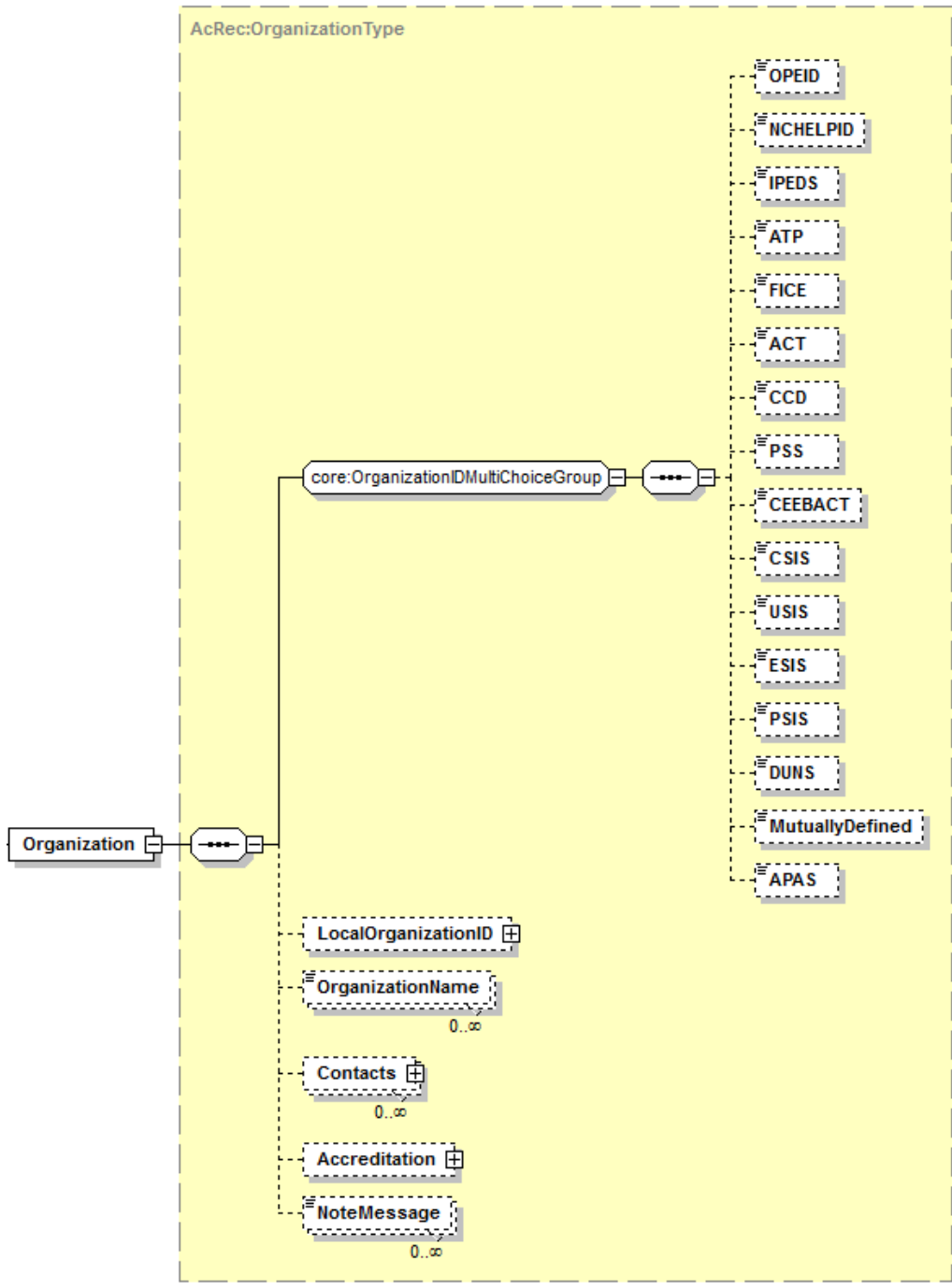

PESC XML Application for Admission Implementation Guide Version 1.3.0

Applicant.Application.RecommendationReference.RefereeOrganization (Continued)

Tag Name	Schema Use	Description	Recommended Use	Format
[OrganizationIDGroup]	Optional	Allowable Organization IDs - Exclusive choice	Optional	minOcc 0 maxOcc 1
Comment: [OrganizationIDGroup] is not an XML tag and does not appear in an instance document. It allows the choice of one and only one of the following code set tags to identify the organization for this Recommendation Reference.				
OPEID	Optional choice	The unique identifier assigned by the Office of Postsecondary Education for each data exchange partner. Includes all postsecondary schools that are eligible to participate in US Title IV federal financial aid programs.	Optional	minOcc 0 maxOcc 1 minLength 3 maxLength 8
Comment: The OPEID would be an appropriate choice if the Recommendation Reference works for a postsecondary institution				
NCHELPID	Optional choice	The unique identifier assigned by National Council on Higher Education Loan Programs for each data exchange partner.	Optional	minOcc 0 maxOcc 1 minLength 3 maxLength 8
Comment: The NCHELPID would be an appropriate choice if the Recommendation Reference works for a postsecondary institution				
IPEDS	Optional choice	The unique identifier for Integrated Postsecondary Education Data System assigned by the National Center for Education Statistics for each postsecondary data exchange partner. Also called the Unit ID.	Optional	minOcc 0 maxOcc 1 minLength 6 maxLength 6
Comment: The IPEDS would be an appropriate choice if the Recommendation Reference works for a postsecondary institution				
ATP	Optional choice	The unique identifier for the Admissions Testing Program assigned by the College Board for each data exchange partner.	Optional	minOcc 0 maxOcc 1 minLength 6 maxLength 6
Comment: The ATP would be an appropriate choice if the Recommendation Reference works for a postsecondary institution				
FICE	Optional choice	The unique identifier once maintained for the Federal Interagency Committee on Education by the National Center for Education Statistics for each postsecondary data exchange partner.	Optional	minOcc 0 maxOcc 1 minLength 6 maxLength 6
Comment: The FICE would be an appropriate choice if the Recommendation Reference works for a postsecondary institution				
ACT	Optional choice	The unique identifier for postsecondary educational institutions assigned by American College Testing available at www.act.org	Optional	minOcc 0 maxOcc 1 minLength 4 maxLength 4
Comment: The ACT would be an appropriate choice if the Recommendation Reference works for a postsecondary institution				
CCD	Optional choice	The unique identifier assigned by National Center for Education Statistics as the Common Core of Data for each data exchange partner.	Optional	minOcc 0 maxOcc 1 minLength 12 maxLength 12
Comment: The CCD would be an appropriate choice if the Recommendation Reference works for a school				
PSS	Optional choice	The unique identifier assigned by National Center for Education Statistics for private schools in the US	Optional	minOcc 0 maxOcc 1 minLength 8 maxLength 8

PESC XML Application for Admission Implementation Guide

Version 1.3.0

Tag Name	Schema Use	Description	Recommended Use	Format
Comment: The PSS would be an appropriate choice if the Recommendation Reference works for a private school in the US				
CEEBACT	Optional choice	The unique identifier assigned by the College Entrance Examining Board and ACT for each K-12 data exchange partner.	Optional	minOcc 0 maxOcc 1 minLength 6 maxLength 6
Comment: The CEEBACT would be an appropriate choice if the Recommendation Reference works for a school				
CSIS	Optional choice	The unique identifier assigned by the Statistics Canada Canadian College Student Information System for each postsecondary data exchange partner.	Not Recommended	minOcc 0 maxOcc 1 minLength 6 maxLength 6
Comment: Since this code set is used to identify postsecondary schools in Canada, it is not a recommended choice for US schools. However, it would be a valid choice for schools in Canada, except that this code set is being replaced with the PSIS code set.				
USIS	Optional choice	The unique identifier assigned by the Statistics Canada University Student Information System for each data postsecondary exchange partner.	Not Recommended	minOcc 0 maxOcc 1 minLength 6 maxLength 6
Comment: Since this code set is used to identify postsecondary schools in Canada, it is not a recommended choice for schools in the US. However, it would be a valid choice for schools in Canada, except that it is being replaced by the newer PSIS code set.				
ESIS	Optional choice	The unique identifier assigned by the Statistics Canada Enhanced Student Information System for each data postsecondary exchange partner.	Optional	minOcc 0 maxOcc 1 minLength 8 maxLength 8
Comment: Since this code set is used to identify postsecondary schools in Canada, it is not a recommended choice for schools in the US. However, it would be a valid choice for schools in Canada, except that it is being replaced by the newer PSIS code set in Canada.				
PSIS	Optional choice	The unique identifier assigned by the Statistics Canada Postsecondary Student Information System for each data postsecondary exchange partner.	Optional	minOcc 0 maxOcc 1 minLength 8 maxLength 8
Comment: Since this code set is used to identify postsecondary schools in Canada, it is not a recommended choice for schools in the US. However, it would be the preferred choice for referees who are employed by postsecondary schools in Canada.				
DUNS	Optional choice	Data Universal Numbering System (DUNS), unique nine character company identification number issued by Dun and Bradstreet Corporation.	Optional	minOcc 0 maxOcc 1 minLength 9 maxLength 9
Comment: The DUNS number would be an appropriate choice to identify a Recommendation Reference who works for a company or corporation.				
MutuallyDefined	Optional choice	Mutually defined by trading partners for organizations that have no codes defined in other organization code sets	Optional	minOcc 0 maxOcc 1 minLength 1 maxLength 60
Comment: MutuallyDefined would be an appropriate choice to identify a Recommendation Reference who works for a company or corporation.				
APAS	Optional choice	Identification codes used by the Alberta Post-Secondary Application Systems.	Optional	minOcc 0 maxOcc 1 minLength 2 maxLength 12
Comment: This is an appropriate choice for institutions in Canada.				
Comment: End of OrganizationIDGroup choice set tags				
LocalOrganizationID	Optional	A code set typically used by a state, province or region to further identify the agency, company or school.	Not Recommended	minOcc 0 maxOcc 1

PESC XML Application for Admission Implementation Guide

Version 1.3.0

Tag Name	Schema Use	Description	Recommended Use	Format
OrganizationName	Required Repeatable	Name of Non-person entity such as Organization, Institution, Agency or Business.	Required	minOcc 1 maxOcc ∞ minLength 1 maxLength 60
Comment: This is the name of the company, vendor, school or agency that is sponsoring the international applicant				
Contacts	Optional Repeatable	To identify a person or an office at the vendor, company, association, agency or school to which administrative communications should be directed	Not Recommended	minOcc 0 maxOcc ∞
Comment: The information about contacting the Recommendation Reference has already been provided for earlier, so it is not recommended to include it here.				
NoteMessage	Optional Repeatable	Additional information about the Recommended Reference	Not recommended	minOcc 0 maxOcc ∞ minLength 1 maxLength 80

Code illustration:

```

<RefereeOrganization>
  <DUNS>123456789</DUNS>
  <LocalOrganizationID/>
  <OrganizationName>Xap Corporation</OrganizationName>
  <Contacts/>
  <NoteMessage/>
</RefereeOrganization>

```

PESC XML Application for Admission Implementation Guide Version 1.3.0

Applicant.Application.ApplicationQuestion

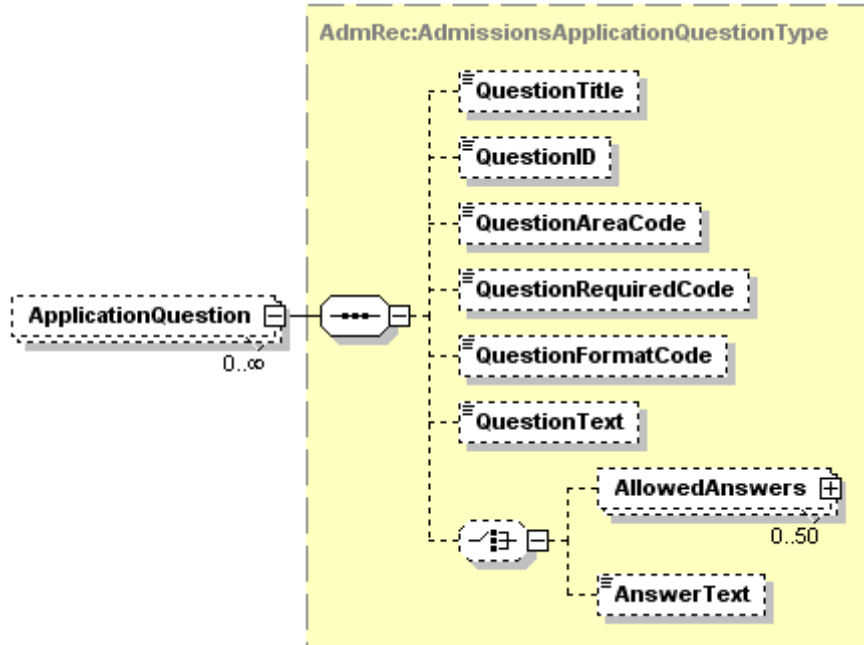

Tag Name	Schema Use	Description	Recommended Use	Format
QuestionTitle	Optional	A short title of the specific question asked of the applicant	Recommended	minOcc 0 maxOcc 1 minLength 1 maxLength 30
QuestionID	Optional	An identifier that distinguishes this question from all other questions that might be asked	Recommended	minOcc 0 maxOcc 1 minLength 0 maxLength 15
Comment: This ID could be just a unique number, or it could include portions that identify the type of question, the area at the school that is asking the question, etc.				
QuestionAreaCode	Optional	This would identify the subject area of the question	Optional	minOcc 0 maxOcc 1 Enumerations: AcademicRecord Admissions Biographical Education Employment Essay ExtraCurricularActivities Family FinancialAid General Health HonorsAwards Housing Immigration Other Personal References Residency Scholarship Tests

PESC XML Application for Admission Implementation Guide

Version 1.3.0

Tag Name	Schema Use	Description	Recommended Use	Format
QuestionRequiredCode	Optional	This would indicate whether or not this was a question that the applicant was required to answer	Recommended	minOcc 0 maxOcc 1 Enumerations: Optional Required
Comment: Since the applications for admission at any given school are modified on a fairly regular basis, this would allow an historical record of whether or not this question was required at the time the applicant was presented with the question.				
QuestionFormatCode	Optional	This would indicate the format of the question asked	Optional	minOcc 0 maxOcc 1 Enumerations: CheckBox DropDownMenu NoInput OneLineText RadioButton TextArea
Comment: The types of questions would be: Check Box: The applicant was provided with a list of answers and the applicant could check as many as were applicable. DropDownMenu: The applicant was provided with a drop down menu from which to select the appropriate responses. No Input: Information was provided to the applicant, but no response was allowed. This would be a record that the student was provided with the information. One Line Text: A question was asked and the student was allowed to enter a single line of text as a response. Radio Button: A question was asked and the student was required to choose one, and only one, of the responses provided. Text Area: A question was asked and the student was provided a large block of space to provide a response.				
QuestionText	Optional	This would indicate the actual text of the question that the applicant was asked	Recommended	minOcc 0 maxOcc 1 minLength 1 maxLength ∞
Comment: No maxLength is specified by the schema for QuestionText. However, the universities receiving the applications and the sending agency or vendor might well agree to set a limit on the length for exchanges between those two entities.				
AllowedAnswers	Optional Choice Repeatable	This would specify the allowed responses from which the applicant must choose	Recommended	minOcc 0 maxOcc 50
Comment: This complex data element will be expanded on page 309 which follows.				
AnswerText	Optional Choice	This would indicate the actual text of the question that the applicant was asked	Recommended	minOcc 1 maxOcc 1 minLength 1 maxLength ∞
Comment: No maxLength is specified by the schema for QuestionText. However, the universities receiving the applications and the sending agency or vendor might well agree to set a limit on the length for exchanges between those two entities.				

Code illustration:

```

<ApplicationQuestion>
  <QuestionTitle>Southern Regional Education Board's Grad Student</QuestionTitle>
  <QuestionID>UGRes123456789</QuestionID>
  <QuestionAreaCode>Residency</QuestionAreaCode>
  <QuestionRequiredCode>Optional</QuestionRequiredCode>
  <QuestionFormatCode>CheckBox</QuestionFormatCode>
  <QuestionText>I am a Southern Regional Education Boards's Academic Common Market graduate student.
  (Required: Certification letter from State Coordinator). </QuestionText>
  <AllowedAnswers/>
</ApplicationQuestion>

```

PESC XML Application for Admission Implementation Guide Version 1.3.0

Applicant.Application.ApplicationQuestion.AllowedAnswers

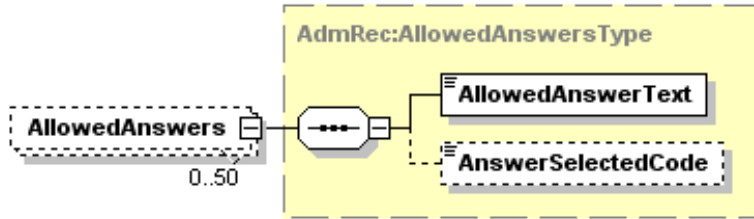

Tag Name	Schema Use	Description	Recommended Use	Format
AllowedAnswerText	Required	An answer that the applicant was provided and allowed to select	Required	minOcc 1 maxOcc 1 minLength 1 maxLength ∞
AnswerSelectedCode	Optional	An indication that the student did or did not select this answer	Recommended	minOcc 0 maxOcc 1 Enumerations: NotSelected Selected

Code illustration:

```

<AllowedAnswers>
  <AllowedAnswerText>I have not applied to any other postsecondary school in this state.
</AllowedAnswerText>
  <AnswerSelectedCode>Selected</AnswerSelectedCode>
</AllowedAnswers>

<AllowedAnswers>
  <AllowedAnswerText>I do not plan to apply to any other postsecondary school in the United States.
</AllowedAnswerText>
  <AnswerSelectedCode>NotSelected</AnswerSelectedCode>
</AllowedAnswers>
  
```

PESC XML Application for Admission Implementation Guide Version 1.3.0

Applicant.Application.AdditionalStudentAchievements

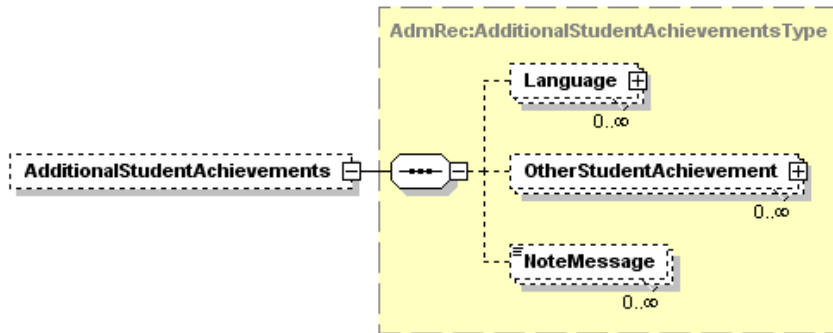

Tag Name	Schema Use	Description	Recommended Use	Format
Language	Optional Repeatable	Language skills reported by the applicant	Recommended	minOcc 0 maxOcc ∞
Comment: This complex data element will be expanded on page 311.				
OtherStudentAchievement	Optional Repeatable	The category of the area in which achievement was earned	Recommended	minOcc 0 maxOcc ∞
Comment: This complex data element will be expanded on page 313.				
NoteMessage	Optional	Additional information about the additional student achievements	Optional	minOcc 0 maxOcc ∞ minLength 1 maxLength 80

Code illustration:

```

<AdditionalStudentAchievements>
  <Language>

  </Language>
  <OtherStudentAchievement>

  </OtherStudentAchievement>
  <NoteMessage/>
</AdditionalStudentAchievements>
  
```

PESC XML Application for Admission Implementation Guide Version 1.3.0

Applicant.Application. AdditionalStudentAchievements.Language

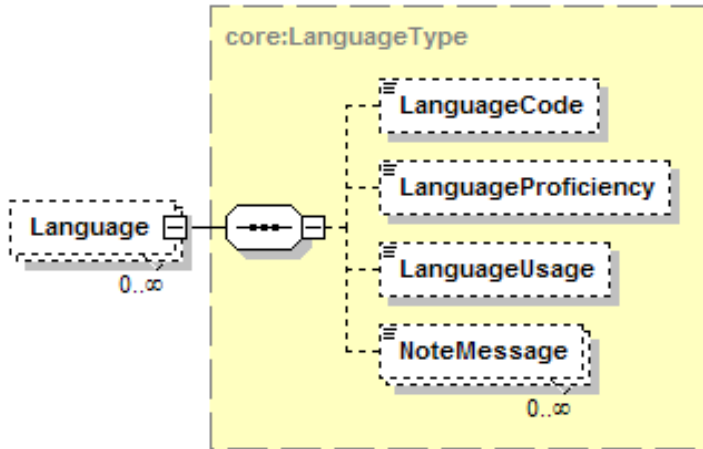

Tag Name	Schema Use	Description	Recommended Use	Format
LanguageCode	Optional	Information about the applicant's achievements in languages	Recommended	minOcc 0 maxOcc 1 minLength 3 maxLength 3 See Appendix C
LanguageProficiency	Optional	The proficiency level of the applicant in this language	Optional	minOcc 0 maxOcc 1 Enumerations: EnglishOnly Excellent Fair FullyEnglishProficient Good LimitedEnglishProficiency NonEnglishSpeaking Poor RedesignatedFluentEnglishProficient Unacceptable Unknown
LanguageUsage	Optional	The type of use of this language in which the student claims proficiency	Optional	minOcc 0 maxOcc 1 Enumerations: Native Reading Speaking SpokenAtHome Writing
NoteMessage	Optional Repeatable	Additional information about the proficiency of the applicant in this language	Not Recommended	minOcc 0 maxOcc ∞ minLength 1 maxLength 80

PESC XML Application for Admission Implementation Guide Version 1.3.0

Applicant.Application. AdditionalStudentAchievements.Language (Continued)

Code illustration:

```
<Language>  
  <LanguageCode>FRE</LanguageCode>  
  </LanguageProficiency>Excellent</LanguageProficiency>  
  <LanguageUsage>Native</LanguageUsage>  
  <NoteMessage/>  
</Language>
```

PESC XML Application for Admission Implementation Guide Version 1.3.0

Applicant.Application.AdditionalStudentAchievements. OtherStudentAchievement

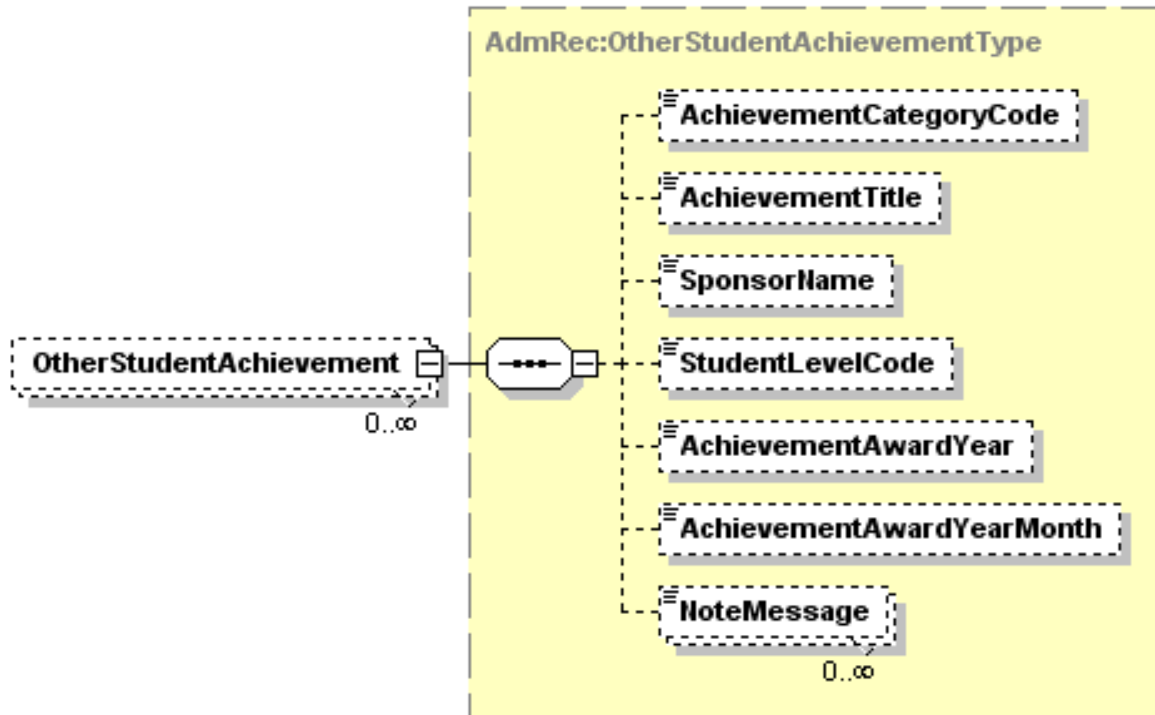

Tag Name	Schema Use	Description	Recommended Use	Format
AchievementCategoryCode	Optional	The category of the area in which achievement was earned	Recommended	minOcc 0 maxOcc 1 Enumerations: Academic Arts Athletic BusinessEmployment CommunityService Leadership Other
Comment: If the other category is used, it is suggested to use an occurrence of NoteMessage to explain.				
AchievementTitle	Optional	The name of the achievement or award	Optional	minOcc 0 maxOcc 1 minLength 0 maxLength 60
SponsorName	Optional	The sponsoring organization that made the award	Optional	minOcc 0 maxOcc 1 minLength 0 maxLength 60

PESC XML Application for Admission Implementation Guide

Version 1.3.0

Tag Name	Schema Use	Description	Recommended Use	Format
StudentLevelCode	Optional	The grade level of the applicant when the award was received	Optional	minOcc 0 maxOcc 1 Enumerations: Infant PreKindergarten FirstGrade SecondGrade ThirdGrade FourthGrade FifthGrade SixthGrade SeventhGrade EighthGrade NinthGrade TenthGrade EleventhGrade TwelfthGrade Postsecondary PostsecondaryBachelorPreliminaryYear NonDegree CollegeFirstYear CollegeFirstYearAttendedBefore CollegeSophomore CollegeJunior CollegeSenior CollegeFifthYear PostBaccalaureate GraduateNonDegree GraduateFirstYear GraduateSecondYear GraduateThirdYear GraduateBeyondThirdYear Professional ProfessionalFirstYear ProfessionalSecondYear ProfessionalThirdYear ProfessionalBeyondThirdYear MastersQualifying Masters Doctoral Postdoctoral
AchievementAwardYear	Optional	The year in which the award was earned	Optional	minOcc 0 maxOcc 1 Format is CCYY
AchievementAwardYearMonth	Optional	The month and year in which the award was earned	Optional	minOcc 0 maxOcc 1 Format is CCYY-MM
Comment: Use either AchievementAwardYear or AchievementAwardYearMonth, but not both.				
NoteMessage	Optional	Additional information about the additional student achievements	Optional	minOcc 0 maxOcc ∞ minLength 1 maxLength 80

PESC XML Application for Admission Implementation Guide Version 1.3.0

Applicant.Application.AdditionalStudentAchievements. OtherStudentAchievement (Continued)

Code illustration:

```
<OtherStudentAchievement>  
  <AchievementCategoryCode>Athletic</AchievementCategoryCode>  
  <AchievementTitle>Letter in Football</AchievementTitle>  
  <SponsorName>State Athletic League</SponsorName>  
  <StudentLevelCode>TwelfthGrade</StudentLevelCode>  
  <AchievementAwardYear>2006</AchievementAwardYear>  
  <AchievementAwardYearMonth/>  
  <NoteMessage/>  
</OtherStudentAchievement>
```

PESC XML Application for Admission Implementation Guide Version 1.3.0

Applicant.Application.PlanToApplyFor

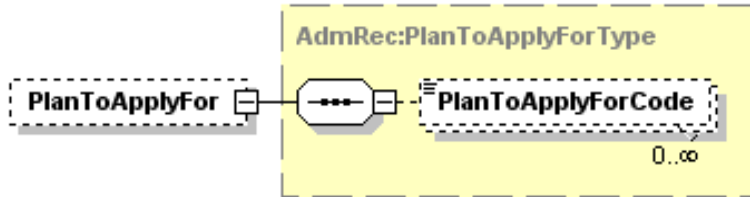

Tag Name	Schema Use	Description	Recommended Use	Format
PlanToApplyForCode	Optional Repeatable	Specific programs or aid for which the applicant is applying	Optional	minOcc 0 maxOcc ∞ Enumerations: CampusEmployment CoOp Fellowship FinancialAid HonorsProgram Housing Internship NationalStudentExchange ResearchAssistantship Scholarship StudyAbroad TeachingAssistantship

Code illustration:

```

<PlanToApplyFor>
  <PlanToApplyForCode>Housing</PlanToApplyForCode>
  <PlanToApplyForCode>Internship</PlanToApplyForCode>
</PlanToApplyFor>
    
```

PESC XML Application for Admission Implementation Guide Version 1.3.0

Applicant.Application.DecisionToApply

Note: DecisionToApply is an optional complex data element. However, if you include it, then you must include at least one occurrence of ApplyDecision.

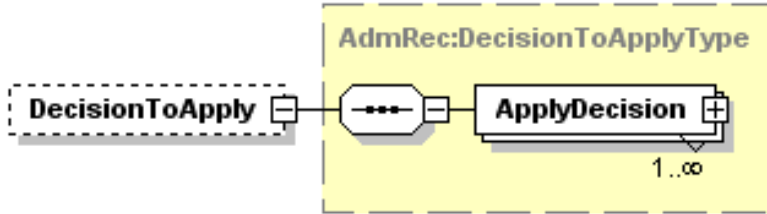

Tag Name	Schema Use	Description	Recommended Use	Format
ApplyDecision	Required Repeatable	Factors affecting the applicant's decision to apply to this school	Required	minOcc 1 maxOcc ∞
Comment: If you include the optional complex data element "DecisionToApply", then you must include the complex data element "ApplyDecision".				
Comment: This complex data element will be expanded on page 318 which follows.				

Code illustration:

```
<DecisionToApply>
  <ApplyDecision>

  </ApplyDecision>
</DecisionToApply>
```

PESC XML Application for Admission Implementation Guide Version 1.3.0

Applicant.Application.DecisionToApply.ApplyDecision

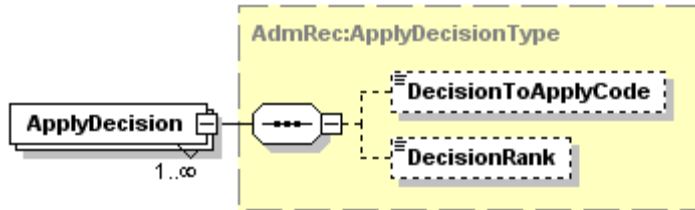

Tag Name	Schema Use	Description	Recommended Use	Format
DecisionToApplyCode	Optional	Factors affecting the applicant's decision to apply to this school	Recommended	minOcc 0 maxOcc 1 Enumerations: Alumni CampusEvent CampusVisit ClassmateCollege ClassmateHighSchool CollegeFair CollegeProfessor CoWorker Friend GuidanceCounselor HumanResourceDepartment IndependentCounselor InformationEvent InstitutionCorrespondence InstitutionReputation Internet Location MastersBusinessAdministrationForum Media MediaRanking OffCampusEvent Other PlacementDepartment Recruiter Relative Supervisor Tuition VisitToHighSchool WebSite
DecisionRank	Optional	The ranking of importance that this factor had in applying to this school	Optional	minOcc 0 maxOcc 1 The format would be an integer
Comment: Each factor that is included would also be able to be ranked in the order of importance. The factor that was most important would include the DecisionRank of "1".				

Code illustration:

```

<ApplyDecision>
  <DecisionToApplyCode>InstitutionReputation</DecisionToApplyCode>
  <DecisionRank>1</DecisionRank>
</ApplyDecision>
<ApplyDecision>
  <DecisionToApplyCode>Recruiter</DecisionToApplyCode>
  <DecisionRank>2</DecisionRank>
</ApplyDecision>
  
```

PESC XML Application for Admission Implementation Guide Version 1.3.0

Applicant.Application.HousingInformation

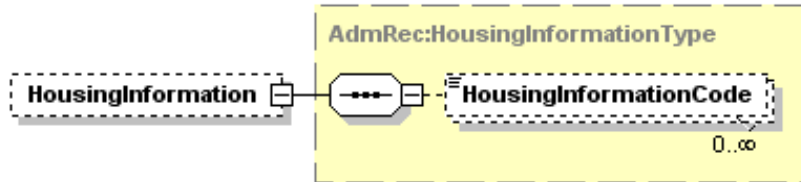

Tag Name	Schema Use	Description	Recommended Use	Format
HousingInformationCode	Optional	Additional info being requested about student housing	Optional	minOcc 0 maxOcc ∞ Enumerations: Family General OffCampus OnCampus

Code illustration:

```

<HousingInformation>
  <HousingInformationCode>Family</HousingInformationCode>
  <HousingInformationCode>OnCampus</HousingInformationCode>
</HousingInformation>
    
```

PESC XML Application for Admission Implementation Guide Version 1.3.0

Applicant.Application.InformationRequested

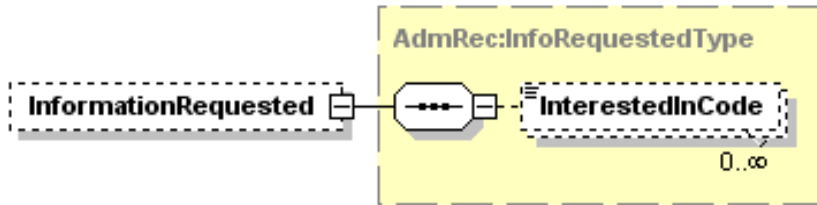

Tag Name	Schema Use	Description	Recommended Use	Format
InterestedInCode	Optional Repeatable	Other programs or activities in which the student is interested and about which the applicant would like additional information	Optional	minOcc 0 maxOcc ∞ Enumerations: Art AthleticsIntramural AthleticsVarsity Band CadetCorps HonorsProgram IndependentStudy ROTCAirForce ROTCArmy ROTCGeneral ROTCNavyMarine SororityFraternityClub

Code illustration:

```

<InformationRequested>
  <InterestedInCode>Band</InterestedInCode>
  <InterestedInCode>SororityFraternityClub</InterestedInCode>
</InformationRequested>
    
```

PESC XML Application for Admission Implementation Guide Version 1.3.0

Applicant.Application.ApplicationFee

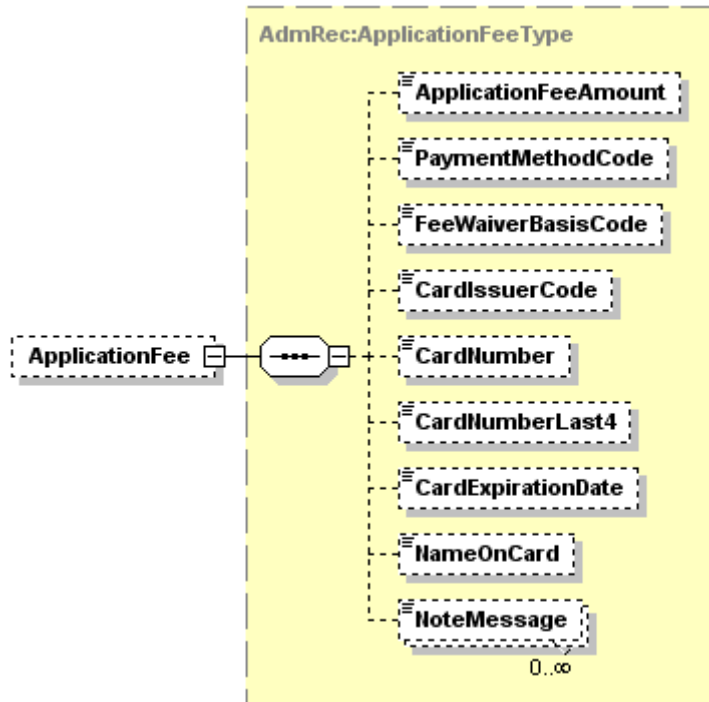

Tag Name	Schema Use	Description	Recommended Use	Format
ApplicationFeeAmount	Optional	Amount of the application fee being paid or waived for the applicant	Optional	minOcc 0 maxOcc 1 Format is xs:decimal
PaymentMethodCode	Optional	The method of payment or waiver being used to satisfy the assessment of the application fee	Optional	minOcc 0 maxOcc 1 Enumerations: BankWire Cash Check CreditCard DebitCard FeeWaiver GuaranteedFunds MoneyOrder Other OtherAgency
FeeWaiverBasisCode	Optional	The source of the waiver used to satisfy the application fee assessment	Optional	minOcc 0 maxOcc 1 Enumerations: AmeriCorps Employee EmployeeDependent GoverningBoard LowIncome Other PeaceCorps PreviouslyPaid School SeniorCitizen TestAgency

PESC XML Application for Admission Implementation Guide

Version 1.3.0

Tag Name	Schema Use	Description	Recommended Use	Format
CardIssuerCode	Optional	The bank or agency that issued the credit or debit card	Optional	minOcc 0 maxOcc 1 Enumerations: AmericanExpress Discover MasterCard Other Visa
Comment: If you choose the value of "Other", then specify the card issuer in the note message below.				
CardNumber	Optional	The number of the credit or debit card	Not Recommended	minOcc 0 maxOcc 1 minLength 0 maxLength 40
Comment: Inclusion of this data element in the schema was quite controversial. Including the card number on the electronic application for admission that the student completes is fairly common, but it would be extremely unusual for this number to be transmitted in an instance document along with other parts of the document. If included on the electronic application for admission by the applicant, then it would normally be sent in a different, separate document to the card processor, and not included in an instance document for the application for admission schema.				
CardNumberLast4	Optional	The last four digits of the credit or debit card number	Optional	minOcc 0 maxOcc 1 minLength 4 maxLength 4
CardExpirationDate	Optional	The month and year when the credit or debit card is scheduled to expire	Optional	minOcc 0 maxOcc 1 Format is CCYY-MM
NameOnCard	Optional	The name as shown on the credit or debit card	Optional	minOcc 0 maxOcc 1 minLength 0 maxLength 40
NoteMessage	Optional	Additional information about the fee for the application for admission	Not Recommended	minOcc 0 maxOcc ∞ minLength 1 maxLength 80
Comment: Many schools may not use any of this entire complex data element about the application fee. Some schools either do not charge an application fee, or do not collect the fee at the time the online application for admission is processed. Other schools do collect the fee on-line, but transmit information about the fee payment in a separate transmission, often using third party software for the fee collection. For those schools that do collect the fee on line as part of the application for admission, or at least information about an application fee waiver, and transmit some of the above data elements, it has been included in the schema. However, transmission of the debit or credit card number with the application for admission instance document is strongly "Not Recommended".				

Code illustration:

```

<ApplicationFee>
  <ApplicationFeeAmount>25</ApplicationFeeAmount>
  <PaymentMethodCode>CreditCard</PaymentMethodCode>
  <FeeWaiverBasisCode/>
  <CardIssuerCode>AmericanExpress</CardIssuerCode>
  <CardNumber/>
  <CardNumberLast4>9876</CardNumberLast4>
  <CardExpirationDate>2011-06</CardExpirationDate>
  <NameOnCard>Dad of Applicant</NameOnCard>
  <NoteMessage/>
</ApplicationFee>

```

PESC XML Application for Admission Implementation Guide Version 1.3.0

Applicant.Application.ActivityParticipationRequest

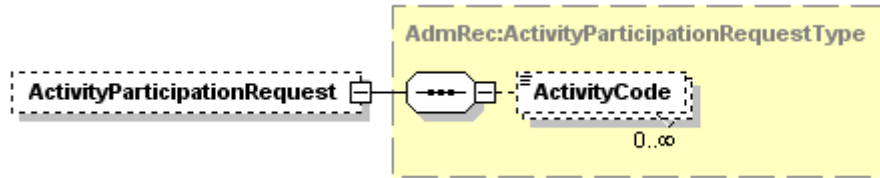

Tag Name	Schema Use	Description	Recommended Use	Format
ActivityCode	Optional Repeatable	Other programs or activities in which the student has expressed an interest in further participation	Optional	minOcc 0 maxOcc ∞ Enumerations: See the code list in Appendix M.

Code illustration:

```
<ActivityParticipationRequest>
  <ActivityCode>ClubFrench</ActivityCode>
  <ActivityCode>Broadcasting</ActivityCode>
</ActivityParticipationRequest>
```

PESC XML Application for Admission Implementation Guide Version 1.3.0

Applicant.Application.PreviousApplication

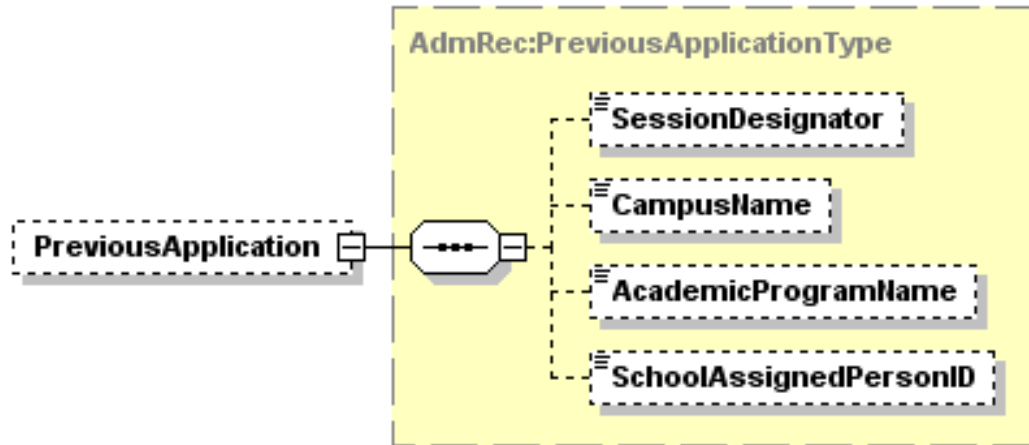

Tag Name	Schema Use	Description	Recommended Use	Format
SessionDesignator	Optional	The year and month in which the academic term or session begins or began for which the applicant previously applied	Optional	minOcc 0 maxOcc 1 Format is xs:gYearMonth As ccyy-mm
CampusName	Optional	The specific campus at the school for which the application was submitted	Optional	minOcc 0 maxOcc 1 minLength 0 maxLength 60
AcademicProgramName	Optional	The name of the program for which the applicant previously applied	Optional	minOcc 0 maxOcc 1 minLength 1 maxLength 60
SchoolAssignedPersonID	Optional	The ID number that was assigned to the applicant as a result of the previous application to the school	Optional	minOcc 0 maxOcc 1 minLength 1 maxLength 20

Code illustration:

```

<PreviousApplication>
  <SessionDesignator>2007-08</SessionDesignator>
  <CampusName>Main</CampusName>
  <AcademicProgramName>Business Administration</AcademicProgramName>
  <SchoolAssignedPersonID>12345676</SchoolAssignedPersonID>
</PreviousApplication>
  
```

PESC XML Application for Admission Implementation Guide Version 1.3.0

Applicant.Application.OtherCollegeApplication

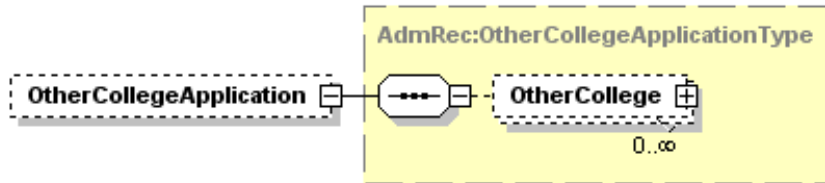

Tag Name	Schema Use	Description	Recommended Use	Format
OtherCollege	Optional Repeatable	Information about another college or university to which the applicant has applied or intends to apply	Optional	minOcc 0 maxOcc ∞
Comment: This complex data element will be expanded on page 326.				

Code illustration:

```

<OtherCollegeApplication>
  <OtherCollege>

  </OtherCollege>
</OtherCollegeApplication>

```

PESC XML Application for Admission Implementation Guide Version 1.3.0

Applicant.Application.OtherCollegeApplication.OtherCollege

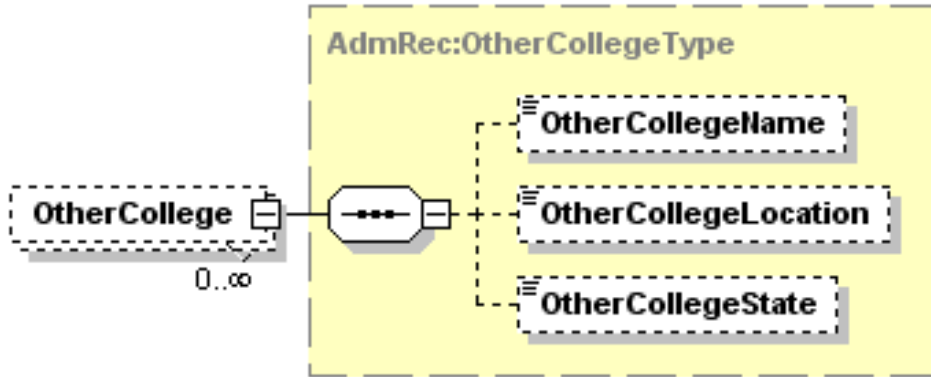

Tag Name	Schema Use	Description	Recommended Use	Format
OtherCollegeName	Optional	The name of the other college to which the applicant has applied, or intends to apply	Optional	minOcc 0 maxOcc 1 minLength 0 maxLength 60
OtherCollegeLocation	Optional	Information about the location of the college to which the applicant has applied, or intends to apply	Optional	minOcc 0 maxOcc 1 minLength 0 maxLength 60
OtherCollegeState	Optional	The state or province in which the other college to which the student has applied, or intends to apply, is located	Optional	minOcc 0 maxOcc 1 See Appendix A for list of state and province codes

Code illustration:

```

<OtherCollege>
  <OtherCollegeName>Miami Dade College</OtherCollegeName>
  <OtherCollegeLocation>Miami</OtherCollegeLocation>
  <OtherCollegeState>FL</OtherCollegeState>
</OtherCollege>

```

PESC XML Application for Admission Implementation Guide Version 1.3.0

Applicant.Application.Sponsor

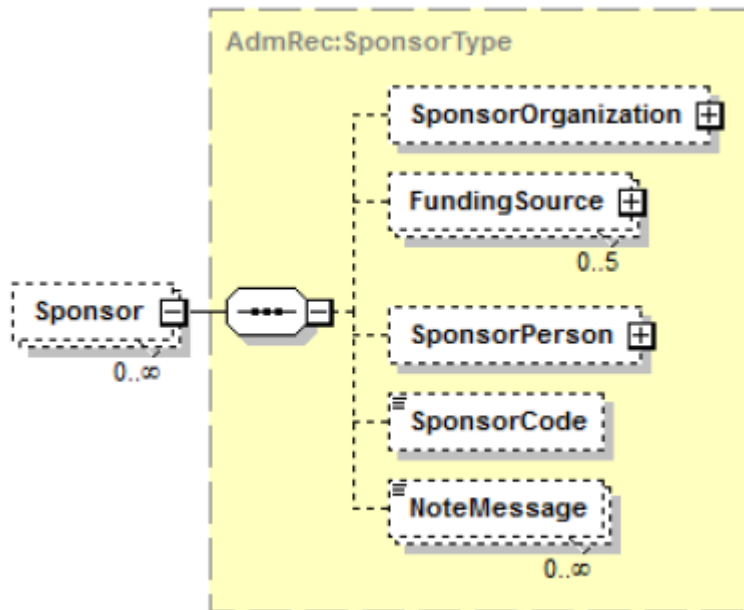

Tag Name	Schema Use	Description	Recommended Use	Format
SponsorOrganization	Optional	Information about the organization that has offered to sponsor the applicant	Recommended	minOcc 0 maxOcc 1
Comment: More detailed information about the SponsorOrganization was presented earlier on page 134.				
FundingSource	Optional Repeatable	The source of the funds being provided for the applicant	Optional	minOcc 0 maxOcc 5
Comment: More detailed information about the FundingSource was presented earlier on page 147.				
SponsorPerson	Optional	Information about the person that has offered to sponsor the applicant	Recommended	minOcc 0 maxOcc 1
Comment: More detailed information about the SponsorPerson was presented earlier on page 158.				
SponsorCode	Optional	The type of sponsor being described	Optional	minOcc 0 maxOcc 1 Enumerations: ForeignCompany ForeignGovernment Institution Organization Other Parent Relative Self Spouse Unknown USCompany USGovernment

PESC XML Application for Admission Implementation Guide Version 1.3.0

NoteMessage	Optional Repeatable	Additional information about the sponsor for the international applicant	Not recommended	minOcc 0 maxOcc ∞ minLength 1 maxLength 80
-------------	------------------------	--	-----------------	---

Applicant.Application.Sponsor (Continued)

Code illustration:

```
<Sponsor>
  <SponsorOrganization>
    </SponsorOrganization>
    <FundingSource>
      </FundingSource>
    <SponsorPerson>
      </SponsorPerson>
    <SponsorCode>Parent</SponsorCode>
  </SponsorCode>
  <NoteMessage/>
</Sponsor>
```

PESC XML Application for Admission Implementation Guide Version 1.3.0

Applicant.Application.ApplicationID

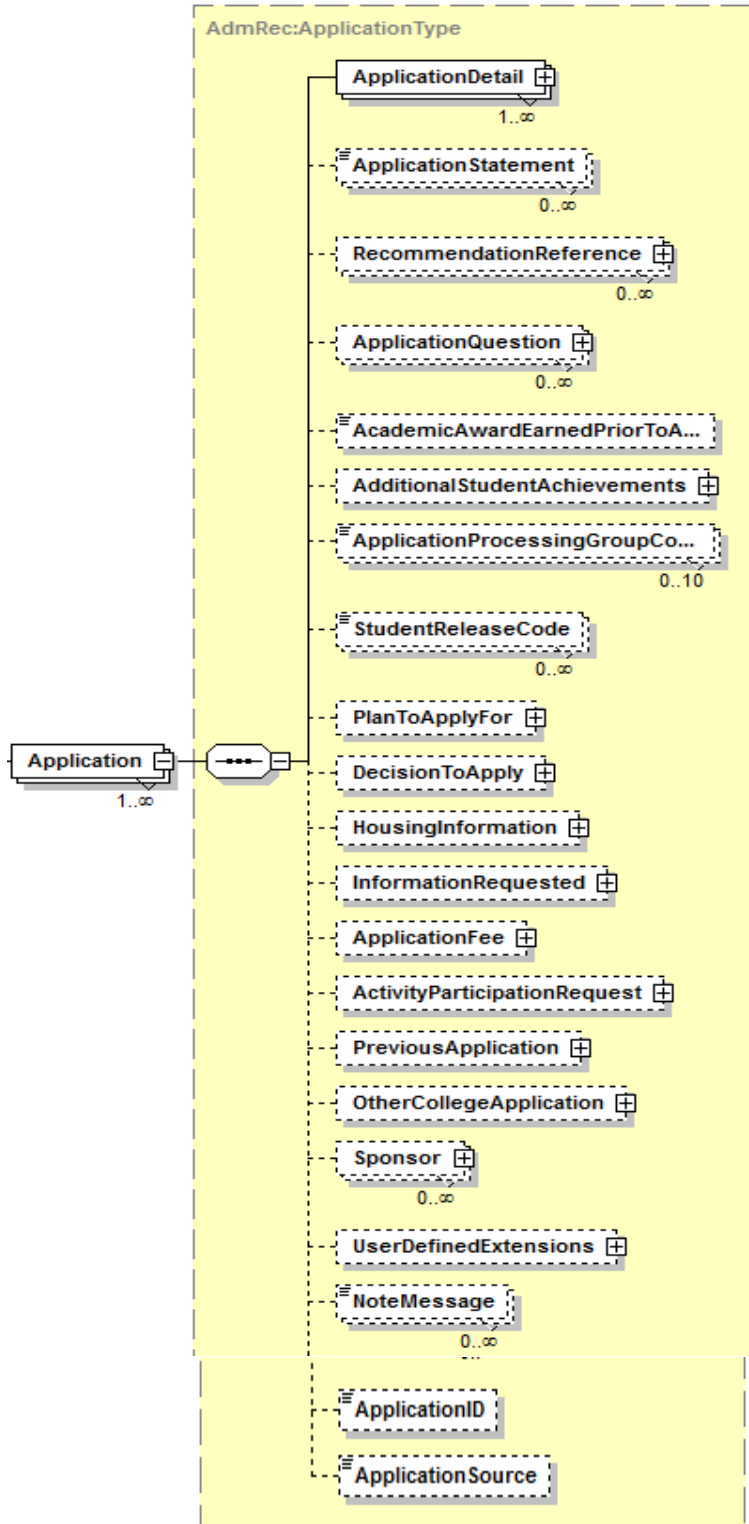

PESC XML Application for Admission Implementation Guide Version 1.3.0

Tag Name	Schema Use	Description	Recommended Use	Format
ApplicationID	Optional	Applicant ID	Optional	minOcc 0 maxOcc 1 minLength 1 maxLength 35

Applicant.Application.ApplicationID (Continued)

Code illustration:

<Not provided at this time>

PESC XML Application for Admission Implementation Guide Version 1.3.0

Applicant.Application.ApplicationSource

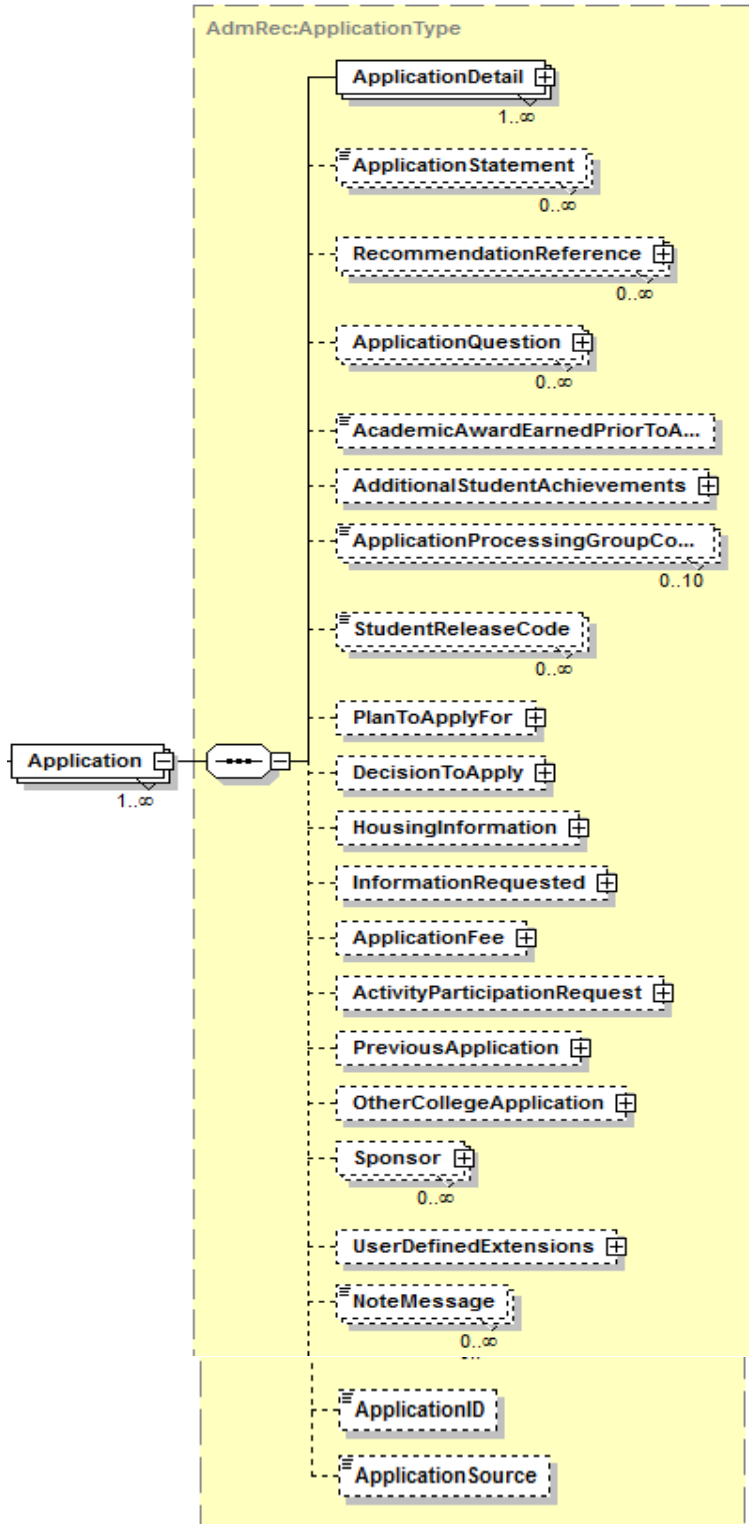

PESC XML Application for Admission Implementation Guide Version 1.3.0

Tag Name	Schema Use	Description	Recommended Use	Format
ApplicationSource	Optional	Applicant Source – add: Applicant and Institution to format colum. Remove min/max length.	Optional	minOcc 0 maxOcc 1 Expresions Enumerati ons Applicant Institution

Applicant.Application.ApplicationSource(Continued)

Code illustration:

<Not provided at this time>

PESC XML Application for Admission Implementation Guide Version 1.3.0

Applicant.GovernmentMilitary

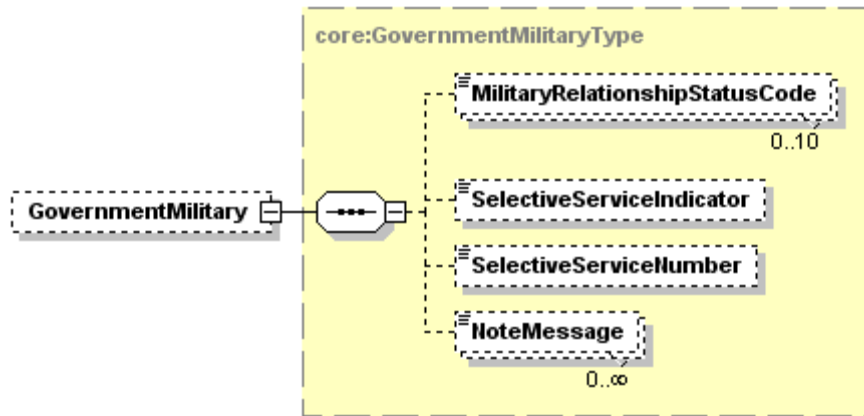

Tag Name	Schema Use	Description	Recommended Use	Format
MilitaryRelationshipStatusCode	Optional Repeatable	This is a code to indicate the relationship of the applicant with the military (specific branch of the Military)	Recommended	minOcc 0 maxOcc 10 Enumerations: ActiveDutyMilitary AirForce AirForceNationalGuard AirForceReserve AirForceROTC ArmedForces ArmedForcesReserves Army ArmyReserve ArmyROTC CoastGuard Dependent InactiveMember MarineCorps MarineCorpsReserve MarineCorpsROTC MerchantMarines Navy NavyReserve NavyROTC None Other ReserveOfficersTrainingProgram Unknown Veteran
SelectiveServiceIndicator	Optional	This is used to indicate if the applicant is required to register in the US for the draft. If so, use True.	Optional	minOcc 0 maxOcc 1 boolean
Comment: If the applicant is required to register in the US for the draft, include this optional data element with the value of "true". If not, then do not include this optional data element in the instance document.				
SelectiveServiceNumber	Optional	This is the Selective Service Number issued by the US government	Recommended	minOcc 0 maxOcc 1 minLength 0 maxLength 20
NoteMessage	Optional Repeatable	Additional information about the relationship of the applicant with the military	Not Recommended	minOcc 0 maxOcc ∞ minLength 1 maxLength 80

PESC XML Application for Admission Implementation Guide Version 1.3.0

Applicant.GovernmentMilitary (Continued)

Code illustration:

```
<GovernmentMilitary>  
  <MilitaryRelationshipStatusCode>AirForce</MilitaryRelationshipStatusCode>  
  <SelectiveServiceIndicator>true</SelectiveServiceIndicator>  
  <SelectiveServiceNumber>123456789012</SelectiveServiceNumber>  
  <NoteMessage/>  
</GovernmentMilitary>
```

PESC XML Application for Admission Implementation Guide Version 1.3.0

Applicant.SelfReportedAcademicRecord

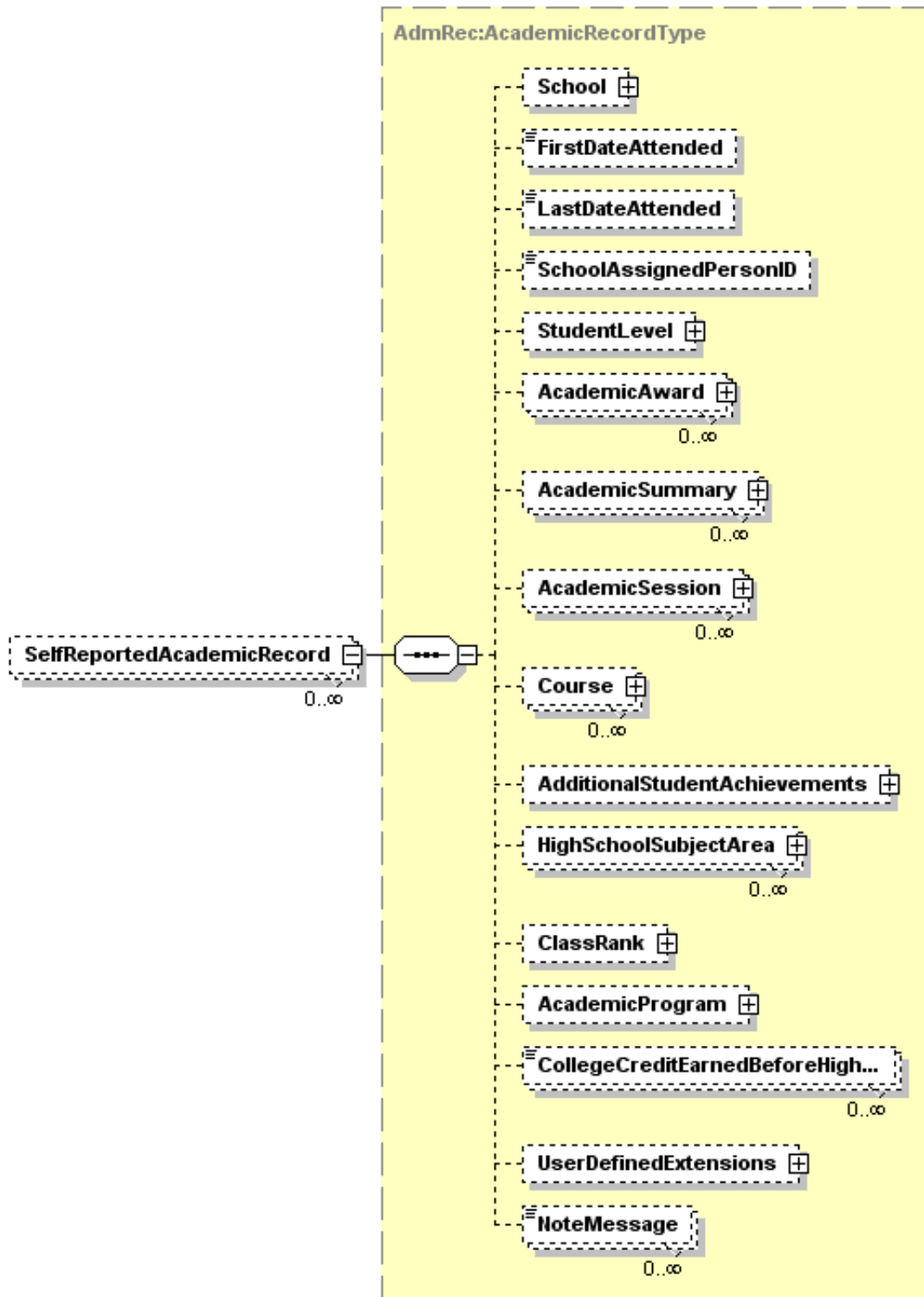

PESC XML Application for Admission Implementation Guide Version 1.3.0

Applicant.SelfReportedAcademicRecord (Continued)

Tag Name	Schema Use	Description	Recommended Use	Format
School	Optional	This is the school where the self reported academic record was earned.	Recommended	minOcc 0 maxOcc 1
Comment: This complex data element will be expanded on page 335.				
FirstDateAttended	Optional	The first date the applicant enrolled at this school	Optional	minOcc 0 maxOcc 1 g:YearMonth Format is CCYY-MM
Comment: This will be used if the applicant was asked to give starting and ending dates of enrollment at the school.				
LastDateAttended	Optional	The last date the applicant enrolled at this school	Optional	minOcc 0 maxOcc ∞ g:YearMonth Format is CCYY-MM
Comment: This will be used if the applicant was asked to give starting and ending dates of enrollment at the school.				
SchoolAssignedPersonID	Optional	The student ID assigned to the applicant at this prior school	Optional	minOcc 0 maxOcc 1 minLength 1 maxLength 20
StudentLevel	Optional	The level of the student at the school where the academic record was earned	Optional	minOcc 0 maxOcc 1
Comment: This complex data element will be expanded on page 350.				
AcademicAward	Optional Repeatable	Academic awards, degrees, diplomas, certifications, etc.	Recommended	minOcc 0 maxOcc ∞
Comment: This complex data element will be expanded on page 351.				
AcademicSummary	Optional Repeatable	Used to send summary totals for all work taken at a certain academic level	Recommended	minOcc 0 maxOcc ∞
Comment: This complex data element will be expanded on page 360.				
AcademicSession	Optional Repeatable	Course, award and summary information related to a specific time period. Typically arranged into successive quarters, semesters or school years. It is normally the preferred method for conveying academic coursework.	Recommended	minOcc 0 maxOcc ∞
Comment: This complex data element will be expanded on page 367.				
Course	Optional Repeatable	Academic coursework not related to a specific session.	Not Recommended	minOcc 0 maxOcc ∞
Comment: The most common way to ask the applicant to indicate courses taken, courses in progress, or courses the applicant plans to take in the future is at the session level. Therefore, if you choose to place this information about courses at this place in the schema, you can certainly do so, and this complex data element is expanded on page 363 under Applicant.SelfReportedAcademicRecord.AcademicSession.Course				
AdditionalStudentAchievements	Optional	Achievements not tied to a specific course, session or award	Optional	minOcc 0 maxOcc 1
Comment: This complex data element will be expanded on page 400.				
HighSchoolSubjectArea	Optional Repeatable	Information about high school courses that are grouped by curriculum area	Optional	minOcc 0 maxOcc ∞
Comment: This complex data element will be expanded on page 404.				

PESC XML Application for Admission Implementation Guide

Version 1.3.0

Tag Name	Schema Use	Description	Recommended Use	Format
ClassRank	Optional	Information reported by the applicant about the applicant's rank in class	Optional	minOcc 0 maxOcc 1
Comment: This complex data element will be expanded on page 405.				
AcademicProgram	Optional	This is the program objective in which the student was enrolled at the high school	Optional	minOcc 0 maxOcc 1
Comment: This complex data element will be expanded further on page 406.				
CollegeCreditEarnedBeforeHighSchoolGraduationCode	Optional Repeatable	An indication of types of college credit earned (or expected to be earned) by an applicant while in secondary school prior to high school graduation	Recommended	minOcc 0 maxOcc ∞ Enumerations: AdvancedPlacement CLEP HighSchoolDualCredit InternationalBaccalaureate Other
Comment: If the value "Other" is included, it is recommended that a NoteMessage be included to describe what is meant by "Other".				
UserDefinedExtensions	Optional	Additional structured information. Requires mutually defined XML mini schema	Optional	minOcc 0 maxOcc 1
NoteMessage	Optional Repeatable	Additional information about the applicant's self-reported prior or current academic record	Not Recommended	minOcc 0 maxOcc ∞ minLength 1 maxLength 80
<p>Comment: The entire complex data element "SelfReportedAcademicRecord" may be repeated. There are several reasons how this feature may be used.</p> <p>The most common use is to show all of the academic record for one school by using one occurrence of SelfReportedAcademicRecord. So, if the student attended a high school, and three postsecondary schools, then four occurrences of "SelfReportedAcademicRecord" could be used. Each of these would allow for indicating an "AcademicSummary" at each school.</p> <p>Another use might be if a school changed the type of credits awarded (changed from awarding semester credits to quarter credits, or vice versa). Then one occurrence could be used for the the school while the credits were awarded on a semester credit basis, and another occurrence could show those credits with quarter credits.</p>				

PESC XML Application for Admission Implementation Guide Version 1.3.0

Applicant.SelfReportedAcademicRecord (Continued)

Code illustration:

```
<SelfReportedAcademicRecord>
  <School>

    </School>
    <FirstDateAttended>2005-08</FirstDateAttended>
    <LastDateAttended>2006-06</LastDateAttended>
    <SchoolAssignedPersonID>123454678</SchoolAssignedPersonID>
    <StudentLevel>

      </StudentLevel>
      <AcademicAward>

        </AcademicAward>
        <AcademicSummary>

          </AcademicSummary>
          <AcademicSession>

            </AcademicSession>
            <Course>

              </Course>
              <AdditionalStudentAchievements>

                </AdditionalStudentAchievements>
                <HighSchoolSubjectArea>

                  </HighSchoolSubjectArea>
                  <ClassRank>

                    </ClassRank>
                    </AcademicProgram>

                  </AcademicProgram>
                  <CollegeCreditEarnedBeforeHighSchoolGraduationCode>CLEP</CollegeCreditEarnedBeforeHighSchoolGraduationCode>
                  <CollegeCreditEarnedBeforeHighSchoolGraduation>AdvancedPlacement</CollegeCreditEarnedBeforeHighSchool
GraduationCode>
                  <UserDefinedExtensions/>
                  <NoteMessage/>
                </SelfReportedAcademicRecord>
```

PESC XML Application for Admission Implementation Guide Version 1.3.0

Applicant.SelfReportedAcademicRecord.School

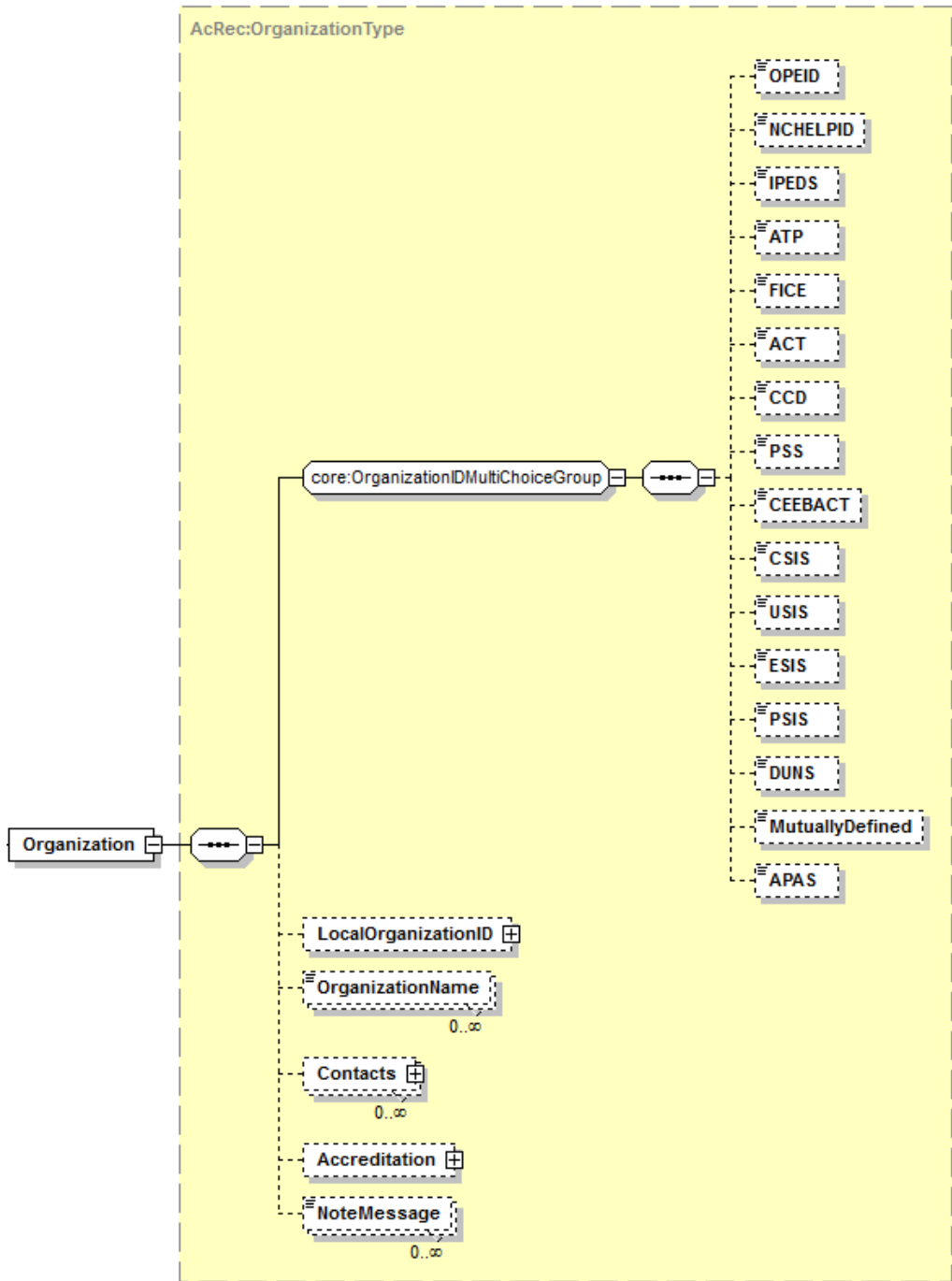

PESC XML Application for Admission Implementation Guide Version 1.3.0

Applicant.SelfReportedAcademicRecord.School (Continued)

Tag Name	Schema Use	Description	Recommended Use	Format
OrganizationName	Required	Name of Non-person entity such as Organization, Institution, Agency or Business.	Required	minOcc 1 maxOcc 1 minLength 1 maxLength 60
Comment: This is the name of the school at which the applicant is reporting academic work was taken.				
[OrganizationIDGroup]	Optional	Allowable Organization IDs - Exclusive choice	Optional	minOcc 0 maxOcc 1
Comment: [OrganizationIDGroup] is not an XML tag and does not appear in an instance document. If included, it requires the choice of one and only one of the following code set tags to identify the source school of the academic record being reported.				
OPEID	Optional choice	The unique identifier assigned by the Office of Postsecondary Education for each data exchange partner. Includes all postsecondary schools that are eligible to participate in US Title IV federal financial aid programs.	Recommended	minOcc 0 maxOcc 1 minLength 3 maxLength 8
Comment: The OPEID could be an appropriate choice to identify a postsecondary school.				
NCHELPID	Optional choice	The unique identifier assigned by National Council on Higher Education Loan Programs for each data exchange partner.	Not Recommended	minOcc 0 maxOcc 1 minLength 3 maxLength 8
Comment: The NCHELPID would not normally be an appropriate choice.				
IPEDS	Optional choice	The unique identifier for Integrated Postsecondary Education Data System assigned by the National Center for Education Statistics for each postsecondary data exchange partner. Also called the Unit ID.	Recommended	minOcc 0 maxOcc 1 minLength 6 maxLength 6
Comment: The IPEDS would be an appropriate choice to identify a postsecondary school.				
ATP	Optional choice	The unique identifier for the Admissions Testing Program assigned by the College Board for each data exchange partner.	Recommended	minOcc 0 maxOcc 1 minLength 6 maxLength 6
Comment: The ATP would be an appropriate choice to identify a postsecondary school.				
FICE	Optional choice	The unique identifier once maintained for the Federal Interagency Committee on Education by the National Center for Education Statistics for each postsecondary data exchange partner.	Recommended	minOcc 0 maxOcc 1 minLength 6 maxLength 6
Comment: The FICE would normally be an appropriate choice to identify a postsecondary school. However, the FICE number was originally maintained by the US Department of Education's National Center for Education Statistics (NCES), but has not been maintained by NCES since late in the last century.				
ACT	Optional choice	The unique identifier for postsecondary educational institutions assigned by American College Testing available at www.act.org	Recommended	minOcc 0 maxOcc 1 minLength 4 maxLength 4
Comment: The ACT would be an appropriate choice to identify a postsecondary school.				
CCD	Optional choice	The unique identifier assigned by National Center for Education Statistics as the Common Core of Data for each data exchange partner.	Recommended	minOcc 0 maxOcc 1 minLength 12 maxLength 12

PESC XML Application for Admission Implementation Guide

Version 1.3.0

Tag Name	Schema Use	Description	Recommended Use	Format
Comment: The CCD would be an appropriate choice to identify a secondary school in the US.				
PSS	Optional choice	The unique identifier assigned by National Center for Education Statistics for private secondary schools in the US.	Recommended	minOcc 0 maxOcc 1 minLength 8 maxLength 8
Comment: The PSS would be an appropriate choice to identify a secondary school in the US.				
CEEBACT	Optional choice	The unique identifier assigned by the College Entrance Examining Board and ACT for each K-12 data exchange partner.	Recommended	minOcc 0 maxOcc 1 minLength 6 maxLength 6
Comment: The CEEBACT would be an appropriate choice to identify a secondary school.				
CSIS	Optional choice	The unique identifier assigned by the Statistics Canada Canadian College Student Information System for each postsecondary data exchange partner.	Optional	minOcc 0 maxOcc 1 minLength 6 maxLength 6
Comment: Since this code set is used to identify postsecondary schools in Canada, it is not a recommended choice for US schools. However, it would be a valid choice for schools in Canada, except that it is now being phased out and the better choice would be the newer PSIS code set.				
USIS	Optional choice	The unique identifier assigned by the Statistics Canada University Student Information System for each data postsecondary exchange partner.	Optional	minOcc 0 maxOcc 1 minLength 6 maxLength 6
Comment: Since this code set is used to identify postsecondary schools in Canada, it is not a recommended choice for schools in the US. However, it would be a valid choice for schools in Canada, except that it is now being phased out and the better choice would be the newer PSIS code set.				
ESIS	Optional choice	The unique identifier assigned by the Statistics Canada Enhanced Student Information System for each data postsecondary exchange partner.	Optional	minOcc 0 maxOcc 1 minLength 8 maxLength 8
Comment: Since this code set is used to identify postsecondary schools in Canada, it is not a recommended choice for schools in the US. However, it would be a valid choice for schools in Canada, but a better choice would be the newer PSIS code set.				
PSIS	Optional choice	The unique identifier assigned by the Statistics Canada Postsecondary Student Information System for each data postsecondary exchange partner.	Optional	minOcc 0 maxOcc 1 minLength 8 maxLength 8
Comment: Since this code set is used to identify postsecondary schools in Canada, it is not a recommended choice for schools in the US. However, it would be the most appropriate choice for postsecondary schools in Canada.				
DUNS	Optional choice	Data Universal Numbering System (DUNS), unique nine character company identification number issued by Dun and Bradstreet Corporation.	Not Recommended	minOcc 0 maxOcc 1 minLength 9 maxLength 9
Comment: The DUNS number would not normally be an appropriate choice.				
MutuallyDefined	Required choice	Mutually defined among trading partners for organizations that do not have a code in any of the other code sets	Not Recommended	minOcc 0 maxOcc 1 minLength 1 maxLength 60
Comment: MutuallyDefined would not normally be an appropriate choice.				
APAS	Optional choice	Identification codes used by the Alberta Post-Secondary Application Systems.	Optional	minOcc 0 maxOcc 1 minLength 2 maxLength 12

PESC XML Application for Admission Implementation Guide

Version 1.3.0

Tag Name	Schema Use	Description	Recommended Use	Format
Comment: This is an appropriate choice for institutions in Canada.				
Comment: End of OrganizationIDGroup choice set tags				
LocalOrganizationID	Optional	A code set typically used by a state, province or region to further identify the sending vendor, agency or school.	Optional	minOcc 0 maxOcc 1
Comment: Additional information about the complex data element Local Organization ID will be shown on page 340.				
SchoolOverrideCode	Optional	Information about why the student took courses at this school	Optional	minOcc 0 maxOcc 1 Enumerations: Coop Institutional Internship MultiCampus Reciprocal StudyAbroad Transfer
Comment: This data element would not normally be included in self-reported academic history. However, the values of Co-op, Internship or Study Abroad might be some use.				
Contacts	Optional Repeatable	To identify a person or an office at the previous school to which administrative communications should be directed	Optional	minOcc 0 maxOcc ∞
Comment: Additional information about the complex data element Contacts will be shown on page 341.				
SecondarySchoolCategoryCode	Optional	The type of secondary school and the type of control for the school	Optional	minOcc 0 maxOcc 1 Enumerations: Charter HomeSchool Independent Parochial Private Public
PostsecondarySchoolCategory	Optional	The type of postsecondary school and the control for the school	Optional	minOcc 0 maxOcc 1 Enumerations: PrivateFourYear PrivateGraduateProfessional PrivateTwoYear PublicFourYear PublicGraduateProfessional PublicTwoYear
NoteMessage	Optional Repeatable	Additional information about the school	Not recommended	minOcc 0 maxOcc ∞ minLength 1 maxLength 80

PESC XML Application for Admission Implementation Guide Version 1.3.0

Applicant.SelfReportedAcademicRecord.School (Continued)

Code illustration:

```
<School>
  <OrganizationName>Miami Senior High School</OrganizationName>
  <CEEBACT>123456</CEEBACT>
  <LocalOrganizationID>

  </LocalOrganizationID>
  <SchoolOverrideCode/>
  <Contacts>

  </Contacts>
  <SecondarySchoolCategoryCode>Public</SecondarySchoolCategoryCode>
  <PostsecondarySchoolCategory/>
  <NoteMessage/>
</School>
```

PESC XML Application for Admission Implementation Guide Version 1.3.0

Applicant.SelfReportedAcademicRecord.School. LocalOrganizationID

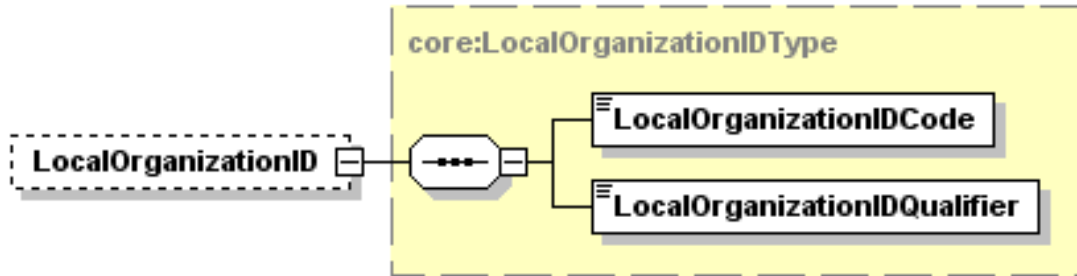

Tag Name	Schema Use	Description	Recommended Use	Format
LocalOrganizationIDCode	Required	The code assigned for the school by the state, province or other mutually defined agency specified in the LocalOrganizationIDQualifier that follows.	Required	minOcc 1 maxOcc 1 minLength 1 maxLength 35
Comment: This is a required data element only if the Local Organization ID complex data element is sent. This is typically the administrative school code assigned by a state or province to specifically identify the school in that state				
LocalOrganizationIDQualifier	Required	This is the state or province that assigned the LocalOrganizationID Code above.	Required	minOcc 1 maxOcc 1 Enumeration: See Code Set in Appendix A.
Comment: This is a required data element only if the Local Organization ID data element is sent. This is typically the state or province that assigned the code to specifically identify the school in that state				

Code illustration:

```
<LocalOrganizationID>
  <LocalOrganizationIDCode>13001212</LocalOrganizationIDCode>
  <LocalOrganizationIDQualifier>FL</LocalOrganizationIDQualifier>
</LocalOrganizationID>
```

PESC XML Application for Admission Implementation Guide Version 1.3.0

Applicant.SelfReportedAcademicRecord.School.Contacts

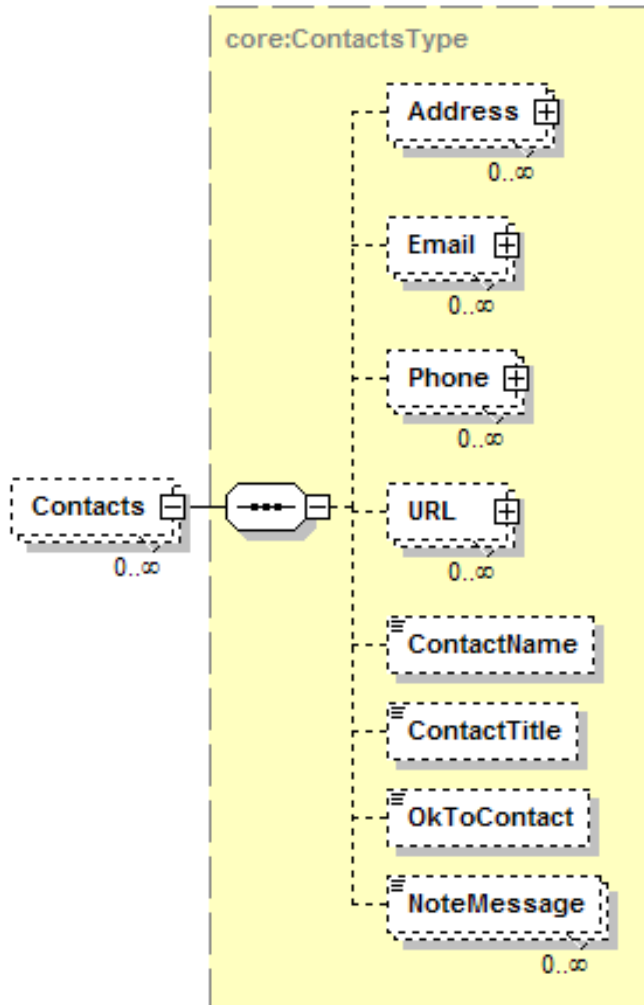

Tag Name	Schema Use	Description	Recommended Use	Format
Address	Optional Repeatable	This is a combined Address Group for a choice between Domestic or International	Optional	minOcc 0 maxOcc ∞
Comment: Additional information about the complex data element Address will be shown on page 343.				
Email	Optional Repeatable	Email address of source company, agency, vendor or institution contact	Optional	minOcc 0 maxOcc ∞
Comment: Additional information about the complex data element Email will be shown on page 346.				
Phone	Optional Repeatable	Phone number of source company, agency, vendor or institution contact	Optional	minOcc 0 maxOcc ∞
Comment: Additional information about the complex data element Phone will be shown on page 347.				
URL	Optional Repeatable	The Uniform Resource Locator of source company, agency or vendor	Optional	minOcc 0 maxOcc ∞
Comment: Additional information about the complex data element URL will be shown on page 349.				

PESC XML Application for Admission Implementation Guide Version 1.3.0

Tag Name	Schema Use	Description	Recommended Use	Format
ContactName	Optional	This is the name of the contact at the source for this transmission.	Optional	minOcc 0 maxOcc 1 minLength 1 maxLength 60
ContactTitle	Optional	The job or position title of the contact at the school	Optional	minOcc 0 maxOcc 1 minLength 1 maxLength 60
OkToContact	Optional	An indicator if it is OK to contact this person at the school	Optional	minOcc 0 maxOcc 1 Enumerations: No Yes
NoteMessage	Optional Repeatable	Additional information about the contacts at the source company, agency or vendor	Not recommended	minOcc 0 maxOcc ∞ minLength 1 maxLength 80

Code illustration:

```

<Contacts>
  <Address>

  </Address>
  <Email>

  </Email>
  <Phone>

  </Phone>
  <URL>

  </URL>
  <ContactName>Reggie Registrar</ContactName>
  <ContactTitle>Guidance Counselor</ContactTitle>
  <OkToContact>Yes</OkToContact>
  <NoteMessage/>
</Contacts>

```

PESC XML Application for Admission Implementation Guide Version 1.3.0

Applicant.SelfReportedAcademicRecord.School.Contacts.Address

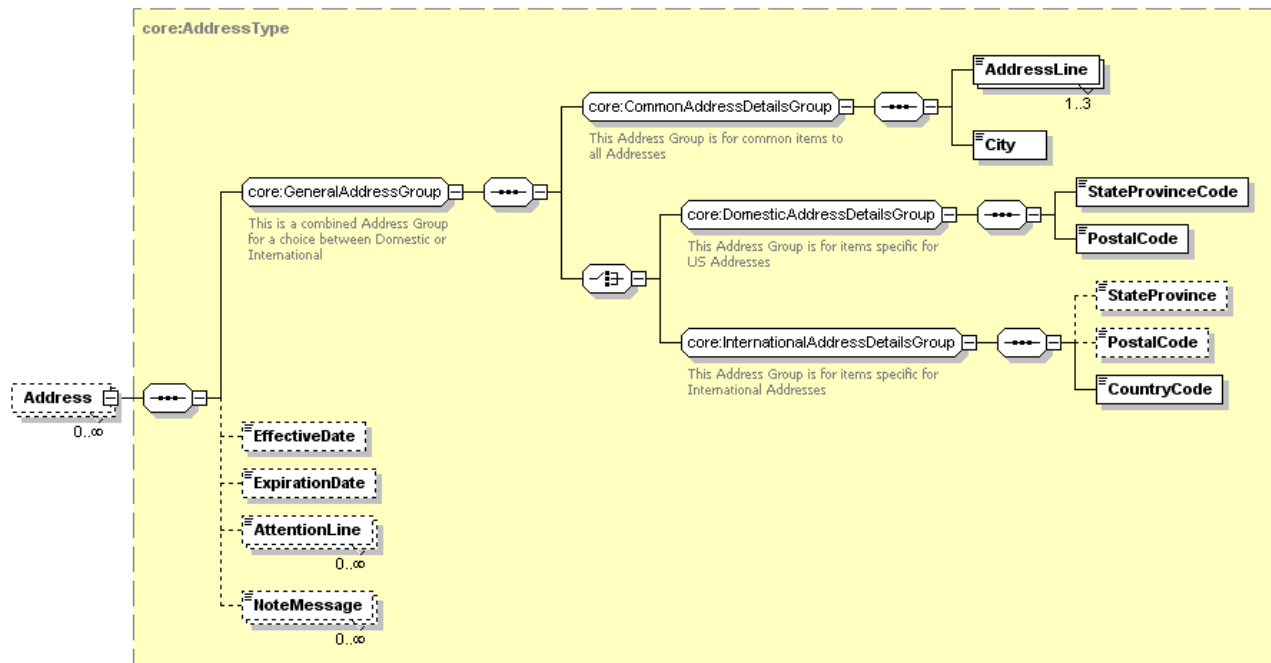

Tag Name	Schema Use	Description	Recommended Use	Format
<i>GeneralAddressGroup</i>	Required	This Address Group is for items common to all Addresses	Required	minOcc 1 maxOcc 1
Comment: [<i>GeneralAddressGroup</i>] does not appear in the instance document. It requires the use of <i>CommonAddressDetailsGroup</i> and the choice of one of either <i>DomesticAddressDetailsGroup</i> or <i>InternationalAddressDetailsGroup</i> . This group is required in the schema only if you choose to send the address of the contact at the school the applicant attended.				
<i>CommonAddressDetailsGroup</i>	Required	This Address Group is for items common to all Addresses	Required	minOcc 1 maxOcc 1
Comment: [<i>CommonAddressDetailsGroup</i>] does not appear in the instance document. If the address of a contact is included in the Application for Admission, then this must be sent. It is required and must be paired with one of either <i>DomesticAddressDetailsGroup</i> or <i>InternationalAddressDetailsGroup</i> .				
AddressLine	Required Repeatable	Local delivery information such as street, building number, PO box, or apartment portion of a postal address of a Contact at the Sending (Source) Company, Agency or Vendor.	Required	minOcc 1 maxOcc 3 minLength 1 maxLength 40
City	Required	The city portion of the Address of a Contact at the Sending (Source) Company, Agency or Vendor.	Required	minOcc 1 maxOcc 1 minLength 2 maxLength 30
<i>DomesticAddressDetailsGroup</i>	Required choice	This Address Group is for items specific for US and Canadian Addresses	Required for domestic addresses	minOcc 1 maxOcc 1
Comment: [<i>DomesticAddressDetailsGroup</i>] does not appear in the instance document. If the complex data element address has a United States or Canadian Postal Code and a US State or Canadian Province Code, then this should be the required choice.				

PESC XML Application for Admission Implementation Guide

Version 1.3.0

Tag Name	Schema Use	Description	Recommended Use	Format
StateProvinceCode	Required	Code for US states, etc., and Canadian provinces.	Required	minOcc 1 maxOcc 1 Enumeration: See Appendix A
PostalCode	Required	The postal code portion of the Address.	Required	minOcc 1 maxOcc 1 minLength 1 maxLength 17
<i>InternationalAddressDetailsGroup</i>	Required choice	This Address Group is for items specific for International Addresses	Required for international addresses	minOcc 1 maxOcc 1
Comment: [InternationalAddressDetailsGroup] does not appear in the instance document. This choice is for addresses that do not have a US or Canadian postal code.				
StateProvince	Optional	The literal name of the state, province or territory of a postal address of the source of this document. Use for addresses outside US or Canada.	Recommended Refer to common postal practices of the source country	minOcc 0 maxOcc 1 minLength 2 maxLength 30
Comment: For an internet resource of states or other geographical subdivisions in countries other than the US and Canada, you might choose to refer to the website of the Universal Postal Union at http://www.upu.int				
PostalCode	Optional	The postal code portion of the Address.	Recommended Refer to common postal practices of the source country	minOcc 0 maxOcc 1 minLength 1 maxLength 17
Comment: For an internet resource of states or other geographical subdivisions in countries other than the US and Canada, you might choose to refer to the website of the Universal Postal Union at http://www.upu.int				
CountryCode	Required	Code indicating Country. Use ISO 3166-1 alpha-2 standard.	Required	minOcc 1 maxOcc 1 Enumerations: See Appendix B1 or B2
EffectiveDate	Optional	The date on which the address became (or will become) effective	Optional	minOcc 0 maxOcc 1 Date format: CCYY-MM-DD
ExpirationDate	Optional	The date on which the address will (or did) expire	Optional	minOcc 0 maxOcc 1 Date format: CCYY-MM-DD
AttentionLine	Optional Repeatable	The individual or office name within the postal address where inquiries should be directed.	Optional	minOcc 0 maxOcc ∞ minLength 1 maxLength 45
NoteMessage	Optional Repeatable	Additional information about the addresses of the contact at the override school	Not recommended	minOcc 0 maxOcc ∞ minLength 1 maxLength 80

PESC XML Application for Admission Implementation Guide Version 1.3.0

Applicant.SelfReportedAcademicRecord.School.Contacts.Address (Continued)

Code illustration 1 (Domestic Address):

```
<Address>  
  <AddressLine>1715 W Cesar Chavez</AddressLine>  
  <City>Austin</City>  
  <StateProvinceCode>TX</StateProvinceCode>  
  <PostalCode>78703</PostalCode>  
  <EffectiveDate/>  
  <ExpirationDate/>  
  <AttentionLine/>  
  <NoteMessage/>  
</Address>
```

Code illustration 2 (International Address):

```
<Address>  
  <AddressLine>Altova Corporation</AddressLine>  
  <AddressLine>Rudolfplatz 13a/9</AddressLine>  
  <City>Wien</City>  
  <StateProvince/>  
  <PostalCode>A-1010</PostalCode>  
  <CountryCode>AT</CountryCode>  
  <EffectiveDate/>  
  <ExpirationDate/>  
  <AttentionLine/>  
  <NoteMessage/>  
</Address>
```

PESC XML Application for Admission Implementation Guide Version 1.3.0

Applicant.SelfReportedAcademicRecord.School.Contacts.Email

Note: Although the complex data element *Email* is an optional data element, if you choose to send the *Email Address* for the source of the electronic application, then you must send the data element *EmailAddress*.

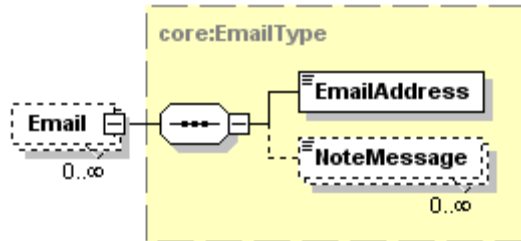

Tag Name	Schema Use	Description	Recommended Use	Format
EmailAddress	Required	The numbers, letters, and symbols used to identify an electronic mail (Email) user within a network.	Required	minOcc 1 maxOc 1 minLength 1 maxLength 128
NoteMessage	Optional Repeatable	Additional information about the email addresses of the contact at the override school	Not recommended	minOcc 0 maxOcc ∞ minLength 1 maxLength 80

Code illustration:

```
<Email>
  <EmailAddress>afarella@collegeboard.org</EmailAddress>
  <NoteMessage/>
</Email>
```

PESC XML Application for Admission Implementation Guide Version 1.3.0

Applicant.SelfReportedAcademicRecord.School.Contacts.Phone

Note: Although the complex data element Phone is an optional data element, if you choose to send the Phone of a Contact at the Sending (Source) Company, Agency or Institution, then you must send a phone number.

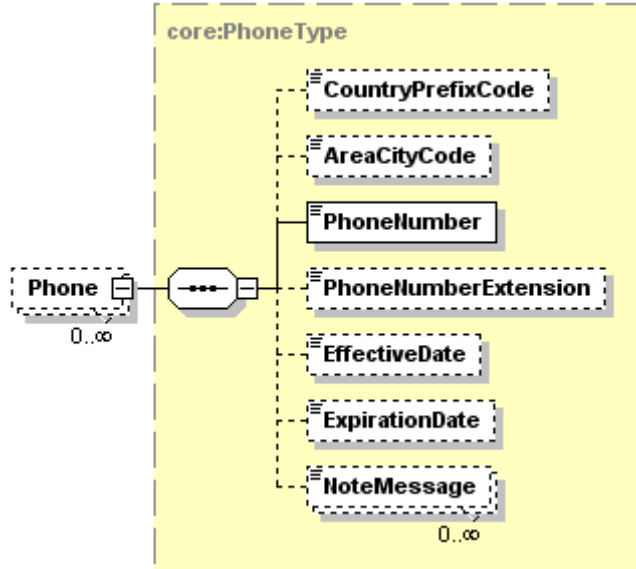

Tag Name	Schema Use	Description	Recommended Use	Format
CountryPrefixCode	Optional	International dialing code	Recommended	minOcc 0 maxOcc 1 minLength 1 maxLength 3
AreaCityCode	Optional	Regional dialing code	Recommended	minOcc 0 maxOcc 1 minLength 1 maxLength 5
PhoneNumber	Required	Telephone number	Required	minOcc 1 maxOcc 1 minLength 1 maxLength 11
Comment: The phone number will typically be sent as a string of numbers with no spaces, periods nor dashes.				
PhoneNumberExtension	Optional	The extended telephone addressing information used in addition to phone number such as a PBX extension, a pager PIN, or FAX sub-address	Optional	minOcc 0 maxOcc 1 minLength 1 maxLength 5
EffectiveDate	Optional	The date on which the phone number became (or will become) effective	Optional	minOcc 0 maxOcc 1 Date format: CCYY-MM-DD
ExpirationDate	Optional	The date on which the phone number will (or did) expire	Optional	minOcc 0 maxOcc 1 Date format: CCYY-MM-DD
NoteMessage	Optional Repeatable	Additional information about the phone numbers of the contacts at the source school	Not recommended	minOcc 0 maxOcc ∞ minLength 1 maxLength 80

PESC XML Application for Admission Implementation Guide Version 1.3.0

Applicant.SelfReportedAcademicRecord.School.Contacts.Phone (Continued)

Code illustration:

```
<Phone>  
  <CountryPrefixCode/>  
  <AreaCityCode>512</AreaCityCode>  
  <PhoneNumber>4142505</PhoneNumber>  
  <PhoneNumberExtension/>  
  <EffectiveDate/>  
  <ExpirationDate/>  
  <NoteMessage/>  
</Phone>
```

PESC XML Application for Admission Implementation Guide Version 1.3.0

Applicant.SelfReportedAcademicRecord.School.Contacts.URL

Note: Although the complex data element URL is an optional data element, if you choose to send the URL of the School, then you must send the URLAddress.

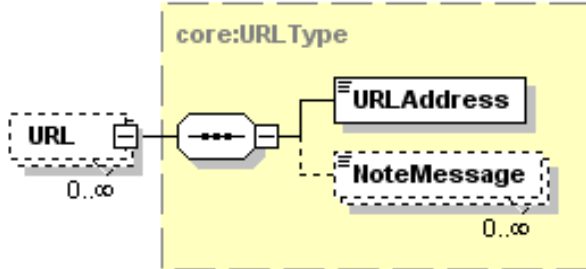

Tag Name	Schema Use	Description	Recommended Use	Format
URLAddress	Required	The Uniform Resource Locator (URL) address of the sending company, agency or vendor, or of a contact at the sending company, agency or vendor	Required	minOcc 1 maxOcc 1 minLength 1 maxLength 512
NoteMessage	Optional Repeatable	Additional information about the URL address of the source institution	Not recommended	minOcc 0 maxOcc ∞ minLength 1 maxLength 80

Code illustration:

```
<URL>
  <URLAddress>www.Xap.com</URLAddress>
  <NoteMessage/>
</URL>
```

PESC XML Application for Admission Implementation Guide Version 1.3.0

Applicant.SelfReportedAcademicRecord.StudentLevel

Note: If you choose to include the optional *StudentLevel*, then you must include the *StudentLevelCode*.

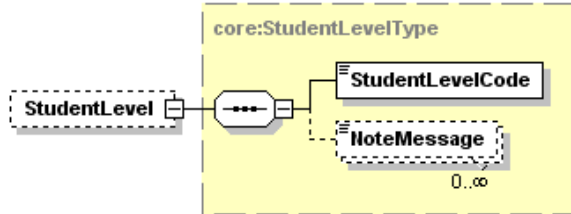

Tag Name	Schema Use	Description	Recommended Use	Format
StudentLevelCode	Required	The level of the student at the school	Required	minOcc 1 maxOcc 1 Enumerations: CollegeFifthYear CollegeFirstYear CollegeFirstYearAttendedBefore CollegeJunior CollegeSenior CollegeSophomore Doctoral EighthGrade EleventhGrade GraduateBeyondThirdYear GraduateFirstYear GraduateNonDegree GraduateSecondYear GraduateThirdYear Masters MastersQualifying NinthGrade NonDegree PostBaccalaureate Postdoctoral PostSecondary PostSecondaryBachelorPreliminaryYear Professional ProfessionalBeyondThirdYear ProfessionalFirstYear ProfessionalSecondYear ProfessionalThirdYear SeventhGrade TenthGrade TwelfthGrade
Comment: The Student Level Code is required only if the complex data element Student Level is included in the instance document.				
NoteMessage	Optional	Additional information about the level of the student	Not Recommended	minOcc 1 maxOcc 1 minLength 1 maxLength 80

Code illustration:

```

<StudentLevel>
  <StudentLevelCode>Masters</StudentLevelCode>
  <NoteMessage/>
</StudentLevel>
    
```

PESC XML Application for Admission Implementation Guide Version 1.3.0

Applicant.SelfReportedAcademicRecord.AcademicAward

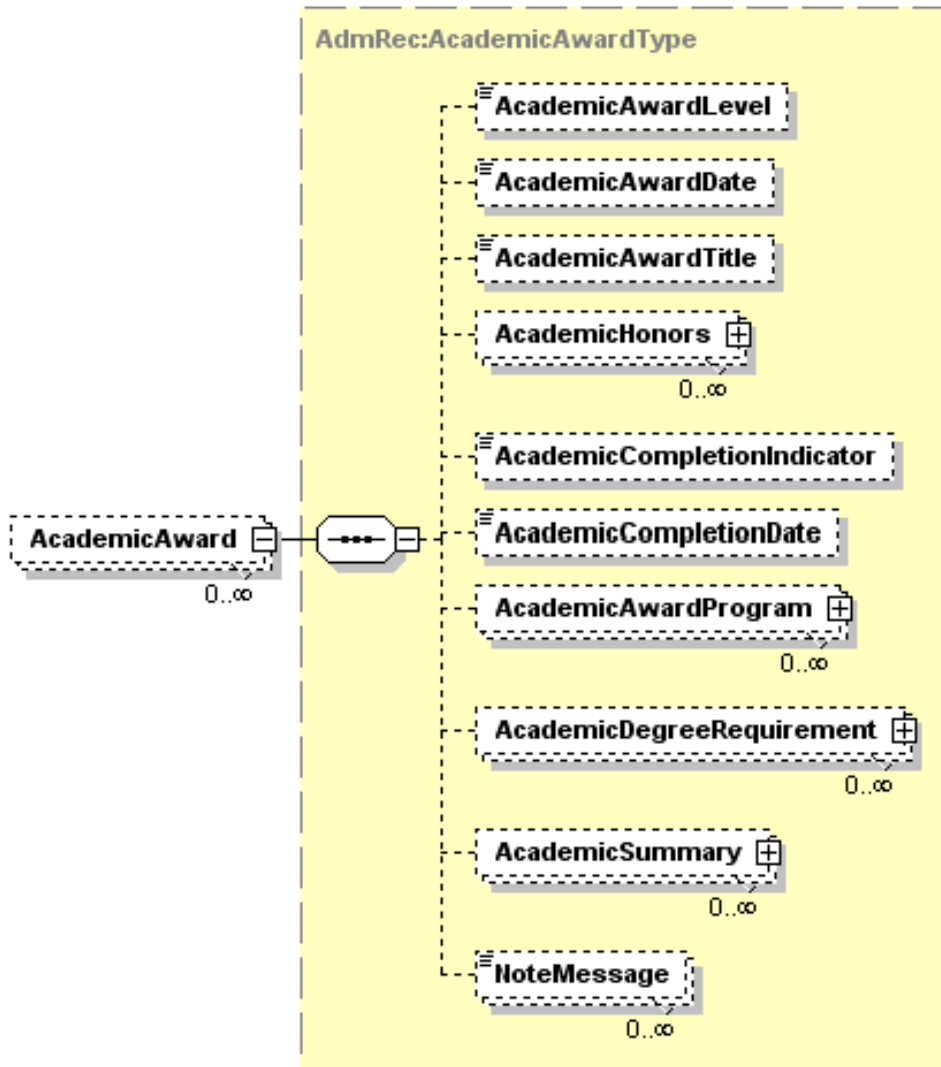

Tag Name	Schema Use	Description	Recommended Use	Format
AcademicAwardLevel	Optional	<p>The level of the degree, certificate, or award granted for the successful completion of requirements of an academic program.</p> <p>Secondary Awards:</p> <p>B17 Did not complete secondary school</p> <p>B18 Standard High School Diploma which may or may not include an exit test</p> <p>B19 Advanced or honors diploma</p> <p>B20 Vocational diploma</p>	Recommended	minOcc 0 maxOcc 1 Enumerations: B17 B18 B19 B20 B21 B22 B23 B24 B25 B26 B27 B28 B58 B59

PESC XML Application for Admission Implementation Guide

Version 1.3.0

Tag Name	Schema Use	Description	Recommended Use	Format
		B21 Special Education Diploma normally for students with a disability		B60 FrenchBaccalaureate CEGEP 1.1 1.2
		B22 Certificate of completion or attendance		2.0 2.1
		B23 Special certificate of completion or attendance		2.2 2.3 2.4
		B24 General Education Development (GED) Diploma		2.5 2.6 2.7
		B25 Other high school equivalency diploma		3.1 3.2
		B26 International diploma or certificate such as International Baccalaureate		4.1 4.2 4.3 4.4
		B27 Standard High School Diploma with only 3 year curriculum		4.5
		B28 Met all graduation requirements except for required exit test		
		B58 International Baccalaureate Examination		
		B59 GCE – General Certificate of Education		
		B60 Honorary High School Diploma		
		Postsecondary Awards:		
		1.1 Certificate of completion		
		1.2 Certificate of proficiency		
		2.0 Certificate		
		2.1 Postsecondary Certificate or Diploma (less than one year)		
		2.2 Postsecondary Certificate or Diploma (one year or more, but less than four years)		
		2.3 Associate Degree (e.g., Associate in Arts, Associate in Science)		
		2.4 Baccalaureate Degree		
		2.5 Baccalaureate (Honors) Degree		
		2.6 Postsecondary Certificate or Diploma (one year or more, but less than two years)		
		2.7 Postsecondary Certificate or Diploma (two years or more, but less than four years)		
		3.1 First Professional Degree		
		3.2 Post-Professional Degree		
		4.1 Graduate Certificate		
		4.2 Master's Degree		
		4.3 Intermediate Graduate Degree		
		4.4 Doctoral Degree		
		4.5 Post-Doctoral Award		

PESC XML Application for Admission Implementation Guide

Version 1.3.0

Tag Name	Schema Use	Description	Recommended Use	Format
		Awards Used in Canada: FrenchBaccalaureate CEGEP (Collège d'enseignement general et professionnel)		
AcademicAwardDate	Optional	The date on which the academic award was conferred	Recommended	minOcc 0 maxOcc 1 xs:date where format is ccyy-mm-dd
Comment: This is the nominal date when the award was granted. It might not be the same as the actual date of completion of the award requirements.				
AcademicAwardTitle	Optional	The descriptive title for the academic award	Recommended	minOcc 0 maxOcc 1 minLength 1 maxLength 400
AcademicHonors	Optional Repeatable	Honors information for the academic award	Recommended	minOcc 0 maxOcc ∞
Comment: This complex data element will be expanded on page 355.				
AcademicCompletionIndicator	Optional	An indication that the degree-seeking student completed all of the requirements for his or her academic program. Not used for Non-Degree programs.	Optional	minOcc 0 maxOcc 1 Acceptable values are true or false
Comment: If the applicant states that the award requirements were not completed, then this data element should be included with the instance document with a value of "false". If the applicant states that the requirements were met, then the data element should be included with a value of "true".				
AcademicCompletionDate	Optional	The date on which the student's requirements for the degree were met or completed.	Recommended	minOcc 0 maxOcc 1 xs:date format is ccyy-mm-dd
Comment: This is the nominal date when all the requirements for the award were completed. It might not be the same as the nominal date of the award.				
AcademicAwardProgram	Optional Repeatable	Information related to the specific area of study (e.g., major) under which the award was granted.	Recommended	minOcc 0 maxOcc 1
Comment: This complex data element will be expanded on page 356.				
AcademicDegreeRequirement	Optional Repeatable	Thesis or dissertation information if required for the award	Optional	minOcc 0 maxOcc ∞
Comment: This complex data element will be expanded on page 359.				
AcademicSummary	Optional Repeatable	Academic summary information pertaining to the award	Optional	minOcc 0 maxOcc ∞
Comment: It would be unusual for a school to ask an applicant for admission to provide a summary of the credits earned and the GPA achieved for a degree or other award earned. In the rare case that this does occur, then this complex data element is expanded on page 353 which follows in this Guide under Applicant.SelfReportedAcademicRecord.AcademicSummary.				
NoteMessage	Optional Repeatable	Additional information about the academic award	Not Recommended	minOcc 0 maxOcc ∞ minLength 1 maxLength 80

PESC XML Application for Admission Implementation Guide Version 1.3.0

Applicant.SelfReportedAcademicRecord.AcademicAward (Continued)

Code illustration:

```
<AcademicAward>
  <AcademicAwardLevel>2.4</AcademicAwardLevel>
  <AcademicAwardDate>1990-05-09</AcademicAwardDate>
  <AcademicAwardTitle>BACHELOR OF ARTS</AcademicAwardTitle>
  <AcademicHonors>

  </AcademicHonors>
  <AcademicCompletionIndicator/>
  <AcademicCompletionDate/>
  <AcademicAwardProgram>

  </AcademicAwardProgram>
  <AcademicDegreeRequirement>

  </AcademicDegreeRequirement>
  <AcademicSummary/>
  <NoteMessage/>
</AcademicAward>
```

PESC XML Application for Admission Implementation Guide Version 1.3.0

Applicant.SelfReportedAcademicRecord.AcademicAward. AcademicHonors

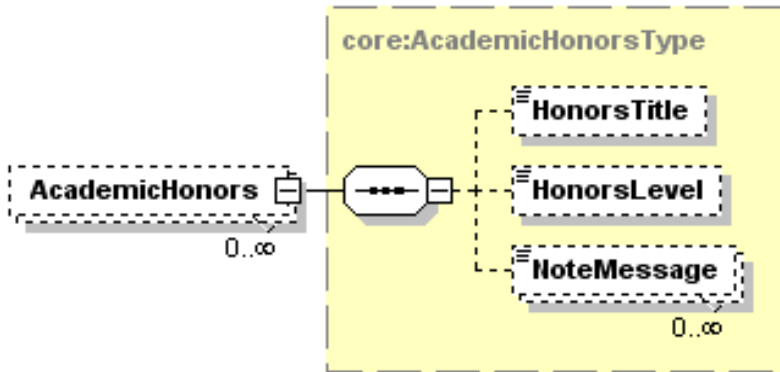

Tag Name	Schema Use	Description	Recommended Use	Format
HonorsTitle	Optional	The descriptive title for the honors received	Optional	minOcc 0 maxOcc 1 minLength 1 maxLength 30
HonorsLevel	Optional	A code value representing 1st highest honor, 2nd highest and 3rd highest.	Optional	minOcc 0 maxOcc 1 Enumerations: FirstHighest SecondHighest ThirdHighest
NoteMessage	Optional Repeatable	Additional information about the URL address of the source institution	Not recommended	minOcc 0 maxOcc ∞ minLength 1 maxLength 80

Code illustration:

```

<AcademicHonors>
  <HonorsTitle>Cum Laude</HonorsTitle>
  <HonorsLevel>ThirdHighest</HonorsLevel>
  <NoteMessage/>
</AcademicHonors>
  
```

PESC XML Application for Admission Implementation Guide Version 1.3.0

Applicant.SelfReportedAcademicRecord.AcademicAward. AcademicAwardProgram

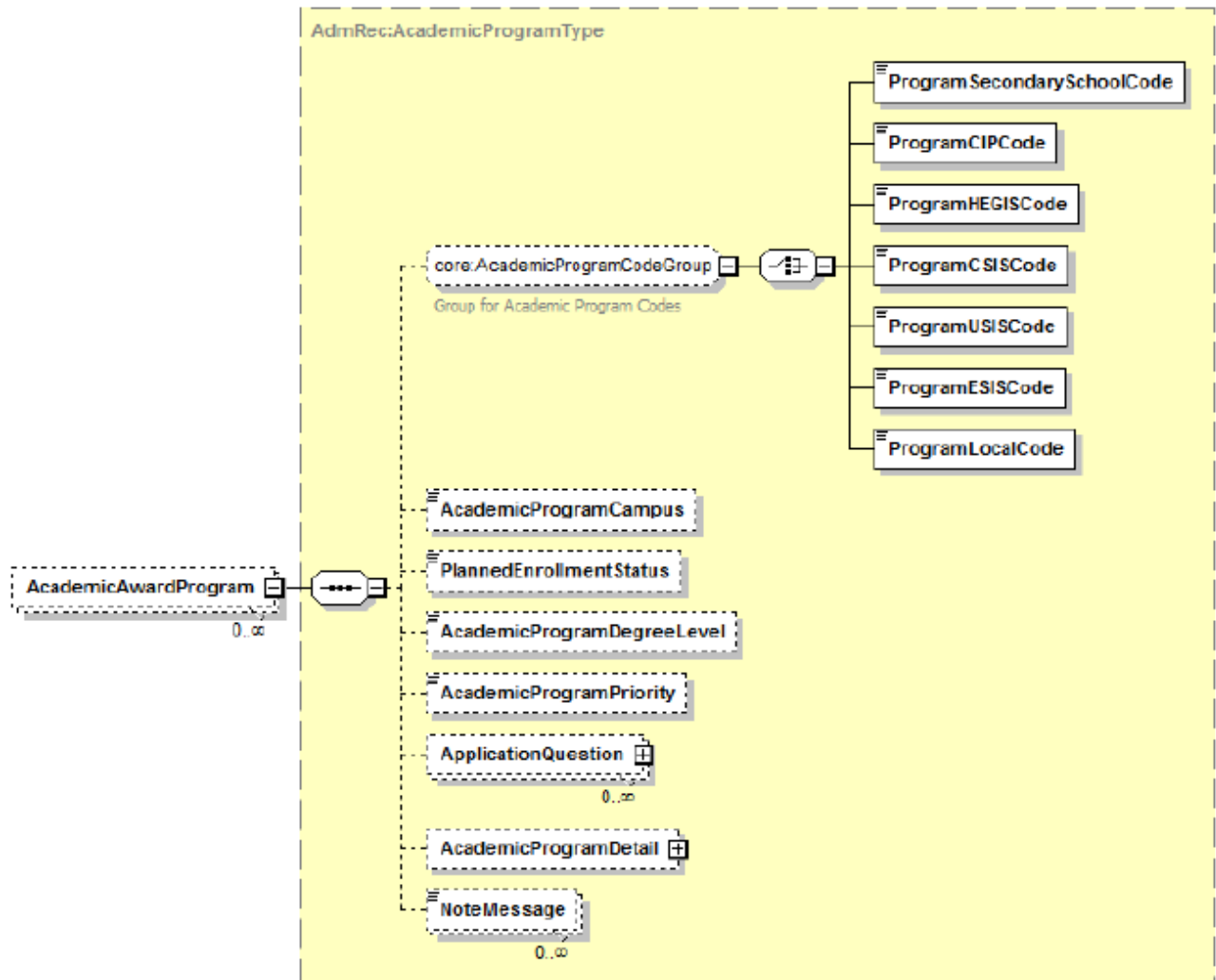

Tag Name	Schema Use	Description	Recommended Use	Format
ProgramSecondarySchoolCode	Optional exclusive choice	Code indicating a discipline or field or level of student in a secondary school	Recommended (use one)	minOcc 0 maxOcc 1 Enumerations: CareerPrep CollegePrep CollegePrepOrCollegeTechPrep CollegeTechPrep General Occupational Vocational
ProgramCIPCode	Optional exclusive choice	Code indicating a discipline or field of study in the Classification of Instructional Programs	Recommended (use one)	minOcc 0 maxOcc 1 minLength 6 maxLength 20

PESC XML Application for Admission Implementation Guide

Version 1.3.0

Tag Name	Schema Use	Description	Recommended Use	Format
Comment: The CIP Code set is maintained by the US Department of Education's National Center for Education Statistics (NCES) and is updated every ten years. The latest version is for the year 2010.				
ProgramHEGISCode	Optional exclusive choice	Code indicating a discipline or field of study assigned by Higher Education General Information Survey	Recommended (use one)	minOcc 0 maxOcc 1 minLength 6 maxLength 20
ProgramCSISCode	Optional exclusive choice	Code indicating a discipline or field of study assigned by Statistics Canada for the Canadian College Student Information System	Recommended (use one)	minOcc 0 maxOcc 1 minLength 5 maxLength 5
ProgramUSISCode	Optional exclusive choice	Code indicating a discipline or field of study assigned by Statistics Canada for the Canadian University Student Information System	Recommended (use one)	minOcc 0 maxOcc 1 minLength 5 maxLength 5
ProgramESISCode	Optional exclusive choice	Code indicating a discipline or field of study assigned by Statistics Canada for the Canadian Enhanced Student Information System	Recommended (use one)	minOcc 0 maxOcc 1 minLength 1 maxLength 20
ProgramLocalCode	Optional exclusive choice	A code identifying the specific program at the local school to which the person is applying	Recommended (use one)	minOcc 0 maxOcc 1 minLength 1 maxLength
AcademicProgramCampus	Optional	Name of the campus which offers the desired program of the applicant	Recommended	minOcc 0 maxOcc 1 minLength 1 maxLength 20
PlannedEnrollmentStatus	Optional	Information about the full time or part time planned enrollment	Not Recommended	minOcc 0 maxOcc 1 Enumerations: FullTime Parttime
AcademicProgramDegreeLevel	Optional	Level of the program in which the applicant was previously enrolled	Recommended	minOcc 0 maxOcc 1 Enumerations: AssociateDegree BaccalaureateDegree Certificate Doctorate GraduateDegree HighSchool MastersDegree NonDegree PostSecondaryDiploma ProfessionalDegree
AcademicProgramPriority	Optional	The priority preference ranking of this choice with other application choices being submitted with this application for admission	Not Recommended	minOcc 0 maxOcc 1 This is a numeric field with allowable values of 1, 2, 3, etc.
ApplicationQuestion	Optional Repeatable	Individual questions that are likely specific to one institution	Not Recommended	minOcc 0 maxOcc ∞
AcademicProgramDetail	Optional	Details about the specific program in which the applicant was previously enrolled	Not Recommended	minOcc 0 maxOcc 1
NoteMessage	Optional	Additional information about the academic award program	Not Recommended	minOcc 0 maxOcc ∞ minLength 1 maxLength 80

PESC XML Application for Admission Implementation Guide Version 1.3.0

Applicant.SelfReportedAcademicRecord.AcademicAward. AcademicAwardProgram (Continued)

Code illustration:

```
<AcademicAwardProgram>  
  <ProgramLocalCode>BS Chem</ProgramLocalCode>  
  <AcademicProgramCampus>Dupont Campus</AcademicProgramCampus>  
  <PlannedEnrollmentStatus/>  
  <AcademicProgramDegreeLevel>BaccalaureateDegree</AcademicProgramDegreeLevel>  
  <AcademicProgramPriority/>  
  <ApplicationQuestion/>  
  <AcademicProgramDetail/>  
  <NoteMessage/>  
</AcademicAwardProgram>
```

PESC XML Application for Admission Implementation Guide Version 1.3.0

Applicant.SelfReportedAcademicRecord.AcademicAward. AcademicDegreeRequirement

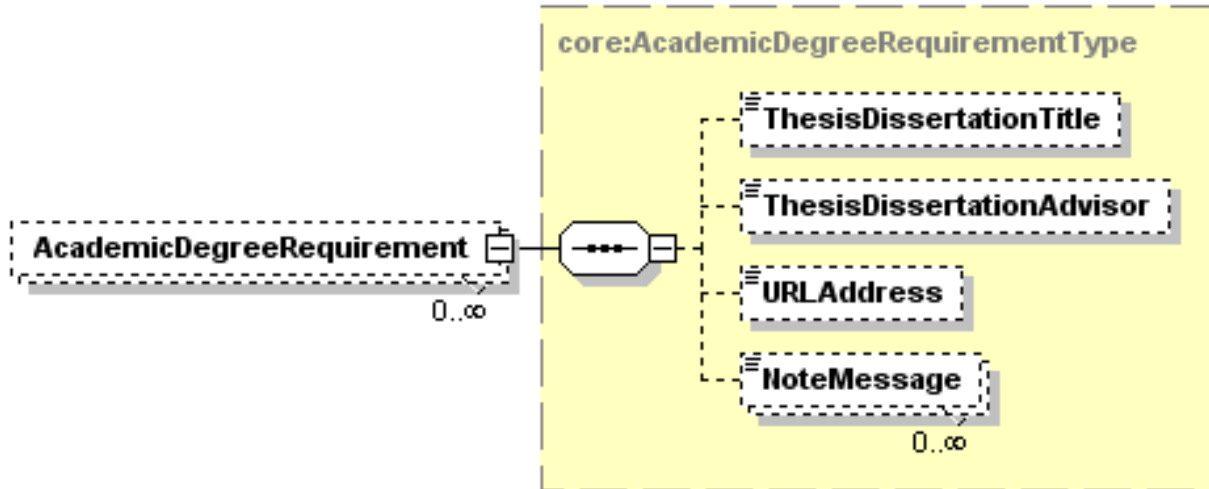

-Tag Name	Schema Use	Description	Recommended Use	Format
ThesisDissertationTitle	Optional	The title of the thesis or dissertation	Optional	minOcc 0 maxOcc 1 minLength 1 maxLength ∞
ThesisDissertationAdvisor	Optional	The advisor (Major Professor) who is supervising the Thesis or Dissertation on behalf of the student earning the degree.	Optional	minOcc 0 maxOcc 1 minLength 1 maxLength 45
URLAddress	Optional	The Uniform Resource Locator address on the Internet where the thesis or dissertation is accessible	Optional	minOcc 0 maxOcc 1 minLength 1 maxLength 512
NoteMessage	Optional Repeatable	Additional information about the academic degree requirement	Not recommended	minOcc 0 maxOcc ∞ minLength 1 maxLength 80

Code illustration:

```

<AcademicDegreeRequirement>
  <ThesisDissertationTitle>Everything's Better with Chemistry</ThesisDissertationTitle>
  <ThesisDissertationAdvisor>Dr. Dupont</ThesisDissertationAdvisor>
  <URLAddress>www.UF.edu/dissertation/AG123456</URLAddress>
  <NoteMessage/>
</AcademicDegreeRequirement>
  
```

PESC XML Application for Admission Implementation Guide Version 1.3.0

Applicant.SelfReportedAcademicRecord.AcademicSummary

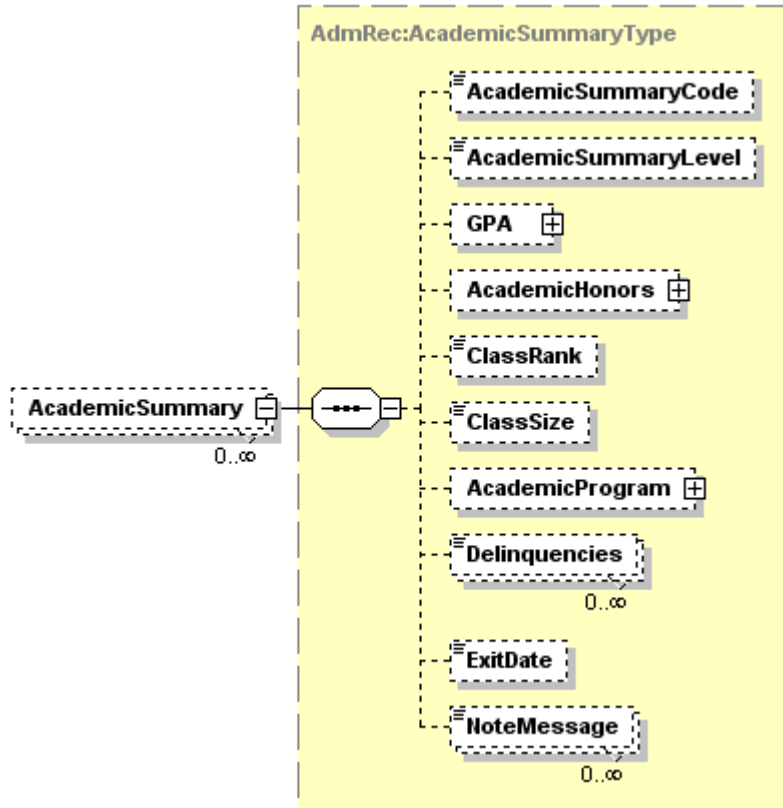

Tag Name	Schema Use	Description	Recommended Use	Format
AcademicSummaryCode	Optional	<p>Academic summary type is an indication of what is being summarized over what period of time.</p> <p>AcademicRenewal - Subset of forgiven courses</p> <p>All - Summary of all courses regardless of institution</p> <p>AllNotRepeated - Summary of all courses except for repeated or forgiven courses/credits</p> <p>CarryoverCredit - Summary from offline records and used as the initial point for cumulatives and averages</p> <p>ConvertedFrom - Summary of credits before an institutional term-basis conversion, such as from quarters to semesters</p> <p>ConvertedTo - Summary of credits after an institutional term-basis</p>	Recommended	<p>minOcc 0 maxOcc 1</p> <p>Enumerations: AcademicRenewal All AllNotRepeated CarryoverCredit ConvertedFrom ConvertedTo Cumulative DegreeApplicable NonDegreeApplicable NonWeighted SenderNotRepeated SenderOnly TransferNotRepeated TransferOnly UserDefined Weighted</p>

PESC XML Application for Admission Implementation Guide

Version 1.3.0

Tag Name	Schema Use	Description	Recommended Use	Format
		<p>conversion, such as from quarters to semesters</p> <p>Cumulative – Summary of all credits up to and including the specified session</p> <p>DegreeApplicable - Summary of course that apply to degree</p> <p>NonDegreeApplicable - Summary of courses that do not apply toward degree</p> <p>NonWeighted – No additional weight was given to various special types of instruction, such as honors or InternationalBaccalaureate courses</p> <p>SenderNotRepeated - Summary of all courses at sending institution except for repeated or forgiven courses/credits</p> <p>SenderOnly - Summary of all courses taken (or recorded as if they were taken) at the institution being reported</p> <p>TransferNotRepeated - Summary of transfer work except for repeated or forgiven courses/credits</p> <p>TransferOnly - Summary of transfer work (courses taken at other than the sending institution)</p> <p>UserDefined - see NoteMessage for explanation</p> <p>Weighted – Includes additional grade points for honors courses, International Baccalaureate, etc. courses</p>		
<p>Comment: DegreeApplicable seems to be the only appropriate value in this context.</p>				
AcademicSummaryLevel	Optional	The level of credit associated with the credit hours earned for the course.	Not Recommended	<p>minOcc 0 maxOcc 1</p> <p>Enumerations: Dual DualGraduateUndergraduate DualHighSchoolCollege EighthGrade EleventhGrade Graduate GraduateProfessional LowerDivision Professional NinthGrade Secondary SeventhGrade TechnicalPreparatory TenthGrade TwelfthGrade Undergraduate UpperDivision Vocational</p>
GPA	Optional	Grade point average for this academic award	Recommended	<p>minOcc 0 maxOcc 1</p>
<p>Comment: This complex data element will be expanded on page 364.</p>				

PESC XML Application for Admission Implementation Guide

Version 1.3.0

Tag Name	Schema Use	Description	Recommended Use	Format
AcademicHonors	Optional	Honors earned with this academic award	Recommended	minOcc 0 maxOcc 1
Comment: This complex data element will be expanded on page 366.				
ClassRank	Optional	The student's class rank relative to other students in the academic cohort (e.g., graduating class).	Not Recommended	minOcc 0 maxOcc 1 minInclusive 1 maxInclusive 9999
Comment: The class rank typically reported is the one associated with the student's entire record at the school, not with just the other graduates in the class. If included, the top student in the class would be assigned the class rank of "1". Class rank is rarely given for postsecondary work.				
ClassSize	Optional	The numeric size of the academic cohort (or size of the graduating class)	Not Recommended	minOcc 0 maxOcc 1 minInclusive 1 maxInclusive 9999
AcademicProgram	Optional	Academic programs related to this academic summary	Not Recommended	minOcc 0 maxOcc 1
Delinquencies	Optional Repeatable	Information about the applicant's good standing at the school	Optional	minOcc 0 maxOcc ∞ Enumerations: ExclusionAcademic ExclusionDiscipline GoodStanding Other ProbationDiscipline ProbationGPA ProbationHours SuspensionDiscipline SuspensionGPA SuspensionHours Unknown
Comment: In general, probation is a temporary (and not well defined among various schools and states or provinces) status and does not preclude continued enrollment. Suspension, in general, means a temporary period on non-enrollment at the school. Suspension generally includes a date when enrollment may be resumed. Exclusion (or dismissal) is more serious and usually means that re-enrollment is not possible without a petition process.				
ExitDate	Optional	The date the applicant last attended that school	Optional	minOcc 0 maxOcc 1 Date format is cyy-mm-dd
NoteMessage	Optional	Additional information about the academic summary	Not Recommended	minOcc 0 maxOcc 1 minLength 1 maxLength 80
Comment: While academic award programs and summaries can be communicated in several different data elements in this schema, it is recommended that they be reported at the highest appropriate level. E.G., use AcademicAward.AcademicAwardProgram to indicate degree major. AcademicAward.AcademicAwardProgram.ProgramSummary for degree major GPA and honors; AcademicAward.AcademicSummary for degree GPA and honors.				

PESC XML Application for Admission Implementation Guide Version 1.3.0

Applicant.SelfReportedAcademicRecord.AcademicSummary (Continued)

Code illustration:

```
<AcademicSummary>
  <AcademicSummaryCode>DegreeApplicable</AcademicSummaryCode>
  <AcademicSummaryLevel>Undergraduate</AcademicSummaryLevel>
  <GPA>

  </GPA>
  <AcademicHonors>

  </AcademicHonors>
  <ClassRank>35</ClassRank>
  <ClassSize>257</ClassSize>
  <AcademicProgram/>
  <Delinquencies>SuspensionGPA</Delinquencies>
  <ExitDate>2007-12-15</ExitDate>
  <NoteMessage/>
</AcademicSummary>
```

PESC XML Application for Admission Implementation Guide Version 1.3.0

Applicant.SelfReportedAcademicRecord.AcademicSummary.GPA

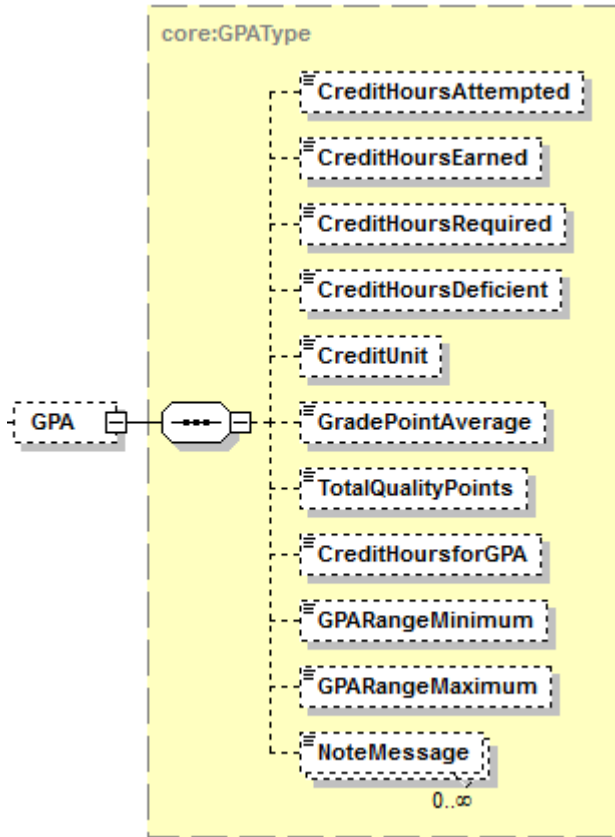

Tag Name	Schema Use	Description	Recommended Use	Format
CreditHoursAttempted	Optional	The total value of credit hours attempted whether or not included in the hours for GPA or hours earned	Recommended	minOcc 0 maxOcc 1 xs:decimal
Comment: For example, a student who attempted 128 semester credits for this award would show "128" as the value in this data element.				
CreditHoursEarned	Optional	The total value of credit hours successfully completed or earned	Recommended	minOcc 0 maxOcc 1 xs:decimal
CreditHoursRequired	Optional	The total value of credit hours required for this academic summary	Not Recommended	minOcc 0 maxOcc 1 xs:decimal
CreditHoursDeficient	Optional	The total value of credit hours deficient for this academic summary	Not Recommended	minOcc 0 maxOcc 1 xs:decimal

PESC XML Application for Admission Implementation Guide

Version 1.3.0

Tag Name	Schema Use	Description	Recommended Use	Format
CreditUnit	Optional	The type of credit (unit, semester, or quarter) associated with the credit hours earned for the course	Recommended	minOcc 0 maxOcc 1 Enumerations: CarnegieUnits ClockHours ContinuingEducationUnits NoCredit Other Quarter Semester Units Unreported
GradePointAverage	Optional	The value of the total quality points divided by the credit hours used for the grade point average	Recommended	minOcc 0 maxOcc 1 xs:decimal
TotalQualityPoints	Optional	The total value of quality points used for the calculation of the grade point average.	Recommended	minOcc 0 maxOcc 1 xs:decimal
CreditHoursforGPA	Optional	The total value of credit hours included in the grade point average calculation	Recommended	minOcc 0 maxOcc 1 xs:decimal
GPARangeMinimum	Optional	The lowest possible grade point average that can be earned by the student	Recommended	minOcc 0 maxOcc 1 xs:decimal
GPARangeMaximum	Optional	The highest possible grade point average that can be earned by the student	Recommended	minOcc 0 maxOcc 1 xs:decimal
NoteMessage	Optional Repeatable	Additional information about the grade point average	Not recommended	minOcc 0 maxOcc ∞ minLength 1 maxLength 80

Code illustration:

```

<GPA>
  <CreditHoursAttempted>150</CreditHoursAttempted>
  <CreditHoursEarned>128</CreditHoursEarned>
  <CreditHoursRequired/>
  <CreditHoursDeficient/>
  <CreditUnit>Semester</CreditUnit>
  <GradePointAverage>3.53</GradePointAverage>
  <TotalQualityPoints>466</TotalQualityPoints>
  <CreditHoursforGPA>132</CreditHoursforGPA>
  <GPARangeMinimum>0</GPARangeMinimum>
  <GPARangeMaximum>4</GPARangeMaximum>
  <NoteMessage/>
</GPA>

```

PESC XML Application for Admission Implementation Guide Version 1.3.0

Applicant.SelfReportedAcademicRecord.AcademicSummary. AcademicHonors

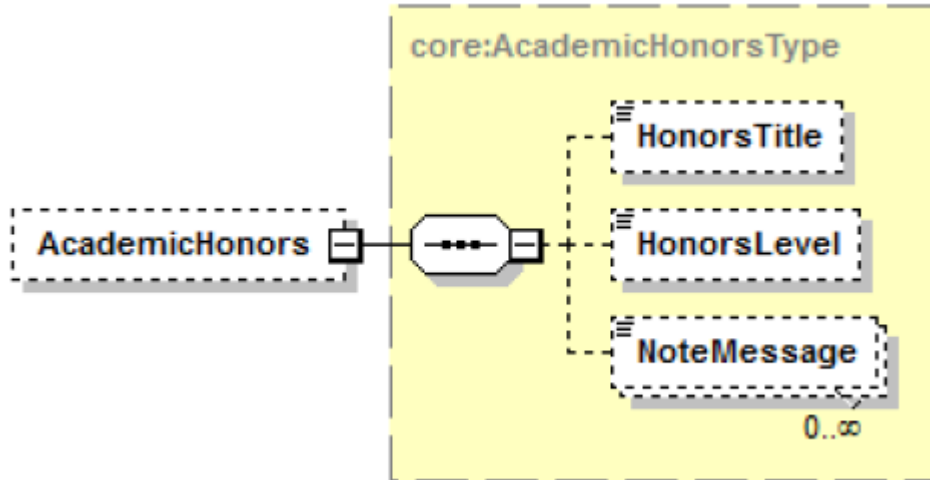

Tag Name	Schema Use	Description	Recommended Use	Format
HonorsTitle	Optional	The descriptive title for the honors received	Optional	minOcc 0 maxOcc 1 minLength 1 maxLength 30
HonorsLevel	Optional	A code value representing 1st highest honor, 2nd highest and 3rd highest.	Optional	minOcc 0 maxOcc 1 Enumerations: FirstHighest SecondHighest ThirdHighest
NoteMessage	Optional Repeatable	Additional information about the URL address of the source institution	Not recommended	minOcc 0 maxOcc ∞ minLength 1 maxLength 80

Code illustration:

```

<AcademicHonors>
  <HonorsTitle>Cum Laude</HonorsTitle>
  <HonorsLevel>ThirdHighest</HonorsLevel>
  <NoteMessage/>
</AcademicHonors>

```

PESC XML Application for Admission Implementation Guide Version 1.3.0

Applicant.SelfReportedAcademicRecord.AcademicSession

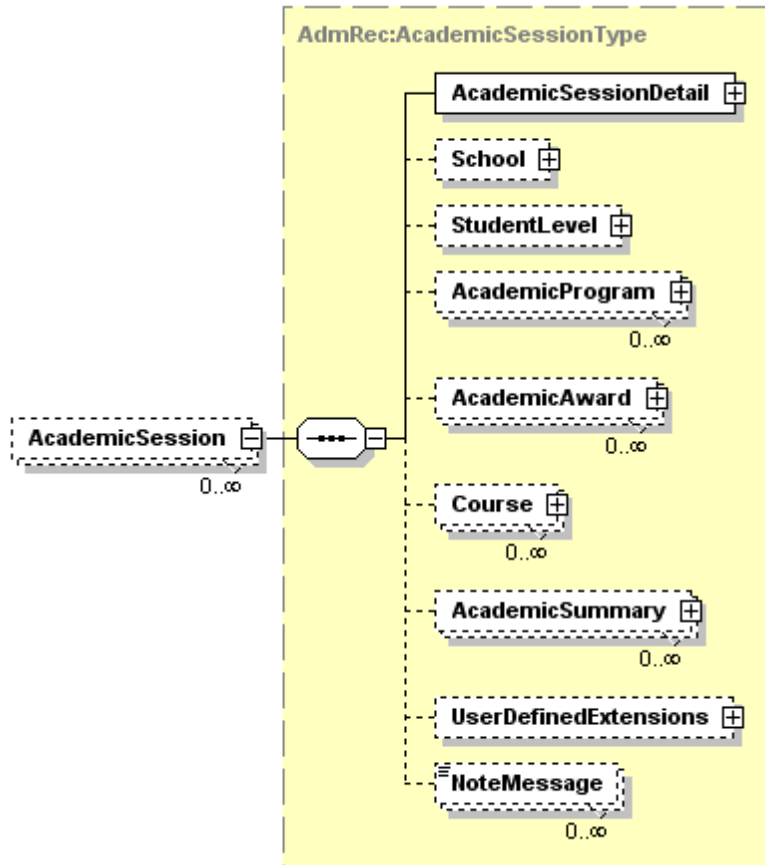

Tag Name	Schema Use	Description	Recommended Use	Format
AcademicSessionDetail	Required	Information identifying the time period of the beginning of this session	Required	minOcc 1 maxOcc 1
Comment: This complex data element will be expanded on page 369.				
School	Optional	Override school	Not Recommended	minOcc 0 maxOcc 1
Comment: This data element would not typically be used in the application for admission, since it would be unusual to ask for the information in this manner on the application for admission. To see the expansion of this data element, go to Applicant.SelfReportedAcademicRecord.School on page 329 earlier in this Guide.				
StudentLevel	Optional	An indication of the classification of the student at the time of this academic session	Optional	minOcc 0 maxOcc 1
Comment: This complex data element will be expanded on page 371.				
AcademicProgram	Optional Repeatable	The major or degree objectives for the student at the time of this session	Optional	minOcc 0 maxOcc ∞
Comment: This complex data element will be expanded on page 372.				

PESC XML Application for Admission Implementation Guide

Version 1.3.0

Tag Name	Schema Use	Description	Recommended Use	Format
AcademicAward	Optional Repeatable	Academic awards associated with or granted during or at the end of this session	Not Recommended	minOcc 0 maxOcc ∞
Comment: It is recommended that any awards granted by the institution should be reported under Applicant.Application.SelfReportedAcademicRecord. If the applicant is allowed to report them under the session in which the award was made, then the expansion of this data element may be found on page 345 which appears earlier in this Guide.				
Course	Optional Repeatable	Courses associated with this session	Recommended	minOcc 0 maxOcc ∞
Comment: This complex data element will be expanded on page 376.				
AcademicSummary	Optional Repeatable	Academic summary for this session	Optional	minOcc 0 maxOcc ∞
Comment: This complex data element will be expanded on page 393.				
UserDefinedExtensions	Optional	Additional information about the Academic Session that has been put into a mini schema. It is intended for use within a predetermined state or region.	Not recommended	minOcc 0 maxOcc 1
Comment: The use of a mini-schema called UserDefinedExtensions can be helpful to a specific group of users who would like to include coded data that is pre-defined and can be interpreted by the recipient of the instance document. Others not in that group would simply ignore the UDE.				
NoteMessage	Optional	Additional information about the academic session	Not Recommended	minOcc 0 maxOcc ∞ minLength 1 maxLength 80
Comment: This entire section would not typically be used for the application for admission. It could be used if the application asked the applicant to specify the courses in which the student is currently enrolled or courses the student plans to take in a future term.				

Code illustration:

```

<AcademicSession>
  <AcademicSessionDetail>

    /AcademicSessionDetail>
    <School>

    </School>
    <StudentLevel>

    </StudentLevel>
    <AcademicProgram>

    </AcademicProgram>
    <AcademicAward>

    </AcademicAward>
    <Course>

    </Course>
    <AcademicSummary>

    </AcademicSummary>
    <UserDefinedExtensions/>
    <NoteMessage/>
  </AcademicSession>

```

PESC XML Application for Admission Implementation Guide Version 1.3.0

Applicant.SelfReportedAcademicRecord.AcademicSession. AcademicSessionDetail

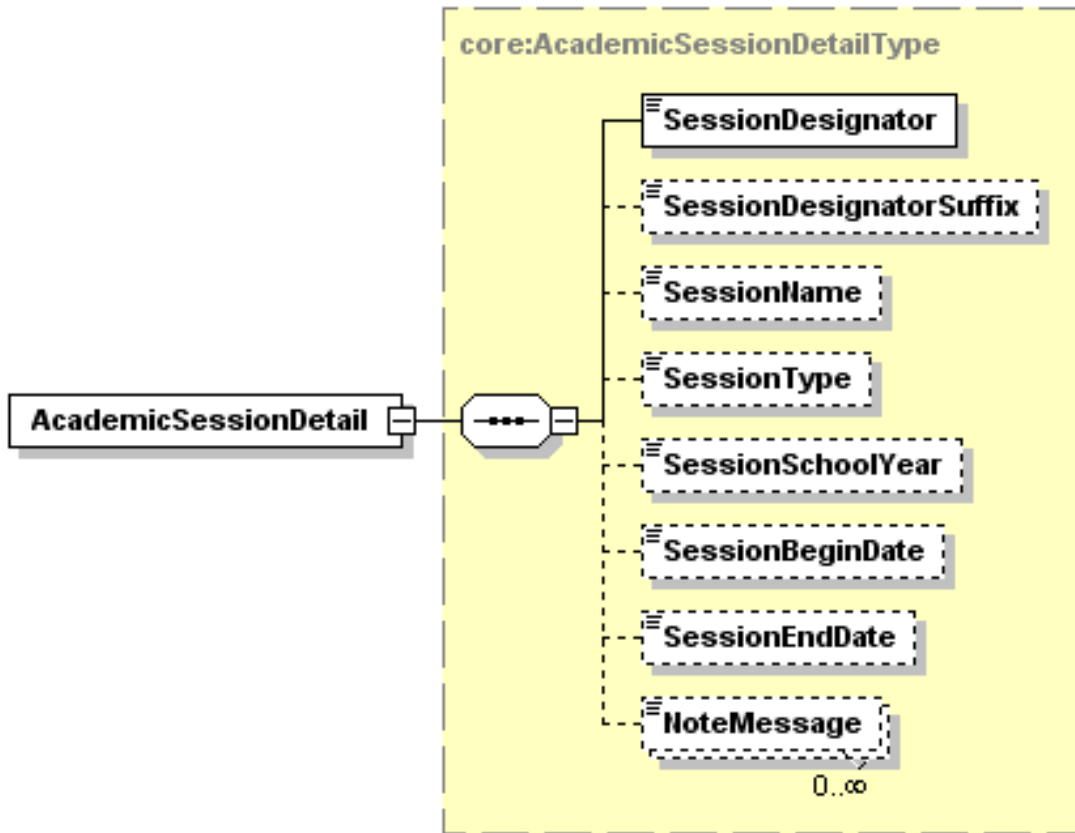

Tag Name	Schema Use	Description	Recommended Use	Format
SessionDesignator	Required	The academic session for which the data are recorded and applicable	Required	minOcc 1 maxOcc 1 Year and month as ccyy-mm
Comment: This data element is used to group all courses and other activities and awards in a typical main session. For example, a student may take courses that begin on the same date as the main session (fall semester, for example), but may also take one or more courses that are considered to be in the same major term (fall semester, for example) but begin a week or two or more later. However, they are all considered to a part of the main term or session.				
SessionDesignatorSuffix	Optional	A free form extension to the session designator to differentiate discrete sub-sessions within the same major term	Optional	minOcc 0 maxOcc 1 minLength 1 maxLength 10
SessionName	Optional	Free-form name of the session	Recommended	minOcc 1 maxOcc 1 minLength 1 maxLength 30
Comment: For example, Fall Semester 2002, or Fall Semester 2003-2004.				

PESC XML Application for Admission Implementation Guide

Version 1.3.0

Tag Name	Schema Use	Description	Recommended Use	Format
SessionType	Optional	Indicates the type of academic session at an educational institution	Recommended	minOcc 1 maxOcc 1 Enumerations: Continuous DiffersByProgram FallSession FourOneFourPlan FullYear Intersession LongSession MiniTerm Other Quarter Quinmester Semester SummerSession Trimester TwelveMonth
Comment: This is the type of calendar used at the school. It does not refer to the type of units of credit awarded. If the value "Other" is included, then it should be explained in a note message.				
SessionSchoolYear	Optional	The years included in the school year	Optional	minOcc 0 maxOcc 1 The format is ccyy-ccyy
SessionBeginDate	Optional	Actual calendar date when session begins	Optional	minOcc 0 maxOcc 1 xs:date with format ccyy-mm-dd
SessionEndDate	Optional	Actual calendar date when session ends	Recommended	minOcc 0 maxOcc 1 xs:date with format ccyy-mm-dd
NoteMessage	Optional Repeatable	Additional information about the academic session detail	Not recommended	minOcc 0 maxOcc ∞ minLength 1 maxLength 80

Code illustration:

```

<AcademicSessionDetail>
  <SessionDesignator>1985-09</SessionDesignator>
  <SessionDesignatorSuffix>1</SessionDesignatorSuffix>
  <SessionName>Fall Semester 1985</SessionName>
  <SessionType>Semester</SessionType>
  <SessionSchoolYear/>
  <SessionBeginDate>1985-09-23</SessionBeginDate>
  <SessionEndDate>1985-12-20</SessionEndDate>
  <NoteMessage/>
</AcademicSessionDetail>

```

PESC XML Application for Admission Implementation Guide Version 1.3.0

Applicant.SelfReportedAcademicRecord.AcademicSession. StudentLevel

Note: If you choose to include the optional StudentLevel, then you must include the StudentLevelCode.

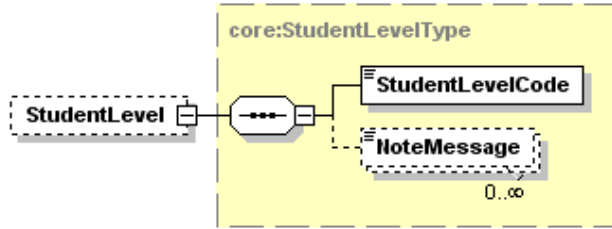

Tag Name	Schema Use	Description	Recommended Use	Format
StudentLevelCode	Required	The level of the student at the school	Required	minOcc 1 maxOcc 1 Enumerations: CollegeFifthYear CollegeFirstYear CollegeFirstYearAttendedBefore CollegeJunior CollegeSenior CollegeSophomore Doctoral EighthGrade EleventhGrade GraduateBeyondThirdYear GraduateFirstYear GraduateNonDegree GraduateSecondYear GraduateThirdYear Masters MastersQualifying NinthGrade NonDegree PostBaccalaureate Postdoctoral Postsecondary PostsecondaryBachelorPreliminaryYear Professional ProfessionalBeyondThirdYear ProfessionalFirstYear ProfessionalSecondYear ProfessionalThirdYear SeventhGrade TenthGrade TwelfthGrade NoFormalSchool
Comment: The Student Level Code is required only if the complex data element Student Level is included in the instance document.				
NoteMessage	Optional	Additional information about the level of the student	Not Recommended	minOcc 1 maxOcc ∞ minLength 1 maxLength 80

Code illustration:

```
<StudentLevel>
  <StudentLevelCode>Masters</StudentLevelCode>
  <NoteMessage/>
</StudentLevel>
```

PESC XML Application for Admission Implementation Guide Version 1.3.0

</StudentLevel>

PESC XML Application for Admission Implementation Guide Version 1.3.0

Applicant.SelfReportedAcademicRecord.AcademicSession. AcademicProgram

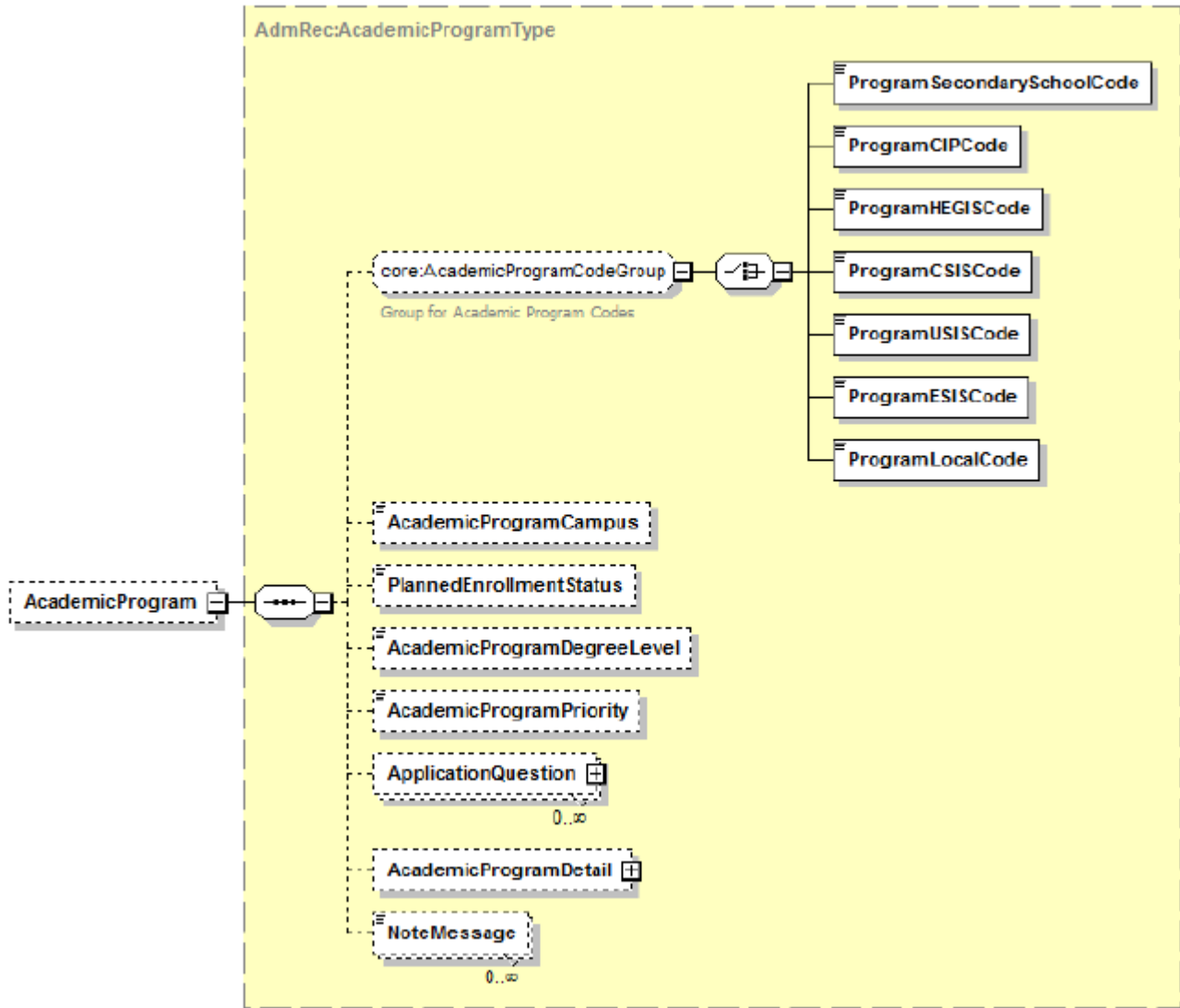

Tag Name	Schema Use	Description	Recommended Use	Format
ProgramSecondarySchoolCode	Optional exclusive choice	Code indicating a discipline or field of study pursued in a secondary school	Optional Choice	minOcc 0 maxOcc 1 Enumerations: CareerPrep CollegePrep CollegePrepOrCollegeTechPrep CollegeTechPrep General Occupational Vocational
Comment: For describing the program taken at a secondary school, this is probably the only appropriate choice.				
ProgramCIPCode	Optional exclusive choice	Code indicating a discipline or field of study assigned by the Classification of Instructional Programs	Recommended Choice	minOcc 0 maxOcc 1 minLength 6 maxLength 20

PESC XML Application for Admission Implementation Guide

Version 1.3.0

Tag Name	Schema Use	Description	Recommended Use	Format
ProgramHEGISCode	Optional exclusive choice	Code indicating a discipline or field of study assigned by Higher Education General Information Survey	Not Recommended	minOcc 0 maxOcc 1 minLength 6 maxLength 20
ProgramCSISCode	Optional exclusive choice	Code indicating a discipline or field of study assigned by Statistics Canada Canadian College Student Information System	Not Recommended	minOcc 0 maxOcc 1 minLength 5 maxLength 5
ProgramUSISCode	Optional exclusive choice	Code indicating a discipline or field of study assigned by the Statistics Canada University Student Information System.	Not Recommended	minOcc 0 maxOcc 1 minLength 5 maxLength 5
ProgramESISCode	Optional exclusive choice	Code indicating a discipline or field of study assigned by the Statistics Canada Enhanced Student Information System.	Not Recommended	minOcc 0 maxOcc 1 minLength 1 maxLength 20
ProgramLocalCode	Optional exclusive choice	Code indicating a the specific program (with options, if any) that the student selects from a list of available programs	Optional	minOcc 0 maxOcc 1 minLength 1 maxLength 20
<p>Comment: Although the above 7 choices for program codes are optional, the second choice is probably the most appropriate to describe the specific academic programs at the specific postsecondary school which the applicant previously attended. For attendance at Canadian postsecondary schools, one of the three Canadian code sets would be the first choice if this optional data element were to be included.</p>				
AcademicProgramCampus	Optional	The preferred campus specified by the applicant for this particular program.	Optional	minOcc 0 maxOcc 1 minLength 0 maxLength 60
PlannedEnrollmentStatus	Optional	The planned full-time or part-time enrollment status of the applicant	Not Recommended	minOcc 0 maxOcc 1 Enumerations: FullTime PartTime
AcademicProgramDegreeLevel	Optional	The level of the degree for which the applicant is applying	Optional	minOcc 0 maxOcc 1 Enumerations: AssociateDegree BaccalaureateDegree Certificate Doctorate GraduateDegree HighSchool MastersDegree NonDegree PostSecondaryDiploma ProfessionalDegree
AcademicProgramPriority	Optional	The priority ranking for this program with relation to other programs requested in the application for admission (First, second, etc.)	Not Recommended	minOcc 0 maxOcc 1
<p>Comment: If this is the only program for which the person is applying, then this data element would not be included in the instance document. If, however, the student was submitting a first (and other choices) of term, program, or campus, then the first choice would be indicated with a "1", the second choice with a "2", etc.</p>				
ApplicationQuestion	Optional Repeatable	Specific questions that are typically appropriate for a limited number of schools	Not Recommended	minOcc 0 maxOcc 1

PESC XML Application for Admission Implementation Guide

Version 1.3.0

Tag Name	Schema Use	Description	Recommended Use	Format
AcademicProgramDetail	Optional	More specific information about the program in which the applicant was previously enrolled	Optional	minOcc 0 maxOcc 1
Comment: This complex data element will be expanded on page 375 which follows.				
NoteMessage	Optional Repeatable	Additional information about the Academic Program for which the applicant is applying	Not Recommended	minOcc 0 maxOcc ∞ minLength 1 maxLength 80

Applicant.SelfReportedAcademicRecord.AcademicSession.AcademicProgram (Continued)

Code illustration:

```

<AcademicProgram>
  <ProgramLocalCode>BA Music</ProgramLocalCode>
  <AcademicProgramCampus>Main</AcademicProgramCampus>
  <PlannedEnrollmentStatus/>
  <AcademicProgramDegreeLevel>BaccalaureateDegree</AcademicProgramDegreeLevel>
  <AcademicProgramPriority/>
  <ApplicationQuestion/>
  <ApplicationProgramDetail>
    </ApplicationProgramDetail>
  <NoteMessage/>
</AcademicProgram>

```

PESC XML Application for Admission Implementation Guide Version 1.3.0

Applicant.SelfReportedAcademicRecord.AcademicSession. AcademicProgram.AcademicProgramDetail

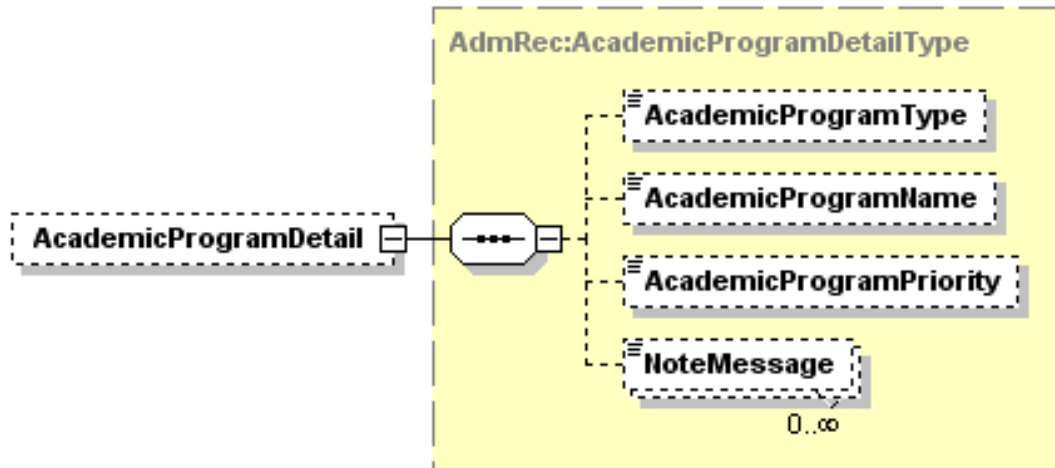

Tag Name	Schema Use	Description	Recommended Use	Format
AcademicProgramType	Optional	The specific category of the academic program for which the person is applying	Optional	minOcc 0 maxOcc 1 Enumerations: Concentration Focus Major Minor SecondMajor Specialization
AcademicProgramName	Optional	The specific name of the academic program for which the person is applying	Optional	minOcc 0 maxOcc 1 minLength 1 maxLength 60
AcademicProgramPriority	Optional	The priority that the applicant has given this particular program among all the programs to which the applicant is applying	Optional	minOcc 1 maxOcc 1 Data type is an integer
Comment: <i>If the applicant has applied for six programs and this program is the second choice, then this value would be "2".</i>				
NoteMessage	Optional	Additional information about the details of the Academic Program	Not Recommended	minOcc 0 maxOcc ∞ minLength 1 maxLength 80

Code illustration:

```
<AcademicProgramDetail>
  <AcademicProgramType>Major</AcademicProgramType>
  <AcademicProgramName>Bachelor of Fine Arts</AcademicProgramName>
  <AcademicProgramPriority/>
  <NoteMessage/>
</AcademicProgramDetail>
```

PESC XML Application for Admission Implementation Guide Version 1.3.0

Applicant.SelfReportedAcademicRecord.AcademicSession.Course

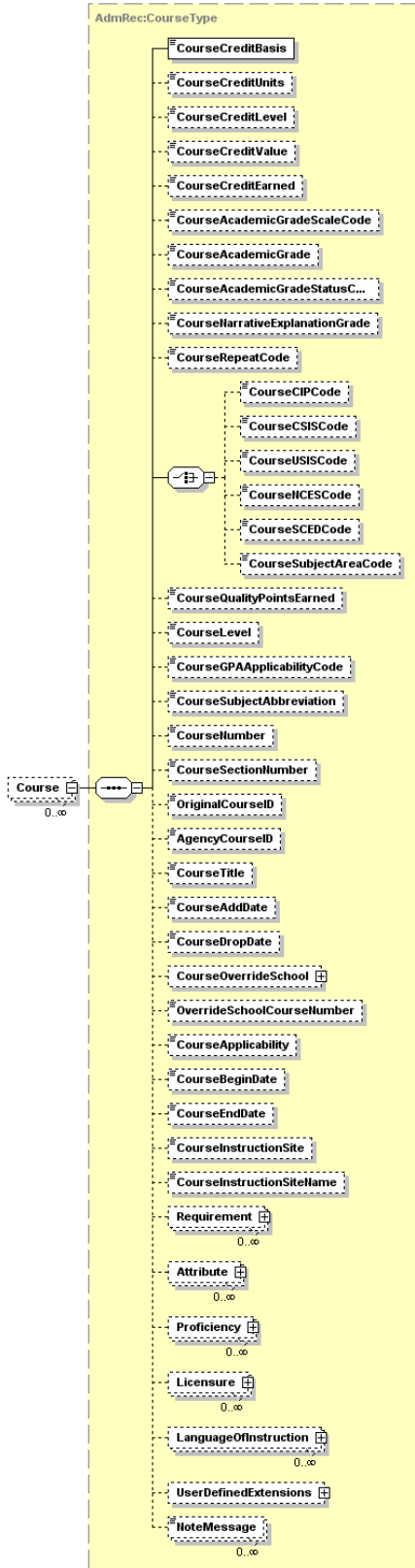

PESC XML Application for Admission Implementation Guide Version 1.3.0

Applicant.SelfReportedAcademicRecord.AcademicSession.Course (Continued)

Tag Name	Schema Use	Description	Recommended Use	Format
CourseCreditBasis	Required	The type of enrollment associated with the credit hours for the course	Required	minOcc 1 maxOcc 1 Enumerations: AcademicRenewal AdultBasic AdvancedPlacement AdvancedStanding ContinuingEducation CreditByExam Equivalence Exemption HighSchoolCreditOnly HighSchoolDualCredit HighSchoolTransferCredit InternationalBaccalaureate JuniorHighSchoolCredit Major Military Regular Remedial LifeExperience
CourseCreditUnits	Optional	The type of credit (unit, semester, or quarter) associated with the credit hours earned for the course	Recommended	minOcc 0 maxOcc 1 Enumerations: CarnegieUnits ClockHours ContinuingEducationUnits NoCredit Other Quarter Semester Units Unreported
CourseCreditLevel	Optional	The level of credit associated with the credit hours earned for the course	Recommended	minOcc 0 maxOcc 1 Enumerations: Dual DualGraduateUndergraduate DualHighSchoolCollege EighthGrade EleventhGrade Graduate GraduateProfessional LowerDivision Professional NinthGrade Secondary SeventhGrade TechnicalPreparatory TenthGrade TwelfthGrade Undergraduate UpperDivision Vocational
Comment: Usually the same as CourseLevel; differs when the student uses the credit at a level different from the CourseLevel, e.g., when the student uses an UpperDivision course (CourseLevel) for graduate credit (CourseCreditLevel).				

PESC XML Application for Admission Implementation Guide

Version 1.3.0

Tag Name	Schema Use	Description	Recommended Use	Format
CourseCreditValue	Optional	Number indicating the credit hours that may be earned in the course.	Recommended	minOcc 0 maxOcc 1 xs:decimal
Comment: If the student makes a passing grade in the course, then this same value will also appear in the CourseCreditEarned. However, if the student makes an incomplete or withdrawal grade, then this is the only place to determine the number of credits that the course was worth.				
CourseCreditEarned	Optional	The number of credits a student earns by the successful completion of the course	Recommended	minOcc 0 maxOcc 1 xs:decimal
CourseAcademicGradeScaleCode	Optional	The grading scale used by an academic educational institution for an academic course	Recommended	minOcc 0 maxOcc 1 minLength 1 maxLength 3 See Appendix Q for code values
Comment: Grade scale code is based on the American Medical Colleges Admissions Services (AMCAS) grade scale.				
CourseAcademicGrade	Optional	The final grade awarded for participation in the course	Recommended	minOcc 0 maxOcc 1 minLength 1 maxLength 10
CourseAcademicGradeStatusCode	Optional	The final grade awarded for participation in the course if it is not included in the CourseAcademicGradeScaleCode	Recommended	minOcc 0 maxOcc 1 Enumerations: AuditedCourse HonorsGrade Incomplete IncompleteNotResolvedFail InProgress NotYetReported OtherFail OtherPass PassFailFail PassFailPass TransferNoGrade Withdraw WithdrawFailing WithdrawNoPenalty WithdrawPassing Completed PlanningToTake
CourseNarrativeExplanationGrade	Optional	The narrative of the grade awarded to a student in an academic course in those cases where a course does not receive a letter or numeric grade included in the grading scale of the Course Academic Grade Scale Code	Not Recommended	minOcc 0 maxOcc 1 minLength 1 maxLength 200
CourseRepeatCode	Optional	Indicates that an academic course has been repeated by a student and how that repeat is to be computed in the student's academic grade point average	Recommended	minOcc 0 maxOcc 1 Enumerations: NotCountedOther RepeatCounted RepeatNotCounted RepeatOtherInstitution ReplacedNotCounted ReplacementCounted
CourseCIPCode	Optional Choice Choose one	The Classification of Instructional Programs (CIP) code to describe the area of study for the course	Optional Choose one	minOcc 0 maxOcc 1 minLength 1 maxLength 10

PESC XML Application for Admission Implementation Guide

Version 1.3.0

Tag Name	Schema Use	Description	Recommended Use	Format
CourseCSISCode	Optional Choice Choose one	The Statistics Canada Canadian College Student Information System (CSIS) code to describe the area of study for a course	Optional Choose one	minOcc 0 maxOcc 1 minLength 1 maxLength 10
CourseUSISCode	Optional Choice Choose one	The Classification of Instructional Programs (CIP) code to describe the area of study for the course	Optional Choose one	minOcc 0 maxOcc 1 minLength 1 maxLength 10
CourseNCESCode	Optional Choice Choose one	The code set developed by the US Department of Education's National Center for Education Statistics (NCES) to describe the content of K12 courses.	Optional Choose one	minOcc 0 maxOcc 1 minLength 1 maxLength 10
CourseSCEDCode	Optional Choice Choose one	The US Department of Education's National Center for Education Statistics (NCES) School Codes for the Exchange of Data (SCED) is a code to describe the area of study for the course	Optional Choose one	minOcc 0 maxOcc 1 minLength 12 maxLength 12
CourseSubjectAreaCode	Optional Choice Choose one	This is a subset of the US Department of Education's National Center for Education Statistics (NCES) School Codes for the Exchange of Data (SCED). It is a code to describe the major area of study for the course	Optional Choose one	minOcc 0 maxOcc 1 Enumerations: EnglishLanguageLiterature Mathematics LifePhysicalSciences SocialSciencesHistory FinePerformingArts ForeignLanguageLiterature ReligiousEducationTheology PhysicalHealthSafetyEducation MilitaryScience ComputerInformationSciences CommunicationsAudioVisualTechnology BusinessMarketing Manufacturing HealthCareSciences PublicProtectiveGovernmentService HospitalityTourism ArchitectureConstruction AgricultureFoodNaturalResources HumanServices TransportationDistributionLogistics EngineeringTechnology Miscellaneous SpecialExceptionalEducationServices

PESC XML Application for Admission Implementation Guide

Version 1.3.0

Tag Name	Schema Use	Description	Recommended Use	Format
CourseQualityPointsEarned	Optional	The numerical value assigned to a letter grade to provide a basis of quantitative determination of an average	Optional Choose one	minOcc 0 maxOcc 1 xs:decimal
<p>Comment: The number of quality points is the product of the credit value of the course and the number of points associated with the grade earned. For example, a student who earned a grade of "B" in a four credit course would earn 3 (worth of a B) times 4 (worth of the course) or 12 course quality points.</p>				
CourseLevel	Optional	The level of work which is reflected in the credits associated with the academic course being described or the level of the typical student taking the academic course	Recommended	minOcc 0 maxOcc 1 Enumerations: Accelerated AdultBasic AdvancedPlacement Basic CollegeLevel CollegePreparatory Dual GiftedTalented GraduateProfessional Honors InternationalBaccalaureate LowerDivision NonAcademic Regents Remedial SpecialEducation TechnicalPreparatory UpperDivision Vocational
CourseGPAApPLICabilityCode	Optional	The manner in which the grade is computed in the GPA calculation	Recommended	minOcc 0 maxOcc 1 Enumerations: Applicable NotApplicable Weighted
CourseSubjectAbbreviation	Optional	The alphabetic abbreviation of the academic department or discipline offering the course. It is typically one part of the total course identifier number.	Recommended	minOcc 0 maxOcc 1 minLength 1 maxLength 10
CourseNumber	Optional	The official reference number portion of a course identifier. This number normally designates the level of the course as well as the level of the student expected to enroll.	Recommended	minOcc 0 maxOcc 1 minLength 1 maxLength 15
<p>Comment: Most schools use a combination of the Course Subject Abbreviation and the Course Number to identify an academic course. However, not every school uses both. So for schools that use only an abbreviation or only a number, it is quite typical to use the two data elements to identify a course. So, for a course that has a course number of "223344556677", it is OK to put the first 10 numbers in the CourseSubjectAbbreviation data element and the last two numbers in the CourseNumber data element.</p>				
CourseSectionNumber	Optional	The number assigned to differentiate among distinct occurrences of courses that have the same abbreviation and number but are considered to be different courses.	Optional	minOcc 0 maxOcc 1 minLength 1 maxLength 10
OriginalCourseID	Optional	The course ID as it was listed when the credit was earned (e.g., before a system conversion) to show consistency between present transcripts and older ones	Recommended	minOcc 0 maxOcc 1 minLength 1 maxLength 30

PESC XML Application for Admission Implementation Guide

Version 1.3.0

Tag Name	Schema Use	Description	Recommended Use	Format
AgencyCourseID	Optional	The identifying number of the course assigned by a state or other agency	Recommended	minOcc 0 maxOcc 1 minLength 1 maxLength 30
CourseTitle	Optional	The name or title of the course taken by a student at an academic institution	Recommended	minOcc 0 maxOcc 1 minLength 1 maxLength 60
CourseAddDate	Optional	The date a student enrolled in or added an academic course at a school	Optional	minOcc 0 maxOcc 1 xs:date where the format is ccy-mm-dd
CourseDropDate	Optional	The date on which the student dropped or withdrew from the course	Optional	minOcc 0 maxOcc 1 xs:date where the format is ccy-mm-dd
CourseOverrideSchool	Optional	The school where the credit was earned if different from the academic session school	Not Recommended	minOcc 0 maxOcc 1
Comment: It would be quite unusual to get this amount of detail about the school (other than the primary school attended in a session) offering a course that the student self-reported. If this amount of detail is required, you may see the expansion of this complex data element under Applicant.SelfReportedAcademicRecord.School on page 284 of this Guide.				
OverrideSchoolCourseNumber	Optional	The course ID as it was listed at the school where the credit was earned	Conditional	minOcc 0 maxOcc 1 minLength 1 maxLength 35
Comment: CourseOverrideSchool and OverrideSchoolCourseNumber are normally used for situations like consortiums, concurrent enrollment or transfer courses, although transfer work is recommended to be reported in a separate session with an override school.				
CourseApplicability	Optional	The academic program to which this academic course applies toward graduation	Not Recommended	minOcc 0 maxOcc 1 Enumerations: BothPrograms FirstProgram NotApplicable SecondProgram
CourseBeginDate	Optional	The date on which this course began	Optional	minOcc 0 maxOcc 1 xs:date where the format is ccy-mm-dd
CourseEndDate	Optional	The date on which this course ended	Optional	minOcc 0 maxOcc 1 xs:date where the format is ccy-mm-dd
Comment: CourseBeginDate and CourseEndDate are recommended when the dates differ from the session begin and end dates.				
CourseDropDate	Optional	The date on which the student dropped or withdrew from the course	Optional	minOcc 0 maxOcc 1 xs:date where the format is ccy-mm-dd
CourseInstructionSite	Optional	An indication of the type of locataion at which the course is taught	Optional	minOcc 0 maxOcc 1 Enumerations: Auxiliary ClinicHospital Correctional Extension OffCampus OnCampus Military StudyAbroad Telecommunication

PESC XML Application for Admission Implementation Guide

Version 1.3.0

Tag Name	Schema Use	Description	Recommended Use	Format
CourseInstructionSiteName	Optional	The name of the location at which the course is taught	Optional	minOcc 0 maxOcc 1 minLength 1 maxLength 30
Requirement	Optional Repeatable	Curriculum requirements satisfied by successful completion of this course	Optional	minOcc 0 maxOcc ∞
Comment: The workgroup has decided that we will not use this for Additional Student Achievements, but we have not yet addressed this area of the schema for the course. This complex data element will be further expanded on page 384 which follows.				
Attribute	Optional Repeatable	Attributes of this course which may require special handling by the receiving institution	Optional	minOcc 0 maxOcc ∞
Comment: The workgroup has decided that we will not use this for Additional Student Achievements but we have not yet addressed this area of the schema for the course. This complex data element will be further expanded on page 386 which follows.				
Proficiency	Optional Repeatable	Proficiency level signified by successful completion of this course	Optional	minOcc 0 maxOcc ∞
Comment: The workgroup has decided that we will not use this for Additional Student Achievements, but we have not yet addressed this area of the schema for the course. This complex data element will be further expanded on page 388 which follows.				
Licensure	Optional Repeatable	The date on which the student dropped or withdrew from the course	Optional	minOcc 0 maxOcc ∞
Comment: The workgroup has decided that we will not use this for Additional Student Achievements, but we have not yet addressed this area of the schema for the course. This complex data element will be further expanded on page 390 which follows.				
LanguageOfInstruction	Optional Repeatable	Language associated with one or more aspects of the course	Optional	minOcc 0 maxOcc ∞
Comment: This complex data element will be further expanded on page 391 which follows.				
UserDefinedExtensions	Optional	Additional structured information. Requires mutually defined XML schema	Optional	minOcc 0 maxOcc 1
Comment: This complex data element will be further expanded on page 392 which follows.				
NoteMessage	Optional	Additional information about the academic course	Not Recommended	minOcc 0 maxOcc ∞ minLength 1 maxLength 80

Code illustration:

```

<Course>
  <CourseCreditBasis>Regular</CourseCreditBasis>
  <CourseCreditUnits>Semester</CourseCreditUnits>
  <CourseCreditLevel>LowerDivision</CourseCreditLevel>
  <CourseCreditValue>3</CourseCreditValue>
  <CourseCreditEarned>3</CourseCreditEarned>
  <CourseAcademicGradeScaleCode>25</CourseAcademicGradeScaleCode>
  <CourseAcademicGrade>A</CourseAcademicGrade>
  <CourseAcademicGradeStatusCode/>
  <CourseNarrativeExplanationGrade/>
  <CourseRepeatCode>NotCountedOther</CourseRepeatCode>
  <CourseCIPCode>1234567890</CourseCIPCode>
  <CourseQualityPointsEarned>12</CourseQualityPointsEarned>
  <CourseLevel>LowerDivision</CourseLevel>
  <CourseSubjectAbbreviation>HIS</CourseSubjectAbbreviation>
  <CourseNumber>315K</CourseNumber>
  <CourseSectionNumber/>
  <OriginalCourseID>HIST 105</OriginalCourseID>
  <AgencyCourseID/>
  <CourseTitle>HISTORY OF THE US 1</CourseTitle>

```

PESC XML Application for Admission Implementation Guide Version 1.3.0

```
<CourseAddDate>2005-09-01</CourseAddDate>
<CourseDropDate/>
<CourseOverrideSchool>

  </CourseOverrideSchool>
  <OverrideSchoolCourseNumber>HST_26A</OverrideSchoolCourseNumber>
  <CourseApplicability>NotApplicable</CourseApplicability>
  <CourseBeginDate>2005-09-01</CourseBeginDate>
  <CourseEndDate>2005-12-07</CourseEndDate>
  <CourseInstructionSite>OnCampus</CourseInstructionSite>
  <CourseInstructionSiteName>Main Campus</CourseInstructionSiteName>
  <Requirement>

    </Requirement>
    <Attribute>

      </Attribute>
      <Proficiency>

        </Proficiency>
        <Licensure>

          </Licensure>
          <LanguageOfInstruction>

            </LanguageOfInstruction>
            <UserDefinedExtensions/>
            <NoteMessage/>
          </Course>
```

PESC XML Application for Admission Implementation Guide Version 1.3.0

Applicant.SelfReportedAcademicRecord.AcademicSession.Course. Requirement

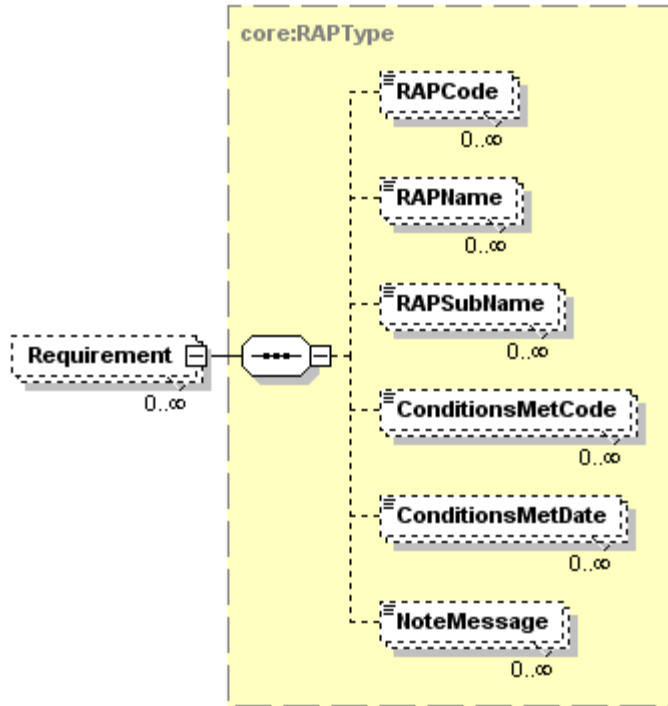

Tag Name	Schema Use	Description	Recommended Use	Format
RAPCode	Optional Repeatable	Requirement demonstrated or earned	Recommended	minOcc 0 maxOcc ∞ minLength 1 maxLength 3
RAPName	Optional Repeatable	Literal name of requirement	Recommended	minOcc 0 maxOcc ∞ minLength 1 maxLength 60
RAPSubName	Required Repeatable	Literal name of subsection of requirement	Optional	minOcc 1 maxOcc ∞ minLength 1 maxLength 60
ConditionsMetCode	Optional Repeatable	Indicates whether and how conditions for certification have been attained	Recommended	minOcc 0 maxOcc ∞ Enumerations: Conditional MutuallyDefined No Yes
ConditionsMetDate	Optional Repeatable	Date of requirement	Optional	minOcc 0 maxOcc ∞ xs:date where format is ccyymm-dd
NoteMessage	Optional Repeatable	Additional information about the Requirement	Optional	minOcc 0 maxOcc ∞ minLength 1 maxLength 80

PESC XML Application for Admission Implementation Guide Version 1.3.0

Applicant.SelfReportedAcademicRecord.AcademicSession.Course. Requirement (Continued)

Code illustration:

```
<Requirement>  
  <RAPCode>9TX</RAPCode>  
  <RAPName>Passed state exam for Spoken English</RAPName>  
  <RAPSubName/>  
  <ConditionsMetCode>Yes</ConditionsMetCode>  
  <ConditionsMetDate>2006-12-15</ConditionsMetDate>  
  <NoteMessage/>  
</Requirement>
```

PESC XML Application for Admission Implementation Guide Version 1.3.0

Applicant.SelfReportedAcademicRecord.AcademicSession.Course. Attribute

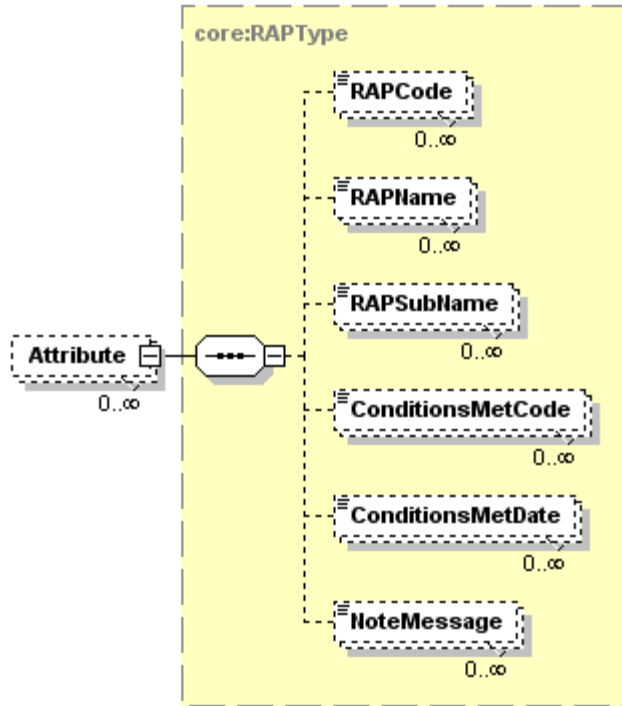

Tag Name	Schema Use	Description	Recommended Use	Format
RAPCode	Optional Repeatable	Attribute demonstrated or earned	Recommended	minOcc 0 maxOcc ∞ minLength 1 maxLength 3
RAPName	Optional Repeatable	Literal name of attribute	Recommended	minOcc 0 maxOcc ∞ minLength 1 maxLength 60
RAPSubName	Required Repeatable	Literal name of subsection of attribute	Optional	minOcc 1 maxOcc ∞ minLength 1 maxLength 60
ConditionsMetCode	Optional Repeatable	Indicates whether and how conditions for certification have been attained	Recommended	minOcc 0 maxOcc ∞ Enumerations: Conditional MutuallyDefined No Yes
ConditionsMetDate	Optional Repeatable	Date of attribute	Optional	minOcc 0 maxOcc ∞ xs:date where format is ccyy-mm-dd
NoteMessage	Optional Repeatable	Additional information about the attribute	Optional	minOcc 0 maxOcc ∞ minLength 1 maxLength 80

PESC XML Application for Admission Implementation Guide Version 1.3.0

Applicant.SelfReportedAcademicRecord.AcademicSession.Course. Attribute (Continued)

Code illustration:

```
<Attribute>
  <RAPCode>9TX</RAPCode>
  <RAPName>TX Core Curr</RAPName>
  <RAPSubName>030Natural Sciences - C1</RAPSubName>
  <ConditionsMetCode>Yes</ConditionsMetCode>
  <ConditionsMetDate>2006-12-15</ConditionsMetDate>
  <NoteMessage/>
</Attribute>
```

PESC XML Application for Admission Implementation Guide Version 1.3.0

Applicant.SelfReportedAcademicRecord.AcademicSession.Course. Proficiency

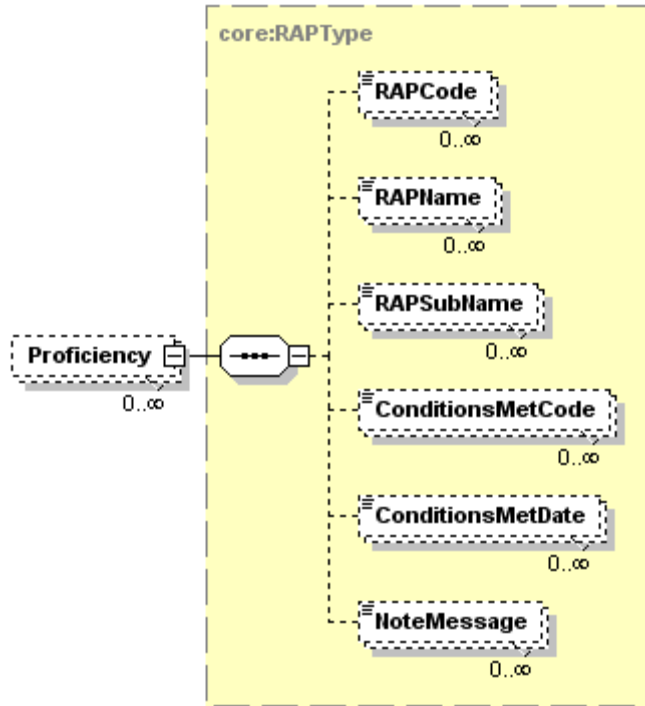

Tag Name	Schema Use	Description	Recommended Use	Format
RAPCode	Optional Repeatable	Proficiency demonstrated or earned	Recommended	minOcc 0 maxOcc ∞ minLength 1 maxLength 3
RAPName	Optional Repeatable	Literal name of proficiency	Recommended	minOcc 0 maxOcc ∞ minLength 1 maxLength 60
RAPSubName	Required Repeatable	Literal name of subsection of proficiency	Optional	minOcc 1 maxOcc ∞ minLength 1 maxLength 60
ConditionsMetCode	Optional Repeatable	Indicates whether and how conditions for certification have been attained	Recommended	minOcc 0 maxOcc ∞ Enumeration : Conditional MutuallyDefined No Yes
ConditionsMetDate	Optional Repeatable	Date of proficiency	Optional	minOcc 0 maxOcc ∞ xs:date where format is ccyymm-dd
NoteMessage	Optional Repeatable	Additional information about the proficiency	Optional	minOcc 0 maxOcc ∞ minLength 1 maxLength 80

PESC XML Application for Admission Implementation Guide Version 1.3.0

Applicant.SelfReportedAcademicRecord.AcademicSession.Course. Proficiency (Continued)

Code illustration:

```
<Proficiency>  
  <RAPCode>9TX</RAPCode>  
  <RAPName>TX Core Curr</RAPName>  
  <RAPSubName>030Natural Sciences - C1</RAPSubName>  
  <ConditionsMetCode>Yes</ConditionsMetCode>  
  <ConditionsMetDate>2006-12-15</ConditionsMetDate>  
  <NoteMessage/>  
</Proficiency>
```

PESC XML Application for Admission Implementation Guide Version 1.3.0

Applicant.SelfReportedAcademicRecord.AcademicSession.Course.Licensure

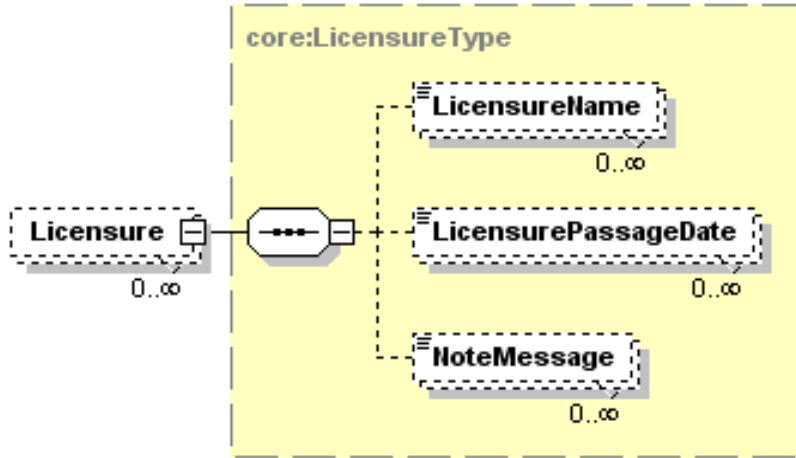

Tag Name	Schema Use	Description	Recommended Use	Format
LicensureName	Optional Repeatable	Proficiency demonstrated or earned	Recommended	minOcc 0 maxOcc ∞ minLength 1 maxLength 60
LicensurePassageDate	Optional Repeatable	Date of proficiency	Optional	minOcc 0 maxOcc ∞ xs:date where format is ccyy-mm-dd
NoteMessage	Optional Repeatable	Additional information about the licensure	Not Recommended	minOcc 0 maxOcc ∞ minLength 1 maxLength 80

Code illustration:

```

<Licensure>
  <LicensureName>Occupational Therapy Assistant</LicensureName>
  <LicensurePassageDate>2006-12-15</LicensurePassageDate>
  <NoteMessage/>
</Licensure>
  
```

PESC XML Application for Admission Implementation Guide Version 1.3.0

Applicant.SelfReportedAcademicRecord.AcademicSession.Course. LanguageOfInstruction

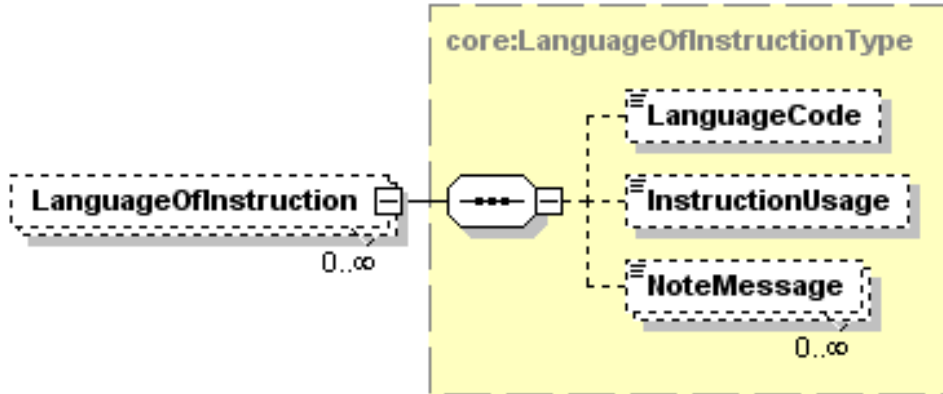

Tag Name	Schema Use	Description	Recommended Use	Format
LanguageCode	Optional	Code indicating the language being used, using ISO 639-2 code (Alpha-3) set. These codes are available at http://www.loc.gov/standards/iso639-2/	Recommended	minOcc 0 maxOcc 1 minLength 3 maxLength 3 See Appendix C
InstructionUsage	Optional	The use of the language in the context of instruction. Examination - Language of examination Instruction - Language of instruction WrittenExam - Language in which examination is written	Optional	minOcc 0 maxOcc ∞ Enumerations: Examination Instruction WrittenExam
NoteMessage	Optional Repeatable	Additional information about the language of instruction	Not Recommended	minOcc 0 maxOcc ∞ minLength 1 maxLength 80

Code illustration:

```
<LanguageOfInstruction>
  <LanguageCode>FRE</LanguageCode>
  <InstructionUsage>Examination</InstructionUsage>
  <NoteMessage/>
</LanguageOfInstruction>
```

PESC XML Application for Admission Implementation Guide Version 1.3.0

Applicant.SelfReportedAcademicRecord.AcademicSession.Course. UserDefinedExtensions

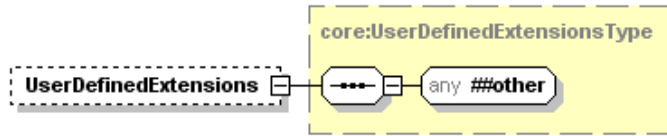

PESC XML Application for Admission Implementation Guide Version 1.3.0

Applicant.SelfReportedAcademicRecord.AcademicSession. AcademicSummary

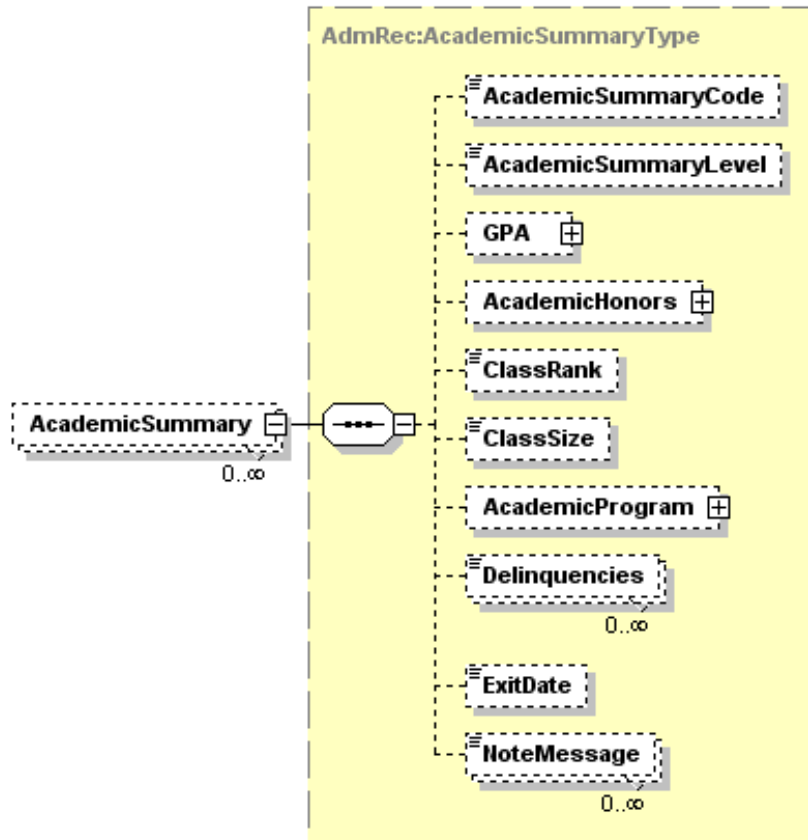

Tag Name	Schema Use	Description	Recommended Use	Format
AcademicSummaryCode	Optional	<p>Academic summary type is an indication of what is being summarized over what period of time.</p> <p>AcademicRenewal - Subset of forgiven courses</p> <p>All - Summary of all courses regardless of institution</p> <p>AllNotRepeated - Summary of all courses except for repeated or forgiven courses/credits</p> <p>CarryoverCredit - Summary from offline records and used as the initial point for cumulatives and averages</p> <p>ConvertedFrom - Summary of credits before an institutional term-basis conversion, such as from quarters to semesters</p> <p>ConvertedTo - Summary of credits after an institutional term-basis</p>	Recommended	<p>minOcc 0 maxOcc 1</p> <p>Enumerations: AcademicRenewal All AllNotRepeated CarryoverCredit ConvertedFrom ConvertedTo Cumulative DegreeApplicable NonDegreeApplicable NonWeighted SenderNotRepeated SenderOnly TransferNotRepeated TransferOnly UserDefined Weighted</p>

PESC XML Application for Admission Implementation Guide

Version 1.3.0

Tag Name	Schema Use	Description	Recommended Use	Format
		<p>conversion, such as from quarters to semesters</p> <p>Cumulative – Summary of all credits included on the student record through and including the current session.</p> <p>DegreeApplicable - Summary of course that apply to degree</p> <p>NonDegreeApplicable - Summary of courses that do not apply toward degree</p> <p>NonWeighted – No additional grade points were included for honors, International Baccalaureate, Advanced Placement, etc.</p> <p>SenderNotRepeated - Summary of all courses at sending institution except for repeated or forgiven courses/credits</p> <p>SenderOnly - Summary of all courses taken (or recorded as if they were taken) at the institution being reported</p> <p>TransferNotRepeated - Summary of transfer work except for repeated or forgiven courses/credits</p> <p>TransferOnly - Summary of transfer work (courses taken at other than the sending institution)</p> <p>UserDefined - see NoteMessage for explanation</p> <p>Weighted – sdditional grade points were included for honors, International Baccalaureate, Advanced Placement, etc.</p>		
AcademicSummaryLevel	Optional	The level of credit associated with the credit hours earned for the course.	Not Recommended	<p>minOcc 0 maxOcc 1</p> <p>Enumerartions: Dual DualHighSchoolCollege DualGraduateUndergraduate EighthGrade EleventhGrade Graduate GraduateProfessional LowerDivision NinthGrade Professional Secondary SeventhGrade TechnicalPreparatory TenthGrade TwelfthGrade Undergraduate UpperDivision Vocational</p>
GPA	Optional	Grade point average for this academic award	Recommended	<p>minOcc 0 maxOcc 1</p>
<p>Comment: This complex data element will be expanded on page 389.</p>				

PESC XML Application for Admission Implementation Guide

Version 1.3.0

Tag Name	Schema Use	Description	Recommended Use	Format
AcademicHonors	Optional	Honors earned in this academic session	Recommended	minOcc 0 maxOcc 1
Comment: This complex data element will be expanded on page 391.				
ClassRank	Optional	The student's class rank relative to other students in the academic cohort (e.g., graduating class).	Not Recommended	minOcc 0 maxOcc 1 minInclusive 1 maxInclusive 9999
Comment: The class rank typically reported is the one associated with the student's entire record at the school, not with just the other graduates in the class. If included, the top student in the class would be assigned the class rank of "1". Class rank is rarely given for postsecondary work.				
ClassSize	Optional	The numeric size of the academic cohort (or size of the graduating class)	Not Recommended	minOcc 0 maxOcc 1 minInclusive 1 maxInclusive 9999
AcademicProgram	Optional	Academic programs related to this academic summary	Not Recommended	minOcc 0 maxOcc 1
Delinquencies	Optional Repeatable	<p>The academic standing of the student at the end of this session.</p> <p>ExclusionAcademic – Student is not eligible to continue or return to the school for academic reasons. Students, in some cases, may petition to return on probation.</p> <p>ExclusionDiscipline – Student is not eligible to continue or return to the school for disciplinary reasons. Students, in some cases, may petition to return on probation.</p> <p>GoodStanding – Student was in good standing</p> <p>Other</p> <p>ProbationDiscipline – Student was on disciplinary probation</p> <p>ProbationGPA – Student was on academic probation because of low GPA</p> <p>ProbationHours – Student was on academic probation because of a deficiency in credit hours earned</p> <p>SuspensionDiscipline – Student was on disciplinary suspension</p> <p>SuspensionGPA – Student was on academic suspension because of low GPA</p> <p>SuspensionHours – Student was on academic suspension because of a deficiency in credit hours earned</p> <p>Unknown</p>	Optional	minOcc 0 maxOcc ∞ Enumerations: ExclusionAcademic ExclusionDiscipline GoodStanding Other ProbationDiscipline ProbationGPA ProbationHours SuspensionDiscipline SuspensionGPA SuspensionHours Unknown
ExitDate	Optional	The date on which the student officially withdrew or graduated	Optional	minOcc 0 maxOcc 1 xs:date where format is ccyymm-dd
NoteMessage	Optional Repeatable	Additional information about the academic summary for this award	Not Recommended	minOcc 0 maxOcc ∞ minLength 1 maxLength 80

PESC XML Application for Admission Implementation Guide Version 1.3.0

Applicant.SelfReportedAcademicRecord.AcademicSession. AcademicSummary (Continued)

Code illustration:

```
<AcademicSummary>
  <AcademicSummaryCode>DegreeApplicable</AcademicSummaryCode>
  <AcademicSummaryLevel>Undergraduate</AcademicSummaryLevel>
  <GPA>

  </GPA>
  <AcademicHonors>

  </AcademicHonors>
  <ClassRank>35</ClassRank>
  <ClassSize>257</ClassSize>
  <AcademicProgram/>
  <Delinquencies/>
  <ExitDate/>
  <NoteMessage/>
</AcademicSummary>
```

PESC XML Application for Admission Implementation Guide Version 1.3.0

Applicant.SelfReportedAcademicRecord.AcademicSession. AcademicSummary.GPA

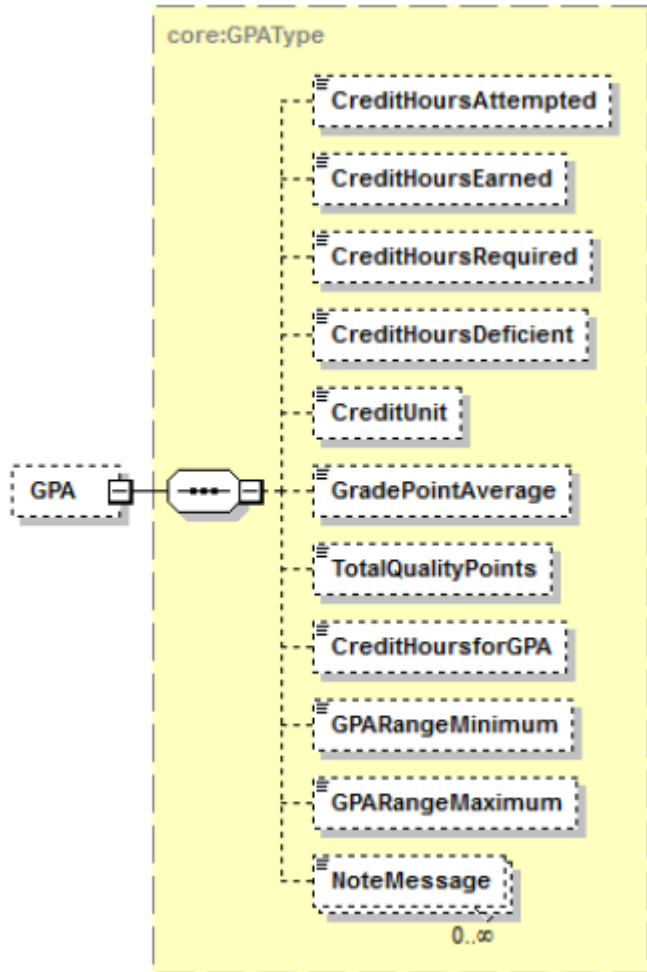

Tag Name	Schema Use	Description	Recommended Use	Format
CreditHoursAttempted	Optional	The total value of credit hours attempted whether or not included in the hours for GPA or hours earned	Recommended	minOcc 0 maxOcc 1 xs:decimal
Comment: For example, a student who attempted or enrolled for 128 semester credits for this award would show "128" as the value in this data element.				
CreditHoursEarned	Optional	The total value of credit hours successfully completed or earned	Recommended	minOcc 0 maxOcc 1 xs:decimal
CreditHoursRequired	Optional	The total value of credit hours required for an award	Not Recommended	minOcc 0 maxOcc 1 xs:decimal
Comment: This data element would not be appropriate for inclusion in GPA in this place of the schema.				

PESC XML Application for Admission Implementation Guide

Version 1.3.0

Tag Name	Schema Use	Description	Recommended Use	Format
CreditHoursDeficient	Optional	The total value of credit hours that a student is lacking for completion of an award	Not Recommended	minOcc 0 maxOcc 1 xs:decimal
Comment: This data element would not be appropriated for inclusion in GPA in this place in the schema..				
CreditUnit	Optional	The type of credit (unit, semester, or quarter) associated with the credit hours earned for the course	Recommended	minOcc 0 maxOcc 1 Enumerations: CarnegieUnits ClockHours ContinuingEducationUnits NoCredit Other Quarter Semester Units Unreported
GradePointAverage	Optional	The value of the total quality points divided by the credit hours for grade point average	Recommended	minOcc 0 maxOcc 1 xs:decimal
TotalQualityPoints	Optional	The total value of quality points used for the calculation of the grade point average.	Recommended	minOcc 0 maxOcc 1 xs:decimal
CreditHoursforGPA	Optional	The total value of credit hours included in the grade point average calculation	Recommended	minOcc 0 maxOcc 1 xs:decimal
GPARangeMinimum	Optional	The lowest possible grade point average that can be earned by the student	Recommended	minOcc 0 maxOcc 1 xs:decimal
GPARangeMaximum	Optional	The highest possible grade point average that can be earned by the student	Recommended	minOcc 0 maxOcc 1 xs:decimal
NoteMessage	Optional Repeatable	Additional information about the grade point average	Not recommended	minOcc 0 maxOcc ∞ minLength 1 maxLength 80

Code illustration:

```

<GPA>
  <CreditHoursAttempted>150</CreditHoursAttempted>
  <CreditHoursEarned>128</CreditHoursEarned>
  <CreditHoursRequired/>
  <CreditHoursDeficient/>
  <CreditUnit>Semester</CreditUnit>
  <GradePointAverage>3.53</GradePointAverage>
  <TotalQualityPoints>466</TotalQualityPoints>
  <CreditHoursforGPA>132</CreditHoursforGPA>
  <GPARangeMinimum>0</GPARangeMinimum>
  <GPARangeMaximum>4</GPARangeMaximum>
  <NoteMessage/>
</GPA>

```

PESC XML Application for Admission Implementation Guide Version 1.3.0

Applicant.SelfReportedAcademicRecord.AcademicSession. AcademicSummary.AcademicHonors

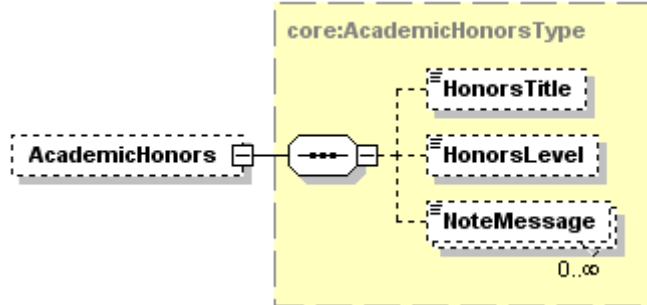

Tag Name	Schema Use	Description	Recommended Use	Format
HonorsTitle	Optional	The descriptive title for the honors received	Optional	minOcc 0 maxOcc 1 minLength 1 maxLength 30
HonorsLevel	Optional	A code value representing 1st highest honor, 2nd highest and 3rd highest.	Optional	minOcc 0 maxOcc 1 Enumerations: FirstHighest SecondHighest ThirdHighest
NoteMessage	Optional Repeatable	Additional information about the URL address of the source institution	Not recommended	minOcc 0 maxOcc ∞ minLength 1 maxLength 80

Code illustration:

```

<AcademicHonors>
  <HonorsTitle>Cum Laude</HonorsTitle>
  <HonorsLevel>ThirdHighest</HonorsLevel>
  <NoteMessage/>
</AcademicHonors>

```

PESC XML Application for Admission Implementation Guide Version 1.3.0

Applicant.SelfReportedAcademicRecord. AdditionalStudentAchievements

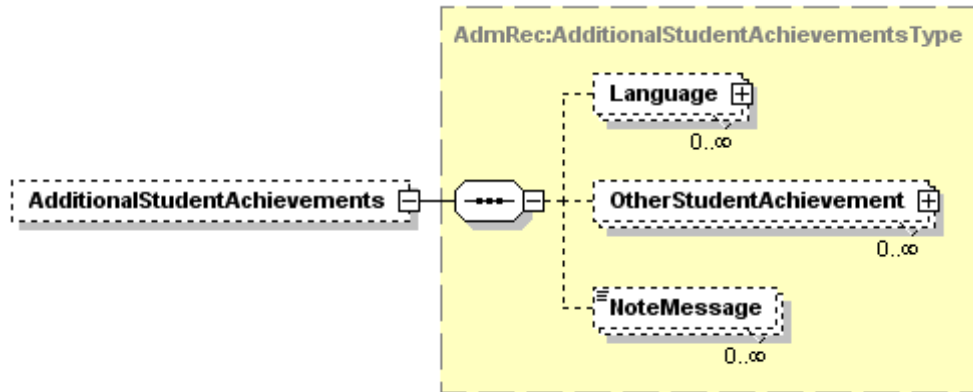

Tag Name	Schema Use	Description	Recommended Use	Format
Language	Optional	Information about the applicant's achievements in languages	Recommended	minOcc 0 maxOcc ∞
Comments: This complex data element will be expanded on page 393.				
OtherStudentAchievement	Optional Repeatable	Information about achievements other than languages	Optional	minOcc 0 maxOcc ∞
Comments: This complex data element will be expanded on page 394.				
NoteMessage	Optional Repeatable	Additional information about the Additional Student Achievements	Not Recommended	minOcc 0 maxOcc ∞ minLength 1 maxLength 80

Code illustration:

```

<AdditionalStudentAchievements>
  <Language>

  </Language>
  <OtherStudentAchievement>

  </OtherStudentAchievement>
  <NoteMessage/>
</AdditionalStudentAchievements>

```

PESC XML Application for Admission Implementation Guide Version 1.3.0

Applicant.SelfReportedAcademicRecord. AdditionalStudentAchievements.Language

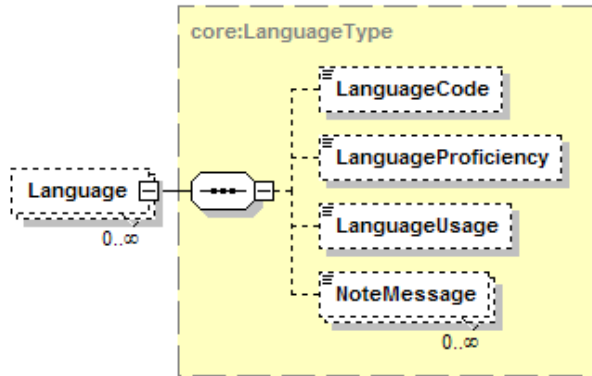

Tag Name	Schema Use	Description	Recommended Use	Format
LanguageCode	Optional	Information about the applicant's achievements in languages	Recommended	minOcc 0 maxOcc 1 minLength 3 maxLength 3 See Appendix C
LanguageProficiency	Optional	The proficiency level of the applicant in this language	Optional	minOcc 0 maxOcc 1 Enumerations: EnglishOnly Excellent Fair FullyEnglishProficient Good LimitedEnglishProficiency NonEnglishSpeaking Poor RedesignatedFluentEnglishProficiency Unacceptable Unknown
LanguageUsage	Optional	The type of use of this language in which the student claims proficiency	Optional	minOcc 0 maxOcc 1 Enumerations: FirstSpokenLanguage Native Reading Speaking SpokenAtHome Writing WrittenCommunication
NoteMessage	Optional Repeatable	Additional information about the proficiency of the applicant in this language	Not Recommended	minOcc 0 maxOcc ∞ minLength 1 maxLength 80

Code illustration:

```

<Language>
  <LanguageCode>FRE</LanguageCode>
  </LanguageProficiency>Excellent</LanguageProficiency>
  <LanguageUsage>Native</LanguageUsage>
  <NoteMessage/>
</Language>
  
```

PESC XML Application for Admission Implementation Guide Version 1.3.0

Applicant.SelfReportedAcademicRecord.

AdditionalStudentAchievements.OtherStudentAchievement

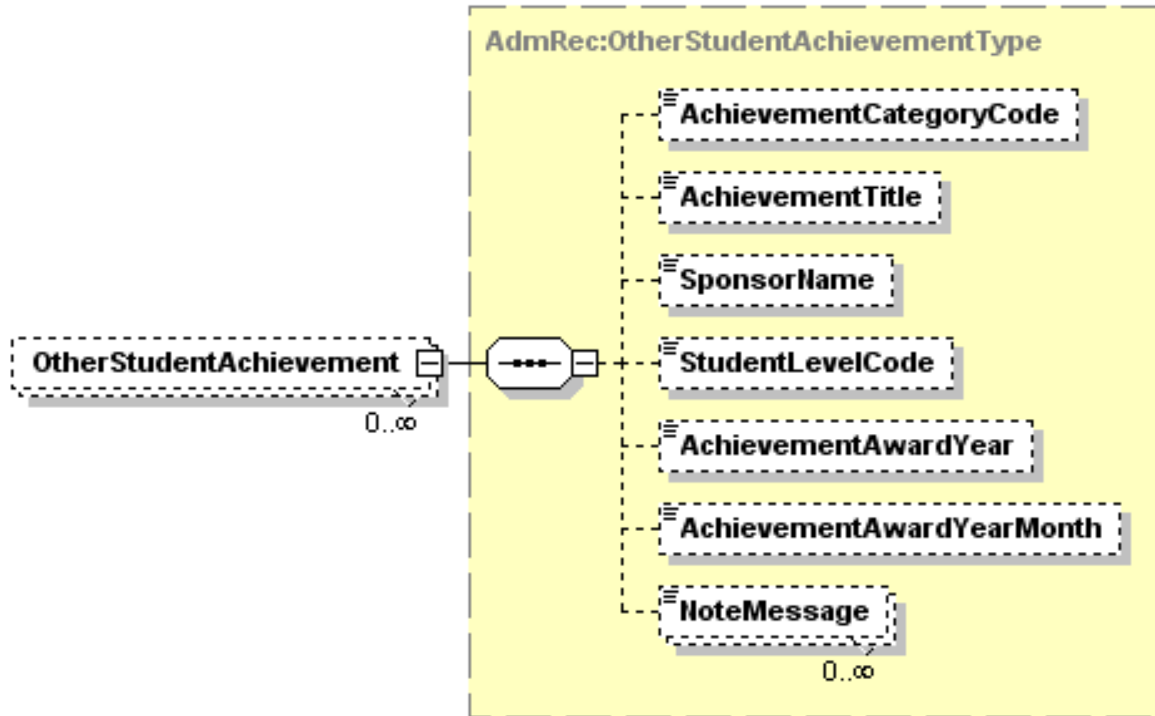

Tag Name	Schema Use	Description	Recommended Use	Format
AchievementCategoryCode	Optional	The category for the achievement	Optional	minOcc 0 maxOcc 1 Enumerations: Academic Arts Athletic BusinessEmployment CommunityService Leadership Other
AchievementTitle	Optional	The name or the title of the achievement earned by the applicant	Recommended	minOcc 0 maxOcc 1 minLength 0 maxLength 60
SponsorName	Optional	The organization, company, school, person, etc. that sponsored the award.	Optional	minOcc 0 maxOcc 1 minLength 0 maxLength 60

PESC XML Application for Admission Implementation Guide

Version 1.3.0

Tag Name	Schema Use	Description	Recommended Use	Format
StudentLevelCode	Optional	The level of the applicant when the achievement was earned or awarded	Optional	minOcc 0 maxOcc 1 Enumerations: CollegeFirstYear CollegeJunior CollegeSenior CollegeSophomore CollegeFifthYear EighthGrade GraduateFirstYear GraduateSecondYear GraduateThirdYear NinthGrade PostBaccalaureate Postsecondary PostsecondaryBachelorPreliminaryYear PostsecondaryBachelorPreliminaryYear TenthGrade EleventhGrade TwelfthGrade
AchievementAwardYear	Optional	The year when the achievement was earned or presented	Optional	minOcc 0 maxOcc 1 The format is CCYY
AchievementAwardYearMonth	Optional	The year and month when the achievement was earned or presented	Optional	minOcc 0 maxOcc 1 Format is CCYY-MM
Comments: If you include the data element AchievementAwardYear, then you do not also include AchievementAwardYearMonth, and vice versa.				
NoteMessage	Optional Repeatable	Additional information about the Additional Student Achievement	Not Recommended	minOcc 0 maxOcc ∞ minLength 1 maxLength 80

Code illustration:

```

<AdditionalStudentAchievement>
  <AchievementCategoryCode>Athletic</AchievementCategoryCode>
  <AchievementTitle>Football Star of the Year</AchievementTitle>
  <SponsorName>School Athletic Association</SponsorName>
  <StudentLevelCode>TwelfthGrade</StudentLevelCode>
  <AchievementAwardYear/>
  <AchievementAwardYearMonth>2006-05</AchievementAwardYearMonth>
  <NoteMessage/>
</AdditionalStudentAchievement>

```

PESC XML Application for Admission Implementation Guide Version 1.3.0

Applicant.SelfReportedAcademicRecord. HighSchoolSubjectArea

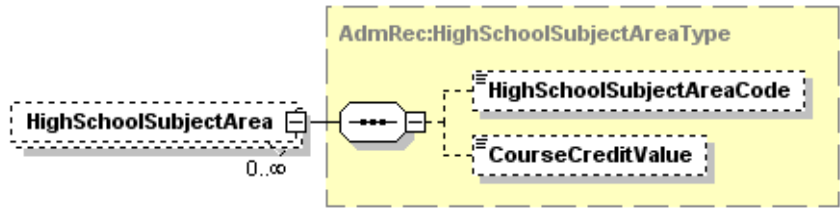

Tag Name	Schema Use	Description	Recommended Use	Format
HighSchoolSubjectAreaCode	Optional	The subject area of the course grouping	Recommended	minOcc 0 maxOcc 1 Enumerations: AcademicElective Arts English ForeignLanguage HistorySocialScience LabScience Math Other Science
CourseCreditValue	Optional	The number of credits awarded for the course	Optional	minOcc 0 maxOcc 1 Format is a decimal
Comment: The value of a high school course would typically be in Carnegie Units. For a one semester high school course, a typical value might be 0.5.				

Code illustration:

```

<HighSchoolSubjectArea>
  <HighSchoolSubjectAreaCode>Math</HighSchoolSubjectAreaCode>
  <CourseCreditValue>0.5</CourseCreditValue>
</HighSchoolSubjectArea>
<HighSchoolSubjectArea>
  <HighSchoolSubjectAreaCode> HistorySocialScience</HighSchoolSubjectAreaCode>
  <CourseCreditValue>1</CourseCreditValue>
</HighSchoolSubjectArea>

```

PESC XML Application for Admission Implementation Guide Version 1.3.0

Applicant.SelfReportedAcademicRecord.ClassRank

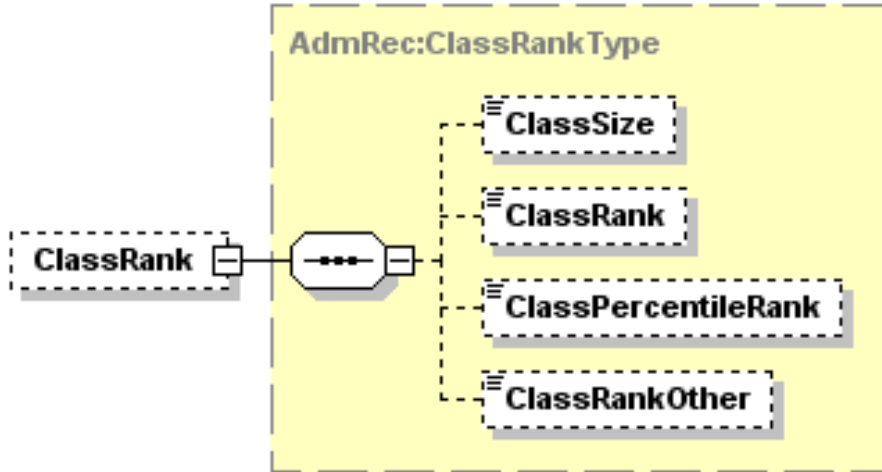

Tag Name	Schema Use	Description	Recommended Use	Format
ClassSize	Optional	The size of the class that is being ranked	Recommended	minOcc 0 maxOcc 1 Format is an integer
ClassRank	Optional	The position or rank of the applicant in the class	Optional	minOcc 0 maxOcc 1 Format is an integer
Comment: For a student who was at the top of the class, the class rank value would be "1"				
ClassPercentileRank	Optional	This would be the applicant's self reported rank as a percentile where the highest possible rank would be 99	Optional	minOcc 0 maxOcc 1 Format is an integer
ClassRankOther	Optional	This would allow for the class rank to be reported in some other way, such as "Top Quartile", or "Top Quintile", et.c	Optional	minOcc 0 maxOcc 1 minLength 1 maxLength 60

Code illustration:

```

<ClassRank>
  <ClassSize>325</ClassSize>
  <ClassRank>3</ClassRank>
  <ClassPercentileRank>99</ClassPercentileRank>
  <ClassRankOther/>
</ClassRank>

```

PESC XML Application for Admission Implementation Guide Version 1.3.0

Applicant.SelfReportedAcademicRecord.AcademicProgram

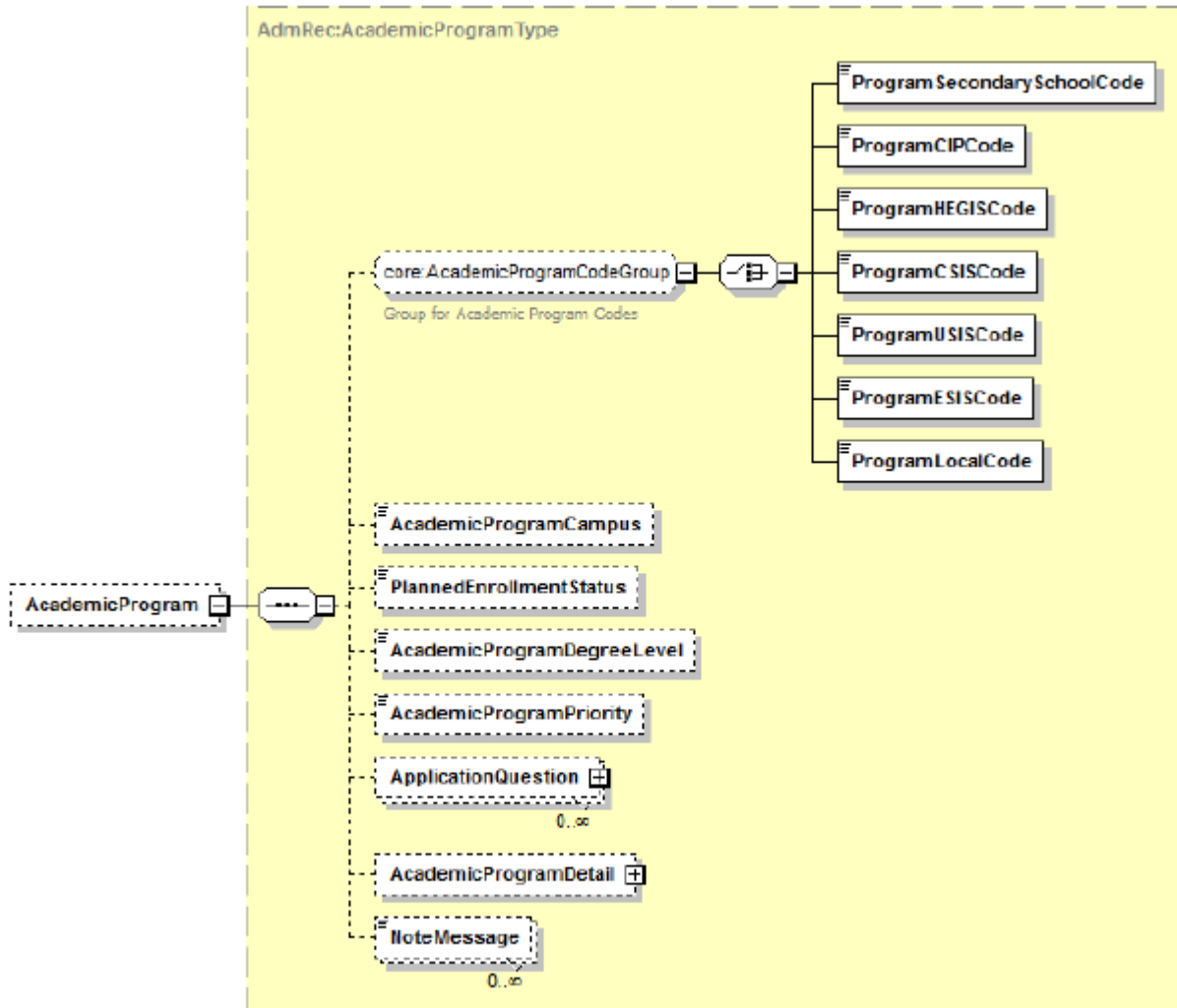

Tag Name	Schema Use	Description	Recommended Use	Format
ProgramSecondarySchoolCode	Optional exclusive choice	Code indicating a discipline, r field of study, or education goal in K12 school	Not Recommended	minOcc 0 maxOcc 1 Enumerations: CareerPrep CollegePrep CollegePrepOrCollegeTechPrep CollegeTechPrep General Occupational Vocational
ProgramCIPCode	Optional exclusive choice	Code indicating a discipline or field of study assigned by the Classification of Instructional Programs	Recommended	minOcc 0 maxOcc 1 minLength 6 maxLength 20

PESC XML Application for Admission Implementation Guide

Version 1.3.0

Tag Name	Schema Use	Description	Recommended Use	Format
ProgramHEGISCode	Optional exclusive choice	Code indicating a discipline or field of study assigned by Higher Education General Information Survey	Not Recommended	minOcc 0 maxOcc 1 minLength 6 maxLength 20
ProgramCSISCode	Optional exclusive choice	Code indicating a discipline or field of study assigned by Statistics Canada Canadian College Student Information System	Not Recommended	minOcc 0 maxOcc 1 minLength 5 maxLength 5
ProgramUSISCode	Optional exclusive choice	Code indicating a discipline or field of study assigned by the Statistics Canada University Student Information System.	Not Recommended	minOcc 0 maxOcc 1 minLength 5 maxLength 5
ProgramESISCode	Optional exclusive choice	Code indicating a discipline or field of study assigned by the Statistics Canada Enhanced Student Information System.	Optional	minOcc 0 maxOcc 1 minLength 1 maxLength 20
ProgramLocalCode	Optional exclusive choice	Code indicating a the specific program (with options, if any) that the student selects from a list of available programs	Optional	minOcc 0 maxOcc 1 minLength 1 maxLength 20
Comment: Although the above 6 choices for program codes are optional, the first choice is probably the most appropriate to describe the specific academic programs at the specific high school the applicant attended. For later state and federal reporting, the local code would be linked to one or more of the other codes in the school's data base.				
AcademicProgramCampus	Optional	The campus for this particular program.	Not Recommended	minOcc 0 maxOcc 1 minLength 1 maxLength 60
PlannedEnrollmentStatus	Optional	The intent of the applicant to pursue full time or part time enrollment	Not Recommended	minOcc 0 maxOcc 1 Enumerations: FullTime PartTime
AcademicProgramDegreeLevel	Optional	The level of the degree	Not Recommended	minOcc 0 maxOcc 1 Enumerations: AssociateDegree BaccalaureateDegree Certificate Doctorate GraduateDegree HighSchool MastersDegree NonDegree PostSecondaryDiploma ProfessionalDegree
AcademicProgramPriority	Optional	The priority ranking for this program with relation to other programs	Not Recommended	minOcc 0 maxOcc 1
ApplicationQuestion	Optional Repeatable	Specific questions asked on an application for admission that typically apply only to that one school	Not Recommended	minOcc 0 maxOcc ∞
Comment: Application Questions are not appropriate for Self Reported Academic Record.				
AcademicProgramDetail	Optional	Details about this specific program	Optional	minOcc 0 maxOcc 1

PESC XML Application for Admission Implementation Guide

Version 1.3.0

Tag Name	Schema Use	Description	Recommended Use	Format
<i>Comment: This complex data element will be expanded on page 400.</i>				
NoteMessage	Optional Repeatable	Additional information about the Academic Program in which the applicant was previously enrolled	Not Recommended	minOcc 0 maxOcc ∞ minLength 1 maxLength 80

Applicant.SelfReportedAcademicRecord.AcademicProgram (Continued)

Code illustration:

```

<AcademicProgram>
  <ProgramLocalCode>BA Music</ProgramLocalCode>
  <AcademicProgramCampus/>
  <PlannedEnrollmentStatus/>
  <AcademicProgramDegreeLevel>BaccalaureateDegree</AcademicProgramDegreeLevel>
  <AcademicProgramPriority/>
  <ApplicationQuestion/>
  <ApplicationProgramDetail>

  </ApplicationProgramDetail>
  <NoteMessage/>
</AcademicProgram>

```

PESC XML Application for Admission Implementation Guide Version 1.3.0

Applicant.SelfReportedAcademicRecord.AcademicProgram. AcademicProgramDetail

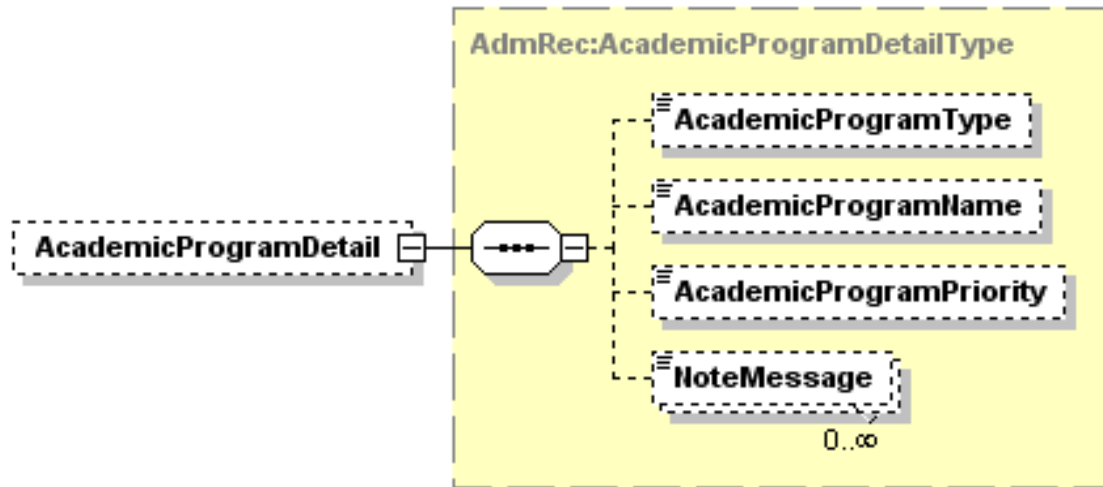

Tag Name	Schema Use	Description	Recommended Use	Format
AcademicProgramType	Optional	The specific category of the academic program for which the person is applying	Optional	minOcc 0 maxOcc 1 Enumerations: Concentration Focus Major Minor SecondMajor Specialization
AcademicProgramName	Optional	The specific name of the academic program for which the person is applying	Optional	minOcc 0 maxOcc 1 minLength 1 maxLength 60
AcademicProgramPriority	Optional	The priority that the applicant has given this particular program among all the programs to which the applicant is applying	Optional	minOcc 1 maxOcc 1 Data type is an integer
Comment: <i>If the applicant has applied for six programs and this program is the second choice, then this value would be "2".</i>				
NoteMessage	Optional	Additional information about the details of the Academic Program	Not Recommended	minOcc 0 maxOcc ∞ minLength 1 maxLength 80

Code illustration:

```

<AcademicProgramDetail>
  <AcademicProgramType>Major</AcademicProgramType>
  <AcademicProgramName>Bachelor of Fine Arts</AcademicProgramName>
  <AcademicProgramPriority/>
  <NoteMessage/>
</AcademicProgramDetail>

```

PESC XML Application for Admission Implementation Guide Version 1.3.0

Applicant.SelfReportedTests

Note: Although the complex data element “SelfReportedTests” is an optional data element, if you choose to include it in the instance document, then you must include one (and only one) version of the date the test was or will be taken.

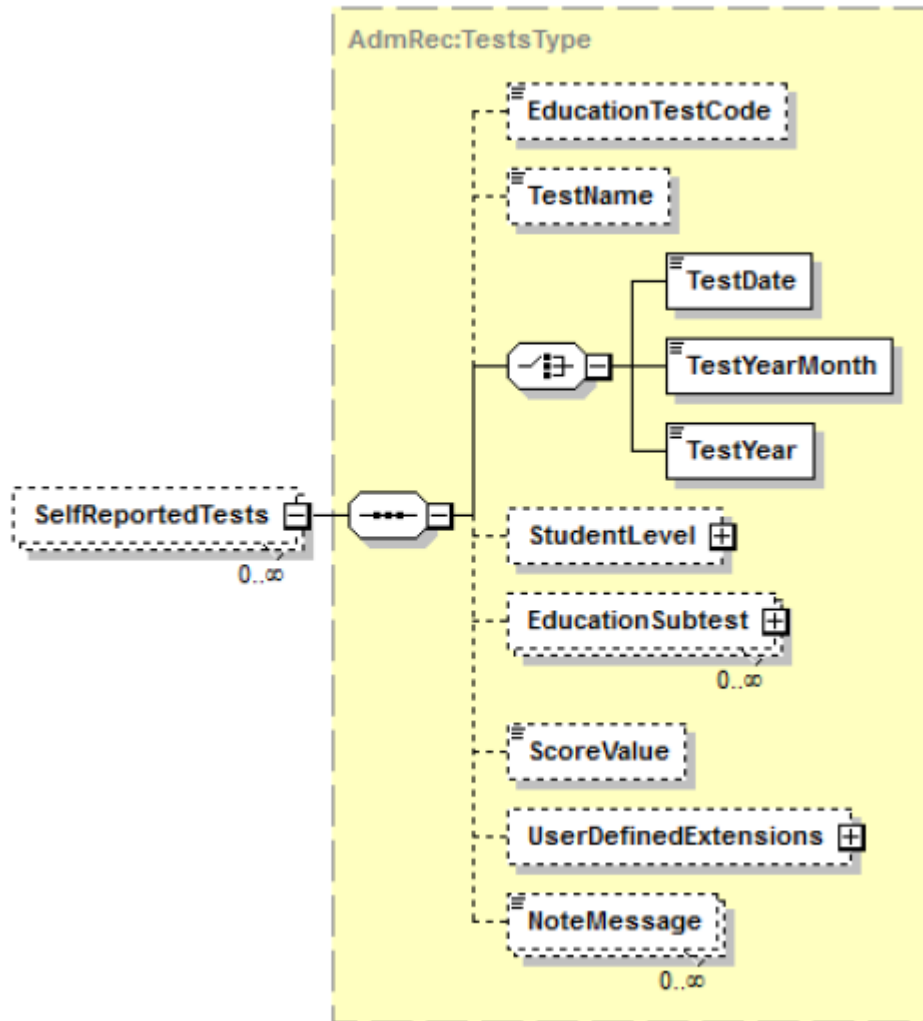

Tag Name	Schema Use	Description	Recommended Use	Format
EducationTestCode	Optional	Code identifying the test	Recommended	minOcc 0 maxOcc 1 See Education Test Codes in Appendix N
<p>Comment: The PESC Workgroup on Education Test Score Reporting developed a new set of Education Test Codes. They appear in Appendix N. It is almost certain that there will soon be additions to this list when the Application for Admission schema is approved and begins to be used..</p>				
TestName	Optional	The literal name of the test	Recommended	minOcc 0 maxOcc 1 minLength 1 maxLength 60

PESC XML Application for Admission Implementation Guide

Version 1.3.0

Tag Name	Schema Use	Description	Recommended Use	Format
Comment: If the value for EducationTestCode is "OtherTest" or "OtherStateTest", then it is extremely important that TestName be included.				
TestDate	Required choice Choose one	The date the test was taken	Required choice	minOcc 1 maxOcc 1 xs:date where format is ccyy-mm-dd
TestYearMonth	Required choice Choose one	The year and the month when the test was taken	Required choice	minOcc 0 maxOcc 1 Date format of ccyy-mm
TestYear	Required choice Choose one	The year the test was taken	Required choice	minOcc 0 maxOcc 1 Date format of ccyy
Comment: One, and only one, of the three data elements above (TestDate, TestYearMonth, and TestYear) is required. TestDate is preferred if the complete date is provided by the applicant.				
StudentLevel	Optional	The educational level of the student when the test was taken	Optional	minOcc 0 maxOcc 1
Comment: This complex data element will be expanded on page 403.				
EducatonSubtest	Optional Repeatable	Information about the subtest	Required	minOcc 0 maxOcc ∞
Comment: This complex data element will be expanded on page 404.				
ScoreValue	Optional	The actual score for the test if a score exists for the test as a whole	Optional	minOcc 0 maxOcc 1 minLength 1 maxLength 40
UserDefinedExtensions	Optional	Additional information about the tests taken or to be taken by the applicant that has been put into a mini schema. It is intended for use within a predetermined state or region.	Not recommended	minOcc 0 maxOcc 1
Comment: The use of a mini-schema called UserDefinedExtensions can be helpful to a specific group of users who would like to include coded data that is pre-defined and can be interpreted by the recipient of the instance document. Others not in that group would simply ignore the UDE.				
NoteMessage	Optional Repeatable	Additional information about the tests the applicant has taken or plans to take	Not recommended	minOcc 0 maxOcc ∞ minLength 1 maxLength 80

Code illustration:

```

<SelfReportedTests>
  <EducationTestCode/>APBiology</EducationTestCode>
  <TestName>College Board's Advanced Placement Test in Biology</TestName>
  <TestDate>2007-02-28</TestDate>
  <StudentLevel>

  </StudentLevel>
  <EducationSubtest>

  </EducationSubtest>
  <ScoreValue>16</ScoreValue>
  <UserDefinedExtensions/>
  <NoteMessage/>
</SelfReportedTests>

```

PESC XML Application for Admission Implementation Guide Version 1.3.0

Applicant.SelfReportedTests.StudentLevel

Note: If you choose to include the optional *StudentLevel*, then you must include the *StudentLevelCode*.

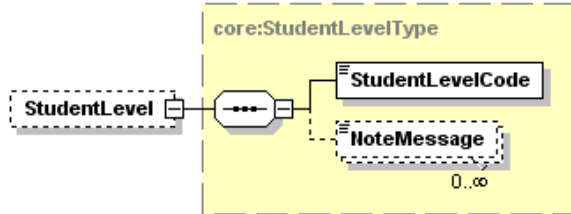

Tag Name	Schema Use	Description	Recommended Use	Format
StudentLevelCode	Required	The level of the student at the school	Required	minOcc 1 maxOcc 1 Enumerations: CollegeFifthYear CollegeFirstYear CollegeFirstYearAttendedBefore CollegeJunior CollegeSenior CollegeSophomore Doctoral EighthGrade EleventhGrade GraduateBeyondThirdYear GraduateFirstYear GraduateNonDegree GraduateSecondYear GraduateThirdYear Masters MastersQualifying NinthGrade NonDegree PostBaccalaureate Postdoctoral Postsecondary PostsecondaryBachelorPreliminaryYear Professional ProfessionalBeyondThirdYear ProfessionalFirstYear ProfessionalSecondYear ProfessionalThirdYear SeventhGrade TenthGrade TwelfthGrade NoFormalSchool
Comment: The Student Level Code is required only if the complex data element Student Level is included in the instance document.				
NoteMessage	Optional	Additional information about the level of the student	Not Recommended	minOcc 0 maxOcc 1 minLength 1 maxLength 80

Code illustration:

```

<StudentLevel>
  <StudentLevelCode>Masters</StudentLevelCode>
  <NoteMessage/>
</StudentLevel>
    
```

PESC XML Application for Admission Implementation Guide Version 1.3.0

Applicant.SelfReportedTests.EducationSubtest

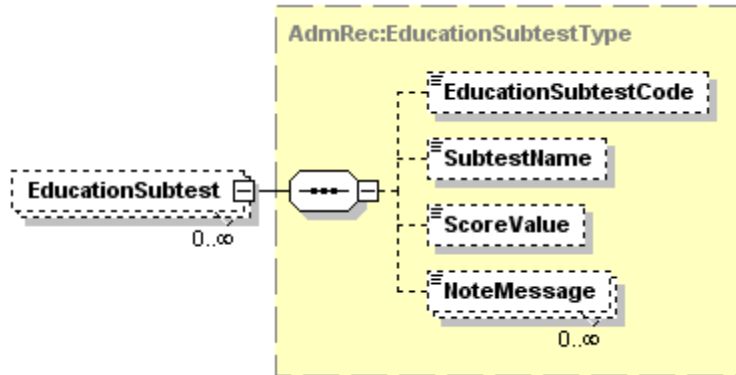

Tag Name	Schema Use	Description	Recommended Use	Format
EducationSubtestCode	Optional	Code identifying the education subtest	Recommended	minOcc 0 maxOcc 1 See Appendix P for the current list of subtest codes
Comment: The PESC Workgroup on Education Test Score Reporting is revising the list of subtest codes so they will not be directly tied to a specific test. When this code set is approved, we will use that code set in Appendix P.				
SubtestName	Optional	The literal name of the subtest	Optional	minOcc 0 maxOcc 1 minLength 1 maxLength 60
Comment: If you include the value "OtherSubtest" in EducationSubtestCode, then it is very important to include the SubtestName.				
ScoreValue	Optional	The actual score the applicant earned on the subtest, as reported by the applicant	Recommended	minOcc 1 maxOcc ∞ minLength 1 maxLength 40
NoteMessage	Optional Repeatable	Additional information about the subtests the applicant has taken or plans to take	Not recommended	minOcc 0 maxOcc ∞ minLength 1 maxLength 80

Code illustration:

```

<EducationSubtest>
  <EducationSubtestCode/>Reading</EducationSubtestCode>
  <SubtestName>Reading</SubtestName>
  <ScoreValue>35</ScoreValue>
  <NoteMessage/>
</EducationSubtest>

```

PESC XML Application for Admission Implementation Guide Version 1.3.0

Applicant.ExtraCurricularActivity

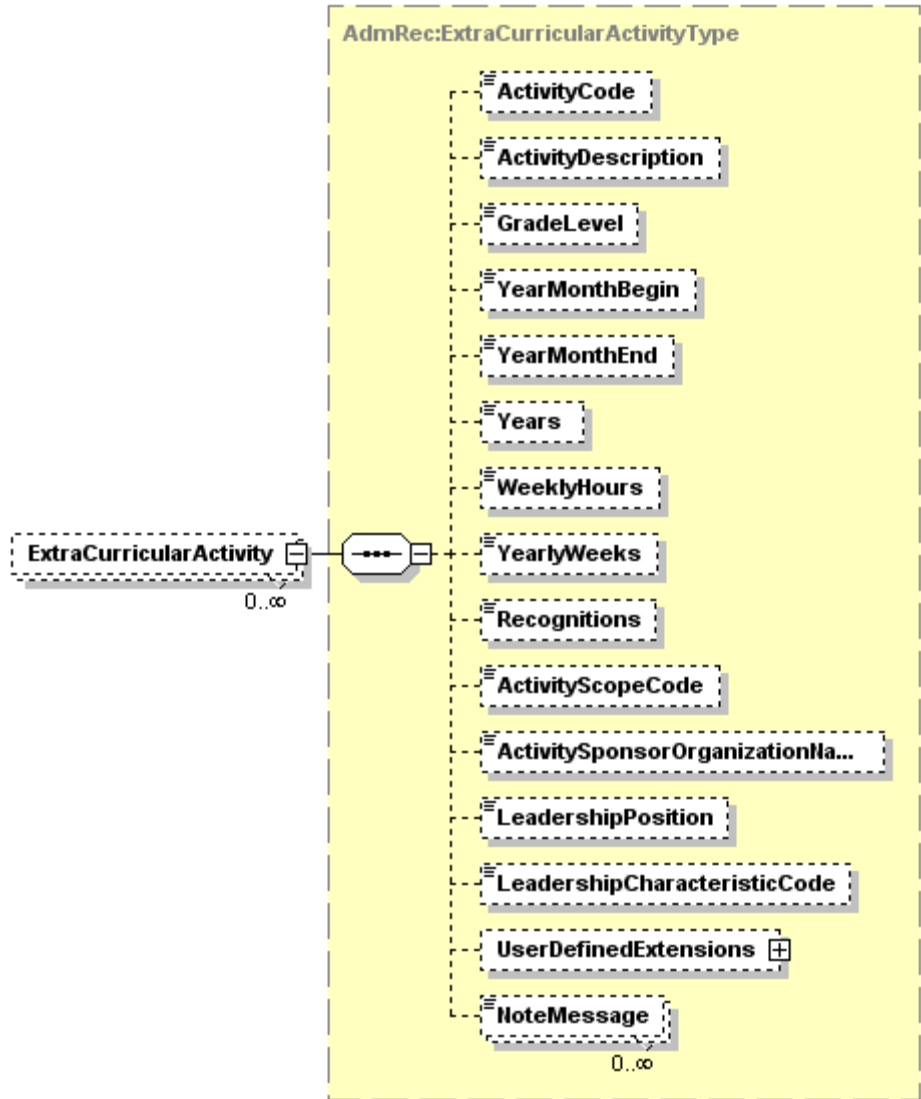

Tag Name	Schema Use	Description	Recommended Use	Format
ActivityCode	Optional	Code identifying the extra curricular activity	Recommended	minOcc 0 maxOcc 1 Enumerations: AcademicHonorSociety AcademicTeamBrainBow Archery ArtGraphicDesign Badminton Band Baseball Basketball Bowling Boxing BoyScouts Braodcasting

PESC XML Application for Admission Implementation Guide

Version 1.3.0

Tag Name	Schema Use	Description	Recommended Use	Format
				Cheerleading Chorus ChurchService ClassOfficer ClassPresident Club4H ClubArt ClubBeta ClubCareer ClubChess ClubComputer ClubDistributiveEducationAmerica ClubDrama ClubEnvironmental ClubEthnic ClubForeignLanguage ClubFrench ClubFuturebusinessLeadersAmerica ClubFutureFarmersAmerica ClubFutureHomemakersAmerica ClubFutureTeachersAmerica ClubGerman ClubHealthOccupationsStudentsAmerica ClubItalian ClubLatin ClubMuAlphaTheta ClubOther ClubPortuguese ClubPsiEtaScience ClubRussian ClubScience ClubSpanish ClubSpeechDebate ClubStudentsAgainstDrunkDriving CommunityService Crew CrossCountry Dance DanceTeam Dissertation Diving DivingScuba DrillTeam Fencing Football Fraternity GirlScouts Golf Gymnastics HandballTeam HockeyField HockeyIce HorsebackRiding Invention JazzEnsemble Journalism JournalismOther KeyClub Lacrosse

PESC XML Application for Admission Implementation Guide

Version 1.3.0

Tag Name	Schema Use	Description	Recommended Use	Format
				LiteraryMagazine ManagerTeam MartialArts MusicInstrument MusicOther MusicTheoryComposition MusicVocal NationalForensicsLeague NationalHonorSociety NovelBook Orchestra Other Patent PeerCounseling PerformingArtsOther Poetry Polo PoloWater ProfessionalPresentation ProfessionalScholarlyArticle ProseShortstory PublicationOther Racquetball Research Riflery Rodeo Rugby Sailing Skiing Soccer Softball Sorority SportOther Squash StudentBodyOfficer StudentBodyPresident StudentLeadershipOther Swimming SwimmingSynchronized Tennis TennisTable Textbook TheaterDrama Thesis ThespianSociety TrackField Tutoring UnpublishedManuscript Volleyball VolunteeringOther VolunteerWork Wrestling YearBook
Comment: These codes are also presented by category in Appendix M.				
ActivityDescription	Optional	A description of the extra curricular activity	Optional	minOcc 0 maxOcc 1 minLength 0 maxLength 60

PESC XML Application for Admission Implementation Guide

Version 1.3.0

Tag Name	Schema Use	Description	Recommended Use	Format
GradeLevel	Optional	The grade level of the applicant when the participation in the activity occurred	Optional	minOcc 0 maxOcc 1 Enumerations: Grade9 Grade10 Grade11 Grade12 PostSecondary
YearMonthBegin	Optional	The year and month that participation in the activity began	Recommended	minOcc 0 maxOcc 1 Format is CCYY-MM
YearMonthEnd	Optional	The year and month that participation in the activity ended	Recommended	minOcc 0 maxOcc 1 Format is CCYY-MM
Years	Optional	The number of years that the applicant spent in this activity	Optional	minOcc 0 maxOcc 1 Format is an integer
WeeklyHours	Optional	The average number of hours that the applicant spent in this activity per week	Optional	minOcc 0 maxOcc 1 Format is an integer
YearlyWeeks	Optional	The average number of weeks that the applicant spent in this activity per year	Optional	minOcc 0 maxOcc 1 Format is an integer
Recognitions	Optional	Any recognitions earned as a result of participating in this activity	Optional	minOcc 0 maxOcc 1 minLength 0 maxLength 60
ActivityScopeCode	Optional	The scope of the activity in which the applicant participated	Optional	minOcc 0 maxOcc 1 Enumerations: International Local National Regional
ActivitySponsorOrganization Name	Optional	The sponsoring organization of the activity	Optional	minOcc 0 maxOcc 1 minLength 1 maxLength 60
LeadershipPosition	Optional	A description of any leadership positions held by the applicant	Optional	minOcc 0 maxOcc 1 minLength 0 maxLength 80
LeadershipCharacteristicCode	Optional	The characteristic of the leadership position held by the applicant	Optional	minOcc 0 maxOcc 1 Enumerations: Elected NonElected
UserDefinedExtensions	Optional	Additional information about the applicant's extra curricular activities that has been put into a mini schema. It is intended for use within a predetermined state or region.	Not recommended	minOcc 0 maxOcc 1
Comment: The use of a mini-schema called <i>UserDefinedExtensions</i> can be helpful to a specific group of users who would like to include coded data that is pre-defined and can be interpreted by the recipient of the instance document. Others not in that group would simply ignore the UDE.				
NoteMessage	Optional Repeatable	Additional information about the extracurricular activities in which the applicant has participated	Not recommended	minOcc 0 maxOcc ∞ minLength 1 maxLength 80

PESC XML Application for Admission Implementation Guide Version 1.3.0

Applicant.ExtraCurricularActivity (Continued)

Code illustration:

```
<ExtraCurricularActivity>
  <ActivityCode/>Sailing</ActivityCode>
  <ActivityDescription>Member of the school's varsity sailing club</ActivityDescription>
  <GradeLevel>Grade10</GradeLevel>
  <YearMonthBegin>2004-09</YearMonthBegin>
  <YearMonthEnd>2005-06</YearMonthEnd>
  <Years>1</Years>
  <WeeklyHours>10</WeeklyHours>
  <YearlyWeeks>35</YearlyWeeks>
  <Recognitions>Best Suntan of the Team</Recognitions>
  <ActivityScopeCode>Local</ActivityScopeCode>
  <ActivitySponsorOrganizationName>Celebrity Cruise Company</ActivitySponsorOrganizationName>
  <LeadershipPosition>FirstMate</LeadershipPosition>
  <LeadershipCharacteristicCode>NonElected</LeadershipCharacteristicCode>
  <UserDefinedExtensions/>
  <NoteMessage/>
</ExtraCurricularActivity>
```

**PESC XML Application for Admission Implementation Guide
Version 1.3.0**

**End of the latest draft of the Implementation
Guide for the PESC XML Application for
Admission to Postsecondary Schools in the
United States and Canada**

**PESC XML Application for Admission Implementation Guide
Version 1.3.0**

Appendix A State and Province Codes Sorted by State and Province Codes	
State and Province Code	State and Province Name
AA	Military – Americas
AB	Alberta
AE	Military – Europe
AK	Alaska
AL	Alabama
AP	Military – Pacific
AR	Arkansas
AS	American Samoa
AZ	Arizona
BC	British Columbia
CA	California
CO	Colorado
CT	Connecticut
CZ	Canal Zone
DC	District of Columbia
DE	Delaware
FL	Florida
FM	Federated States of Micronesia
GA	Georgia
GU	Guam
HI	Hawaii
IA	Iowa
ID	Idaho
IL	Illinois
IN	Indiana
KS	Kansas
KY	Kentucky
LA	Louisiana
MA	Massachusetts
MB	Manitoba
MD	Maryland
ME	Maine
MH	Marshall Islands
MI	Michigan
MN	Minnesota
MO	Missouri
MP	Northern Mariana Islands
MS	Mississippi
MT	Montana

**PESC XML Application for Admission Implementation Guide
Version 1.3.0**

Appendix A State and Province Codes Sorted by State and Province Codes	
State and Province Code	State and Province Name
NB	New Brunswick
NC	North Carolina
ND	North Dakota
NE	Nebraska
NF	Newfoundland
NH	New Hampshire
NJ	New Jersey
NL	Newfoundland and Labrador
NM	New Mexico
NS	Nova Scotia
NT	Northwest Territories
NU	Nunavut
NV	Nevada
NY	New York
OH	Ohio
OK	Oklahoma
ON	Ontario
OR	Oregon
PA	Pennsylvania
PE	Prince Edward Island
PR	Puerto Rico
PW	Republic of Palau
QC	Quebec
RI	Rhode Island
SC	South Carolina
SD	South Dakota
SK	Saskatchewan
TN	Tennessee
TX	Texas
UT	Utah
VA	Virginia
VI	Virgin Islands
VT	Vermont
WA	Washington
WI	Wisconsin
WV	West Virginia
WY	Wyoming
YT	Yukon

Appendix B1
Country Codes
ISO 3166-1 Alpha-2 Standard (as of April 2007)
Not to be used for US SEVIS Purposes
Sorted by Code

CountryCode	Description
AD	Andorra
AE	United Arab Emirates
AF	Afghanistan
AG	Antigua And Barbuda
AI	Anguilla
AL	Albania
AM	Armenia
AN	Netherlands Antilles
AO	Angola
AQ	Antarctica
AR	Argentina
AS	American Samoa
AT	Austria
AU	Australia
AW	Aruba
AX	Åland Islands
AZ	Azerbaijan
BA	Bosnia And Herzegovina
BB	Barbados
BD	Bangladesh
BE	Belgium
BF	Burkina Faso
BG	Bulgaria
BH	Bahrain
BI	Burundi
BJ	Benin
BL	Saint-Barthélemy
BM	Bermuda
BN	Brunei Darussalam
BO	Bolivia
BR	Brazil
BS	Bahamas
BT	Bhutan
BV	Bouvet Island
BW	Botswana
BY	Belarus
BZ	Belize
CA	Canada
CC	Cocos (Keeling) Islands

PESC XML Application for Admission Implementation Guide Version 1.3.0

Appendix B1

Country Codes

ISO 3166-1 Alpha-2 Standard (as of April 2007)

Not to be used for US SEVIS Purposes

Sorted by Code

CountryCode	Description
CD	Congo, The Democratic Republic Of The
CF	Central African Republic
CG	Congo
CH	Switzerland
CI	Cote D'ivoire
CK	Cook Islands
CL	Chile
CM	Cameroon
CN	China
CO	Colombia
CR	Costa Rica
CS	Serbia And Montenegro (Deleted as of April 2007 – see ME and RS) *
CU	Cuba
CV	Cape Verde
CX	Christmas Island
CY	Cyprus
CZ	Czech Republic
DE	Germany
DJ	Djibouti
DK	Denmark
DM	Dominica
DO	Dominican Republic
DZ	Algeria
EC	Ecuador
EE	Estonia
EG	Egypt
EH	Western Sahara
ER	Eritrea
ES	Spain
ET	Ethiopia
FI	Finland
FJ	Fiji
FK	Falkland Islands (Malvinas)
FM	Micronesia, Federated States Of
FO	Faroe Islands
FR	France
GA	Gabon
GB	United Kingdom

**PESC XML Application for Admission Implementation Guide
Version 1.3.0**

Appendix B1

Country Codes

ISO 3166-1 Alpha-2 Standard (as of April 2007)

Not to be used for US SEVIS Purposes

Sorted by Code

CountryCode	Description
GD	Grenada
GE	Georgia
GF	French Guiana
GG	Guernsey
GH	Ghana
GI	Gibraltar
GL	Greenland
GM	Gambia
GN	Guinea
GP	Guadeloupe
GQ	Equatorial Guinea
GR	Greece
GS	South Georgia And The South Sandwich Islands
GT	Guatemala
GU	Guam
GW	Guinea Bissau
GY	Guyana
HK	Hong Kong
HM	Heard Island And Mcdonald Islands
HN	Honduras
HR	Croatia
HT	Haiti
HU	Hungary
ID	Indonesia
IE	Ireland
IL	Israel
IM	Isle of Man
IN	India
IO	British Indian Ocean Territory
IQ	Iraq
IR	Iran, Islamic Republic Of
IS	Iceland
IT	Italy
JE	Jersey
JM	Jamaica
JO	Jordan
JP	Japan
KE	Kenya
KG	Kyrgyzstan

**PESC XML Application for Admission Implementation Guide
Version 1.3.0**

Appendix B1

Country Codes

ISO 3166-1 Alpha-2 Standard (as of April 2007)

Not to be used for US SEVIS Purposes

Sorted by Code

CountryCode	Description
KH	Cambodia
KI	Kiribati
KM	Comoros
KN	Saint Kitts And Nevis
KP	Korea, Democratic People's Republic Of
KR	Korea, Republic Of
KW	Kuwait
KY	Cayman Islands
KZ	Kazakhstan
LA	Lao People's Democratic Republic
LB	Lebanon
LC	Saint Lucia
LI	Liechtenstein
LK	Sri Lanka
LR	Liberia
LS	Lesotho
LT	Lithuania
LU	Luxembourg
LV	Latvia
LY	Libyan Arab Jamahiriya
MA	Morocco
MC	Monaco
MD	Moldova, Republic Of
ME	Montenegro
MF	Saint Martin (French Part)
MG	Madagascar
MH	Marshall Islands
MK	Macedonia, The Former Yugoslav Republic Of
ML	Mali
MM	Myanmar
MN	Mongolia
MO	Macao
MP	Northern Mariana Islands
MQ	Martinique
MR	Mauritania
MS	Montserrat
MT	Malta
MU	Mauritius
MV	Maldives

**PESC XML Application for Admission Implementation Guide
Version 1.3.0**

Appendix B1

Country Codes

ISO 3166-1 Alpha-2 Standard (as of April 2007)

Not to be used for US SEVIS Purposes

Sorted by Code

CountryCode Description

MW	Malawi
MX	Mexico
MY	Malaysia
MZ	Mozambique
NA	Namibia
NC	New Caledonia
NE	Niger
NF	Norfolk Island
NG	Nigeria
NI	Nicaragua
NL	Netherlands
NO	Norway
NP	Nepal
NR	Nauru
NU	Niue
NZ	New Zealand
OM	Oman
PA	Panama
PE	Peru
PF	French Polynesia
PG	Papua New Guinea
PH	Philippines
PK	Pakistan
PL	Poland
PM	Saint Pierre And Miquelon
PN	Pitcairn
PR	Puerto Rico
PS	Palestinian Territory, Occupied
PT	Portugal
PW	Palau
PY	Paraguay
QA	Qatar
RE	Reunion
RO	Romania
RS	Serbia
RU	Russian Federation
RW	Rwanda
SA	Saudi Arabia
SB	Solomon Islands

**PESC XML Application for Admission Implementation Guide
Version 1.3.0**

Appendix B1

Country Codes

ISO 3166-1 Alpha-2 Standard (as of April 2007)

Not to be used for US SEVIS Purposes

Sorted by Code

CountryCode	Description
--------------------	--------------------

SC	Seychelles
SD	Sudan
SE	Sweden
SG	Singapore
SH	Saint Helena
SI	Slovenia
SJ	Svalbard And Jan Mayen
SK	Slovakia
SL	Sierra Leone
SM	San Marino
SN	Senegal
SO	Somalia
SR	Suriname
ST	Sao Tome And Principe
SV	El Salvador
SY	Syrian Arab Republic
SZ	Swaziland
TC	Turks And Caicos Islands
TD	Chad
TF	French Southern Territories
TG	Togo
TH	Thailand
TJ	Tajikistan
TK	Tokelau
TL	Timor Leste
TM	Turkmenistan
TN	Tunisia
TO	Tonga
TR	Turkey
TT	Trinidad And Tobago
TV	Tuvalu
TW	Taiwan, Province Of China
TZ	Tanzania, United Republic Of
UA	Ukraine
UG	Uganda
UM	United States Minor Outlying Islands
US	United States
UY	Uruguay
UZ	Uzbekistan

**PESC XML Application for Admission Implementation Guide
Version 1.3.0**

Appendix B1

Country Codes

ISO 3166-1 Alpha-2 Standard (as of April 2007)

Not to be used for US SEVIS Purposes

Sorted by Code

CountryCode	Description
--------------------	--------------------

VA	Holy See (Vatican City State)
VC	Saint Vincent And The Grenadines
VE	Venezuela
VG	Virgin Islands, British
VI	Virgin Islands, U.S.
VN	Viet Nam
VU	Vanuatu
WF	Wallis And Futuna
WS	Samoa
YE	Yemen
YT	Mayotte
ZA	South Africa
ZM	Zambia
ZW	Zimbabwe

**Appendix B2
Country Codes**

ISO 3166-1 Alpha-2 Standard (as of April 2007)

Not to be used for US SEVIS Purposes

Sorted by Country Name

CountryCode	Description
AD	Andorra
AF	Afghanistan
AX	Åland Islands
AL	Albania
DZ	Algeria
AS	American Samoa
AO	Angola
AI	Anguilla
AQ	Antarctica
AG	Antigua And Barbuda
AR	Argentina
AM	Armenia
AW	Aruba
AU	Australia
AT	Austria
AZ	Azerbaijan
BS	Bahamas
BH	Bahrain
BD	Bangladesh
BB	Barbados
BY	Belarus
BE	Belgium
BZ	Belize
BJ	Benin
BM	Bermuda
BT	Bhutan
BO	Bolivia
BA	Bosnia And Herzegovina
BW	Botswana
BV	Bouvet Island
BR	Brazil
IO	British Indian Ocean Territory
BN	Brunei Darussalam
BG	Bulgaria
BF	Burkina Faso
BI	Burundi
KH	Cambodia
CM	Cameroon
CA	Canada

**PESC XML Application for Admission Implementation Guide
Version 1.3.0**

**Appendix B2
Country Codes**

ISO 3166-1 Alpha-2 Standard (as of April 2007)

Not to be used for US SEVIS Purposes

Sorted by Country Name

CountryCode Description

CV	Cape Verde
KY	Cayman Islands
CF	Central African Republic
TD	Chad
CL	Chile
CN	China
CX	Christmas Island
CC	Cocos (Keeling) Islands
CO	Colombia
KM	Comoros
CG	Congo
CD	Congo, The Democratic Republic Of The
CK	Cook Islands
CR	Costa Rica
CI	Cote D'ivoire
HR	Croatia
CU	Cuba
CY	Cyprus
CZ	Czech Republic
DK	Denmark
DJ	Djibouti
DM	Dominica
DO	Dominican Republic
EC	Ecuador
EG	Egypt
SV	El Salvador
GQ	Equatorial Guinea
ER	Eritrea
EE	Estonia
ET	Ethiopia
FK	Falkland Islands (Malvinas)
FO	Faroe Islands
FJ	Fiji
FI	Finland
FR	France
GF	French Guiana
PF	French Polynesia
TF	French Southern Territories
GA	Gabon

**PESC XML Application for Admission Implementation Guide
Version 1.3.0**

**Appendix B2
Country Codes**

ISO 3166-1 Alpha-2 Standard (as of April 2007)

Not to be used for US SEVIS Purposes

Sorted by Country Name

CountryCode Description

GM	Gambia
GE	Georgia
DE	Germany
GH	Ghana
GI	Gibraltar
GR	Greece
GL	Greenland
GD	Grenada
GP	Guadeloupe
GU	Guam
GT	Guatemala
GG	Guernsey
GN	Guinea
GW	Guinea Bissau
GY	Guyana
HT	Haiti
HM	Heard Island And Mcdonald Islands
VA	Holy See (Vatican City State)
HN	Honduras
HK	Hong Kong
HU	Hungary
IS	Iceland
IN	India
ID	Indonesia
IR	Iran, Islamic Republic Of
IQ	Iraq
IE	Ireland
IM	Isle of Man
IL	Israel
IT	Italy
JM	Jamaica
JP	Japan
JE	Jersey
JO	Jordan
KZ	Kazakhstan
KE	Kenya
KI	Kiribati
KP	Korea, Democratic People's Republic Of
KR	Korea, Republic Of

**PESC XML Application for Admission Implementation Guide
Version 1.3.0**

**Appendix B2
Country Codes**

ISO 3166-1 Alpha-2 Standard (as of April 2007)

Not to be used for US SEVIS Purposes

Sorted by Country Name

CountryCode Description

KW	Kuwait
KG	Kyrgyzstan
LA	Lao People's Democratic Republic
LV	Latvia
LB	Lebanon
LS	Lesotho
LR	Liberia
LY	Libyan Arab Jamahiriya
LI	Liechtenstein
LT	Lithuania
LU	Luxembourg
MO	Macao
MK	Macedonia, The Former Yugoslav Republic Of
MG	Madagascar
MW	Malawi
MY	Malaysia
MV	Maldives
ML	Mali
MT	Malta
MH	Marshall Islands
MQ	Martinique
MR	Mauritania
MU	Mauritius
YT	Mayotte
MX	Mexico
FM	Micronesia, Federated States Of
MD	Moldova, Republic Of
MC	Monaco
MN	Mongolia
ME	Montenegro
MS	Montserrat
MA	Morocco
MZ	Mozambique
MM	Myanmar
NA	Namibia
NR	Nauru
NP	Nepal
NL	Netherlands
AN	Netherlands Antilles

PESC XML Application for Admission Implementation Guide Version 1.3.0

Appendix B2

Country Codes

ISO 3166-1 Alpha-2 Standard (as of April 2007)

Not to be used for US SEVIS Purposes

Sorted by Country Name

CountryCode	Description
-------------	-------------

NC	New Caledonia
NZ	New Zealand
NI	Nicaragua
NE	Niger
NG	Nigeria
NU	Niue
NF	Norfolk Island
MP	Northern Mariana Islands
NO	Norway
OM	Oman
PK	Pakistan
PW	Palau
PS	Palestinian Territory, Occupied
PA	Panama
PG	Papua New Guinea
PY	Paraguay
PE	Peru
PH	Philippines
PN	Pitcairn
PL	Poland
PT	Portugal
PR	Puerto Rico
QA	Qatar
RE	Reunion
RO	Romania
RU	Russian Federation
RW	Rwanda
BL	Saint-Barthélemy
SH	Saint Helena
KN	Saint Kitts And Nevis
LC	Saint Lucia
MF	Saint Martin (French Part)
PM	Saint Pierre And Miquelon
VC	Saint Vincent And The Grenadines
WS	Samoa
SM	San Marino
ST	Sao Tome And Principe
SA	Saudi Arabia
SN	Senegal

**PESC XML Application for Admission Implementation Guide
Version 1.3.0**

**Appendix B2
Country Codes**

ISO 3166-1 Alpha-2 Standard (as of April 2007)

Not to be used for US SEVIS Purposes

Sorted by Country Name

CountryCode	Description
RS	Serbia
CS	Serbia And Montenegro (Deleted as of April 2007 – see ME and RS)
SC	Seychelles
SL	Sierra Leone
SG	Singapore
SK	Slovakia
SI	Slovenia
SB	Solomon Islands
SO	Somalia
ZA	South Africa
GS	South Georgia And The South Sandwich Islands
ES	Spain
LK	Sri Lanka
SD	Sudan
SR	Suriname
SJ	Svalbard And Jan Mayen
SZ	Swaziland
SE	Sweden
CH	Switzerland
SY	Syrian Arab Republic
TW	Taiwan, Province Of China
TJ	Tajikistan
TZ	Tanzania, United Republic Of
TH	Thailand
TL	Timor Leste
TG	Togo
TK	Tokelau
TO	Tonga
TT	Trinidad And Tobago
TN	Tunisia
TR	Turkey
TM	Turkmenistan
TC	Turks And Caicos Islands
TV	Tuvalu
UG	Uganda
UA	Ukraine
AE	United Arab Emirates
GB	United Kingdom
US	United States

**PESC XML Application for Admission Implementation Guide
Version 1.3.0**

Appendix B2

Country Codes

ISO 3166-1 Alpha-2 Standard (as of April 2007)

Not to be used for US SEVIS Purposes

Sorted by Country Name

CountryCode	Description
--------------------	--------------------

UM	United States Minor Outlying Islands
UY	Uruguay
UZ	Uzbekistan
VU	Vanuatu
VE	Venezuela
VN	Viet Nam
VG	Virgin Islands, British
VI	Virgin Islands, U.S.
WF	Wallis And Futuna
EH	Western Sahara
YE	Yemen
ZM	Zambia
ZW	Zimbabwe

**PESC XML Application for Admission Implementation Guide
Version 1.3.0**

Appendix C1: ISO 639-2 Language Codes http://www.loc.gov/standards/iso639-2/php/code_list.php Sorted by Language Code	
Language Code	Description
AAR	Afar
ABK	Abkhazian
ACE	Achinese
ACH	Acoli
ADA	Adangme
ADY	Adyghe; Adygei
AFA	Afro-Asiatic (Other)
AFH	Afrihili
AFR	Afrikaans
AIN	Ainu
AKA	Akan
AKK	Akkadian
ALB	Albanian
ALE	Aleut
ALG	Algonquian Languages
ALT	Southern Altai
AMH	Amharic
ANG	English, Old (ca. 450-1100)
ANP	Angika
APA	Apache Languages
ARA	Arabic
ARC	Aramaic (700-300 BCE); Imperial Aramaic (700-300 BCE)
ARG	Aragonese
ARM	Armenian
ARN	Mapudungun; Mapuche
ARP	Arapaho
ART	Artificial (Other)
ARW	Arawak
ASM	Assamese
AST	Asturian; Bable
ATH	Athapascan Languages

**PESC XML Application for Admission Implementation Guide
Version 1.3.0**

Appendix C1: ISO 639-2 Language Codes http://www.loc.gov/standards/iso639-2/php/code_list.php Sorted by Language Code	
Language Code	Description
AUS	Australian Languages
AVA	Avaric
AVE	Avestan
AWA	Awadhi
AYM	Aymara
AZE	Azerbaijani
BAD	Banda Languages
BAI	Bamileke Languages
BAM	Bambara
BAN	Balinese
BAQ	Basque
BAS	Basa
BAT	Baltic (Other)
BEJ	Beja
BEL	Belarusian
BEM	Bemba
BEN	Bengali
BER	Berber (Other)
BHO	Bhojpuri
BIH	Bihari
BIK	Bikol
BIN	Bini; Edo
BIS	Bislama
BLA	Siksika
BNT	Bantu (Other)
BOD	Tibetan
BOS	Bosnian
BRA	BRAJ
BRE	Breton
BTK	Batak Languages
BUA	Buriat

**PESC XML Application for Admission Implementation Guide
Version 1.3.0**

Appendix C1: ISO 639-2 Language Codes http://www.loc.gov/standards/iso639-2/php/code_list.php Sorted by Language Code	
Language Code	Description
BUG	Buginese
BUL	Bulgarian
BYN	Bilin; Blin
CAD	Caddo
CAI	Central American Indian (Other)
CAR	Galibi Carib
CAT	Catalan; Valencian
CAU	Caucasian (Other)
CEB	Cebuano
CEL	Celtic (Other)
CES	Czech
CHA	Chamorro
CHB	Chibcha
CHE	Chechen
CHG	Chagatai
CHI	Chinese
CHK	Chuukese
CHM	Mari
CHN	Chinook Jargon
CHO	Choctaw
CHP	Chipewyan
CHR	Cherokee
CHU	Church Slavonic; Old Slavonic; Church Slavonic; Old Bulgarian; Old Church Slavonic
CHV	Chuvash
CHY	Cheyenne
CMC	Chamic Languages
COP	Coptic
COR	Cornish
COS	Corsican
CPE	Creoles and Pidgins, English Based (Other)

**PESC XML Application for Admission Implementation Guide
Version 1.3.0**

Appendix C1: ISO 639-2 Language Codes http://www.loc.gov/standards/iso639-2/php/code_list.php Sorted by Language Code	
Language Code	Description
CPF	Creoles and Pidgins, French Based (Other)
CPP	Creoles and Pidgins, Portuguese Based (Other)
CRE	Cree
CRH	Crimean Tatar; Crimean Turkish
CRP	Creoles and Pidgins (Other)
CSB	Kashubian
CUS	Cushitic (Other)
CYM	Welsh
CZE	Czech
DAK	Dakota
DAN	Danish
DAR	Dargwa
DAY	Dayak (Land) Languages
DEL	Delaware
DEN	Slave (Athapascan)
DEU	German
DGR	Dogrib
DIN	Dinka
DIV	Divehi; Dhivehi; Maldivian
DOI	Dogri
DRA	Dravidian (Other)
DSB	Lower Sorbian
DUA	Duala
DUM	Dutch, Middle (ca. 1050–1350)
DUT	Dutch; Flemish
DYU	Dyula
DZO	Dzongkha
EFI	Efik
EGY	Egyptian (Ancient)
EKA	Ekajuk
ELL	Greek, Modern (1453-)

**PESC XML Application for Admission Implementation Guide
Version 1.3.0**

Appendix C1: ISO 639-2 Language Codes http://www.loc.gov/standards/iso639-2/php/code_list.php Sorted by Language Code	
Language Code	Description
ELX	Elamite
ENG	English
ENM	English, Middle (1100-1500)
EPO	Esperanto
EST	Estonian
EUS	Basque
EWE	Ewe
EWO	Ewondo
FAN	Fang
FAO	Faroese
FAS	Persian
FAT	Fanti
FIJ	Fijian
FIL	Filipino; Pilipino
FIN	Finnish
FIU	Finno-Ugrian (Other)
FON	Fon
FRA	French
FRE	French
FRM	French, Middle (ca. 1400-1600)
FRO	French, Old (842-ca. 1400)
FRR	Frisian, Northern
FRS	Frisian, Eastern
FRY	Frisian, Western
FUL	Fulah
FUR	Friulian
GAA	Ga
GAY	Gayo
GBA	Gbaya
GEM	Germanic (Other)
GEO	Georgian

**PESC XML Application for Admission Implementation Guide
Version 1.3.0**

Appendix C1: ISO 639-2 Language Codes http://www.loc.gov/standards/iso639-2/php/code_list.php Sorted by Language Code	
Language Code	Description
GER	German
GEZ	Geez
GIL	Gilbertese
GLA	Gaelic; Scottish Gaelic
GLE	Irish
GLG	Galician
GLV	Manx
GMH	German, Middle High (ca.1050-1500)
GOH	German, Old High (ca. 750-1050)
GON	Gondi
GOR	Gorontalo
GOT	Gothic
GRB	Grebo
GRC	Greek, Ancient (to 1453)
GRE	Greek, Modern (1453-)
GRN	Guarani
GSW	Swiss German, Alemannic
GUJ	Gujarati
GWI	Gwich'in
HAI	Haida
HAT	Taitian; Haitian Creole
HAU	Hausa
HAW	Hawaiian
HEB	Hebrew
HER	Herero
HIL	Hiligaynon
HIM	Himigaynon
HIN	Hindi
HIT	Hittite
HMN	Hmong
HMO	Hiri Motu

**PESC XML Application for Admission Implementation Guide
Version 1.3.0**

Appendix C1: ISO 639-2 Language Codes http://www.loc.gov/standards/iso639-2/php/code_list.php Sorted by Language Code	
Language Code	Description
HRV	Croatian
HSB	Sorbian (Upper)
HUN	Hungarian
HUP	Hupa
HYE	Armenian
IBA	Iban
IBO	Igbo
ICE	Icelandic
IDO	Ido
III	Sichuan Yi
IJO	Ijo Languages
IKU	Inuktitut
ILE	Interlingue
ILO	Iloko
INA	Interlingua (International Auxiliary Language Association)
INC	Indic (Other)
IND	Indonesian
INE	Indo-European (Other)
INH	Ingush
IPK	Inupiaq
IRA	Iranian (Other)
IRO	Iroquoian Languages
ISL	Icelandic
ITA	Italian
JAV	Javanese
JBO	Lojban
JPN	Japanese
JPR	Judeo-Persian
JRB	Judeo-Arabic
KAA	Kara-Kalpak
KAB	Kabyle

**PESC XML Application for Admission Implementation Guide
Version 1.3.0**

Appendix C1: ISO 639-2 Language Codes http://www.loc.gov/standards/iso639-2/php/code_list.php Sorted by Language Code	
Language Code	Description
KAC	Kachin; Jingpho
KAL	Greenlandic; Kalaallisut
KAM	Kamba
KAN	Kannada
KAR	Karen Languages
KAS	Kashmiri
KAT	Georgian
KAU	Kanuri
KAW	Kawi
KAZ	Kazakh
KBD	Kabardian
KHA	Khasi
KHI	Khoisan (Other)
KHM	Khmer (Central)
KHO	Khotanese
KIK	Kikuyu; Gikuyu
KIN	Kinyarwanda
KIR	Kirghiz; Kyrgyz
KMB	Kimbundu
KOK	Konkani
KOM	Komi
KON	Kongo
KOR	Korean
KOS	Kosraean
KPE	Kpelle
KRC	Karachay-Balkar
KRL	Karelian
KRO	Kru Languages
KRU	Kurukh
KUA	Kuanyama; Kwanyama
KUM	Kumyk

**PESC XML Application for Admission Implementation Guide
Version 1.3.0**

Appendix C1: ISO 639-2 Language Codes http://www.loc.gov/standards/iso639-2/php/code_list.php Sorted by Language Code	
Language Code	Description
KUR	Kurdish
KUT	Kutenai
LAD	Ladino
LAH	Lahnda
LAM	Lamba
LAO	Lao
LAT	Latin
LAV	Latvian
LEZ	Lezghian
LIM	Limburgan; Limburger; Limburgish
LIN	Lithuanian
LOL	Mongo
LOZ	Lozi
LTZ	Luxembourgish; Letzeburgesch
LUA	Luba-Lulua
LUB	Luba-Katanga
LUG	Ganda
LUI	Luiseno
LUN	Lunda
LUO	Luo (Kenya and Tanzania)
LUS	Lushai
MAC	Macedonian
MAD	Madurese
MAG	Magahi
MAH	Marshallese
MAI	Maithili
MAK	Makasar
MAL	Malayalam
MAN	Mandingo
MAO	Maori
MAP	Austronesian (Other)

**PESC XML Application for Admission Implementation Guide
Version 1.3.0**

Appendix C1: ISO 639-2 Language Codes http://www.loc.gov/standards/iso639-2/php/code_list.php Sorted by Language Code	
Language Code	Description
MAR	Marathi
MAS	Masai
MAY	Malay
MDF	Moksha
MDR	Mandar
MEN	Mende
MGA	Irish, Middle (900-1200)
MIC	Mi'kmaq; Micmac
MIG	Malagasy
MIN	Minangkabau
MIS	Uncoded Languages
MKD	Macedonian
MKH	Mon-Khmer (Other)
MLT	Maltese
MNC	Manchu
MNI	Manipuri
MNO	Manobo Languages
MOH	Mohawk
MOL	Moldavian
MON	Mongolian
MOS	Mossi
MRI	Maori
MSA	Malay
MUL	Multiple Languages
MUN	Munda Languages
MUS	Creek
MWL	Mirandese
MWR	Marwari
MYA	Burmese
MYA	Burmese
MYN	Mayan Languages

**PESC XML Application for Admission Implementation Guide
Version 1.3.0**

Appendix C1: ISO 639-2 Language Codes http://www.loc.gov/standards/iso639-2/php/code_list.php Sorted by Language Code	
Language Code	Description
MYV	Erzya
NAH	Nahuatl Languages
NAI	North American Indian
NAP	Neapolitan
NAU	Nauru
NAV	Navajo; Navaho
NBL	Nddbele, South; South Ndebele
NDE	Ndebele, North; North Ndebele
NDO	Ndonga
NDS	Low German; Low Saxon; German, Low; Saxon, Low
NEP	Nepali
NEW	Nepal Bhasa; Newari
NIA	Nias
NIC	Niger-Kordofanian (Other)
NIU	Niuean
NLD	Dutch, Flemish
NNO	Norwegian Nynorsk; Nynorsk, Norwegian
NOB	Bokmål, Norwegian; Norwegian Bokmål
NOG	Nogai
NON	Norse, Old
NOR	Norwegian
NQO	N'Ko
NSO	Northern Sotho; Pedi; Sepedi
NUB	Nubian Languages
NWC	Nepal Bhasa, Classical; Classical Newari
NYA	Nyanja; Chichewa; Chewa
NYM	Nyamwezi
NYN	Nyankole
NYO	Nyoro
NZI	Nzima
OCI	Occitan (post 1500); Provençal

**PESC XML Application for Admission Implementation Guide
Version 1.3.0**

Appendix C1: ISO 639-2 Language Codes http://www.loc.gov/standards/iso639-2/php/code_list.php Sorted by Language Code	
Language Code	Description
OJI	Ojibwa
ORI	Oriya
ORM	Oromo
OSA	Osage
OSS	Ossetian; Ossetic
OTA	Turkish, Ottoman (1500-1928)
OTO	Otomian Languages
PAA	Papuan (Other)
PAG	Pangasinan
PAL	Pahlavi
PAM	Pampanga
PAN	Panjabi; Punjabi
PAP	Papiamento
PAU	Palauan
PEO	Persian, Old (ca. 600-400 B.C.)
PER	Persian
PHI	Philippine (Other)
PHN	Phoenician
PLI	Pali
POL	Polish
PON	Pohnpeian
POR	Portuguese
PRA	Prakrit Languages
PRO	Provençal, Old (to 1500)
PUS	Pushto
QAA	Reserved for Local Use
QTZ	Reserved for Local Use
QUE	Quechua
RAJ	Rajasthani
RAP	Rapanui
RAR	Rarotongan; Cook Islands Maori

**PESC XML Application for Admission Implementation Guide
Version 1.3.0**

Appendix C1: ISO 639-2 Language Codes http://www.loc.gov/standards/iso639-2/php/code_list.php Sorted by Language Code	
Language Code	Description
ROA	Romance (Other)
ROH	Romansh
ROM	Romany
RON	Romanian
RUM	Romanian
RUN	Rundi
RUP	Aromanian, Arumanian; Macedo-Romanian
RUS	Russian
SAD	Sandawe
SAG	Sango
SAH	Yakut
SAI	South American Indian (Other)
SAL	Salishan Languages
SAM	Samaritan Aramaic
SAN	Sanskrit
SAS	Sasak
SAT	Santali
SCC	Serbian
SCN	Sicilian
SCO	Scots
SCR	Croatian
SEL	Selkup
SEM	Semitic (Other)
SGA	Irish, Old (to 900)
SGN	Sign Languages
SHN	Shan
SID	Sidamo
SIN	Sinhala; Sinhalese
SIO	Siouan Languages
SIT	Sino-Tibetan (Other)
SLA	Slavic (Other)

**PESC XML Application for Admission Implementation Guide
Version 1.3.0**

Appendix C1: ISO 639-2 Language Codes http://www.loc.gov/standards/iso639-2/php/code_list.php Sorted by Language Code	
Language Code	Description
SLK	Slovak
SLO	Slovak
SLV	Slovenian
SMA	Southern Sami
SME	Northern Sami
SMI	Sami Languages (Other)
SMJ	Lule Sami
SMN	Inari Sami
SMO	Samoaan
SMS	Skolt Sami
SNA	Shona
SND	Sindhi
SNK	Soninke
SOG	Sogdian
SOM	Somali
SON	Songhai Languages
SOT	Sotho, Southern
SPA	Spanish, Castilian
SQI	Albanian
SQI	Albanian
SRD	Sardinian
SRN	Sranan Tongo
SRP	Serbian
SRR	Serer
SSA	Nilo-Saharan (Other)
SSW	Swati
SUK	Sukuma
SUN	Sundanese
SUS	Susu
SUX	Sumerian
SWA	Swahili

**PESC XML Application for Admission Implementation Guide
Version 1.3.0**

Appendix C1: ISO 639-2 Language Codes http://www.loc.gov/standards/iso639-2/php/code_list.php Sorted by Language Code	
Language Code	Description
SWE	Swedish
SYC	Syriac, Classical
SYR	Syriac
TAH	Tahitian
TAI	Tai (Other)
TAM	Tamil
TAT	Tatar
TEL	Telugu
TEM	Timne
TER	Tereno
TET	Tetum
TGK	Tajik
TGL	Tagalog
THA	Thai
TIB	Tibetan
TIB	Tibetan
TIG	Tigre
TIR	Tigrinya
TIV	Tiv
TKL	Tokelau
TLH	TlhIngan-Hol; Klingon
TLI	Tlingit
TMH	Tamashek
TOG	Tonga (Nyasa)
TON	Tonga (Tonga Islands)
TPI	Tok Pisin
TSI	Tsimshian
TSN	Tswana
TSO	Tsonga
TUK	Turkmen
TUM	Tumbuka

**PESC XML Application for Admission Implementation Guide
Version 1.3.0**

Appendix C1: ISO 639-2 Language Codes http://www.loc.gov/standards/iso639-2/php/code_list.php Sorted by Language Code	
Language Code	Description
TUP	Tupi Languages
TUR	Turkish
TUT	Altaic (Other)
TVL	Tuvalu
TWI	Twi
TYV	Tuvinian
UDM	Udmurt
UGA	Ugaritic
UIG	Uighur; Uyghur
UKR	Ukrainian
UMB	Umbundu
UND	Undetermined
URD	Urdu
UZB	Uzbek
VAI	Vai
VEN	Venda
VIE	Vietnamese
VOL	Volapük
VOT	Votic
WAK	Wakashan Languages
WAL	Walamo
WAR	Waray
WAS	Washo
WEL	Welsh
WEN	Sorbian Languages
WLN	Walloon
WOL	Wolof
XAL	Kalmyk; Oirat
XHO	Xhosa
YAO	Yao
YAP	Yapese

**PESC XML Application for Admission Implementation Guide
Version 1.3.0**

Appendix C1: ISO 639-2 Language Codes http://www.loc.gov/standards/iso639-2/php/code_list.php Sorted by Language Code	
Language Code	Description
YID	Yiddish
YOR	Yoruba
YPK	Yupik Languages
ZAP	Zapotec
ZEN	Zenaga
ZHA	Zhuang; Chuang
ZHO	Chinese
ZND	Zande languages
ZUL	Zulu
ZUN	Zuni
ZXX	No linguistic content
ZZA	Zaza; Dimili; Dimli; Kirdki; Kirmanjki; Zazaki

**PESC XML Application for Admission Implementation Guide
Version 1.3.0**

Appendix C2: ISO 639-2 Language Codes http://www.loc.gov/standards/iso639-2/php/code_list.php Sorted by Name of Language	
Language Code	Description
AAR	Afar
ABK	Abkhazian
ACE	Achinese
ACH	Acoli
ADA	Adangme
ADY	Adyghe; Adygei
AFH	Afrihili
AFR	Afrikaans
AFA	Afro-Asiatic (Other)
AIN	Ainu
AKA	Akan
AKK	Akkadian
ALB	Albanian
SQI	Albanian
SQI	Albanian
ALE	Aleut
ALG	Algonquian Languages
TUT	Altaic (Other)
AMH	Amharic
ANP	Angika
APA	Apache Languages
ARA	Arabic
ARG	Aragonese
ARC	Aramaic (700-300 BCE); Imperial Aramaic (700-300 BCE)
ARP	Arapaho
ARW	Arawak
ARM	Armenian
HYE	Armenian
RUP	Aromanian, Arumanian; Macedo-Romanian
ART	Artificial (Other)

**PESC XML Application for Admission Implementation Guide
Version 1.3.0**

Appendix C2: ISO 639-2 Language Codes http://www.loc.gov/standards/iso639-2/php/code_list.php Sorted by Name of Language	
Language Code	Description
ASM	Assamese
AST	Asturian; Bable
ATH	Athapascan Languages
DEN	Athapascan Slave
AUS	Australian Languages
MAP	Austronesian (Other)
AVA	Avaric
AVE	Avestan
AWA	Awadhi
AYM	Aymara
AZE	Azerbaijani
AST	Bable, Asturian
BAN	Balinese
BAT	Baltic (Other)
BAM	Bambara
BAI	Bamileke Languages
BAD	Banda Languages
BNT	Bantu (Other)
BAS	Basa
BAQ	Basque
EUS	Basque
BTK	Batak Languages
BEJ	Beja
BEL	Belarusian
BEM	Bemba
BEN	Bengali
BER	Berber (Other)
BHO	Bhojpuri
BIH	Bihari
BIK	Bihari
BYN	Bilin; Blin

**PESC XML Application for Admission Implementation Guide
Version 1.3.0**

Appendix C2: ISO 639-2 Language Codes http://www.loc.gov/standards/iso639-2/php/code_list.php Sorted by Name of Language	
Language Code	Description
BIN	Bini; Edo
BIS	Bislama
BYN	Blin; Bilin
NOB	Bokmål, Norwegian; Norwegian Bokmål
BOS	Bosnian
BRA	BRAJ
BRE	Breton
BUG	Buginese
BUL	Bulgarian
CHU	Bulgarian (Old); Church Slavic; Old Slavonic; Church Slavonic; Old Church Slavonic
BUA	Buriat
MYA	Burmese
MYA	Burmese
CAD	Caddo
CAT	Catalan; Valencian
CAU	Caucasian (Other)
CEB	Cebuano
CEL	Celtic (Other)
CAI	Central American Indian (Other)
CHG	Chagatai
CMC	Chamic Languages
CHA	Chamorro
CHE	Chechen
CHR	Cherokee
CHY	Cheyenne
CHB	Chibcha
NYA	Chichewa; Chewa; Nyanja
CHI	Chinese
ZHO	Chinese
ZHO	Chinese

**PESC XML Application for Admission Implementation Guide
Version 1.3.0**

Appendix C2: ISO 639-2 Language Codes	
http://www.loc.gov/standards/iso639-2/php/code_list.php	
Sorted by Name of Language	
Language Code	Description
CHN	Chinook Jargon
CHP	Chipewyan
CHO	Choctaw
ZHA	Chuang; Zhuang
CHU	Church Slavic; Old Slavonic; Church Slavonic; Old Bulgarian; Old Church Slavonic
CHK	Chuukese
CHV	Chuvash
RAR	Cook Islands Maori; Rarotongan
COP	Coptic
COR	Cornish
COS	Corsican
CRE	Cree
MUS	Creek
CRP	Creoles and Pidgins (Other)
CPE	Creoles and Pidgins, English Based (Other)
CPF	Creoles and Pidgins, French Based (Other)
CPP	Creoles and Pidgins, Portuguese Based (Other)
CRH	Crimean Tatar; Crimean Turkish
HRV	Croatian
SCR	Croatian
CUS	Cushitic (Other)
CES	Czech
CZE	Czech
DAK	Dakota
DAN	Danish
DAR	Dargwa
DAY	Dayak (Land) Languages
DEL	Delaware
ZZA	Dimili; Dimli; Kirdki; Kirmanjki; Zazaki; Zaza
DIN	Dinka

**PESC XML Application for Admission Implementation Guide
Version 1.3.0**

Appendix C2: ISO 639-2 Language Codes http://www.loc.gov/standards/iso639-2/php/code_list.php Sorted by Name of Language	
Language Code	Description
DIV	Divehi; Dhivehi; Maldivian
DOI	Dogri
DGR	Dogrib
DRA	Dravidian (Other)
DUA	Duala
NLD	Dutch, Flemish
DUM	Dutch, Middle (ca. 1050–1350)
DUT	Dutch; Flemish
NLD	Dutch; Flemish
DYU	Dyula
DZO	Dzongkha
BIN	Edo; Bini
EFI	Efik
EGY	Egyptian (Ancient)
EKA	Ekajuk
ELX	Elamite
ENG	English
ENM	English, Middle (1100-1500)
ANG	English, Old (ca. 450-1100)
MYV	Erzya
EPO	Esperanto
EST	Estonian
EWE	Ewe
EWO	Ewondo
FAN	Fang
FAT	Fanti
FAO	Faroese
FIJ	Fijian
FIL	Filipino; Pilipino
FIN	Finnish
FIU	Finno-Ugrian (Other)

**PESC XML Application for Admission Implementation Guide
Version 1.3.0**

Appendix C2: ISO 639-2 Language Codes	
http://www.loc.gov/standards/iso639-2/php/code_list.php	
Sorted by Name of Language	
Language Code	Description
DUT	Flemish; Dutch
NLD	Flemish; Dutch
FON	Fon
FRA	French
FRE	French
FRM	French, Middle (ca. 1400-1600)
FRO	French, Old (842-ca. 1400)
FRS	Frisian, Eastern
FRR	Frisian, Northern
FRY	Frisian, Western
FUR	Friulian
FUL	Fulah
GAA	Ga
GLA	Gaelic; Scottish Gaelic
CAR	Galibi Carib
GLG	Galician
LUG	Ganda
GAY	Gayo
GBA	Gbaya
GEZ	Geez
GEO	Georgian
KAT	Georgian
DEU	German
GER	German
GSW	German (Swiss); Alemannic
NDS	German, Low; Saxon, Low
GMH	German, Middle High (ca.1050-1500)
GOH	German, Old High (ca. 750-1050)
GEM	Germanic (Other)
KIK	Gikuyu; Kikuyu
GIL	Gilbertese

**PESC XML Application for Admission Implementation Guide
Version 1.3.0**

Appendix C2: ISO 639-2 Language Codes	
http://www.loc.gov/standards/iso639-2/php/code_list.php	
Sorted by Name of Language	
Language Code	Description
GON	Gondi
GOR	Gorontalo
GOT	Gothic
GRB	Grebo
GRC	Greek, Ancient (to 1453)
ELL	Greek, Modern (1453-)
GRE	Greek, Modern (1453-)
KAL	Greenlandic; Kalaallisut
GRN	Guarani
GUJ	Gujarati
GWI	Gwich'in
HAI	Haida
HAU	Hausa
HAW	Hawaiian
HEB	Hebrew
HER	Herero
HIL	Hiligaynon
HIM	Himigaynon
HIN	Hindi
HMO	Hiri Motu
HIT	Hittite
HMN	Hmong
HUN	Hungarian
HUP	Hupa
IBA	Iban
ICE	Icelandic
ISL	Icelandic
IDO	Ido
IBO	Igbo
IJO	Ijo Languages
ILO	Iloko

**PESC XML Application for Admission Implementation Guide
Version 1.3.0**

Appendix C2: ISO 639-2 Language Codes http://www.loc.gov/standards/iso639-2/php/code_list.php Sorted by Name of Language	
Language Code	Description
SMN	Inari Sami
NAI	Indian, North American
SAI	Indian, South American (Other)
INC	Indic (Other)
INE	Indo-European (Other)
IND	Indonesian
INH	Ingush
INA	Interlingua (International Auxiliary Language Association)
ILE	Interlingue
IKU	Inuktitut
IPK	Inupiaq
IRA	Iranian (Other)
GLE	Irish
MGA	Irish, Middle (900-1200)
SGA	Irish, Old (to 900)
IRO	Iroquoian Languages
ITA	Italian
JPN	Japanese
JAV	Javanese
KAC	Jingpho; Kachin
JRB	Judeo-Arabic
JPR	Judeo-Persian
KBD	Kabardian
KAB	Kabyle
KAC	Kachin; Jingpho
KAL	Kalaallisut; Greenlandic
XAL	Kalmyk; Oirat
KAM	Kamba
KAN	Kannada
KAU	Kanuri
KRC	Karachay-Balkar

**PESC XML Application for Admission Implementation Guide
Version 1.3.0**

Appendix C2: ISO 639-2 Language Codes http://www.loc.gov/standards/iso639-2/php/code_list.php Sorted by Name of Language	
Language Code	Description
CAA	Kara-Kalpak
KRL	Karelian
KAR	Karen Languages
KAS	Kashmiri
CSB	Kashubian
KAW	Kawi
KAZ	Kazakh
KHA	Khasi
KHM	Khmer (Central)
KHI	Khoisan (Other)
KHO	Khotanese
KIK	Kikuyu; Gikuyu
KMB	Kimbundu
KIN	Kinyarwanda
ZZA	Kirdki; Kirmanjki; Zazaki; Zaza; Dimili; Dimli;
KIR	Kirghiz; Kyrgyz
TLH	Klingon; tlhIngan-Hol
KOM	Komi
KON	Kongo
KOK	Konkani
KOR	Korean
KOS	Kosraean
KPE	Kpelle
KRO	Kru Languages
KUA	Kuanyama; Kwanyama
KUM	Kumyk
KUR	Kurdish
KRU	Kurukh
KUT	Kutenai
LAD	Ladino
LAH	Lahnda

**PESC XML Application for Admission Implementation Guide
Version 1.3.0**

Appendix C2: ISO 639-2 Language Codes http://www.loc.gov/standards/iso639-2/php/code_list.php Sorted by Name of Language	
Language Code	Description
LAM	Lamba
LAO	Lao
LAT	Latin
LAV	Latvian
LEZ	Lezghian
LIM	Limburgan; Limburger; Limburgish
LIN	Lithuanian
JBO	Lojban
NDS	Low German; Low Saxon; German, Low; Saxon, Low
DSB	Lower Sorbian
LOZ	Lozi
LUB	Luba-Katanga
LUA	Luba-Lulua
LUI	Luiseno
SMJ	Lule Sami
LUN	Lunda
LUO	Luo (Kenya and Tanzania)
LUS	Lushai
LTZ	Luxembourgish; Letzeburgesch
MAC	Macedonian
MKD	Macedonian
RUP	Macedo-Romanian; Aromanian, Arumanian
MAD	Madurese
MAG	Magahi
MAI	Maithili
MAK	Makasar
MIG	Malagasy
MAY	Malay
MSA	Malay
MAL	Malayalam
DIV	Maldivian; Divehi; Dhivehi

**PESC XML Application for Admission Implementation Guide
Version 1.3.0**

Appendix C2: ISO 639-2 Language Codes http://www.loc.gov/standards/iso639-2/php/code_list.php Sorted by Name of Language	
Language Code	Description
MLT	Maltese
MNC	Manchu
MDR	Mandar
MAN	Mandingo
MNI	Manipuri
MNO	Manobo Languages
GLV	Manx
MAO	Maori
MRI	Maori
ARN	Mapudungun; Mapuche
MAR	Marathi
CHM	Mari
MAH	Marshallese
MWR	Marwari
MAS	Masai
MYN	Mayan Languages
MEN	Mende
MIC	Mi'kmaq; Micmac
MIN	Minangkabau
MWL	Mirandese
MOH	Mohawk
MDF	Moksha
MOL	Moldavian
LOL	Mongo
MON	Mongolian
MKH	Mon-Khmer (Other)
MOS	Mossi
MUL	Multiple Languages
MUN	Munda Languages
NQO	N'Ko
NAH	Nahuatl Languages

**PESC XML Application for Admission Implementation Guide
Version 1.3.0**

Appendix C2: ISO 639-2 Language Codes	
http://www.loc.gov/standards/iso639-2/php/code_list.php	
Sorted by Name of Language	
Language Code	Description
NAU	Nauru
NAV	Navajo; Navaho
NBL	Nddbele, South; South Ndebele
NDE	Ndebele, North; North Ndebele
NDO	Ndonga
NAP	Neapolitan
NWC	Nepal Bhasa, Classical; Classical Newari
NEW	Nepal Bhasa; Newari
NEP	Nepali
NWC	Newari, Classical; Old Newari; Classical Nepal Bhasa
NIA	Nias
NIC	Niger-Kordofanian (Other)
SSA	Nilo-Saharan (Other)
NIU	Niuean
ZXX	No linguistic content
NOG	Nogai
NON	Norse, Old
NAI	North American Indian
SME	Northern Sami
NSO	Northern Sotho; Pedi; Sepedi
NOR	Norwegian
NNO	Norwegian Nynorsk; Nynorsk, Norwegian
NUB	Nubian Languages
NYM	Nyamwezi
NYA	Nyanja; Chichewa; Chewa
NYN	Nyankole
NYO	Nyoro
NZI	Nzima
OCI	Occitan (post 1500); Provençal
XAL	Oirat; Kalmyk
OJI	Ojibwa

**PESC XML Application for Admission Implementation Guide
Version 1.3.0**

Appendix C2: ISO 639-2 Language Codes	
http://www.loc.gov/standards/iso639-2/php/code_list.php	
Sorted by Name of Language	
Language Code	Description
ORI	Oriya
ORM	Oromo
OSA	Osage
OSS	Ossetian; Ossetic
OTO	Otomian Languages
PAL	Pahlavi
PAU	Palauan
PLI	Pali
PAM	Pampangana
PAG	Pangasinan
PAN	Panjabi; Punjabi
PAP	Papiamentu
PAA	Papuan (Other)
NSO	Pedi; Sepedi; Northern Sotho
FAS	Persian
PER	Persian
PER	Persian
PEO	Persian, Old (ca. 600-400 B.C.)
PHI	Philippine (Other)
PHN	Phoenician
FIL	Pilipino; Filipino
PON	Pohnpeian
POL	Polish
POR	Portuguese
PRA	Prakrit Languages
PRO	Provençal, Old (to 1500)
PAN	Punjabi; Panjabi
PUS	Pushto
QUE	Quechua
RAJ	Rajasthani
RAP	Rapanui

**PESC XML Application for Admission Implementation Guide
Version 1.3.0**

Appendix C2: ISO 639-2 Language Codes http://www.loc.gov/standards/iso639-2/php/code_list.php Sorted by Name of Language	
Language Code	Description
RAR	Rarotongan; Cook Islands Maori
QAA	Reserved for Local Use
QTZ	Reserved for Local Use
ROA	Romance (Other)
RON	Romanian
RUM	Romanian
ROH	Romansh
ROM	Romany
RUN	Rundi
RUS	Russian
SSA	Saharan, Nilo (Other)
SAL	Salishan Languages
SAM	Samaritan Aramaic
SMI	Sami Languages (Other)
SMN	Sami, Inari
SMJ	Sami, Lule
SME	Sami, Northern
SMS	Sami, Skolt
SMA	Sami, Southern
SMO	Samoan
SAD	Sandawe
SAG	Sango
SAN	Sanskrit
SAT	Santali
SRD	Sardinian
SAS	Sasak
NDS	Saxon, Low; German, Low
SCO	Scots
GLA	Scottish Gaelic
SEL	Selkup
SEM	Semitic (Other)

**PESC XML Application for Admission Implementation Guide
Version 1.3.0**

Appendix C2: ISO 639-2 Language Codes	
http://www.loc.gov/standards/iso639-2/php/code_list.php	
Sorted by Name of Language	
Language Code	Description
SCC	Serbian
SRP	Serbian
SRR	Serer
SHN	Shan
SNA	Shona
III	Sichuan Yi
SCN	Sicilian
SID	Sidamo
SGN	Sign Languages
BLA	Siksika
SND	Sindhi
SIN	Sinhala; Sinhalese
SIT	Sino-Tibetan (Other)
SIO	Siouan Languages
SMS	Skolt Sami
DEN	Slave (Athapaskan)
CHU	Slavic (Church); Old Slavonic; Church Slavonic; Old Bulgarian; Old Church Slavonic
SLA	Slavic (Other)
SLK	Slovak
SLO	Slovak
SLV	Slovenian
SOG	Sogdian
SOM	Somali
SON	Songhai Languages
SNK	Soninke
HSB	Sorbian (Upper)
WEN	Sorbian Languages
DSB	Sorbian, Lower
NSO	Sotho, Northern; Pedi; Sepedi
SOT	Sotho, Southern

**PESC XML Application for Admission Implementation Guide
Version 1.3.0**

Appendix C2: ISO 639-2 Language Codes http://www.loc.gov/standards/iso639-2/php/code_list.php Sorted by Name of Language	
Language Code	Description
SAI	South American Indian (Other)
ALT	Southern Altai
SMA	Southern Sami
SPA	Spanish, Castilian
SRN	Sranan Tongo
SUK	Sukuma
SUX	Sumerian
SUN	Sundanese
SUS	Susu
SWA	Swahili
SSW	Swati
SWE	Swedish
GSW	Swiss German, Alemannic
SYR	Syriac
SYC	Syriac, Classical
TGL	Tagalog
TAH	Tahitian
TAI	Tai (Other)
HAT	Taitian; Haitian Creole
TGK	Tajik
TMH	Tamashek
TAM	Tamil
TAT	Tatar
CRH	Tatar (Crimean); Crimean Turkish
TEL	Telugu
TER	Tereno
TET	Tetum
THA	Thai
BOD	Tibetan
TIB	Tibetan
TIB	Tibetan

**PESC XML Application for Admission Implementation Guide
Version 1.3.0**

Appendix C2: ISO 639-2 Language Codes http://www.loc.gov/standards/iso639-2/php/code_list.php Sorted by Name of Language	
Language Code	Description
TIG	Tigre
TIR	Tigrinya
TEM	Timne
TIV	Tiv
TLH	TlhIngan-Hol; Klingon
TLI	Tlingit
TPI	Tok Pisin
TKL	Tokelau
TOG	Tonga (Nyasa)
TON	Tonga (Tonga Islands)
SRN	Tongo, Sranan
TSI	Tsimshian
TSO	Tsonga
TSN	Tswana
TUM	Tumbuka
TUP	Tupi Languages
TUR	Turkish
CRH	Turkish (Crimean); Crimean Tatar
OTA	Turkish, Ottoman (1500-1928)
TUK	Turkmen
TVL	Tuvalu
TYV	Tuvinian
TWI	Twi
UDM	Udmurt
UGA	Ugaritic
UIG	Uighur; Uyghur
UKR	Ukrainian
UMB	Umbundu
MIS	Uncoded Languages
UND	Undetermined
URD	Urdu

**PESC XML Application for Admission Implementation Guide
Version 1.3.0**

Appendix C2: ISO 639-2 Language Codes http://www.loc.gov/standards/iso639-2/php/code_list.php Sorted by Name of Language	
Language Code	Description
UZB	Uzbek
VAI	Vai
CAT	Valencian; Catalan
VEN	Venda
VIE	Vietnamese
VOL	Volapük
VOT	Votic
WAK	Wakashan Languages
WAL	Walamo
WLN	Walloon
WAR	Waray
WAS	Washo
CYM	Welsh
WEL	Welsh
WEL	Welsh
WOL	Wolof
XHO	Xhosa
SAH	Yakut
YAO	Yao
YAP	Yapese
YID	Yiddish
YOR	Yoruba
YPK	Yupik Languages
ZND	Zande languages
ZAP	Zapotec
ZZA	Zaza; Dimili; Dimli; Kirdki; Kirmanjki; Zazaki
ZEN	Zenaga
ZHA	Zhuang; Chuang
ZUL	Zulu
ZUN	Zuni

PESC XML Application for Admission Implementation Guide Version 1.3.0

**PESC XML Application for Admission Implementation Guide
Version 1.3.0**

Appendix D: Relationship Codes used in Person, Family, Immigration and Residency portions of this Implementation Guide

Relationship Word Code	Explanation
AdultOther	
AdoptedChild	
AdoptedDaughter	
AdoptedSon	
AdoptiveFather	
AdoptiveMother	
AdoptiveParent	
AgencyRepresentative	
Applicant	
Aunt	
AuthorizedDesignate	
Brother	
BrotherInLaw	
Business	
BusinessAssociate	
BusinessPartner	
Child	Dependent between the ages of 0 and 19; age qualifications may vary depending on policy
CollateralDependent	Relative related by blood or marriage who resides in the home and is dependent on the insured for a major portion of support
CommonLawSpouse	
CourtAppointedGuardian	
Cousin	
Daughter	
DaughterInLaw	
Dependent	
DependentOfMinorDependent	A child not legally of age who has been granted adult status
DomesticPartner	
EmancipatedMinor	A person who has been judged by a court of competent jurisdiction to be allowed to act in his or her own interest; no adult is legally responsible for this minor; this may be declared as a result of marriage
EmergencyContact	
Employee	

**PESC XML Application for Admission Implementation Guide
Version 1.3.0**

Appendix D: Relationship Codes used in Person, Family, Immigration and Residency portions of this Implementation Guide	
Relationship Word Code	Explanation
Employer	
ExHusband	
ExSpouse	An ex-spouse of the person
ExWife	
Father	
FatherInLaw	
Fiance	Fiancé (Male)
Fiancee	Fiancée (Female)
FosterChild	
FosterDaughter	
FosterFather	
FosterMother	
FosterParent	
FosterSon	
Friend	
GodDaughter	
GodFather	
GodMother	
GodParent	
GodSon	
GrandChild	
GrandDaughter	
GrandFather	
GrandMother	
GrandParent	
GrandSon	
GreatAunt	
GreatUncle	
Guardian	An adult who is given legal responsibility for a child by a court
HalfBrother	
HalfSister	
HandicappedDependent	
Husband	
LifePartner	

**PESC XML Application for Admission Implementation Guide
Version 1.3.0**

Appendix D: Relationship Codes used in Person, Family, Immigration and Residency portions of this Implementation Guide	
Relationship Word Code	Explanation
Mother	
MotherInLaw	
Neighbor	
Nephew	
Niece	
Other	
Parent	
Parents	The residence or legal custody of the student is with both parents
Partner	
RelationshipOther	
Relative	
Self	
Sibling	
SignificantOther	
Sister	
SisterInLaw	
Son	
SonInLaw	
Sponsor	
SponsoredDependent	Dependents between the ages of 19 and 25 not attending school; age qualifications may vary depending on policy
Spouse	
StepBrother	
StepChild	
StepDaughter	
StepFather	
StepMother	
StepParent	
StepSister	
StepSon	
Student	Dependent between the ages of 19 and 25 attending school; age qualifications may vary depending on policy
Uncle	

**PESC XML Application for Admission Implementation Guide
Version 1.3.0**

Appendix D: Relationship Codes used in Person, Family, Immigration and Residency portions of this Implementation Guide	
Relationship Word Code	Explanation
Unknown	
Ward	
Widow	
Widower	
Wife	

PESC XML Application for Admission Implementation Guide Version 1.3.0

Appendix E: Religious Affiliation Codes
Agnostic
Anglican
ApostolicChristian
AssembliesOfGod
Atheist
BahaiFaith
Baptist
BaptistConservative
BaptistOther
BaptistSouthern
Buddhist
Catholic
CatholicGreek
CatholicOther
CatholicRoman
Christian
ChristianBrethren
ChristianOther
ChristianReformed
ChristianScience
ChurchOfChrist
ChurchOfGod
ChurchOfTheNazarene
Congregational
Coptic
CrusadeForChristCampus
DisciplesOfChrist
EasternChristianOrthodox
Episcopal
Evangelist
FirstChristian
GraceReformed
GreatCommission
Hindu
Interdenominational
IntervarsityChristianFellowship
Jain
JehovahsWitnesses
Jewish
JewishConservative
JewishOrthodox
JewishOther

PESC XML Application for Admission Implementation Guide Version 1.3.0

Appendix E: Religious Affiliation Codes
JewishReform
LatterDaySaintMormon
LutheranMissouriSynod
LutheranNationalConference
LutheranUnspecified
LutheranWisconsin
Mennonite
Methodist
MethodistAfricanEpiscopal
Muslim
Navigators
None
NotFoundSeeNoteMessage
OtherNonChristian
OtherReligion
Pentecostal
PlymouthBrethren
Presbyterian
PresbyterianReformed
Protestant
ProtestantOther
ReorganizedLatterDaySaint
SeventhDayAdventist
Sikh
SocietyOfFriends
TrinityChurch
Unification
UnifiedFamily
UnitarianUniversalists
UnitedChurch
Wesleyan
WorldWideDiscipleship

**PESC XML Application for Admission Implementation Guide
Version 1.3.0**

Appendix F: Visa Codes Used by US Immigration Services Sorted by Visa Code	
US Immigration Visa Code	Description
A-1	Ambassador, Diplomat or Conoff and Immediate Family
A-2	Other Foreign Government Official and Immediate Family
A-3	Personal Employee of A1/A2 Visa Holder and Immediate Family
B-1	Visitor for Business
B-1/B-2	Visitor for Business and Pleasure
B-2	Visitor for Pleasure
BBBCC	B-1/B-2/BCC Combination Visa Mexican
C-1	Alien in Transit
C-1D	Alien Crewmember in Transit
C-2	Alien in Transit – United Nations
C-3	Alien in Transit – Foreign Official and Immediate Family
C-4	Transit without visa
D--	Crew Member (Ship or Aircraft Crew)
D-1	Crewmember departing on same vessel of arrival
D-2	Crewmember departing by means other than vessel of arrival
E-1	Treaty Trader, Spouse, Children
E-2	Treaty Investor, Spouse, Children
F-1	Student (full time) for Academic or Language Training
F-2	Spouse or Dependent Child of F-1 Visa Holder
F-3	Border Commuter Student
G-1	Permanent Representative to an International Organization and Immediate Family
G-2	Temporary Representative to International Organization and Immediate Family
G-3	Representative NonRec/Member Government to International Organization and Immediate Family
G-4	Employee of International Organization and Immediate Family
G-5	Personal Employee of G-1, G-2, G-3 or G-4 Visa Holder and Immediate Family
H-1B	Temporary Worker Distinguished Merit (Other than Nurse)
H-1B1	Free Trade Agreement NonImmigrant Professionals

**PESC XML Application for Admission Implementation Guide
Version 1.3.0**

Appendix F: Visa Codes Used by US Immigration Services Sorted by Visa Code	
US Immigration Visa Code	Description
H-1C	Nurses going to work for up to three years in health professional shortage areas
H-2A	Temporary Agricultural Worker
H-2B	Non-Agricultural Temporary Worker
H-3	Trainee
H-4	Spouse or Child of H-1, B-1, C-2, A-2, or B-3 Visa Holder
I--	Foreign Information Media and Spouse and Child
J-1	Exchange Visitor
J-2	Spouse or Dependent Child of J-1
K-1	Fiancé or Fiancée of US Citizen
K-2	Child of K-1 Visa Holder
K-3	Spouse of a US Citizen (LIFE Act)
K-4	Child of K-3 Visa Holder (LIFE Act)
L-1	Intra-Company Transferee (Executive, Manager)
L-1A	Executive, managerial
L-1B	Specialized knowledge
L-2	Spouse or Child of L-1 Visa Holder
M-1	Student (full time) admitted for educational vocational or technical training
M-2	Spouse or Dependent Child of M-1 visa Holder
M-3	Border Commuter Vocational Student
N-8	Parent of SK3 International Organization Special Immigrant
N-9	Child of N-8 or of SK-1, SK-2, or SK-4 Special Immigrant
NATO-1	NATO-1
NATO-2	NATO-2
NATO-3	NATO-3
NATO-4	NATO-4
NATO-5	NATO-5
NATO-6	NATO-6
NATO-7	Personal Employee of a NATO-1, NATO-2, NATO-3, NATO-4, NATO-5 or NATO-6 Visa Holder
O-1	Alien of Extraordinary Ability
O-2	Alien Accompanying O-1 Alien

**PESC XML Application for Admission Implementation Guide
Version 1.3.0**

Appendix F: Visa Codes Used by US Immigration Services Sorted by Visa Code	
US Immigration Visa Code	Description
O-3	Spouse or Child of O-1 or O-2 Visa Holder
P-1	Athlete or Entertainment Group for Specific Event
P-2	Artist – Reciprocal Exchange
P-3	Culturally Unique Artist
P-4	Spouse or Child of P-1, P-2, or P-3 Visa Holder
Q-1	International cultural exchange visitors
Q-2	Irish Peace Process Cultural and Training Program (Walsh Visas) from Dublin and Belfast only
Q-3	Spouse or child of Q-2 (Dublin or Belfast Only)
R-1	Religious workers
R-2	Spouse or child of R-1 Visa Holder
S-5	Informant of criminal organization information
S-6	Informant of terrorism information
S-7	Spouse, Son, Daughter or Parent of S-5 or S-6 Visa Holder
T-1	Victim of a severe form of trafficking in persons
T-2	Spouse of a victim of a severe form of trafficking in persons
T-3	Child of a victim of a severe form of trafficking in persons
T-4	Parent of a victim of a severe form of trafficking persons (if T-1 victim is under 21 years of age)
TN-	Trade visas for Canadians and Mexicans
TD-	NAFTA Derivative (Spouse or child accompanying TN Visa Holder)
TN-	NAFTA Professional
TWOV	Passenger or crew
U-1	Victim of certain criminal activity
U-2	Spouse of U-1
U-3	Child of U-1
U-4	Parent of U-1, if U-1 is under 21 years of age
V-1	Spouse of an LPR (LIFE Act Visa) who is the principal beneficiary of a family-based petition which was filed prior to 12/21/2000, and has been pending for at least 3 years
V-2	Child of V-1 (LPR Child Principal – LIFE Act)
V-3	The derivative child of a V-1 or V-2 Visa Holder

**PESC XML Application for Admission Implementation Guide
Version 1.3.0**

Appendix F: Visa Codes Used by US Immigration Services Sorted by Visa Code	
US Immigration Visa Code	Description
TPS	Temporary Protected Status

**PESC XML Application for Admission Implementation Guide
Version 1.3.0**

**Appendix G1: Birth Country Codes
for SEVIS Purposes
As defined by the US Federal Information Processing
Standards
(FIPS 10-4), National Imagery and Mapping Agency
Sorted by Birth Country Code**

BIRTH COUNTRY CODE	BIRTH COUNTRY NAME
AA	ARUBA
AC	ANTIGUA AND BARBUDA
AE	UNITED ARAB EMIRATES
AF	AFGHANISTAN
AG	ALGERIA
AJ	AZERBAIJAN
AL	ALBANIA
AM	ARMENIA
AN	ANDORRA
AO	ANGOLA
AQ	AMERICAN SAMOA
AR	ARGENTINA
AS	AUSTRALIA
AT	ASHMORE AND CARTIER ISLANDS
AU	AUSTRIA
AV	ANGUILLA
AY	ANTARCTICA
BA	BAHRAIN
BB	BARBADOS
BC	BOTSWANA
BD	BERMUDA
BE	BELGIUM
BF	BAHAMAS, THE
BG	BANGLADESH
BH	BELIZE
BK	BOSNIA AND HERZEGOVINA
BL	BOLIVIA
BM	BURMA
BN	BENIN
BO	BELARUS
BP	SOLOMON ISLANDS
BQ	NAVASSA ISLAND
BR	BRAZIL

**PESC XML Application for Admission Implementation Guide
Version 1.3.0**

**Appendix G1: Birth Country Codes
for SEVIS Purposes
As defined by the US Federal Information Processing
Standards
(FIPS 10-4), National Imagery and Mapping Agency
Sorted by Birth Country Code**

BIRTH COUNTRY CODE	BIRTH COUNTRY NAME
BS	BASSAS DA INDIA
BT	BHUTAN
BU	BULGARIA
BV	BOUVET ISLAND
BX	BRUNEI
BY	BURUNDI
CA	CANADA
CB	CAMBODIA
CD	CHAD
CE	SRI LANKA
CF	CONGO
CG	CONGO, DEMOCRATIC REPUBLIC OF THE
CH	CHINA
CI	CHILE
CJ	CAYMAN ISLANDS
CK	COCOS (KEELING) ISLANDS
CL	CENTRAL AND SOUTHERN LINE ISLANDS
CM	CAMEROON
CN	COMOROS
CO	COLOMBIA
CQ	NORTHERN MARIANA ISLANDS
CR	CORAL SEA ISLANDS
CS	COSTA RICA
CT	CENTRAL AFRICAN REPUBLIC
CU	CUBA
CV	CAPE VERDE
CW	COOK ISLANDS
CY	CYPRUS
CZ	CZECHOSLOVAKIA
DA	DENMARK
DJ	DJIBOUTI
DO	DOMINICA
DQ	JARVIS ISLAND

**PESC XML Application for Admission Implementation Guide
Version 1.3.0**

**Appendix G1: Birth Country Codes
for SEVIS Purposes
As defined by the US Federal Information Processing
Standards
(FIPS 10-4), National Imagery and Mapping Agency
Sorted by Birth Country Code**

BIRTH COUNTRY CODE	BIRTH COUNTRY NAME
DR	DOMINICAN REPUBLIC
EC	ECUADOR
EG	EGYPT
EI	IRELAND
EK	EQUATORIAL GUINEA
EN	ESTONIA
EQ	CANTON AND ENDERBURY
ER	ERITREA
ES	EL SALVADOR
ET	ETHIOPIA
EU	EUROPA ISLAND
EZ	CZECH REPUBLIC
FG	FRENCH GUIANA
FI	FINLAND
FJ	FIJI
FK	FALKLAND ISLANDS (ISLAS MALVINAS)
FM	MICRONESIA, FEDERATED STATES OF
FO	FAROE ISLANDS
FP	FRENCH POLYNESIA
FQ	BAKER ISLAND
FR	FRANCE
FS	FRENCH SOUTHERN AND ANTARCTIC LANDS
FT	FRENCH TERRITORY OF THE AFARS AND ISSAS
GA	GAMBIA, THE
GB	GABON
GC	GERMAN DEMOCRATIC REPUBLIC
GE	FEDERAL REPUBLIC OF GERMANY
GG	GEORGIA
GH	GHANA
GI	GIBRALTAR
GJ	GRENADA
GK	GUERNSEY
GL	GREENLAND

**PESC XML Application for Admission Implementation Guide
Version 1.3.0**

**Appendix G1: Birth Country Codes
for SEVIS Purposes
As defined by the US Federal Information Processing
Standards
(FIPS 10-4), National Imagery and Mapping Agency
Sorted by Birth Country Code**

BIRTH COUNTRY CODE	BIRTH COUNTRY NAME
GM	GERMANY
GN	GILBERT AND ELLICE ISLANDS
GO	GLORIOSO ISLANDS
GP	GUADELOUPE
GQ	GUAM
GR	GREECE
GS	GILBERT ISLANDS
GT	GUATEMALA
GV	GUINEA
GY	GUYANA
GZ	GAZA STRIP
HA	HAITI
HK	HONG KONG
HM	HEARD ISLAND AND MCDONALD SLANDS
HO	HONDURAS
HQ	HOWLAND ISLAND
HR	CROATIA
HU	HUNGARY
IC	ICELAND
ID	INDONESIA
IM	ISLE OF MAN
IN	INDIA
IO	BRITISH INDIAN OCEAN TERRITORY
IP	CLIPPERTON ISLAND
IQ	UNITED STATES MISC. PACIFIC ISLANDS
IR	IRAN
IS	ISRAEL
IT	ITALY
IU	ISRAEL-SYRIA DEMILITARIZED ZONE
IV	COTE D IVOIRE
IW	ISRAEL-JORDAN DEMILITARIZED ZONE
IY	IRAQ-SAUDI ARABIA NEUTRAL ZONE
IZ	IRAQ

**PESC XML Application for Admission Implementation Guide
Version 1.3.0**

**Appendix G1: Birth Country Codes
for SEVIS Purposes
As defined by the US Federal Information Processing
Standards
(FIPS 10-4), National Imagery and Mapping Agency
Sorted by Birth Country Code**

BIRTH COUNTRY CODE	BIRTH COUNTRY NAME
JA	JAPAN
JE	JERSEY
JM	JAMAICA
JN	JAN MAYEN
JO	JORDAN
JQ	JOHNSTON ATOLL
JS	SVALBARD AND JAN MAYEN
JU	JUAN DE NOVA ISLAND
KE	KENYA
KG	KYRGYZSTAN
KN	NORTH KOREA
KQ	KINGMAN REEF
KR	KIRIBATI
KS	SOUTH KOREA
KT	CHRISTMAS ISLAND
KU	KUWAIT
KZ	KAZAKHSTAN
LA	LAOS
LE	LEBANON
LG	LATVIA
LH	LITHUANIA
LI	LIBERIA
LO	SLOVAKIA
LQ	PALMYRA ATOLL
LS	LIECHTENSTEIN
LT	LESOTHO
LU	LUXEMBOURG
LY	LIBYA
MA	MADAGASCAR
MB	MARTINIQUE
MC	MACAU
MD	MOLDOVA
ME	SPANISH NORTH AFRICA

**PESC XML Application for Admission Implementation Guide
Version 1.3.0**

**Appendix G1: Birth Country Codes
for SEVIS Purposes
As defined by the US Federal Information Processing
Standards
(FIPS 10-4), National Imagery and Mapping Agency
Sorted by Birth Country Code**

BIRTH COUNTRY CODE	BIRTH COUNTRY NAME
MF	MAYOTTE
MG	MONGOLIA
MH	MONTSERRAT
MI	MALAWI
MK	MACEDONIA, THE FORMER YUGOSLAV REPUBLIC OF
ML	MALI
MN	MONACO
MO	MOROCCO
MP	MAURITIUS
MQ	MIDWAY ISLANDS
MR	MAURITANIA
MT	MALTA
MU	OMAN
MV	MALDIVES
MW	MONTENEGRO
MX	MEXICO
MY	MALAYSIA
MZ	MOZAMBIQUE
NC	NEW CALEDONIA
NE	NIUE
NF	NORFOLK ISLAND
NG	NIGER
NH	VANUATU
NI	NIGERIA
NL	NETHERLANDS
NO	NORWAY
NP	NEPAL
NR	NAURU
NS	SURINAME
NT	NETHERLANDS ANTILLES
NU	NICARAGUA
NZ	NEW ZEALAND
PA	PARAGUAY

**PESC XML Application for Admission Implementation Guide
Version 1.3.0**

**Appendix G1: Birth Country Codes
for SEVIS Purposes
As defined by the US Federal Information Processing
Standards
(FIPS 10-4), National Imagery and Mapping Agency
Sorted by Birth Country Code**

BIRTH COUNTRY CODE	BIRTH COUNTRY NAME
PC	PITCAIRN ISLANDS
PE	PERU
PF	PARACEL ISLANDS
PG	SPRATLY ISLANDS
PK	PAKISTAN
PL	POLAND
PM	PANAMA
PO	PORTUGAL
PP	PAPUA NEW GUINEA
PQ	CANAL ZONE
PS	PALAU
PT	PORTUGUESE TIMOR
PU	GUINEA-BISSAU
QA	QATAR
RE	REUNION
RH	SOUTHERN RHODESIA
RM	MARSHALL ISLANDS
RO	ROMANIA
RP	PHILIPPINES
RQ	PUERTO RICO
RS	RUSSIA
RW	RWANDA
SA	SAUDI ARABIA
SB	SAINT PIERRE AND MIQUELON
SC	SAINT KITTS AND NEVIS
SE	SEYCHELLES
SF	SOUTH AFRICA
SG	SENEGAL
SH	SAINT HELENA
SI	SLOVENIA
SK	SIKKIM
SL	SIERRA LEONE
SM	SAN MARINO

**PESC XML Application for Admission Implementation Guide
Version 1.3.0**

**Appendix G1: Birth Country Codes
for SEVIS Purposes
As defined by the US Federal Information Processing
Standards
(FIPS 10-4), National Imagery and Mapping Agency
Sorted by Birth Country Code**

BIRTH COUNTRY CODE	BIRTH COUNTRY NAME
SN	SINGAPORE
SO	SOMALIA
SP	SPAIN
SQ	SWAN ISLANDS
SR	SERBIA
SS	SPANISH SAHARA
ST	SAINT LUCIA
SU	SUDAN
SV	SVALBARD
SW	SWEDEN
SX	SOUTH GEORGIA AND THE SOUTH SANDWICH ISLANDS
SY	SYRIA
SZ	SWITZERLAND
TD	TRINIDAD AND TOBAGO
TE	TROMELIN ISLAND
TH	THAILAND
TI	TAJIKISTAN
TK	TURKS AND CAICOS ISLANDS
TL	TOKELAU
TN	TONGA
TO	TOGO
TP	SAO TOME AND PRINCIPE
TQ	TRUST TERRITORY OF THE PACIFIC ISLANDS
TS	TUNISIA
TT	EAST TIMOR
TU	TURKEY
TV	TUVALU
TW	TAIWAN
TX	TURKMENISTAN
TZ	TANZANIA
U2	NEUTRAL ZONE
U3	STATELESS
U5	UNKNOWN

**PESC XML Application for Admission Implementation Guide
Version 1.3.0**

Appendix G1: Birth Country Codes for SEVIS Purposes As defined by the US Federal Information Processing Standards (FIPS 10-4), National Imagery and Mapping Agency Sorted by Birth Country Code	
BIRTH COUNTRY CODE	BIRTH COUNTRY NAME
UG	UGANDA
UK	UNITED KINGDOM
UP	UKRAINE
UR	UNION OF SOVIET SOCIALIST REPUBLICS
US	UNITED STATES
UV	BURKINA FASO
UY	URUGUAY
UZ	UZBEKISTAN
VC	SAINT VINCENT AND THE GRENADINES
VE	VENEZUELA
VI	BRITISH VIRGIN ISLANDS
VM	VIETNAM
VN	DEMOCRATIC REPUBLIC OF VIET-NAM
VQ	VIRGIN ISLANDS
VS	REPUBLIC OF VIET-NAM
VT	VATICAN CITY
WA	NAMIBIA
WE	WEST BANK
WF	WALLIS AND FUTUNA
WI	WESTERN SAHARA
WQ	WAKE ATOLL
WS	SAMOA
WZ	SWAZILAND
YE	YEMAN (SANAA)
YI	SERBIA AND MONTENEGRO
YM	YEMEN
YO	YUGOSLAVIA
YQ	SOUTHERN RYUKYU ISLANDS
YS	YEMEN (ADEN)
ZA	ZAMBIA
ZI	ZIMBABWE

**PESC XML Application for Admission Implementation Guide
Version 1.3.0**

**Appendix G2: Birth Country Codes
for SEVIS Purposes
As defined by the US Federal Information Processing
Standards
(FIPS 10-4), National Imagery and Mapping Agency
Sorted by Country Name**

BIRTH COUNTRY CODE	BIRTH COUNTRY NAME
AF	AFGHANISTAN
AL	ALBANIA
AG	ALGERIA
AQ	AMERICAN SAMOA
AN	ANDORRA
AO	ANGOLA
AV	ANGUILLA
AY	ANTARCTICA
AC	ANTIGUA AND BARBUDA
AR	ARGENTINA
AM	ARMENIA
AA	ARUBA
AT	ASHMORE AND CARTIER ISLANDS
AS	AUSTRALIA
AU	AUSTRIA
AJ	AZERBAIJAN
BF	BAHAMAS, THE
BA	BAHRAIN
FQ	BAKER ISLAND
BG	BANGLADESH
BB	BARBADOS
BS	BASSAS DA INDIA
BO	BELARUS
BE	BELGIUM
BH	BELIZE
BN	BENIN
BD	BERMUDA
BT	BHUTAN
BL	BOLIVIA
BK	BOSNIA AND HERZEGOVINA
BC	BOTSWANA
BV	BOUVET ISLAND
BR	BRAZIL

**PESC XML Application for Admission Implementation Guide
Version 1.3.0**

**Appendix G2: Birth Country Codes
for SEVIS Purposes
As defined by the US Federal Information Processing
Standards
(FIPS 10-4), National Imagery and Mapping Agency
Sorted by Country Name**

BIRTH COUNTRY CODE	BIRTH COUNTRY NAME
IO	BRITISH INDIAN OCEAN TERRITORY
VI	BRITISH VIRGIN ISLANDS
BX	BRUNEI
BU	BULGARIA
UV	BURKINA FASO
BM	BURMA
BY	BURUNDI
CB	CAMBODIA
CM	CAMEROON
CA	CANADA
PQ	CANAL ZONE
EQ	CANTON AND ENDERBURY
CV	CAPE VERDE
CJ	CAYMAN ISLANDS
CT	CENTRAL AFRICAN REPUBLIC
CL	CENTRAL AND SOUTHERN LINE ISLANDS
CD	CHAD
CI	CHILE
CH	CHINA
KT	CHRISTMAS ISLAND
IP	CLIPPERTON ISLAND
CK	COCOS (KEELING) ISLANDS
CO	COLOMBIA
CN	COMOROS
CF	CONGO
CG	CONGO, DEMOCRATIC REPUBLIC OF THE
CW	COOK ISLANDS
CR	CORAL SEA ISLANDS
CS	COSTA RICA
IV	COTE D IVOIRE
HR	CROATIA
CU	CUBA
CY	CYPRUS

**PESC XML Application for Admission Implementation Guide
Version 1.3.0**

**Appendix G2: Birth Country Codes
for SEVIS Purposes
As defined by the US Federal Information Processing
Standards
(FIPS 10-4), National Imagery and Mapping Agency
Sorted by Country Name**

BIRTH COUNTRY CODE	BIRTH COUNTRY NAME
EZ	CZECH REPUBLIC
CZ	CZECHOSLOVAKIA
VN	DEMOCRATIC REPUBLIC OF VIET-NAM
DA	DENMARK
DJ	DJIBOUTI
DO	DOMINICA
DR	DOMINICAN REPUBLIC
TT	EAST TIMOR
EC	ECUADOR
EG	EGYPT
ES	EL SALVADOR
EK	EQUATORIAL GUINEA
ER	ERITREA
EN	ESTONIA
ET	ETHIOPIA
EU	EUROPA ISLAND
FK	FALKLAND ISLANDS (ISLAS MALVINAS)
FO	FAROE ISLANDS
GE	FEDERAL REPUBLIC OF GERMANY
FJ	FIJI
FI	FINLAND
FR	FRANCE
FG	FRENCH GUIANA
FP	FRENCH POLYNESIA
FS	FRENCH SOUTHERN AND ANTARCTIC LANDS
FT	FRENCH TERRITORY OF THE AFARS AND ISSAS
GB	GABON
GA	GAMBIA, THE
GZ	GAZA STRIP
GG	GEORGIA
GC	GERMAN DEMOCRATIC REPUBLIC
GM	GERMANY
GH	GHANA

**PESC XML Application for Admission Implementation Guide
Version 1.3.0**

**Appendix G2: Birth Country Codes
for SEVIS Purposes
As defined by the US Federal Information Processing
Standards
(FIPS 10-4), National Imagery and Mapping Agency
Sorted by Country Name**

BIRTH COUNTRY CODE	BIRTH COUNTRY NAME
GI	GIBRALTAR
GN	GILBERT AND ELLICE ISLANDS
GS	GILBERT ISLANDS
GO	GLORIOSO ISLANDS
GR	GREECE
GL	GREENLAND
GJ	GRENADA
GP	GUADELOUPE
GQ	GUAM
GT	GUATEMALA
GK	GUERNSEY
GV	GUINEA
PU	GUINEA-BISSAU
GY	GUYANA
HA	HAITI
HM	HEARD ISLAND AND MCDONALD SLANDS
HO	HONDURAS
HK	HONG KONG
HQ	HOWLAND ISLAND
HU	HUNGARY
IC	ICELAND
IN	INDIA
ID	INDONESIA
IR	IRAN
IZ	IRAQ
IY	IRAQ-SAUDI ARABIA NEUTRAL ZONE
EI	IRELAND
IM	ISLE OF MAN
IS	ISRAEL
IW	ISRAEL-JORDAN DEMILITARIZED ZONE
IU	ISRAEL-SYRIA DEMILITARIZED ZONE
IT	ITALY
JM	JAMAICA

**PESC XML Application for Admission Implementation Guide
Version 1.3.0**

**Appendix G2: Birth Country Codes
for SEVIS Purposes
As defined by the US Federal Information Processing
Standards
(FIPS 10-4), National Imagery and Mapping Agency
Sorted by Country Name**

BIRTH COUNTRY CODE	BIRTH COUNTRY NAME
JN	JAN MAYEN
JA	JAPAN
DQ	JARVIS ISLAND
JE	JERSEY
JQ	JOHNSTON ATOLL
JO	JORDAN
JU	JUAN DE NOVA ISLAND
KZ	KAZAKHSTAN
KE	KENYA
KQ	KINGMAN REEF
KR	KIRIBATI
KU	KUWAIT
KG	KYRGYZSTAN
LA	LAOS
LG	LATVIA
LE	LEBANON
LT	LESOTHO
LI	LIBERIA
LY	LIBYA
LS	LIECHTENSTEIN
LH	LITHUANIA
LU	LUXEMBOURG
MC	MACAU
MK	MACEDONIA, THE FORMER YUGOSLAV REPUBLIC OF
MA	MADAGASCAR
MI	MALAWI
MY	MALAYSIA
MV	MALDIVES
ML	MALI
MT	MALTA
RM	MARSHALL ISLANDS
MB	MARTINIQUE
MR	MAURITANIA

**PESC XML Application for Admission Implementation Guide
Version 1.3.0**

**Appendix G2: Birth Country Codes
for SEVIS Purposes
As defined by the US Federal Information Processing
Standards
(FIPS 10-4), National Imagery and Mapping Agency
Sorted by Country Name**

BIRTH COUNTRY CODE	BIRTH COUNTRY NAME
MP	MAURITIUS
MF	MAYOTTE
MX	MEXICO
FM	MICRONESIA, FEDERATED STATES OF
MQ	MIDWAY ISLANDS
MD	MOLDOVA
MN	MONACO
MG	MONGOLIA
MW	MONTENEGRO
MH	MONTSERRAT
MO	MOROCCO
MZ	MOZAMBIQUE
WA	NAMIBIA
NR	NAURU
BQ	NAVASSA ISLAND
NP	NEPAL
NL	NETHERLANDS
NT	NETHERLANDS ANTILLES
U2	NEUTRAL ZONE
NC	NEW CALEDONIA
NZ	NEW ZEALAND
NU	NICARAGUA
NG	NIGER
NI	NIGERIA
NE	NIUE
NF	NORFOLK ISLAND
KN	NORTH KOREA
CQ	NORTHERN MARIANA ISLANDS
NO	NORWAY
MU	OMAN
PK	PAKISTAN
PS	PALAU
LQ	PALMYRA ATOLL

**PESC XML Application for Admission Implementation Guide
Version 1.3.0**

**Appendix G2: Birth Country Codes
for SEVIS Purposes
As defined by the US Federal Information Processing
Standards
(FIPS 10-4), National Imagery and Mapping Agency
Sorted by Country Name**

BIRTH COUNTRY CODE	BIRTH COUNTRY NAME
PM	PANAMA
PP	PAPUA NEW GUINEA
PF	PARACEL ISLANDS
PA	PARAGUAY
PE	PERU
RP	PHILIPPINES
PC	PITCAIRN ISLANDS
PL	POLAND
PO	PORTUGAL
PT	PORTUGUESE TIMOR
RQ	PUERTO RICO
QA	QATAR
VS	REPUBLIC OF VIET-NAM
RE	REUNION
RO	ROMANIA
RS	RUSSIA
RW	RWANDA
SH	SAINT HELENA
SC	SAINT KITTS AND NEVIS
ST	SAINT LUCIA
SB	SAINT PIERRE AND MIQUELON
VC	SAINT VINCENT AND THE GRENADINES
WS	SAMOA
SM	SAN MARINO
TP	SAO TOME AND PRINCIPE
SA	SAUDI ARABIA
SG	SENEGAL
SR	SERBIA
YI	SERBIA AND MONTENEGRO
SE	SEYCHELLES
SL	SIERRA LEONE
SK	SIKKIM
SN	SINGAPORE

**PESC XML Application for Admission Implementation Guide
Version 1.3.0**

**Appendix G2: Birth Country Codes
for SEVIS Purposes
As defined by the US Federal Information Processing
Standards
(FIPS 10-4), National Imagery and Mapping Agency
Sorted by Country Name**

BIRTH COUNTRY CODE	BIRTH COUNTRY NAME
LO	SLOVAKIA
SI	SLOVENIA
BP	SOLOMON ISLANDS
SO	SOMALIA
SF	SOUTH AFRICA
SX	SOUTH GEORGIA AND THE SOUTH SANDWICH ISLANDS
KS	SOUTH KOREA
RH	SOUTHERN RHODESIA
YQ	SOUTHERN RYUKYU ISLANDS
SP	SPAIN
ME	SPANISH NORTH AFRICA
SS	SPANISH SAHARA
PG	SPRATLY ISLANDS
CE	SRI LANKA
U3	STATELESS
SU	SUDAN
NS	SURINAME
SV	SVALBARD
JS	SVALBARD AND JAN MAYEN
SQ	SWAN ISLANDS
WZ	SWAZILAND
SW	SWEDEN
SZ	SWITZERLAND
SY	SYRIA
TW	TAIWAN
TI	TAJIKISTAN
TZ	TANZANIA
TH	THAILAND
TO	TOGO
TL	TOKELAU
TN	TONGA
TD	TRINIDAD AND TOBAGO
TE	TROMELIN ISLAND

**PESC XML Application for Admission Implementation Guide
Version 1.3.0**

Appendix G2: Birth Country Codes for SEVIS Purposes As defined by the US Federal Information Processing Standards (FIPS 10-4), National Imagery and Mapping Agency Sorted by Country Name	
BIRTH COUNTRY CODE	BIRTH COUNTRY NAME
TQ	TRUST TERRITORY OF THE PACIFIC ISLANDS
TS	TUNISIA
TU	TURKEY
TX	TURKMENISTAN
TK	TURKS AND CAICOS ISLANDS
TV	TUVALU
UG	UGANDA
UP	UKRAINE
UR	UNION OF SOVIET SOCIALIST REPUBLICS
AE	UNITED ARAB EMIRATES
UK	UNITED KINGDOM
US	UNITED STATES
IQ	UNITED STATES MISC. PACIFIC ISLANDS
U5	UNKNOWN
UY	URUGUAY
UZ	UZBEKISTAN
NH	VANUATU
VT	VATICAN CITY
VE	VENEZUELA
VM	VIETNAM
VQ	VIRGIN ISLANDS
WQ	WAKE ATOLL
WF	WALLIS AND FUTUNA
WE	WEST BANK
WI	WESTERN SAHARA
YE	YEMAN (SANAA)
YM	YEMEN
YS	YEMEN (ADEN)
YO	YUGOSLAVIA
ZA	ZAMBIA
ZI	ZIMBABWE

**PESC XML Application for Admission Implementation Guide
Version 1.3.0**

Appendix H1: Citizenship and Residence Country Codes as defined by the US Federal Information Processing Standards (FIPS 10-4), National Imagery and Mapping Agency Sorted by Country Code	
Citizenship & Residence COUNTRY CODE	Citizenship & Residence COUNTRY DESCRIPTION
AA	ARUBA
AC	ANTIGUA AND BARBUDA
AE	UNITED ARAB EMIRATES
AF	AFGHANISTAN
AG	ALGERIA
AJ	AZERBAIJAN
AL	ALBANIA
AM	ARMENIA
AN	ANDORRA
AO	ANGOLA
AR	ARGENTINA
AS	AUSTRALIA
AT	ASHMORE AND CARTIER ISLANDS
AU	AUSTRIA
AV	ANGUILLA
BA	BAHRAIN
BB	BARBADOS
BC	BOTSWANA
BD	BERMUDA
BE	BELGIUM
BF	BAHAMAS, THE
BG	BANGLADESH
BH	BELIZE
BK	BOSNIA AND HERZEGOVINA
BL	BOLIVIA
BM	BURMA
BN	BENIN
BO	BELARUS
BP	SOLOMON ISLANDS
BR	BRAZIL
BS	BASSAS DA INDIA
BT	BHUTAN
BU	BULGARIA

**PESC XML Application for Admission Implementation Guide
Version 1.3.0**

Appendix H1: Citizenship and Residence Country Codes as defined by the US Federal Information Processing Standards (FIPS 10-4), National Imagery and Mapping Agency Sorted by Country Code	
Citizenship & Residence COUNTRY CODE	Citizenship & Residence COUNTRY DESCRIPTION
BV	BOUVET ISLAND
BX	BRUNEI
BY	BURUNDI
CA	CANADA
CB	CAMBODIA
CD	CHAD
CE	SRI LANKA
CF	CONGO
CG	CONGO, DEMOCRATIC REPUBLIC OF THE
CH	CHINA
CI	CHILE
CJ	CAYMAN ISLANDS
CK	COCOS (KEELING) ISLANDS
CM	CAMEROON
CN	COMOROS
CO	COLOMBIA
CR	CORAL SEA ISLANDS
CS	COSTA RICA
CT	CENTRAL AFRICAN REPUBLIC
CU	CUBA
CV	CAPE VERDE
CW	COOK ISLANDS
CY	CYPRUS
DA	DENMARK
DJ	DJIBOUTI
DO	DOMINICA
DR	DOMINICAN REPUBLIC
EC	ECUADOR
EG	EGYPT
EI	IRELAND
EK	EQUATORIAL GUINEA
EN	ESTONIA
ER	ERITREA

**PESC XML Application for Admission Implementation Guide
Version 1.3.0**

Appendix H1: Citizenship and Residence Country Codes as defined by the US Federal Information Processing Standards (FIPS 10-4), National Imagery and Mapping Agency Sorted by Country Code	
Citizenship & Residence COUNTRY CODE	Citizenship & Residence COUNTRY DESCRIPTION
ES	EL SALVADOR
ET	ETHIOPIA
EU	EUROPA ISLAND
EZ	CZECH REPUBLIC
FG	FRENCH GUIANA
FI	FINLAND
FJ	FIJI
FK	FALKLAND ISLANDS (ISLAS MALVINAS)
FM	MICRONESIA, FEDERATED STATES OF
FO	FAROE ISLANDS
FP	FRENCH POLYNESIA
FR	FRANCE
FS	FRENCH SOUTHERN AND ANTARCTIC LANDS
GA	GAMBIA, THE
GB	GABON
GG	GEORGIA
GH	GHANA
GI	GIBRALTAR
GJ	GRENADA
GK	GUERNSEY
GL	GREENLAND
GM	GERMANY
GO	GLORIOSO ISLANDS
GP	GUADELOUPE
GR	GREECE
GT	GUATEMALA
GV	GUINEA
GY	GUYANA
GZ	GAZA STRIP
HA	HAITI
HK	HONG KONG
HM	HEARD ISLAND AND MCDONALD SLANDS
HO	HONDURAS

**PESC XML Application for Admission Implementation Guide
Version 1.3.0**

Appendix H1: Citizenship and Residence Country Codes as defined by the US Federal Information Processing Standards (FIPS 10-4), National Imagery and Mapping Agency Sorted by Country Code	
Citizenship & Residence COUNTRY CODE	Citizenship & Residence COUNTRY DESCRIPTION
HR	CROATIA
HU	HUNGARY
IC	ICELAND
ID	INDONESIA
IM	ISLE OF MAN
IN	INDIA
IO	BRITISH INDIAN OCEAN TERRITORY
IP	CLIPPERTON ISLAND
IR	IRAN
IS	ISRAEL
IT	ITALY
IV	COTE D IVOIRE
IZ	IRAQ
JA	JAPAN
JE	JERSEY
JM	JAMAICA
JN	JAN MAYEN
JO	JORDAN
JU	JUAN DE NOVA ISLAND
KE	KENYA
KG	KYRGYZSTAN
KN	NORTH KOREA
KR	KIRIBATI
KS	SOUTH KOREA
KT	CHRISTMAS ISLAND
KU	KUWAIT
KZ	KAZAKHSTAN
LA	LAOS
LE	LEBANON
LG	LATVIA
LH	LITHUANIA
LI	LIBERIA
LO	SLOVAKIA

**PESC XML Application for Admission Implementation Guide
Version 1.3.0**

Appendix H1: Citizenship and Residence Country Codes as defined by the US Federal Information Processing Standards (FIPS 10-4), National Imagery and Mapping Agency Sorted by Country Code	
Citizenship & Residence COUNTRY CODE	Citizenship & Residence COUNTRY DESCRIPTION
LS	LIECHTENSTEIN
LT	LESOTHO
LU	LUXEMBOURG
LY	LIBYA
MA	MADAGASCAR
MB	MARTINIQUE
MC	MACAU
MD	MOLDOVA
MF	MAYOTTE
MG	MONGOLIA
MH	MONTSERRAT
MI	MALAWI
MK	MACEDONIA, THE FORMER YUGOSLAV REPUBLIC OF
ML	MALI
MN	MONACO
MO	MOROCCO
MP	MAURITIUS
MR	MAURITANIA
MT	MALTA
MU	OMAN
MV	MALDIVES
MX	MEXICO
MY	MALAYSIA
MZ	MOZAMBIQUE
NC	NEW CALEDONIA
NE	NIUE
NF	NORFOLK ISLAND
NG	NIGER
NH	VANUATU
NI	NIGERIA
NL	NETHERLANDS
NO	NORWAY
NP	NEPAL

**PESC XML Application for Admission Implementation Guide
Version 1.3.0**

Appendix H1: Citizenship and Residence Country Codes as defined by the US Federal Information Processing Standards (FIPS 10-4), National Imagery and Mapping Agency Sorted by Country Code	
Citizenship & Residence COUNTRY CODE	Citizenship & Residence COUNTRY DESCRIPTION
NR	NAURU
NS	SURINAME
NT	NETHERLANDS ANTILLES
NU	NICARAGUA
NZ	NEW ZEALAND
PA	PARAGUAY
PC	PITCAIRN ISLANDS
PE	PERU
PF	PARACEL ISLANDS
PG	SPRATLY ISLANDS
PK	PAKISTAN
PL	POLAND
PM	PANAMA
PO	PORTUGAL
PP	PAPUA NEW GUINEA
PS	PALAU
PU	GUINEA-BISSAU
QA	QATAR
RE	REUNION
RM	MARSHALL ISLANDS
RO	ROMANIA
RP	PHILIPPINES
RS	RUSSIA
RW	RWANDA
SA	SAUDI ARABIA
SB	SAINT PIERRE AND MIQUELON
SC	SAINT KITTS AND NEVIS
SE	SEYCHELLES
SF	SOUTH AFRICA
SG	SENEGAL
SH	SAINT HELENA
SI	SLOVENIA
SL	SIERRA LEONE

**PESC XML Application for Admission Implementation Guide
Version 1.3.0**

Appendix H1: Citizenship and Residence Country Codes as defined by the US Federal Information Processing Standards (FIPS 10-4), National Imagery and Mapping Agency Sorted by Country Code	
Citizenship & Residence COUNTRY CODE	Citizenship & Residence COUNTRY DESCRIPTION
SM	SAN MARINO
SN	SINGAPORE
SO	SOMALIA
SP	SPAIN
ST	SAINT LUCIA
SU	SUDAN
SV	SVALBARD
SW	SWEDEN
SX	SOUTH GEORGIA AND THE SOUTH SANDWICH ISLANDS
SY	SYRIA
SZ	SWITZERLAND
TD	TRINIDAD AND TOBAGO
TE	TROMELIN ISLAND
TH	THAILAND
TI	TAJIKISTAN
TK	TURKS AND CAICOS ISLANDS
TL	TOKELAU
TN	TONGA
TO	TOGO
TP	SAO TOME AND PRINCIPE
TS	TUNISIA
TT	EAST TIMOR
TU	TURKEY
TV	TUVALU
TW	TAIWAN
TX	TURKMENISTAN
TZ	TANZANIA
U2	NEUTRAL ZONE
U3	STATELESS
U5	UNKNOWN
UG	UGANDA
UK	UNITED KINGDOM
UP	UKRAINE

**PESC XML Application for Admission Implementation Guide
Version 1.3.0**

Appendix H1: Citizenship and Residence Country Codes as defined by the US Federal Information Processing Standards (FIPS 10-4), National Imagery and Mapping Agency Sorted by Country Code	
Citizenship & Residence COUNTRY CODE	Citizenship & Residence COUNTRY DESCRIPTION
UV	BURKINA FASO
UY	URUGUAY
UZ	UZBEKISTAN
VC	SAINT VINCENT AND THE GRENADINES
VE	VENEZUELA
VI	BRITISH VIRGIN ISLANDS
VM	VIETNAM
VT	VATICAN CITY
WA	NAMIBIA
WE	WEST BANK
WF	WALLIS AND FUTUNA
WI	WESTERN SAHARA
WS	SAMOA
WZ	SWAZILAND
YI	SERBIA AND MONTENEGRO
YM	YEMEN
ZA	ZAMBIA
ZI	ZIMBABWE

**PESC XML Application for Admission Implementation Guide
Version 1.3.0**

Appendix H2: Citizenship and Residence Country Codes as defined by the Federal Information Processing Standards (FIPS 10-4), National Imagery and Mapping Agency SORTED BY COUNTRY NAME	
Citizenship & Residence COUNTRY CODE	Citizenship & Residence COUNTRY DESCRIPTION
AF	AFGHANISTAN
AL	ALBANIA
AG	ALGERIA
AN	ANDORRA
AO	ANGOLA
AV	ANGUILLA
AC	ANTIGUA AND BARBUDA
AR	ARGENTINA
AM	ARMENIA
AA	ARUBA
AT	ASHMORE AND CARTIER ISLANDS
AS	AUSTRALIA
AU	AUSTRIA
AJ	AZERBAIJAN
BF	BAHAMAS, THE
BA	BAHRAIN
BG	BANGLADESH
BB	BARBADOS
BS	BASSAS DA INDIA
BO	BELARUS
BE	BELGIUM
BH	BELIZE
BN	BENIN
BD	BERMUDA
BT	BHUTAN
BL	BOLIVIA
BK	BOSNIA AND HERZEGOVINA
BC	BOTSWANA
BV	BOUVET ISLAND
BR	BRAZIL
IO	BRITISH INDIAN OCEAN TERRITORY
VI	BRITISH VIRGIN ISLANDS
BX	BRUNEI

**PESC XML Application for Admission Implementation Guide
Version 1.3.0**

Appendix H2: Citizenship and Residence Country Codes as defined by the Federal Information Processing Standards (FIPS 10-4), National Imagery and Mapping Agency SORTED BY COUNTRY NAME	
Citizenship & Residence COUNTRY CODE	Citizenship & Residence COUNTRY DESCRIPTION
BU	BULGARIA
UV	BURKINA FASO
BM	BURMA
BY	BURUNDI
CB	CAMBODIA
CM	CAMEROON
CA	CANADA
CV	CAPE VERDE
CJ	CAYMAN ISLANDS
CT	CENTRAL AFRICAN REPUBLIC
CD	CHAD
CI	CHILE
CH	CHINA
KT	CHRISTMAS ISLAND
IP	CLIPPERTON ISLAND
CK	COCOS (KEELING) ISLANDS
CO	COLOMBIA
CN	COMOROS
CF	CONGO
CG	CONGO, DEMOCRATIC REPUBLIC OF THE
CW	COOK ISLANDS
CR	CORAL SEA ISLANDS
CS	COSTA RICA
IV	COTE D IVOIRE
HR	CROATIA
CU	CUBA
CY	CYPRUS
EZ	CZECH REPUBLIC
DA	DENMARK
DJ	DJIBOUTI
DO	DOMINICA
DR	DOMINICAN REPUBLIC
TT	EAST TIMOR

**PESC XML Application for Admission Implementation Guide
Version 1.3.0**

Appendix H2: Citizenship and Residence Country Codes as defined by the Federal Information Processing Standards (FIPS 10-4), National Imagery and Mapping Agency SORTED BY COUNTRY NAME	
Citizenship & Residence COUNTRY CODE	Citizenship & Residence COUNTRY DESCRIPTION
EC	ECUADOR
EG	EGYPT
ES	EL SALVADOR
EK	EQUATORIAL GUINEA
ER	ERITREA
EN	ESTONIA
ET	ETHIOPIA
EU	EUROPA ISLAND
FK	FALKLAND ISLANDS (ISLAS MALVINAS)
FO	FAROE ISLANDS
FJ	FIJI
FI	FINLAND
FR	FRANCE
FG	FRENCH GUIANA
FP	FRENCH POLYNESIA
FS	FRENCH SOUTHERN AND ANTARCTIC LANDS
GB	GABON
GA	GAMBIA, THE
GZ	GAZA STRIP
GG	GEORGIA
GM	GERMANY
GH	GHANA
GI	GIBRALTAR
GO	GLORIOSO ISLANDS
GR	GREECE
GL	GREENLAND
GJ	GRENADA
GP	GUADELOUPE
GT	GUATEMALA
GK	GUERNSEY
GV	GUINEA
PU	GUINEA-BISSAU
GY	GUYANA

**PESC XML Application for Admission Implementation Guide
Version 1.3.0**

Appendix H2: Citizenship and Residence Country Codes as defined by the Federal Information Processing Standards (FIPS 10-4), National Imagery and Mapping Agency SORTED BY COUNTRY NAME	
Citizenship & Residence COUNTRY CODE	Citizenship & Residence COUNTRY DESCRIPTION
HA	HAITI
HM	HEARD ISLAND AND MCDONALD SLANDS
HO	HONDURAS
HK	HONG KONG
HU	HUNGARY
IC	ICELAND
IN	INDIA
ID	INDONESIA
IR	IRAN
IZ	IRAQ
EI	IRELAND
IM	ISLE OF MAN
IS	ISRAEL
IT	ITALY
JM	JAMAICA
JN	JAN MAYEN
JA	JAPAN
JE	JERSEY
JO	JORDAN
JU	JUAN DE NOVA ISLAND
KZ	KAZAKHSTAN
KE	KENYA
KR	KIRIBATI
KU	KUWAIT
KG	KYRGYZSTAN
LA	LAOS
LG	LATVIA
LE	LEBANON
LT	LESOTHO
LI	LIBERIA
LY	LIBYA
LS	LIECHTENSTEIN
LH	LITHUANIA

**PESC XML Application for Admission Implementation Guide
Version 1.3.0**

Appendix H2: Citizenship and Residence Country Codes as defined by the Federal Information Processing Standards (FIPS 10-4), National Imagery and Mapping Agency SORTED BY COUNTRY NAME	
Citizenship & Residence COUNTRY CODE	Citizenship & Residence COUNTRY DESCRIPTION
LU	LUXEMBOURG
MC	MACAU
MK	MACEDONIA, THE FORMER YUGOSLAV REPUBLIC OF
MA	MADAGASCAR
MI	MALAWI
MY	MALAYSIA
MV	MALDIVES
ML	MALI
MT	MALTA
RM	MARSHALL ISLANDS
MB	MARTINIQUE
MR	MAURITANIA
MP	MAURITIUS
MF	MAYOTTE
MX	MEXICO
FM	MICRONESIA, FEDERATED STATES OF
MD	MOLDOVA
MN	MONACO
MG	MONGOLIA
MH	MONTSERRAT
MO	MOROCCO
MZ	MOZAMBIQUE
WA	NAMIBIA
NR	NAURU
NP	NEPAL
NL	NETHERLANDS
NT	NETHERLANDS ANTILLES
U2	NEUTRAL ZONE
NC	NEW CALEDONIA
NZ	NEW ZEALAND
NU	NICARAGUA
NG	NIGER
NI	NIGERIA

**PESC XML Application for Admission Implementation Guide
Version 1.3.0**

Appendix H2: Citizenship and Residence Country Codes as defined by the Federal Information Processing Standards (FIPS 10-4), National Imagery and Mapping Agency SORTED BY COUNTRY NAME	
Citizenship & Residence COUNTRY CODE	Citizenship & Residence COUNTRY DESCRIPTION
NE	NIUE
NF	NORFOLK ISLAND
KN	NORTH KOREA
NO	NORWAY
MU	OMAN
PK	PAKISTAN
PS	PALAU
PM	PANAMA
PP	PAPUA NEW GUINEA
PF	PARACEL ISLANDS
PA	PARAGUAY
PE	PERU
RP	PHILIPPINES
PC	PITCAIRN ISLANDS
PL	POLAND
PO	PORTUGAL
QA	QATAR
RE	REUNION
RO	ROMANIA
RS	RUSSIA
RW	RWANDA
SH	SAINT HELENA
SC	SAINT KITTS AND NEVIS
ST	SAINT LUCIA
SB	SAINT PIERRE AND MIQUELON
VC	SAINT VINCENT AND THE GRENADINES
WS	SAMOA
SM	SAN MARINO
TP	SAO TOME AND PRINCIPE
SA	SAUDI ARABIA
SG	SENEGAL
YI	SERBIA AND MONTENEGRO
SE	SEYCHELLES

**PESC XML Application for Admission Implementation Guide
Version 1.3.0**

Appendix H2: Citizenship and Residence Country Codes as defined by the Federal Information Processing Standards (FIPS 10-4), National Imagery and Mapping Agency SORTED BY COUNTRY NAME	
Citizenship & Residence COUNTRY CODE	Citizenship & Residence COUNTRY DESCRIPTION
SL	SIERRA LEONE
SN	SINGAPORE
LO	SLOVAKIA
SI	SLOVENIA
BP	SOLOMON ISLANDS
SO	SOMALIA
SF	SOUTH AFRICA
SX	SOUTH GEORGIA AND THE SOUTH SANDWICH ISLANDS
KS	SOUTH KOREA
SP	SPAIN
PG	SPRATLY ISLANDS
CE	SRI LANKA
U3	STATELESS
SU	SUDAN
NS	SURINAME
SV	SVALBARD
WZ	SWAZILAND
SW	SWEDEN
SZ	SWITZERLAND
SY	SYRIA
TW	TAIWAN
TI	TAJIKISTAN
TZ	TANZANIA
TH	THAILAND
TO	TOGO
TL	TOKELAU
TN	TONGA
TD	TRINIDAD AND TOBAGO
TE	TROMELIN ISLAND
TS	TUNISIA
TU	TURKEY
TX	TURKMENISTAN
TK	TURKS AND CAICOS ISLANDS

**PESC XML Application for Admission Implementation Guide
Version 1.3.0**

Appendix H2: Citizenship and Residence Country Codes as defined by the Federal Information Processing Standards (FIPS 10-4), National Imagery and Mapping Agency SORTED BY COUNTRY NAME	
Citizenship & Residence COUNTRY CODE	Citizenship & Residence COUNTRY DESCRIPTION
TV	TUVALU
UG	UGANDA
UP	UKRAINE
AE	UNITED ARAB EMIRATES
UK	UNITED KINGDOM
U5	UNKNOWN
UY	URUGUAY
UZ	UZBEKISTAN
NH	VANUATU
VT	VATICAN CITY
VE	VENEZUELA
VM	VIETNAM
WF	WALLIS AND FUTUNA
WE	WEST BANK
WI	WESTERN SAHARA
YM	YEMEN
ZA	ZAMBIA
ZI	ZIMBABWE

**PESC XML Application for Admission Implementation Guide
Version 1.3.0**

Appendix J1: Passport Issuing Country Code as defined by the US Federal Information Processing Standards (FIPS 10-4), National Imagery and Mapping Agency Sorted by Country Code	
COUNTRY CODE	COUNTRY NAME
AA	ARUBA
AC	ANTIGUA AND BARBUDA
AE	UNITED ARAB EMIRATES
AF	AFGHANISTAN
AG	ALGERIA
AJ	AZERBAIJAN
AL	ALBANIA
AM	ARMENIA
AN	ANDORRA
AO	ANGOLA
AR	ARGENTINA
AS	AUSTRALIA
AT	ASHMORE AND CARTIER ISLANDS
AU	AUSTRIA
AV	ANGUILLA
AY	ANTARCTICA
BA	BAHRAIN
BB	BARBADOS
BC	BOTSWANA
BD	BERMUDA
BE	BELGIUM
BF	BAHAMAS, THE
BG	BANGLADESH
BH	BELIZE
BK	BOSNIA AND HERZEGOVINA
BL	BOLIVIA
BM	BURMA
BN	BENIN
BO	BELARUS
BP	SOLOMON ISLANDS
BR	BRAZIL
BS	BASSAS DA INDIA
BT	BHUTAN
BU	BULGARIA
BV	BOUVET ISLAND
BX	BRUNEI

**PESC XML Application for Admission Implementation Guide
Version 1.3.0**

Appendix J1: Passport Issuing Country Code as defined by the US Federal Information Processing Standards (FIPS 10-4), National Imagery and Mapping Agency Sorted by Country Code	
COUNTRY CODE	COUNTRY NAME
BY	BURUNDI
CA	CANADA
CB	CAMBODIA
CD	CHAD
CE	SRI LANKA
CF	CONGO
CG	CONGO, DEMOCRATIC REPUBLIC OF THE
CH	CHINA
CI	CHILE
CJ	CAYMAN ISLANDS
CK	COCOS (KEELING) ISLANDS
CL	CENTRAL AND SOUTHERN LINE ISLANDS
CM	CAMEROON
CN	COMOROS
CO	COLOMBIA
CR	CORAL SEA ISLANDS
CS	COSTA RICA
CT	CENTRAL AFRICAN REPUBLIC
CU	CUBA
CV	CAPE VERDE
CW	COOK ISLANDS
CY	CYPRUS
CZ	CZECHOSLOVAKIA
DA	DENMARK
DJ	DJIBOUTI
DO	DOMINICA
DR	DOMINICAN REPUBLIC
EC	ECUADOR
EG	EGYPT
EI	IRELAND
EK	EQUATORIAL GUINEA
EN	ESTONIA
EQ	CANTON AND ENDERBURY
ER	ERITREA
ES	EL SALVADOR
ET	ETHIOPIA

**PESC XML Application for Admission Implementation Guide
Version 1.3.0**

Appendix J1: Passport Issuing Country Code as defined by the US Federal Information Processing Standards (FIPS 10-4), National Imagery and Mapping Agency Sorted by Country Code	
COUNTRY CODE	COUNTRY NAME
EU	EUROPA ISLAND
EZ	CZECH REPUBLIC
FG	FRENCH GUIANA
FI	FINLAND
FJ	FIJI
FK	FALKLAND ISLANDS (ISLAS MALVINAS)
FM	MICRONESIA, FEDERATED STATES OF
FO	FAROE ISLANDS
FP	FRENCH POLYNESIA
FR	FRANCE
FS	FRENCH SOUTHERN AND ANTARCTIC LANDS
FT	FRENCH TERRITORY OF THE AFARS AND ISSAS
GA	GAMBIA, THE
GB	GABON
GC	GERMAN DEMOCRATIC REPUBLIC
GE	FEDERAL REPUBLIC OF GERMANY
GG	GEORGIA
GH	GHANA
GI	GIBRALTAR
GJ	GRENADA
GK	GUERNSEY
GL	GREENLAND
GM	GERMANY
GN	GILBERT AND ELLICE ISLANDS
GO	GLORIOSO ISLANDS
GP	GUADELOUPE
GR	GREECE
GS	GILBERT ISLANDS
GT	GUATEMALA
GV	GUINEA
GY	GUYANA
GZ	GAZA STRIP
HA	HAITI
HK	HONG KONG
HM	HEARD ISLAND AND MCDONALD SLANDS
HO	HONDURAS

**PESC XML Application for Admission Implementation Guide
Version 1.3.0**

Appendix J1: Passport Issuing Country Code as defined by the US Federal Information Processing Standards (FIPS 10-4), National Imagery and Mapping Agency Sorted by Country Code	
COUNTRY CODE	COUNTRY NAME
HR	CROATIA
HU	HUNGARY
IC	ICELAND
ID	INDONESIA
IM	ISLE OF MAN
IN	INDIA
IO	BRITISH INDIAN OCEAN TERRITORY
IP	CLIPPERTON ISLAND
IQ	UNITED STATES MISC. PACIFIC ISLANDS
IR	IRAN
IS	ISRAEL
IT	ITALY
IU	ISRAEL-SYRIA DEMILITARIZED ZONE
IV	COTE D IVOIRE
IW	ISRAEL-JORDAN DEMILITARIZED ZONE
IY	IRAQ-SAUDI ARABIA NEUTRAL ZONE
IZ	IRAQ
JA	JAPAN
JE	JERSEY
JM	JAMAICA
JN	JAN MAYEN
JO	JORDAN
JS	SVALBARD AND JAN MAYEN
JU	JUAN DE NOVA ISLAND
KE	KENYA
KG	KYRGYZSTAN
KN	NORTH KOREA
KR	KIRIBATI
KS	SOUTH KOREA
KT	CHRISTMAS ISLAND
KU	KUWAIT
KZ	KAZAKHSTAN
LA	LAOS
LE	LEBANON
LG	LATVIA
LH	LITHUANIA

**PESC XML Application for Admission Implementation Guide
Version 1.3.0**

Appendix J1: Passport Issuing Country Code as defined by the US Federal Information Processing Standards (FIPS 10-4), National Imagery and Mapping Agency Sorted by Country Code	
COUNTRY CODE	COUNTRY NAME
LI	LIBERIA
LO	SLOVAKIA
LS	LIECHTENSTEIN
LT	LESOTHO
LU	LUXEMBOURG
LY	LIBYA
MA	MADAGASCAR
MB	MARTINIQUE
MC	MACAU
MD	MOLDOVA
ME	SPANISH NORTH AFRICA
MF	MAYOTTE
MG	MONGOLIA
MH	MONTSERRAT
MI	MALAWI
MK	MACEDONIA, THE FORMER YUGOSLAV REPUBLIC OF
ML	MALI
MN	MONACO
MO	MOROCCO
MP	MAURITIUS
MR	MAURITANIA
MT	MALTA
MU	OMAN
MV	MALDIVES
MW	MONTENEGRO
MX	MEXICO
MY	MALAYSIA
MZ	MOZAMBIQUE
NC	NEW CALEDONIA
NE	NIUE
NF	NORFOLK ISLAND
NG	NIGER
NH	VANUATU
NI	NIGERIA
NL	NETHERLANDS
NO	NORWAY

**PESC XML Application for Admission Implementation Guide
Version 1.3.0**

Appendix J1: Passport Issuing Country Code as defined by the US Federal Information Processing Standards (FIPS 10-4), National Imagery and Mapping Agency Sorted by Country Code	
COUNTRY CODE	COUNTRY NAME
NP	NEPAL
NR	NAURU
NS	SURINAME
NT	NETHERLANDS ANTILLES
NU	NICARAGUA
NZ	NEW ZEALAND
PA	PARAGUAY
PC	PITCAIRN ISLANDS
PE	PERU
PF	PARACEL ISLANDS
PG	SPRATLY ISLANDS
PK	PAKISTAN
PL	POLAND
PM	PANAMA
PO	PORTUGAL
PP	PAPUA NEW GUINEA
PQ	CANAL ZONE
PS	PALAU
PT	PORTUGUESE TIMOR
PU	GUINEA-BISSAU
QA	QATAR
RE	REUNION
RH	SOUTHERN RHODESIA
RM	MARSHALL ISLANDS
RO	ROMANIA
RP	PHILIPPINES
RS	RUSSIA
RW	RWANDA
SA	SAUDI ARABIA
SB	SAINT PIERRE AND MIQUELON
SC	SAINT KITTS AND NEVIS
SE	SEYCHELLES
SF	SOUTH AFRICA
SG	SENEGAL
SH	SAINT HELENA
SI	SLOVENIA

**PESC XML Application for Admission Implementation Guide
Version 1.3.0**

Appendix J1: Passport Issuing Country Code as defined by the US Federal Information Processing Standards (FIPS 10-4), National Imagery and Mapping Agency Sorted by Country Code	
COUNTRY CODE	COUNTRY NAME
SK	SIKKIM
SL	SIERRA LEONE
SM	SAN MARINO
SN	SINGAPORE
SO	SOMALIA
SP	SPAIN
SQ	SWAN ISLANDS
SR	SERBIA
SS	SPANISH SAHARA
ST	SAINT LUCIA
SU	SUDAN
SV	SVALBARD
SW	SWEDEN
SX	SOUTH GEORGIA AND THE SOUTH SANDWICH ISLANDS
SY	SYRIA
SZ	SWITZERLAND
TD	TRINIDAD AND TOBAGO
TE	TROMELIN ISLAND
TH	THAILAND
TI	TAJIKISTAN
TK	TURKS AND CAICOS ISLANDS
TL	TOKELAU
TN	TONGA
TO	TOGO
TP	SAO TOME AND PRINCIPE
TQ	TRUST TERRITORY OF THE PACIFIC ISLANDS
TS	TUNISIA
TT	EAST TIMOR
TU	TURKEY
TV	TUVALU
TW	TAIWAN
TX	TURKMENISTAN
TZ	TANZANIA
U2	NEUTRAL ZONE
U3	STATELESS
U5	UNKNOWN

**PESC XML Application for Admission Implementation Guide
Version 1.3.0**

Appendix J1: Passport Issuing Country Code as defined by the US Federal Information Processing Standards (FIPS 10-4), National Imagery and Mapping Agency Sorted by Country Code	
COUNTRY CODE	COUNTRY NAME
UG	UGANDA
UK	UNITED KINGDOM
UP	UKRAINE
UR	UNION OF SOVIET SOCIALIST REPUBLICS
UV	BURKINA FASO
UY	URUGUAY
UZ	UZBEKISTAN
VC	SAINT VINCENT AND THE GRENADINES
VE	VENEZUELA
VI	BRITISH VIRGIN ISLANDS
VM	VIETNAM
VN	DEMOCRATIC REPUBLIC OF VIET-NAM
VS	REPUBLIC OF VIET-NAM
VT	VATICAN CITY
WA	NAMIBIA
WE	WEST BANK
WF	WALLIS AND FUTUNA
WI	WESTERN SAHARA
WS	SAMOA
WZ	SWAZILAND
YE	YEMAN (SANAA)
YI	SERBIA AND MONTENEGRO
YM	YEMEN
YO	YUGOSLAVIA
YQ	SOUTHERN RYUKYU ISLANDS
YS	YEMEN (ADEN)
ZA	ZAMBIA
ZI	ZIMBABWE

**PESC XML Application for Admission Implementation Guide
Version 1.3.0**

Appendix J2: Passport Issuing Country Codes as defined by the US Federal Information Processing Standards (FIPS 10-4), National Imagery and Mapping Agency Sorted by Country Name	
COUNTRY CODE	COUNTRY NAME
AF	AFGHANISTAN
AL	ALBANIA
AG	ALGERIA
AN	ANDORRA
AO	ANGOLA
AV	ANGUILLA
AY	ANTARCTICA
AC	ANTIGUA AND BARBUDA
AR	ARGENTINA
AM	ARMENIA
AA	ARUBA
AT	ASHMORE AND CARTIER ISLANDS
AS	AUSTRALIA
AU	AUSTRIA
AJ	AZERBAIJAN
BF	BAHAMAS, THE
BA	BAHRAIN
BG	BANGLADESH
BB	BARBADOS
BS	BASSAS DA INDIA
BO	BELARUS
BE	BELGIUM
BH	BELIZE
BN	BENIN
BD	BERMUDA
BT	BHUTAN
BL	BOLIVIA
BK	BOSNIA AND HERZEGOVINA
BC	BOTSWANA
BV	BOUVET ISLAND
BR	BRAZIL
IO	BRITISH INDIAN OCEAN TERRITORY
VI	BRITISH VIRGIN ISLANDS
BX	BRUNEI
BU	BULGARIA
UV	BURKINA FASO

**PESC XML Application for Admission Implementation Guide
Version 1.3.0**

Appendix J2: Passport Issuing Country Codes as defined by the US Federal Information Processing Standards (FIPS 10-4), National Imagery and Mapping Agency Sorted by Country Name	
COUNTRY CODE	COUNTRY NAME
BM	BURMA
BY	BURUNDI
CB	CAMBODIA
CM	CAMEROON
CA	CANADA
PQ	CANAL ZONE
EQ	CANTON AND ENDERBURY
CV	CAPE VERDE
CJ	CAYMAN ISLANDS
CT	CENTRAL AFRICAN REPUBLIC
CL	CENTRAL AND SOUTHERN LINE ISLANDS
CD	CHAD
CI	CHILE
CH	CHINA
KT	CHRISTMAS ISLAND
IP	CLIPPERTON ISLAND
CK	COCOS (KEELING) ISLANDS
CO	COLOMBIA
CN	COMOROS
CF	CONGO
CG	CONGO, DEMOCRATIC REPUBLIC OF THE
CW	COOK ISLANDS
CR	CORAL SEA ISLANDS
CS	COSTA RICA
IV	COTE D IVOIRE
HR	CROATIA
CU	CUBA
CY	CYPRUS
EZ	CZECH REPUBLIC
CZ	CZECHOSLOVAKIA
VN	DEMOCRATIC REPUBLIC OF VIET-NAM
DA	DENMARK
DJ	DJIBOUTI
DO	DOMINICA
DR	DOMINICAN REPUBLIC
TT	EAST TIMOR

**PESC XML Application for Admission Implementation Guide
Version 1.3.0**

Appendix J2: Passport Issuing Country Codes as defined by the US Federal Information Processing Standards (FIPS 10-4), National Imagery and Mapping Agency Sorted by Country Name	
COUNTRY CODE	COUNTRY NAME
EC	ECUADOR
EG	EGYPT
ES	EL SALVADOR
EK	EQUATORIAL GUINEA
ER	ERITREA
EN	ESTONIA
ET	ETHIOPIA
EU	EUROPA ISLAND
FK	FALKLAND ISLANDS (ISLAS MALVINAS)
FO	FAROE ISLANDS
GE	FEDERAL REPUBLIC OF GERMANY
FJ	FIJI
FI	FINLAND
FR	FRANCE
FG	FRENCH GUIANA
FP	FRENCH POLYNESIA
FS	FRENCH SOUTHERN AND ANTARCTIC LANDS
FT	FRENCH TERRITORY OF THE AFARS AND ISSAS
GB	GABON
GA	GAMBIA, THE
GZ	GAZA STRIP
GG	GEORGIA
GC	GERMAN DEMOCRATIC REPUBLIC
GM	GERMANY
GH	GHANA
GI	GIBRALTAR
GN	GILBERT AND ELLICE ISLANDS
GS	GILBERT ISLANDS
GO	GLORIOSO ISLANDS
GR	GREECE
GL	GREENLAND
GJ	GRENADA
GP	GUADELOUPE
GT	GUATEMALA
GK	GUERNSEY
GV	GUINEA

**PESC XML Application for Admission Implementation Guide
Version 1.3.0**

Appendix J2: Passport Issuing Country Codes as defined by the US Federal Information Processing Standards (FIPS 10-4), National Imagery and Mapping Agency Sorted by Country Name	
COUNTRY CODE	COUNTRY NAME
PU	GUINEA-BISSAU
GY	GUYANA
HA	HAITI
HM	HEARD ISLAND AND MCDONALD SLANDS
HO	HONDURAS
HK	HONG KONG
HU	HUNGARY
IC	ICELAND
IN	INDIA
ID	INDONESIA
IR	IRAN
IZ	IRAQ
IY	IRAQ-SAUDI ARABIA NEUTRAL ZONE
EI	IRELAND
IM	ISLE OF MAN
IS	ISRAEL
IW	ISRAEL-JORDAN DEMILITARIZED ZONE
IU	ISRAEL-SYRIA DEMILITARIZED ZONE
IT	ITALY
JM	JAMAICA
JN	JAN MAYEN
JA	JAPAN
JE	JERSEY
JO	JORDAN
JU	JUAN DE NOVA ISLAND
KZ	KAZAKHSTAN
KE	KENYA
KR	KIRIBATI
KU	KUWAIT
KG	KYRGYZSTAN
LA	LAOS
LG	LATVIA
LE	LEBANON
LT	LESOTHO
LI	LIBERIA
LY	LIBYA

**PESC XML Application for Admission Implementation Guide
Version 1.3.0**

Appendix J2: Passport Issuing Country Codes as defined by the US Federal Information Processing Standards (FIPS 10-4), National Imagery and Mapping Agency Sorted by Country Name	
COUNTRY CODE	COUNTRY NAME
LS	LIECHTENSTEIN
LH	LITHUANIA
LU	LUXEMBOURG
MC	MACAU
MK	MACEDONIA, THE FORMER YUGOSLAV REPUBLIC OF
MA	MADAGASCAR
MI	MALAWI
MY	MALAYSIA
MV	MALDIVES
ML	MALI
MT	MALTA
RM	MARSHALL ISLANDS
MB	MARTINIQUE
MR	MAURITANIA
MP	MAURITIUS
MF	MAYOTTE
MX	MEXICO
FM	MICRONESIA, FEDERATED STATES OF
MD	MOLDOVA
MN	MONACO
MG	MONGOLIA
MW	MONTENEGRO
MH	MONTSERRAT
MO	MOROCCO
MZ	MOZAMBIQUE
WA	NAMIBIA
NR	NAURU
NP	NEPAL
NL	NETHERLANDS
NT	NETHERLANDS ANTILLES
U2	NEUTRAL ZONE
NC	NEW CALEDONIA
NZ	NEW ZEALAND
NU	NICARAGUA
NG	NIGER
NI	NIGERIA

**PESC XML Application for Admission Implementation Guide
Version 1.3.0**

Appendix J2: Passport Issuing Country Codes as defined by the US Federal Information Processing Standards (FIPS 10-4), National Imagery and Mapping Agency Sorted by Country Name	
COUNTRY CODE	COUNTRY NAME
NE	NIUE
NF	NORFOLK ISLAND
KN	NORTH KOREA
NO	NORWAY
MU	OMAN
PK	PAKISTAN
PS	PALAU
PM	PANAMA
PP	PAPUA NEW GUINEA
PF	PARACEL ISLANDS
PA	PARAGUAY
PE	PERU
RP	PHILIPPINES
PC	PITCAIRN ISLANDS
PL	POLAND
PO	PORTUGAL
PT	PORTUGUESE TIMOR
QA	QATAR
VS	REPUBLIC OF VIET-NAM
RE	REUNION
RO	ROMANIA
RS	RUSSIA
RW	RWANDA
SH	SAINT HELENA
SC	SAINT KITTS AND NEVIS
ST	SAINT LUCIA
SB	SAINT PIERRE AND MIQUELON
VC	SAINT VINCENT AND THE GRENADINES
WS	SAMOA
SM	SAN MARINO
TP	SAO TOME AND PRINCIPE
SA	SAUDI ARABIA
SG	SENEGAL
SR	SERBIA
YI	SERBIA AND MONTENEGRO
SE	SEYCHELLES

**PESC XML Application for Admission Implementation Guide
Version 1.3.0**

Appendix J2: Passport Issuing Country Codes as defined by the US Federal Information Processing Standards (FIPS 10-4), National Imagery and Mapping Agency Sorted by Country Name	
COUNTRY CODE	COUNTRY NAME
SL	SIERRA LEONE
SK	SIKKIM
SN	SINGAPORE
LO	SLOVAKIA
SI	SLOVENIA
BP	SOLOMON ISLANDS
SO	SOMALIA
SF	SOUTH AFRICA
SX	SOUTH GEORGIA AND THE SOUTH SANDWICH ISLANDS
KS	SOUTH KOREA
RH	SOUTHERN RHODESIA
YQ	SOUTHERN RYUKYU ISLANDS
SP	SPAIN
ME	SPANISH NORTH AFRICA
SS	SPANISH SAHARA
PG	SPRATLY ISLANDS
CE	SRI LANKA
U3	STATELESS
SU	SUDAN
NS	SURINAME
SV	SVALBARD
JS	SVALBARD AND JAN MAYEN
SQ	SWAN ISLANDS
WZ	SWAZILAND
SW	SWEDEN
SZ	SWITZERLAND
SY	SYRIA
TW	TAIWAN
TI	TAJIKISTAN
TZ	TANZANIA
TH	THAILAND
TO	TOGO
TL	TOKELAU
TN	TONGA
TD	TRINIDAD AND TOBAGO
TE	TROMELIN ISLAND

**PESC XML Application for Admission Implementation Guide
Version 1.3.0**

Appendix J2: Passport Issuing Country Codes as defined by the US Federal Information Processing Standards (FIPS 10-4), National Imagery and Mapping Agency Sorted by Country Name	
COUNTRY CODE	COUNTRY NAME
TQ	TRUST TERRITORY OF THE PACIFIC ISLANDS
TS	TUNISIA
TU	TURKEY
TX	TURKMENISTAN
TK	TURKS AND CAICOS ISLANDS
TV	TUVALU
UG	UGANDA
UP	UKRAINE
UR	UNION OF SOVIET SOCIALIST REPUBLICS
AE	UNITED ARAB EMIRATES
UK	UNITED KINGDOM
IQ	UNITED STATES MISC. PACIFIC ISLANDS
U5	UNKNOWN
UY	URUGUAY
UZ	UZBEKISTAN
NH	VANUATU
VT	VATICAN CITY
VE	VENEZUELA
VM	VIETNAM
WF	WALLIS AND FUTUNA
WE	WEST BANK
WI	WESTERN SAHARA
YE	YEMAN (SANAA)
YM	YEMEN
YS	YEMEN (ADEN)
YO	YUGOSLAVIA
ZA	ZAMBIA
ZI	ZIMBABWE

**PESC XML Application for Admission Implementation Guide
Version 1.3.0**

Appendix K: US Port of Entry Codes Sorted by Port of Entry Code	
POE CODE	POE DESCRIPTION
ABG	ALBURG VT
ABQ	ALBUQUERQUE NM
ABS	ALBURG SPRINGS VT
ADT	AMISTAD DAM TX
AGA	AGANA GUAM
AGN	ALGONAC, MI
ALB	ALBANY, NY
ALC	ALCAN AK
AMB	AMBROSE ND
ANC	ANCHORAGE, AK
AND	ANDRADE CA
ANT	ANTLER ND
ARB	ARUBA NETH ANTILLES
AST	ASTORIA OR
ATL	ATLANTA GA
AUS	AUSTIN TX
BAL	BALTIMORE MD
BAU	BAUDETTE MN
BBM	BROWNSV'LE, MATAMOR.TX
BEB	BEEBE PLAIN, VT
BEE	BEECHER FALLS, VT
BEL	BELLINGHAM WA
BGM	BANGOR, ME
BLA	BLAINE WA
BOA	BRIDGE OF AMERICAS TX
BOS	BOSTON, MA
BRG	BURLINGTON, VT
BRO	BROWNSV'LE TX
BTN	BATON ROUGE LA
BWA	BOUNDARY WA
BWM	BRIDGEWATER, ME
BYO	BAYONNE, NJ
CAL	CALEXICO, CA
CHA	CHARLOTTE AMALIE
CHF	CHIEF MOUNTAIN, MT
CHI	CHICAGO, IL
CHL	CHARLESTON, SC
CHM	CHAMPLAIN, NY
CHR	CHRISTIANSTED, VI
CHT	CHATEAUGAY, NY
CIN	CINCINNATI, OH

**PESC XML Application for Admission Implementation Guide
Version 1.3.0**

Appendix K: US Port of Entry Codes Sorted by Port of Entry Code	
POE CODE	POE DESCRIPTION
CLE	CLEVELAND, OH
CLG	CALGARY, CN
CLM	COLUMBUS, OH
CLS	CALAIS, ME
CLT	CHARLOTTE, NC
CNA	CANAAN, VT
CNJ	CAMDEN, NJ
COB	COBURN GORE, ME
COL	COLUMBUS, NM
COO	COOS BAY, OR
COW	HEADQUARTERS
CRP	CORPUS CHRISTI, TX
CRU	CRUZ BAY, ST JOHN
CRY	CARBURY, ND
DAC	DALTONS CACHE, AK
DAL	DALLAS, TX
DCB	DETROIT, MI (BRIDGE)
DCT	DETROIT MI (TUNNEL)
DEN	DENVER CO
DER	DERBY LINE, VT (I91)
DET	DETROIT, MI
DLB	DEL BONITA, MT
DLR	DEL RIO, TX
DLV	DERBY LINE, VT (RT 5)
DNS	DUNSEITH, ND
DOU	DOUGLAS, AZ
DTH	DUTCH HARBOR, AK
DUL	DULUTH, MN
DVD	DOVER, DE AFB
DVL	DANVILLE, WA
EAS	EASTON, ME
EDA	EDMONTON, CN
EGP	EAGLE PASS, TX
EPI	EASTPORT, ID
EPM	EASTPORT, ME
ERC	EAST RICHFORD, VT
EST	ESTCOURT, ME
FAB	FABENS, TX
FAL	FALCON HEIGHTS, TX
FBA	FREEPORT, BAHAMAS
FER	FERRY, WA

**PESC XML Application for Admission Implementation Guide
Version 1.3.0**

Appendix K: US Port of Entry Codes Sorted by Port of Entry Code	
POE CODE	POE DESCRIPTION
FMY	FORT MYERS, FL
FOR	FOREST CITY, ME
FRB	FAIRBANKS, AK
FRT	FORTUNA, ND
FTC	FORT COVINGTON, NY
FTF	FORT FAIRFIELD, ME
FTH	FORT HANCOCK, TX
FTK	FORT KENT, ME
FWA	FRONTIER, WA
GAL	GALVESTON, TX
GPM	GRAND PORTAGE, MN
GRR	GREER, SC
GUL	GULFPORT, MS
HAM	HAMILTON, BERMUDA
HAR	HARTFORD, CT
HEL	HELENA, MT
HHW	HONOLULU HI
HID	HIDALGO, TX
HIG	HIGHGATE SPRINGS, VT
HML	HAMLIN, ME
HNN	HANNAH, ND
HNS	HANSBORO, ND
HOU	HOUSTON, TX
HTM	HOULTON, ME
INP	INDIANAPOLIS IN
INT	INTERNAT'L FALLS MN
IVP	CALEXICO, EAST, CA
JAC	JACKSONV'L FL
JKM	JACKMAN, ME
KAN	KANSAS CITY MO
KET	KETCHIKAN, AK
KEY	KEY WEST FL
KOA	KEAHOLE, KONA, HI
LAN	LANCASTER, MN
LAR	LAREDO, TX
LAU	LAURIER, WA
LCB	LAREDO COL BRIDGE, TX
LIM	LIMESTONE, ME
LKC	LAKE CHARLES, LA
LLB	JUAREZ, LINCN BRDG TX
LOI	LOS INDIOS, TX

**PESC XML Application for Admission Implementation Guide
Version 1.3.0**

Appendix K: US Port of Entry Codes Sorted by Port of Entry Code	
POE CODE	POE DESCRIPTION
LON	LONGVIEW, WA
LOS	LOS ANGELES, CA
LOU	LOUISVILLE KY
LSE	LOS EBANOS, TX
LUB	LUBEC, ME
LUK	LUKEVILLE AZ
LVG	LAS VEGAS NV
LYN	LYNDEN, WA
MAD	MADAWASKA, ME
MAG	MCGUIRE AFB, NJ
MAI	MAIDA, ND
MAP	MARIPOSA, AZ
MAS	MASSENA, NY
MAY	MAYAGUEZ, PR
MEM	MEMPHIS TN
MET	METALINE FALLS, WA
MGM	MORGAN, MT
MIA	MIAMI, FL
MIL	MILWAUKEE, WI
MND	MINOT ND
MOB	MOBILE, AL
MON	MONTREAL, CN
MOO	MOORES, NY
MOR	MORSES LINE, VT
MRC	MARINE CITY, MI
MSP	MINNEAPOLIS, ST. PAUL AIRPORT
MTC	MONTICELLO, ME
NAC	NACO, AZ
NAS	NASSAU BAHAMAS
NEC	NECHE, ND
NEW	NEWARK, NJ
NIA	NIAGARA FALLS, NY
NIG	NIGHTHAWK, WA
NOG	NOGALES, AZ
NOL	NEW ORLEANS, LA
NOM	NOME, AK SEAPORT
NOO	NOONAN, ND
NOR	NORFOLK VA
NOY	NOYES, MN
NPT	NEWPORT, OR
NRG	NORTHGATE, ND

**PESC XML Application for Admission Implementation Guide
Version 1.3.0**

Appendix K: US Port of Entry Codes Sorted by Port of Entry Code	
POE CODE	POE DESCRIPTION
NRN	NORTON, VT
NRT	NORTH TROY, VT
NSV	NASHVILLE, TN
NYC	NEW YORK, NY
OGD	OGDENSBURG, NY
OKC	OKLAHOMA CITY, OK
OMA	OMAHA, NE
OPH	OPHEIM, MT
ORI	ORIENT, ME
ORL	ORLANDO, FL
ORO	OROVILLE, WA
OTM	OTAY MESA, CA
OTT	OTTAWA, CN
PAN	PANAMA CITY, FL
PAR	PORT ARTHUR, TX
PBB	PEACE BRIDGE, NY
PCF	PORT CANAVERAL, FL
PDN	PASO DEL NORTE, TX
PEM	PEMBINA, ND
PEV	PORT EVERGLADES, FL
PGR	PROGRESO, TX
PHI	PHILADELPHI, PA
PHO	PHOENIX AZ
PHR	PHARR, TX
PHU	PORT HURON, MI
PHY	BLAINE, WA PACIFIC HWY
PIB	PARADISE ISLAND, BS
PIE	PIEGAN, MT
PIN	PINE CREEK, MN
PIT	PITTSBURGH, PA
PIV	PINNACLE ROAD, VT
PKC	POKER CREEK, AK
PNG	PORT ANGELES, WA
PNH	PITTSBURG, NH
POM	PORTLAND, ME
PON	PONCE, PR
POO	PORTLAND OR
POR	PORTAL, ND
PRE	PRESIDIO, TX
PRO	PROVIDENCE, RI
PTL	PORTHILL, ID

**PESC XML Application for Admission Implementation Guide
Version 1.3.0**

Appendix K: US Port of Entry Codes Sorted by Port of Entry Code	
POE CODE	POE DESCRIPTION
PTR	POINT ROBERTS,WA
RAY	RAYMOND, MT
RDU	RALEIGH/DURHAM, NC
REN	RENO, NV
RIF	RICHFORD, VT
RIO	RIO GRANDE CITY, TX
ROM	ROMA, TX
ROO	ROOSVILLE, MT
ROS	ROSEAU, MN
ROU	ROUSES POINT, NY
SAJ	SAN JUAN, PR
SAR	SARLES, ND
SAS	SASABE, AZ
SAU	ST AUGUSTINE, FL
SAV	SAVANNAH, GA
SCO	SCOBAY, MT
SDP	SAN DIEGO, CA
SDY	SANDUSKY, OH
SEA	SEATTLE, WA
SET	SEATTLE, WA
SFB	SANFORD, FL
SFR	SAN FRANCISCO, CA
SHR	SHERWOOD, ND
SJO	ST JOHN, ND
SKA	SKAGWAY, AK
SLC	SALT LAKE CITY, UT
SLU	SAN LUIS, AZ
SNA	SAN ANTONIO, TX
SND	SAN DIEGO, CA
SNJ	SAN JOSE, CA
SNN	SHANNON, IRELAND
SPA	ST PAMPILE, ME
SPE	ST. PETERSBURG, FL
SPM	ST PAUL, MN
SPO	SPOKANE, WA
SRL	ST AURELIE, ME
SSB	SEATTLE SEAPORT
SSM	SAULT STE. MARIE, MI
STL	ST LOUIS, MO
STR	SANTA TERESA, NM
STT	ST THOMAS, VI

**PESC XML Application for Admission Implementation Guide
Version 1.3.0**

Appendix K: US Port of Entry Codes Sorted by Port of Entry Code	
POE CODE	POE DESCRIPTION
SUM	SUMAS, WA
SWE	SWEETGRASS, MT
SYS	SAN YSIDRO, CA
TAC	TACOMA, WA
TAM	TAMPA, FL
TEC	TECATE, CA
THO	THOUSAND ISL BRDGE, NY
TOL	TOLEDO, OH
TOR	TORONTO, CANADA
TRO	TROUT RIVER, NY
TUC	TUCSON AZ/SUB
TUR	TURNER, MT
VCB	VANCEBORO, ME
VCV	VANCOUVER CN
VIC	VICTORIA CANADA
VNB	VAN BUREN, ME
WAL	WALHALLA, ND
WAR	WARROAD, MN
WAS	WASHINGTON DC
WBE	WEST BERKSHIRE, VT
WCM	WILLOW CREEK, MT
WHI	WHITETAIL, MT
WHM	WILD HORSE, MT
WHO	WESTHOPE, ND
WIL	WILMINGTON, NC
WIN	WINNIPEG, CN
WND	WILLISTON, ND
WPB	WEST PALM BEACH, FL
YSL	YSLETA, TX
YUI	YUMA AIRPORT, AZ

**PESC XML Application for Admission Implementation Guide
Version 1.3.0**

Appendix L: US Visa Issuance Post Codes Sorted by Visa Post Code	
VISA POST CODE	VISA POST DESCRIPTION
ABD	ABU DHABI
ABJ	ABIDJAN
ABU	ABUJA
ACC	ACCRA
ADA	ADDIS ABADA
ADN	ADANA
AKD	ASHGABAT
ALG	ALGIERS
ALX	ALEXANDRIA
AMM	AMMAN
AMS	AMSTERDAM
ANK	ANKARA
ANT	ANTANANARIVO
APA	APIA
ASC	ASUNCION
ATA	ALMA ATA
ATH	ATHENS
ATW	ANTWERP
AUC	AUCKLAND
BAG	BAGHDAD
BAM	BAMAKO
BAN	BANGKOK
BAR	BARRANQUILLA
BDS	BANDAR SERI BEGAWAN
BEI	BEIJING
BEL	BELEM
BER	BERLIN
BET	BELFAST
BGD	BELGRADE
BIL	BILBAO
BIS	BISSAU
BKK	BISHKEK
BKU	BAKU
BLA	BLANTYRE
BLZ	BELIZE CITY
BNG	BANGUI
BNJ	BANJUL
BOG	BOGOTA
BOM	BOMBAY

**PESC XML Application for Admission Implementation Guide
Version 1.3.0**

Appendix L: US Visa Issuance Post Codes Sorted by Visa Post Code	
VISA POST CODE	VISA POST DESCRIPTION
BON	BONN
BOR	BORDEAUX
BRA	BRASILIA
BRC	BARCELONA
BRE	BREMEN
BRI	BRIDGETOWN
BRN	BERN
BRT	BEIRUT
BRU	BRUSSELS
BRV	BRAZZAVILLE
BSB	BRISBANE
BTS	BRATISLAVA
BUC	BUCHAREST
BUD	BUDAPEST
BUE	BUENOS AIRES
BUJ	BUJUMBURA
BUK	BUKAVU
CAI	CALI
CAL	CALCUTTA
CAN	CANBERRA
CAO	CAIRO
CAP	CAPE TOWN
CAR	CARACAS
CAS	CASABLANCA
CDJ	CIUDAD JUAREZ
CEB	CEBU
CHE	CHENGDU
CHN	CHIANG MAI
CLG	CALGARY
COL	COLOMBO
CON	CONAKRY
COP	COPENHAGEN
COT	COTONOU
CUR	CURACAO
DAC	DHAKA
DAK	DAKAR
DAM	DAMASCUS
DAR	DAR ES SALAAM
DBI	DUBAI

**PESC XML Application for Admission Implementation Guide
Version 1.3.0**

Appendix L: US Visa Issuance Post Codes Sorted by Visa Post Code	
VISA POST CODE	VISA POST DESCRIPTION
DHA	DHAHRAN
DHB	DUSHANBE
DJI	DJIBOUTI
DOH	DOHA
DOU	DOUALA
DUB	DUBLIN
DUR	DURBAN
DUS	DUSSELDORF
EDI	EDINBURGH
FKT	FRANKFURT
FLO	FLORENCE
FRE	FREETOWNN
FUK	FUKUOKA
GAB	GABORONE
GEN	GENEVA
GNG	GUANGZHOU
GOA	GENOA
GTW	GEORGETOWN
GUA	GUATEMALA
GUJ	GUADALAJARA
GUQ	GUAYAQUIL
HAG	HAGUE
HAI	HAIFA
HAL	HALIFAX
HAM	HAMBURG
HAR	HARARE
HAV	HAVANA
HCM	HO CHI MINH CITY, VIETNAM
HEL	HELSINKI
HER	HERMOSILLO
HKG	HONG KONG
HMN	HAMILTON
HON	HONIORA
ISL	ISLAMABAD
IST	ISTANBUL
IZM	IZMIR
JAK	JAKARTA
JER	JERUSALEM
JID	JEDDAH

**PESC XML Application for Admission Implementation Guide
Version 1.3.0**

Appendix L: US Visa Issuance Post Codes Sorted by Visa Post Code	
VISA POST CODE	VISA POST DESCRIPTION
JOH	JOHANNESBURG
KAB	KABUL
KAD	KADUNA
KAM	KAMPALA
KAP	KARACHI
KAT	KATHMANDU
KEV	KIEV
KHA	KHARTOUM
KIG	KIGALI
KIN	KINGSTON
KNS	KINSHASA
KNV	CHISINAU
KOL	KOLONIA
KOR	KOROR
KRA	KRAKOW
KUL	KUALA LUMPUR
KUW	KUWAIT
LAG	LAGOS
LAH	LAHORE
LAP	LA PAZ
LEI	LIEPZIG
LEN	LENINGRAD
LIB	LIBREVILLE
LIL	LILONGWE
LIM	LIMA
LIS	LISBON
LIV	LIVERPOOL
LOM	LOME
LON	LONDON
LUA	LUANDA
LUB	LUBUMBASHI
LUS	LUSAKA
LUX	LUXEMBOURG
LYN	LYON
MAA	MANAMA
MAD	MADRID
MAJ	MAJURO
MAL	MALABO
MAN	MANILA

**PESC XML Application for Admission Implementation Guide
Version 1.3.0**

Appendix L: US Visa Issuance Post Codes Sorted by Visa Post Code	
VISA POST CODE	VISA POST DESCRIPTION
MAP	MAPUTO
MAR	MARACAIBO
MAS	MASERU
MAT	MATAMOROS
MAZ	MAZATLAN
MBA	MBABANE
MDR	MADRAS
MDS	MADRAS
MED	MEDAN
MEL	MELBOURNE
MER	MERIDA
MEX	MEXICO CITY
MIL	MILAN
MNG	MANAGUA
MNT	MONTREAL
MOG	MOGADISHU
MON	MONROVIA
MOR	MORONI
MOS	MOSCOW
MRS	MARSEILLE
MRT	MARTINIQUE
MSA	MOMBASA
MSK	MINSK
MTR	MONTERREY
MTV	MONTEVIDEO
MUN	MUNICH
MUS	MUSCAT
NAH	NAHA
NAI	NAIROBI
NAP	NAPLES
NAS	NASSAU
NDJ	N.DJAMENA
NDL	NEW DELHI
NIA	NIAMEY
NIC	NICOSIA
NOU	NOUAKCHOTT
NUV	NUEVO LAREDO
OPO	OPORTO
ORN	ORAN

**PESC XML Application for Admission Implementation Guide
Version 1.3.0**

Appendix L: US Visa Issuance Post Codes Sorted by Visa Post Code	
VISA POST CODE	VISA POST DESCRIPTION
OSK	OSAKA-KOBE
OSL	OSLO
OTT	OTTAWA
OUA	OUAGADOUGOU
PAG	PORTO ALEGRE
PAL	PALERMO
PAN	PANAMA CITY
PAP	PORT-AU-PRINCE
PAR	PARIS
PDE	PONTA DELGADA
PER	PERTH
PES	PESHAWAR
PHP	U. S. CONSULATE OFFICE, PHNPM PENN
PLS	PORT LOUIS
PMB	PORT MORESBY
POS	PORT OF SPAIN
POZ	POZNAN
PPO	PAGO PAGO
PRA	PRAIA
PRB	PARAMARIBO
PRE	PRETORIA
PRG	PRAGUE
PRM	PARAMARIBO
PSN	PUSAN
QUE	QUEBEC
QUI	QUITO
RAB	RABAT
RAN	RANGOON
RDJ	RIO DE JANEIRO
REC	RECIFE
REY	REYKJAVIK
RGA	RIGA
RID	RIYADH
ROM	ROME
ROT	ROTTERDAM
SAJ	SAIPAN
SAL	SALISBURY
SAN	SANTIAGO
SAP	SAO PAULO

**PESC XML Application for Admission Implementation Guide
Version 1.3.0**

Appendix L: US Visa Issuance Post Codes Sorted by Visa Post Code	
VISA POST CODE	VISA POST DESCRIPTION
SEO	SEOUL
SEV	SEVILLE
SGE	ST. GEORGES
SHA	SHANGHAI
SIN	SINGAPORE
SLZ	SALZBURG
SNA	SANAA
SND	SANTO DOMINGO
SNJ	SAN JOSE
SNS	SAN SALVADOR
SNY	SHENYANG
SOF	SOFIA
SOK	SONGKHLA
SPP	SAPPORO
SPT	ST. PETERSBURG
STJ	ST. JOHNS
STO	STOCKHOLM
STR	STRASBOURG
STU	STUTTGART
SUR	SURABAYA
SUV	SUVA
SVD	SALVADOR
SYD	SYDNEY
TAI	TAIPEI
TAL	TALLINN
TAN	TANGIER
TBL	TBILISI
TEG	TEGUCIGALPA
TEH	TEHRAN
TEL	TEL AVIV
THE	THESSALONIKI
THT	TASHKENT
TIA	TIRANA
TIJ	TIJUANA
TOK	TOKYO
TOR	TORONTO
TRI	TRIESTE
TRP	TRIPOLI
TUN	TUNIS

**PESC XML Application for Admission Implementation Guide
Version 1.3.0**

Appendix L: US Visa Issuance Post Codes Sorted by Visa Post Code	
VISA POST CODE	VISA POST DESCRIPTION
UDN	UDORN
ULN	ULAANBAATAR
VAL	VALLETTA
VAN	VANCOUVER
VAT	VATICAN CITY
VIC	VICTORIA
VIE	VIENNA
VIL	VILNIUS
VIT	VIENTIANE
VW	VISA WAIVER
WAR	WARSAW
WDC	WASHINGTON
WEL	WELLINGTON
WHK	WINDHOEK
WIN	WINNEPEG
YAO	YAOUNDE
YRV	YEREVAN
ZAG	ZAGREB
ZUR	ZURICH

**PESC XML Application for Admission Implementation Guide
Version 1.3.0**

Appendix M1: Student Activity Codes Sorted by Activity within Major Category	
Category	Activity
Clubs	BoyScouts
Clubs	Club4H
Clubs	ClubArt
Clubs	ClubCareer
Clubs	ClubChess
Clubs	ClubComputer
Clubs	ClubDistributiveEducationAmerica
Clubs	ClubDrama
Clubs	ClubEnvironmental
Clubs	ClubEthnic
Clubs	ClubForeignLanguage
Clubs	ClubFrench
Clubs	ClubFutureBusinessLeadersAmerica
Clubs	ClubFutureFarmersAmerica
Clubs	ClubFutureHomemakersAmerica
Clubs	ClubFutureTeachersAmerica
Clubs	ClubGerman
Clubs	ClubHealthOccupationsStudentsAmerica
Clubs	ClubItalian
Clubs	ClubLatin
Clubs	ClubOther
Clubs	ClubPortuguese
Clubs	ClubRussian
Clubs	ClubScience
Clubs	ClubSpanish
Clubs	ClubSpeechDebate
Clubs	ClubStudentsAgainstDrunkDriving
Clubs	Fraternity
Clubs	GirlScouts
Clubs	KeyClub
Clubs	PeerCounseling
Clubs	Sorority
Clubs	Tutoring

PESC XML Application for Admission Implementation Guide Version 1.3.0

Appendix M1: Student Activity Codes Sorted by Activity within Major Category	
Category	Activity
HonorSociety	AcademicHonorSociety
HonorSociety	AcademicTeamBrainBowl
HonorSociety	ClubBeta
HonorSociety	ClubMuAlphaTheta
HonorSociety	ClubPsiEtaScience
HonorSociety	NationalForensicsLeague
HonorSociety	NationalHonorSociety
HonorSociety	ThespianSociety
Inventions	Invention
Inventions	Patent
Inventions	Research
Journalism	Broadcasting
Journalism	Journalism
Journalism	JournalismOther
Journalism	LiteraryMagazine
Journalism	YearBook
Leadership	ClassOfficer
Leadership	ClassPresident
Leadership	StudentBodyOfficer
Leadership	StudentBodyPresident
Leadership	StudentLeadershipOther
PerformingArts	ArtGraphicDesign
PerformingArts	Band
PerformingArts	Chorus
PerformingArts	Dance
PerformingArts	DanceTeam
PerformingArts	DrillTeam
PerformingArts	JazzEnsemble
PerformingArts	MusicInstrumental
PerformingArts	MusicOther
PerformingArts	MusicTheoryComposition
PerformingArts	MusicVocal
PerformingArts	Orchestra

**PESC XML Application for Admission Implementation Guide
Version 1.3.0**

Appendix M1: Student Activity Codes Sorted by Activity within Major Category	
Category	Activity
PerformingArts	PerformingArtsOther
PerformingArts	TheaterDrama
Publications	Dissertation
Publications	NovelBook
Publications	Poetry
Publications	ProfessionalPresentation
Publications	ProfessionalScholarlyArticle
Publications	ProseShortStory
Publications	PublicationOther
Publications	Textbook
Publications	Thesis
Publications	UnpublishedManuscript
Sports	Archery
Sports	Badminton
Sports	Baseball
Sports	Basketball
Sports	Bowling
Sports	Boxing
Sports	Cheerleading
Sports	Crew
Sports	CrossCountry
Sports	Diving
Sports	DivingScuba
Sports	Fencing
Sports	Football
Sports	Golf
Sports	Gymnastics
Sports	HandballTeam
Sports	HockeyField
Sports	HockeyIce
Sports	HorsebackRiding
Sports	Lacrosse
Sports	ManagerTeam

**PESC XML Application for Admission Implementation Guide
Version 1.3.0**

Appendix M1: Student Activity Codes Sorted by Activity within Major Category	
Category	Activity
Sports	MartialArts
Sports	Polo
Sports	PoloWater
Sports	Racquetball
Sports	Riflery
Sports	Rodeo
Sports	Rugby
Sports	Sailing
Sports	Skiing
Sports	Soccer
Sports	Softball
Sports	SportOther
Sports	Squash
Sports	Swimming
Sports	SwimmingSynchronized
Sports	Tennis
Sports	TennisTable
Sports	TrackField
Sports	Volleyball
Sports	Wrestling
Volunteering	ChurchService
Volunteering	CommunityService
Volunteering	VolunteeringOther
Volunteering	VolunteerWork

PESC XML Application for Admission Implementation Guide Version 1.3.0

Appendix M2: Student Activity Codes Sorted by Activity	
Category	Activity Code
HonorSociety	AcademicHonorSociety
HonorSociety	AcademicTeamBrainBowl
Sports	Archery
PerformingArts	ArtGraphicDesign
Sports	Badminton
PerformingArts	Band
Sports	Baseball
Sports	Basketball
Sports	Bowling
Sports	Boxing
Clubs	BoyScouts
Journalism	Broadcasting
Sports	Cheerleading
PerformingArts	Chorus
Volunteering	ChurchService
Leadership	ClassOfficer
Leadership	ClassPresident
Clubs	Club4H
Clubs	ClubArt
HonorSociety	ClubBeta
Clubs	ClubCareer
Clubs	ClubChess
Clubs	ClubComputer
Clubs	ClubDistributiveEducationAmerica
Clubs	ClubDrama
Clubs	ClubEnvironmental
Clubs	ClubEthnic
Clubs	ClubForeignLanguage
Clubs	ClubFrench
Clubs	ClubFutureBusinessLeadersAmerica
Clubs	ClubFutureFarmersAmerica
Clubs	ClubFutureHomemakersAmerica
Clubs	ClubFutureTeachersAmerica

PESC XML Application for Admission Implementation Guide Version 1.3.0

Appendix M2: Student Activity Codes Sorted by Activity	
Category	Activity Code
Clubs	ClubGerman
Clubs	ClubHealthOccupationsStudentsAmerica
Clubs	ClubItalian
Clubs	ClubLatin
HonorSociety	ClubMuAlphaTheta
Clubs	ClubOther
Clubs	ClubPortuguese
HonorSociety	ClubPsiEtaScience
Clubs	ClubRussian
Clubs	ClubScience
Clubs	ClubSpanish
Clubs	ClubSpeechDebate
Clubs	ClubStudentsAgainstDrunkDriving
Volunteering	CommunityService
Sports	Crew
Sports	CrossCountry
PerformingArts	Dance
PerformingArts	DanceTeam
Publications	Dissertation
Sports	Diving
Sports	DivingScuba
PerformingArts	DrillTeam
Sports	Fencing
Sports	Football
Clubs	Fraternity
Clubs	GirlScouts
Sports	Golf
Sports	Gymnastics
Sports	HandballTeam
Sports	HockeyField
Sports	HockeyIce
Sports	HorsebackRiding
Inventions	Invention

PESC XML Application for Admission Implementation Guide Version 1.3.0

Appendix M2: Student Activity Codes Sorted by Activity	
Category	Activity Code
PerformingArts	JazzEnsemble
Journalism	Journalism
Journalism	JournalismOther
Clubs	KeyClub
Sports	Lacrosse
Journalism	LiteraryMagazine
Sports	ManagerTeam
Sports	MartialArts
PerformingArts	MusicInstrumental
PerformingArts	MusicOther
PerformingArts	MusicTheoryComposition
PerformingArts	MusicVocal
HonorSociety	NationalForensicsLeague
HonorSociety	NationalHonorSociety
Publications	NovelBook
PerformingArts	Orchestra
Other	Other
Inventions	Patent
Clubs	PeerCounseling
PerformingArts	PerformingArtsOther
Publications	Poetry
Sports	Polo
Sports	PoloWater
Publications	ProfessionalPresentation
Publications	ProfessionalScholarlyArticle
Publications	ProseShortStory
Publications	PublicationOther
Sports	Racquetball
Inventions	Research
Sports	Riflery
Sports	Rodeo
Sports	Rugby
Sports	Sailing

**PESC XML Application for Admission Implementation Guide
Version 1.3.0**

Appendix M2: Student Activity Codes Sorted by Activity	
Category	Activity Code
Sports	Skiing
Sports	Soccer
Sports	Softball
Clubs	Sorority
Sports	SportOther
Sports	Squash
Leadership	StudentBodyOfficer
Leadership	StudentBodyPresident
Leadership	StudentLeadershipOther
Sports	Swimming
Sports	SwimmingSynchronized
Sports	Tennis
Sports	TennisTable
Publications	Textbook
PerformingArts	TheaterDrama
Publications	Thesis
HonorSociety	ThespianSociety
Sports	TrackField
Clubs	Tutoring
Publications	UnpublishedManuscript
Sports	Volleyball
Volunteering	VolunteeringOther
Volunteering	VolunteerWork
Sports	Wrestling
Journalism	YearBook

PESC XML Application for Admission Implementation Guide Version 1.3.0

Appendix N – EducationTestCode and TestName

Note: This is the new set of Academic Test Codes approved by the PESC Workgroup on Education Test Score Reporting.

Appendix N – EducationTestCode and EducationTestName	
Test Code	Test Name
ACT	The ACT
ACTExplore	ACT EXPLORE
ACTInterestInventory	ACT Interest Inventory
ACTPlan	ACT PLAN
ACTWorkKeys	ACT WorkKeys
APArtDrawing	College Board Adv Placement in Art - Drawing
APArtGeneral	College Board Adv Placement in Art - General
APBiology	College Board Adv Placement in Biology
APCalculusAB	College Board Adv Placement in Calculus AB
APCalculusBC	College Board Adv Placement in Calculus BC
APChemistry	College Board Adv Placement in Chemistry
APComputerScienceA	College Board Adv Placement in Computer Science A
APComputerScienceB	College Board Adv Placement in Computer Science B
APEconomicsMacro	College Board Adv Placement in Economics Macro
APEconomicsMicro	College Board Adv Placement in Economics Micro
APEnglishLanguageComposition	College Board Adv Placement in English Language Composition
APFrenchLanguage	College Board Adv Placement in French Language
APFrenchLiterature	College Board Adv Placement in French Literature
APGermanLanguage	College Board Adv Placement in German Language
APGovernmentPoliticsComparative	College Board Adv Placement in Government & Politics - Comparative
APGovernmentPoliticsUS	College Board Adv Placement in Government & Politics - US
APHistoryArt	College Board Adv Placement in Art History
APHistoryEurope	College Board Adv Placement in European History
APHistoryUS	College Board Adv Placement in US History
APLatinCatHor	College Board Adv Placement in Latin Cat Hor
APLatinVergil	College Board Adv Placement in Latin - Vergil
APMusicListeningLiterature	College Board Adv Placement in Music Listening & Literature
APMusicTheory	College Board Adv Placement in Music Theory
APPhysics	College Board Adv Placement in Physics

PESC XML Application for Admission Implementation Guide Version 1.3.0

Appendix N – EducationTestCode and EducationTestName	
Test Code	Test Name
APPhysicsEngineeringMechanics	College Board Adv Placement in Physics C - E & M
APPhysicsMechanics	College Board Adv Placement in Physics C - Mech
APPsychology	College Board Adv Placement in Psychology
APSpanishLanguage	College Board Adv Placement in Spanish Language
APSpanishLiterature	College Board Adv Placement in Spanish Literature
CaliforniaHighSchoolExitExam	California High School Exit Exam
CLEPAccountingFinancial	College Level Examination Program - Financial Accounting
CLEPAgebraCollege	College Level Examination Program - College Algebra
CLEPBiology	College Level Examination Program - Biology
CLEPBusinessLawIntroduction	College Level Examination Program - Introduction to Business Law
CLEPCalculus	College Level Examination Program - Calculus
CLEPChemistry	College Level Examination Program - Chemistry
CLEPCompositionCollegeFreshman	College Level Examination Program - Freshman College Composition
CLEPCompsitionEnglish	College Level Examination Program - EnglishComposition
CLEPEconomicsMacro	College Level Examination Program - Principles of Macroeconomics
CLEPEconomicsMicro	College Level Examination Program - Principles of Microeconomics
CLEPEnglishComposition	College Level Examination Program - English Composition
CLEPFrenchLanguage	College Level Examination Program - French Language (Levels 1 and 2)
CLEPGermanLanguage	College Level Examination Program - German Lanaguage (Levels 1 and 2)
CLEPGovernmentAmerican	College Level Examination Program - American Government
CLEPHistoryUSFrom1865	College Level Examination Program - U.S. History II:1865 to Present
CLEPHistoryUSTo1877	College Level Examination Program - U.S. History I: Early Colonization to 1877
CLEPHumanGrowthDevelopment	College Level Examination Program - Human Growth and Development
CLEPHumanities	College Level Examination Program - Humanities
CLEPInformationSystems	College Level Examination Program - Information Systems and Computer Applications
CLEPLanguageSpanish	College Level Examination Program - Spanish Language (Levels 1 and 2)
CLEPLiteratureAmerican	College Level Examination Program - American Literature

PESC XML Application for Admission Implementation Guide Version 1.3.0

Appendix N – EducationTestCode and EducationTestName	
Test Code	Test Name
CLEPLiteratureAnalysisAndInterpreting	College Level Examination Program - Analyzing and Interpreting Literature
CLEPLiteratureEnglish	College Level Examination Program - English Literature
CLEPManagement	College Level Examination Program - Principles of Management
CLEPMarketing	College Level Examination Program - Principles of Marketing
CLEPMath	College Level Examination Program - Mathematics
CLEPMathCollege	College Level Examination Program - College Mathematics
CLEPPreCalculus	College Level Examination Program - Precalculus
CLEPPsychologyEducational	College Level Examination Program - Educational Psychology
CLEPPsychologyIntroductory	College Level Examination Program - Introductory Psychology
CLEPSciencesNatural	College Level Examination Program - Natural Science
CLEPSocialSciencesAndHistory	College Level Examination Program - Social Sciences and History
CLEPSociologyIntroductory	College Level Examination Program - Introductory Sociology
CLEPWesternCivilizationFrom1648	College Level Examination Program - Western Civilization II: 1648 to Present
CLEPWesternCivilizationTo1648	College Level Examination Program - Western Civilization I: Ancient Near East to 1648
GED	General Education Development
GMAT	GMAT (Graduate Management Admission Test)
GRE	Graduate Record Examination General Test (ETS)
GREBiochemistryCellMolecular	Graduate Record Examination General Test (ETS)
GREBiology	Graduate Record Examination - Biology
GREChemistry	Graduate Record Examination - Chemistry
GREComputerScience	Graduate Record Examination - Computer Science
GRELiteratureEnglish	Graduate Record Examination - Literature in English
GREMathematics	Graduate Record Examination - Mathematics
GREPhysics	Graduate Record Examination - Physics
GREPsychology	Graduate Record Examination - Psychology
IELTS	International English Language Testing System (Cambridge)
InternationalBaccalaureate	International Baccalaureate
LSAT	Law School Admission Test
MCAT	Medical Colleges Admissions Test
OtherStateTest	Other State Test

PESC XML Application for Admission Implementation Guide Version 1.3.0

Appendix N – EducationTestCode and EducationTestName	
Test Code	Test Name
OtherTest	Other Test
SAT	SAT Reasoning Test
SATBiology	SAT Subject Test - Biology E/M
SATChemistry	SAT Subject Test - Chemistry
SATChineseListening	SAT Subject Test - Chinese with Listening
SATFrenchListening	SAT Subject Test - French Listening
SATGerman	SAT Subject Test - German
SATGermanListening	SAT Subject Test - German Listening
SATHebrew	SAT Subject Test - Hebrew
SATHebrewModern	SAT Subject Test - Modern Hebrew
SATHistoryWorld	SAT Subject Test - World History
SATItalian	SAT Subject Test - Italian
SATJapaneseWithListening	SAT Subject Test - Japanese with Listening
SATKoreanListening	SAT Subject Test - Korean with Listening
SATLatin	SAT Subject Test - Latin
SATLiterature	SAT Subject Test - Literature
SATMath1	SAT Subject Test - Mathematics Level I
SATMath2	SAT Subject Test - Mathematics Level II
SATPhysics	SAT Subject Test - Physics
SATSpanish	SAT Subject Test - Spanish
SATSpanishListening	SAT Subject Test - Spanish Listening
SATUSHistory	SAT Subject Test - American History
TABE	Test of Adult Basic Education
TOEFL	Test of English as a Foreign Language

PESC XML Application for Admission Implementation Guide Version 1.3.0

Appendix P – EducationSubtestCode and EducationSubtestName

Note: This is the new set of codes for Subtests that has been approved by the PESC Workgroup for Education Test Score Reporting

Appendix P – EducationSubtestCode and EducationSubtestName	
Subtest Code	Subtest Name
Algebra	Algebra
Algebra1	Algebra 1
AlgebraGeometryCoordinate	Algebra/Coordinate Geometry
Analytical	Analytical Writing
Biochemistry	Biochemistry
Biology	Biology
BiologyCell	Cell Biology
BiologyCellularAndMolecular	Cellular and Molecular Biology
BiologyMolecularAndGenetics	Molecular Biology and Genetics
BiologyOrganismal	Organismal Biology
Chemistry	Chemistry
CompositeScore	Composite
Comprehension	Comprehension
Computation	Computation
ConceptsApplications	Concepts/Applications
EcologyAndEvolution	Ecology and Evolution
English	English
EnglishA	English A
EnglishB	English B
EnglishLanguageArts	English-Language Arts
EnglishRhetoricalSkills	English: Rhetorical Skills
EnglishTestOfStandardWritten	Test of Standard Written English
EnglishUsageMechanics	English: Usage/Mechanics
Essay	Essay 1
Expression	Expression
Fit	Personal Skills: Fit
GeometryTrigonometry	Geometry/Trigonometry
HistoryAmerican	History (American)
HistoryEuropean	History (European)
InformationLocating	Locating Information
InterestArts	Interest in Arts
InterestBusinessContact	Interest in Business Contact
InterestBusinessOperations	Interest in Business Operations
InterestScience	Interest in Science
InterestSocialScience	Interest in Social Science
InterestTechnical	Interest Technical
LanguageArts	Language Arts

PESC XML Application for Admission Implementation Guide Version 1.3.0

Appendix P – EducationSubtestCode and EducationSubtestName	
Subtest Code	Subtest Name
LanguageForeignA	Foreign Language A
LanguageForeignB	Foreign Language B
Listening	Listening
ListeningComprehension	Listening Comprehension
LiteraryResponses	Literary Responses and Analysis
LiteratureAndArtsInterpreting	Interpreting Literature and the Arts
Math	Mathematics
MathAlgebraPreAlgebra	Mathematics: Pre-algebra/Algebra
MathApplied	Applied Mathematics
MathElementaryPreAlgebra	Mathematics: Pre-algebra/elementary
MathGeometry	Mathematics: Geometry
MathIntermediate	Mathematics: Intermediate
MathPlaneGeometryTrigonometry	Mathematics: Plane Geometry and Trigonometry
MeasurementAndGeometry	Measurement & Geometry
Mechanics	Mechanics
NumberSense	Number Sense
Observation	Observation
OtherSubtest	Other subtest
Performance	Personal Skills: Performance
Physics	Physics
ProbabilityAndStatistics	Probability and Statistics
PsychologyExperimental	Experimental Psychology
PsychologySocial	Social Psychology
Quantitative	Quantitative
Reading	Reading
ReadingArtsLiterature	Reading: Arts/Literature
ReadingComprehension	Reading Comprehension
ReadingInformational	Reading for Information
ReadingSocialStudiesScience	Reading: Social Studies/Science
Science	Science
SocialStudies	Social Studies
Spelling	Spelling
Talent	Personal Skills: Talent
Teamwork	Teamwork
TechnologyApplied	Applied Technology
Total	Total
TotalScore	Total
Usage	Usage
Verbal	Verbal
Vocabulary	Vocabulary
WordAnalysis	Word Analysis
Writing	Writing
WritingAnalytical	Analytical Writing Assessment
WritingBusiness	Business Writing

PESC XML Application for Admission Implementation Guide Version 1.3.0

Appendix P – EducationSubtestCode and EducationSubtestName	
Subtest Code	Subtest Name
WritingConventions	Writing Conventions
WritingEnglish	Combined Writing/English
WritingStrategies	Writing Strategies
WrittenExpressionAndStructure	Structure and Written Expression

Appendix Q – Course Academic Grade Scale Codes

I. Five or more passing grades (alpha with +/-)												
Code	Grades Used											
Wt	4.0	3.7	3.3	3.0	2.7	2.3	2.0	1.7	1.3	1.0	0.7	0.0
01	A	A-	B+	B	B-	C+	C	C-	D+	D	D-	F
02	A+,A	A-	B+	B	B-	C+	C	C-	D+	D	D-	F
03	A		B+	B		C+	C		D+	D		F
04	A+, A		B+	B		C+	C		D+	D		F
05	A+, A	A-	B+	B	B-	C+	C	C-	D+	D		F
06	A	A-	B+	B	B-	C+	C	C-				F
07	A		B+	B		C+	C			D		F
08	A	A-	B+	B	B-	C+	C	C-	D+	D		F
09	A	A-	B+	B	B-	C+	C	C-		D		F
10	A	A-	B+	B	B-	C+	C	C-	D+	D	D-	E/NC
11	A+, A	A-	B+	B	B-	C+	C	C-				
12	A+, A	A-	B+	B	B-	C+	C	C-	D+	D	D-	
13	A	A-	B+	B	B-	C+	C	C-	D+	D	D-	
14	Non-standard system using 5 or more alpha grades, no "F"											
15	Non-standard system using 5 or more alpha grades, and "F"											

II. ABCD/F with Halfstep Grades (AB, BC, etc.)									
Code	Grades Used								
Wt	4.0	3.5	3.0	2.5	2.0	1.5	1.0	0.5	0.0
16	A	AB	B	BC	C	CD	D	DF	F
17	A	AB	B	BC	C		D		F
18	A		B	C+	C		D		F
19	A	B+	B	C+	C	D+	D		F
20	A	B+	B	C+	C		D		F
21	A	B+	B	C+	C	C-	D		F
22	A+,A	B+	B	C+	C	D+	D		F
23	Other ABCDF system with halfstep grades, no "F" grade								
24	Other ABCDF system with halfstep grades and "F" grade								

**PESC XML Application for Admission Implementation Guide
Version 1.3.0**

Appendix Q – Course Academic Grade Scale Codes (Continued)

III. ABCD/F Type (4 passing letter grades)					
Code	Grades Used				
Wt	4.0	3.0	2.0	1.0	0.0
25	A	B	C	D	F
26	A	B	C	D	NC/N
27	A	B	C	D	E
28	H	S+	S	S-	U
29	E	S	M	I	F
30	DN	HP	P	HCO	NC
31	D	E	G	Q	U/F
32	H	E	G	P	U
33	S	H	P	LP	F
34	E	VG	G	P	F
35	HO	HP	PA	CR	NC
36	A	B	C	D	
37	A	B	C	D	U/R
38	Other ABCD/F type system, no "F" grade				
39	Other ABCD/F type system, with "F" grade				

IV. ABC/F Type (3 passing letter grades)				
Code	Grades Used			
Wt	4.0	3.0	2.0	0.0
40	A	B	C	F
41	H	HP	CR	NC
42	H	HP	P	F
43	A	B	C	NC
44	A	B	C	
45	H	HP	P	NP
46	HH	H	P	
47	HH	H	P	F
48	E	G	P	U/F
53	Other ABC/F type system, with no "F" grade			
54	Other ABC/F type system, with "F" grade			

**PESC XML Application for Admission Implementation Guide
Version 1.3.0**

Appendix Q – Course Academic Grade Scale Codes (Continued)

V. Graduate School Grading Systems (not normally found in Manual)					
Code	Grades Used				
Wt	4.0	3.7	3.0	2.7	0.0
49	H	HP	P	LP	U/F
50	H	HP	P		F
51	DIST	HIGH PASS	PASS	LOW PASS	F
52	H	HP	P		U

VI. Pass/Fail Type (one or two passing grades)	
Code	Grades Used
Two passing grades, each converted to an American Medical Colleges Admissions Service (AMCAS) grade of "P"; failing grade converted to "N"	
55	Pass/Fail: HP and P, F
56	Pass/Fail: H and P, F
57	Pass/Fail: HP and P, N/NC
58	Pass/Fail: H and P, U
59	Other Pass/Fail types with two passing grades
One passing grade, converted to AMCAS grade of "P"; failing grade converted to AMCAS grade of "N"	
60	Pass/Fail: P, F
61	Pass/Fail: SAT, U
62	Pass/Fail: CR, NC
63	Pass/Fail: S, U
64	Other Pass/Fail types with one passing grade

**PESC XML Application for Admission Implementation Guide
Version 1.3.0**

Appendix Q – Course Academic Grade Scale Codes (Continued)

VII. Numeric - Percent Type												
Code	Grades Used											
Wt	4.0	3.7	3.3	3.0	2.7	2.3	2.0	1.7	1.3	1.0	0.7	0.0
65	100-93	92-90	89-87	86-83	82-80	79-77	76-73	72-70	69-67	66-63	62-60	59-0
66	100-90			89-80			79-70			69-60		59-0
67	100-94	93-90		89-85			84-75			74-70		69-0
68	100-90			89-80			79-70			69-65		64-0
69	100-93			92-85			84-77			76-70		69-0
70	100-93			92-84			83-75			74-70		69-0
71	100-90			89-80		79-76	75-70			69-60		59-0
72	100-90		89-85	84-80		79-75	74-70					69-0
73	Other numeric grading system - percent type											

VIII. Numeric - Percent Type												
Code	Grades Used											
Wt	4.0	3.7	3.3	3.0	2.7	2.3	2.0	1.7	1.3	1.0	0.7	0.0
74	4.0	3.7	3.3	3.0	2.7	2.3	2.0	1.7	1.3	1.0	0.7	0.0
77	1			2			3			4		5
79	4.0			3.0			2.0			1.0		0.0
80	1+,1	1-	2+	2	2-	3+	3	3-	4+	4	4-	5/6
81	3.0			2.0			1.0					0.0
82	Other numeric grading system - 4.0 or integer type											

**PESC XML Application for Admission Implementation Guide
Version 1.3.0**

Appendix Q – Course Academic Grade Scale Codes (Continued)

IX. Numeric (4.0 type) Grading Systems using Halfstep Grades									
Code	Grades Used								
Wt	4.0	3.5	3.0	2.5	2.0	1.5	1.0	0.5	0.0
76	4.0	3.5	3.0	2.5	2.0	1.5	1.0	0.5	0.0
78	4.0	3.5	3.0	2.5	2.0		1.0		0.0
82	Other numeric grading system - 4.0 or integer type								
75	Continuous 4.0 scale (4.0 to 0.0)								

X. Numeric - Canadian Type												
Code	Grades Used											
Wt	4.0	3.7	3.3	3.0	2.7	2.3	2.0	1.7	1.3	1.0	0.7	0.0
83	9	8	7		6	5		4	3			2,1
84	10,9	8	7		6	5		4	3	2	1	0
85	100-87	86-80	79-76	75-73	72-70	69-66	65-63	62-60	59-56	55-53	52-50	49-0
86	100-84	83-75	74-72	71-69	68-66	65-64	63-62	61-60	59-56	55-53	52-50	49-0
87	100-87	86-80	79-75	74-70	69-65	64-60	59-55	54-50				49-0
88	100-87	86-80	79-75	74-70	69-65	64-62	61-59	58-55	54-52	51-48	47-45	44-0
89	Other numeric grading system – Canadian											
99	Grading Scale Unknown											

**PESC XML Application for Admission Implementation Guide
Version 1.3.0**

Appendix S: Exchange Visitor Position Codes As Used by the US SEVIS Process Sorted by Position Code	
POSITION CODE	POSITION DESCRIPTION
100	CATEGORY – GOVERNMENT
110	CENTRAL GOVERNMENT GROUP
111	HEAD OF GOVERNMENT
112	MINISTERIAL LEVEL OFFICIAL
113	EXECUTIVE LEVEL OFFICIAL
114	CIVIL SERVICE EMPLOYEE IN CENTRAL GOVERNMENT
115	PROFESSIONALS AND SCIENTISTS IN CENTRAL GOVERNMENT
116	LEGISLATOR IN CENTRAL GOVERNMENT
117	JUDGES IN CENTRAL GOVERNMENT
118	MANAGER OF STATE ENTERPRISE
119	CENTRAL GOVERNMENT, OTHER
120	REGIONAL, STATE OR PROVINCIAL GOVERNMENT GROUP
121	GOVERNOR OR OTHER CHIEF OF REGIONAL UNIT
122	SENIOR HEAD OF REGIONAL DEPT
123	EXECUTIVE LEVEL REGIONAL OFFICIALS
124	CIVIL SERVICE EMPLOYEE IN REGIONAL/STATE GOVERNMENT
125	PROFESSIONALS AND SCIENTISTS IN REGIONAL GOVERNMENT
126	LEGISLATOR IN REGIONAL OR STATE GOVERNMENT
127	JUDGES IN REGIONAL OR STATE GOVERNMENT
128	MANAGER OF REGIONAL ENTERPRISE
129	OTHER, REGIONAL GOVERNMENT
130	CITY OR TOWN GOVERNMENT GROUP
131	MAYOR OR CITY MANAGER
132	HEAD OF CITY DEPARTMENT
133	EXECUTIVE LEVEL CITY OR TOWN OFFICIALS
134	CIVIL SERVICE EMPLOYEE IN CITY OR TOWN GOVERNMENT
135	PROFESSIONALS AND SCIENTISTS IN CITY OR TOWN GOVERNMENT
136	LEGISLATOR IN CITY OR TOWN GOVERNMENT
137	JUDGES IN CITY OR TOWN GOVERNMENT
138	MANAGER OF CITY ENTERPRISE
139	OTHER, CITY OR TOWN GOVERNMENT
140	INTERNATIONAL ORGANIZATION GROUP
141	HEAD OF INTERNATIONAL ORGANIZATION GROUP
142	SENIOR OFFICIAL OF INTERNATIONAL ORGANIZATION
143	EMPLOYEE OF INTERNATIONAL ORGANIZATION
200	CATEGORY – ACADEMIC COMMUNITY
210	UNIVERSITY LEVEL GROUP
211	UNIVERSITY PRESIDENT OR RECTOR
212	UNIVERSITY ADMINISTRATIVE STAFF

**PESC XML Application for Admission Implementation Guide
Version 1.3.0**

Appendix S: Exchange Visitor Position Codes As Used by the US SEVIS Process Sorted by Position Code	
POSITION CODE	POSITION DESCRIPTION
213	UNIVERSITY TEACHING STAFF INCLUDING RESEARCHERS
214	UNIVERSITY GRADUATE STUDENTS
215	UNIVERSITY UNDERGRADUATE STUDENTS
216	UNIVERSITY MEDICAL SCHOOL STUDENTS
217	UNIVERSITY SCHOOL STUDENTS IN OTHER PROFESSIONS
218	UNIVERSITY POST GRAD MEDICAL TRAINEE
219	OTHER UNIVERSITY
220	SECONDARY SCHOOL GROUP
221	SECONDARY SCHOOL PRINCIPAL
222	SECONDARY SCHOOL TEACHER OR STAFF
223	SECONDARY SCHOOL STUDENT
229	OTHER SECONDARY SCHOOL
230	ELEMENTARY SCHOOL GROUP
231	TEACHER OR STAFF ELEMENTARY PRINCIPAL
239	OTHER ELEMENTARY SCHOOL
240	SPECIAL SCHOOLS, INSTITUTES, OR VOCATIONAL SCHOOL GROUPS
241	SPECIAL SCHOOL, INSTITUTE, OR VOCATIONAL HEAD
242	SPECIAL SCHOOL, INSTITUTE, OR VOCATIONAL TEACHER OR STAFF
249	SPECIAL SCHOOL, INSTITUTE, OR VOCATIONAL – OTHER
300	CATEGORY – PRIVATE SECTOR
310	PRIVATE BUSINESS GROUP
311	PRIVATE BUSINESS ENTREPRENEUR
312	CORPORATE EXECUTIVE
313	MANAGER EMPLOYED BY PRIVATE BUSINESS
314	EMPLOYEE OF PRIVATE BUSINESS
315	PROFESSIONAL OR SCIENTISTS IN PRIVATE BUSINESS
319	PRIVATE BUSINESS, OTHER
320	SELF-EMPLOYED PROFESSIONALS GROUP
321	SELF-EMPLOYED PROFESSIONALS (LEGAL FIELD)
322	SELF-EMPLOYED PROFESSIONALS (MEDICAL FIELD)
323	SELF-EMPLOYED PROFESSIONALS (TECHNICAL FIELD)
329	SELF-EMPLOYED PROFESSIONALS – OTHER
330	INDEPENDENT, NON-PROFIT, HOSPITALS, OR OTHER ORGANIZATION GROUPS
331	DIRECTOR OF INSTIT/CORP. OR HOSPITAL
332	MANAGER-EXEC EMPLOYED BY INST/CORP
334	EMPLOYEE OF IND.INSTIT OR CORP
335	INSTIT/CORP PROFESS.NAL/SCIEN.

**PESC XML Application for Admission Implementation Guide
Version 1.3.0**

Appendix S: Exchange Visitor Position Codes As Used by the US SEVIS Process Sorted by Position Code	
POSITION CODE	POSITION DESCRIPTION
339	INDEPENDENT, NON-PROFIT, HOSPITALS, OR SIMILAR ORGANIZATION – OTHER
340	AGRICULTURE (INCL. FORESTRY AND FISHERIES) GROUP
341	AGRICULTURAL ENTREPRENEUR
342	EXECUTIVE OF AGRICULTURAL BUSINESS
343	AGRICULTURAL MANAGER
344	EMPLOYEE OF AGRICULTURAL ENTERPRISE
345	PROFESSIONAL OR SCIENTISTS IN AGRICULTURE
349	AGRICULTURE, OTHER
350	RELIGION GROUP
351	MINISTER OF RELIGION
352	RELIGIOUS ORDER/CONGREGATION MEMBER
353	THEOLOGIAN
400	CATEGORY – THE ARTS AND SPORTS
410	THE ARTS GROUP
411	ARTIST (GRAPHIC ARTS)
412	AUTHOR (PLAYWRIGHT POET)
413	STAGE OR FILM ACTOR
414	FILM (OR STAGE) PRODUCER
415	COMPOSER OR MUSICIAN
419	ARTS OTHER
420	THE SPORTS GROUP
421	ATHLETE
422	COACH
429	SPORTS OTHER
500	CATEGORY – LABOR
510	LABOR UNION GROUP
511	LABOR UNION HEAD
512	LABOR UNION OFFICIAL
513	LABOR UNION OTHER
520	LABOR UNION MINISTRY GROUP
521	LABOR MINISTER (OR LAB.AG.HEAD)
522	SENIOR MINISTERIAL OFFICIAL
523	MINISTERIAL OR LABOR AG.EMPL.
529	MINISTRY OF LABOR OTHER
530	LABOR EXPERTS IN ACADEMIA GROUP
539	LABOR EXPERTS IN ACADEMIA OTHER
540	LABOR ORGANIZATION AND OTHER LABOR GROUPS
541	HEAD OF LABOR ORGANIZATION

**PESC XML Application for Admission Implementation Guide
Version 1.3.0**

Appendix S: Exchange Visitor Position Codes As Used by the US SEVIS Process Sorted by Position Code	
POSITION CODE	POSITION DESCRIPTION
542	EMPLOYEE OF LABOR ORGANIZATION
600	CATEGORY – COMMUNICATIONS
610	ELECTRONIC MEDIA GROUP
611	HEAD OF TV OR RADIO STATION
612	RADIO OR TV JOURNALIST
613	ELECTRONIC MEDIA TECHNICIAN
619	ELECTRONIC MEDIA OTHER
620	PRINTED MEDIA GROUP
621	EDITOR AND/OR PUBLISHER
622	JOURNALIST
623	TECHNICAL OFFICIAL IN PRINTED MEDIA FIELD
629	PRINTED MEDIA OTHER
630	FILM AS NEWS MEDIA GROUP
631	FILM MAKER
639	FILM AS NEWS MEDIA OTHER
700	CATEGORY – IMPORTANT POLITICAL FIGURES NOT CLASSIFIED ELSEWHERE
710	OPPOSITION LEADER (NOT IN GOVERNMENT)
720	OPPOSITION LEADER – LEGISLATURE GROUP
730	FORMER INFLUENTIAL POLITICAL OFFICIAL
790	IMPORTANT POLITICAL FIGURE
800	CATEGORY – MILITARY
900	CATEGORY - OTHER

**PESC XML Application for Admission Implementation Guide
Version 1.3.0**

Appendix T:

A Sample XML Instance Document for an example of an Application for Admission of a US Citizen to a Postsecondary School in the United States follows on the next page.

```

1 <?xml version="1.0" encoding="UTF-8"?>
2 <!--Sample XML file generated by XMLSpy v2011 rel. 3 sp1 (X64) (http://www.altova.com)-->
3 <AdmApp:AdmissionsApplication xsi:schemaLocation="urn:org:pecs:message:AdmissionsApplication:v1.1.0
4 AdmissionsApplication_v1.1.0.xsd" xmlns:n1="http://www.altova.com/samplexml/other-namespace"
5 xmlns:xsi="http://www.w3.org/2001/XMLSchema-instance" xmlns:AdmApp="
6 urn:org:pecs:message:AdmissionsApplication:v1.1.0">
7   <TransmissionData>
8     <DocumentID>1234567</DocumentID>
9     <CreatedDateTime>2011-06-17T09:30:47.0Z</CreatedDateTime>
10    <DocumentTypeCode>Application</DocumentTypeCode>
11    <TransmissionType>Original</TransmissionType>
12    <Source>
13      <Organization>
14        <DUNS>111222333</DUNS>
15        <OrganizationName>The Common Application</OrganizationName>
16        <Contacts>
17          <Address>
18            <AddressLine>123 Main Street</AddressLine>
19            <City>Great City</City>
20            <StateProvinceCode>NY</StateProvinceCode>
21            <PostalCode>12345</PostalCode>
22          </Address>
23          <Email>
24            <EmailAddress>Michael@CommonApp.com</EmailAddress>
25          </Email>
26          <Phone>
27            <AreaCityCode>904</AreaCityCode>
28            <PhoneNumber>5551234</PhoneNumber>
29          </Phone>
30          <URL>
31            <URLAddress>www.TheCommonApplication.com</URLAddress>
32          </URL>
33          <ContactName>Michael Moore</ContactName>
34          <ContactTitle>President</ContactTitle>
35          <OkToContact>Yes</OkToContact>
36        </Contacts>
37      </Organization>
38    </Source>
39    <Destination>
40      <Organization>
41        <FICE>002102</FICE>
42        <OrganizationName>Miami Dade College</OrganizationName>
43        <OrganizationName>Office of Admissions</OrganizationName>
44        <Contacts>
45          <Address>
46            <AddressLine>11011 SW 104 Street</AddressLine>
47            <City>Miami</City>
48            <StateProvinceCode>FL</StateProvinceCode>
49            <PostalCode>33176</PostalCode>
50            <AttentionLine>Ms. Dulce Beltran</AttentionLine>
51          </Address>
52          <Email>
53            <EmailAddress>Dulce.Beltran@mdc.edu</EmailAddress>
54          </Email>
55          <Email>
56            <EmailAddress>Harold.Harper@mdc.edu</EmailAddress>
57          </Email>
58          <Phone>
59            <AreaCityCode>305</AreaCityCode>
60            <PhoneNumber>2372222</PhoneNumber>
61          </Phone>
62          <ContactName>Dulce Beltran</ContactName>
63          <ContactTitle>College Registrar</ContactTitle>
64          <OkToContact>Yes</OkToContact>
65        </Contacts>
66      </Organization>
67    </Destination>
68    <DocumentProcessCode>TEST</DocumentProcessCode>
69    <DocumentOfficialCode>Unofficial</DocumentOfficialCode>
70    <DocumentCompleteCode>Complete</DocumentCompleteCode>
71  </TransmissionData>
72 </Applicant>

```

PESC XML Application for Admission Implementation Guide Version 1.3.0

```
73      <Person>
74          <SSN>123123123</SSN>
75          <Birth>
76              <BirthDate>1967-08-13</BirthDate>
77              <BirthCity>La Habana</BirthCity>
78              <BirthCountry>CU</BirthCountry>
79          </Birth>
80          <Name>
81              <NameCode>Legal</NameCode>
82              <FirstName>John</FirstName>
83              <MiddleName>T</MiddleName>
84              <LastName>Student</LastName>
85              <NameSuffix>JR</NameSuffix>
86          </Name>
87          <AlternateName>
88              <NameCode>Casual</NameCode>
89              <FirstName>Jon</FirstName>
90              <LastName>Stewart</LastName>
91          </AlternateName>
92          <PreferredName>
93              <NameCode>Casual</NameCode>
94              <FirstName>Tom</FirstName>
95          </PreferredName>
96          <Citizenship>
97              <CitizenshipStatusCode>Citizen</CitizenshipStatusCode>
98              <CitizenshipCountryCode>US</CitizenshipCountryCode>
99          </Citizenship>
100         <Contacts>
101             <PermanentAddress>
102                 <AddressLine>3835 Kumquat Avenue</AddressLine>
103                 <City>Miami</City>
104                 <StateProvinceCode>FL</StateProvinceCode>
105                 <PostalCode>33133</PostalCode>
106             </PermanentAddress>
107             <MailingAddress>
108                 <AddressLine>3835 Kumquat Avenue</AddressLine>
109                 <City>Miami</City>
110                 <StateProvinceCode>FL</StateProvinceCode>
111                 <PostalCode>33133</PostalCode>
112             </MailingAddress>
113             <CurrentAddress>
114                 <AddressLine>3835 Kumquat Avenue</AddressLine>
115                 <City>Miami</City>
116                 <StateProvinceCode>FL</StateProvinceCode>
117                 <PostalCode>33133</PostalCode>
118             </CurrentAddress>
119             <PermanentPhone>
120                 <AreaCityCode>305</AreaCityCode>
121                 <PhoneNumber>4431388</PhoneNumber>
122             </PermanentPhone>
123             <DayPhone>
124                 <AreaCityCode>305</AreaCityCode>
125                 <PhoneNumber>4431388</PhoneNumber>
126             </DayPhone>
127             <EveningPhone>
128                 <AreaCityCode>305</AreaCityCode>
129                 <PhoneNumber>9623014</PhoneNumber>
130             </EveningPhone>
131             <MobilePhone>
132                 <AreaCityCode>305</AreaCityCode>
133                 <PhoneNumber>9623014</PhoneNumber>
134             </MobilePhone>
135             <PrimaryEmail>
136                 <EmailAddress>stewartj@aol.com</EmailAddress>
137             </PrimaryEmail>
138             <ContactPreferenceCode>Email</ContactPreferenceCode>
139         </Contacts>
140         <Gender>
141             <GenderCode>Male</GenderCode>
142         </Gender>
143         <EthnicityRace>
```

PESC XML Application for Admission Implementation Guide

Version 1.3.0

```

144         <EthnicityCode>NonHispanic</EthnicityCode>
145         <RaceCode>White</RaceCode>
146         <RaceCode>AmericanIndianAlaskaNative</RaceCode>
147         <LocalEthnicityRaceCode>Seminole</LocalEthnicityRaceCode>
148     </EthnicityRace>
149     <PrivacyRestriction>
150         <PrivacyRestrictionDate>2008-08-13</PrivacyRestrictionDate>
151         <PrivacyRestrictionLevel>00</PrivacyRestrictionLevel>
152     </PrivacyRestriction>
153     <Employment>
154         <Employer>
155             <OrganizationName>ATT</OrganizationName>
156             <Contacts>
157                 <Address>
158                     <AddressLine>11011 SW 104 Street</AddressLine>
159                     <City>Miami</City>
160                     <StateProvinceCode>FL</StateProvinceCode>
161                     <PostalCode>33176</PostalCode>
162                     <EffectiveDate>2008-08-13</EffectiveDate>
163                     <ExpirationDate>2010-08-13</ExpirationDate>
164                 </Address>
165                 <Phone>
166                     <AreaCityCode>305</AreaCityCode>
167                     <PhoneNumber>5553258</PhoneNumber>
168                 </Phone>
169                 <ContactName>Mr. Jason Alexander</ContactName>
170                 <ContactTitle>Department Manager</ContactTitle>
171                 <OkToContact>Yes</OkToContact>
172             </Contacts>
173         </Employer>
174         <EmploymentBeginYearMonth>2006-08</EmploymentBeginYearMonth>
175         <EmploymentEndYearMonth>2008-08</EmploymentEndYearMonth>
176         <PositionTitle>Installer</PositionTitle>
177         <EmploymentStatusCode>FullTime</EmploymentStatusCode>
178         <EmploymentWeeklyHours>40</EmploymentWeeklyHours>
179         <JobDescription>Installation of new telephone and internet access lines.</JobDescription>
180     </Employment>
181     <Employment>
182         <Employer>
183             <OrganizationName>Comcast Cable</OrganizationName>
184             <Contacts>
185                 <Address>
186                     <AddressLine>9806 SW 100 Avenue</AddressLine>
187                     <City>Miami</City>
188                     <StateProvinceCode>FL</StateProvinceCode>
189                     <PostalCode>33157</PostalCode>
190                     <EffectiveDate>1986-08-13</EffectiveDate>
191                     <ExpirationDate>2006-07-01</ExpirationDate>
192                 </Address>
193                 <ContactName>Mr. José González</ContactName>
194                 <ContactTitle>Supervisor</ContactTitle>
195                 <OkToContact>Yes</OkToContact>
196             </Contacts>
197         </Employer>
198         <EmploymentBeginYearMonth>1986-08</EmploymentBeginYearMonth>
199         <EmploymentEndYearMonth>2006-07</EmploymentEndYearMonth>
200         <PositionTitle>Cable Installer</PositionTitle>
201         <EmploymentStatusCode>FullTime</EmploymentStatusCode>
202         <EmploymentWeeklyHours>40</EmploymentWeeklyHours>
203         <JobDescription>Installation and repair of TV cable lines for customers.</JobDescription>
204     </Employment>
205     <FirstSpokenLanguageCode>SPA</FirstSpokenLanguageCode>
206     <Language>
207         <LanguageCode>SPA</LanguageCode>
208         <LanguageProficiency>Excellent</LanguageProficiency>
209         <LanguageUsage>FirstSpokenLanguage</LanguageUsage>
210     </Language>
211     <MaritalStatusCode>Single</MaritalStatusCode>
212 </Person>
213 <Family>
214     <ParentsMaritalStatusCode>Married</ParentsMaritalStatusCode>

```

PESC XML Application for Admission Implementation Guide

Version 1.3.0

```

215     <FamilyMember>
216         <RelationshipCode>Mother</RelationshipCode>
217         <DesignateCode>EmergencyContact</DesignateCode>
218         <DesignateCode>AuthorizedDesignate</DesignateCode>
219         <Birth>
220             <BirthDate>1947-09-01</BirthDate>
221             <BirthCity>Habana</BirthCity>
222             <BirthCountry>CU</BirthCountry>
223         </Birth>
224         <Name>
225             <NameCode>Legal</NameCode>
226             <FirstName>Maria</FirstName>
227             <LastName>Student</LastName>
228         </Name>
229         <Contacts>
230             <Address>
231                 <AddressLine>3960 Main Street</AddressLine>
232                 <City>Miami</City>
233                 <StateProvinceCode>FL</StateProvinceCode>
234                 <PostalCode>33133</PostalCode>
235             </Address>
236             <Email>
237                 <EmailAddress>LadyMaria@aol.com</EmailAddress>
238             </Email>
239             <Phone>
240                 <AreaCityCode>305</AreaCityCode>
241                 <PhoneNumber>5555555</PhoneNumber>
242             </Phone>
243             <OkToContact>Yes</OkToContact>
244         </Contacts>
245         <Gender>
246             <GenderCode>Female</GenderCode>
247         </Gender>
248         <Marital>
249             <MaritalStatusCode>Married</MaritalStatusCode>
250         </Marital>
251         <EthnicityRace>
252             <EthnicityCode>Hispanic</EthnicityCode>
253             <RaceCode>White</RaceCode>
254             <RaceCode>BlackAfricanAmerican</RaceCode>
255         </EthnicityRace>
256         <Citizenship>
257             <CitizenshipStatusCode>Citizen</CitizenshipStatusCode>
258             <CitizenshipCountryCode>US</CitizenshipCountryCode>
259         </Citizenship>
260         <EducationLevel>CollegeAttended</EducationLevel>
261         <OccupationDetail>
262             <Occupation>Housewife</Occupation>
263         </OccupationDetail>
264     </FamilyMember>
265     <FamilyMember>
266         <RelationshipCode>Father</RelationshipCode>
267         <DesignateCode>EmergencyContact</DesignateCode>
268         <DesignateCode>AuthorizedDesignate</DesignateCode>
269         <Birth>
270             <BirthDate>1940-10-03</BirthDate>
271             <BirthCountry>CU</BirthCountry>
272         </Birth>
273         <Name>
274             <NameCode>Legal</NameCode>
275             <FirstName>John</FirstName>
276             <MiddleName>T</MiddleName>
277             <LastName>Student</LastName>
278             <NameSuffix>SR</NameSuffix>
279         </Name>
280         <Contacts>
281             <Address>
282                 <AddressLine>3960 Main Street</AddressLine>
283                 <City>Miami</City>
284                 <StateProvinceCode>FL</StateProvinceCode>
285                 <PostalCode>33133</PostalCode>

```

PESC XML Application for Admission Implementation Guide

Version 1.3.0

```

286         </Address>
287         <Email>
288             <EmailAddress>BigDaddy@mdc.edu</EmailAddress>
289         </Email>
290         <Phone>
291             <AreaCityCode>305</AreaCityCode>
292             <PhoneNumber>5555555</PhoneNumber>
293             <NoteMessage>Home Phone</NoteMessage>
294         </Phone>
295         <Phone>
296             <AreaCityCode>305</AreaCityCode>
297             <PhoneNumber>2371234</PhoneNumber>
298             <NoteMessage>Work Phone</NoteMessage>
299         </Phone>
300         <OkToContact>Yes</OkToContact>
301     </Contacts>
302     <Gender>
303         <GenderCode>Male</GenderCode>
304     </Gender>
305     <Marital>
306         <MaritalStatusCode>Married</MaritalStatusCode>
307     </Marital>
308     <EthnicityRace>
309         <EthnicityCode>Hispanic</EthnicityCode>
310         <RaceCode>White</RaceCode>
311     </EthnicityRace>
312     <Citizenship>
313         <CitizenshipStatusCode>Citizen</CitizenshipStatusCode>
314         <CitizenshipCountryCode>US</CitizenshipCountryCode>
315     </Citizenship>
316     <EducationLevel>MastersDegree</EducationLevel>
317     <OccupationDetail>
318         <Occupation>Professor of English</Occupation>
319         <Employer>
320             <OrganizationName>Florida International University</OrganizationName>
321             <Contacts>
322                 <URL>
323                     <URLAddress>www.fiu.edu</URLAddress>
324                 </URL>
325             </Contacts>
326         </Employer>
327     </OccupationDetail>
328     <Legacy>
329         <SchoolBeganYear>1958</SchoolBeganYear>
330         <SchoolEndedYear>1964</SchoolEndedYear>
331         <SchoolName>University of Florida</SchoolName>
332         <AcademicAwardTitle>Masters in Fine Arts</AcademicAwardTitle>
333     </Legacy>
334 </FamilyMember>
335 <FamilyLegacy>
336     <LegacyGraduateCode>Sibling</LegacyGraduateCode>
337 </FamilyLegacy>
338 <FamilyIncome>
339     <FamilyIncomeAmount>70000</FamilyIncomeAmount>
340 </FamilyIncome>
341 <FamilyDependents>0</FamilyDependents>
342 </Family>
343 <Residency>
344     <ResidentName>
345         <NameCode>Legal</NameCode>
346         <FirstName>John</FirstName>
347         <MiddleName>T</MiddleName>
348         <LastName>Student</LastName>
349         <NameSuffix>JR</NameSuffix>
350     </ResidentName>
351     <RelationshipCode>Self</RelationshipCode>
352     <FinancialDependency>
353         <DependencyStatusCode>Independent</DependencyStatusCode>
354         <FinancialDependencyDate>1997-01-01</FinancialDependencyDate>
355     </FinancialDependency>
356     <StateProvinceCode>FL</StateProvinceCode>

```

PESC XML Application for Admission Implementation Guide

Version 1.3.0

```

357     <City>Miami</City>
358     <ResidencyEstablishedDate>1997-01-01</ResidencyEstablishedDate>
359     <ResidencyStatusCode>Resident</ResidencyStatusCode>
360     <DriversLicense>
361         <StateProvinceCode>FL</StateProvinceCode>
362         <DriversLicenseNumber>S363-874-67-504-0</DriversLicenseNumber>
363         <FirstIssueDate>1985-08-13</FirstIssueDate>
364         <LastIssueDate>2008-08-13</LastIssueDate>
365     </DriversLicense>
366     <VoterRegistration>
367         <StateProvinceCode>FL</StateProvinceCode>
368         <VoterRegistrationDistrict>586</VoterRegistrationDistrict>
369         <City>Miami</City>
370         <VoterRegistrationNumber>108927496</VoterRegistrationNumber>
371         <FirstIssueDate>1989-08-13</FirstIssueDate>
372         <LastIssueDate>2006-08-13</LastIssueDate>
373     </VoterRegistration>
374     <VehicleRegistration>
375         <StateProvinceCode>FL</StateProvinceCode>
376         <OwnerName>John T Student</OwnerName>
377         <VehicleRegistrationNumber>V634JC</VehicleRegistrationNumber>
378         <FirstIssueDate>2005-08-13</FirstIssueDate>
379         <LastIssueDate>2008-07-13</LastIssueDate>
380     </VehicleRegistration>
381     <EmploymentResidency>
382         <FullTimeFlag>true</FullTimeFlag>
383         <EmploymentBeginDate>2006-08-13</EmploymentBeginDate>
384         <EmploymentEndDate>2008-08-13</EmploymentEndDate>
385         <EmployerName>ATT</EmployerName>
386         <EmploymentLocation>Miami, FL</EmploymentLocation>
387     </EmploymentResidency>
388     <IncomeTaxInformation>
389         <IncomeTaxState>FL</IncomeTaxState>
390         <IncomeTaxYear>2007</IncomeTaxYear>
391     </IncomeTaxInformation>
392     <PropertyOwned>
393         <PropertyPurchaseDate>1995-08-13</PropertyPurchaseDate>
394         <PropertyState>FL</PropertyState>
395         <PropertyCounty>Miami-Dade</PropertyCounty>
396         <HomesteadExemptionClaimedCode>Yes</HomesteadExemptionClaimedCode>
397     </PropertyOwned>
398     <LastResidence>Florida</LastResidence>
399 </Residency>
400
401 <Application>
402     <ApplicationDetail>
403         <ApplicationSession>
404             <SessionDesignator>2009-08</SessionDesignator>
405             <SessionName>Fall Term 2009</SessionName>
406             <SessionType>Semester</SessionType>
407             <SessionBeginDate>2009-08-25</SessionBeginDate>
408         </ApplicationSession>
409         <ApplicationDegreeProgram>
410             <ProgramLocalCode>BS-CHEM-ENG</ProgramLocalCode>
411             <PlannedEnrollmentStatus>FullTime</PlannedEnrollmentStatus>
412         </ApplicationDegreeProgram>
413     <AcademicProgramDegreeLevel>BaccalaureateDegree</AcademicProgramDegreeLevel>
414     <AcademicProgramPriority>1</AcademicProgramPriority>
415     <ApplicationQuestion>
416         <QuestionTitle>Previous Experience in Program</QuestionTitle>
417         <QuestionID>PrevExp0001</QuestionID>
418         <QuestionAreaCode>Employment</QuestionAreaCode>
419         <QuestionRequiredCode>Optional</QuestionRequiredCode>
420         <QuestionFormatCode>TextArea</QuestionFormatCode>
421         <QuestionText>Do you have any work or other experience in the field for which
422 you are applying. Please explain. </QuestionText>
423         <AnswerText>Yes, I worked part time for several summers after high school in
424 the field.
425         </AnswerText>
426     </ApplicationQuestion>
427 </AcademicProgramDetail>

```

PESC XML Application for Admission Implementation Guide

Version 1.3.0

```

428                                     <AcademicProgramType>Major</AcademicProgramType>
429                                     <AcademicProgramName>Bachelor of Science in Chemical
Engineering</AcademicProgramName>
431                                     <AcademicProgramPriority>1</AcademicProgramPriority>
432                                     </AcademicProgramDetail>
433                                 </ApplicationDegreeProgram>
434                                 <ApplicationPriority>1</ApplicationPriority>
435                             </ApplicationDetail>
436                             <RecommendationReference>
437                                 <RefereeName>
438                                     <NameCode>Legal</NameCode>
439                                     <FirstName>Carlos</FirstName>
440                                     <LastName>Alvarez</LastName>
441                                 </RefereeName>
442                                 <RefereeContacts>
443                                     <Address>
444                                         <AddressLine>100 West Flagler Street</AddressLine>
445                                         <City>Miami</City>
446                                         <StateProvinceCode>FL</StateProvinceCode>
447                                         <PostalCode>33101</PostalCode>
448                                     </Address>
449                                     <Email>
450                                         <EmailAddress>Carlos.Alvarez@MiamiCounty.gov</EmailAddress>
451                                     </Email>
452                                     <URL>
453                                         <URLAddress>www.miamicounty.gov</URLAddress>
454                                     </URL>
455                                     <ContactTitle>Mayor, Miami-Dade County</ContactTitle>
456                                     <OkToContact>Yes</OkToContact>
457                                 </RefereeContacts>
458                                 <RefereeOrganization>
459                                     <OrganizationName>Miami-Dade County</OrganizationName>
460                                 </RefereeOrganization>
461                                 <RefereePositionInOrganization>Mayor</RefereePositionInOrganization>
462                             </RecommendationReference>
463                             <ApplicationQuestion>
464                                 <QuestionTitle>Residency FL Prepaid</QuestionTitle>
465                                 <QuestionID>Residency034</QuestionID>
466                                 <QuestionAreaCode>Residency</QuestionAreaCode>
467                                 <QuestionRequiredCode>Optional</QuestionRequiredCode>
468                                 <QuestionFormatCode>CheckBox</QuestionFormatCode>
469                                 <QuestionText>Are you a qualified beneficiary under the terms of the Florida Prepaid College
Program (Section 240.551, Florida Statutes) and not otherwise eligible? </QuestionText>
471                                 <AllowedAnswers>
472                                     <AllowedAnswerText>Yes</AllowedAnswerText>
473                                     <AnswerSelectedCode>Selected</AnswerSelectedCode>
474                                 </AllowedAnswers>
475                                 <AllowedAnswers>
476                                     <AllowedAnswerText>No</AllowedAnswerText>
477                                     <AnswerSelectedCode>NotSelected</AnswerSelectedCode>
478                                 </AllowedAnswers>
479                             </ApplicationQuestion>
480                             <AdditionalStudentAchievements>
481                                 <Language>
482                                     <LanguageCode>SPA</LanguageCode>
483                                     <LanguageProficiency>Excellent</LanguageProficiency>
484                                     <LanguageUsage>SpokenAtHome</LanguageUsage>
485                                 </Language>
486                                 <Language>
487                                     <LanguageCode>FRE</LanguageCode>
488                                     <LanguageProficiency>Excellent</LanguageProficiency>
489                                     <LanguageUsage>Speaking</LanguageUsage>
490                                 </Language>
491                             </AdditionalStudentAchievements>
492                             <ApplicationProcessingGroupCode>FirstTimeStudent</ApplicationProcessingGroupCode>
493                             <StudentReleaseCode>AllValuesIncluded</StudentReleaseCode>
494                             <PlanToApplyFor>
495                                 <PlanToApplyForCode>CampusEmployment</PlanToApplyForCode>
496                                 <PlanToApplyForCode>FinancialAid</PlanToApplyForCode>
497                                 <PlanToApplyForCode>Housing</PlanToApplyForCode>
498                             </PlanToApplyFor>

```

PESC XML Application for Admission Implementation Guide

Version 1.3.0

```

499         <DecisionToApply>
500             <ApplyDecision>
501                 <DecisionToApplyCode>Alumni</DecisionToApplyCode>
502                 <DecisionRank>1</DecisionRank>
503             </ApplyDecision>
504             <ApplyDecision>
505                 <DecisionToApplyCode>InstitutionReputation</DecisionToApplyCode>
506                 <DecisionRank>2</DecisionRank>
507             </ApplyDecision>
508         </DecisionToApply>
509     <HousingInformation>
510         <HousingInformationCode>Family</HousingInformationCode>
511         <HousingInformationCode>OnCampus</HousingInformationCode>
512     </HousingInformation>
513     <InformationRequested>
514         <InterestedInCode>HonorsProgram</InterestedInCode>
515     </InformationRequested>
516     <ApplicationFee>
517         <ApplicationFeeAmount>25</ApplicationFeeAmount>
518         <PaymentMethodCode>Cash</PaymentMethodCode>
519     </ApplicationFee>
520 </Application>
521 <GovernmentMilitary>
522     <MilitaryRelationshipStatusCode>Veteran</MilitaryRelationshipStatusCode>
523 </GovernmentMilitary>
524 <SelfReportedAcademicRecord>
525     <School>
526         <OrganizationName>Miami Palmetto Senior High School</OrganizationName>
527         <CEEBACT>100262</CEEBACT>
528     </School>
529     <FirstDateAttended>1981-08-13</FirstDateAttended>
530     <LastDateAttended>1985-06-13</LastDateAttended>
531     <StudentLevel>
532         <StudentLevelCode>TwelfthGrade</StudentLevelCode>
533     </StudentLevel>
534     <AcademicAward>
535         <AcademicAwardLevel>B18</AcademicAwardLevel>
536         <AcademicAwardDate>1985-06-13</AcademicAwardDate>
537         <AcademicAwardTitle>Standard High School Diploma</AcademicAwardTitle>
538         <AcademicHonors>
539             <HonorsTitle>With Highest Honors</HonorsTitle>
540             <HonorsLevel>FirstHighest</HonorsLevel>
541         </AcademicHonors>
542         <AcademicCompletionIndicator>true</AcademicCompletionIndicator>
543         <AcademicCompletionDate>1985-05-10</AcademicCompletionDate>
544     </AcademicAward>
545     <AdditionalStudentAchievements>
546         <OtherStudentAchievement>
547             <AchievementCategoryCode>Academic</AchievementCategoryCode>
548             <AchievementTitle>Principal's Award for Outstanding Achievement</AchievementTitle>
549             <StudentLevelCode>EleventhGrade</StudentLevelCode>
550             <AchievementAwardYear>1985</AchievementAwardYear>
551         </OtherStudentAchievement>
552     </AdditionalStudentAchievements>
553     <HighSchoolSubjectArea>
554         <HighSchoolSubjectAreaCode>English</HighSchoolSubjectAreaCode>
555         <CourseCreditValue>4</CourseCreditValue>
556     </HighSchoolSubjectArea>
557     <HighSchoolSubjectArea>
558         <HighSchoolSubjectAreaCode>ForeignLanguage</HighSchoolSubjectAreaCode>
559         <CourseCreditValue>3</CourseCreditValue>
560     </HighSchoolSubjectArea>
561     <HighSchoolSubjectArea>
562         <HighSchoolSubjectAreaCode>Math</HighSchoolSubjectAreaCode>
563         <CourseCreditValue>4</CourseCreditValue>
564     </HighSchoolSubjectArea>
565     <HighSchoolSubjectArea>
566         <HighSchoolSubjectAreaCode>LabScience</HighSchoolSubjectAreaCode>
567         <CourseCreditValue>2</CourseCreditValue>
568     </HighSchoolSubjectArea>
569 </HighSchoolSubjectArea>

```

PESC XML Application for Admission Implementation Guide

Version 1.3.0

```

570         <HighSchoolSubjectAreaCode>Science</HighSchoolSubjectAreaCode>
571         <CourseCreditValue>4</CourseCreditValue>
572     </HighSchoolSubjectArea>
573 </HighSchoolSubjectArea>
574         <HighSchoolSubjectAreaCode>HistorySocialScience</HighSchoolSubjectAreaCode>
575         <CourseCreditValue>3</CourseCreditValue>
576     </HighSchoolSubjectArea>
577 </HighSchoolSubjectArea>
578         <HighSchoolSubjectAreaCode>Arts</HighSchoolSubjectAreaCode>
579         <CourseCreditValue>4</CourseCreditValue>
580     </HighSchoolSubjectArea>
581 <ClassRank>
582         <ClassSize>324</ClassSize>
583         <ClassRank>3</ClassRank>
584     </ClassRank>
585 <CollegeCreditEarnedBeforeHighSchoolGraduationCode>AdvancedPlacement</CollegeCreditEarnedBeforeHighSchoolGraduati
586 onCode>
587 <CollegeCreditEarnedBeforeHighSchoolGraduationCode>CLEP</CollegeCreditEarnedBeforeHighSchoolGraduationCode>
588 </SelfReportedAcademicRecord>
589 <SelfReportedTests>
590     <EducationTestCode>ACT</EducationTestCode>
591     <TestName>The ACT</TestName>
592     <TestDate>2008-04-27</TestDate>
593     <StudentLevel>
594         <StudentLevelCode>TwelfthGrade</StudentLevelCode>
595     </StudentLevel>
596     <EducationSubtest>
597         <EducationSubtestCode>English</EducationSubtestCode>
598         <ScoreValue>17</ScoreValue>
599     </EducationSubtest>
600     <EducationSubtest>
601         <EducationSubtestCode>Math</EducationSubtestCode>
602         <ScoreValue>15</ScoreValue>
603     </EducationSubtest>
604     <EducationSubtest>
605         <EducationSubtestCode>Reading</EducationSubtestCode>
606         <ScoreValue>16</ScoreValue>
607     </EducationSubtest>
608     <EducationSubtest>
609         <EducationSubtestCode>CompositeScore</EducationSubtestCode>
610         <ScoreValue>18</ScoreValue>
611     </EducationSubtest>
612 </SelfReportedTests>
613 <ExtraCurricularActivity>
614     <ActivityCode>AcademicHonorSociety</ActivityCode>
615     <GradeLevel>Grade12</GradeLevel>
616     <YearMonthBegin>1984-08</YearMonthBegin>
617     <YearMonthEnd>1985-06</YearMonthEnd>
618     <Years>1</Years>
619     <WeeklyHours>5</WeeklyHours>
620     <YearlyWeeks>30</YearlyWeeks>
621     <ActivityScopeCode>National</ActivityScopeCode>
622     <LeadershipPosition>President</LeadershipPosition>
623     <LeadershipCharacteristicCode>Elected</LeadershipCharacteristicCode>
624 </ExtraCurricularActivity>
625 <ExtraCurricularActivity>
626     <ActivityCode>Band</ActivityCode>
627     <ActivityDescription>First String Trombone</ActivityDescription>
628     <GradeLevel>Grade12</GradeLevel>
629     <YearMonthBegin>1981-08</YearMonthBegin>
630     <YearMonthEnd>1985-06</YearMonthEnd>
631     <Years>4</Years>
632     <WeeklyHours>15</WeeklyHours>
633     <YearlyWeeks>32</YearlyWeeks>
634     <Recognitions>Won State Competition</Recognitions>
635     <ActivityScopeCode>Regional</ActivityScopeCode>
636 </ExtraCurricularActivity>
637 </Applicant>
638 </AdmApp:AdmissionsApplication>

```

Appendix U

Changes Made to the PESC XML Admissions Application Schema Since Version 1.0.0

Version 1.0.0

The first version of the XML Admissions Application Schema used Version 1.XX.0 of the Core Main Schema and Version 1.XX.0 of the Admissions Record Sector Library Schema.

Version 1.1.0

Version 1.1.0 of the PESC XML Admissions Application Schema uses Version 1.10.0 of the Core Main Schema and Version 1.1.0 of the Admissions Record Sector Library Schema.

The following changes are included in this version:

1. Added a new code set (PSS) for private secondary schools in the US to the OrganizationIDGroup to allow reference to be made to private secondary schools.
2. Added a new simple data element ("PartialSSN") as child to "Person" to allow the inclusion of the last four digits of the Social Security Number for those schools that prefer not to include the entire 9 digit number.
3. Added an iteration of the complex data element "Language" as child to "Person" to allow an applicant to specify which language they would prefer for future communications between the school and the applicant.
4. Added new enumerated values to the simple data elements "LanguageProficiency" and "LanguageUsage".
5. Changed the maximum length of the simple data element "AcademicAwardTitle" from 80 to 400 to allow for longer titles of degrees awarded.
6. Added the complex data element "Sponsor" as child to "Application" to allow for non-international applicants to have sponsors.

PESC XML Application for Admission Implementation Guide Draft

7. Added a new code set “ProgramSecondarySchoolCode” to the “AcademicProgramCodeGroup” to allow applicants an option to specify what their award objective was in a secondary school.
8. Added two new optional simple data elements (“CreditHoursRequired” and “CreditHoursDeficient”) as child to the complex data element “GPA” for use in other schemas. We see no need for them in the Admissions Application.
9. Added a new enumerated value “Correspondence” for the simple data element “CourseCreditBasis” which is child to “Course”.
10. Added a new enumerated value of “Regents” to the simple data element “CourseLevel” which is child to the complex data element “Course”. This was requested by the State University System of New York.
11. Added “UDE” as child to the complex data element “SelfReportedTests”. This was not a change to the schema, but a simple correction to its omission in the first Implementation Guide.

Version 1.3.0

Version 1.3.0 of the PESC XML Admissions Application Schema uses Version 1.14.0 of the Core Main Schema and Version 1.3.0 of the Admissions Record Sector Library Schema.

The following changes are included in this version:

Version 1.1.0

Version 1.1.0 of the PESC XML Admissions Application Schema uses Version 1.10.0 of the Core Main Schema and Version 1.1.0 of the Admissions Record Sector Library Schema.

The following changes are included in this version:

New Element requests:

1. Applicant.Application

(1) ApplicationID - Optional element, alphanumeric, with length 1-35.

(2) ApplicationSource - Optional element with enumerated values of 'Applicant' and 'Institution'

PESC XML Application for Admission Implementation Guide **Draft**

2. Add a 'PreferredPhone' to Applicant.Person.Contacts, listed after Applicant.Person.Contacts.OtherPhone. Enumerations will match existing Phone segments, e.g., PermanentPhone, CampusPhone, BusinessPhone. This is an optional element.

New enumerations:

1. TransmissionData.Source.Organization:

OrganizationIDGroup: Add enumerated value of "APAS" (Alberta Post-secondary Application System)

Note: User requested this be added in all schemas, rather than just the Admissions Application.

2. Applicant.SelfReportedAcademicRecord.AcademicAward:

AcademicAwardLevel: (1)Add enumerated value of "B58" to specify 'International Baccalaureate Examination'

(2)Add enumerated value of "B59" to specify "GCE -- General Certificate of Education"

(3)Add enumerated value of "B60" to specify "Honorary High School Diploma"

3. Applicant.SelfReportedAcademicRecord.StudentLevel:

StudentLevelCode: Add these enumerated values:

(1) "NoFormalSchool" can it be added to the beginning of the list prior to Infant?

4. Applicant.SelfReportedAcademicRecord.AcademicSession.Course:

CourseAcademicGradeStatusCode: Add these enumerated values:

(1) "Completed"

(2) "PlanningToTake"

PESC XML Application for Admission Implementation Guide **Draft**

Appendix V

Participants in the Development of the PESC XML Application for Admission Schema

Last Name	First Name	Title	School/Company/Association
Archer	Christie	End User Analyst	University of Lethbridge (Alberta, CA)
Baldwin	Mary Jane		Texas A&M University
Bezjia	Vic	Executive Director, International Center	Azusa Pacific University (CA)
Borgione	Lawrence	Product Manager, Oracle Campus Solutions Product Strategy	Oracle Corporation
Brower	Paula	Banner Student Product Manager	SunGard Higher Education
Burnette, III	Richard R. "Rick"	Director of Student Information Management	Florida State University
Castro	Connie		Texas A&M University
Chun	Nikki	eManager, Division of Enrollment Management	University of Miami (FL)
Costa	Gus	Chief Technology Officer	Apply Yourself Recruiting Solutions
Dueck	Randy	Programmer/Analyst	University of Lethbridge (Alberta, CA)
Dunkleman	Joshua		Applications On-Line
Durr	Mary Therese	Director of Enrollment Systems	Bentley College (MA)
Farella	Adriana	Associate Vice President for Enrollment Services and University Registrar	The Catholic University of America 1
Farmer	Larry L.	Lead Software Applications Developer	Texas A&M University
Fleming	J		George Fox University (OR)
Grams	Mary	Director, International Student Services	Azusa Pacific University (CA)
Greene	Robin S.	Associate Director, Technology & Internet Services, and Member of AACRAO SPEEDE Committee	The College Foundation of North Carolina
Gunadi	Anita	International Student Advisor, Office of International Student Services	Azusa Pacific University (CA)
Guth	Philip	VP for Enrollment Services	Judson College (IL) 3
Hammond	Laura	Senior Administrative Coordinator, Office of Graduate and International Admissions	Texas A&M University
Haney	Peter	Assistant Registrar, Admissions and Transfer	University of Lethbridge (Alberta, CA)
Harris	Kay	Principal Product Manager	Oracle Corporation
Hockett	Margy		SunGard Higher Education
Hudachek	George	Associate Director of Admissions	U of Minnesota-Twin Cities
Hurley	Gerry		College Summit
Jacobs	Robert W.	Consultant (in Alberta, Canada)	Online Business Systems
Kaushik	Rajiv	Information Technology for the Kualu Student Project	Massachusetts Institute of Technology 4
Kazzaz	Daniel	Chair, ANSI ASC X12	Rapid Data Interchange
Kennedy	Dan		Carnegie Mellon University (PA)
Killion	Robert	Executive Director	The Common Application, Inc.
King	Robert		CitiBank
Korte	Jeff	Project Manger for Admissions	Jenzabar
Landgraf	Aaron	Assistant Director of Technology and Business	Applications On-Line

PESC XML Application for Admission Implementation Guide **Draft**

Appendix V

Participants in the Development of the PESC XML Application for Admission Schema

Last Name	First Name	Title	School/Company/Association
Layton	Robert	President	KEL Group, Inc.
Martin	Morgan	SIS Programmer Analyst	University of Lethbridge (Alberta, CA)
Matthews	Michael	Product Manager, Recruitment	The College Board
McGoldrick	J. Joseph	Development Mgr/Mgmt App Processing	State University of New York
McGregor	Chad	Consultant (in Alberta, Canada)	Online Business Systems
McIntyre	Dianna	Assistant Director of International Student Services	George Fox University (OR)
McNair	Sam		The College Board
Mlynarski	Angela	User Support Analyst	University of Lethbridge (Alberta, CA)
Morin	Duane	Services Architect	ConnectEdu
Nasr	Tim	Manager of Client Services	Xap Corporation
Rea	Scott		Dartmouth College (NH)
Rich	Cheryl L.	Associate Director, Admissions Processing, Office of Admissions and Records	Texas A&M University
Rissler	Jean	Senior Application Architect	Jenzabar
Roueché-Herdman	Catherine	Assistant Director of Admissions	Texas A&M University
Sandul	Debi	Associate Registrar	University of Lethbridge (Alberta, CA)
Schaefermeyer	Mark J.	Director, Recruitment & Admissions, Grad School	Virginia Commonwealth University
Schwanz	Jason A.	Director of Systems/Operations for Admissions	George Fox University (OR)
Sessa	Michael	Executive Director	PESC
Shalla	Kevin	Associate Director of Information & Technical Services; Office of Admissions and Records	University of Illinois at Chicago
Skeel	Rick	Director of Student Records, and Member of AACRAO SPEEDE Committee	University of Oklahoma
Slavin	Jim	Director, Admissions & Enrollment Software Services	The College Board
Smith-Larson	Clare	Coordinator, Project EASIER and Member of AACRAO SPEEDE Committee	Iowa State University
Snowden	Monique	Assistant Dean of Enrollment Management, School of Continuing Studies, and Chair of AACRAO SPEEDE Committee	Northwestern University
Stewart	John T. "Tom"	College Registrar (Retired) and Member of AACRAO SPEEDE Committee	Miami Dade College (FL)
Tiss	David	Director of Product Development	AY Recruiting Solutions
Van Neste	Karl	Application Architect	The College Board
Wagoner	Jessica	Director of Client Services	Xap Corporation
Walker	Michelle	Assistant Director of Admissions	Texas A&M University
Wofford	Douglas	President and CEO	Admissions Lab of 422 Group
Wysoski	Mark	Product Manager	SunGard Bi-Tech
Zimmer	Bill	Advisory Consultant	SunGard Higher Education ²

¹ Adriana Farella was at Xap Corporation when the Workgroup began meeting. She then moved to a position at The College Board prior to her current position at The Catholic University of America.

² Bill Zimmer is now at Rider University in New Jersey.

PESC XML Application for Admission Implementation Guide **Draft**

3 Phil Guth is now working forJenzabar

4 Rajiv Kaushik worked for InfoSys Corporation when the Workgroup began meeting. He then moved to Wachovia Corporation and is now at Massachusetts Institute of Technology