

U. S. Suggested Retail Price List  
Jan-18

Phone: 260-665-2769

Fax: 260-665-3047

Email: iim@mobility-usa.com

[www.mobility-usa.com](http://www.mobility-usa.com)

Quote: \_\_\_\_\_

P.O. \_\_\_\_\_

**Bill To:**

Dealer: \_\_\_\_\_ Contact: \_\_\_\_\_

Address: \_\_\_\_\_

City: \_\_\_\_\_ State: \_\_\_\_\_ Zip: \_\_\_\_\_

Phone: \_\_\_\_\_ Fax: \_\_\_\_\_

Email: \_\_\_\_\_ Mark For: \_\_\_\_\_

**Ship To:**

Same as Bill To: \_\_\_\_\_

Dealer: \_\_\_\_\_ Contact: \_\_\_\_\_

Address: \_\_\_\_\_

City: \_\_\_\_\_ State: \_\_\_\_\_ Zip: \_\_\_\_\_

Phone: \_\_\_\_\_ Fax: \_\_\_\_\_

Email: \_\_\_\_\_ Mark For: \_\_\_\_\_

**Clip Features and Specifications**

- **Frame** - lightweight aluminum, silver painted with non-toxic epoxy powders, chair folds similar to an umbrella
- **Backrest** - semi-rigid, reclines in three positions with zippers
- **Seat Bottom** - slightly inclined, semi-rigid
- **Blue & White Upholstery** - removable for washing with removable aluminium reinforcement ribs, slots for attaching accessories
- **Wheels** - puncture-proof wheels glide on ball bearings: 6" front wheels swivel, 8" rear wheels with independent brakes
- **Net basket** - on the back of the backrest
- **Footrest** - removable, height adjustable

**Clip Seat - White & Blue Upholstery**

Part Number	Description	Price	HCPCS
_____ CLP-1	Clip size 1	\$2,200.00	E1236
_____ CLP-2	Clip size 2	\$2,300.00	E1236
_____ CLP-3	Clip size 3	\$2,400.00	E1236



**Footrest Options**

Part Number	Description	Price	HCPCS
_____ 827	Foot Straps 8"-11"	\$70.00	E0951
_____ 827A	Foot Straps 11"-14"	\$80.00	E0951



_____ CLP817-1	Leg Straps size 1,2	\$135.00	K0038
_____ CLP817-3	Leg Straps size 3	\$135.00	K0038







Client:





PO:

Clip USD

**Positioning Options**

Part Number	Description	Price	HCPCS	
CLP816-1	Side Supports for the trunk size 1,2	\$150.00	E0965	
CLP816-3	Side Supports for the trunk size 3	\$150.00	E0965	
CLP853-1	Vest Harness size 1,2	\$175.00	E0960	
CLP853-3	Vest Harness size 3	\$175.00	E0960	
894-1	45° Pelvic Belt size 1,2	\$95.00	E0978	
894-3	45° Pelvic Belt size 3	\$95.00	E0978	
906-1	Five Point Harness size 1,2	\$130.00	E0960	
906-3	Five Point Harness size 3	\$130.00	E0960	
CLP835-1	Adjustable Headrest size 1,2	\$150.00	E0955	
CLP835-3	Adjustable Headrest size 3	\$150.00	E0955	

**Clip Accessories**

Part Number	Description	Price	HCPCS	
CLP812-1	Wheel direction locks size 1,2,3	\$175.00	K0108	
CLP818-1	Blue Thermal Cover size 1,2	\$375.00	K0108	
CLP818-3	Blue Thermal Cover size 3	\$375.00	K0108	
CLP819-1	Blue Canopy size 1,2,3 requires CLP819-HW	\$300.00	K0108	
CLP819-HW	Canopy Hardware	\$125.00	K0108	
CLP 825-1	Blue Rain Cover size 1,2 requires 819	\$150.00	K0108	
CLP 825-3	Blue Rain Cover size 3 requires 819	\$150.00	K0108	
891	Tie Down Hooks Set of 4-forward-facing transport conforms with ISO 7176/19 and ANSI RESNA WC/19	\$275.00	K0108	

Client:

PO:

Clip USD

**Client Measurements**

A Back height \_\_\_\_\_ F Lower leg length \_\_\_\_\_  
 B Chest depth \_\_\_\_\_ G Head height \_\_\_\_\_  
 C Chest width \_\_\_\_\_ H Arm height \_\_\_\_\_  
 D Seat depth \_\_\_\_\_ Age: \_\_\_\_\_  
 E Seat width \_\_\_\_\_ Weight: \_\_\_\_\_

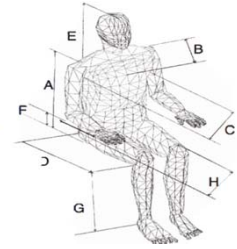

**Dimensions**

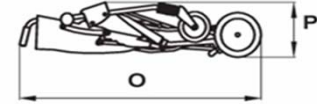
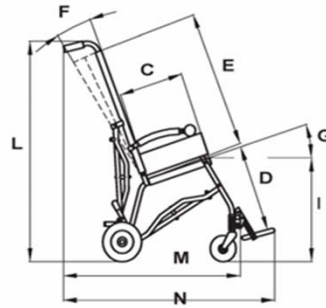
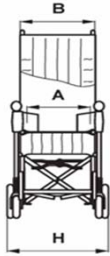

Measurement in Inches

Clip	Size 1	Size 2	Size 3
Max Capacity	66 lbs	77 lbs	88 lbs
User Height	43 - 49	47 - 55	53 - 61
Unit Weight	24 lbs	24 lbs	24.5 lbs
A Seat width	12	13	14
B Back width	16	16	16
C Seat depth	10	12	14
D Legrest length	6 - 9	8 - 12	10.5 - 14.5
E Backrest height	21.5	23	25
F Backrest inclination	0° - 12°	0° - 12°	0° - 12°
G Seat bottom inclination-tilt	18°	18°	18°
H Total width	20	20	20
I Knee to floor	18	19	19
L Height of chair	39	39	41
M Front wheel to handle bar	29	29	31
N Total length	31.5	35	37
O Folded seat height	43	43	45
P Folded seat depth	12	12	12.5
Q Folded seat width	12.5	12.5	14

Note: All specification and prices are subject to change without notice. Prices listed are only valid if ordering with a stroller. The HCPCS codes provided are not intended to be billing or legal advice, rather Innovation In Motion's interpretation of the code definitions. Use of the codes provided does not ensure coverage or payment for the item. For coverage information, verify the policy of the appropriate payer. It is recommended to contact Innovation In Motion with any questions regarding proper ordering of the chair at 1-260-665-2769.