



BOY SCOUTS OF AMERICA[®] NATIONAL



SHOOTING

SPORTS MANUAL



BOY SCOUTS OF AMERICA[®]

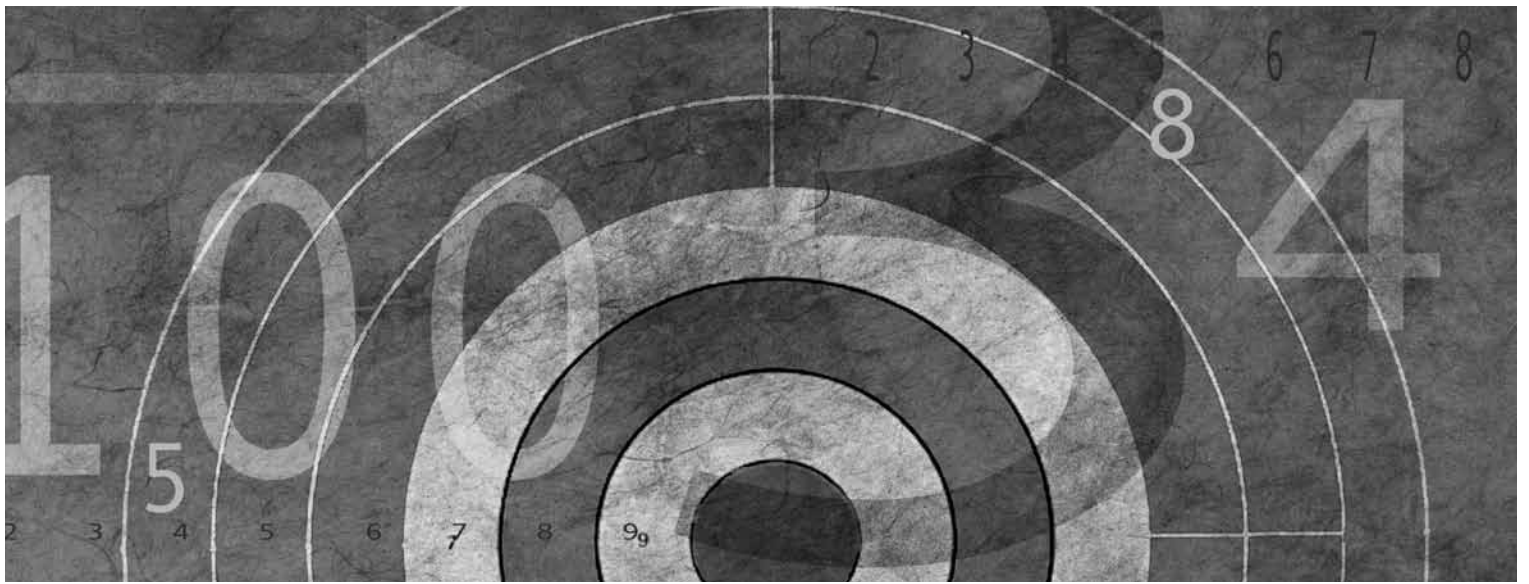

BOY SCOUTS OF AMERICA® NATIONAL SHOOTING SPORTS MANUAL



BOY SCOUTS OF AMERICA®

ACKNOWLEDGMENTS



The Boy Scouts of America greatly appreciates the National Shooting Sports Task Force and sub-task force members for their expertise and recommendations in the development of the *Boy Scouts of America National Shooting Sports Manual*. For their substantial contributions to the writing of this manual and commitment to Scouting, the BSA would also like to thank Larry Quandahl, Mark Belli, and Connie Elliott of the National Rifle Association, Youth Programs Education and Training Division.

A Word About Youth Protection

Child abuse is a serious problem in our society, and unfortunately, it can occur anywhere, even in Scouting. Youth safety is of paramount importance to Scouting. For that reason, the BSA continues to create barriers to abuse beyond what have previously existed in Scouting.

The Boy Scouts of America places the greatest importance on providing the most secure environment possible for our youth members. To maintain such an environment, the BSA has developed numerous procedural and leadership selection policies, and provides parents and leaders with numerous online and print resources for the Cub Scout, Boy Scout, and Venturing programs.

The BSA requires Youth Protection training for all registered leaders.

New leaders are required to complete Youth Protection training. To take the training online, go to www.MyScouting.org and establish an account using the member number you receive when you register for BSA membership. If you take the training online before you obtain a member number, be sure to return to MyScouting and enter your number for training record credit. Your BSA local council also provides training on a regular basis if you cannot take it online. For more information, refer to the back of the BSA adult membership application, No. 524-501.

Youth Protection training must be taken every two years—regardless of position. If a volunteer does not meet the BSA's Youth Protection training requirement at the time of recharter, the volunteer will not be reregistered.

We encourage all adults, including all parents, to take the BSA's Youth Protection training.

To find out more about the Youth Protection policies of the Boy Scouts of America and how to help Scouting keep your family safe, see the *Parent's Guide* in any of the Cub Scouting or Boy Scouting handbooks, or go to <http://www.scouting.org/Training/YouthProtection.aspx>.

Revised October 2011

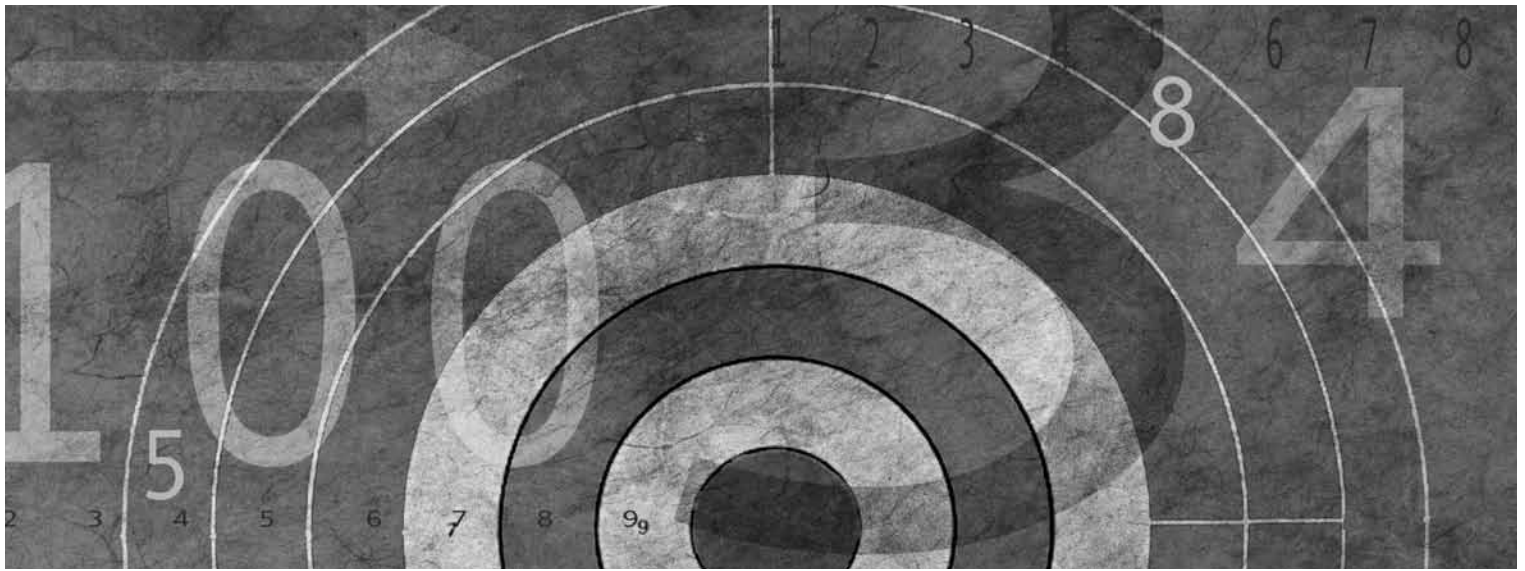

INTRODUCTION

The BSA's National Shooting Sports Committee understands the need for clarification in the terminology and delivery of the BSA shooting sports programs. The National Rifle Association, working with the BSA and the Shooting Sports Committee, reviewed BSA documents referencing shooting sports and has compiled that information into this new format, putting the information under one cover.

Section I, "The Essentials," contains information important and relevant to all individuals involved in the shooting sports programs. This includes leaders, merit badge counselors, council shooting sports chairs, council shooting sports committee members, National Camping School shooting sports directors, council camping committees, camp personnel, professionals, and all others who may be assisting in the various shooting sport programs.

Sections II through V contain information relevant and necessary for individuals involved in shooting sports on a higher level and providing the program for youth. This includes NRA instructors, NRA range safety officers, council shooting sports chairs, council shooting sports committee members, NRA coaches, council professionals, camping committees, camp rangers, National Camping School shooting sports directors, and all others involved in helping to organize events and assisting in the delivery of shooting programs throughout the year.

CONTENTS

Introduction	3
Section I The Essentials	
Chapter 1: Qualified Supervision—Roles and Responsibilities	9
Introduction to Shooting Sports and the Positive Aspects.....	9
Shooting Sports Personnel Descriptions	9
Definition of “Instructor Qualified”	10
Five Levels of Shooting Activities.....	11
Chapter 2: BSA Shooting Sports—A Wealth of Year-Round Opportunities	41
Cub Scout Programs	41
Boy Scout and Varsity Scout Programs	41
Venturing and Sea Scout Programs.....	42
Chapter 3: Merit Badge Counselors	44
Shooting Sports Merit Badge Counselor Requirements and Registration.....	44
Summer Camp Merit Badge Counselors.....	44
Resources for Merit Badge Counselors	44
Section II Beyond the Unit Level	
Chapter 4: Council Shooting Sports Committees.....	49
Organization	49
Responsibilities	49
Chapter 5: Range Operation.....	50
General Equipment Common to All Scouting Program Levels and Shooting Disciplines....	50
Range and Shooting Equipment Appropriate to Each Scouting Program Level.....	51
Section III Health and Safety	
Chapter 6: Safety	59
<i>Guide to Safe Scouting</i>	59
Communications	59
Emergency Response Plans.....	59
National Camping Standards	60
Standard Operating Procedures.....	60
Archery Safety Guidelines.....	60
Equipment Inspections—Firearms and Archery.....	60
Chapter 7: Health Considerations.....	61
General.....	61
Section IV Training	
Chapter 8: Training Courses.....	65
BSA Training	65
National Rifle Association Training.....	65
Archery Training	67
Section V Cub Scout Shooting Sports	
Chapter 9: Introduction.....	71
Leadership	71
BSA National Camping School Shooting Sports Director	71
Directing Shooting Sports in a Council Program	71
Safety Instruction Guidelines	72
Positive Aspects of Shooting Sports.....	72

Chapter 10: Archery	73
A Brief History of Archery	73
Leadership	73
Training Cub Scouts	74
Safety Guidelines	75
Archery Shooting Basics	75
Archery Games and Activities	78
Cub Scout Shooting Sports Award	79
Archery Belt Loop and Sports Pin.....	79
Range Layout	79
Range Operation Rules.....	80
Equipment	80
Targets and Scoring	82
Chapter 11: BB Gun Shooting.....	83
A Brief History of BB Guns	83
Leadership	83
Training BB Gun Range Masters	84
Training Cub Scouts	84
Safety Guidelines	85
BB Gun Shooting Basics.....	86
Basic Shooting Activity.....	88
BB Gun Shooting Games and Activities.....	89
Cub Scout Shooting Sports Award	90
BB Shooting Belt Loop and Sports Pin.....	90
Range Layout	91
Range Operation Rules.....	92
Equipment	92
Chapter 12: Other Shooting Sports.....	95
Shooting on a Safe Range.....	95
Pellet Guns.....	95
Slingshots and Wrist Rockets.....	95
Catapults and Other Shooting Devices.....	96
Chapter 13: Resources, Certificates, and Patches	97
Resources	97
Certification	98
Sample Archery Scorecard	99
Sample Targets.....	100
Crossword Puzzle: Air Gun Shooting	101
Quiver and Bow Rack.....	102
Archery Storage Locker.....	103
Glossary	107

Appendixes

- 1 NRA FIRST Steps/BSA Shotgun Shooting Merit Badge Teaching Guide
- 2 NRA FIRST Steps/BSA Rifle Shooting Merit Badge Teaching Guide
- 3 Sample Standard Operating Procedures Manual
- 4 Shooting Sports Decision Tree
- 5 Activity Consent Form, No. 680-673
- 6 Resources

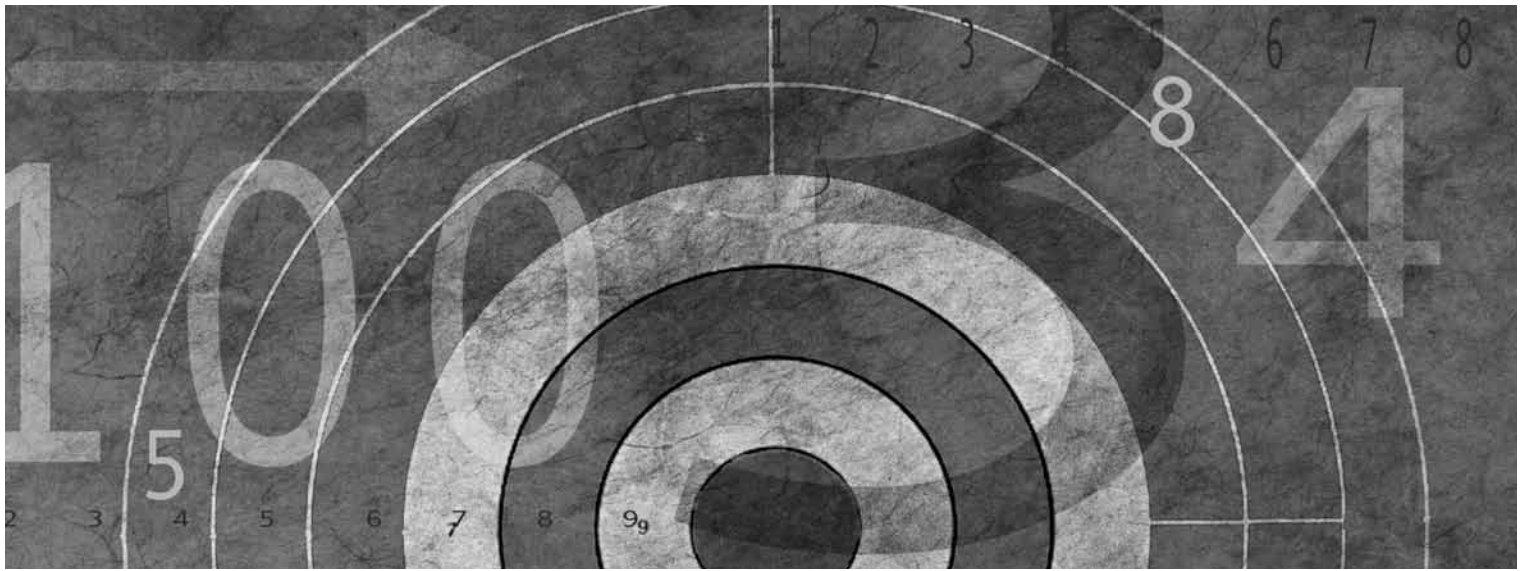

SECTION I THE ESSENTIALS

The information in Section I is essential for everyone involved in BSA shooting sports programs. This includes all individuals working with Cub Scouting, Boy Scouting, Venturing, Sea Scouting, or shooting sports committees.

Chapter 1: Qualified Supervision—Roles and Responsibilities

Introduction to Shooting Sports and the Positive Aspects

Throughout the Boy Scouts of America from Cub Scouting to Venturing and Sea Scouting, all program divisions use responsible outdoor activities to promote character development and values-based leadership training. Shooting sports have the ability to attract and retain youth in the movement. Millions of young people participate in one or more of the sports annually—archery, rifle shooting, shotgun activities, etc.—guided by adult volunteers who have the skills and knowledge to provide quality programs in a safe and effective way.

Scouting is delivered through small local units led by volunteers and sponsored by local organizations—churches, civic and veterans groups, schools, and other organizations. Depending upon the age group served, these units are Cub Scout packs, Boy Scout troops, Venturing crews, Sea Scout ships, and Varsity Scout teams, which are variable in size. Units within a geographic division, called a district, are assisted by full-time professional Scouters employed by a council. Units often take advantage of council summer camps, where trained staff members assume the responsibility for delivering a quality program, but some units also conduct activities under their own leadership. Other organizations also conduct youth camps—often stand-alone programs of short duration during the summer. BSA summer camps are but one element of a year-round program. The BSA encourages unit initiatives, whether it is a den leader taking advantage of a parent’s offer of a backyard space; a troop using private or public property, such as a state or other park; or a crew taking off on its own trek at Philmont or another high-adventure base.

Key to safe and effective unit activities is informed, trained, and conscientious unit leadership. Various activities can present some degree of risk; those risks can be mitigated by training and commitment of BSA volunteer leaders. When activities are properly conducted under the appropriate guidelines, they can be safe, fun filled, exciting, and rewarding.

The den leader, Cubmaster, Scoutmaster, crew Advisor, or other registered adult leader in charge, who accompanies the unit on an outing, is always responsible for ensuring that all activities adhere to the above points. However, BSA policy does not specify that the unit leader must be the one to satisfy all of the criteria. Under appropriate circumstances, a unit leader may delegate responsibility to others. For example, a Scout troop shooting at a gun club with National Rifle Association certified instructors may depend upon those instructors to conduct shooting activities. A Venturing crew or Sea Scout ship may rely on a National Rifle Association certified pistol instructor(s) to provide the necessary equipment and instruction.

As these examples demonstrate, a unit can participate in challenging and enjoyable shooting activities even where the unit’s leadership lacks the knowledge and skill to conduct these activities themselves. With regard to archery, a troop need not forgo an archery shoot simply because the facility does not employ a National Archery Association–certified instructor, provided that the unit leadership is trained with

the appropriate, current certifications that the BSA requires in order to conduct that program.

This publication provides information to determine when the proper safeguards are in place for a shooting activity, regardless of whether those safeguards are provided by the facility operator or the unit. Skills and certifications are reviewed, as well as requirements for a proper facility. After reviewing this material, the leader should be confident in his or her ability to judge when a shooting activity is safe, when the risk is unacceptable, or when his or her background is insufficient to make that determination. Experienced, informed leaders develop a sense or intuition with regard to an action. When an activity exceeds the leader’s comfort zone, it should be curtailed or modified.

Shooting Sports Personnel Descriptions

The following list contains titles an individual may hold in the shooting sports program and describes what their qualifications and responsibilities are.

Shooting Sports Director

- Twenty-one years of age or older and currently certified with National Camping School shooting sports director training within the past five years.
- In charge of all shooting sports programs, including rifle, shotgun, muzzleloaders, and archery during the summer camp program.
- Manages staff that includes properly qualified instructors with current certifications and trains support staff.
- Sees that all areas are maintained and used properly, keeps an updated inventory of equipment, and is in charge of the safe and proper maintenance and use of this equipment.
- Can serve as a range safety officer if the shooting sports director holds current NRA range safety officer certification.
- Can serve as a chief instructor if the National Camping School shooting sports director holds current NRA instructor certifications for the discipline for which supervision and instruction is required.

Council Shooting Sports Coordinator/Chair

- Twenty-one years of age or older. National Camping School certification as a shooting sports director is recommended.
- National Rifle Association certified instructor for one or more of the appropriate disciplines is recommended.
- Current NRA range safety officer certification is recommended.
- Certified Level 1 archery instructor recommended.

Chief Instructor

- Twenty-one years of age or older. Current NRA instructor rating in the specific shooting sports program for which supervision and instruction is required. The BSA National Camping School shooting sports director can be the chief instructor.

Assistant Instructors

- Eighteen years of age or older and holds current NRA assistant instructor's certificate in the appropriate discipline
- Can assist the chief instructor in supervising a range; however, this **does not include** running a live firing line.

NRA Range Safety Officer

- Twenty-one years of age or older and holds current NRA range safety officer credentials
- In charge of the firing line at any time it is in operation
- May not leave the firing line at any time while it is in operation

Shooting Sports Program Counselors and Aides

- Sixteen years of age or older and trained for specific duties by a National Camping School shooting sports director
- Under on-site supervision of an NRA range safety officer, may exercise crowd control, serve as training assistant for specified topics assigned by the NRA range safety officer, move and maintain equipment, and act as a coach in a student coach/pupil setting
- May **NOT** supervise any live fire

BSA BB Gun Range Master

- Eighteen years of age or older and trained by a National Camping School shooting sports director or National Rifle Association rifle instructor, or NRA/USA Shooting/CMP certified rifle coach
- Is in charge of the firing line at any time it is in operation
- BB gun training must be renewed every two years, and this person must have a current Training Course Certificate, No. 33767.

BSA Archery Director

- 18 years of age or older
- An archery range master who is trained by a National Camping School shooting sports director or is instructor-certified by the USA Archery/National Field Archery Association or trained using NFAA Level 1 Basic Instructor Course by a USA Archery/NFAA Level 2 instructor or an NCS shooting sports director.

- Responsibilities include the setup and operation of a safe archery range for Cub Scout or Boy Scout programs, Archery merit badge instruction, and management of an archery staff at camp.

BSA Archery Range Master

- Eighteen years of age or older and trained by a National Camping School shooting sports director or USA Archery/NFAA Level archery instructor to set up and operate a safe archery range for a Cub Scout or Boy Scout archery program according to BSA standards located in Section V of this manual, "Cub Scout Shooting Sports."
- Archery training must be renewed every two years, and this person must have a current Training Course Certificate, No. 33767.

Definition of "Instructor Qualified"

To be instructor qualified means the individual holds one or more of the following certifications depending on the discipline.

Trained and currently documented by:

- The BSA National Camping School as a shooting sports director for rifle, muzzleloading rifle, shotgun, and archery. Pistol is optional.
- The National Rifle Association as a currently certified basic instructor or coach for the specific discipline where instruction is taking place (rifle, muzzleloading rifle, shotgun, muzzleloading shotgun, pistol, or muzzleloading pistol)
- The National Muzzleloading Rifle Association as a current instructor or NRA instructor for muzzleloading rifle, muzzleloading shotgun or muzzleloading pistol
- The USA Archery/National Field Archery Association as a currently certified instructor or coach for archery

A copy of the current training certificate or document is to be on file at the local council office and/or camp.

Five Levels of Shooting Activities

Five Levels for Rifle Shooting

- The BSA's BB gun program is not included in the Five Levels for Rifle Shooting. Refer to Section V of this manual for information on Cub Scout BB gun shooting.
- BSA summer camps are not included in the Five Levels for Rifle Shooting.
- The BSA does not allow the use of any fully automatic firearms in its shooting sports program.
- Note that many public and private ranges may have stricter procedures that will take precedence over BSA rules. These stricter rules are the minimum acceptable for BSA shooting sports activities at those ranges.

Level 1: Air Rifle Shooting Experience

Purpose. Introduce and recruit youth to the BSA and the BSA shooting sports programs. The BSA is taking the range and the experience to the people.

Examples. An air rifle range set up at a community event, county or state fair, a mall, a store opening, etc.

Youth. Minimum age: 8 years old. Male or female

Rifle. .177-caliber air rifle with a minimum 2.5-pound trigger pull; open, scope, or dot sights; air, CO₂, or pre-charged pneumatic

Ammunition. .177-caliber pellets

Range. A BSA-approved range, a public or private commercial range or club, a portable range, a shooting trailer, or a temporary safety enclosure

Training. Five minutes of three rules of gun safety. Guns are tethered to a table and magazines are loaded by instructors. Youth just point at targets and fire. Taught by a National Camping School shooting sports director certified as an NRA rifle instructor, or an NRA certified rifle instructor or NRA/USA Shooting/CMP certified rifle coach.

Safety. Eye protection is required.

Range supervision. A certified NRA range safety officer or a currently certified National Camping School shooting sports director certified as an NRA rifle instructor or an NRA certified rifle instructor or NRA/USA Shooting/CMP certified rifle coach

Ratio. One NRA range safety officer or one currently certified National Camping School shooting sports director certified as an NRA rifle instructor or an NRA certified rifle instructor or NRA/USA Shooting/CMP certified rifle coach or NRA instructor for every shooter on the line

Course. Bench rest position only, large bull's-eye targets with a target carrier system, resetting metallic targets, balloons, and other fun, breakable targets

Level 2: Rifle Open Shooting Experience

Purpose. Introduce and recruit Scouts into shooting sports programs.

Examples. A day-at-the-range event (fun shoot), NRA Day event (contact the National Rifle Association for information on NRA Day), Winchester/NRA Marksmanship Qualification Program, camporee, camp weekend shoot, or Order of the Arrow event are examples. A rifle open shooting experience could be held at a BSA facility or public or private commercial range or club.

Youth. Boy Scouts, Venturers, Sea Scouts

Rifles.

- **Boy Scouts, Venturers, and Sea Scouts.** .177-caliber air rifle with a minimum 2.5-pound trigger pull; open, scope, or dot sights; air, CO₂, or pre-charged pneumatic
- **Boy Scouts.** .22-caliber rimfire, bolt-action rifles. Either a breech-loading, single-shot, bolt-action rifle or a repeater bolt-action rifle with a box magazine must be used. If a magazine-fed rifle is used, the cartridges must be loaded directly into the rifle's chamber and not fed from the magazine into the chamber. (*Tubular magazines are **not** allowed.*) Trigger pull will be a minimum of three pounds.
- **Venturers and Sea Scouts.** Any cartridge-firing rifle with open, scope, or dot sights

Ammunition. Correct ammunition for the rifle being fired. Tracer, armor-piercing, and explosive ammo are not allowed.

Range. A BSA-approved range or a public or private commercial range or club for air rifle or cartridge-firing rifles. For air rifle, a portable range, shooting trailer, temporary safety enclosure, or public or private commercial range or club may be used.

Training. BSA 30-minute rifle briefing taught by a National Camping School shooting sports director certified as an NRA rifle instructor, or an NRA certified rifle instructor or NRA/USA Shooting/CMP certified rifle coach. **Note:** If a youth has completed the NRA FIRST Steps Rifle Course or NRA Basics of Rifle Shooting Course, or earned the Rifle Shooting merit badge in the past, and has written documentation of completion with them, they do not need to take this training.

Safety. Eye protection is required for air rifles. Cartridge-firing rifles require eye and hearing protection.

Range supervision. A certified NRA range safety officer is to directly supervise all live fire on the range. Additionally, the instruction offered must be done by a currently certified National Camping School shooting sports director certified as an NRA rifle instructor or an NRA certified rifle instructor or an NRA/USA Shooting/CMP certified rifle coach. These must be two separate individuals.

Ratio. One NRA range safety officer per eight shooters

Course. Bench rest, prone, standing, kneeling, or sitting positions. Targets could be paper, resetting metallic targets, balloons, and other fun, breakable targets. You can also use the Winchester/NRA Marksmanship Qualification Program.

Level 3: Rifle Ongoing Shooting Sports Program

Purpose. Introduce and recruit Scouts into year-round shooting sports programs.

Examples. Examples of ongoing programs are the Boy Scout Rifle Shooting merit badge and the Venturing Ranger Award. Shooting programs could be held at a BSA facility or public or private commercial range or club.

Youth. Boy Scouts, Venturers, Sea Scouts

Rifles. Rifles will meet the requirements of the BSA program as follows:

- **Boy Scouts, Venturers, and Sea Scouts.** .177-caliber air rifle with a minimum 2.5-pound trigger pull; open, scope, or dot sights; air, CO₂, or pre-charged pneumatic
- **Boy Scouts.** .22-caliber rimfire, bolt-action rifles. Either a breech-loading, single-shot, bolt-action rifle or a repeater bolt-action rifle with a box magazine must be used. If a magazine-fed rifle is used, the cartridges must be loaded directly into the rifle's chamber and not fed from the magazine into the chamber. (*Tubular magazines are **not** allowed.*) Trigger pull will be a minimum of three pounds.
- **Venturers and Sea Scouts.** Any cartridge-firing rifle with open, scope, or dot sights

Ammunition. Correct ammunition for the rifle being fired. Tracer, armor-piercing, and explosive ammo are not allowed.

Range. A BSA-approved range for air rifle or cartridge-firing rifles or a public or private commercial range or club. For air rifle, a portable range, shooting trailer, temporary safety enclosure, or public or private commercial range or club may be used.

Training. NRA Rifle FIRST Steps (three hours) or NRA Basics of Rifle Shooting Course (eight hours). Taught by a National Camping School shooting sports director certified as an NRA rifle instructor, or an NRA certified rifle instructor or NRA/USA Shooting/CMP certified rifle coach. **Note:** If a youth has completed the NRA FIRST Steps Rifle Course or NRA Basics of Rifle Shooting Course, or earned the Rifle Shooting merit badge in the past, and has written documentation of completion with them, they do not need to take this training.

Safety. Eye protection is required for air rifle. Cartridge-firing rifles require eye and hearing protection.

Range supervision. A certified NRA range safety officer is to directly supervise all live fire on the range. Additionally, the instruction offered must be done by a currently certified National Camping School shooting sports director certified as an NRA rifle instructor or an NRA certified rifle instructor or NRA/USA Shooting/CMP certified rifle coach. These must be two separate individuals.

Ratio. One NRA range safety officer to eight shooters. One NRA rifle instructor to eight shooters while firing.

Course. Boy Scout Rifle Shooting merit badge and the Venturing Ranger Award.

Level 4: Rifle Competitive Level

Purpose. To promote competition among Boy Scouts, Venturers, and Sea Scouts.

Youth. Boy Scouts, Venturers, and Sea Scouts

Rifles. Rifles will meet the requirements for the conventional and international rifle shooting competitive programs. The trigger pull will be determined by the course of competition.

Ammunition. Correct ammunition for the rifle being fired. Tracer, armor-piercing, and explosive ammo are not allowed.

Range. A BSA-approved range or a public or private commercial range or club

Training. NRA Rifle FIRST Steps (three hours) or NRA Basics of Rifle Shooting Course (eight hours). Taught by a National Camping School shooting sports director certified as an NRA rifle instructor, or an NRA certified rifle instructor or NRA/USA Shooting/CMP certified rifle coach. **Note:** If a youth has completed the NRA FIRST Steps Rifle Course or NRA Basics of Rifle Shooting Course, or earned the Rifle Shooting merit badge in the past, and has written documentation of completion with them, they do not need to take this training.

Safety. Eye protection is required for air rifle. Cartridge-firing rifles require eye and hearing protection.

Range supervision. Range supervision will be based on the rules of the approved competition.

Course. Competitive rule book for the course of competition

Level 5: NRA Rifle Instructor or NRA Coach

Purpose. Boy Scouts, Venturers, and Sea Scouts to take a leadership role in their troop, crew, or ship as an NRA apprentice or NRA assistant instructor or NRA assistant coach.

Youth. Boy Scouts, Venturers, and Sea Scouts

Rifles. Rifles will meet the requirements for the course being taught

Ammunition. Correct ammunition for the rifle being fired

Range. A BSA-approved range or a public or private commercial range or club

Training. Successfully complete an NRA rifle instructor training or an NRA/USA Shooting/CMP rifle coach school.

Safety. Eye protection is required for air rifle. Cartridge-firing rifles require eye and hearing protection.

Range supervision. Range supervision will be based on the course being taught.

Course. NRA instructor course or NRA coach course

Five Levels for Shotgun Shooting

- BSA summer camps are not included in the Five Levels for Shotgun Shooting.
- The BSA does not allow the use of any fully automatic firearms in its shooting sports program.
- Note that many public and private ranges may have stricter procedures that will take precedence over BSA rules. These stricter rules are the minimum acceptable for BSA shooting sports activities at those ranges.

Level 1: Shotgun-Shooting Experience

Level 1 is not available for shotgun shooting.

Level 2: Shotgun Open Shooting Experience

Purpose. Introduce and recruit Scouts into shooting sports programs.

Examples. A day-at-the-range event (fun shoot), NRA Day event (contact the National Rifle Association for information on NRA Day), or Winchester/NRA Marksmanship Qualification Program. A BSA camp weekend shoot, camporee, or Order of the Arrow event are examples.

Youth. Boy Scouts, Venturers, and Sea Scouts

Shotgun. Youth- and adult-size gas-operated semiautomatic shotguns are recommended. It is recommended that 20-, 16-, or 12-gauge semiautomatic shotguns be used.

Ammunition. Correct ammunition for the shotgun being fired. Tracer, armor-piercing, and explosive ammo are not allowed.

Range. A BSA-approved range for shotguns or a public or private commercial range or club

Training. BSA 30-minute shotgun briefing taught by a National Camping School shooting sports director certified as an NRA shotgun instructor, or an NRA certified shotgun instructor or NRA/USA Shooting/CMP certified shotgun coach. **Note:** If a youth has completed an NRA FIRST Steps Shotgun Course or NRA Basics of Shotgun Shooting Course, or earned the Shotgun Shooting merit badge in the past, and has written documentation of completion with them, they do not need to take this training.

Safety. Eye and hearing protection are required.

Range supervision. A certified NRA range safety officer is to directly supervise live fire on the range. Additionally, the instruction offered must be done by a currently certified National Camping School shooting sports director certified as an NRA shotgun instructor or an NRA certified shotgun instructor or NRA/USA Shooting/CMP certified shotgun coach. These must be two separate individuals.

Ratio. One NRA range safety officer must be present for each group consisting of a maximum of six shooters. One NRA instructor for each student is required when loading and firing a shotgun.

Course. Slow, straight-away, and incoming targets. You can also use the Winchester/NRA Marksmanship Qualification Program. An example would be trap single with one shot shell loaded at a time.

Level 3: Shotgun Ongoing Shooting Sports Program

Purpose. Introduce and recruit Scouts into year-round shooting sports programs.

Examples. Examples of ongoing programs are the Boy Scout Shotgun Shooting merit badge and Venturing Ranger Award. Shooting programs could be held at a BSA facility or a public or private commercial range or club.

Youth. Boy Scouts, Venturers, and Sea Scouts

Shotgun. Youth- and adult-size gas-operated semiautomatic shotguns are recommended. It is recommended that 20-, 16-, or 12-gauge semiautomatic shotguns be used.

Ammunition. Correct ammunition for the shotgun being fired. Tracer, armor-piercing, and explosive ammo are not allowed.

Range. A BSA-approved range for shotguns or a public or private commercial range or club

Training. NRA Shotgun FIRST Steps (three hours) or NRA Basics of Shotgun Shooting Course (eight hours). Taught by a National Camping School shooting sports director certified as an NRA shotgun instructor or NRA certified shotgun instructor or NRA/USA Shooting/CMP certified shotgun coach. **Note:** If a youth has completed an NRA FIRST Steps Shotgun Course or NRA Basics of Shotgun Shooting Course, or earned the Shotgun Shooting merit badge in the past, and has written documentation of completion with them, they do not need to take this training.

Safety. Eye and hearing protection are required.

Range supervision. A certified NRA range safety officer is to directly supervise live fire on the range. Additionally, the instruction offered must be done by a currently certified National Camping School shooting sports director certified as an NRA shotgun instructor or an NRA certified shotgun instructor or NRA/USA Shooting/CMP certified shotgun coach. These must be two separate individuals.

Ratio. One NRA range safety officer must be present for each group consisting of a maximum of six shooters. One NRA instructor for each student is required when loading and firing a shotgun.

Course. Boy Scout Shotgun Shooting merit badge and Venturing Ranger Award. An example would be trap single with one shot shell loaded at a time.

Level 4: Shotgun Competitive Level Program

Purpose. To promote competition among Boy Scouts, Venturers, and Sea Scouts.

Youth. Boy Scouts, Venturers, and Sea Scouts

Shotguns. Shotguns will meet the requirements for the conventional and international shotgun shooting competitive programs. The trigger pull will be determined by the course of competition.

Ammunition. Correct ammunition for the shotgun being fired. Tracer, armor-piercing, and explosive ammo are not allowed.

Range. A BSA-approved range for shotguns or a public or private commercial range or club

Training. NRA Shotgun FIRST Steps (three hours) or NRA Basics of Shotgun Shooting Course (eight hours). Taught by a National Camping School shooting sports director certified as an NRA shotgun instructor or NRA certified shotgun instructor or NRA/USA Shooting/CMP certified shotgun coach. **Note:** If a youth has completed an NRA FIRST Steps Shotgun Course, or NRA Basics of Shotgun Shooting Course, or earned the Shotgun Shooting merit badge in the past, and has written documentation of completion with them, they do not need to take this training.

Safety. Shotgun shooting requires eye and hearing protection.

Range supervision. Range supervision will be based on the rules of the BSA-approved competition.

Course. Competitive rule book for the course of competition. Load shells per the course of fire. Examples would be: trap doubles, where two shot shells are loaded; skeet, where two shot shells are loaded; five stand; and sporting clays.

Level 5: NRA Shotgun Instructor or NRA Coach

Purpose. Boy Scouts, Venturers, and Sea Scouts to take a leadership role in their troop, crew, or ship as an NRA apprentice or NRA assistant instructor or NRA assistant coach

Youth. Boy Scouts, Venturers, and Sea Scouts

Shotguns. Shotguns will meet the requirements for the course being taught.

Ammunition. Correct ammunition for the shotgun being fired. Tracer, armor-piercing, and explosive ammo are not allowed.

Range. A BSA-approved range for shotguns or a public or private commercial range or club

Training. Successfully complete an NRA shotgun instructor training or an NRA/USA Shooting/CMP shotgun coach school.

Safety. Shotgun shooting requires eye and hearing protection.

Range supervision. Range supervision will be based on the course being taught.

Course. NRA shotgun instructor course or NRA coach course

Five Levels for Pistol Shooting

Note that many public and private ranges may have stricter procedures that will take precedence over BSA rules. These stricter rules are the minimum acceptable for BSA shooting sports activities at those ranges.

Level 1: Air Pistol Shooting Experience

Purpose. Introduce and recruit youth to the BSA and the Venturing and Sea Scouting shooting sports programs.

Examples. A community event, county or state fair, shopping mall, or a store opening. The BSA is taking the range and the experience to the people.

Youth. Minimum age: 14 years old. Male or female

Pistol. .177-caliber air pistol with a minimum 2.5-pound trigger pull; open, scope, or dot sights; air, CO₂, or pre-charged pneumatic

Ammunition. .177-caliber pellets

Range. A BSA-approved range or a public or private commercial range or club, a portable range, a shooting trailer, or a temporary safety enclosure

Training. BSA 30-minute pistol briefing due to 1-to-1 ratio of shooter to instructor, with the instructors loading the pistol for the shooter. Taught by a National Camping School shooting sports director currently certified as an NRA certified pistol instructor, or an NRA certified pistol instructor or NRA/USA Shooting/CMP certified pistol coach.

Safety. Eye protection is required.

Range supervision. A certified NRA range safety officer is to directly supervise live fire on the range. Additionally, the instruction offered must be done by a currently certified National Camping School shooting sports director certified as an NRA pistol instructor or an NRA certified pistol instructor or NRA/USA Shooting/CMP certified pistol coach. These must be two separate individuals.

Ratio. One NRA range safety officer per three shooters. One NRA pistol instructor or NRA/USA Shooting/CMP certified pistol coach per shooter while shooting.

Course. Bench rest position, large bull's-eye targets with a target carrier system, resetting metallic targets, balloons, and other fun, breakable targets

Level 2: Pistol Open Shooting Experience

Purpose. Introduce and recruit Venturers and Sea Scouts into shooting sports programs.

Examples. A day-at-the-range event (fun shoot), NRA Day event (contact the National Rifle Association for information on NRA Day), Winchester/NRA Marksmanship Qualification Program, camporee, or camp weekend shoot. A cartridge-firing pistol open shooting experience could be held at a BSA facility or a public or private commercial range or club. A pistol open shooting experience using air pistols could use a portable range, shooting trailer, or temporary safety enclosure.

Youth. Venturers and Sea Scouts

Pistols. .177-caliber air pistol with a minimum 2.5-pound trigger pull; open, scope, or dot sights; air, CO₂, or pre-charged pneumatic. Cartridge-firing pistol with a three-pound trigger pull; open, scope, or dot sights

Ammunition. Correct ammunition for the pistol being fired. Tracer, armor-piercing, and explosive ammo are not allowed.

Range. A BSA-approved range for air pistol and cartridge-firing pistols or a public or private commercial range or club. For air pistol, a portable range, shooting trailer, temporary safety enclosure, or a public or private commercial range or club may be used.

Training. BSA 30-minute pistol briefing due to 1-to-1 ratio of shooter to instructor, with the instructor loading the pistol for the shooter. Taught by a National Camping School shooting sports director currently certified as an NRA certified pistol instructor or an NRA certified pistol instructor or NRA/USA Shooting/CMP certified pistol coach.

Safety. Eye protection is required for air pistols. Cartridge-firing pistols require eye and hearing protection.

Range supervision. A certified NRA range safety officer is to directly supervise live fire on the range. Additionally, the instruction offered must be done by a currently certified National Camping School shooting sports director certified as an NRA pistol instructor or an NRA certified pistol instructor or NRA/USA Shooting/CMP certified pistol coach. These must be two separate individuals.

Ratio. One NRA range safety officer per three shooters. One NRA pistol instructor or NRA/USA Shooting/CMP certified pistol coach per shooter while shooting.

Course. Bench rest or two-handed standing positions. Targets may be paper, resetting metallic targets, balloons, and other fun breakable targets. You can also use the Winchester/NRA Marksmanship Qualification Program.

Level 3: Pistol Ongoing Shooting Sports Program

Purpose. Introduce and recruit Venturers and Sea Scouts to year-round shooting sports programs.

Examples. An example of an ongoing program is the Venturing Ranger Award. Shooting programs could be held at a BSA facility, or a public or private commercial range or club may be used.

Youth. Venturer and Sea Scouts

Pistols. .177-caliber air pistol with a minimum 2.5-pound trigger pull; open, scope, or dot sights; air, CO₂, or pre-charged pneumatic. Cartridge-firing pistol with a three-pound trigger pull; open, scope, or dot sights

Ammunition. Correct ammunition for the pistol being fired. Tracer, armor-piercing, and explosive ammo are not allowed.

Range. A BSA-approved range for air pistol and cartridge-firing pistols, or a public or private commercial range or club. For air pistol, a portable range, shooting trailer, temporary safety enclosure, or a public or private commercial range or club may be used.

Training. NRA FIRST Steps (three hours) or NRA Basics of Pistol Shooting Course (eight hours). Taught by a National Camping School shooting sports director certified as an NRA pistol instructor or an NRA certified pistol instructor or NRA/USA Shooting/CMP certified pistol coach.

Safety. Eye protection is required for air pistols. Cartridge-firing pistols require eye and hearing protection.

Range supervision. A certified NRA range safety officer is to directly supervise live fire on the range. Additionally, the instruction offered must be done by a currently certified National Camping School shooting sports director certified as an NRA pistol instructor or an NRA certified pistol instructor or NRA/USA Shooting/CMP certified pistol coach. These must be two separate individuals.

Ratio. One NRA range safety officer per three shooters. One NRA pistol instructor or NRA/USA Shooting/CMP certified pistol coach per two shooters while loading and shooting.

Course. Venturing Ranger Award

Level 4: Pistol Competitive Shooting Sports Program

Purpose. Introduce and recruit Venturers and Sea Scouts to year-round competitive shooting sports programs.

Examples. Examples of ongoing programs are conventional and international pistol shooting competitive programs. Shooting programs could be held at a BSA facility or a public or private commercial range or club.

Youth. Venturers and Sea Scouts

Pistols. Pistols will meet the requirements of the competitive rule book for the course of competition.

Ammunition. Correct ammunition for the pistol being fired. Tracer, armor-piercing, and explosive ammo are not allowed.

Range. A BSA-approved range for air pistol and cartridge-firing pistols, or a public or private commercial range or club. For air pistol, a portable range, shooting trailer, temporary safety enclosure, or a public or private commercial range or club may be used.

Training. NRA FIRST Steps (three hours) or NRA Basics of Pistol Shooting Course (eight hours). Taught by a National Camping School shooting sports director certified as an NRA pistol instructor or an NRA certified pistol instructor or NRA/USA Shooting/CMP certified pistol coach.

Safety. Eye protection is required for air pistols. Cartridge-firing pistols require eye and hearing protection.

Range supervision. Range supervision will be based on the rules of the approved competition.

Course. The competitive rule book for the course or competition level

Level 5: Pistol Marksmanship Instructor or Coach

Purpose. Venturers and Sea Scouts to take on a leadership role in their crew or ship as an NRA apprentice or assistant instructor or assistant coach.

Youth. Venturers and Sea Scouts

Training. Successfully complete an NRA pistol instructor training or an NRA/USA Shooting/CMP pistol coach school.

Five Levels for Muzzleloading Rifle Shooting

Note that many public and private ranges may have stricter standard operating procedures (SOPs) that will take precedence. These SOPs are the minimum acceptable for BSA shooting sports activities.

Level 1: Muzzleloading Introduction

Purpose. Introduce and recruit youth to the BSA and the BSA shooting sports programs.

Examples. Could be held at a county or state fair, conservation club, or school program (with prior administrative approval). The BSA is taking the range and the experience to the people.

Youth. Minimum age: 8 years old. Male or female

Rifle. Flintlock and percussion rifles and accoutrements

Ammunition. Samples of appropriate ammunition for display and explanation

Range. Not applicable. For display and discussion purposes only.

Training. Guns are not to be handled except by an instructor. Taught by a National Camping School shooting sports director certified as an NRA/NMLRA muzzleloading rifle instructor, or an NRA/NMLRA muzzleloading rifle instructor, or a National Muzzleloading Rifle Association rifle instructor.

Safety. Display and discussion only

Range supervision. Not applicable

Ratio. Small groups

Course. No course of fire

Level 2: Muzzleloading Rifle Open Shooting Experience

Purpose. Introduce and recruit Scouts into shooting sports programs.

Examples. A day-at-the-range event (fun shoot), NMLRA Day, NRA Day, or a Winchester/NRA Marksmanship Qualification Program. Could be held at a BSA facility or public or private commercial range or club.

Youth. Boy Scouts, Venturers, and Sea Scouts

Rifles. Muzzleloading rifles, in appropriate size for the shooter

Ammunition. Correct ammunition for the rifle being fired

Range. BSA-approved range, or a public or private commercial range or club

Training. A 30-minute rifle briefing taught by a National Camping School shooting sports director certified as an NRA/NMLRA muzzleloading rifle instructor, or an NRA/NMLRA muzzleloading rifle instructor, or a National Muzzleloading Rifle Association rifle instructor.

Safety. Eye and hearing protection are required.

Range supervision. A certified NRA range safety officer is directly supervising all live fire on the range. Additionally, the instruction offered must be done by a currently certified National Camping School shooting sports director certified as an NRA/NMLRA muzzleloading rifle instructor, or an NRA/NMLRA muzzleloading rifle instructor, or a National Muzzleloading Rifle Association rifle instructor. These must be two separate individuals.

Ratio. One NRA range safety officer per eight shooters. One NRA/NMLRA muzzleloading rifle instructor or National Muzzleloading Rifle Association rifle instructor per shooter while loading and firing.

Course. Bench rest or cradled, rifle loaded by instructor only. Targets could be paper, resetting metallic targets, balloons, and other fun breakable targets (environmentally friendly materials). You can also use the Winchester/NRA Marksmanship Qualification Program.

Level 3: Muzzleloading Rifle Ongoing Shooting Sports Program

Purpose. Introduce and recruit Scouts into year-round shooting sports programs.

Examples. The Rifle Shooting merit badge and Venturing Ranger Award. Shooting programs could be held at a BSA facility or public or private commercial range or club.

Youth. Boy Scouts, Venturers, and Sea Scouts

Rifles. Muzzleloading rifles, in appropriate size for the shooter

Ammunition. Correct ammunition for the rifle being fired

Range. BSA-approved range, or public or private commercial range or club

Training. Three hours of instruction on loading and firing a muzzleloader, as well as instruction on range rules and safety. Taught by a National Camping School shooting sports director certified as an NRA/NMLRA muzzleloading rifle instructor, or an NRA/NMLRA muzzleloading rifle instructor, or a National Muzzleloading Rifle Association rifle instructor.

Safety. Eye and hearing protection are required.

Range supervision. A certified NRA range safety officer is directly supervising all live fire on the range. Additionally, the instruction offered must be done by a currently certified National Camping School shooting sports director certified as an NRA/NMLRA muzzleloading rifle instructor, or an NRA/NMLRA muzzleloading rifle instructor, or a National Muzzleloading Rifle Association rifle instructor. These must be two separate individuals.

Ratio. One NRA range safety officer per eight shooters. One NRA/NMLRA rifle instructor or National Muzzleloading Rifle Association rifle instructor per shooter while loading and firing.

Course. Rifle Shooting merit badge and Venturing Ranger Award

Level 4: Muzzleloading Rifle Competitive Level

Purpose. To promote competition among Boy Scouts, Venturers, and Sea Scouts.

Youth. Boy Scouts, Venturers, and Sea Scouts

Rifles. Rifles will meet the requirements for the conventional and international muzzleloading rifle shooting competitive programs.

Ammunition. Correct ammunition for the rifle being fired

Range. BSA-approved range or public or private commercial range or club

Training. Basic muzzleloading instruction including cleaning and maintaining muzzleloading rifles. Taught by a National Camping School shooting sports director certified as an NRA/NMLRA rifle instructor, or an NRA/NMLRA certified rifle instructor, or a National Muzzleloading Rifle Association rifle instructor.

Safety. Eye and hearing protection are required.

Range supervision. Range supervision will be based on the rules of the approved competition.

Course. The competitive rule book for the course of competition

Level 5: NMLRA Rifle Instructor or NMLRA Range Officer

Purpose. Boy Scouts, Venturers, and Sea Scouts to take on a leadership role in their troop, crew, or ship as an NMLRA instructor, NRA muzzleloading rifle instructor, or NMLRA range officer

Youth. Boy Scouts, Venturers, and Sea Scouts

Rifles. Rifles will meet the requirements for the course being taught.

Ammunition. Correct ammunition for the rifle being fired

Range. BSA-approved range or public or private commercial range or club

Training. Successfully complete NMLRA instructor training, NRA/NMLRA muzzleloading rifle instructor course, or an NRA range officer course.

Safety. Eye and hearing protection are required.

Range supervision. Based on the course being taught

Course. NMLRA instructor course, NRA/NMLRA muzzleloading rifle instructor course or NRA range officer course

Five Levels for Muzzleloading Shotgun Shooting

Note that many public and private ranges may have stricter standard operating procedures (SOPs) that will take precedence. These SOPs are the minimum acceptable for BSA shooting sports activities.

Level 1: Muzzleloading Shotgun Shooting Experience

Level 1 is not available for shotgun shooting.

Level 2: Muzzleloading Shotgun Open Shooting Experience

Purpose. Introduce and recruit Scouts into shooting sports programs.

Examples. A day-at-the-range event, fun shoot, NMLRA Day, or an NRA Day. Could be held at a BSA facility or public or private commercial range or club.

Youth. Boy Scouts, Venturers, and Sea Scouts

Shotgun. 10-gauge or smaller muzzleloading shotguns

Ammunition. Correct ammunition for the shotgun being fired

Range. A BSA-approved range for shotguns or public or private commercial range or club

Training. A 30-minute shotgun briefing taught by a National Muzzle Loading Rifle Association instructor, National Camping School shooting sports director certified as an NRA muzzleloading shotgun instructor, or an NRA certified muzzleloading shotgun instructor.

Safety. Eye and hearing protection are required.

Range supervision. A certified NRA range safety officer is to directly supervise all live fire on the range. Additionally, the instruction offered must be done by a currently certified National Camping School shooting sports director certified as an NRA or NMLRA muzzleloading shotgun instructor or an NRA certified muzzleloading shotgun instructor. These must be two separate individuals.

Ratio. One NRA range safety officer per shooter. One adult to run hand trap, if applicable. One NRA or NMLRA muzzleloading shotgun instructor per shooter while loading and firing.

Course. Slow, straightaway targets

Level 3: Muzzleloading Shotgun Ongoing Shooting Sports Program

Purpose. Introduce and recruit Scouts into year-round shooting sports programs.

Examples. The Shotgun Shooting merit badge, Venturing Ranger Award, and the Winchester/NRA Marksmanship Qualification Program. Shooting programs could be held at a BSA facility or public or private commercial range or club.

Youth. Boy Scouts, Venturers, and Sea Scouts

Shotgun. 10-gauge or smaller muzzleloading shotguns

Ammunition. Correct ammunition for the shotgun being fired

Range. A BSA-approved range for shotguns or public or private commercial range or club

Training. Three hours of instruction on loading and firing a muzzleloading shotgun, as well as instruction on range rules and safety. Taught by a National Muzzle Loading Rifle Association instructor, National Camping School shooting sports director certified as an NRA muzzleloading shotgun instructor, or an NRA certified muzzleloading shotgun instructor.

Safety. Eye and hearing protection are required.

Range supervision. A certified NRA range safety officer is directly supervising all live fire on the range. Additionally, the instruction offered must be done by a currently certified National Camping School shooting sports director certified as an NRA or NMLRA muzzleloading shotgun instructor or an NRA certified muzzleloading shotgun instructor. These must be two separate individuals.

Ratio. One NRA range safety officer must be present for each group consisting of a maximum of five shooters. It must be a 1-to-1 NRA or NMLRA muzzleloading shotgun instructor-to-student ratio when loading and firing a shotgun.

Course. Shotgun Shooting merit badge, Venturing Ranger Award, and the Winchester/NRA Marksmanship Qualification, regulation skeet, trap targets shot at 10, 16, or 20 yards

Level 4: Shotgun Competitive Level Program

Purpose. To promote competition among Boy Scouts, Venturers, and Sea Scouts.

Youth. Boy Scouts, Venturers, and Sea Scouts

Shotguns. 10-gauge or smaller muzzleloading shotguns

Ammunition. Correct ammunition for the shotgun being fired

Range. A BSA-approved range for shotguns or public or private commercial range or club

Training. Basic muzzleloading instruction, including the cleaning and maintenance of muzzleloading shotguns. Taught by a National Muzzle Loading Rifle Association instructor, National Camping School shooting sports director certified as an NRA muzzleloading shotgun instructor, or an NRA certified muzzleloading shotgun instructor.

Safety. Shotgun shooting requires eye and hearing protection.

Range supervision. Range supervision will be based on the rules of the BSA-approved competition.

Course. Competitive rules for the course of competition

Level 5: NMLRA Shotgun Instructor

Purpose. Boy Scouts, Venturers, and Sea Scouts to take a leadership role in their troop, crew, or ship as an NMLRA muzzleloading shotgun instructor or an NRA muzzleloading shotgun instructor.

Youth. Boy Scouts, Venturers, and Sea Scouts

Rifles. Shotguns will meet the requirements for the course being taught.

Ammunition. Correct ammunition for the shotgun being fired

Range. A BSA-approved range or public or private commercial range or club

Training. Successfully complete NMLRA muzzleloading shotgun instructor training or an NRA muzzleloading shotgun instructor course.

Safety. Eye and hearing protection are required.

Range supervision. Range supervision will be based on the course being taught.

Course. NMLRA muzzleloading shotgun instructor course or an NRA muzzleloading shotgun instructor course

Five Levels for Muzzleloading Pistol Shooting Venturing and Sea Scouting

Note that many public and private ranges may have stricter standard operating procedures (SOPs) that will take precedence. These SOPs are the minimum acceptable for BSA shooting sports activities.

Level 1

Level 1 is not available for muzzleloading pistol shooting.

Level 2: Muzzleloading Pistol Open Shooting Experience

Purpose. Introduce and recruit Scouts into shooting sports programs.

Examples. A day-at-the-range event (fun shoot), National Muzzle Loading Rifle Association (NMLRA) Day, or a National Rifle Association (NRA) Day. The Muzzleloading Pistol Open Shooting Experience could be held at a BSA facility or public or private commercial range or club.

Youth. Venturers and Sea Scouts

Pistols. Muzzleloading pistols, flint or percussion, single-barrel or revolver, in appropriate size for the shooter

Ammunition. Correct ammunition for the pistol being fired

Range. A BSA-approved range or public or private commercial range or club

Training. A 30-minute pistol briefing taught by an NMLRA instructor or National Camping School shooting sports director certified as an NRA/NMLRA muzzleloading pistol instructor or an NRA/NMLRA muzzleloading pistol instructor.

Safety. Eye and hearing protection are required.

Range supervision. A certified NRA range safety officer is directly supervising all live fire on the range. Additionally, the instruction offered may be done by a currently certified National Camping School shooting sports director certified as an NRA/NMLRA muzzleloading pistol instructor, an NMLRA instructor, or an NRA/NMLRA certified muzzleloading pistol instructor. These must be two separate individuals.

Ratio. One NRA range safety officer per three shooters. One NRA or NMLRA muzzleloading pistol instructor per shooter while loading and firing.

Course. Bench rest or two-handed standing positions. Targets could be paper, resetting metallic targets, balloons, and other fun breakable targets (environmentally friendly materials).

Level 3: Muzzleloading Pistol Ongoing Shooting Sports Program

Purpose. Introduce and recruit Scouts into year-round shooting sports programs. Shooting programs could be held at a BSA facility or public or private commercial range or club.

Youth. Venturers and Sea Scouts

Pistols. Muzzleloading pistols, flint or percussion, single-barrel or revolver, in appropriate size for the shooter

Ammunition. Correct ammunition for the pistol being fired

Range. A BSA-approved range or public or private commercial range or club

Training. Three hours of instruction on loading and firing a muzzleloading pistol, as well as instruction on range rules and safety. Taught by an NMLRA instructor or National Camping School shooting sports director certified as an NRA/NMLRA muzzleloading pistol instructor or an NRA/NMLRA muzzleloading instructor.

Safety. Eye and hearing protection are required.

Range supervision. A certified NRA range safety officer is directly supervising all live fire on the range. Additionally, the instruction offered may be done by a currently certified National Camping School shooting sports director certified as an NRA/NMLRA muzzleloading pistol instructor, an NMLRA instructor, or an NRA/NMLRA certified muzzleloading pistol instructor. These must be two separate individuals.

Ratio. One NRA range safety officer per three shooters. One NRA or NMLRA muzzleloading pistol instructor per shooter while loading and firing.

Course. Appropriate targets based on desired award

Level 4: Muzzleloading Pistol Competitive Shooting Sports Program

Purpose. To promote competition among Venturers and Sea Scouts.

Youth. Venturers and Sea Scouts

Pistols. Muzzleloading pistols will meet the requirements for the conventional and international muzzleloading pistol shooting competitive programs.

Ammunition. Correct ammunition for the pistol being fired

Range. A BSA-approved range or public or private commercial range or club

Training. Basic muzzleloading instruction including the cleaning and maintenance of muzzleloading pistols. Taught by an NMLRA instructor or National Camping School shooting sports director certified as an NRA/NMLRA muzzleloading pistol instructor or an NRA/NMLRA muzzleloading pistol instructor.

Safety. Eye and hearing protection are required.

Range supervision. Range supervision will be based on the rules of the approved competition.

Course. Competitive rule book for the course of competition.

Level 5: Muzzleloading Pistol Marksmanship Instructor or Coach

Purpose. Venturers and Sea Scouts to take a leadership role in their crew or ship as an NMLRA instructor, NRA/NMLRA muzzleloading pistol instructor, or NMLRA range safety officer.

Youth. Venturers and Sea Scouts

Training. Successfully complete NMLRA instructor training or the NRA/NMLRA muzzleloading pistol instructor course.

Chapter 2: BSA Shooting Sports—A Wealth of Year-Round Opportunities

CUB SCOUT PROGRAMS

Cub Scout shooting sports programs may be conducted only on a district or council level. Archery and BB gun shooting are restricted to day camps, Cub Scout/Webelos Scout resident camps, council-managed family camping programs, or to council activities where there are properly trained supervisors and all standards for BSA shooting sports are enforced. Archery and BB gun shooting are not to be done at the pack level.

The use of pellet air rifles is restricted to Webelos Scouts in a BSA resident camp setting only.

All shooting ranges in the Cub Scout program must be supervised by a qualified range master who is at least 18 years of age and who meets the minimum requirements. See specific qualifications and training requirements for BB gun and archery range masters under “Shooting Sports Personnel Descriptions” in Chapter 1, and in Section V, “Cub Scout Shooting Sports.”

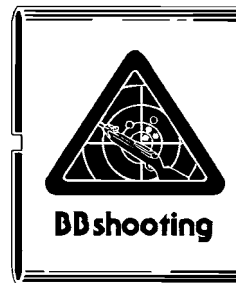
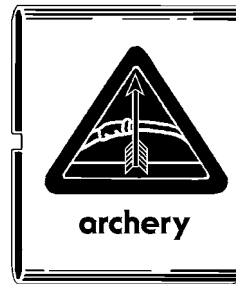

Opportunities

Cub Scout Shooting Sports Award. The Cub Scout Shooting Sports Award, No. 34216, may be awarded to a boy whenever he achieves a level of marksmanship or excellence. The range master, with other leaders of the camp or event, may determine special circumstances where a unique award might be useful. The award might be given for proficiency in shooting, best sportsmanship, or other appropriate achievement. The award is available from the National Distribution Center.

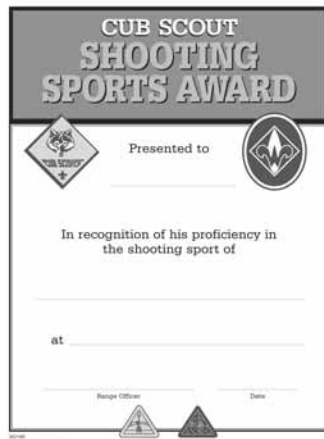

Belt loops and sports pins. Archery and BB Shooting belt loops and sports pins may be earned only through council- or district-sponsored programs. Quality camp programs will offer an archery shooting or BB gun shooting program that allows boys to meet the requirements for earning the belt loops. In a program where boys come for more than one day, councils should offer activities that meet the requirements for the Archery and BB Shooting sports pins. Dens and packs enjoy coming to council camps where they have a chance to earn belt loops and sports pins that cannot be earned at home.

BOY SCOUT AND VARSITY SCOUT PROGRAMS

Boy Scout shooting sports can take place at any council-approved property. This could include a BSA-approved range or a public or private commercial range or club. The council's camping reservation is as an ideal location for shooting sports. Here, safely designed ranges may be established for the long-term camping program. Under qualified leadership, Scouts, should be given a chance to participate in these skills year-round. Alert unit, district, and council leadership will discover community resources that will be available to units throughout the year. Local archery, angling, National Rifle Association, and sportsmen's groups will often provide facilities and resources.

Boy Scouts and Varsity Scouts can shoot small-bore rifle, shotgun, muzzleloading rifle, muzzleloading shotguns, and archery following the five levels of shooting described in Chapter 1 for the specific discipline.

Opportunities

There are many year-round shooting sport opportunities for Scouts to enjoy. Listed below are only a few of the programs available.

Merit badge programs:

- *Rifle Shooting* merit badge pamphlet, No. 35942. For requirements, see www.scouting.org/scoutsources/BoyScouts/AdvancementandAwards/MeritBadges/mb-RIFL.aspx.
- *Shotgun Shooting* merit badge pamphlet, No. 35948. For requirements, see www.scouting.org/scoutsources/boyscouts/advancementandawards/meritbadges/mb-ssho.aspx.
- *Archery* merit badge pamphlet, No. 35856. For requirements, see www.scouting.org/scoutsources/boyscouts/advancementandawards/meritbadges/mb-arch.aspx.

Summer camp programs. The BSA summer camp program offers a wide variety of shooting sport opportunities for Scouts. Contact your local council for more information on what the council's summer camp offers or check with other councils to see what programs they offer that may be different.

Hunter education. Contact your local department of natural resources for more information on hunter safety and education, or find information online at www.hunter-ed.com.

National Rifle Association Awards

NRA Outstanding Achievement Youth Award. This award recognizes NRA junior members who take an active part in shooting sports through individual participation and educational pursuits. The award is designed to increase awareness of the shooting sport activities available for youth. For more information, contact NRA Youth Programs or visit the website at www.nrahq.org/youth/achievement.asp.

Winchester/NRA Marksmanship Qualification Program. This is the perfect opportunity to enjoy year-round shooting while, at the same time, a Scout can earn awards for each level they reach. The courses of fire start at a level for the beginning shooter's skills, which means a Scout can earn the first rating of Pro-Marksman even if they are just learning to shoot. The ratings continue to advance to the more challenging skills through the intermediate levels (Marksman 1st Class, Sharpshooter, and Expert) to the nationally recognized skill level of Distinguished Expert. The levels of shooting can be earned in each of the different qualification courses. For more information, go to www.nrahq.org/education/training/marksmanship/index.asp.

National Rifle Association Postal Matches. A National Camp Postal Match program is available with instant recognition for participants in long-term summer camps. Immediate recognition is provided weekly to winners in each participating council camp. National recognition is provided to top scorers in each division (Junior, first-year camper; Senior, seasoned camper) in each participating camp and to overall top scorers. For additional information, contact the Competitions Division, National Rifle Association, 11250 Waples Mill Road, Fairfax, VA 22030. The website is www.nrahq.org/compete/dept-postal.asp.

National Rifle Association Youth Hunter Education Challenge. The website is www.nrahq.org/hunting/yhec/index.asp.

Sporting clay events. Sporting clays courses offer a wide variety of shots that simulate those found in hunting upland birds, waterfowl, and rabbits. Each sporting clay course is unique and presents a mix of close, midrange, and distant shots traveling at various speeds from several traps. Refer to the *Shotgun Shooting* merit badge book for more information.

Five-stand sporting clays. Scouts can test their skills in a modified five-stand environment.

VENTURING AND SEA SCOUT PROGRAMS

Venturers and Sea Scouts are allowed to shoot the same firearms as a Boy Scout and may also shoot rifles, pistols, and revolvers of any caliber or action. An exception is they may not shoot fully automatic firearms. Refer to "The Five Levels of Shooting Activities" in Chapter 1 to better understand what qualifications must be met for Venturing and Sea Scouting.

Opportunities

In addition to the opportunities offered for Boy Scouts, Venturers and Sea Scouts also have an opportunity to participate in the hunting experience. The Ranger Award is an excellent way to learn more about hunting education and safety.

BSA Shooting Sports Outstanding Achievement Award.

While working on the Ranger Shooting Sports elective, Venturers and Sea Scouts are to complete one of the following disciplines: air pistol, air rifle, archery, muzzleloading rifle, shotgun, or small-bore rifle. However, Venturers and Sea Scouts who go beyond the basic requirement and complete five of the six disciplines will earn the Venturing Shooting Sports Outstanding Achievement Award. This beautiful medal and certificate are sponsored by many companies and organizations in the shooting sports industry to recognize outstanding achievement in shooting sports. For more information, go to www.scouting.org.

Hunter education. Contact your local department of natural resources for more information on hunter safety and education, or find information online at www.hunter-ed.com.

National Rifle Association Awards

NRA Outstanding Achievement Youth Award. This award recognizes NRA junior members who take an active part in shooting sports through individual participation and educational pursuits. The award is designed to increase awareness of the shooting sport activities available for youth. For more information, contact NRA Youth Programs or visit the website at www.nrahq.org/youth/achievement.asp.

Winchester/NRA Marksmanship Qualification Program.

This is the perfect opportunity to enjoy year-round shooting while, at the same time, a Scout can earn awards for each level they reach. The courses of fire start at a level for the beginning shooter's skills, which means a Scout can earn the first rating of Pro-Marksman even if they are just learning to shoot. The ratings continue to advance to the more challenging skills through the intermediate levels (Marksman 1st Class, Sharpshooter, and Expert) to the nationally recognized skill level of Distinguished Expert. The levels of shooting can be earned in each of the different qualification courses. For more information, go to www.nrahq.org/education/training/marksmanship/index.asp.

National Rifle Association Postal Matches. A National Camp Postal Match program is available with instant recognition for participants in long-term summer camps. Immediate recognition is provided weekly to winners in each participating council camp. National recognition is provided to top scorers in each division (Junior, first-year camper; Senior, seasoned camper) in each participating camp and to overall top scorers. For additional information, contact the Competitions Division, National Rifle Association, 11250 Waples Mill Road, Fairfax, VA 22030. The website is www.nrahq.org/compete/dept-postal.asp.

National Rifle Association Youth Hunter Education Challenge. The website is www.nrahq.org/hunting/yhec/index.asp.

Sporting clay events. Sporting clays courses offer a wide variety of shots that simulate those found in hunting upland birds, waterfowl, and rabbits. Each sporting clay course is unique and presents a mix of close, midrange, and distant shots traveling at various speeds from several traps. Refer to the *Shotgun Shooting* merit badge book for more information.

Five-stand sporting clays. Shooters can test their skills in a modified five-stand environment.

Modified five-stand sporting clays. Shooters can test their skills in a modified five-stand environment.

Cowboy action shooting events. For information, contact the Great Salt Lake Council at www.gslc-bsa.org or call Leo Monsen 801-582-3663.

Training Programs for Adults and Youth

See Section IV on training in this book.

Council Shooting Sports Committees

Your local council's shooting sports committee provides an opportunity to become involved in the shooting sports program on a year-round basis. Refer to Chapter 4 for more information on council shooting sports committees.

Brownell's/NRA National Youth Shooting Sports Ambassadors

Sponsored by Brownell's, the program offers participants a wide array of benefits, ranging from cash awards and travel opportunities to meeting national shooting celebrities. For more information on the Brownell's/NRA National Youth Shooting Sports Ambassador Program, contact Claudia Olsen by email at colsen@nrahq.org or by phone at 703-267-1597.

Chapter 3: Merit Badge Counselors

Shooting Sports Merit Badge Counselor Requirements and Registration

To qualify as a shooting sports merit badge counselor, a volunteer must:

- Register annually with the Boy Scouts of America.
- Be at least 18 years old.
- Be of good character.
- Be proficient in the merit badge subject by vocation, avocation, or special training.
- Rifle Shooting and Shotgun Shooting—The merit badge counselor must take responsibility to assure that all instruction involving the handling of firearms or live ammunition must be supervised by a certified National Camping School (NCS) shooting sports director, National Rifle Association (NRA) rifle instructor, or NRA coach for the Rifle Shooting merit badge or an NRA shotgun instructor or coach for the Shotgun Shooting merit badge. That involving muzzleloaders must be supervised by an NCS shooting sports director or NRA/NMLRA-certified muzzleloading firearms instructor for the merit badge discipline. Shooting must be supervised by an NRA certified range safety officer (RSO). If instruction and shooting are to occur at the same time, the RSO and qualified NRA instructor both must be present. The RSO and NRA instructor may not be the same person. Note that commercial shooting ranges may provide RSOs. In approving merit badge counselors, the local council advancement committee has the authority to establish a minimum, reasonable level of skills and education for the counselor of a given merit badge. For example, NRA certification could be established as a council standard for approving counselors for the Rifle Shooting or Shotgun Shooting merit badges. (Reference: *Guide to Advancement*)
- Be able to work with Scout-age youth.
- Be currently trained in BSA Youth Protection.

To register with the Boy Scouts of America, a potential merit badge counselor must complete the BSA's Adult Application form, No. 524-501; available in Spanish as No. 524-502, and submit it along with the BSA Merit Badge Counselor Information form, No. 34405 (available online at www.scouting.org), to the BSA local council office. Renewal of this registration annually is necessary to continue as a merit badge counselor.

The Boy Scouts of America requires that merit badge counselors take BSA Youth Protection training. This program addresses strategies for personal safety awareness for youth as well as adults. BSA Youth Protection policies include:

- Two-deep leadership
- No one-on-one contact
- Respecting privacy
- Separate accommodations
- Reporting problems

The BSA Youth Protection policies have been adopted primarily for the protection of our youth members. BSA Youth Protection training is available online at www.scouting.org.

Summer Camp Merit Badge Counselors

The same qualifications and rules apply to counselors for council summer camp merit badge programs. All counselors must be 18 years or older; however, qualified camp staff members under age 18 may assist the merit badge counselor. (These assistants are not qualified to sign off on a Scout's blue card, nor may they certify the Scout's completion of a merit badge.) Each counselor must maintain the exact standards as outlined in the merit badge requirements—nothing deleted; nothing added.

Partial completion of merit badges at summer camp should be credited to a Scout on the Application for Merit Badge (blue card) and given to his Scoutmaster at the end of the week.

Resources for Merit Badge Counselors

- BSA Shotgun Shooting Merit Badge Teaching Guide. Refer to Appendix 1.
- BSA Rifle Shooting Merit Badge Teaching Guide. Refer to Appendix 2.
- Adult Application. This adult registration form consists of a cover sheet, an instruction and information sheet, and a four-part registration form. It is used for all BSA volunteers, including merit badge counselors. Completion of the form is required of all merit badge counselors regardless of whether they are already a registered Scouter, and for each position the volunteer would like to serve in. The form is available online at www.scouting.org.
- *Guide to Advancement*, No. 33088. This is the handbook for Scouters responsible for advancement at the council, district, and unit levels. It contains the current BSA advancement policies, procedures, rules, and regulations as well as other information.
- Application for Merit Badge (blue card), No. 34124. This three-panel, blue, wallet-size card shows that the Scout has permission from his Scoutmaster to start working on a particular merit badge, records his progress, and when completed, provides a separate record for the Scout, the counselor, and the unit.
- *Boy Scout Handbook*, No. 34554. This is the critical document for a Scout, providing the basic information for all facets of Scouting, including a chapter on the merit badge program.
- *Boy Scout Requirements*, No. 33216. Updated yearly, this book contains the complete, official requirements for all BSA merit badges, ranks, and special awards. Requirements in this publication may be more current than the merit badge pamphlet; therefore, *Boy Scout Requirements* takes precedence.
- A Guide for Merit Badge Counseling, No. 34532. This folder gives potential merit badge counselors an introduction to the advancement program and the merit badge counselor's role. It also lists all the current merit badge subjects.
- Merit Badge Counselor Information form, No. 34405. When attached to the Adult Application, this document specifies the merit badge subjects a counselor wants to coach and secures the counselor's agreement to follow the merit badge requirements and BSA policies. This form is available online at www.scouting.org/filestore/pdf/34405.pdf.

- Merit badge pamphlet series. The merit badge pamphlets are written for Scout-age boys. The information presented in the pamphlet will help the counselor understand what the Scout may be studying and the level of learning expected by the Boy Scouts of America. The pamphlets may also contain suggestions for projects or demonstrations required to earn the merit badge. At times, the requirements presented in the merit badge pamphlet may not match those in the current edition of the *Boy Scout Requirements* book. The *Boy Scout Requirements* criteria take precedence. Once a Scout has started working on a merit badge, he may continue with the requirements

in effect when he started. He is not required to meet newly introduced changes unless the national office places a specific timeline on the implementation of new requirements.

Shooting sports merit badge pamphlets include:

—*Rifle Shooting*, No. 35942

—*Shotgun Shooting*, No. 35948

—*Archery*, No. 35856

- *Scoutmaster Handbook*, No. 33009. As the Scoutmaster's primary guide, the *Scoutmaster Handbook* contains a section on the merit badge program that includes tips on recruiting counselors and other advancement resources.

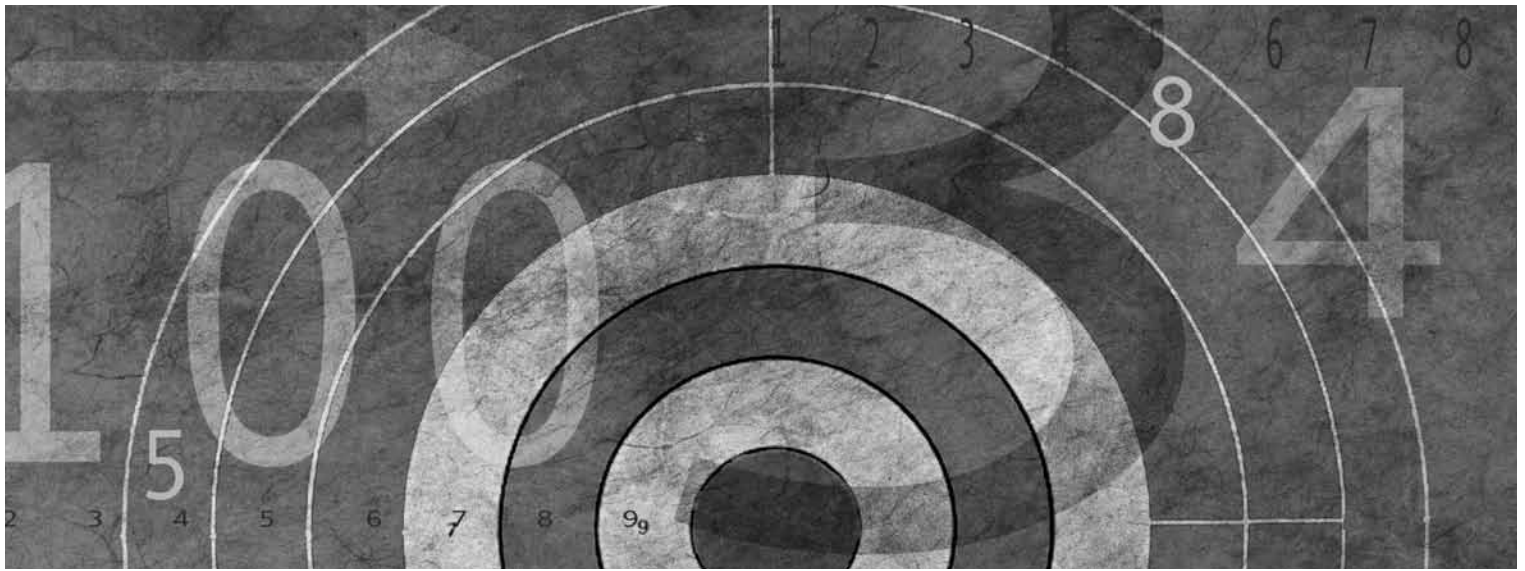

SECTION II BEYOND THE UNIT LEVEL

In addition to Section I, the information contained in Section II through Section V is necessary for individuals who are involved in the shooting sports programs on a higher level. This includes NRA instructors, NRA range safety officers, National Camping School shooting sports directors, council shooting sports chairs, council shooting sports committee members, council professionals, camping committees, camp rangers, and all others who are involved in organizing and assisting in the delivery of the various shooting events throughout the year.

Chapter 4: Council Shooting Sports Committees

Organization

It is strongly recommended that all Boy Scout councils have a shooting sports committee. The purpose of the committee is to manage and provide resources to the council, the camping committee, and the council camps for all activities involving shooting sports whether during summer camps or during year-round shooting opportunities. All shooting sports activities should be coordinated through the shooting sports committee to verify that a safe and responsible program is planned and conducted by properly trained and currently certified personnel.

Responsibilities

Council Shooting Sports Committee Chairman/Coordinator

The organization should be composed of a shooting sports chairman/coordinator with a working understanding of summer camp and off-season programs, and the knowledge, skills, and attitude to organize and run safe ranges and shooting sports programs. The chairman is appointed by the council president or his or her designee. The committee shall report to the council vice president for program, the camping committee chair, the health and safety chair, or the council risk management committee chair as appropriate for the individual council organization.

- An age of 21 years or older and National Camping School certification as a shooting sports director is recommended.
- National Rifle Association certified instructor for one or more of the appropriate disciplines are recommended.
- Current NRA range safety officer rating is recommended.
- Certified Level 1 archery instructor is recommended.
- Schedules meetings, preferably on a monthly basis, of the shooting sports committee and assigns individual committee member responsibilities. Keeps the council executive or his designee informed of committee actions.
- Advises the summer camp National Camping School shooting sports director in ensuring all shooting sports requirements in the national standards are being met.
- Accompanies the area camp visitation team on the tour of the shooting sports facilities and answers any questions it has relating to compliance with the national standards.
- If requested by the Scout executive, his/her representative or the camp director submits an evaluation on the National Camping School shooting sports director and staff and makes a recommendation on their employment in the future.
- Ensures adequate training sessions are conducted annually to certify BB gun and archery instructors for Cub Scout day camp, field day, or other council or district activities.
- Assists the camp director in identifying and recruiting the shooting sports director for summer camp in the event of illness or emergency. Serves in this capacity as requested or appointed by the camp director.

- Ensures compliance with all BSA/NRA shooting sports standards for Cub Scout, Boy Scout, Venturing, and Sea Scout programs on and off council property.
- Maintains a current inventory of all council shooting sports equipment and supplies and provides copies to all interested persons.
- Compiles on a timely basis a list of equipment and supplies needed for summer camp and year-round operation and submits it to the council executive or his/her designee for procurement.
- Assists in developing and continuing review of range safety standard operating procedures.
- Schedules range maintenance to ensure all shooting sports facilities and equipment meet BSA/NRA standards prior to all uses.
- Identifies adult Scouters to help in year-round shooting sports programs and ensures they hold the appropriate current NRA certification.
- Maintains a current list of individuals with NRA certifications and National Camping School training.
- Recommends fee structures for year-round use of shooting sports facilities and equipment.
- Serves as a resource for shooting sports merit badges, unit shooting sports activities, or other council or district shooting sports events.
- Makes recommendations to the Scout executive or his/her designee on procurement of guns, archery equipment, and supplies.
- Fundraisers. The chairman, working with the council executive, should apply to the available grant programs in order to fulfill current and future shooting sport needs. Grant programs are available through the National Rifle Association, Winchester, Friends of the NRA local banquets, the National Alliance for the Development of Archery, and local gun and sportsman clubs, to name a few. Keeping track of and having specific tasks for the funds makes it easier to receive and apply over the years.

Committee Members

- Assist the council shooting sports committee chairman in performing the duties of the shooting sports committee.
- Committee members are nominated by the chairman and/or other committee members, and are approved by the council president or his/her designee.
- NRA certified instructor in at least one of the NRA disciplines is recommended.
- NRA range safety officer certification is recommended.
- Shooting sports committee members may be appointed to the council committee at large.

Chapter 5: Range Operation

In planning any shooting sports activity, consideration must be given to what equipment is required for that specific shooting discipline and venue. Care must be taken to provide, or arrange for, the safety of non-participants as well as personal protection of the shooter. This chapter examines some of the items that should be considered.

Pointing any type of firearm or simulated firearm at any individual is unauthorized. Scout units (other than Cub Scouts and Webelos Scouts) may plan or participate in paintball, laser tag, or similar events where participants shoot at targets that are neither living nor human representations. Units with council approval may participate in formally organized historical reenactment events where firearms are used and intentionally aimed over the heads of the reenactment participants. Paintball guns, laser guns, or similar devices may be used in target shooting with council approval and following the Sweet 16 of BSA Safety. Council approval means the approval of the Scout executive or his or her designee on a tour plan specifically outlining details of the event. (However, law enforcement departments and agencies using firearms in standard officer/agent training may use their training agenda when accompanied with appropriate safety equipment in the Law Enforcement Exploring program.) Reference the *Guide to Safe Scouting*.

General Equipment Common to All Scouting Program Levels and Shooting Disciplines

Range safety flag. As an indicator that the range is active, the range safety flag is to be displayed on a flagpole in a prominent place visible to approaching spectators and shooters. Each range should have its own flagpole. It is recommended the flag be made of a bright red material approximately 48-by-36 inches in size. (This flag can be purchased from the NRA's online store.) The flag should be removed at the end of the shooting session.

Eye and hearing protection. Each shooter *must* wear hearing and eye protection appropriate for the shooting discipline. Spectators in the immediate, designated area must also wear protection.

This personal safety equipment may be provided by the shooting event or furnished by the individual participant. If provided by the individual, the range safety officer or NRA instructor should verify that eyeglasses have adequate lens area to offer protection. Hearing protection must fit properly.

If eye and hearing protection is furnished by the event organizers, an assortment of sizes should be on hand to ensure proper fit. Youth sizes are available from many vendors of safety glasses. Earmuffs might be preferable to earplugs. When exchanging common-use items, be sure to clean and disinfect them before wearing them. Earplugs are NOT to be exchanged.

Empty-chamber indicator. An added safety measure while transporting or storing, or while the firearm is unattended, a visual empty-chamber indicator should be installed. Several commercial models are available which when installed in the chamber displays a brightly colored flag readily visible.

A simple alternate method is to use a piece of high-visibility, heavy monofilament trimmer line, cut approximately 12 inches longer than the barrel of the firearm. When inserted through the barrel, approximately 6 inches of line is visible at both the muzzle and the breech.

Ammunition control. A simple ammunition block, with an appropriate number of 15/64-inch-diameter holes drilled in a pattern of a multiple of five, should be used to control the ammunition being dispensed to the shooters. Range personnel will load the blocks from the bulk ammunition storage, and issue only the number of rounds being fired for a given relay.

A similar block should be provided for the shotgun range, with holes to match the gauge of the shotshell being used.

Comfort items.

- Sling. A leather or web sling will aid shooters in the prone, kneeling, and sitting positions. They are easily adjustable to each shooter and will steady the shooter.
- Prone mat. A padded shooting mat of approximately 30-by-60 inches should be provided at each prone shooting position.
- Kneeling roll. A piece of carpet remnant approximately 8 inches wide and tightly rolled and bound to approximately 4 to 6 inches in diameter may be placed under the ankle of the down leg when shooting in the kneeling position.

First-aid kit. A first-aid kit must be readily accessible to the range or classroom. It should be well stocked and include items appropriate for potential injuries unique to the specific shooting sports venue. A medical log must be included in each kit. Details of each transaction should be recorded. Expended materials should be replaced before the next activity. Annually, a qualified medical technician should inventory the contents and replace out-of-date items.

Emergency communications device. The procedure to summon emergency help must be considered during planning and be verified before the start of the event. Is there a landline phone nearby? Does a cell phone have active coverage in this area? Is there a need for another two-way communications device?

Make sure you research the phone numbers for emergency medical services. Also, do your homework and determine what you will say to the emergency operator regarding your exact location. And if you are on a large or gated facility, you should have someone meet EMS at the entrance, and other areas when needed, to guide the emergency responders or give them directions to the subject.

Range and Shooting Equipment Appropriate to Each Scouting Program Level



Cub Scout BB Gun

Note: No firearms or handguns of any type are permitted in the Cub Scout program.

BB gun or air rifle. Only a smoothbore, spring-type air gun propelling a coated steel ball projectile commonly known as a “BB” may be used. It may be desirable to shorten the stock on a few BB guns to accommodate smaller Cub Scouts.

Target. The target line is usually set five meters (16.5 feet) from the firing line. The TQ-40 and AR-4 are the common targets for this distance. Paper plates or aluminum pie tins are also popular targets for Cub Scouts.

The use of pellet air rifles is restricted to Webelos Scouts in a resident camp setting and qualifies when in compliance with the following:

- The air rifle pellet gun range meets or exceeds BSA and NRA recommendations and appropriate BSA Engineering Service design standards. The range is on council-owned property.
- All rifles in good repair are provided. All rifles used in BSA shooting sports have a trigger pull in excess of 2.5 pounds and are tested with a 2.5-pound weight or scale at least once a week while in use. If any trigger mechanism fails, the air rifle is immediately removed from service. Documentation of the tests is maintained.
- All air rifles (CO₂, pump, break barrel, etc.) are limited to single-shot designated for target shooting, velocity of 500 to 540 feet per second, and energy levels not to exceed 7.5 joules.
- Safe, separate, and locked storage (can be the same building) is provided for pellet guns, pellets, and CO₂ cylinders and bulk tanks.
- Air rifle propellant is limited to CO₂ cylinders or air compressor/scuba tanks. Refilling is conducted by qualified adults with appropriate controls. If scuba tanks are used, each tank must be visually inspected annually and hydrostatically tested every five years by a qualified technician.



Cub Scout Archery

Bows. A light-draw-weight (15- to 20-pound), 54-inch, take-down, recurve bow is recommended for Cub Scouts because the bow will fit the many archers who may have different lengths of draw. The bow should be equipped with an arrow rest in good condition and a proper-length, well-served, 10-strand string, with a properly placed nock locator.

Always inspect the bow for cracks, splinters, and condition of the bow string and serving.

The Mathews-brand Genesis bow is popular in youth programs because it provides all the advantages of a compound bow, but with a steady draw weight throughout the length of the pull.

True compound bows are not recommended at this level because they must be set up to fit each individual archer.

Arrows. Care should be taken to inspect arrows before use.

- Shaft material. Wood arrows are light but susceptible to warping and splintering. Fiberglass arrows are heavier and more durable, and will last several seasons. Aluminum arrows are light and shoot true, but cannot be repaired if bent or kinked. Carbon fiber arrows are lighter, stronger, and preferred by most competitive archers.
- Length. An appropriate length arrow for Cub Scout-age youth will be approximately 24 to 26 inches. Care must be taken to avoid shooting an arrow that is too short for the archer.
- Point. Arrows must be fitted with target points. No field points or broadheads.
- Nock. The nock should fit the serving of the bow being used. The arrow should not fall from the string if the nock opening is correct.
- Fletching/vanes. Either one may be used; however, plastic vanes will provide longer service with young shooters.

Personal protection.

- Quiver. For each archer, either a personal side quiver or a ground quiver must be provided to store arrows during shooting.
- Finger protection. Each archer must wear a finger tab or glove unless there are “no gloves” on the string.
- Arm protection. Each archer *must* wear an arm guard on the bow arm. Arm guards may be obtained in junior sizes for small arms.

Targets. For Cub Scouts, it is recommended that large-diameter target mats and faces be used to ensure success and to reduce the number of lost arrows. Ethafoam mats are commercially available in 48-inch, 36-inch, and 32-inch diameters, with five-color target faces to match.

Set the target line at no more than 10 yards in front of the shooting line, adding to the success of young archers. The mat should also be mounted relatively low to the ground to make it easier to extract arrows from the target.



Boy Scout and Varsity Scout Air Rifle

BB gun. A smoothbore, spring-type air gun propelling a coated steel ball projectile commonly known as a “BB.”

BB gun target. The target line is usually set five meters (16.5 feet) from the firing line. The TQ-40 and AR-4 are the common targets for this distance. Paper plates or aluminum pie tins are also popular targets for training new shooters.

Air rifle. Spring-piston or pneumatic (single-stroke, multi-pump, air, or CO₂ gas) air rifles with rifled barrels bored for .177-caliber skirted pellets may be used.

Air rifle target. The target line is usually set at 10 meters (33 feet) from the firing line. The TQ-18 and AR-5 are the common targets for this distance. Paper plates or aluminum pie tins are also popular targets for training new shooters.

Boy Scout and Varsity Scout Rifle

.22-caliber rifle. Breech-loading, single-shot, bolt-action, .22-caliber short or long rifle rimfire cartridges, or a repeater-type bolt-action .22-caliber rifle with a clip-fed magazine. (Tubular magazines are **not** allowed.) The trigger pull must test to a minimum of 3 pounds of trigger pull, without exception.

Ammunition. Current-manufacture .22-caliber short, long, or long rifle. (.22 WMR may **not** be used.)

Sights.

- Open sights found on most light rifles are limited to elevation adjustment.
- Aperture (peep) sights are fully adjustable and have an easy-to-learn sight picture. The easy adjustment will aid in meeting the merit badge requirements and in qualification shooting.
- Optical (telescopic) sights are also fully adjustable, but care must be taken to provide an appropriate scope for the shooting distance. Target turrets (hand adjustable) are recommended when the rifle will be used by multiple shooters, and for meeting the merit badge requirements.

Targets. TQ-1 and A-17 targets are recommended at 50 feet. The A-23 is a popular small-bore rifle target at 50 yards.

Boy Scout and Varsity Scout Pistol

Note: No handguns are permitted in the Boy Scout and Varsity Scout programs.

Boy Scout and Varsity Scout Shotgun

Shotgun. Modern sporting shotguns of any gauge may be used. However, experience shows that beginning shooters will be more successful with a 20- or 12-gauge shotgun, putting more shot to the target. The semiautomatic shotgun will produce less felt recoil, thus making the shooter more comfortable.

Chokes. At the muzzle end of the shotgun is a “choke.” Just as the nozzle on a garden hose determines the width of a jet of water, the choke affects the spread pattern of the pellets exiting from the barrel. There are four main chokes: skeet, IC (improved cylinder), M (modified), and F (full). For camp use, skeet and IC are recommended. If these are not available, modified would be the best choice.

Ammunition. Current-manufacture shotshells of the appropriate gauge containing No. 7½ to No. 9 shot. A shot size larger than 7½ is not to be used. Reloads may not be used in BSA shooting sports programs.

Trap/thrower. Hand throwers, manual traps, or automatic traps may be used. Care should be taken to match the target speed and flight path to the shooter’s ability. Always refer to the manufacturer’s operations and safety instructions before operating this equipment.

Trap location. For new shooters and merit badge qualification, the trap should be set to present a straight-away, rising target, at a reasonable speed. Trap systems on trap and skeet fields and on sporting clays courses will provide the shooter with some challenging presentations as skills are mastered.

Boy Scout and Varsity Scout Muzzleloading Firearms

Because of the historical significance of muzzleloading firearms, Scouts are encouraged to learn to safely load and shoot a muzzleloader. On the range, each Scout must be under the direct supervision (one on one) of a currently NRA or NMLRA certified muzzleloading instructor when loading and firing the muzzleloader.

Muzzleloading rifle. Only recently manufactured (or assembled from a kit) percussion cap muzzleloading rifles no greater than .58-caliber are to be used. Flintlock rifles are **not** approved for use by Boy Scouts or Varsity Scouts. All muzzleloading rifles are subject to safety inspection by the instructor or range officer. Rifles made from kits must be checked by a qualified gunsmith.

Propellant. Only a commercially manufactured, sporting-grade black powder or black powder substitute offered for sale by a reputable firm should be used in muzzleloading rifles.

Accessories.

- **Ramrod.** The ramrod is used to seat the patch and ball. It is usually mounted in the fore-end of the stock, just beneath the barrel. It is recommended that a more durable work rod be obtained for use on the range. The first time a new rod is used, it should be inserted into the charged barrel all the way down to the ball. A permanent mark should be scribed on the rod at the muzzle. This will be an indicator of a charge or ball remaining in the barrel.
- **Powder flask and powder measure.** Propellant shall be transferred from the original bulk container to a brass or plastic powder flask to be taken to the range. It shall then be poured into the powder measure before pouring into the barrel.
- **Short starter.** This tool allows the shooter to first get the ball and patch just started into the muzzle, and second to drive the ball a short distance down the barrel, before using the ramrod to seat them against the powder charge.
- **Nipple wrench and nipple pick.** The nipple wrench is a simple tool used to remove the cap nipple should it become fouled. A nipple pick is a stiff wire that is used to clear debris in the nipple orifice (flash channel).
- **Capper.** Percussion caps are packaged 100 per tin. The capper allows the caps to be dispensed one at a time right onto the nipple.
- **Patch puller, ball puller.** These tools fit onto the end of the ramrod to remove the ball or patch from down in the barrel. Care must be taken when using these items.
- **CO₂ ball discharger.** This tool has a fitting to fit onto the nipple and has a small CO₂ cartridge to provide pressure to blow a patch and ball out the muzzle of the rifle. Always point the muzzleloader in a safe direction when using this device.
- **Loading bench.** Many Scout ranges are equipped with a loading bench that provides a stable and easy-to-reach platform for the muzzleloading rifle during the loading process.

Muzzleloading pistol. (No handguns are permitted in the Boy Scout and Varsity Scout programs.)

Muzzleloading shotgun. Only recently manufactured (or assembled from a kit) percussion cap muzzleloading shotguns no smaller than 20-gauge or greater than 10-gauge are to be used. Flintlock shotguns are **not** approved.

Propellant. Only a commercially manufactured, sporting-grade black powder or black powder substitute offered for sale by a reputable firm should be used in muzzleloading shotguns. For new shooters, the amount of propellant in grains should be at the minimum of the gun manufacturer's recommended load range.

Accessories.

- **Ramrod.** The ramrod is used to seat the patch and shot. It is usually mounted in the fore-end of the stock, just beneath the barrel. It is recommended that a more durable work rod be obtained for use on the range. The first time a new rod is used, it should be inserted into the charged barrel all the way down to the ball. A permanent mark should be scribed on the rod at the muzzle. This will be an indicator of a charge or shot remaining in the barrel.
- **Powder flask and powder measure.** Propellant shall be transferred from the original bulk container to a brass or plastic powder flask to be taken to the range. It shall then

be poured into the powder measure before pouring into the barrel.

- **Shot measure.** A small cup with a handle that allows the shooter to measure the exact amount of shot and then pour it directly into the barrel.
- **Nipple wrench and nipple pick.** The nipple wrench is a simple tool used to remove the cap nipple should it become fouled. A nipple pick is a stiff wire that is used to clear debris in the nipple orifice (flash channel).
- **Capper.** Percussion caps are packaged 100 per tin. The capper allows the caps to be dispensed one at a time right onto the nipple.
- **Patch puller, wad puller.** These tools fit onto the end of the ramrod to remove the wad or patch from down in the barrel. Care must be taken when using these items.
- **CO₂ ball discharger.** This tool has a fitting to fit onto the nipple and has a small CO₂ cartridge to provide pressure to blow a patch and shot out the muzzle of the shotgun. Always point the muzzleloading shotgun in a safe direction when using this device.
- **Loading bench.** Many Scout ranges are equipped with a loading bench that provides a stable and easy-to-reach platform for the muzzleloading shotgun during the loading process.

Boy Scout and Varsity Scout Archery

Bows. Light-draw-weight (20- and 25-pound), 62-inch and 66-inch, take-down, recurve bows are recommended for Boy Scouts because the bow will fit the many archers who may have different lengths of draw. The bow should be equipped with an arrow rest in good condition and with a proper-length, well-served, 10-strand string with a properly placed nock locator.

Always inspect the bow for cracks and splinters, and the condition of the bowstring and serving.

The Mathews-brand Genesis bow is popular in youth programs because it provides all the advantages of a compound bow but with a steady draw weight throughout the length of the pull.

True compound bows are not recommended at this level because they must be set up to fit each individual archer.

Arrows. Care should be taken to inspect arrows before use.

- **Shaft material.** Wood arrows are light but susceptible to warping and splintering. Fiberglass arrows are heavier and more durable, and will last several seasons. Aluminum arrows are light and shoot true, but cannot be repaired if bent or kinked. Carbon fiber arrows are lighter, stronger, and preferred by most competitive archers.
- **Length.** An appropriate length arrow for Boy Scout-age youth will be approximately 26 to 30 inches. Care must be taken to avoid shooting an arrow that is too short for the archer.
- **Point.** Arrows must be fitted with target points. No field points or broadheads.
- **Nock.** The nock should fit the serving of the bow being used. The arrow should not fall from the string if the nock opening is correct.
- **Fletching/vanes.** Either may be used; however, plastic vanes will provide longer service with young shooters.

Personal protection.

- Quiver. For each archer, either a personal side quiver or a ground quiver must be provided to store arrows during shooting.
- Finger protection. Each archer must wear a finger tab or glove unless there are “no gloves” on the string.
- Arm protection. Each archer *must* wear an arm guard on the bow arm. Arm guards may be obtained in several sizes and configurations.

Sights. As the fundamentals of archery are learned, it is recommended that sights be added to the bow. Least expensive may be a simple quilter’s pin affixed at the sight window by foam tape applied to the back of the handle.

Relatively inexpensive commercial target sights may be added to the bow, which will be a tremendous aid to the shooter either for qualifying or competition.

Targets. For Boy Scouts, it is recommended that large-diameter target mats and faces be used to ensure success and to reduce the number of passed arrows. Ethafoam mats are commercially available in 48-, 36-, and 32-inch diameters with five-color target faces to match. The mat should be mounted on a stable tripod with the center of the target approximately 48 inches high.

One optional qualification round for the Archery merit badge requires a 32-inch, five-color target face 15 yards from the shooting line. See the *Archery* merit badge book for details of the various rounds.



Venturing and Sea Scout Air Rifle

BB gun. A smoothbore, spring-type air gun propelling a coated steel ball projectile commonly known as a “BB.”

BB gun target. The target line is usually set five meters (16.5 feet) from the firing line. The TQ-40 and AR-4 are the common targets for this distance. Paper plates or aluminum pie tins are also popular targets for training new shooters.

Air rifle. Spring-piston or pneumatic (single-stroke, multi-pump, air, or CO₂ gas) air rifles with rifled barrels bored for .177-caliber skirted pellets may be used.

Air rifle target. The target line is usually set at 10 meters (33 feet) from the firing line. The TQ-18 and AR-5 are the common targets for this distance. Paper plates or aluminum pie tins are also popular targets for training new shooters.

Venturing and Sea Scout Rifle

Small-bore and centerfire rifle. Venturers and Sea Scouts may shoot rifles of any caliber.

Sights.

- Open sights found on most light rifles are limited to elevation adjustment.
- Aperture (peep) sights are fully adjustable and have an easy-to-learn sight picture. The easy adjustment will aid in meeting the merit badge requirements and in qualification shooting.
- Optical (telescopic) sights are also fully adjustable, but care must be taken to provide an appropriate scope for the shooting distance. Target turrets (hand adjustable) are recommended when the rifle will be used by multiple shooters.

Targets. TQ-1, TQ-5, and A-17 targets are recommended at 50 feet. The A-23 is a popular small-bore rifle target at 50 yards, and the A-25 is sized for 100 yards.

Metallic silhouette is becoming a popular target discipline at many clubs and ranges.

Pointing any type of firearm or simulated firearm at any individual is unauthorized. Scout units (other than Cub Scouts and Webelos Scouts) may plan or participate in paintball, laser tag, or similar events where participants shoot at targets that are neither living nor human representations. Units with council approval may participate in formally organized historical reenactment events where firearms are used and intentionally aimed over the heads of the reenactment participants. Paintball guns, laser guns, or similar devices may be used in target shooting with council approval and following the Sweet 16 of BSA Safety. Council approval means the approval of the Scout executive or his or her designee on a tour plan specifically outlining details of the event. (However, law enforcement departments and agencies using firearms in standard officer/agent training may use their training agenda when accompanied with appropriate safety equipment in the Law Enforcement Exploring program.) Reference the *Guide to Safe Scouting*.

Venturing and Sea Scout Pistol

Semiautomatic pistols and revolvers. Venturers and Sea Scouts may shoot handguns of any caliber or action except fully automatic.

Sights. Open sights may be fixed or fully adjustable. Optical (telescopic) sights are also fully adjustable, but care must be taken to provide an appropriate scope for the shooting distance. Laser sights have become extremely popular as a training aid for pistol shooting; however, they may not be permitted for certain qualification programs.

Targets. A 9-inch paper plate is recommended for training new shooters at 15 feet. The TQ-6, slow fire, and TQ-7 rapid-fire targets are recommended at 25 feet. B-2, slow-fire, and B-3, timed and rapid-fire are popular pistol targets at 50 feet. The B16, slow-fire, and B-8, timed and rapid-fire, targets are sized for 25 yards.

Metallic silhouette is also becoming a popular shooting discipline at many clubs and ranges.

Venturing and Sea Scout Shotgun

Shotgun. Modern sporting shotguns of any gauge may be used. However, experience shows that beginning shooters will be more successful with a 20- or 12-gauge shotgun, putting more shot to the target. The semiautomatic shotgun will produce less felt recoil, thus making the shooter more comfortable.

Chokes. At the muzzle end of the shotgun is a “choke.” Just as the nozzle on a garden hose determines the width of a jet of water, the choke affects the spread pattern of the pellets exiting from the barrel. There are four main chokes: skeet, IC (improved cylinder), M (modified), and F (full). For camp use, skeet and IC are recommended. If these are not available, modified would be the best choice.

Ammunition. Current-manufacture shotshells of the appropriate gauge containing No. 7½ to No. 9 shot. A shot size larger than 7½ is not to be used.

Trap/thrower. Hand throwers, manual traps, or automatic traps may be used. Care should be taken to match the target speed and flight path to the shooter’s ability. Always refer to the manufacturer’s operations and safety instructions before operating this equipment.

Trap location. For new shooters and merit badge qualification, the trap should be set to present a straight-away, rising target, at a reasonable speed. Trap systems on trap and skeet fields and on sporting clays courses will provide the shooter with some challenging presentations as skills are mastered.

Venturing and Sea Scout Muzzleloading Firearms

Because of the historical significance of muzzleloading firearms, Venturers and Sea Scouts are encouraged to learn to safely load and shoot a muzzleloader. On the range, each Venturer must be under the direct supervision (one on one) of a currently certified NRA or NMLRA muzzleloading instructor when loading and firing the muzzleloader.

Muzzleloading rifle or pistol. Recently manufactured (or assembled from a kit) percussion cap or flintlock muzzleloading rifles and pistols of any caliber may be used. All muzzleloading rifles and pistols are subject to safety inspection by the instructor or range officer. Rifles and pistols made from kits must be checked by a qualified gunsmith.

Propellant. Only a commercially manufactured, sporting-grade black powder or black powder substitute offered for sale by a reputable firm should be used in muzzleloading rifles or pistols.

Accessories.

- **Ramrod.** The ramrod is used to seat the patch and ball. It is usually mounted in the fore-end of the stock, just beneath the barrel. It is recommended that a more durable work rod be obtained for use on the range. The first time a new rod is used, it should be inserted into the charged barrel all the way down to the ball. A permanent mark should be scribed on the rod at the muzzle. This will be an indicator of a charge or ball remaining in the barrel.

- **Powder flask and powder measure.** Propellant shall be transferred from the original bulk container to a brass or plastic powder flask to be taken to the range. It shall then be poured into the powder measure before pouring into the barrel.
- **Short starter.** This tool allows the shooter to first get the ball and patch just started into the muzzle, and second to drive the ball a short distance down the barrel, before using the ramrod to seat them against the powder charge.
- **Nipple wrench and nipple pick.** The nipple wrench is a simple tool used to remove the cap nipple should it become fouled. A nipple pick is a stiff wire that is used to clear debris in the nipple orifice (flash channel).
- **Capper.** Percussion caps are packaged 100 per tin. The capper allows the caps to be dispensed one at a time right onto the nipple.
- **Patch puller, ball puller.** These tools fit onto the end of the ramrod to remove the ball or patch from down in the barrel. Care must be taken when using these items.
- **CO₂ ball discharger.** This tool has a fitting to fit onto the nipple and has a small CO₂ cartridge to provide pressure to blow a patch and ball out the muzzle of the gun. Always point the muzzleloader in a safe direction when using this device.
- **Loading bench.** Many Scout ranges are equipped with a loading bench that provides a stable and easy-to-reach platform for the muzzleloading rifle during the loading process.

Muzzleloading Shotgun. Only recently manufactured (or assembled from a kit) percussion cap or flintlock muzzleloading shotguns no smaller than 20-gauge or greater than 10-gauge are to be used.

Propellant. Only a commercially manufactured, sporting-grade black powder or black powder substitute offered for sale by a reputable firm should be used in muzzleloading shotguns. For new shooters, the amount of propellant in grains should be at the minimum of the gun manufacturer’s recommended load range.

Accessories.

- **Ramrod.** The ramrod is used to seat the patch and shot. It is usually mounted in the fore-end of the stock, just beneath the barrel. It is recommended that a more durable work rod be obtained for use on the range. The first time a new rod is used, it should be inserted into the charged barrel all the way down to the ball. A permanent mark should be scribed on the rod at the muzzle. This will be an indicator of a charge or shot remaining in the barrel.
- **Powder flask and powder measure.** Propellant shall be transferred from the original bulk container to a brass or plastic powder flask to be taken to the range. It shall then be poured into the powder measure before pouring into the barrel.
- **Shot measure.** A small cup with a handle that allows the shooter to measure the exact amount of shot and then pour it directly into the barrel.
- **Nipple wrench and nipple pick.** The nipple wrench is a simple tool used to remove the cap nipple should it become fouled. A nipple pick is a stiff wire that is used to clear debris in the nipple orifice (flash channel).
- **Capper.** Percussion caps are packaged 100 per tin. The capper allows the caps to be dispensed one at a time right onto the nipple.

- Patch puller, wad puller. These tools fit onto the end of the ramrod to remove the wad or patch from down in the barrel. Care must be taken when using these items.
- CO₂ ball discharger. This tool has a fitting to fit onto the nipple and has a small CO₂ cartridge to provide pressure to blow a patch and shot out the muzzle of the shotgun. Always point the muzzleloading shotgun in a safe direction when using this device.
- Loading bench. Many Scout ranges are equipped with a loading bench that provides a stable and easy-to-reach platform for the muzzleloading shotgun during the loading process.

Venturing and Sea Scout Archery

Bows. Light-draw-weight (20- to 35-pound); 62-, 66-, or 70-inch; take-down; recurve bows are recommended for Venturers and Sea Scouts because the bow will fit the many archers who may have different lengths of draw. The bow should be equipped with an arrow rest in good condition and with a proper-length, well-served, 10- to 12-strand string with a properly placed nock locator.

Always inspect the bow for cracks and splinters, and the condition of the bowstring and serving.

The Mathews-brand Genesis bow is popular in youth programs because it provides all the advantages of a compound bow but with a steady draw weight throughout the length of the pull.

True compound bows are not recommended at this level because they must be set up to fit each individual archer.

Arrows. Care should be taken to inspect arrows before use.

- Shaft material. Wood arrows are light but susceptible to warping and splintering. Fiberglass arrows are heavier and more durable, and will last several seasons. Aluminum arrows are light and shoot true, but cannot be repaired if bent or kinked. Carbon fiber arrows are lighter, stronger, and preferred by most competitive archers.

- Length. An appropriate length arrow for Venturing-age youth will be approximately 28 to 32 inches. Care must be taken to avoid shooting an arrow that is too short for the archer.
- Point. Arrows must be fitted with target points. No field points or broadheads.
- Nock. The nock should fit the serving of the bow being used. The arrow should not fall from the string if the nock opening is correct.
- Fletching/vanes. Either may be used; however, plastic vanes will provide longer service with young shooters.

Personal protection.

- Quiver. For each archer, either a personal side quiver or a ground quiver must be provided to store arrows during shooting.
- Finger protection. Each archer must wear a finger tab or glove unless there are “no gloves” on the string.
- Arm protection. Each archer *must* wear an arm guard on the bow arm. Arm guards may be obtained in junior sizes for small arms.

Sights. As the fundamentals of archery are learned, it is recommended that commercial sights be added to the bow. Relatively inexpensive target sights may be added to the bow, which will be a tremendous aid to the shooter either for qualifying or for competition.

Targets. For new shooters, it is recommended that large-diameter target mats and faces be used to ensure success and to reduce the number of passed arrows. Ethafoam mats are commercially available in 48-, 36-, and 32-inch diameters with five-color target faces to match. The mat should be mounted on a stable tripod with the center of the target approximately 48 inches high. As Venturers and Sea Scouts develop skill, various target games and shooting distances may be introduced to provide a challenge for the shooter.

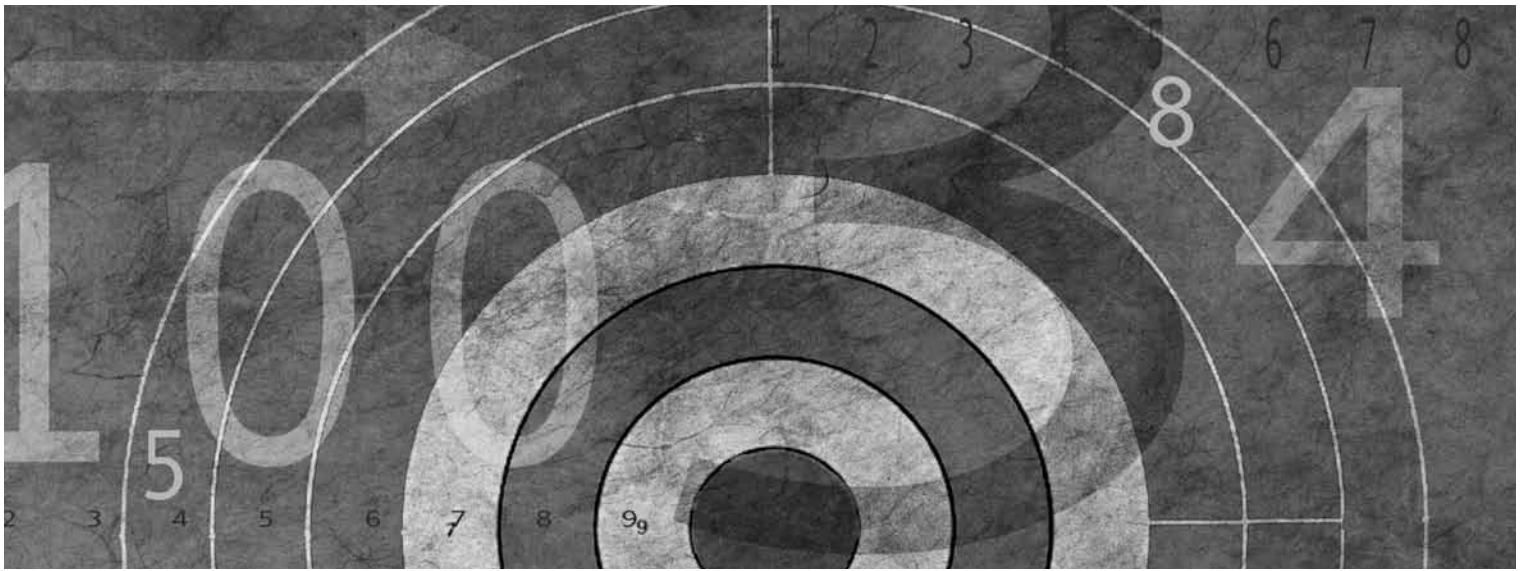

SECTION III HEALTH AND SAFETY

Chapter 6: Safety

The Boy Scouts of America adheres to its longstanding policy of teaching its youth and adult members the safe, responsible, and intelligent handling, care, and use of firearms and bow and arrow in planned, carefully managed, and supervised programs.

Safe gun handling is of paramount importance. You must treat every firearm as if it were loaded. With that in mind, there are several universal rules of safe gun handling that must be followed at all times.

1. **Always** keep the firearm pointed in a safe direction.
2. **Always** keep your finger off the trigger and outside the trigger guard until aimed at your target and instructed to shoot.
3. **Always** keep your firearm unloaded until you are ready to shoot.
4. Know your target and what is beyond it.
5. Be familiar with the safe operation of your firearm.
6. Always use the correct ammunition for your firearm.
7. Live rounds of ammunition **MUST NOT** leave the range.
8. Unattended firearms should not be accessible to unauthorized persons.

Guide to Safe Scouting

The purpose of the *Guide to Safe Scouting* is to prepare adult leaders to conduct Scouting activities in a safe and prudent manner. The policies and guidelines have been established because of the real need to protect members from known hazards that have been identified through 100-plus years of experience. Limitations on certain activities should not be viewed as stumbling blocks; rather, policies and guidelines are best described as stepping-stones toward safe and enjoyable adventures.

All volunteers participating in official Scouting activities should become familiar with the *Guide to Safe Scouting*. The *Guide to Safe Scouting* may be found online at www.scouting.org/scoutsource/HealthandSafety/GSS.

Communications

Each range should have a working two-way radio, cell phone, or immediate access to a telephone, whenever a shooting activity is taking place there. An emergency contact list should be permanently posted close to the radio or telephone. The camp ranger will also have the contact list with a copy posted in the office near the phone. The list should include the camp ranger; fire, police, and rescue services; hospital; camp physician (for summer camp); council camping director; and Scout executive. If trained medical personnel are known to be present in camp during an event, they may be able to render assistance.

If 911 is called, have someone stay on the phone with the 911 operator until emergency medical help arrives. Send someone to the camp entrance and any other appropriate locations to help direct emergency services personnel and equipment to the scene where they are needed.

Emergency Response Plans

A complete first-aid kit should be centrally located near the shooting ranges. The location of the first-aid kit should be prominently marked. In the event of an accident, the procedures listed below should be strictly followed.

Minor Injury Not Involving Shooting Sports Equipment

1. Call for a cease-fire on the adjacent range.
2. Assess the situation.
3. Send the injured party to the first-aid station (if there is one) together with a buddy and adult supervision. If a first-aid station is not available and the injury is minor, apply first-aid using the range first-aid kit.
4. Notify the event director or the camp director and coordinate with them the notification of unit leaders, parents, and other appropriate people.
5. Fill out the injury report form.
6. Continue range operations.

Minor Injury Involving Shooting Sports Equipment

1. Call for a cease-fire on the range involved.
2. Assess the situation.
3. Send the injured party to the first-aid station (if there is one) together with a buddy and adult supervision. If a first-aid station is not available and the injury is minor, apply first-aid using the range first-aid kit.
4. Notify the event director or the camp director and coordinate with them the notification of unit leaders, parents, and other appropriate people.
5. Fill out the injury report form. Take detailed notes, list witnesses and their contact information, and turn in the event notes to the ranger, who will forward the information to the camping director.
6. Remove the faulty equipment until it can be properly repaired.
7. Assess the appropriateness of continuing range operations.

Major Injury Not Involving Shooting Sports Equipment

1. Call for a cease-fire on the adjacent range.
2. Send a responsible individual to call 911 and notify the event director or the camp director and coordinate with them the notification of unit leaders, parents, and other appropriate people.
3. Perform required first-aid. Give priority attention to providing all possible care for the injured.
4. Keep onlookers calm. Put another adult or senior Scout in charge to move and keep people out of the area.
5. Fill out the injury report form. Take detailed notes, list witnesses and their contact information, and turn in the event notes to the ranger, who will forward the information to the camping director.
6. Assess the appropriateness of continuing range operations.

Major Injury Involving Shooting Sports Equipment

1. Call for a cease-fire on the range involved.

2. Send a responsible individual to call 911 and notify the event director or the camp director and coordinate with them the notification of unit leaders, parents, and other appropriate people.
3. Perform the required first-aid. Give priority attention to providing all possible care for the injured.
4. Keep onlookers calm. Put another adult or senior Scout in charge to move and keep people out of the area.
5. Fill out the injury report form. Take detailed notes, list witnesses and their contact information, and turn in the event notes to the camp ranger, who will forward the information to the camp director and the Scout executive.
6. Identify, by some means, the faulty or malfunctioning equipment.
7. Close the range involved.
8. Notify the camping director and the Scout executive.

Fatality

1. Call for a cease-fire on all ranges.
2. Send a responsible individual to call 911 and notify the camp director, camp ranger, unit leader, and event chairman (if appropriate).
3. Keep onlookers calm. Put another adult in charge to move and keep people out of the area.
4. Fill out the injury report form. Take detailed notes, list witnesses and their contact information, and turn in the event notes to the camp ranger, who will forward the information to the camping director and Scout executive.
5. Close the range involved.
6. Notify the camping director and the Scout executive.
7. Ensure that no disturbance of the victim or surroundings is permitted until police have assumed authority. Designate a responsible adult to take charge of the bystanders.
8. Exercise care that no statements are made either orally or in writing that could be interpreted either as assumption or rejection of responsibility for the accident.
9. Refer any media (press, radio, TV) inquiries to the Scout executive.
10. Assess the appropriateness of reopening ranges away from the scene of the fatality.

National Camping Standards

Refer to the current *Camp Program and Property Management* book, Section VI, “Shooting Sports,” for summer camp operation and management procedures. BSA resident camps adhere to the current year’s national standards, which can differ from this manual. This shooting sports manual is to be used for all off-season camp property and off-camp property shooting sports activities.

Standard Operating Procedures

All ranges should have their own written standard operating procedures (SOP) and have them posted at the range. See Appendix 3 for a sample of an SOP.

Archery Safety Guidelines

Modern bows and arrows are potentially dangerous. Boy Scouts, Venturers, and Sea Scouts must learn the following simple safety rules:

- Range flags must be flown while the range is in use.
- Check all equipment before using it to be sure bows, bowstrings, and arrows are in safe condition.

- All spectators and archers waiting to shoot must remain behind the shooting line at all times.
- A bow, like a gun, must never be pointed at a person.
- Never release an arrow without being able to see its full, clear path to the target.
- Never draw a bow if anyone is in front of the shooting line. Stand behind the shooting line.
- Arrows should be nocked only on the shooting line at the archery range master’s signal and pointed only in the direction of the target.
- Stop shooting immediately on signal from the range master or if anyone crosses in front of or behind the target.
- Never shoot an arrow up into the air.
- Break and discard all cracked or fractured arrows.
- Draw a bowstring only with a nocked arrow of proper length. Failure to do this may result in overdrawing and breaking the bow or in personal injury.
- Observe all state and local laws on using a bow.
- Always wear an arm guard and finger tab or gloves.
- Broadhead arrows are for those who are licensed to hunt. They have no place in Scouting archery activities.
- Bows and arrows should be used only in places set aside for their use. Target or field archery ranges should be established and clearly marked on all sides. All shooting must be done in an established and supervised area.
- Always practice courtesy and good sportsmanship.
- When searching for a lost arrow, leave your bow standing against the target face. Better yet, have a partner stand by to intercept other archers who may follow. Stay on marked paths. Travel the direction in which targets are marked.

Equipment Inspections—Firearms and Archery

Before Shooting

Inspect the ranges for any condition that might pose a potential hazard to the safe operation of the ranges. If unsafe conditions exist, contact the camp ranger to help mitigate those conditions. If unsafe conditions cannot be made safe, the range **MUST NOT** be opened for live firing. Inspect the shooting sports equipment for any condition that might pose a potential hazard to the safe operation of that equipment. Any shooting sports equipment that is not fully functional **MUST NOT** be used until it is repaired.

After Shooting

Ensure that all firearms are completely unloaded. Clean the shooting sports equipment. For archery, this may be as simple as wiping dirt and fingerprints off the equipment. For firearms, some disassembly may be required to gain access to dirty parts. Where appropriate, enlist the Scouts who were shooters to help with the cleanup. Put away shooting sports equipment that stays on the ranges, including safety equipment, targets, and ammunition. Return firearms to the armory and archery equipment to its proper storage location. If there are firearms or archery equipment that malfunctioned or was unsafe to operate, that equipment should either be repaired or tagged to be repaired by a qualified gunsmith or archery specialist.

Chapter 7: Health Considerations

General

Eye protection. When a firearm or BB gun is fired, the bullet or BB is discharged at very high speed. When the projectile hits a stationary object, the projectile and/or the stationary object may break apart, sending fragments flying. The fragments might fly back toward the firing line. Also of concern, when the firearm discharges, small amounts of powder may blow back toward the shooter. To help minimize the risk of serious injury to the eyes while shooting, shatter-resistant or shatterproof glasses must be worn by all people on or near the firing line.

Hearing protection. The discharge of a firearm creates a sharp report loud enough to damage the human ear. To reduce the potential for hearing damage, earplugs, passive earmuffs, or active ear protection must be worn by all people within the ready line or on the firing line. The level of hearing protection should be a noise reduction ratio of at least 20 decibels.

Lead protection. Lead is a soft, dense metal that is an integral part of most bullets. Lead is toxic to humans in relatively small concentrations, with the most susceptible organs being the eyes, central nervous system, and gastrointestinal tract. Handling ammunition, setting up a range for shooting, counting out rounds for firing, loading and unloading a firearm, discharging a firearm, and cleaning a firearm can all leave lead residues on the skin. Two easy precautions can minimize the risk of inhaling or ingesting lead residues. First, when handling ammunition or a recently discharged firearm, minimize contact of the hands with other parts of the body, particularly the eyes, mouth, and skin. When you are finished handling ammunition or firearms, immediately wash your hands with soap and water. It is strongly recommended that a handwashing

station be next to all shooting ranges and storage areas where ammunition or firearms may be handled or used. Food and drink should not be permitted on a shooting range or in storage areas. This will remove the temptation to eat around a source of lead.

Cleaning solvents. Solvents used for cleaning firearms typically contain petroleum distillates, ammonia, caustics, and other potentially hazardous chemicals. Hazards may include skin damage, lightheadedness from vapors, and risk of fire. In addition, once the solvent has done its job of cleaning a firearm, it not only contains the original chemicals, but now contains the residues from the firearm, which may include lead, copper, gunpowder, and burned plastic. As with lead, contact with the eyes, mouth, and skin should be discouraged while handling firearm cleaning solvents. Food and drink should not be allowed in areas where cleaning takes place. A washing station with soap and water should be available near the firearm maintenance/cleaning area.

Other considerations. Another type of health consideration concerns shooters who may have physical or mental challenges. The question may need to be asked whether or not the challenged individual can shoot safely. Factors influencing the answer can be many: How severe is the challenge? Does the challenged person have someone helping them? Can you communicate effectively with the challenged person? It may be necessary to temporarily close the range to other shooters so you can work one on one on the range with a challenged individual. Advance consideration must also be given to the provisions of the Americans With Disabilities Act.

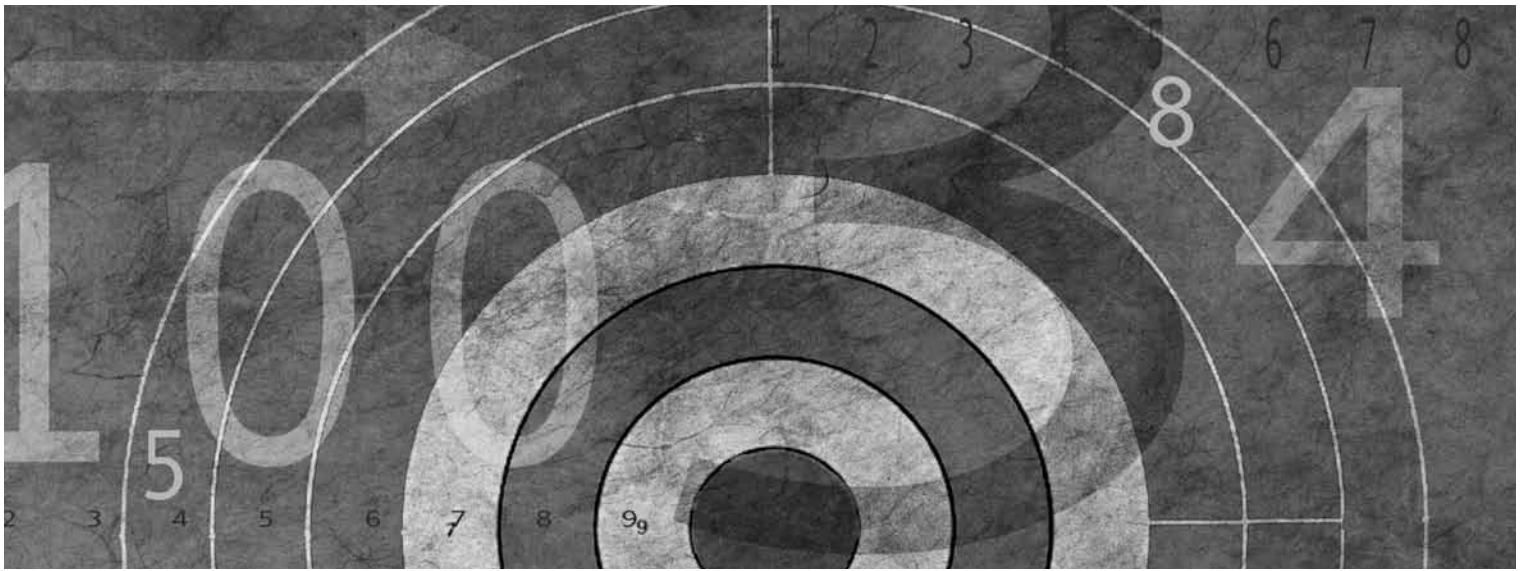

SECTION IV TRAINING

Chapter 8: Training Courses

In Scouting events and activities, the BSA's primary consideration is the safety of its youth and adult members. To achieve that goal, the BSA, in consultation with other organizations, has created specific guidelines for the shooting sports, which is the purpose of this manual. These organizations also provide training and instructor certification by discipline-specific subject matter experts to prepare those individuals who will serve in a leadership or supervisory role in the various shooting sports activities.

The National Rifle Association states the goal of its Instructor Training Program is to develop instructors who possess the **knowledge**, **skill**, and **attitude** to teach the safe handling and proper use of firearms.

In general, for all certifying organizations, the instructor candidate must meet specific eligibility requirements, satisfactorily complete the instructor training curriculum, understand and agree to the responsibilities of a certified instructor, and maintain active certification status.

Listed here are the shooting sports training certifications recognized by the Boy Scouts of America.

BSA Training

BSA National Camping School

Annually, seven-day BSA National Camping Schools are conducted in each region. The purpose of the National Camping School is to prepare Scouters who will be serving in management or supervisory roles in the council summer camp program. Those who successfully complete the shooting sports section of the National Camping School, will be given a certificate of training as a BSA shooting sports director, which is valid for the next five camping seasons.

Participation must be approved by a local Scout executive, and enrollment is administered through the local council.

Successful completion of the National Camping School shooting sports curriculum includes the practical training, testing, and approval for the candidate to apply for instructor credentials as an NRA certified rifle instructor, NRA certified shotgun instructor, NRA certified muzzleloading rifle instructor, NRA certified pistol instructor, NRA range safety officer, and USA Archery (NADA) basic archery instructor (Level 1).

It is also expected that the BSA shooting sports director will serve the council as a resource during the off season and be an active member of the council's shooting sports committee.

Range Master Training for Cub Scouting

Operation of BB and archery ranges for Cub Scout activities and events, including Cub Scout day camp, Cub Scout or Webelos resident camp, Mom and me, dad-n-lad, parent and pal, and council-operated family camping programs require qualified, trained range masters.

Cub Scout BB and archery range master training is administered by the council's shooting sports committee and is conducted by a BSA shooting sports director or a National Rifle Association currently certified rifle instructor for BB gun, or NRA/USA Shooting/CMP certified rifle coach, and an USA Archery/NFAA instructor for archery. This certification is valid for two years.

A currently certified NRA rifle instructor or NRA/USA Shooting/CMP certified rifle coach is qualified to serve as a BB range master. A currently certified USA Archery/NFAA basic archery instructor or National Archery in the Schools Program (NASP) basic archery instructor may serve as the archery range master for Cub Scout archery activities. BSA registration is required per *Cub Scout Day Camp*, No. 13-33815, and Day Camp Standard M43A.

National Rifle Association Training

NRA Certified Rifle Instructor

An NRA certified rifle instructor is required to provide instruction for BSA rifle shooting activities involving Boy Scouts, Varsity Scouts, Venturers, and Sea Scouts.

The NRA rifle instructor may teach the BSA 30-Minute Rifle Briefing, the NRA FIRST Steps Rifle Orientation, the Rifle Shooting merit badge using the BSA Rifle Shooting Merit Badge Teaching Guide, and the eight-hour NRA Basic Rifle Course.

A currently certified NRA rifle instructor is qualified to serve as a BB range master for Cub Scout BB shooting activities.

The NRA rifle instructor course is 14 hours and includes classroom and range activities with student teaching, evaluation, and testing. The course is conducted by an NRA training counselor.

NRA Certified Shotgun Instructor

An NRA certified shotgun instructor is required to provide instruction for BSA shotgun shooting activities involving Boy Scouts, Varsity Scouts, Venturers, and Sea Scouts.

The NRA shotgun instructor may teach the BSA 30-Minute Shotgun Briefing, the NRA FIRST Steps Shotgun Orientation, the Shotgun Shooting merit badge using the BSA Shotgun Shooting Merit Badge Teaching Guide, and the eight-hour NRA Basic Shotgun Course.

The NRA shotgun instructor course is 11 hours and includes classroom and range activities with student teaching, evaluation, and testing. The course is conducted by an NRA training counselor.

NRA Certified Pistol Instructor

An NRA certified pistol instructor is required to provide supervision for BSA pistol shooting activities involving Venturers and Sea Scouts only.

The NRA pistol instructor may teach the BSA 30-Minute Pistol Briefing, the NRA FIRST Steps Pistol Orientation, and the eight-hour NRA Basic Pistol Course to Venturers and Sea Scouts.

The NRA pistol instructor course is 10 hours and includes classroom and range activities with student teaching, evaluation, and testing. The course is conducted by an NRA training counselor.

NRA/National MuzzleLoading Rifle Association Certified Muzzleloading Rifle Instructor

An NRA/NMLRA certified muzzleloading rifle instructor is required to provide supervision for BSA muzzleloading rifle shooting activities involving Boy Scouts, Varsity Scouts, Venturers, and Sea Scouts.

The NRA/NMLRA muzzleloading rifle instructor may teach the NRA Basic Muzzleloading Rifle Shooting Course, the NRA FIRST Steps Muzzleloading Rifle Orientation, and the Muzzleloading option of the Rifle Shooting merit badge. To serve as a merit badge counselor, he or she must hold a current BSA registration as a merit badge counselor.

The NRA muzzleloading rifle instructor course is 12.5 hours and includes classroom and range activities with student teaching, evaluation, and testing. The course is conducted by an NRA training counselor.

NRA/National MuzzleLoading Rifle Association Certified Muzzleloading Shotgun Instructor

An NRA/NMLRA certified muzzleloading shotgun instructor is required to provide supervision for BSA muzzleloading shotgun shooting activities involving Boy Scouts, Varsity Scouts, Venturers, and Sea Scouts.

The NRA/NMLRA muzzleloading shotgun instructor may teach the NRA Basic Muzzleloading Shotgun Shooting Course, the NRA FIRST Steps Muzzleloading Shotgun Orientation, and the muzzleloading option of the Shotgun Shooting merit badge. To serve as a merit badge counselor, he or she must hold a current BSA registration as a merit badge counselor.

The NRA muzzleloading shotgun instructor course is 11 hours and includes classroom and range activities with student teaching, evaluation, and testing. The course is conducted by an NRA training counselor.

NRA Certified Muzzleloading Pistol Instructor

An NRA/NMLRA certified muzzleloading pistol instructor is required to provide supervision for BSA muzzleloading pistol shooting activities involving Venturers and Sea Scouts only.

The NRA/NMLRA muzzleloading pistol instructor may teach the NRA Basic Muzzleloading Pistol Shooting Course or the NRA FIRST Steps Muzzleloading Pistol Orientation to Venturers and Sea Scouts.

The NRA/NMLRA muzzleloading pistol instructor course is 12.5 hours and includes classroom and range activities with student teaching, evaluation, and testing. The course is conducted by an NRA training counselor.

NRA Range Safety Officer

An NRA range safety officer is required to provide live firing range supervision for all shooting activities involving Boy Scouts, Varsity Scouts, Venturers, and Sea Scouts. No other certification is accepted.

The NRA range safety officer is responsible for the range operation.

The NRA basic range safety officer instructor course is nine hours and includes classroom and range activities with student teaching, evaluation, and testing. The course is conducted by an NRA chief range safety officer or NRA training counselor.

NRA Chief Range Safety Officer

An NRA chief range safety officer is qualified to teach the NRA basic range safety officer course. The CRSO may also assist Scouting activities in the role of the RSO.

The NRA chief range safety officer instructor course is approximately eight hours and includes classroom and range activities with student teaching, evaluation, and testing. The course is conducted by an NRA training counselor.

NRA Home Firearms Safety Instructor

An NRA certified instructor in any discipline may home study, complete the testing, and apply for an appointment as an NRA home firearms safety instructor. The four-hour home firearms safety course would be a great opportunity to get the entire Scouting family familiar with the safe handling of a firearm that may be found in the home. The curriculum includes how to unload a firearm and proper storage. It is not a shooting course.

NRA Training Counselor

Qualified, experienced, certified instructors may apply for appointment as a training counselor to recruit and train new instructors to teach basic firearms training courses. To be eligible, they must:

- Be a member of the NRA.
- Have at least two years of experience in teaching discipline-specific NRA basic courses, conducting a minimum of five basic firearms courses with a total minimum of 25 students.
- Attend a training counselor workshop and receive the endorsement of the NRA training counselor trainer.

Note: An NRA certified instructor who uses the new *BSA Merit Badge Teaching Guide* to teach the BSA Rifle Shooting or Shotgun Shooting merit badges and files these course reports with the NRA as “FIRST Steps Courses” can use these classes to fill part of their requirements to be training counselor–qualified. For more information on how to obtain copies of the *BSA Merit Badge Teaching Guide*, please contact Mark Belli at NRA headquarters. E-mail him at Mbelli@nrahq.org or call 703-267-1550.

Council shooting sports committees should recruit Scouters who have been appointed as NRA training counselors as active committee members or as a shooting sports resource for the council.

NRA Coach Education Program

The Coach Education Program, under the Education and Training Division of the NRA, offers both basic and advanced technical and tactical skills coach training schools for rifle, pistol, shotgun, and high-power rifle, along with training camps and clinics. Training reflects the latest in coaching philosophy and presentation methodology along with the most up-to-date techniques and competition tactics to help you and your team achieve your goals.

The Coach Education Program is a cooperative effort of the major competitive shooting organizations in the United States, the NRA, USA Shooting (USAS), the Civilian Marksmanship Program (CMP), and the Amateur Trapshooting Association (ATA). The NRA is the governing body for many domestic shooting sports programs and administers the Coach Education Program. USAS is the national governing body for Olympic and international shooting sports in the United States. The CMP is a federally chartered not-for-profit corporation whose mission is to train U.S. citizens in marksmanship and firearm safety, with a particular emphasis on youth. The ATA is the governing body for American-style trapshooting.

Archery Training

USA Archery/NFAA Basic Archery Instructor

This universal USA Basic Archery Instructor Certification course is administered by USA Archery, the official organization for Olympic archery, and the National Field Archery Association (NFAA).

Candidates for the basic instructor certification are primarily camp counselors and those working with entry-level students. The eight-hour curriculum includes classroom and range activities, practice teaching, and testing.

USA Archery/NFAA certified archery instructors may teach the Basic Archery course and the Archery merit badge. To serve as a merit badge counselor, he or she must hold a current BSA registration as a merit badge counselor. In addition, the certified instructor may serve as a range master for a Cub Scout archery activity.

USA Archery/NFAA Intermediate Archery Instructor

Candidates for the intermediate instructor certification are instructors who currently hold a basic certification, want to teach the basic instructor course, and are working with intermediate-level students. The curriculum includes classroom and range activities, equipment tuning, coaching and evaluation, practice teaching, and testing, and is conducted by a USA Archery/NFAA instructor trainer.

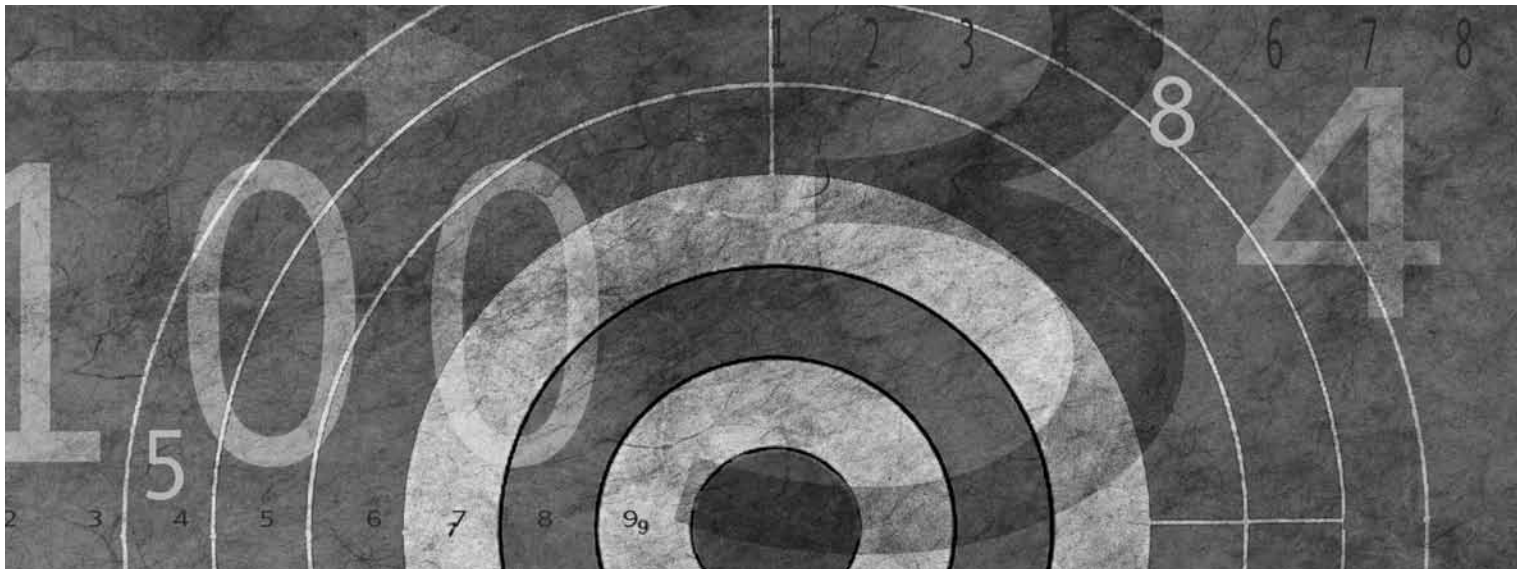

SECTION V
CUB SCOUT SHOOTING SPORTS

Chapter 9: Introduction

Archery and BB gun shooting are restricted to day camps, Cub Scout/Webelos Scout resident camps, council-managed family camping programs, or to council activities held on or off BSA property where there are currently trained BSA shooting sports range masters and all standards for BSA shooting sports are enforced. Archery and BB gun shooting are not to be done at the pack level.

Archery and BB Shooting belt loops and sports pins may be earned only at the camps and activities listed above.

These programs are designed to emphasize safety and marksmanship development under the direction of trained range masters using nationally approved instructional methods.

This section is for the BSA shooting sports director with archery and/or NRA rifle certification or for NRA instructors or for NRA/USA Shooting/CMP certified rifle coaches or USA Archery/NFAA archery instructors who will teach the shooting sports skills of archery and BB gun shooting to Tiger Cubs with their adult partners, Cub Scouts, and Webelos Scouts. There is potential danger to the untrained participant and others. "Safety through skill" is the watch phrase.

Special facilities and supervision are required for shooting sports. Camping reservations of local councils become the center for most of these activities.

Shooting sports training provides fun and adventure for boys. Archery and BB gun shooting teach skills, discipline, self-reliance, sportsmanship, and conservation, all of which are elements of good character valued by Scouters.

Adventure beckons when Tiger Cubs with their adult partners, Cub Scouts, and Webelos Scouts have mastered the skills of shooting sports. Mastery of these skills will help a boy feel confident in his abilities.

The council's camping reservation usually is an ideal location for shooting sports areas. Here, safely designed areas may be established for the Cub Scout shooting sports program. Under qualified leadership, Tiger Cubs with their adult partners, Cub Scouts, Webelos Scouts, and parents may be given the opportunity to participate in these skills.

Other community resources such as the local chapter of the National Rifle Association, archery clubs, and sports groups will often provide facilities and resources.

The skills needed to master shooting sports adds color and variety to the Cub Scout program. These activities can become a natural part of our camp setting.

Leadership

In camp, leadership for shooting sports needs special attention by the camp director and his or her program director. Staff members must be certified per BSA qualifications for these activities and must be at least

18 years old with mature judgment and the ability to teach. Ideally, in Cub Scout/Webelos Scout day or resident camp, the staff should be members of the central camp staff. Volunteer experts who come to camp for shorter periods may supplement their work.

All shooting ranges in the Cub Scout program must be supervised by a qualified range master who is at least 18 years old and who meets the minimum state requirements. See specific qualifications and training requirements for archery range master and for BB gun shooting range masters in Chapter 1.

Some leaders may already be available with the proper training; however, to find other adults in your community who may be interested in being trained as a range master, try contacting:

- Members of National Archery Association clubs
- Members of sportsmen's clubs (often including bow hunters)
- College and high school physical education instructors
- Representatives of the archery industry
- Members of the National Rifle Association
- Members of local gun clubs
- Military instructors
- Local and state police department personnel
- State conservation personnel
- Local sporting goods retailers and their employees

BSA National Camping School Shooting Sports Director

In most councils, the BSA National Camping School shooting sports director oversees the shooting programs, trains the range masters, and is responsible for the operation of archery and BB gun ranges in council camps.

The BSA National Camping School shooting sports director must be at least 21 years old and hold a current National Camping School shooting sports director's card. National Camping School qualifications include BB, rifle, shotgun, muzzleloading, and archery instruction, unless otherwise noted on the card. He or she is registered with the Boy Scouts of America.

Note: In addition to shooting sports directors, USA Archery/NFAA instructors may train archery range masters, and National Rifle Association rifle instructors or NRA/USA Shooting/CMP certified rifle coaches may train BB gun range masters.

Directing Shooting Sports in a Council Program

- Know and strictly follow all the safety regulations related to BB guns and archery.
- Train staff about safety regulations for all sports areas.
- Train all campers and leaders in the safety fundamentals.
- Check the performance and safety aspects of all areas.
- Restrict from using an area any person who does not follow all safety instructions.
- Set up all areas in a practical, safe, and inviting manner.
- Provide qualified supervision for each area at all times, even when not in use.

- Train, schedule, and supervise staff to perform daily routines.
- Check the inventory of all shooting sports equipment. Check minimum equipment to make sure there is enough equipment, and obtain any needed equipment.
- Keep an adequate stock of BB guns and archery equipment on hand and be accountable for all inventories.
- Make sure equipment is properly stored and locked up when not in use.
- Organize and promote individual and team competition.
- Set an example of Scout-like conduct regarding uniforming and general bearing.
- Report any and all operational and personnel problems to the camp director.
- File a closing inventory, a report, and recommendations as instructed.

Safety Instruction Guidelines

To be effective, instruction should:

- Teach safety through self-discipline. Safety practices should become habits.
- Teach shooting skills using the best methods for the limited time available. Participants learn more by example and doing than by lectures.
- Develop, through participation, the attitudes and habits that will fortify the goals of the movement—to help boys become physically fit men of good character who are prepared for useful citizenship.

Give instruction in simple terms. Controversial methods should be omitted. Make it clear that only one method will be used and that there is not enough time to show alternate methods. Instructors should exactly follow the method they teach.

Shooting sports skills must be learned by practice, with each participant learning the rules of safety and self-discipline by putting them into effect. Participants quickly learn that there is no place for foolishness, carelessness, or horseplay when they handle shooting equipment. The instructor must always be mindful of his or her responsibility to make safety rules thoroughly understood before, during, and after instruction and practice. At the same time, he or she must have warmth, patience, and understanding for the boy who may not understand an instruction or who finds a skill challenging to learn.

Positive Aspects of Shooting Sports

From material by R.A. Soldivera, shooting sports consultant

- Shooting sports are part of the Olympic program events.
- Shooting sports do not require participants to start at an early age to be successful. A person may start shooting in high school and compete on a national level before entering college.
- Age does not seem to be a factor in learning shooting sports. Shooting sports have had a national champion who was more than 60 years old, and one as young as 16 years old.
- Shooting sports are for both boys and girls.
- Shooting sports may be conducted both indoors and outdoors.
- Shooting sports may be featured as both a winter sport and a summer sport.
- Shooting sports may offer individual participation, team participation, or both at the same time.
- Shooting sports are recognized as being very safe with few injuries.
- Shooting sports require a minimum of facilities rather than large arenas, courses, courts, or gymnasiums.
- Students who have participated in shooting sports report a marked improvement in their ability to concentrate when they apply the principles of these sports to their academic pursuits.
- Purity is a term used in sports to describe the degree of precision with which a physical function must be executed. Shooting sports require the highest degree of purity.
- Sportsmanship has been described as “the quality and conduct of a person who accepts victory and defeat graciously.” Shooting sports has a reputation for high sportsmanship conduct among its participants.
- People with physical disabilities are able to compete at high levels of competition in shooting sports.
- College scholarships are awarded in shooting sports.
- In shooting sports, everyone participates.

Chapter 10: Archery

Archery is a colorful, interesting, and worthwhile activity for boys. The beginner gets immediate satisfaction, yet finds a continuous challenge as he develops into a skilled archer. This activity provides good physical exercise and develops powers of concentration and coordination.

The goal is to teach Tiger Cubs with their adult partners, Cub Scouts, and Webelos Scouts how to use the bow and arrow safely.

A Brief History of Archery

The advancement of civilization was enhanced by the use and discovery of bows and arrows. The bow and arrow provided a much safer way to hunt and made life easier.

Generally it is thought the spear was the predecessor to the bow. Spearheads have been discovered from many thousands of years ago.

A recognizable bow was discovered dating back to 6000 B.C. that was made from yew or elm.

Egyptians, somewhere around 3500 B.C. to 2800 B.C., are considered the first to use the bow in battle, which gave them superiority over their enemies. This bow was known as a composite bow.

Assyrians developed a shorter recurve bow that provided more power and easier handling around 1500 B.C. Crossbows were also used in ancient China.

About this same time, the Parthians became famous for shooting backwards while riding a horse. The term “Parthian shot” is still used today in archery.

Heracles, a Greek hero, was very well known for his help with the siege of Troy around 1260 B.C.–1240 B.C. As a direct result of Heracles’ help, the city of Troy fell through the use of the Trojan Horse.

Around 1200 B.C., a famous Egyptian pharaoh named Rameses II gave archery another boost by putting archers on chariots. This mobility allowed the Egyptians to defeat the Hittite army.

Through the course of time the wooden bow was made longer. The British were famous for improving on the bow, which eventually became known as the British longbow. The most famous battle of the longbow was the battle of Crecy in 1346. In 1500, crossbows were banned in England to promote the use of the longbow. In 1595, the army was ordered to replace all bows with muskets. Archery has remained a popular sport activity in England.

Some of the first archery clubs were formed in England. Competitions were part of their way of life. The English are noted for the three forms of shooting. Butt shooting is where targets are mounted on mounds at 100 to 140 yards. Clout shooting is where targets are mounted on the ground with a

wooden stay in the center. For these two forms, arrows are shot upward to descend on the target. For the third form of shooting, roving, archers shoot at simulated small animals over varying ranges on unprepared ground and courses.

Around 1000 A.D., bow and arrow technology swept the Americas. As seen through archeological studies, its use was adopted by most prehistoric native Americans.

In 1879 the National Archery Association was founded. The first national tournament was held in White Stocking Park in Chicago the same year. The first archery club in the United States, the United Bowmen of Philadelphia, was founded in 1928.

In 1900 archery became part of the Olympic games. It was dropped after 1920 because the wide range of rules could not be standardized. In 1931, the Federation Internationale de Tir l’Arc (FITA) was founded in Paris and standardized the rules for international competition, but it was not until 1972 that archery was again a part of the Olympic program.

Leadership

Archery must be conducted by trained, qualified on-site range masters who actually direct the operation of the range program and archery instruction. To qualify as an archery range master, the range master must be at least 18 years old and be trained by a National Camping School-trained shooting sports director or a USA Archery/NFAA instructor.

The local council issues a Training Course Pocket Certificate, No. 33767, and keeps a record of those who have been certified. Certification must be renewed every two years.

Training Archery Range Masters

Use this outline to train archery range masters for district or council Cub Scout camps or events.

Section I (40 minutes)

- A. A Brief History of Archery, page 73
- B. Safety Guidelines, page 75
 1. Sun Safety on the Shooting Range, page 75
- C. Equipment, page 80
 1. Review bows, bowstrings, arrows, arm guards, finger tabs, quivers, points of aim, target butts, target faces, and backstops.
 2. Review how to string and unstring a bow.
 3. Review how to maintain, store, and care for equipment.
- D. Range Layout, page 79
- E. Range Operation Rules, page 80

Section II (40 minutes)

- A. Archery Shooting Basics, page 75
 - 1. Eye Dominance, page 75
 - 2. Stance, page 76
 - 3. Nock the Arrow, page 76
 - 4. Establish the Bow Hold, page 76
 - 5. Draw, page 76
 - 6. Aim, page 76
 - 7. Anchor, page 77
 - 8. Release or Loose, page 77
 - 9. Follow Through, page 77
 - 10. Retrieve Arrows, page 77
- B. Targets and Scoring, page 82
 - 1. Target Butts, page 82
 - 2. Target Faces, page 82
 - 3. Backstops, page 82
- C. Know the Proper Whistle Codes, page 75
- D. Archery Practice Fun, page 78

Section III (20 minutes)

- A. Training Cub Scouts, page 74
 - 1. Teaching Tips, page 74
- B. Shooting a Competitive Round, page 78
- C. Archery Games and Activities, page 78
- D. Tiger Cubs and Archery, page 75
- E. Cub Scout Shooting Sports Award, page 79
- F. Archery Belt Loop and Sports Pin, page 79

Training Cub Scouts

The objective is to teach Cub Scouts how to shoot a bow and arrow and to have fun safely.

This instruction is designed for immediate participation and success. For example, beginning students tend to shoot high because they want to look at the point of their arrows. By placing targets on the ground at 10 yards, rather than at the traditional 48-inch level at 25 yards, fewer arrows miss the target. This means more class time can be spent on shooting and less on looking for arrows.

Before handing out equipment, check each participant's eye dominance, page 75. Also, look for loose objects on the participants such as pins, pencils, loose sweaters, and watches that could get in the way of shooting.

For the best learning experience, give each Cub Scout a bow, an arm guard, a finger tab, a quiver, and six arrows. If it is not possible for each to have a bow, one bow might be shared by two or more boys.

Caution the class to hold the items but to not shoot until you give exact instructions to do so. Bows should already be strung at the first session. Stringing and unstringing bows may be taught later.

For beginning instruction, have left-handed shooters grouped at the right end of the shooting line to allow them a better view of the range master as he or she demonstrates.

Instruction takes place at the shooting line. Explain the use of whistles, page 75.

Teaching Tips

The coach-pupil method is effective for all types of skill training and is particularly effective in shooting sports. To put this method into practice:

1. Put the bow in the Cub Scout's hand as soon as possible so he can understand the tool while the basics are explained.
2. Group participants into pairs (boy and parent/guardian would be ideal.) Check for loose items on the bow side of the student that could interfere with his shooting.
3. The instructor demonstrates the activity or action to be followed before the whole group. When demonstrating techniques, be sure to do them correctly. The instructor then circulates among the pairs, giving a word of advice or assistance, recognizing good work, correcting errors, and determining how well the participants understand the method.
4. Check the student's finger tab closely before he shoots. Watch for four fingers on the string. Look for cramped fingers on the bowstring. Watch the thumb on the drawing hand. If a student masters the draw and anchor quite readily, stand behind him and check the string path before allowing him to shoot.
5. The boy practices while the parent coaches. Let Scouts shoot the first arrow as soon as possible, even if the bow hand, anchor, draw, etc., are not perfect.
6. At a predetermined signal, the positions are reversed.
7. Progressively, participants are learning by observing, by doing, and by coaching.
8. Use a positive approach. Use praise sincerely. Before making a correction, figure out the fault to find the cause. Never correct a student after spotting a fault on one arrow shot.
9. Avoid long discussions on learning the parts of equipment used. Teach just enough so participants will know how to safely use the equipment.
10. Allow each boy to feel the satisfaction of hitting the target as quickly as possible.

Cub Scout Archery Training

Section I (20 minutes)

- A. Safety Guidelines, page 75
- B. Equipment, page 80
 - 1. Review bows, bowstrings, arrows, arm guards, finger tabs, quivers, points of aim, target butts, target faces, and backstops.
 - 2. Review how to maintain, store, and care for equipment.
 - 3. Review how to string and unstring a bow. (Optional.)

Section II (40 minutes)

- A. Archery Shooting Basics, page 75
 - 1. Eye Dominance, page 75
 - 2. Stance, page 76
 - 3. Nock the Arrow, page 76
 - 4. Establish the Bow Hold, page 76
 - 5. Draw, page 76
 - 6. Aim, page 76
 - 7. Anchor, page 77
 - 8. Release or Loose, page 77
 - 9. Follow Through, page 77
 - 10. Retrieve Arrows, page 77
- B. Practice, practice, practice

Section III (60 minutes) (optional activities)

- A. Shooting a Competitive Round, page 78
- B. Archery Games and Activities, page 78
- C. Archery Belt Loop and Sports Pin, page 79

Tiger Cubs and Archery

Tiger Cubs and their adult partners may participate in archery activities. The adult partners must be included in all archery activities. Each Tiger Cub must be paired with his adult partner before being allowed to shoot.

Keep in mind that boys of this age have very short attention spans (20 to 30 minutes maximum), and tire easily. They probably have little previous experience working as a group and may require more time to understand how the range operates. Tiger Cubs have a wide range of ability and experience levels, so be ready for anything!

Tiger Cubs may earn the Archery belt loop and sports pin.

Safety Guidelines

Tiger Cubs with their adult partners, Cub Scouts, and Webelos Scouts should learn these simple safety rules. When training youth to shoot, be sure to have the proper equipment, secure and safe ranges, and clear safety instruction.

1. Observe all state and local laws on using a bow and arrow.
2. Shoot only with proper range supervision.
3. Always check your equipment before shooting. Break and discard all cracked or fractured arrows.
4. Know the proper whistle codes.
5. Bows and arrows should be used only in places set aside for their use.
6. Always keep your arrows pointed down or toward the target.
7. Only release an arrow when you can see its full clear path to the target.
8. Shoot only at the target in front of you.
9. Keep the arrows in the quiver until everyone is on or behind the shooting line and the range master has indicated that you may begin shooting.
10. Shoot with your feet behind the shooting (firing) line.
11. Stop shooting immediately upon signal from the range master or if anyone crosses in front of the shooting line or in front of or behind the targets.
12. Use only arrows that have been measured for your proper draw length. Arrows that are too short may cause personal injury or damage to the bow and arrow.
13. Always wear an arm guard and finger tab or glove.
14. Always practice courtesy and good sportsmanship.
15. Always walk, never run, when on the archery range or while carrying arrows.
16. On a target range, leave the bow standing against the target face while you are looking for lost arrows.
17. Stay on marked paths. Travel the direction in which the targets are marked.

Know the Proper Whistle Codes

Two blasts. Move up to the firing line.

One blast. Fire the proper number of arrows.

Three blasts. Cease firing. Move to the target. Retrieve and score arrows.

Four or more blasts. Cease firing. Stay where you are. This is an EMERGENCY. Officials will tell the archers what action to take either verbally or by the whistle code.

Remember there is only ONE command to shoot—ONE blast of the whistle.

For any command of more than one blast, STOP shooting. Watch and listen for further instructions.

Sun Safety on the Shooting Range

The American Academy of Dermatology advises the following protection tips against damaging rays:

- Limit exposure to sun between 10 a.m. and 4 p.m. when the sun's rays are the strongest.
- Generously apply sunscreen with a sun protection factor (SPF) of at least 15 and reapply it every two hours when outdoors, even on cloudy days.
- Wear protective, tightly woven clothing, such as a long-sleeved shirt and pants.
- Wear a hat with a wide, 4-inch brim and sunglasses with UV protective lenses.
- Stay in the shade whenever possible.
- Avoid reflective surfaces, which can reflect up to 85 percent of the sun's damaging rays.

Archery Shooting Basics

The following instructions are written for right-handed shooters. When training left-handed shooters, reverse the instructions as necessary.

Eye Dominance

Before shooting a bow, the participants should determine which eye is dominant. Just as people are either right- or left-handed, one eye is more dominant than the other. Discovering which eye a shooter favors is important because it could determine on which side the bow should be held.

To find which eye is dominant, have participants extend both arms in front of them and form a small hole with their thumbs and index fingers. Instruct them to look at a distant object through the opening and then pull their hands back to their face. The eye that is in line with the object is dominant. Practice sight picture and correct sight alignment.

Assign boys, leaders, and parents in pairs to assist each other, then have them check with the range master.

Stance

Have the archers turn sideways to the target, with their left shoulder toward the target. (Left-handers should stand with their right shoulder toward the target.) Weight should be evenly distributed and feet should be as wide apart as is comfortable (approximately shoulder width). This is called the square stance.

Another way to enter the square stance is to have the archer lay down an arrow so that the arrow points at the center of the target. The archer then places the toes of both feet against the arrow. Straddle the shooting line. Relax the knees—do not lock them backward.

After archers are familiar with the square stance, instruct them to move their right foot forward, toward the person in front of them, until the instep of their right foot lines up with the toe of their left foot. Tell archers to rise up on their toes and take a one-eighth turn toward the target. This is called the oblique stance. The oblique stance allows beginners to use their back muscles immediately, moves the string away from the bow arm so there is less chance of string slap, and provides a secure base.

Golf tees pushed into the ground make good foot markers for consistency in placing the feet. Once the feet are properly positioned, stand erect without jutting the hip. Position the head so vision is parallel with the ground and so the chin is above the left shoulder.

Nock the Arrow

To nock the arrow means to place the arrow on the string and the bow. With your right hand, lay the shaft of the arrow on the arrow rest and nock the arrow by fitting the notched end of the string just below the string's nocking point. Be sure the odd-colored feather (cock) is facing away from the bow.

The left hand holds the bow with the tip tilted away from the body at a 20-degree angle and with the string toward the body. Grasp an arrow by the nock between the thumb and index finger of the right hand.

Each arrow is nocked so it is at a 90-degree angle with the bowstring. Just above the proper nocking point, whip the bowstring with a small piece of brightly colored thread to serve as a nock locator. This mark enables each arrow to be nocked in the same place for consistent shooting.

Place the index finger of the right hand above the nock and the next two fingers below the nock. "Hook" the bowstring with the first joint of these three fingers without curling them and without applying pressure on the arrow nock.

Establish the Bow Hold

Each archer should extend his left arm toward the target with the left hand in a "handshake" position. Place the pivot point of the bow handle in the "V" formed by the thumb and forefinger of the left hand. Drop the forefinger around the back of the bow with the thumb resting lightly over the forefinger. The other three fingers should be pointing toward the target.

Inform archers that the pivot point should touch only the meaty part of the thumb and that no other part of the hand or palm should touch the bow. Extending the last three fingers toward the target will help the students keep the palm off the bow. This should result in a relaxed hold on the bow and avoid "gripping" the bow handle. The wrist should be straight but relaxed. Have the student relax and hold the bow at his side with the string up so the bow does not interfere with students on either side. Tell each student to raise his head, look at the bull's-eye, raise the bow arm to shoulder height, and lower it again to the side.

Draw

Bring the left hand up, turning the hand so the bow assumes a vertical position at arm's length. The heel of the left hand presses against the bow grip with the bow in the V between the thumb and index finger. The left hand should not "grip" or "hold" the bow.

Pressure against the lifeline of the hand from drawing the bowstring keeps the bow in place. Keep slight tension on the bowstring so it rests across the fingertips in between the first joints.

With the three fingers of the right hand serving as hooks, start the draw slowly. The index finger will be above the arrow and the middle two fingers below it. At full draw, the right elbow is back and in direct line with the tip of the arrow. Keep fingers (except the three "hook" fingers), hand, and forearm relaxed.

Keeping the left arm fully extended and the left shoulder down, begin to draw the bowstring with the right hand. The right hand and elbow should stay at shoulder level. The right forearm becomes a straight-line extension of the arrow. Use the strong back muscles to draw the bow, concentrating on smoothly and steadily moving the elbow straight back. Be sure to draw the bow the same length each time.

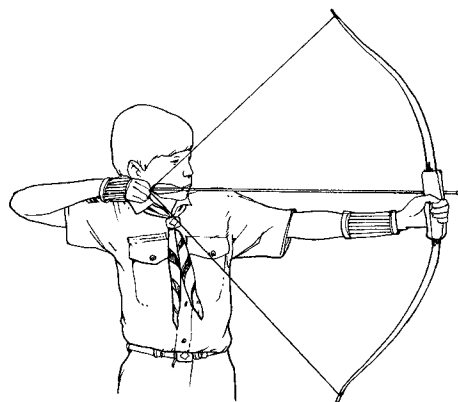

Aim

Two aiming methods are used:

1. **Bow-sight method.** The bow-sight method of aiming is often the most easily understood and is the most useful for target archery.

To establish sights, attach a wooden match with a small rubber band to the back surface of the upper limb of the bow about five inches above the handle. Loop one end of the band around the head end of a match. Stretch the

rubber band around the face of the bow and attach its other loop around the other end of the match. The match head now forms a temporary sight that can be adjusted upward, downward, to the right, or to the left.

Establish a sight for 10 yards by measuring the distance from the pupil of the right eye down to the bottom of the chin. Add to this distance the diameter of the arrow you are using. Measure the total distance on the upper limb of your bow, from the top of the handle up. It will be approximately five inches. Raise or lower the match and rubber band until they coincide with the upper limit of the measurement. The match head should stick out to the left of the bow about $\frac{1}{4}$ inch.

Choose a small one-inch aiming spot on your target, 10 yards away. When the arrow is fully drawn and anchored, raise or lower the bow so the match head is in line with the right eye and the aiming spot, and release the arrow. Shoot three to six arrows in the same way and see where they group.

If all arrows hit the aiming spot, you have established the 10-yard sight. Draw a horizontal pencil line across the back of the bow at the elevation of the match, and mark a "10" on it. Later you can remark it with black ink or a black marker. If the arrows group a little high, push the match up a bit. If the arrows go left, pull the match head out to the left a bit. If they go right, push the match straight to the right.

After establishing the 10-yard sight and recording its elevation in pencil on the upper limb of the bow, stand 20 yards away from the target and try to locate the 20-yard sight. To start, bring the match down about $\frac{1}{8}$ inch below the 10-yard sight and try it out. It will not be far off. The 30-yard elevation mark will be found approximately $\frac{1}{4}$ inch below the 20-yard sight. The 40-yard elevation mark is on sight at nearly $\frac{1}{2}$ inch below the 30-yard sight.

In every case, the sight can only be established by shooting arrows at the new distances and adjusting sights until arrows consistently hit at or near the spot. Sights can be established every 10 yards up to 100 yards. A more permanent and quite satisfactory sight can be made by attaching one or more five- or six-inch pieces of weather stripping to the back of the bow and sticking a steel pin with a black glass or enamel head into it perpendicular to the bow.

2. Point-of-aim method. The point of aim for a given distance may be located once the sight system is established. For example, to find the point of aim at 40 yards, stand on the 40-yard line with the arrow drawn and anchored with the sight aimed on the center of the bull's-eye. While holding this position, glance down across the pile or shaft of the arrow to a spot on the ground seen just above the pile. Keeping the eyes glued on this spot, walk forward, and place the point of aim on that spot. Conversely, if the point of aim for a given distance is known, establish a sight on the bow for it by placing the bow sight on the bull's eye when the pile of the arrow has been sighted on the point of aim.

The more experienced archer will raise his bow and draw to anchor point in one smooth flow of motion. The arrow at this point is not immediately released. Several seconds are used to aim before the fingers release the arrow.

Anchor

At the completion of the draw, the relaxed thumb of the right hand finds an anchor spot under the jawbone. If this is too difficult, rest the forefinger along the side of the jaw. Using the jawbone as an anchor, the bowstring will touch the nose and the center of the chin.

It is important that the anchor point be the same for every shot. Therefore, through practice, the most comfortable anchor point should be established.

Release or Loose

Proper release of a well-aimed arrow makes the difference between a good or poor shot. It is a delicate action. Hold the bow with a relaxed grip. The hand is opened with the fingers moving quickly and precisely off the nock and the string at the same time. The action of the back muscles will cause the right elbow to come back as the shoulder blades come together. If alignment is kept, the right hand will pass along the side of the neck. This is a natural reaction and not a conscious motion if the back muscles are being properly used. Keep the left arm in the same position as for a full draw. Relax the wrist. Keep alignment. Avoid tension. Keep the bow at the same level that it was at full draw.

Follow Through

Keep aiming until the arrow hits the target. Throwing the hand out from the shoulder after the arrow is on its way invariably means that the fingers have been jerked away from the string. After release, the fingers should not be more than an inch away from and behind the anchor point. The bow should not drop immediately. If it does, it usually means that it was jerked at release. Hold the position until the arrow strikes the target to make certain the whole process is smooth. In a good follow-through, your right hand will be at the back of your neck and your arm will be lined up perfectly.

Retrieve Arrows

After all archers have shot their allotment of arrows (usually around six, if time permits), demonstrate and explain the proper methods to retrieve arrows from the target and ground.

First, before any archer goes to retrieve any arrows, permission must be granted by the range master. The range master will observe the archers and indicate when all archers have completed shooting and it is safe to retrieve arrows. At this time:

- Withdraw all arrows from the target.
- Retrieve all arrows that missed the target.
- Record scores.

Caution the archers to walk slowly to the target and watch for arrows on the ground. Demonstrate that an arrow buried under the grass should be withdrawn point first and be completely clear of the grass before the arrow is lifted.

No one may stand directly in front of the target while arrows are being withdrawn.

Archery Games and Activities

A variety of games or activities can be done using archery skills. Different ranges could be set up to play a particular game, or courses could be set up where participants go from station to station. Archery games and alternate activities work well, especially when youth are in camp for more than one day or if a council sponsors a special archery camp for Cub Scouts.

Remember, any place there is an archery range and there is archery shooting, even when playing a game or activity, a qualified archery range master must be present.

Shooting games are designed to improve shooting skills. Remember, safety is a must.

The following activities and opportunities would be appropriate for Tiger Cubs with their adult partners, Cub Scouts, and Webelos Scouts.

Shooting a Competitive Round

Listed below are two rounds that can be adapted for instructional use. When conducting a competitive round or tournament, two practice ends should be allowed before scoring begins. The purpose of these rounds is to expose students to the mechanics of a tournament. The scores might be used as a part of the skill evaluation.

Instructional Round 1

Distance: 20 yards
Target: 36-inch, four-color face
Total arrows: 60 (five arrows per end; four ends per game; three games pre-round)
Score: 5-4-3-2-1
Total Points: 300

Instructional Round 2

(American Archery Council Instruction Round)

Modified Chicago Round

Distance: 20 yards
Target: 36-inch, four-color face
Total arrows: 30 (five arrows per end; six ends per game; one game pre-round)
Score: 5-4-3-2-1
Total points: 150

Modified Flint Round

Total arrows: 30
Score: 5-3
Total points: 150
Station 1: four arrows at 17 yards—
18-inch black-and-white face
Station 2: four arrows at 20 yards—
12-inch black-and-white face
Station 3: four arrows at 20 yards—18-inch face
Station 4: four arrows at 14 yards—12-inch face
Station 5: four arrows at 15 yards—18-inch face
Station 6: four arrows at 10 yards—12-inch face
Station 7: one arrow each at 20 yards, 17 yards,
15 yards, 14 yards, 10 yards, 20 feet—18-inch face
Total points: 300

Tic Tac Toe

Place three rows of three balloons on a target mat. Divide the group into two lines and have them stand in a single file 20 feet from the target. At the signal to shoot, each archer will shoot one arrow and step back. The second and each succeeding person will shoot one at a time. The first team to break three balloons in any line is the winning team.

Wand Shooting

Place a strip of 1-inch masking tape over the target face from top to bottom. A point is scored when an arrow hits the tape anywhere on the target. Divide the group into two lines, and have them stand in a single file 20 feet from the target. At the signal to shoot, each archer will shoot one arrow and step back. The second and each succeeding person will shoot one at a time. The first team to get two points is the winning team.

Shoot the Monster

Participants shoot at a monster face attached or painted on a one-gallon plastic bottle, suspended with shock cord within a tire. The object is to hit the plastic bottle. This event can be scored individually or by den or pack.

Drop in the Barrel

Participants lob an arrow into a barrel that is placed as the bull's-eye of a horizontal target on the ground. Outer rings may be formed with chalk, string, circles of small pennants, etc., at five-foot intervals from the barrel. Scoring may be kept by individual or by den or pack.

Spin the Insect

A picture of an insect is glued to a piece of plywood 12 inches square. The plywood is fastened so it will pivot freely around a centered bar set from post to post when struck with an arrow.

Ring the Bell

Participants shoot at bells through the open end of swinging tires. All tires are swung in unison with a rope tied to the bottom of each tire and extended to an area beyond the limits of firing on the side.

Football Placekick

A scaled-down goalpost is erected behind a four-foot-high canvas sheet. From the firing line the archer can see only the top portion of the goalpost uprights. An arrow shot between the uprights above the crossbar scores as a field goal (three points), while an arrow that passes over the canvas and under the crossbar scores as a touchdown (six points). A raised platform should be set up adjacent to the shooting positions so an observer can determine the scoring since the archer is not able to see the lower portion of the goalposts.

Archery Practice Fun

Any station set up for boys to practice skills is a fun station for the Cub Scouts. Boys have limited times to shoot arrows, so the opportunity to practice at a council camp or event is a great experience for them. A practice station is a simple, basic archery range, but a very fun one for the boys.

Archery stations could also be set up to practice stringing bows or learning how to care for some of the equipment. Helping with some of the archery equipment could be a rainy day activity.

Action Archery Course

An action archery course could be set up using several of these games as different stations in the course. A drawing of a sample action archery course is found on page 108.

Cub Scout Shooting Sports Award

The Cub Scout Shooting Sports Award, No. 34216, may be awarded to a boy whenever he achieves a level of marksmanship or excellence. The archery range master, with other leaders of the camp or event, may determine special circumstances where a unique award might be useful. The award might be given for proficiency in shooting, best sportsmanship, or for some other appropriate achievement.

The award is available from the National Distribution Center in packages of 100.



Archery Belt Loop and Sports Pin

Archery belt loops and sports pins may be earned only through council- or district-sponsored programs.

Quality camp programs will offer an archery shooting program that allows boys to meet the requirements for earning the Archery belt loop. In a program where boys come for more than one day, councils should offer activities that meet the requirements for the Archery sports pin. Dens and packs enjoy coming to council camps where they have an opportunity to earn belt loops and sports pins that cannot be earned at home.

See the sample certificates on page 100. Use these certificates to show that boys have met the requirements for the loops and pins. Their pack may then purchase the Archery belt loops and sports pins at their local Scout shop.

Tiger Cubs complete requirements while working with their parent or adult partner. Parents and partners do not earn loops or pins. All requirements must be completed under the supervision of a certified archery range master.

Belt Loop Requirements

Complete the following three requirements:

1. Explain the rules for safe archery that you have learned in the district/council camp or activity you are attending to your leader or adult partner.
2. Demonstrate to your leader or adult partner good archery shooting techniques, including the stance and how to nock the arrow, establish the bow, draw, aim, release, follow through, and retrieve arrows.
3. Practice shooting at your district or council camp for the time allowed.

Sports Pin Requirements

Earn the Archery belt loop and complete five of the following:

1. Explain the parts of a bow and demonstrate how to string the bowstring in a proficient manner.
2. Demonstrate how to properly use archery equipment, including arm guards, finger tabs, and quivers, and explain about proper clothing.
3. Develop proficient shooting techniques by practicing for three hours.
4. Learn the correct scoring techniques for target archery.
5. Make a poster that emphasizes the four whistle codes.
6. Draw to scale or set up an archery range.
7. Shoot 30 arrows from a distance of 30 feet at a target and score at least 50 points, or shoot 30 arrows from a distance of 90 feet and score at least 30 points.
8. Help make a type of target for the camp archery range.
9. Show how to put away and properly store archery equipment.
10. Tell five facts about an archer in history or literature.

Range Layout

Review the archery range layout below. Safety is a primary concern when operating an archery range, and the safety rules must be followed.

If at all possible, the range should be laid out so shooting is done in a northerly direction so archers are never facing the sun. To protect arrows, all outcropping rocks should be reduced to ground level. Grass should be planted so a good sod is developed. Keep grass cut close and raked clear. Sandy soils needs no ground cover.

Important! Arrange facilities so there is no possibility of non-participants inadvertently walking behind the targets while shooting is in progress!

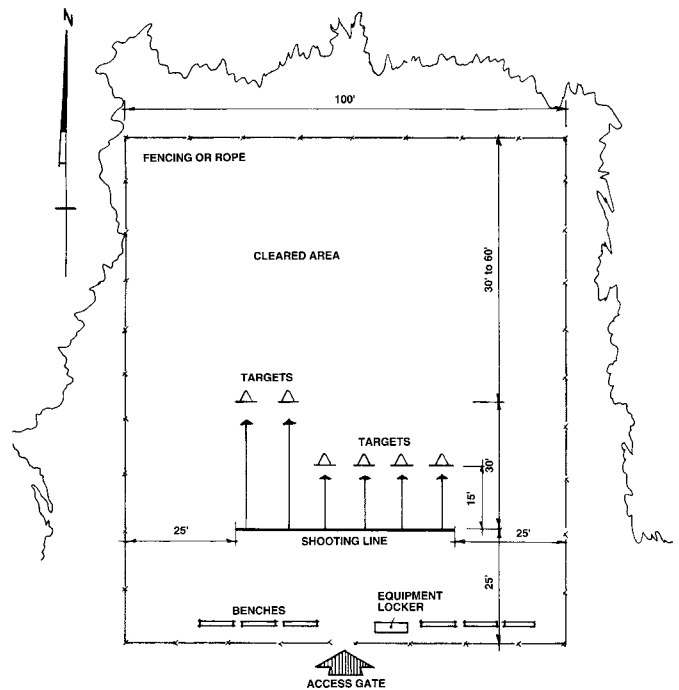

Range Operation Rules

1. Never operate a range without adult supervision.
2. Be sure all safety rules are understood and followed.
3. Range flags must be flown while the range is in use.
4. Check all equipment before using to be sure bows, bowstrings, and arrows are in safe condition.
5. All spectators and boys waiting to shoot must remain behind the waiting line at least three yards behind the shooting line.
6. Archers must wear shoes on the range at all times.
7. Archers may not allow anyone to hold a target for them.
8. Archers must not talk or disturb shooters on either side when they are shooting.
9. Archers stay on the shooting line until their target partners have shot their last arrows, and then both step back together.
10. Use the proper whistle codes.
11. Use the proper scoring techniques.
12. No running is allowed on the ranges at any time.

Sample Range Rules Poster

Archery Range Rules

1. This range may be opened only by a certified archery range master.
2. All commands issued by the range master must be obeyed immediately.
3. Stay behind the firing line. Do not straddle the firing line. Do not reach for objects that fall beyond the firing line.
4. Bows will be placed on ground quivers when shooting has ceased or when retrieving arrows. No bows may be carried to the target butts.
5. Do not pick up a bow or nock an arrow unless told to by the range master.
6. Absolutely no running on the range. Belt quivers should be used while retrieving arrows.
7. No horseplay or unnecessary talking on the range.
8. If in doubt about these rules, ask your leader or range master for advice and help.

Equipment

When not in use, archery equipment should be kept in locked storage to protect it from weather, rodents, and theft. (For instructions on how to build storage lockers and other storage equipment see pages 103–106.)

Archery Equipment for 100 Campers

Many of the following items are available through the National Distribution Center. For additional sources, see Resources, page 97.

- Six 48-inch target faces mounted on straw target butts and tripods or on stacked, baled straw
- 10 bows—four 15-pound, four 20-pound, and two 25-pound
- 12 bowstrings
- 12 finger tabs
- 12 arm guards
- 60 arrows selected to fit bows
- 36 action archery arrows
- Two sets of field archery targets
- 60 plastic jugs (various sizes)
- 12 ground quivers (camp-made)

Bows

Beginners should use a very light bow with no more than a 25-pound pull. Pull is the force in pounds required to draw the bow a specified length. Bows of this weight are usually about 56 to 66 inches long. The bow should not be so heavy that the archer tires himself handling it.

The question has been asked as to which bows should be used: compound bows or recurve bows. Most discussions suggest that beginning archers should learn on a recurve bow. The recurve bow allows the archer to better learn proper finger tension, where the compound bow is a programmed bow with little room for variation.

Modern recurve bows are either made entirely of fiberglass or are a composite of wood and fiberglass. Both are satisfactory for beginning instruction. Fiberglass bows require less care, are less expensive, and are more serviceable for beginning classes. Intermediate and advanced groups could use laminated bows, which have superior shooting characteristics.

When purchasing bows, consider that some shooters will be left-handed. If purchasing fiberglass bows, select a type that can be shot from either side. If purchasing laminated bows, about 10 percent should be left-handed.

PARTS OF A BOW

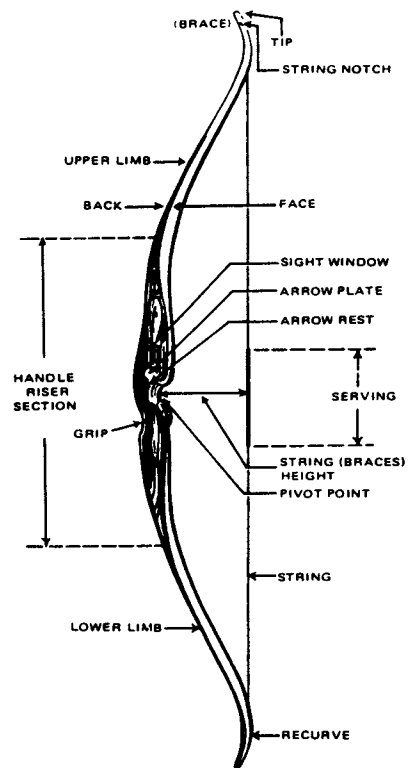

Care of Bows

Some basics to follow in the care of your bows whether they be wood, metal, or fiberglass:

- Never lay a bow on the ground.
- Never stand a bow on end.
- Store bows by laying them on pegs that support the bow in the handle riser section.
- Although finishes are waterproof, it is best to dry the bow if it gets wet. Bow wax will help preserve the finish on the bow.

- Carry a bow unbraced in a bow case to protect it from scratches and possible damage.
- Never leave a bow in an automobile as the heat from the sun may cause damage. Store bows unstrung and, if possible, in a cool place with moderate humidity.

Bowstrings

The National Archery Association advises beginners to use bowstrings made of Dacron with a serving (a wrapping of thread that protects the bowstring at the point where the arrow is set) made of multifilament nylon thread.

Keep the bowstring well waxed with either a commercial bowstring wax or one you make yourself using one part resin to three parts beeswax.

Inspect the string carefully before and after each day's shooting. If any of the strings are broken, discard the string. Check the serving and repair or replace it if it is loose or worn.

Replacement bowstrings should be ordered according to the length and weight of the bow. If a bow is marked 56 inches, 20 pounds, order a 56"-20# string. Do not order by the actual measured length of the string.

Bow Stringer

Always use a bow stringer to string a recurve bow. The step-through and push-pull methods can cause permanent damage to bows by torquing their limbs. A bow-stringer is a piece of string about 5 feet long that has a leather cap at each end. The larger cap attaches over the bottom bow notch and the smaller cap goes over the upper bow notch. The top cap is small enough for the bowstring to be slipped into the bow notch.

To string a bow, position the bottom end of the bowstring in the bottom notch and slip the caps of the bow-stringer over the ends of the bow. Holding the bow by the grip, allow the stringer to rest on the ground. Step on the center of the bow stringer and smoothly pull upward on the bow grip to tension the bow. Using the thumb and index finger, slide the top loop of the bow-stringer into the upper bow notch.

Check the bow to make sure the bowstring is properly in place. To unstring a bow, tension it and guide the top loop down. Bows that are not in use should be unstrung before being stored.

Arrows

Most young beginners will use 26-inch-long arrows. Longer arrows may be provided for larger boys and adults. Arrows of Port Orford cedar, pine, birch, aluminum, or fiberglass are suitable for beginners. Wood arrows are the least expensive, but aluminum and fiberglass arrows are more durable and will last much longer. If there is little possibility of losing them, aluminum or fiberglass arrows may be the best buy.

Advanced archers will become concerned with matched arrows (spine and weight) for their own bows. At this point, such equipment should be secured as personal property. Its acquisition becomes a matter of personal preference. Interest in this is a payoff for the instructor.

A general rule for determining bow length is as follows:

- Draw your bow using an extra long arrow to your normal full draw.
- Have someone mark the arrow shaft at least one inch directly in front of the spot where the arrow contacts the most forward position of the arrow rest. This is the correct arrow length for you. Beginners may want to add one to two inches to correct arrow length to ensure the arrow will not be too short once their shooting technique improves.

For planning purposes, the following averages may be helpful:

- The average adult male uses a 28-inch arrow.
- The average adult female uses a 26-inch arrow.
- The average teenager uses a 26-inch arrow.
- The average youth 12 years old or younger uses a 24-inch arrow.

Care of Arrows

Feathers on arrows should be kept dry. If the feathers become wet, wipe them dry and clean before storing. Separate the arrows until they are dry to allow the feathers to expand and regain their original shape. If the feathers are matted down, they can be steamed to return them to their original shape.

Discard any fiberglass or wooden arrows that have splinters or cracks in the shaft.

The arrows can be kept in the quivers during the season, but if they are not going to be used for several months, it is best to store them in the boxes in which they were received. These boxes have individual holes for each arrow. This will preserve the feathers and help prevent wooden arrows from warping.

Arm Guards

The arm guard is either leather or plastic with at least two elastic straps. It is slipped over the forearm that holds the bow and provides protection from the slap of the bowstring after the arrow is released.

Care of Arm Guards

Arm guards should have laces or elastic replaced when needed. Arm guards should be kept in labeled boxes. All leather goods will last longer if stored in a cool, dry place and occasionally cleaned with saddle soap.

Every shooter must use an arm guard and finger protector.

Finger Tabs

Finger tabs are preferable to gloves for group instruction because they present fewer fitting problems. Made of smooth leather, finger tabs absorb the friction of the bowstring across the fingertips. Without them, painful blisters can develop. Many designs are available, but for beginners the simplest and most inexpensive type is satisfactory.

Quivers

For the young beginner, having a quiver to use when returning arrows from the target to the shooting line will improve safety procedures. (See page 102.)

Point of Aim

The point of aim is simply a small piece of paper or light-colored plastic that can be readily seen when placed on the ground in front of a target. The archer uses it as a sighting point when shooting at the target.

Targets and Scoring

Target Butts

Targets for beginners should be about 48 inches in diameter and made of straw or Ethafoam. The target butts are placed on soft-pine tripods, about six inches off the ground. (Ethafom is the proper material for a target butt. Plastic foam is messy and does not last long.) Keep the targets close to the ground so missed arrows will not go far and so younger archers can reach the highest arrows easily.

Three to five bales of straw may be stacked to serve as target butts. Make sure the bales are tied back to a post so they will not fall forward on someone pulling arrows. Care should be taken in stacking the bales to be sure they are very close together. Keep the bales off the ground by stacking them on old tires.

Target Faces

The 48-inch standard target face is recommended for use on outdoor ranges. These are printed on several types of material, including heavy paper, canvas, and oil cloth. If you use paper targets, paste them to light cardboard or they will not last long. Smaller targets are made to be shot at from shorter distances.

The target is made up of five concentric color zones. Each zone is divided by a thin line into two scoring zones of equal width. Each circle represents the following point values:

- Inner gold = 10 points
- Outer gold = 9 points
- Inner red = 8 points
- Outer red = 7 points
- Inner blue = 6 points
- Outer blue = 5 points
- Inner black = 4 points
- Outer black = 3 points
- Inner white = 2 points
- Outer white = 1 point

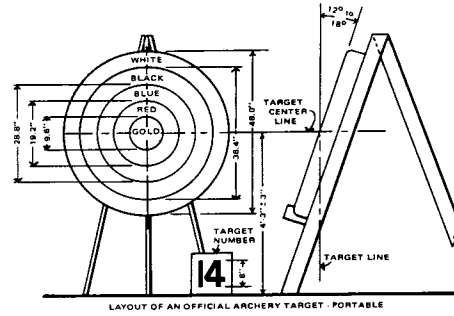

Care of Target Faces

Target faces should be removed from mats when the mats are being moistened. Masking tape applied to the back of a target face that is tearing from much use will help it last longer. Center patches that cover the gold and part of the red scoring areas on the target face will double the life of the target faces. The patches must be carefully aligned so the lines marking the scoring areas line up exactly.

Backstops

Baled straw stacked behind the target will catch wild shots. Also, several layers of burlap, old canvas, or rugs hanging loosely over a horizontal pole or plank 1 or 2 inches wide will stop arrows that miss the target. These materials will last much longer if they can be rolled up and stored between seasons.

Any indoor backstop should be a minimum of eight feet from the top to the floor. A backstop should be hung two to three feet from the wall and two to 10 feet behind the targets to prevent arrows from hitting the wall. If there is a possibility of arrows hitting and damaging the floor in front of the targets, such as in a gymnasium, rest the targets on rubber runners, canvas-covered tumbling mats, or on a rug that extends six to eight feet in front of the targets.

Chapter 11: BB Gun Shooting

BB gun shooting is an exciting, worthwhile activity for boys, and it is one of the most popular program activities held at Cub Scout camps. BB gun shooting provides fun and adventure, yet also teaches skills, discipline, self-reliance, and sportsmanship. We will teach Tiger Cubs with their adult partners, Cub Scouts, and Webelos Scouts how to use BB guns safely.

Intelligent, supervised use of BB guns is consistent with the principle of “safety through skill.”

Approval has been given for BB gun (defined as a smoothbore spring-piston or air rifle propelling shot known as “BBs”) safety and marksmanship programs in district or council Cub Scout programs. **The barrel velocity has been changed to 350 feet per second maximum.** Tiger Cubs and Cub Scouts are not permitted to use any other type of handgun or firearm.

The use of pellet air rifles is restricted to Webelos Scouts in a resident camp setting and qualifies when in compliance with the following:

- The air rifle pellet gun range meets or exceeds BSA and NRA recommendations and appropriate BSA Engineering Service design standards. The range is on council-owned property.
- All rifles in good repair are provided. All rifles used in BSA shooting sports have a trigger pull in excess of 2.5 pounds and are tested with a 2.5-pound weight or scale at least once a week while in use. If any trigger mechanism fails, the air rifle is immediately removed from service. Documentation of the tests is maintained.
- All air rifles (CO₂, pump, break barrel, etc.) are limited to single-shot designated for target shooting, velocity of 500 to 540 feet per second, and energy levels not to exceed 7.5 joules.
- Safe, separate and locked storage (can be the same building) is provided for pellet guns, pellets, and CO₂ cylinders and bulk tanks.
- Air rifle propellant is limited to CO₂ cylinders or air compressor/scuba tanks. Refilling is conducted by qualified adults with appropriate controls. If scuba tanks are used, each tank must be visually inspected annually and hydrostatically tested every five years by a qualified technician.

A Brief History of BB Guns

In ancient history, blowguns began to appear in many different parts of the world. Although crude, these primitive weapons were very accurate. They were made from bamboo or other hollowed-out woods.

A blowgun is a tube into which a hunter blows to shoot a projectile out the other end. This idea was transferred into gun form somewhere in the 1500s. The bellows gun, invented around 1580, is the earliest known air-powered gun.

A few decades later, the first pneumatic (pump-up) air gun was created in France for King Henry IV. The nobility usually owned these early guns, since they were too expensive for commoners.

In the late 1700s, some units of the Austrian army were equipped with air rifles.

In America, records show that in the 1800s, Lewis and Clark had an air gun for hunting and impressing the native Americans. The native Americans called it “the smokeless thunder stick.”

In 1885, in the United States, the Markham Air Rifle Company became one of the first companies to sell BB guns. These pneumatic rifles eliminated bullets and used a small pellet the size of a ball bearing, soon to be called a “BB.”

A few years later, a company that sold steel windmills decided to also sell BB rifles. By 1895, this company had stopped producing windmills and made air rifles full-time and changed the company name to Daisy.

Daisy’s guns were mostly made of steel, which improved the gun’s strength and design. The Daisy air rifle became popular very quickly, and within five years Daisy had sold 250,000 BB guns. Soon, Daisy bought out all of its competition.

Daisy also promoted to youth by making special BB guns that related with popular historical characters like Davy Crockett.

In 1984, the Olympic Games featured air guns for the first time.

Today, BB guns are still being produced in both rifle and pistol forms and are very popular among all age groups.

Leadership

BB gun shooting must be conducted by trained, qualified, on-site range masters who actually direct the operation of the range program and BB gun shooting instruction. To qualify as a BB gun range master, the range master must be at least 18 years old and be trained by a National Camping School-trained shooting sports director or a National Rifle Association rifle instructor or NRA/USA Shooting/CMP certified rifle coach.

The BB gun range master also must be registered with the Boy Scouts of America.

The local council issues a Training Course Pocket Certificate, No. 33767, and keeps a record of those who have been certified. Certification must be renewed every two years.

Training BB Gun Range Masters

Use this outline to train BB gun range masters for district or council Cub Scout camps or events. The NRA rifle orientation, when applied to air guns, may also be taught as long as the following topics, including Section IV, are covered.

Section I (40 minutes)

- A. A Brief History of BB Guns, page 83
- B. Safety Guidelines, page 85
 - 1. Safety Reminders, page 85
 - 2. What Causes Gun Accidents?, page 85
- C. Equipment, page 92
 - 1. Review air guns, air compression mechanisms, safety devices, air gun ammunition, target faces, and backstops.
 - 2. Review how to maintain, store, and care for equipment.

Section II (40 minutes)

- A. Range Layout, page 91
- B. Range Operation Rules, page 92

Section III (40 minutes)

- A. Training Cub Scouts, page 84
 - 1. Teaching Tips, page 84
- B. BB Gun Shooting Basics, page 86
 - 1. Eye Dominance, page 86
 - 2. Shooting Shoulder, page 86
 - 3. Breathing, page 86
 - 4. Sight Alignment, page 86
 - 5. Trigger Squeeze, page 86
 - 6. Follow Through, page 86
- C. Shooting Positions, page 87
 - 1. Free-Arm Standing Position, page 87
 - 2. Prone Position, page 87
 - 3. Kneeling Position, page 88
 - 4. Sitting Position, page 88
- D. Sighting and Scoring Targets, page 88
- E. Range Commands, page 92
- F. BB Gun Shooting Practice Fun, page 89

Section IV (30 minutes)

- A. Basic Shooting Activity, page 88
- B. BB Gun Shooting Games and Activities, page 89
- C. Tiger Cubs and BB Gun Shooting, page 85
- D. Cub Scout Shooting Sports Award, page 90
- E. BB Shooting Belt Loop and Sports Pin, page 90

Training Cub Scouts

The objective is to teach Cub Scouts how to use a BB gun safely, to teach basic BB gun shooting skills, and to have fun. They should have the opportunity to fire a BB gun during the first orientation period. This activity is not intended necessarily to produce expert marksmen.

The instructor must always be mindful of his or her responsibility to make safety thoroughly understood before, during, and after instruction and practice. At the same time he or she must have warmth, patience, and understanding for the boy who finds the skill difficult to learn.

Teaching Tips

The coach-pupil method is effective for all types of skill training and is particularly effective in shooting sports. To put this method into practice:

- Put the BB gun in the Cub Scout's hand as soon as possible so he can understand the BB gun while the basics are explained.
- Group participants into pairs (boy and parent/guardian would be ideal).
- The instructor demonstrates the activity or action to be followed before the whole group. When demonstrating techniques, be sure to do them correctly. The instructor then circulates among the pairs giving a word of advice or assistance, recognizing good work, correcting errors, and determining how well the participants understood the method.
- The boy practices while the parent coaches. Let Scouts shoot the first round. At a predetermined signal, reverse the roles. Progressively, participants are learning by observing, by doing, and by coaching.
- Use a positive approach. Use praise sincerely. Before making a correction, question the fault to find the cause. Do show a boy what he is doing wrong.
- Avoid long discussions on the parts of the equipment used. Teach just enough so participants will know how to safely use the equipment.
- Allow each boy to feel the satisfaction of hitting a target as quickly as possible.

Cub Scout BB Gun Shooting Training

Use this outline to train Cub Scouts to participate at a BB gun range at district or council Cub Scout camp.

Section I (20 minutes)

- A. Safety Guidelines, page 85
- B. Equipment, page 92
 - 1. Review air guns, air compression mechanisms, safety devices, air gun ammunition, target faces, and backstops.
 - 2. Review how to maintain, store, and care for equipment.

Section II (40 minutes)

- A. BB Gun Shooting Basics, page 86
 - 1. Eye Dominance, page 86
 - 2. Shooting Shoulder, page 86
 - 3. Breathing, page 86
 - 4. Sight Alignment, page 86
 - 5. Trigger Squeeze, page 86
 - 6. Follow Through, page 86
- B. BB Gun Shooting Practice Fun, page 89

Section III (60 minutes) (optional activities)

- A. Shooting Positions, page 87
 - 1. Free-Arm Standing Position, page 87
 - 2. Prone Position, page 87
 - 3. Kneeling Position, page 88
 - 4. Sitting Position, page 88
- B. BB Gun Shooting Games and Activities, page 89
- C. Cub Scouting Shooting Sports Award, page 90
- D. BB Shooting Belt Loop and Sports Pin, page 90

Tiger Cubs and BB Gun Shooting

Tiger Cubs and their adult partners may participate in BB gun shooting activities. The adult partners must be included in all shooting activities. Each Tiger Cub must be paired with his adult partner before being allowed to shoot. In most cases, when Tiger Cubs and their adult partners participate in BB gun shooting, it will be at a day camp.

Keep in mind that boys of this age have very short attention spans (20 to 30 minutes maximum) and tire easily. They probably have little previous experience working as a group and may require more time to understand how the range operates. Tiger Cubs have a wide range of ability and experience levels, so be ready for anything!

Tiger Cubs may earn the BB Shooting belt loop and sports pin.

Safety Guidelines

When training youth to shoot, be sure to have proper equipment, secure and safe ranges, and clear safety instruction.

Gun safety is a simple but continuous process. Youth must first learn about safe gun handling. Safe handling skills are developed through practice. The most important safety element is attitude. All the safety knowledge and skills are of little value unless they are used. Being safe means consciously keeping a BB gun under control.

Before handling any gun, a boy must always get permission from his parent or guardian. If this is his first BB gun shooting experience, he should sit down with an adult and discuss under what circumstances the gun can be handled. He must understand that the BB gun is not a toy.

Before using a gun:

- Always get permission from your parent or guardian.
- Always have an adult present when you use a gun.
- Know how the gun works and how to use it.
- Always be sure of your target and what is beyond the target.
- Always wear eye protection.
- Never reuse BBs.

These basic rules apply to handling a BB gun under any circumstances:

1. Always keep the gun pointed in a safe direction. This is the primary rule of gun safety. "Safe direction" means the gun is pointed so that even if it were to go off, it would not cause injury or damage. The key to this rule is to control where the muzzle or front end of the barrel is pointed at all times. Common sense dictates the safest direction depending on circumstances.
2. Always keep your finger off the trigger until you are ready to shoot. When holding a gun, rest your finger along the side of the gun or the trigger guard. Until you are actually ready to fire, do not touch the trigger.
3. Always keep the gun unloaded until ready to use. When you pick up a gun, carefully point it in a safe direction. Engage the safety, if possible. Then, while keeping your finger off the trigger, open the action and look inside the chamber(s) to make sure it is clear of ammunition. If the

gun has a magazine, remove it before opening the action and make sure it is empty. If you do not know how to open the action or inspect the chamber(s), leave the gun alone and get help from someone who does.

4. Know how to use a gun safely. Before handling a gun, learn how it operates. Know its basic parts and how to safely open and close the action. Know how to remove ammunition from the gun or magazine.
5. Be sure the gun is safe to operate. Just like other tools, guns need regular maintenance to remain in good working order. Regular cleaning and proper storage are part of the gun's general upkeep. If there is any question about a gun's ability to function, then do not use it. Get someone to fix it!
6. Use only the correct ammunition for the gun. Only the BB designed for a particular BB gun can be fired safely in that gun. Do not shoot the gun without loading the proper ammunition.
7. Wear eye protection. Always wear eye protection. Shooters and instructors should wear approved safety goggles at all BB gun ranges. BBs may ricochet.
8. Never use alcohol or drugs before or when shooting. Alcohol or any other substance likely to impair normal mental or physical function must not be used before or while handling or shooting guns.
9. Most guns have a mechanism called a safety that helps prevent the gun from accidentally firing. However, a safety is a mechanical device, which can and will fail. Shooters must be trained that the safety mechanism is not a sure, safe way to prevent a gun from firing. Many accidents have occurred because shooters have relied on the safety mechanism to work.
10. Although not mandatory for BB gun shooting, ear protection may also be worn. Shots fired from guns are loud, and the noise could damage the hearing of some shooters.
11. Know your target and what is beyond the target. Be absolutely sure to identify the target beyond any doubt. Equally important, be aware of the area beyond the target. Never fire in a direction where there are people or where any other potential for mishap might exist. Think first. Shoot second.
12. Store guns so they are not accessible to any unauthorized person. Deciding where and how to store guns and ammunition depends on several factors and include security and accessibility. Safe and secure storage means untrained individuals (especially children) are denied access to guns and ammunition.

What Causes Gun Accidents?

Most air gun accidents are caused by ignorance and/or carelessness.

- *Ignorance:* A lack of knowledge
- *Carelessness:* Failure to use knowledge

Safety Reminders

What should a Cub Scout do if he finds a gun in another place?

- STOP!
- DON'T TOUCH!
- LEAVE THE AREA!
- TELL AN ADULT!

Sun Safety on the Shooting Range

The American Academy of Dermatology advises the following protection tips against damaging rays:

- Limit exposure to the sun between 10 a.m. and 4 p.m., when the sun's rays are the strongest.
- Generously apply sunscreen with a sun protection factor (SPF) of at least 15 and reapply every two hours when outdoors, even on cloudy days.
- Wear protective, tightly woven clothing, such as a long-sleeved shirt and pants.
- Wear a hat with a wide, 4-inch brim and sunglasses with UV protective lenses.
- Stay in the shade whenever possible.
- Avoid reflective surfaces, which can reflect up to 85 percent of the sun's damaging rays.

BB Gun Shooting Basics

Eye Dominance

Before shooting a gun, the participants should determine which eye is dominant. Just as people are either right- or left-handed, one eye is more dominant than the other. Discovering which eye a shooter favors is important because it could determine on which side the gun is held.

To find which eye is dominant, have participants extend both arms in front of them and form a small hole with their thumbs and index fingers. Instruct them to look at a distant object through the opening and then pull their hands back to their face. The eye that is in line with the object is dominant.

Shooting Shoulder

It is recommended that a shooter use the shoulder that is on the same side of the body as the dominant eye. If the right eye is dominant, place the firearm against the right shoulder. If the left eye is dominant, use the left shoulder.

Breathing

When shooting, stop breathing before firing a shot. Breathing causes the body to move and makes it difficult to maintain a steady sight picture. Before firing, relax and get comfortable. Then exhale and stop breathing. This technique will help shooters aim by reducing the body and rifle movement in relation to the target. Do not stop breathing for longer than eight to 10 seconds while aiming at the target. If you are not able to shoot within that time, stop, take a breath or two, and repeat the process.

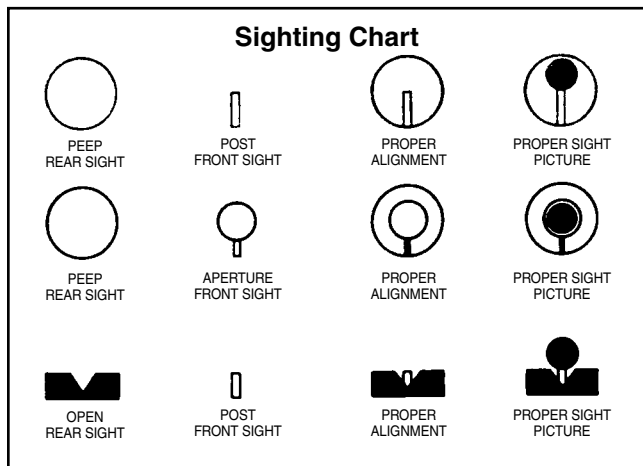

Sight Alignment

The shooter must learn proper sight alignment. This is the relationship of the front and rear sights to the eye. The shooter's dominant eye must be lined up with the front and rear sights, and the sights must be positioned so the front sight device is aligned properly with the rear sight.

Proper sight alignment is a key to accurate shooting. Any misalignment of the front sight with the rear sight introduces an angular error that is multiplied with distance.

A correct sight picture is obtained by achieving the proper alignment and then putting the aligned sights into their proper relationship with the target.

Trigger Squeeze

Trigger squeeze is the term used to explain how pressure is applied to the trigger. Some other terms commonly used are trigger pull, trigger control, trigger press, and trigger movement. While all these terms are correct, the preferred term is trigger squeeze because it accurately describes the smooth application of pressure required.

When ready to begin squeezing the trigger, the index finger should be on the trigger so the trigger is about halfway between the tip of the finger and the first joint.

The trigger must be squeezed straight back in a smooth, continuous manner without disturbing the sight alignment. Once trigger squeeze has begun, keep squeezing smoothly and continuously—do not speed up or slow down or apply pressure in a start-and-stop manner. Use the same type of pressure that would be used to squeeze a drop of liquid from a medicine dropper—a gradual, steady application of pressure until the drop finally falls. Just as it would be impossible to predict the instant the drop of liquid will fall, it should be impossible to predict the precise instant the gun will fire. Each shot should come as a surprise.

For best results, trigger squeeze and sight alignment must be done simultaneously.

Follow Through

The shooter must also master proper follow-through. Follow-through means to continue to do everything that was being done at the time the shot was fired. In other words, keep aiming until the BB hits the target.

The idea is to prevent any unnecessary movement before the projectile leaves the barrel. Because an air gun takes longer to send a projectile out of the barrel, proper follow-through is particularly important.

Shooting Positions

Proper body position is essential to achieve a good shooting score. When learning any shooting position, these basic steps must be followed:

1. Study the position.
2. Practice the position without a gun. (Learn to put the feet, legs, body, head, and arms in the correct position without holding a gun.)
3. Practice the position with a gun.
4. Align the position properly with the target. Adjust the position so the gun points naturally at the target.
5. Shoot from the position.

A number of positions are used in air rifle shooting. The position used depends upon the type of shooting being done. The free-arm standing position is used most often. The arm-rest standing position is used when a high degree of stability is required, as in competitive shooting events. The prone position or bench rest position is the steadiest because the elbows and almost all of the body are in contact with the ground. Following are some positions described in detail. The directions are for right-handed shooters. Left-handed shooters should adjust their positions accordingly.

Free-Arm Standing Position

Body position:

- **Feet.** Stand with feet shoulder width apart and body weight evenly distributed.
- **Body and head.** Keep the body and head comfortably erect.
- **Knees.** Keep the knees straight but not locked.
- **Left arm.** Rest the left arm against the rib cage to support the rifle.
- **Left hand.** Place the left hand under the fore-end of the rifle to support the weight of the rifle.
- **Right hand.** Grasp the rifle grip with the right hand.
- **Right shoulder.** Position the rifle butt against the right shoulder so the sights are at eye level.

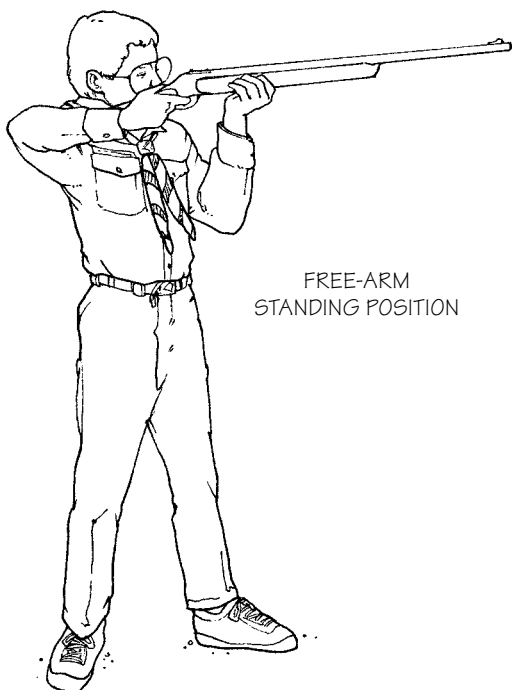

FREE-ARM
STANDING POSITION

How to move into position:

- Keep the rifle pointed in a safe direction and the index finger off the trigger. Hold the rifle in both hands and move to the firing point.
- Turn the body so the left side of the body is closest to the target.
- Raise the rifle to eye level and position it against the right shoulder.
- Align the body's position with the target.
- To correct aim right or left, move the feet. To make vertical adjustments, raise or lower the rifle. To make horizontal adjustments, move the feet.

Prone Position

Body position:

- **Body.** Lie on the ground, facing the target and angled slightly to the left.
- **Right knee.** Slightly bend the right knee.
- **Right leg.** Draw the right leg up, keeping it parallel to the back, and place the right foot on the ground.
- **Left elbow.** Extend the left elbow forward.
- **Left hand.** Hold the fore-end of the rifle with the left hand.
- **Right hand.** Grasp the rifle grip with the right hand.
- **Right shoulder.** Position the rifle butt against the right shoulder so the sights are at eye level.

How to move into position:

- Keep the rifle pointed in a safe direction and the index finger off the trigger. Hold the rifle in both hands and move to the firing point.
- With the rifle held in the left hand and pointed in a safe direction, use the right hand to help lower the body to a kneeling position. Continue to hold the rifle in the left hand, pointed in a safe direction, and lower the body to the floor (again using the right hand to assist).
- Extend the left elbow forward.
- Raise the rifle to eye level and position it against the right shoulder.
- Align the body's position with the target. To correct aim right or left, pivot the body around the left elbow. To correct aim up or down, move the left hand forward to lower the rifle or backward to raise the rifle.



PRONE POSITION

Kneeling Position

- Kneel in a comfortable position.
- Keep the right knee on the floor with the foot directly under the center of the buttocks.
- With the instep and toes of the right foot flat on the ground, sit on the bottom of the heel, not on the back of the foot. Use a kneeling roll on the instep to take pressure off the foot.
- Place the flat part of the left elbow on the flat part of the left kneecap.
- Lay the rifle in the left hand for support. To correct aim, pivot the body on the right foot. Adjust the left foot for balance.

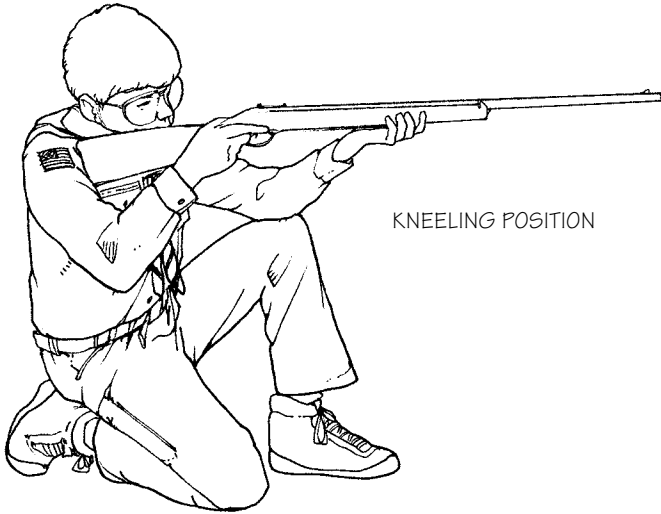

Sitting Position

Sitting is a new variation on the arm-rest standing position.

- Sit cross-legged at a 45-degree angle to the line of fire.
- With the sides of the feet flat on the ground, rest the calves on the upper sides of the feet.
- Rest both elbows on the legs just behind the knees.
- Hold the rifle in the left hand with fingers relaxed.
- Grasp the rifle grip with the right hand.
- To correct aim to the right or left, pivot the body. To correct aim up or down, move the supporting arm forward to lower the rifle or backward to raise the rifle.
- To help with proper sight alignment, position the stock against the shoulder.

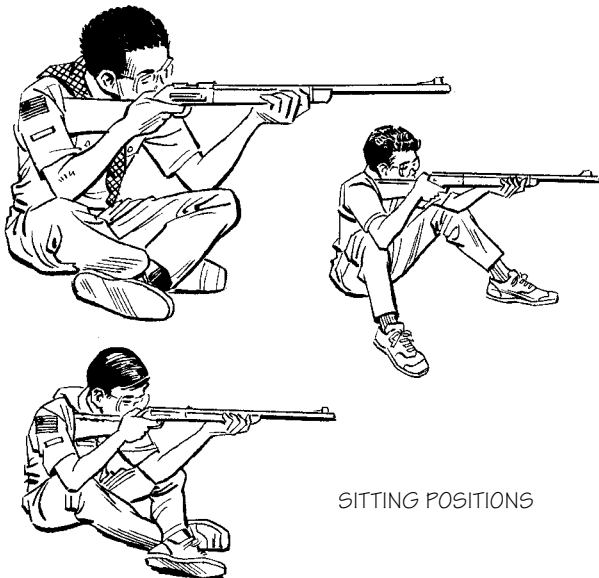

Sighting and Scoring Targets

Have the instructor zero all BB guns before the range is used the first time. Use a supported position (sandbags or other type rest placed on the deck or on a sturdy table) to zero BB guns. The objective is to determine where the BB gun places holes in the target when the effects of human factors (including breathing, trigger squeeze, and position) are minimized by using a rest. A correct sight picture and alignment with a six o'clock hold must be used. Adjust the sights to achieve a 10-ring score.

When the BB gun is properly zeroed, fire a minimum of three shots onto a final target for a sighting record. Put the BB gun number on the target, sign and date it, and post it on the range bulletin board.

When a camper fires a good group outside the 10-ring, review sight adjustments. Sighting aids are available that can be used for instruction. The Paige Instructional Sighting Device, available through the National Rifle Association, is a popular aid.

Basic Shooting Activity

This shooting activity covers many of the basic fundamentals needed in shooting a BB gun. Pair boys and adults as shooters and coaches.

1. Greet the participants.
2. Bring the participants onto the range.
3. Show the gun and say "This is a BB gun."
4. Point to the barrel and say, "This is the barrel."
5. Point to the muzzle and say, "This is the muzzle. It is the end the BB shoots out."

Always keep the gun pointed in a safe direction.

6. Point to the action and say, "This is the action. It has the trigger—the part you squeeze to shoot."

Always keep your finger off the trigger until you are ready to shoot.

7. Say, "The action also has the chamber where you put the BB to load the gun."

Always keep the gun unloaded until ready to use.

8. Point to the stock and say, "This is the stock." Then demonstrate how to hold the gun: Put the butt of the stock against your shoulder, hold the grip with the hand of the same arm, keeping your finger off the trigger and pointed in the same safe direction as the gun. Hold the fore stock with your other hand.
9. Say, "You will use the free-arm standing position like this." Demonstrate the position that is recommended for your range.
10. Have everyone on the range put on eye protection, either safety glasses or goggles.
11. Say, "Shooters, please move forward at my command." Then give the command, "ON THE FIRING LINE."
12. Assume the shooting position.

13. Have shooters pick up their guns, keeping them pointed in a safe direction down range.
14. Have shooters again assume the shooting position, this time with the gun, and look through the sights. Explain how the sights are used.
15. Once all shooters know how to assume the shooting position and how to properly hold the gun, explain and demonstrate how to charge the gun.
16. Have shooters load BBs into the chamber. (Explain further.) Close and ready the gun.
17. Return to your shooting position. Note that everyone can make ready and load the gun.
18. Give the command “READY ON THE FIRING LINE.”
19. When shooters are in the ready position, give the command “COMMENCE FIRING.” Shoot all your five shots.
20. Watch for safety and help as needed.
21. Give the command “CEASE FIRING.” Everyone is to stop shooting.
22. Give the command “CLEAR ALL GUNS.” Have everyone clear their gun.
23. Explain and demonstrate how to make a gun safe. Explain how to ground the gun for position and range.
24. Have shooters and coaches switch positions.
25. Repeat from step 10.

Groups may continue to rotate shooting or may exit the range.

BB Gun Shooting Games and Activities

A variety of games or activities can be done with BB gun shooting skills. Different ranges could be set up to play a particular game or courses could be set up where participants go from station to station. BB gun shooting games and alternate activities work well, especially when youth are in camp for more than one day or if a council sponsors a special BB gun shooting camp for Cub Scouts. Shooting games are designed to improve shooting skills. Remember—safety is a must.

The following games and activities are appropriate for Tiger Cubs with their adult partners, Cub Scouts, and Webelos Scouts.

Fun Target Activities

- Make 8.5-by-11-inch targets with several squares on each. Put a number in each square. Shooters can see the squares but not the numbers in them. After firing at the page, the shooter adds up the numbers from the squares that his BBs hit. The highest score is the winner.
- Place dots on a target, then shoot at the back side of the target. Count the score from the dotted side.
- Suspend table tennis balls in a box to use as targets.
- Create a target by taping round candy to the back of a box. When the target is hit by the BB the candy shatters.
- Set up balloons as targets.
- Set up crackers as targets. Have participants shoot at the narrow edges of the crackers.

Tic Tac Toe

Place three rows of three balloons on a target mat. Divide the group into two lines and have them stand in a single file 20 feet from the target. At the signal to shoot, each shooter will shoot one BB and step back. The second and each succeeding person will shoot one at a time. The first team to break three balloons in any line is the winning team.

BB Gun Shooting Practice Fun

A practice station is a simple, basic BB gun shooting range, but is very fun for the boys. Many boys have few opportunities to shoot guns, so having the opportunity at a council camp or event to practice is a great experience for them.

Discuss and emphasize the primary rules of proper gun handling. Point out that all guns are potentially dangerous.

Practice the following skills:

- Have participants always point the muzzle in a safe direction and to be sure of their target.
- Show how to handle a gun while standing and when walking.
- Demonstrate and practice various gun-handling situations—how to pass the gun to another person, how to cross a fence with it, how to store it in an automobile, and how to get in and out of a boat with it. Use real or artificial situations, but use the Scouts as demonstrators and require them to practice with others watching.
- Review sight pictures and sight alignment. Give reasons for sighting in a gun before shooting. Tell how little mistakes in sight alignment cause big misses on the target.
- Explain sight adjustment—move the rear sight in the direction you want the BB to go.
- Have relays, prone position without magazine, using sling or sandbag and paper targets.
- Explain the use of BB dishes.
- Demonstrate sitting, kneeling, and standing shooting positions.
- Shoot five rounds per Cub Scout using the standing position.

Bikathlon

The bikathlon event is modeled after the winter Olympic biathlon where competitors cross-country ski and shoot rifles.

In the bikathlon, the Cub Scouts bike around an off-road course, stop at various points, dismount from the bikes to shoot targets that fall over when struck, and then continue along the course. Though the sport requires a certain amount of strength for the biking portion, the BB gun shooting is the key to the event. It takes real skill to hold a gun steady and shoot when one is puffing from an all-out bike ride.

Equipment and Materials

- Bikes
- Elbow and knee guards
- Safety helmets
- Stopwatch or other timing device
- BB guns
- Safety glasses to be worn at the firing line
- Cub Scout Shooting Sports Award certificates, No. 34216

Personnel

Assign adults to the following positions:

- Match director (responsible for the event)
- Jury (three people who are responsible for solving any dispute that may arise during the match and to ensure compliance of the rules by participants)
- Range masters (responsible for safety on the range)
- Statistical officer (responsible for tracking participants' total lapse time)

- Starter (the official who starts each relay or heat)
- Other personnel needed are timers, first-aid personnel, course marshals, and repair personnel (for guns and bikes).

Setting Up the Course

Make the course approximately one-third of a mile in length, in the form of a loop so the starting line and a finishing line are in the same position. One point along the course becomes the firing line—with a separate position for each racer. Identify each firing point with a color, as assigned to each participant. Place a bike rack in a safe place with easy access. The course should not be in a rocky area, and the instructors should walk it to ensure that all dangerous obstacles have been removed. The course can be an existing track or laid out with cones or rope guides to make sure each biker follows the same route.

Running the Race

The bicycle is ridden to the shooting point, the youth dismounts, parks the bike, and shoots the targets. The biker shoots at each target until it is hit and knocked over, then remounts the bike and finishes the race. A limit may be imposed on the number of shots for each target and a time penalty imposed if the target is not knocked over.

The youth finishing the race in the shortest time is declared the winner. The key to the event is not only to pedal fast, but also to shoot quickly and accurately.

Shooting is normally done from the standing position but may be changed at the camp director's discretion. Participants are never allowed to ride the course with the gun. The guns are to remain at the firing point at all times.

Every participant is required to attend a 10- to 15-minute session on bike safety and air gun handling before being allowed to participate in the bikathlon.

This safety session should, as a minimum, cover the following:

- Course layout and general rules
- Range procedure and safety
- How the match is scored
- How to operate and load the guns
- Shooting safety and safe gun handling
- Basics of sighting and shooting
- Bicycle use and riding safety
- Hands-on practice as time, personnel, equipment, and facilities allow
- A written test on air gun and bicycle safety (optional)

Action BB Gun Shooting Course

Set up an action BB gun shooting course using several games or targets as different stations in the course. Each station could encourage the shooters to use a different shooting position. One station could be used to do maintenance work for the BB gun shooting program.

Cub Scout Shooting Sports Award

A Cub Scout Shooting Sports Award, No. 34216, may be awarded to a boy whenever he achieves a level of marksmanship or excellence. The BB gun range master, with other leaders of the camp or event, may determine special circumstances where a unique award might be useful. The award might be given for proficiency in shooting, best sportsmanship, or for some other appropriate achievement.

The award is available from the National Distribution Center in packages of 100.

Belt Loop and Sports Pin Activities

BB Shooting belt loops and sports pins may be earned only through council- or district-sponsored programs.

Quality camp programs will offer a BB gun shooting program that meets the requirements for boys to earn the BB Shooting belt loop. In a program where boys come for more than one day, councils should offer activities that meet requirements for the BB Shooting sports pin. Dens and packs enjoy coming to council camps where they have an opportunity to earn belt loops and sport pins that cannot be earned at home.

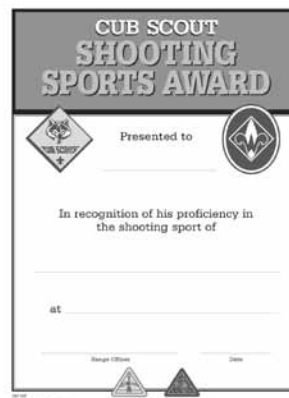

See the requirements for the BB Shooting belt loop and sports pin. Use the certificates to show that boys have met the requirements for the loops and pins. Their pack may then purchase the BB Shooting belt loops and sports pins at their local Scout shop.

BB Shooting Belt Loop and Sports Pin

Tiger Cubs complete requirements while working with their parent or adult partner. Parents and partners do not earn loops or pins. All requirements must be completed under the supervision of a certified BB gun shooting range master.

Belt Loop Requirements

Complete three requirements:

1. Explain the rules for safe BB gun shooting you have learned to your leader or adult partner.
2. Demonstrate to your leader or adult partner good BB gun shooting techniques, including eye dominance, shooting shoulder, breathing, sight alignment, trigger squeeze, and follow-through.
3. Practice shooting at your district or council camp for the time allowed.

Sports Pin Requirements

Earn the BB Shooting belt loop and complete five of the following.

1. Explain the parts of a BB gun and demonstrate how to properly load the gun.
2. Demonstrate the shooting positions.
3. Develop proficient shooting techniques by practicing for three hours.
4. Learn the correct scoring techniques for target BB gun shooting.
5. Make a poster that emphasizes the proper range commands.
6. Draw to scale or set up a BB gun shooting range.
7. Show improvement in your shooting ability with an increase in scoring points.
8. Help make a type of target for the camp BB gun shooting range.
9. Show how to put away and properly store BB gun shooting equipment after use.
10. Explain how to use the safety mechanism on a BB gun.
11. Tell five facts about the history of BB guns.

Range Layout

Review the BB gun range layouts on the following page.

Safety is a primary concern when operating a BB gun range and all safety rules must be followed.

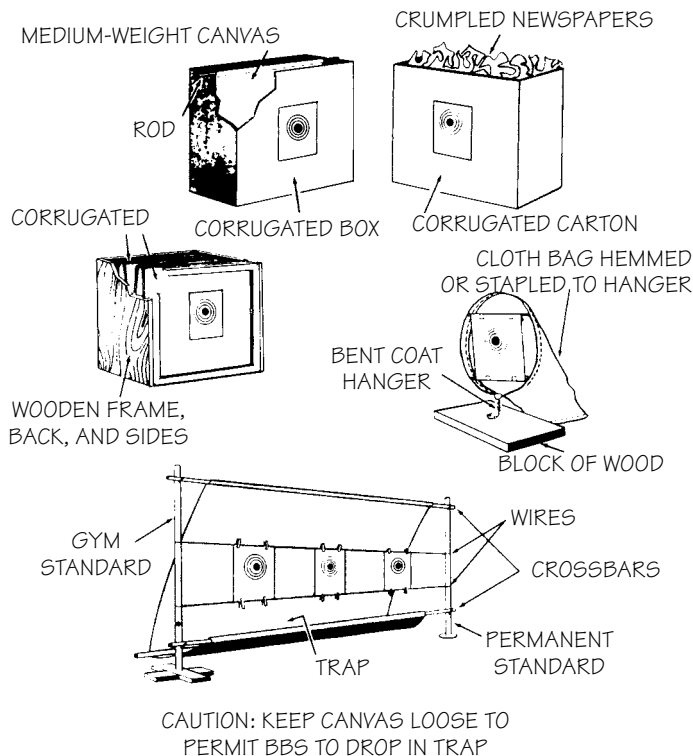

1. **Safe area.** Whether inside or outside, be sure the range is set up so no one can accidentally walk in front of the firing line. When indoors, make sure doors and side windows are locked. When outside, make sure to always shoot in a safe direction. In either case, never point the gun toward windows or where people might walk.
2. **Safe distance.** Maintain at least 15 feet between the shooter and the target.
3. **Safe backstop.** A backstop to trap BBs and hold the target can easily be made from a large cardboard box. Do not shoot at a hard surface that could cause a ricochet. If using a tarp as a backstop, it is important to verify that the tarp is made of a heavy canvas material and not a thin plastic canvas material. It is best to hang the material at a 45-degree angle. Bales of straw also work well. Crosman offers a ballistic fabric that is by far the best, and it can be reused.

Important! Arrange facilities so there is no possibility of anyone inadvertently walking behind the targets while shooting is in progress. No one may stand directly in front of the target while shooting is in progress!

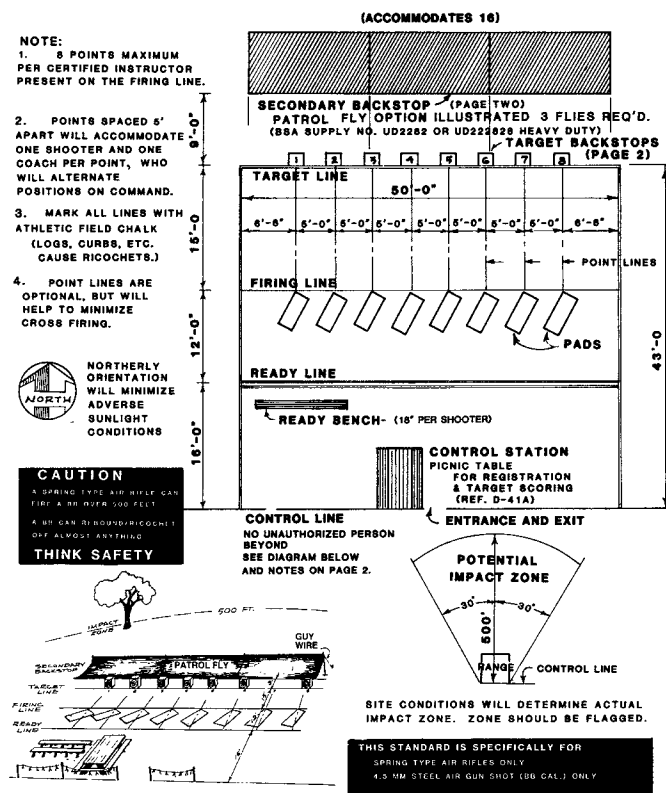

Shooting on a Safe Range

A safe range must have three things:

1. A safe area
2. A safe distance
3. A safe backstop

Range Operation Rules

When operating the range, the safety rules must be remembered and constantly obeyed.

1. If the range is outdoors, fly a red range flag whenever the range is in use. The flag should be large enough and high enough on a flagpole to be seen from all approaches to the range.
2. Shooters reporting to the firing line will be issued a specific number of BBs and a BB dish that will be placed in plain sight at the firing point.
3. Shooters will be instructed that in case of a misfire the BB gun will be kept pointed at the target. The instructor will be called. If the malfunction is due to a broken part, the gun, after being cleared of BBs, will be removed from the firing line.
4. BB guns must be left with the action open or at half-cock, in the case of lever action spring-piston air guns, except when the shooter is in position on the firing line and has been given the command to load. (Half-cock position on a lever action spring-piston air gun is with the lever down, but without the spring compressed or cocked. To check to see if the gun is cocked, pull the lever forward; if there is no pressure on the lever, the spring is compressed and the gun is cocked.)
5. As soon as the command to cease firing is given, the BB guns must be opened and placed on the shooting mat with their muzzles pointing downrange, actions open or at half-cock, whether or not the shooter has completed firing all his shots. This rule must be enforced and obeyed absolutely.
6. In preparing to fire, the targets are first placed in position. The shooters then take their places on the firing line. While the first group is firing, the targets are prepared for the next group of shooters and they are told their firing point. When the first group has completed firing and all BB guns are unloaded and actions open or at half-cock, the fired targets are taken down and the new targets set up.
7. No one, shooter or instructor, is allowed in front of the firing line after the order has been given to load and before the order has been given to cease firing—actions open.
8. No one is allowed on the firing line except the shooters and their coaches or instructors.
9. Horseplay of any kind is forbidden on the range. Spectators and those who are waiting their turn to fire are not permitted to do anything that may distract the attention of the shooters from the business of shooting accurately and safely.
10. All BB guns not in use should be kept in racks with the actions open or at half-cock.

Sample range rules poster:

BB Gun Shooting Range Rules

1. This range may be opened only by a certified BB gun shooting range master.
2. All commands issued by the range master must be obeyed immediately.
3. Stay behind the firing line. Do not straddle the firing line.
4. Do not pick up a gun unless told to by the range master.
5. Absolutely no running on the range.
6. No horseplay or unnecessary talking on the range.
7. If in doubt about these rules, ask your leader or range master for advice and help.

Range Commands

When ready to start firing, the range master commands: “ON THE FIRING LINE.”

Immediately, each shooter takes his assigned place at his firing point and prepares to fire, but does not load. The range master checks the location of each shooter to ensure correct firing point and target number.

The range master makes sure the range is clear, then asks:

“IS THE LINE READY?”

If there is any shooter who is not ready or whose target is in bad order, that shooter immediately raises his arm and calls:

“NOT READY” and gives the number of his target.

The range master will immediately call:

“THE LINE IS NOT READY.”

The range master will investigate the difficulty and assist in correcting it. When the difficulty has been corrected, the range master calls:

“IS THE LINE READY?”

If all is ready, the range master then calls:

“THE LINE IS READY.”

(This means the line is ready on the right, ready on the left, and ready on the firing line.)

The range master calls:

“LOAD.” Shooters load the BB gun chambers.

The range master calls:

“READY ON THE FIRING LINE.”

The range master commands:

“COMMENCE FIRING.”

After firing, the range master commands:

“CEASE FIRING—CLEAR ALL GUNS.” All BB gun chambers and magazines are unloaded and shooters leave the firing line with the actions of their BB guns open.

Repeat the above steps for all succeeding shooters.

The range master will immediately command “CEASE FIRING” if any incident occurs that could result in possible injury to some living thing should firing continue.

“AS YOU WERE” means to disregard the command just given.

“CARRY ON” means to proceed with whatever was being done before the interruption occurred.

Equipment

BB gun shooting equipment may be secured from gun retailers. See “Resources” on page 99.

BB Gun Shooting Equipment for 200 Campers

- One range—50-foot range with eight firing points 15 feet from firing line to target
- 12 BB guns
- 1,200 targets
- 18,000 BBs

- Eight target backstops
- One set of 17-by-22-inch instruction wall charts
- 10 safety glasses
- Each BB gun should be equipped with an adjustable sling of 5/8-inch-wide nylon webbing and with target sights.

Range Accessories

- Tarps to provide shade over the pads protecting the shooters and the guns
- BB dishes at each firing point
- Shooting mats at each firing point
- A desk with storage space for equipment for recording scores. It should be behind the ready line and near the bulletin board.
- Ample waste receptacles behind the firing line for fired targets and trash
- Sandbags or other rest equipment for each firing point
- Range flag and pole for use during range operation
- BB gun racks to store BB guns that are not in use

Air Guns

Air guns, traditionally regarded as guns for beginners, are now enjoyed by shooting enthusiasts at all skill levels. Some, such as the familiar BB gun, are excellent for beginners, while other types are designed for the seasoned competitor. Whether used for recreation or sport, for field use or as an inexpensive training tool, air rifles are an excellent way to enjoy shooting.

In recent years, air guns have undergone dramatic improvements, making them more reliable, durable, and accurate. Air guns can be fired safely by shooters of all ages and experience levels on a wider variety of ranges than any other type of firearm.

Spring-Piston Guns

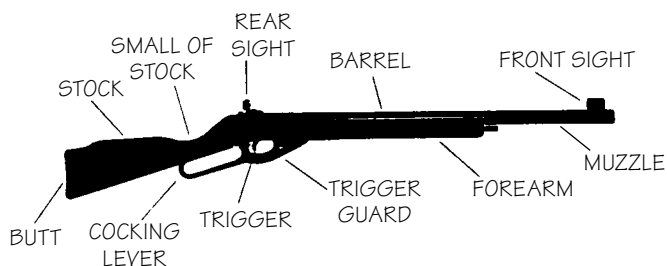

Spring-piston air guns use a manually operated lever, pivoting barrel, or other device to move a piston that in turn compresses a mainspring located in the frame or receiver portion of the gun.

When the piston is completely retracted, the mainspring is fully compressed. The piston will remain in this retracted position until the shooter releases it by pulling the trigger. The piston, under pressure from the compressed mainspring, moves rapidly forward when it is released, and compresses the air in front of it. The compressed air then forces the projectile out of the barrel.

In this type of air gun, the air that propels the projectile is not stored in a reservoir prior to firing; the air is compressed by the movement of the piston after the trigger is pulled.

Pneumatic Guns

Pneumatic air guns use the principle of stored compressed air or gas and can be divided into two categories: single-stroke/multi-pump guns and compressed CO₂/air guns.

1. **Single-stroke and multi-pump pneumatic air guns** use a manually operated lever (or a pivoting barrel that acts as a lever) to force air through a valve mechanism to compress and store the air in an air reservoir or chamber.

In the single-stroke model, one stroke of the lever charges the air reservoir with enough compressed air for one shot. After the air reservoir has been charged, additional strokes of the lever are not required. In some models, additional strokes will have no effect; in other models, additional strokes may result in damage to the gun.

In the multi-pump model, a similar lever and valve mechanism is used to compress and store air; however, the lever must be pumped several times to build sufficient air pressure for one shot. The amount of air pressure in the reservoir is determined by the number of times the lever is pumped. This adjustable air pressure feature allows the velocity of the projectile to be varied, thereby enabling the shooter to use this type of air gun for a variety of activities.

In both the single-stroke and multi-pump models, all the air that has been compressed will remain in the reservoir until the shooter releases it by pulling the trigger. Pulling the trigger releases a spring-driven hammer that strikes an air exhaust valve. This valve immediately releases the stored air, which then propels the projectile out of the barrel. Little or no compressed air remains in the reservoir. For the next shot, the shooter must again use the lever to compress and store air.

2. **Compressed CO₂/air pneumatic guns** use CO₂ or air that has been compressed and stored in a metal cylinder, or air that is compressed by an external air pump.

In some models, a small, disposable CO₂ metal cylinder is inserted into the gun. When the shooter pulls the trigger, a measured portion of the compressed gas stored in the cylinder is released to propel the projectile out of the barrel. Since not all the gas is released at one time, additional shots may be fired without having to recharge the gun.

Air Compression Mechanisms

Various mechanical designs employing levers, pivoting barrels, or other devices are used to compress the air in spring-piston air guns and in pneumatic single-stroke and multi-pump air guns. Five current designs are break-barrel (also known as barrel-cocking), over-lever, under-lever, side-lever, and slide.

Air Gun Ammunition

There are five basic types of air gun ammunition: pellets, lead balls, darts, bolts, and BBs.

BBs, the most familiar air gun ammunition, are made of steel and are coated to prevent rust. BBs are fired in a smoothbore air rifle and are intended for plinking and target competition. Some brand names are Beeman, Crosman, Daisy, and Marksman.

Equipment Maintenance and Storage

Keep BB gun shooting equipment in good condition. Repairing guns and keeping target faces and mats in good condition can save money and make shooting experiences more successful.

Even when shooting is occurring daily, BB gun shooting equipment should be kept in locked storage when not in use to protect it from weather, rodents, and theft.

Chapter 12: Other Shooting Sports

Many council programs have shooting activities that include wrist rockets (slingshots), catapults, balloon launchers, rockets, and some other creative devices. These items are fun and, in most cases, seem harmless. However, any type of shooting activity can be dangerous, and if safety precautions are not taken, accidents can happen easily. Great care should be taken that safety is the key factor for any activity where items are shot through the air.

- **Airsoft is not an approved BSA shooting activity for Cub Scouts, Boy Scouts, Varsity Scouts, Venturers, or Sea Scouts.**
- **Paintball guns are not approved for Cub Scouts and Webelos Scouts. Boy Scouts, Varsity Scouts, Venturers, and Sea Scouts may only use paintball guns to shoot at approved targets—never at another person.**
- All safety guidelines enforced in archery and BB gun shooting apply to all other types of shooting sports.
- A safe range must be provided for any activity, such as wrist rockets, catapults, or rockets, that involves shooting objects or water in the air.
- A range master must supervise the range.
- All shooting activities must be approved by the council shooting sports committee or the National Camping School–trained shooting sports director or an NRA rifle instructor.

Shooting on a Safe Range

A safe range must have three things:

1. **A safe area**
 2. **A safe distance**
 3. **A safe backstop**
1. **Safe area.** Whether inside or outside, be sure the range is set up so no one can accidentally walk in front of the firing line.
 2. **Safe distance.** Maintain at least 15 feet between the shooter and the target.
 3. **Safe backstop.** A backstop designed to trap items and hold the target is required. A backstop to trap BBs and hold the target can easily be made from a large cardboard box. Do not shoot at a hard surface that could cause a ricochet. If using a tarp as a backstop, it is important to verify that the tarp is made of a heavy canvas material and not a thin plastic canvas material. It is best to hang the material at a 45-degree angle. Bales of straw also work well. Crosman offers a ballistic fabric that is by far the best, and it can be reused.

Pellet Guns

The use of pellet air rifles is restricted to Webelos Scouts in a resident camp setting and qualifies when in compliance with the following requirements. Tiger Cubs and Cub Scouts are **NOT** permitted to shoot pellet air rifles.

- The air rifle pellet gun range meets or exceeds BSA and National Rifle Association recommendations, including nearby latrine facilities, drinking water, first-aid kit, and emergency communications. See *Camp Program and Property Management*, No. 20-920, and appropriate BSA Engineering Service design standards. The range is on council-owned property.
- The shooting sports director is at least 21 years of age and holds a valid certificate of training from the shooting sports section of National Camping School or is a current NRA rifle instructor or NRA/USA Shooting/CMP certified rifle coach.
- The shooting sports director or NRA rifle instructor or NRA/USA Shooting/CMP certified rifle coach must be in charge of the firing line any time it is in operation, supervising a maximum of eight firing points at one time.
- Approved safety glasses or goggles with side shields must be worn by all shooters and instructors.
- Air rifles in good repair are provided. Firearms modified to fit the size of the shooters are desirable. All rifles used in BSA shooting sports have a trigger pull in excess of 2.5 pounds and are tested with a 2.5-pound weight or scale at least once a week while in use. If any trigger mechanism fails, the air rifle is immediately removed from service. Documentation of the tests is maintained.
- All air rifles (CO₂, pump, break barrel, etc.) are limited to single-shot designated for target shooting, velocity of 500 to 540 feet per second, and energy levels not to exceed 7.5 joules.
- Safe, separate, and locked storage (can be the same building) is provided for pellet guns, pellets, and CO₂ cylinders and bulk tanks.
- Air rifle propellant is limited to CO₂ cylinders or air compressor/scuba tanks. Refilling is conducted by qualified adults with appropriate controls. If scuba tanks are used, each tank must be visually inspected annually and hydrostatically tested every five years by a qualified technician.
- A handwashing station (with cold water and soap) is available for all shooters to use upon leaving the firing line. **THERE IS NO EATING OR DRINKING ON THE FIRING LINE.**

Slingshots and Wrist Rockets

Using slingshots is an affordable, fun activity in council-sponsored camps. Boys love to shoot slingshots, and many have not had previous experience with them. Although exciting and fun, slingshots are not toys. Boys must understand that they must follow the rules when shooting or they will not be allowed to participate. Remember the story of David and Goliath.

Shooting items from slingshots and wrist rockets can be dangerous. For these activities, follow the same safety guidelines and rules as used for BB gun shooting. Always shoot at a range such as an archery or BB gun shooting range.

Equipment

Slingshots are usually fork-shaped (Y) and made out of very strong and durable wood or aluminum. Broom wood, which is both strong and lightweight and lends itself to carving, is also good for slingshots.

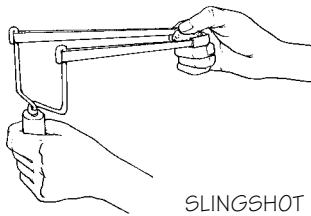

SLINGSHOT

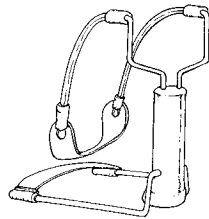

WRIST ROCKET

Wrist rockets are a type of slingshot. They are designed to brace against the wrist and therefore seem to be steadier.

Many companies sell excellent slingshots and wrist rockets. Companies that sell BB guns or archery equipment would be good resources for these items. Less expensive slingshots and wrist rockets are available from chain stores.

Targets

Targets for slingshots and wrist rockets can be made from a variety of materials, including paper, cans, plastic bottles, and balloons. Paper targets can be homemade or purchased. Cans are excellent as they make a great sound when hit. Cans, plastic bottles, and balloons can be hung from strings or attached to netting. A sample target is shown on page 100. Practice with the slingshot or wrist rocket on a bull's-eye about 2 inches in diameter and with the target 10 feet away, then move the target out to 25 yards.

Ammunition

Items shot from slingshots and wrist rockets are considered ammunition. Generally people use small rocks and pebbles; however, this is not appropriate for Cub Scouts. Instead, use a softer ammunition such as pinto beans or even soft chunky dog food. Ammunition such as ball bearings may not be used.

Slingshot and Wrist Rocket Guidelines

(Instructions are for right-handed shooters. Reverse instructions for left-handed shooters where applicable.)

1. A range master must be present and a 1-to-1 adult-to-boy ratio must be used.
2. Use a safe shooting range such as a BB gun range or archery range.
3. Wear protective eyeglasses or goggles.
4. Do not pick up a slingshot until told to do so.
5. Never shoot at anything if you cannot see what is behind it.
6. Do not use a slingshot with a power band damaged by age or weather.
7. Never shoot up into the air.
8. Never cross the firing line when shooting.
9. Point your left foot and shoulder directly at the target with the body turned to the right. Turn the head directly toward the target.
10. Center the ammo in the middle of the leather pouch. Hold the handle firmly in the left hand and pinch the ends of the leather pouch together with the thumb and index finger of the right hand, encompassing the ammo.
11. Hold the left arm out straight and firm. Draw the right hand back level with right cheek—NEVER TO THE EYE—while holding the leather pouch securely between the thumb and index finger of the right hand.

12. Aim and release the leather ammo pouch to shoot.
13. Always practice courtesy and good sportsmanship!

Catapults and Other Shooting Devices

Catapults can be a fun activity at Cub Scout camps. Catapults were ancient war machines used to throw huge rocks over castle walls. Today, a type of catapult is used to launch planes from aircraft carriers. A slingshot is also a kind of catapult. Balloon launchers and peashooters can also be used at camp.

CATAPULT

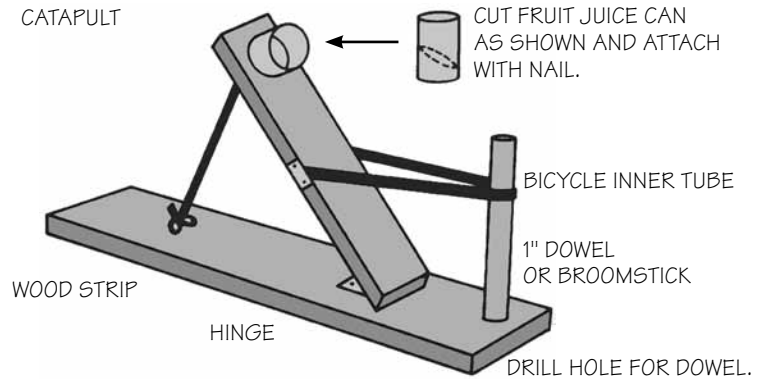

CUT FRUIT JUICE CAN AS SHOWN AND ATTACH WITH NAIL.

BICYCLE INNER TUBE

1" DOWEL OR BROOMSTICK

DRILL HOLE FOR DOWEL.

Although specific rules have not been written about each type of shooting activity, these general guidelines apply:

1. Have fun and be responsible!
2. Do not aim any shooting device at a person. Never shoot any projectile, even if it is soft or seems to be harmless, at or near people, animals, or personal property. This includes water balloons.
3. A balloon launcher is not a toy and is made for the sole purpose of launching water balloons. Never launch water balloons at eye level.
4. Do not use any projectiles such as rocks, pebbles, or ball bearings that are hard or that could cause harm.
5. Never use a launcher if there are signs of wear. Check before each use.
6. When using a slingshot or balloon launcher, never put your finger or hand between the tubing connection and the handle.
7. Always wear eye protection.
8. Targets may be made similar to those for archery and BB gun shooting. Creative targets may also be made that relate to the camp theme. Targets should not look like humans or animals.
9. A range master must supervise the range at all times.
10. The range must meet the criteria of a safe range: safe area, safe distance, and safe backstop.
11. The range must be established. Make certain that no one will wander into the landing zone of the projectiles.
12. The use of catapults or other shooting devices must be approved by a National Camp School-trained shooting sports director.

Ammunition

For water balloons, use biodegradable small balloons filled no larger than a ping pong ball. When using a catapult, use an object that is soft and is no larger than the opening of a small juice can.

Chapter 13: Resources, Certificates, and Patches

Resources

Archery Trade Association
101 N. German, Suite 3
New Ulm, MN 56073
866-266-2776
www.archerytrade.org

National Field Archery Association (NFAA)
800 Archery Lane
Yankton, SD 57078
605-260-9279
www.nfaa-archery.org

USA Archery
711 N. Tejon St.
Colorado Springs, CO 80903
719-866-4576
www.USArchery.org

Daisy Manufacturing Company
P.O. Box 220
Rogers, AR 72757-0220
800-643-3458
www.daisy.com

Marksman Products
5482 Argosy Drive
Huntington Beach, CA 92649
714-898-7535
www.marksman.com

Crosman Corporation
7629 Routes 5 and 20
East Bloomfield, NY 14469
800-724-7486
www.crosman.com

National Rifle Association (NRA)
11250 Waples Mill Road
Fairfax, VA 22030
800-672-3888
www.nra.org

Tread Lightly
800-966-9900
www.respectedaccess.org

Webelos Handbook, No. 33452
Boy Scouts of America

Cub Scout Academic and Sports Program Archery Belt Loop and Pin Certification



This certifies that _____ has earned the Archery:

Belt Loop

Sports Pin

Earned at _____ (authorized camp)

On _____ (Date)

Certified by _____ (Range officer)

And _____ (adult leader or parent)

Present this completed certification to your council Scout shop to purchase the Cub Scout archery belt loop or sports pin.

Cub Scout Academic and Sports Program BB Shooting Belt Loop and Pin Certification

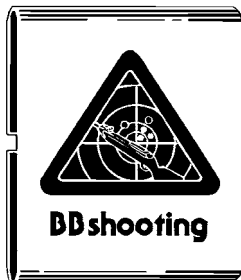

This certifies that _____ has earned the BB Shooting:

Belt Loop

Sports Pin

Earned at _____ (authorized camp)

On _____ (Date)

Certified by _____ (Range officer)

And _____ (adult leader or parent)

Present this completed certification to your council Scout shop to purchase the Cub Scout BB shooting belt loop or sports pin.

Sample Archery Scorecard

These cards may be reproduced for campers in the archery program to keep their score as they strive to improve their shooting skill.

Arrow Score			Hits	End Score	Running Score
Total					

Signature

Arrow Score			Hits	End Score	Running Score
Total					

Signature

Arrow Score			Hits	End Score	Running Score
Total					

Signature

Arrow Score			Hits	End Score	Running Score
Total					

Signature

Sample Targets

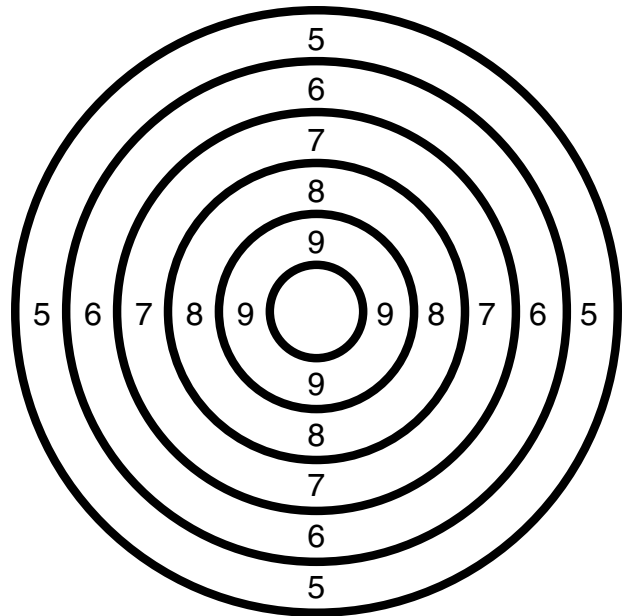
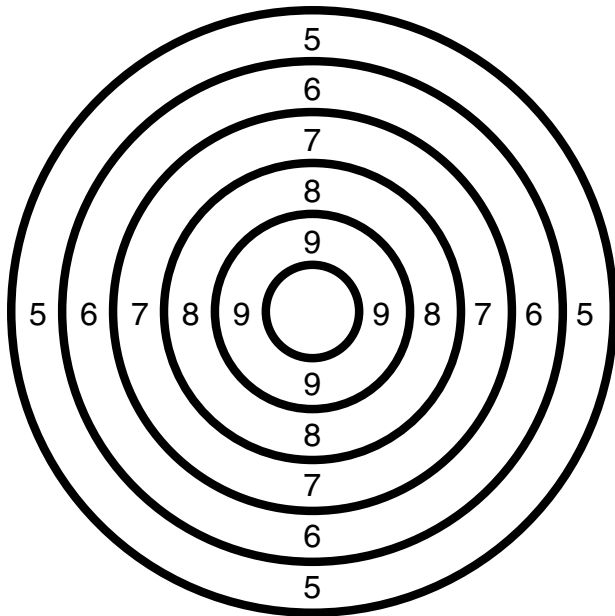
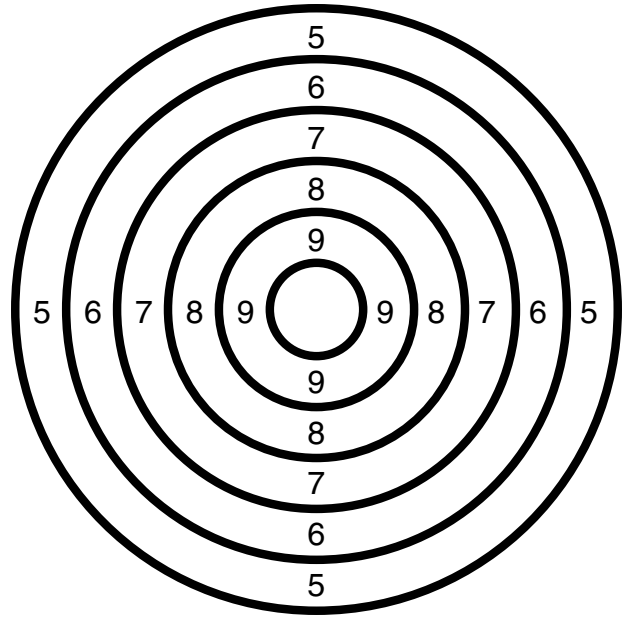
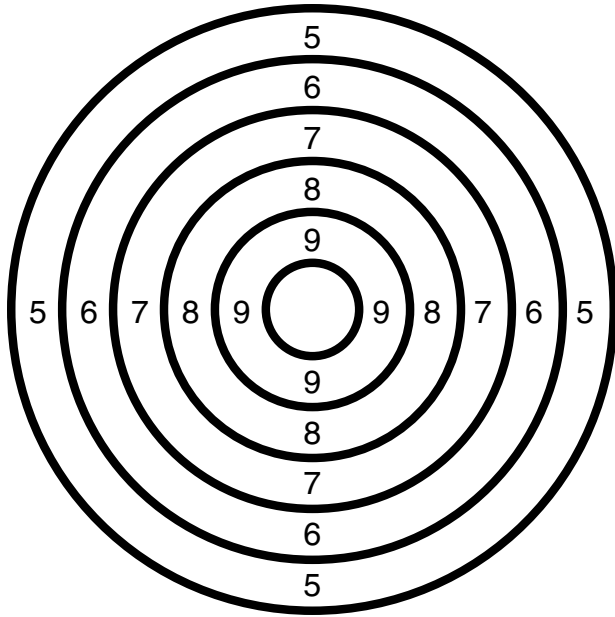

Crossword Puzzle: Air Gun Shooting

So you think you know a lot about air gunning? Here's a crossword puzzle to test your knowledge of air guns, ammunition, and common shooting terms.

If you find yourself stumped, you can check the answers below.

1. You shoot at this.
2. Your point total.
3. The diameter of a bore determines this.
4. An air gun has none. Kick.
5. Soft lead air gun projectile.
6. Olympic shooters strive for this.
7. The inside of the barrel.
8. You catch pellets, BBs, and mice in one of these.

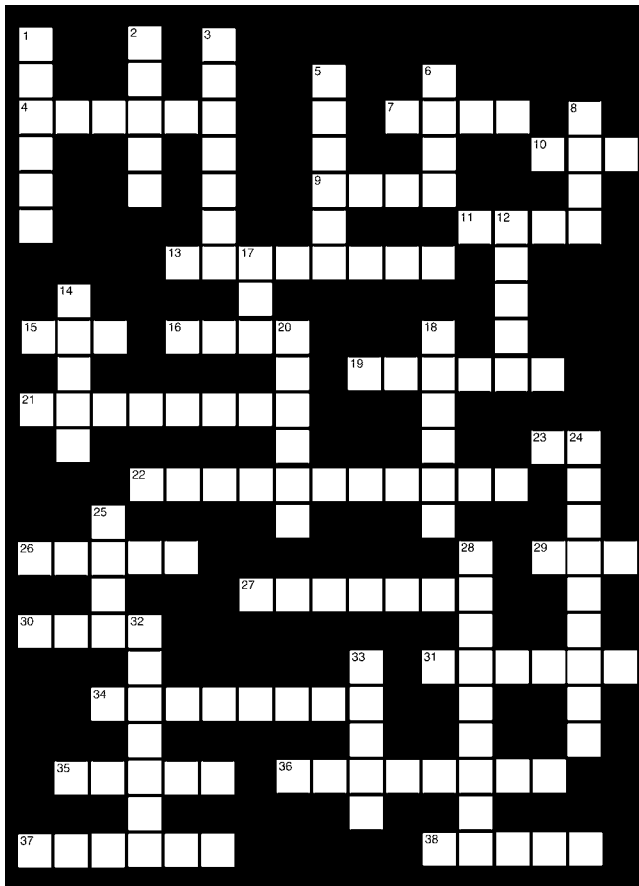

9. You do this when you put pellets or BBs in an air gun's receiver.
10. National Rifle Association.
11. The part by which you hold a pistol.
12. The place where you shoot.
13. Lots of this will make you a better shooter.
14. You hold this type of air gun against your shoulder.
15. The opposite of a miss.
16. A pneumatic air gun requires you to do this to increase air pressure.
17. You do this when you line up the sights on a target.
18. Every shooter's primary responsibility.
19. Handle every gun as if it were this.
20. A hand-held air gun.
21. The highest level of international air gun competition. It takes place every four years.
22. The metal targets that are profiles of rams, turkeys, pigs, and chickens. Use only pellets to shoot them.
23. A perfectly round, copper-covered steel ball fired from some air guns.
24. A new sport that combines the challenges of air gunning and off-road bicycling.
25. This opens a rifle's action.
26. The position air gunners take lying down.
27. The world leader in air gun technology. A bikathlon sponsor.
28. This type of air gun is powered by a pump system similar to a bicycle pump.
29. The largest silhouette target.
30. This part of the rifle goes against your shoulder.
31. Always point this in a safe direction. The end of a barrel.
32. Squeeze this to make an air gun fire.
33. The grip, comb, and butt are on this part of a rifle.
34. Never shoot BBs at metallic silhouette targets because they might do this.
35. The aiming device on an air gun.
36. The most important component of an air gun range.
37. The projectile travels from the receiver to the muzzle through this.
38. A telescopic sight.

Crossword Puzzle Answers

- | | | | | |
|------------|--------------|-----------------|---------------|--------------|
| 1. Target | 9. Load | 17. Aim | 25. Bolt | 33. Stock |
| 2. Score | 10. NRA | 18. Safety | 26. Prone | 34. Ricochet |
| 3. Caliber | 11. Grip | 19. Loaded | 27. Crosman | 35. Sight |
| 4. Recoil | 12. Range | 20. Pistol | 28. Pneumatic | 36. Backstop |
| 5. Pellet | 13. Practice | 21. Olympics | 29. Ram | 37. Barrel |
| 6. Gold | 14. Rifle | 22. Silhouettes | 30. Butt | 38. Scope |
| 7. Bore | 15. Hit | 23. BB | 31. Muzzle | |
| 8. Trap | 16. Pump | 24. Bikathlon | 32. Trigger | |

Quiver and Bow Rack

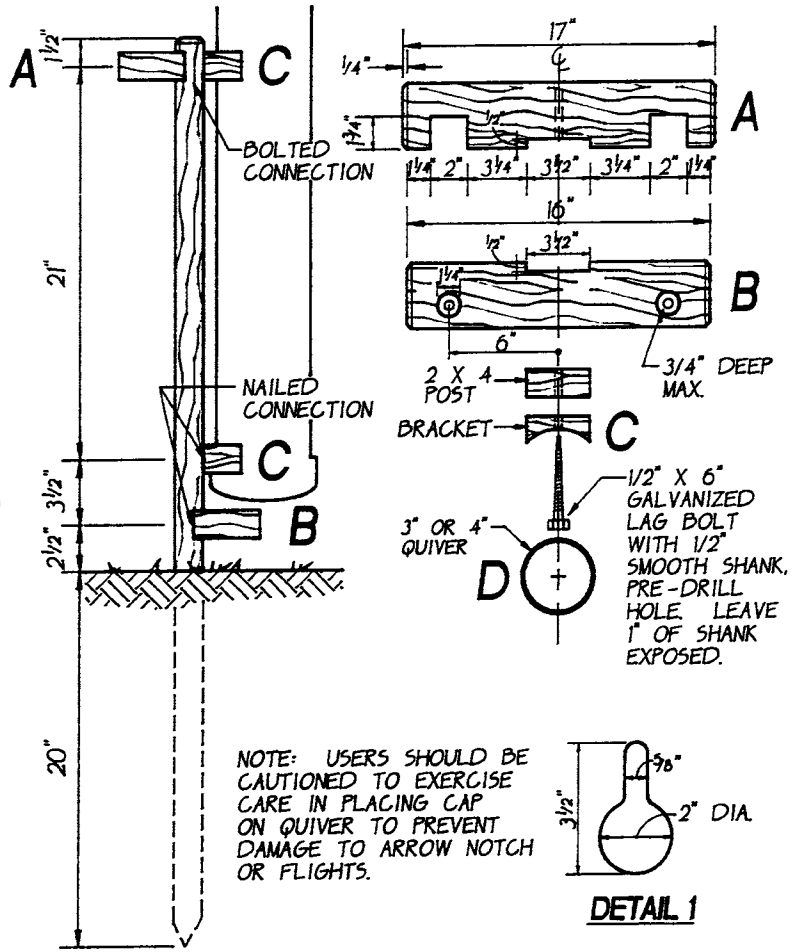
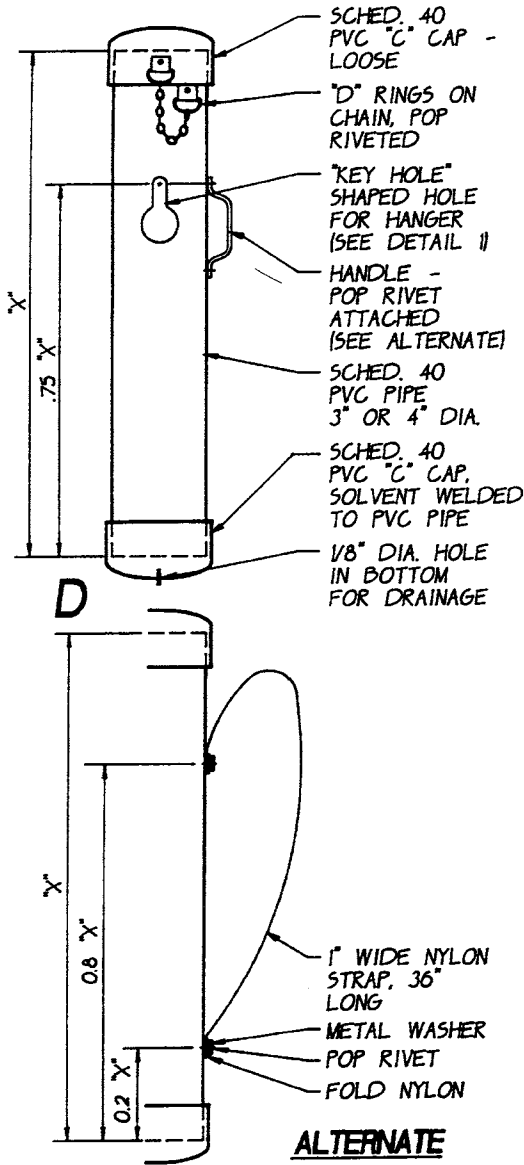

NOTE: USERS SHOULD BE CAUTIONED TO EXERCISE CARE IN PLACING CAP ON QUIVER TO PREVENT DAMAGE TO ARROW NOTCH OR FLIGHTS.

NOTE:
 X = 27" FOR 26" LONG ARROW
 X = 29" FOR 28" LONG ARROW

Archery Storage Locker

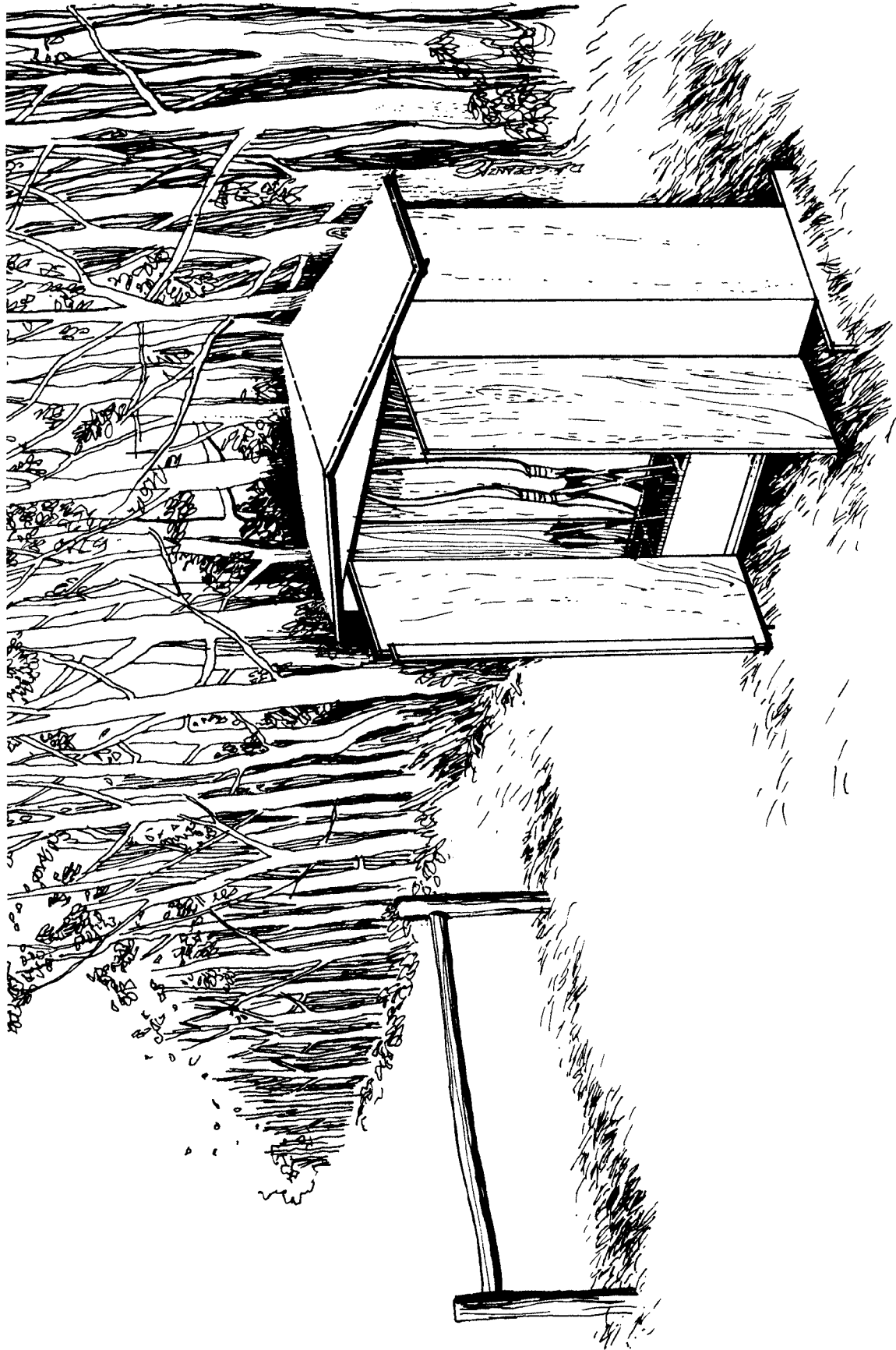

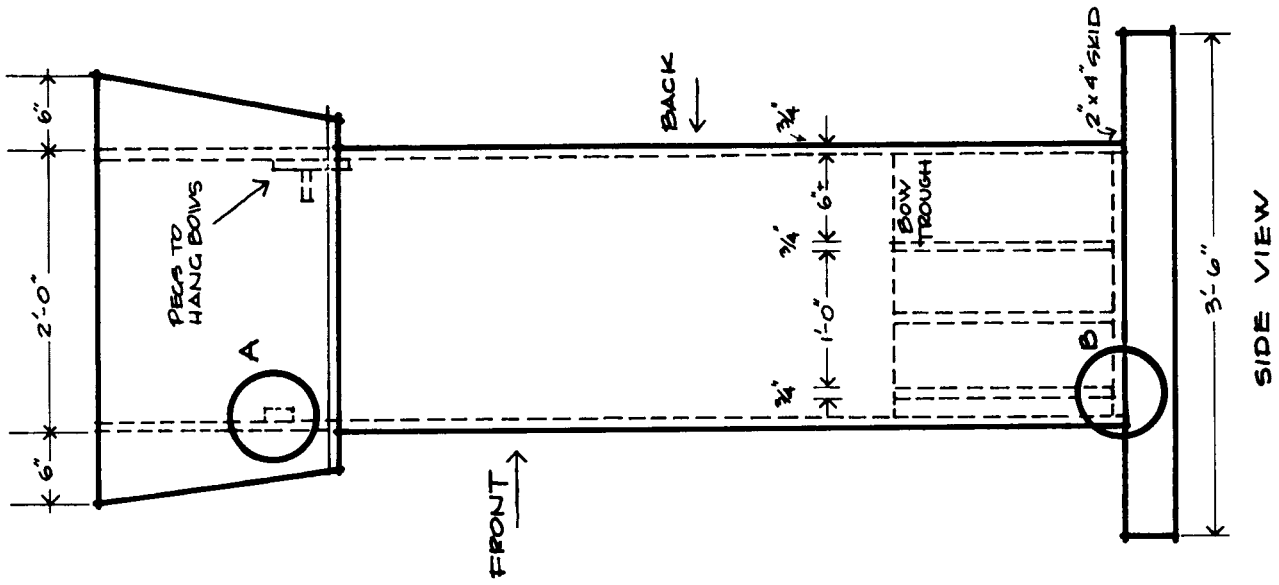
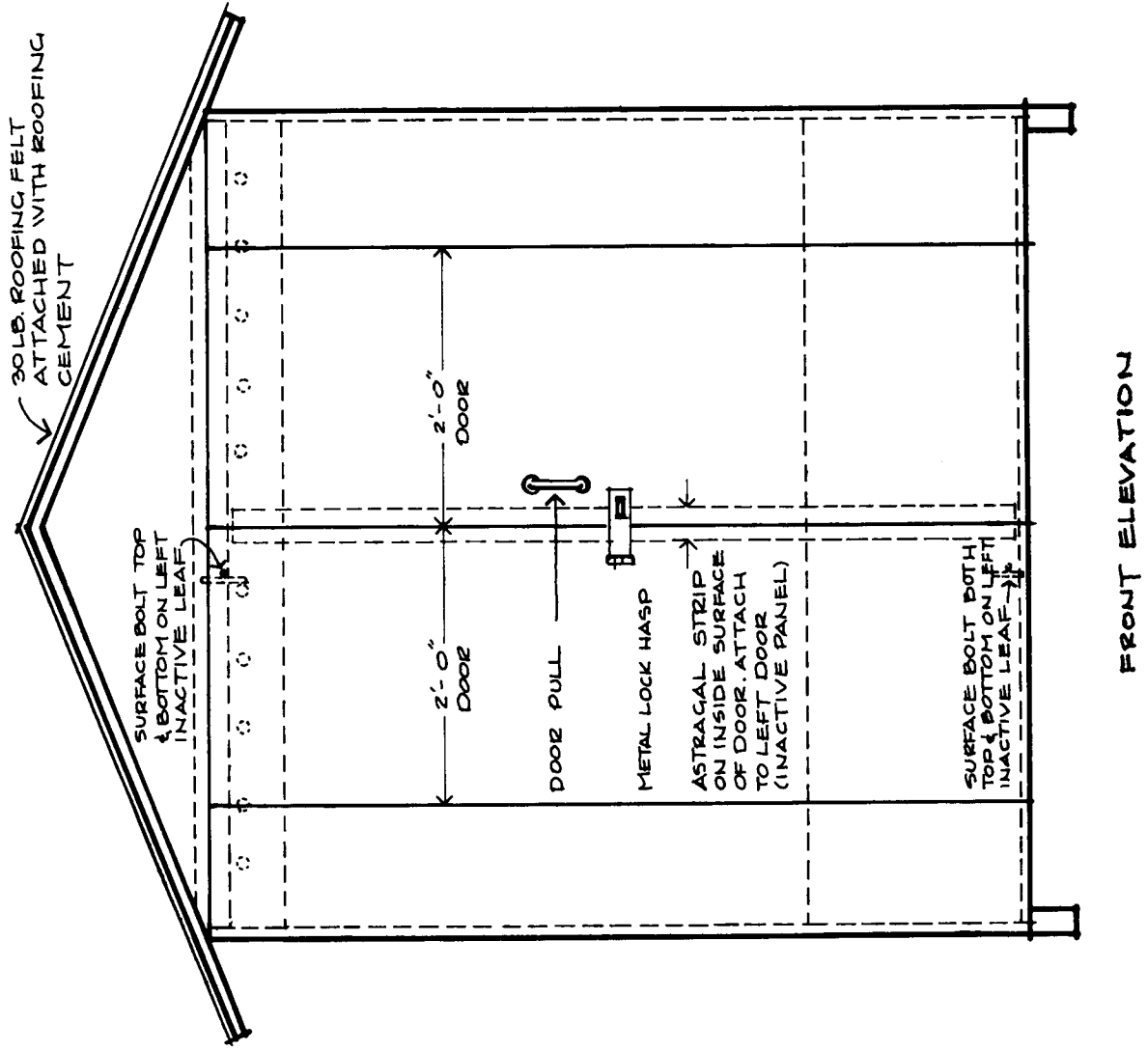

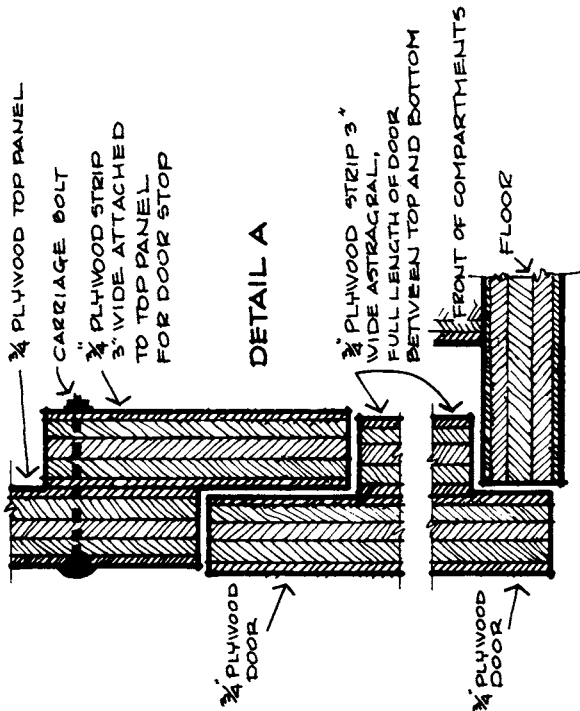

DETAIL B

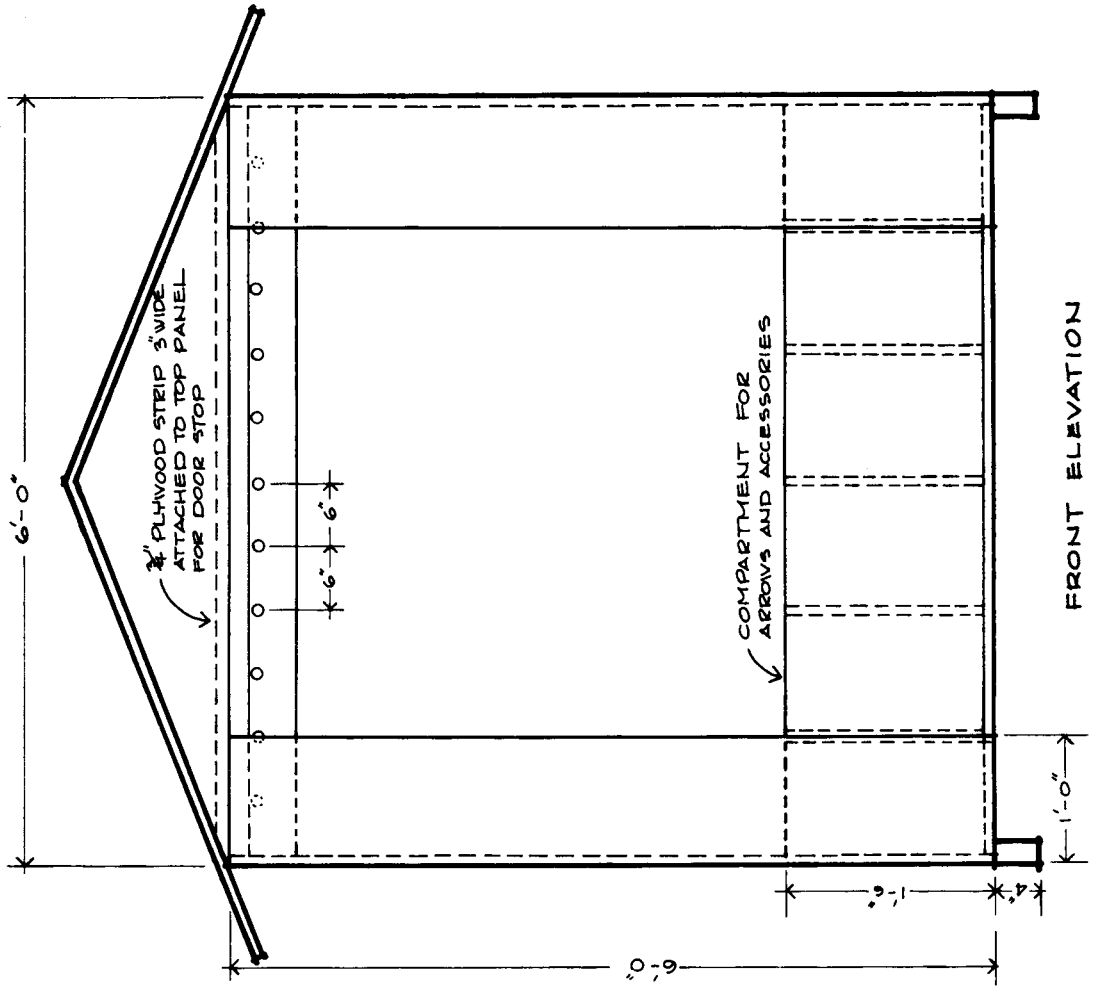
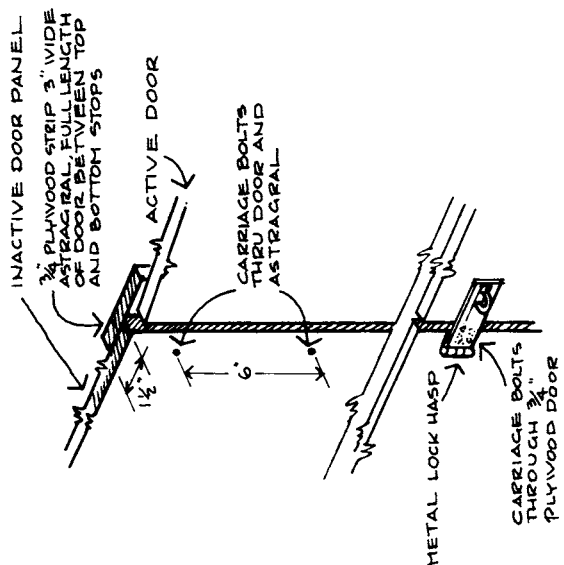

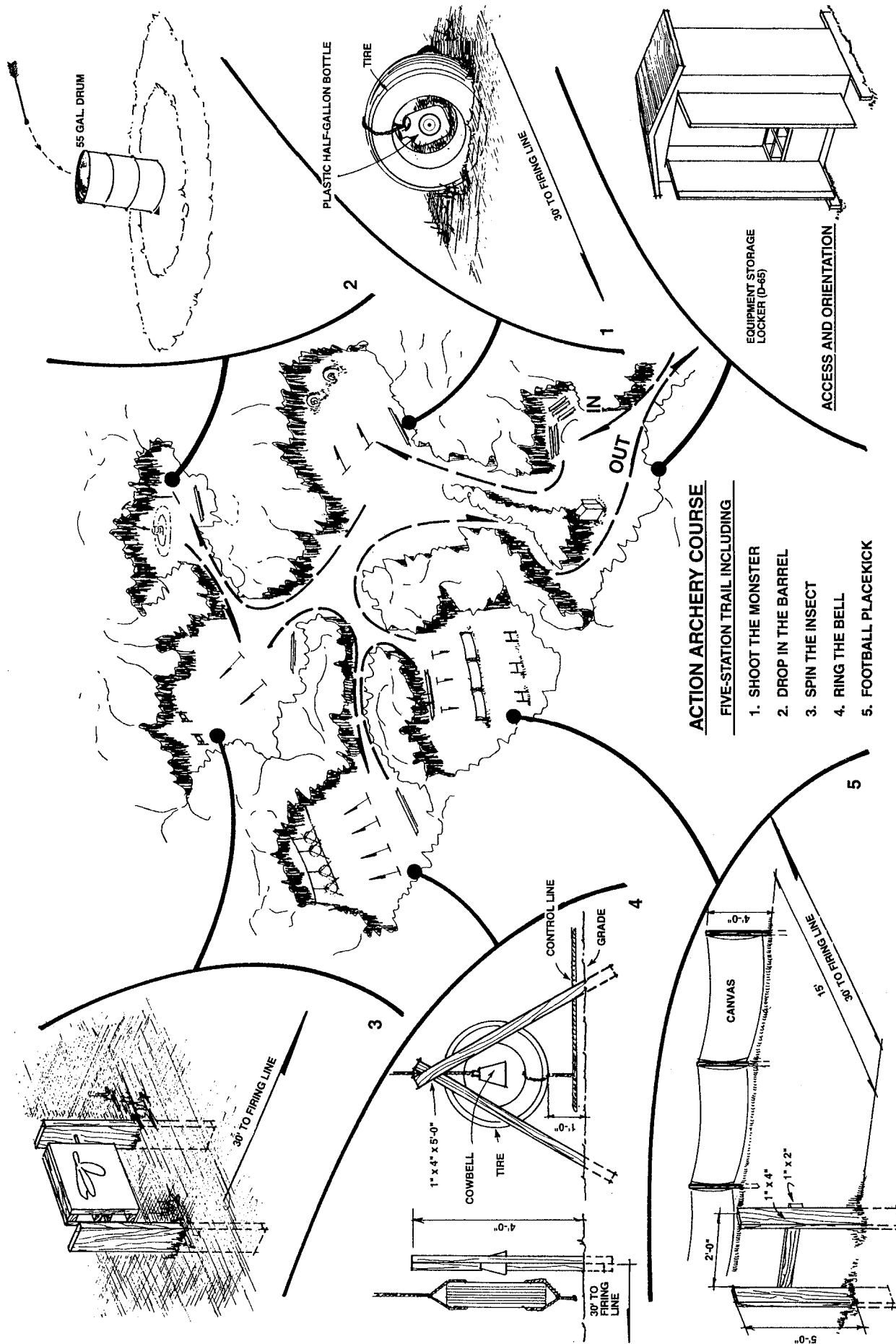

ACTION ARCHERY COURSE

FIVE-STATION TRAIL INCLUDING

1. SHOOT THE MONSTER
2. DROP IN THE BARREL
3. SPIN THE INSECT
4. RING THE BELL
5. FOOTBALL PLACEKICK

EQUIPMENT STORAGE LOCKER (D-65)

ACCESS AND ORIENTATION

IN
OUT

PLASTIC HALF-GALLON BOTTLE

TIRE

55 GAL. DRUM

30° TO FIRING LINE

1" x 4" x 5'-0"

COWBELL

TIRE

CONTROL LINE

GRADE

30° TO FIRING LINE

CANVAS

2'-0"

1" x 4"

5'-0"

4'-0"

15'

30° TO FIRING LINE

5

2

1

Glossary

action. A group of moving parts used to cock, compress air (in some models), load, fire, and unload an air gun.

air gun. A gun that propels a projectile through its barrel by use of compressed air or carbon dioxide gas (CO₂). Gunpowder is not used in this type of gun.

anchor point. The particular spot on the archer's face to which the index finger comes on the draw to give consistency to shooting.

arm guard. A piece of leather or plastic that is worn on the inside of the forearm to protect the arm from the bowstring.

arrow plate. A substance on the side of the bow to give point contact with the arrow.

arrow rest. An extraneous device on the bow to provide point contact; also a resting point.

back. The side of the bow that is away from the shooter.

BB. The term BB is used to describe spherical steel pellets that are .177 inch (4.5 mm) in diameter. However, steel BBs actually have a maximum diameter of .175 inch. BB projectiles for air guns should not be confused with the .181-inch-diameter BB pellets used in shotgun shells.

blunt. A blunt-tipped arrow, often used for small game.

bolt. A hard, metal projectile with a sharp, pointed nose and plastic fins inserted in the rear portion of the projectile.

bore. The inside of the barrel of a gun.

bow arm. The arm that holds the bow (not the string).

bow sight. A device attached to the bow that allows the shooter to sight directly on the target (which cannot be done with the arrow tip except at point-blank range).

bowstring. The string of a bow, usually made of Dacron.

broadhead. An arrow with a sharpened metal tip for hunting live game.

butt. A backstop for holding arrows shot at a target. The shoulder end of a rifle stock.

caliber. The diameter of a projectile, the distance between the lands in a rifled barrel, or the bore diameter in a smoothbore barrel.

cant. The act of holding the bow tilted or slightly turned while shooting.

cast. The distance a bow can shoot an arrow.

CO₂ cylinder or tank. A metal cylinder tank that contains carbon dioxide gas (CO₂). Available in small disposable cylinders for insertion in some models of CO₂ pneumatic air guns; also available in large tanks that are used to charge refillable cylinders and internal gas reservoirs in other models.

cock feather. The arrow feather at right angles to the nock; often of a different color than the other feathers.

cocking lever. The part of a spring-piston air gun used to cock a spring-loaded piston that compresses air at the instant of firing.

compressed CO₂ /air pneumatic gun. A type of air gun using carbon dioxide gas (CO₂) or air that has been compressed and stored in a metal cylinder, or air that is compressed by an external air pump. This type of air gun allows the firing of multiple shots without recharging.

creeping. Letting the string hand edge forward before release.

crest. Paint or decoration on the arrow shaft near the feathers.

cylindrical pellets. A cylindrically shaped air gun pellet that usually has a raised band encircling its base to act as an air seal.

dart. A hard metal projectile with a sharp pointed nose and organic or artificial hair or feathers inserted in the rear portion of the projectile.

dieseling. The ignition and detonation of low-flash point lubricants due to the high temperature generated during the rapid compression of air in a spring-piston air gun.

draw. The acting of pulling the bowstring back into the anchor position.

drawing arm. The arm that draws back the bowstring.

drift. Natural deflection of an arrow from its normal path due to outside factors, such as wind.

end. A specified number of arrows shot at one time (or from one position) before retrieving.

end loop. The part of the string that fits over the bow nock.

face. The part of the bow facing the shooter; also a target face.

fast. An expression used to warn people of arrows being shot.

field archery. A competitive round shot at various distances and laid out like a golf course.

field arrow. An arrow with a field point; used outdoors for field archery, stump shooting, roving, and small game.

finger tab. A tab worn on the drawing hand to protect the fingers and give a smooth release of the bowstring.

fletching. The feathers of the arrow that give guidance to the arrow's flight.

flight. A competitive round of shooting for distance; also, the path of an arrow.

forearm. The part of the arm between the elbow and the wrist.

free style. Shooting with the aid of a bow sight.

front sight. The sight on the muzzle of a gun.

glove. A covering worn to protect the fingers from the string.

grooves. The shallow, spiral cuts in a bore that, together with the lands, make up the rifling in the bore of a barrel.

handle riser. The center part of the bow.

head. The tip or point of the arrow.

hen feathers. The two feathers not at right angles to the nock; usually the same color (but different from the cock feather).

hold. The act of gripping the bow; hesitating at full draw.

index. The raised piece of plastic on the nock of an arrow that is in line with the cock feather.

instinctive shooting. Aiming and shooting arrows instinctively rather than using the pre-gap or point-of-aim methods or a bow sight.

jerking. Letting the drawing hand jerk too far back as the arrow is released.

kick. The recoil of the bowstring and bow after the arrow is released.

laminate. A composite bow, usually of wood and fiberglass.

lands. The ridges of metal between the grooves in a rifled barrel.

limbs. The two ends of a bow, from the handle riser out.

longbow. A bow with no recurve.

multi-pump pneumatic air gun. A type of pneumatic air gun that uses several strokes of a lever to compress and store enough air in a reservoir or chamber for one shot.

muzzle. The front end of the barrel from which a projectile exits.

NAA. National Archery Association.

NRA. National Rifle Association.

nock. The groove in the end of the arrow in which the bowstring fits; also, the groove at each end of the bow which holds the bowstring in place.

nock locator. The material on the bowstring used to indicate the exact nocking point for the arrow.

nocking point. The marked place on the bowstring where the arrow nock is placed before drawing and releasing.

over-bowed. Using a bow that is too heavy for the individual.

overdraw. Drawing the arrow back too far so that the tip passes the face of the bow. This is a dangerous practice.

plinking. Informal shooting at a variety of targets.

pneumatic air gun. A type of air gun that uses stored compressed air. Divided into two subcategories: single-stroke or multi-pump pneumatics and air pneumatics.

point. The tip on the end of the arrow.

point-blank range. The only distance from the target at which the point-of-aim is right on the target center.

point-of-aim. A method of aiming using a point, usually in front of the target, with which the point of the arrow is aligned; allows for trajectory of the arrow.

pre-gap (pre-draw gap). A method of aiming.

projectile. A body projected forward such as a bullet from a gun.

quiver. A container to hold arrows; can be ground, back, side, or pocket type.

range officer. A trained, certified, on-site adult who directs the operation of a range program in a shooting sport.

rear sight. The sight nearest the breech of a gun.

recurve. A bow that is curved on the ends.

reflexed bow. A bow with limb ends curving toward the back rather than toward the face of the bow.

release. The act of letting the bowstring slip off the fingertips.

rifling. Spiral grooves and lands in the barrel bore that provide a stabilizing spin to a projectile so that it will be more accurate in flight.

roving. An outdoor game played by two or more in which natural targets such as stumps, trees, or bushes are selected for accuracy competition.

self arrow. An arrow made entirely of one piece of wood.

self bow. A bow made entirely of one piece of wood, as opposed to other types of bows such as laminate.

servicing. The thread wrapped about the bowstring to prevent fraying of the string.

shaft. The middle of an arrow; an unfletched arrow.

shelf. The place on the bow where the arrow rests.

shooting sports director. The person who has overall responsibility for the operation of the shooting program for council camps and activities.

sight alignment. The relationship between the front and rear sights, where the shooter sees that the post bead, disc, or front sight device is aligned properly with the rear sight.

sights. Mechanical, optical, or electronic devices used to align the axis of the barrel on the target.

sinking. The gradual loss of a bow's power.

single-stroke pneumatic air gun. A type of pneumatic air gun that uses one stroke of a lever to compress and store enough air in a reservoir or chamber for one shot.

small of stock. The narrow part of a rifle stock.

smoothbore. An informal name for a gun that has a smoothbore barrel.

smoothbore barrel. A barrel that does not contain rifling.

solid bow. A common reference to a bow that is made entirely of fiberglass or plastics.

spring-piston air gun. A type of air gun that uses a manually operated lever or other device to cock a spring-loaded piston, which compresses air at the instant of firing. The air that propels the projectile is not stored in a reservoir prior to firing.

stance. A standing position assumed when shooting an arrow.

stock. The wooden or metal piece to which the barrel or mechanism of a rifle are attached.

string. Preparing a bow for shooting; also, the bowstring.

string fingers. The three fingers used to draw back the bowstring.

string height. The distance between the bow and the bowstring at the handle.

strung bow. A bow that is ready to shoot.

target archery. A competitive round shot at affixed distances in an open area.

target arrow. A lightweight arrow with a target point.

throwing. Moving the bow hand to the left upon release.

understrung. A bow with a bowstring that is too long.

vane. A plastic fletching on an arrow.

weight. The amount of effort (in pounds) required to draw the bow a given length (normally measured at 28 inches).

weight in hand. The actual weight of the bow.

windage. The amount of drift in the flight of an arrow caused by wind.

wobble. The erratic motion of a flying arrow.

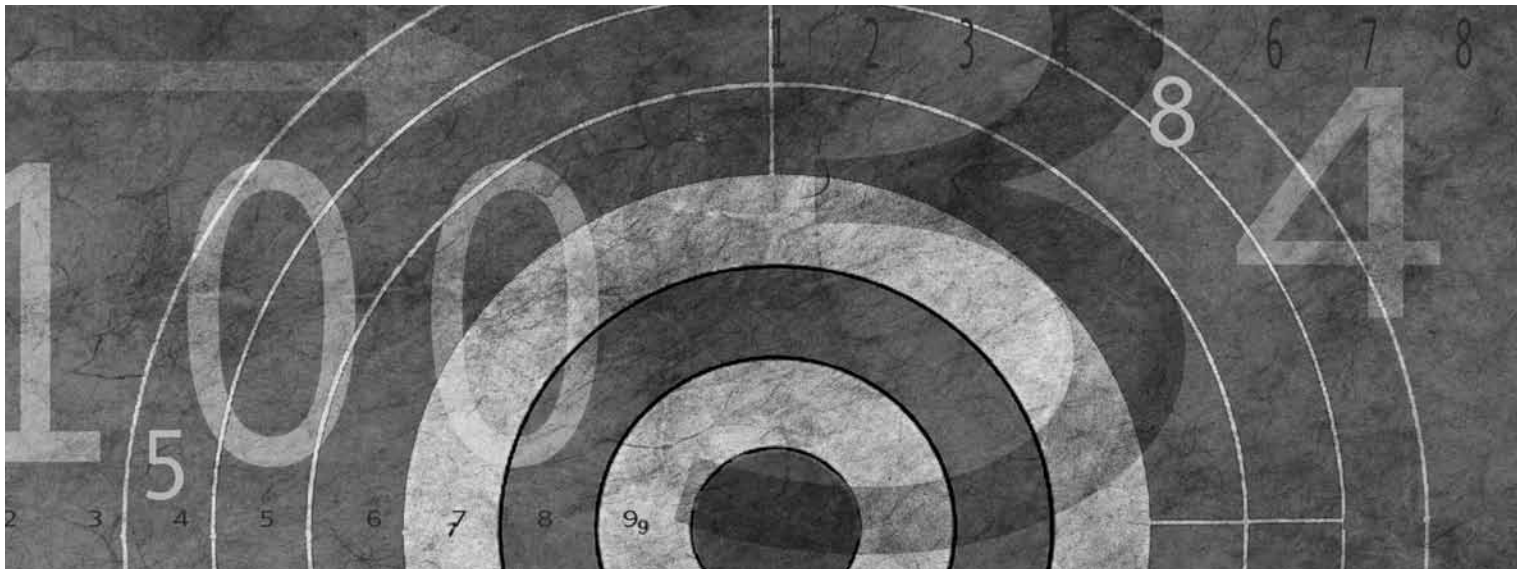

APPENDIXES

- 1 NRA FIRST Steps/BSA Shotgun Shooting Merit Badge Teaching Guide
- 2 NRA FIRST Steps/BSA Rifle Shooting Merit Badge Teaching Guide
- 3 Sample Standard Operating Procedures Manual
- 4 Shooting Sports Decision Tree
- 5 Activity Consent Form, No. 680-673
- 6 Resources

**NRA
FIRST Steps
SHOTGUN
ORIENTATION**

**INSTRUCTOR'S
LESSON PLANS**

**BOY SCOUTS OF AMERICA
SHOTGUN SHOOTING
MERIT BADGE TEACHING GUIDE**

**NRA FIRST Steps Firearm Instruction, Responsibility, and Safety Training Program
First Edition**

©1995 The National Rifle Association of America

All rights reserved. Printed in the United States of America. This material may not be reproduced in whole or in part, by photocopying, mimeograph or by any other means without written permission. For information, write: Training Department, National Rifle Association, 11250 Waples Mill Road, Fairfax, VA 22030

TABLE OF CONTENTS

Introduction	5
Day 1, Lesson I.	
Introduction to Shotgun Safety, Parts, and Operation.....	7
Day 2, Lesson II.	
Introduction to Ammunition and the Fundamentals of Shotgun Shooting	9
Day 3, Lesson III.	
Introduction to Shotgun Shooting at Straightaway Targets.....	10
Day 4, Lesson IV.	
Introduction to Shotgun Cleaning, Storage, and Training Opportunities.....	11

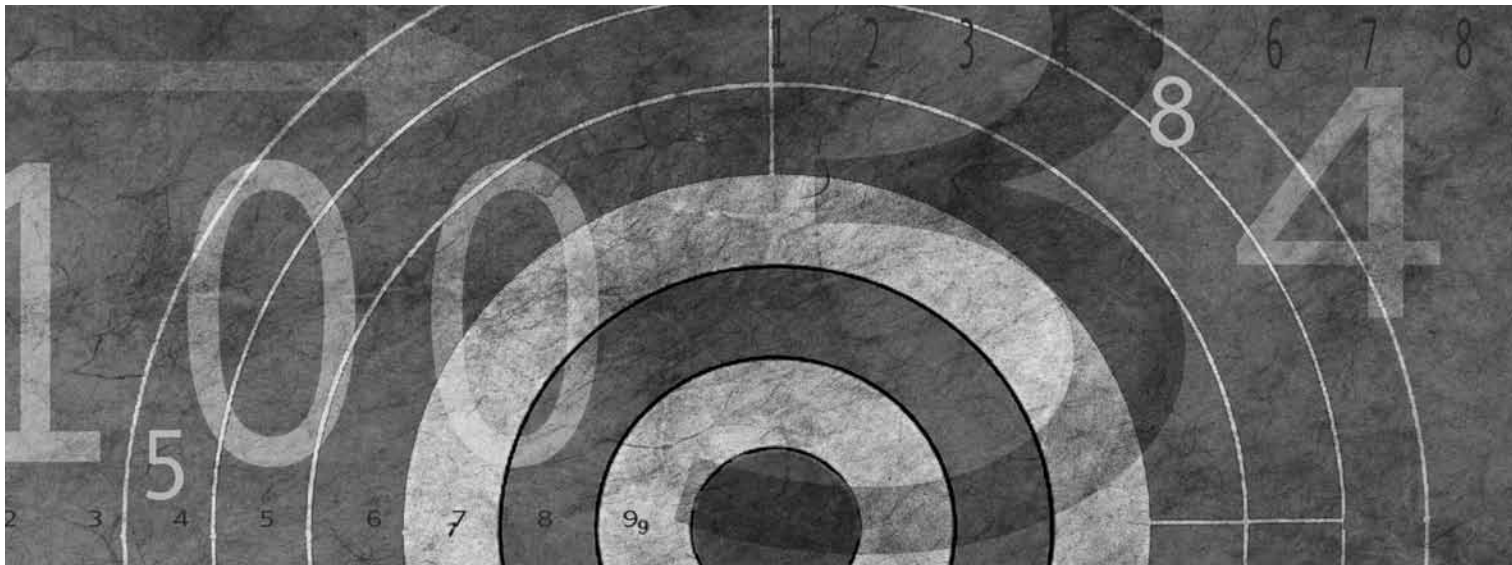

INTRODUCTION

The certified NRA shotgun instructor who is serving as the merit badge counselor will need the following reference materials:

NRA FIRST Steps Shotgun and Orientation Lesson Plans, No. 13392–3/2/10, and BSA *Shotgun Shooting* merit badge pamphlet, No. 35492.

The purpose of this manual is to integrate the BSA *Shotgun Shooting* merit badge pamphlet with the NRA FIRST (Firearm Introduction, Responsibility and Safety Training) Steps Shotgun Orientation Lesson Plans to allow those NRA certified shotgun instructors who teach according to this manual to accumulate the five courses and a total of 25 students required to be eligible to attend an NRA Training Counselor Workshop.

In teaching the Shotgun Shooting merit badge, the counselor/instructor must:

1. Follow the NRA FIRST Steps Shotgun Orientation Lesson Plans, adding the BSA merit badge requirements as noted. This outline applies ONLY to Merit Badge Option A—Modern Shotshell Type.
2. Reference BOTH the BSA *Shotgun Shooting* merit badge pamphlet and the NRA FIRST Steps Shotgun Orientation Lesson Plans to complete the Training Counselor Workshop eligibility requirement.

NOTE: There are a few requirements of the Shotgun Shooting merit badge that are not covered in the NRA FIRST Steps Shotgun Orientation Lesson Plans which must be supplemented accordingly.

Each Scout should have his own copy of the BSA *Shotgun Shooting* merit badge pamphlet.

Day 1

Lesson I. Introduction to Shotgun Safety, Parts, and Operation—2 Hours

Paragraph A. Orientation—15 minutes

Steps 1: Skip this step, or have students fill out the merit badge record cards instead, if used by the local council.

Steps 2–9: Follow the NRA FIRST Steps Lesson Plans.

Step 10: Distribute the BSA *Shotgun Shooting* merit badge pamphlet instead of the FIRST Steps Shotgun book.

Paragraph B. Introduce Lesson—5 minutes.

Follow the NRA FIRST Steps Lesson Plan.

Paragraph C. Shotgun Safety—20 minutes

Steps 1–2: Follow the FIRST Steps Lesson Plan.

Step 3: Teach the NRA Fundamental Rules for Safe Gun Handling.

BSA Requirement 2b.

Identify and demonstrate the rules for safely handling a shotgun.

*Refer Scouts to *Shotgun Shooting* merit badge pamphlet pages 24 and 25 titled “Fundamental Rules for Safe Gun Handling” and use NRA FIRST Steps Rule 3.

Note: Follow BSA *Shotgun Shooting* merit badge pamphlet page 4, requirements 1a–b. The requirements are listed below along with references to teach from. **These requirements are not found in the FIRST Steps Shotgun Lesson Plan.** Teach these requirements prior to continuing with the First STEPS Shotgun Lesson Plan to paragraph D. *Safe Shotgun Handling Practical Exercise* listed below.

BSA Requirement 1a.

Explain why BB and pellet air guns must always be treated with the same respect as firearms.

*Refer Scouts to *Shotgun Shooting* merit badge pamphlet page 25, “BB and Pellet Air Guns.”

BSA Requirement 1b.

Describe how you would react if a friend visiting your home asked to see your or your family’s firearm(s).

*Refer Scouts to the *Shotgun Shooting* merit badge pamphlet. There is no exact quote. Use page 28, “Store guns so they are not accessible to unauthorized person.”

Paragraph D. Safe Shotgun Handling Practical Exercise—15 minutes

Follow the NRA FIRST Steps Lesson Plan.

BSA Requirement 2b.

Identify and demonstrate the rules for safely handling a shotgun.

*Refer Scouts to *Shotgun Shooting* merit badge pamphlet pages 24 and 25 titled “Fundamental Rules for Safe Gun Handling.”

Break—5-minutes

*First Shot Assessments—30 minutes

Paragraph E. Shotgun Parts—5 minutes

Steps 1–3: Teach from the box below.

Note: Teach all action types: pump, hinge, and semiautomatic.

BSA Requirement 2a.

Identify the principal parts of a shotgun, action types, and how they function.

*Refer Scouts to *Shotgun Shooting* merit badge pamphlet page 10, “Shotgun Parts,” and page 17, “The Safety.”

Paragraph F. Shotgun Parts—5 minutes

Follow the NRA FIRST Steps Lesson Plan.

Paragraph G. Editor’s note: Printing error: Paragraph G inadvertently skipped.

Paragraph H. Shotgun Parts: Review—5 minutes

Follow the NRA FIRST Steps Lesson Plan.

Paragraph I. Shotgun Operation—5 minutes

Steps 1–2: Follow the NRA FIRST Steps Lesson Plan.

Paragraph J. Shotgun Operation Practical Exercise—5 minutes

Follow the NRA FIRST Steps Lesson Plan.

Paragraph K. Conclude Lesson—5 minutes

Steps 1–3: Follow the NRA FIRST Steps Lesson Plan.

Day 2

Lesson II. Introduction to Ammunition and the Fundamentals of Shotgun Shooting—2 Hours

Paragraph A. Introduce Lesson—5 minutes

Follow the NRA FIRST Steps Lesson Plan.

Paragraph B. Shotgun Ammunition—5 minutes

1. Ammunition compatibility

Note: Follow the BSA *Shotgun Shooting* merit badge pamphlet page 5 requirements 2c and d. The requirements are listed below along with references to teach from. **These requirements are not found in the FIRST Steps Shotgun Lesson Plan.** Teach these requirements prior to continuing the FIRST Steps Shotgun Lesson Plan, Paragraph B item 2 *Ammunition malfunction*.

BSA Requirement 2c.

Identify the parts of a shotgun shell and their functions.

*Refer Scouts to *Shotgun Shooting* merit badge pamphlet page 18, “Shotgun Ammunition,” and page 19, “How Shotgun Ammunition Fires.”

BSA Requirement 2d.

Identify the various gauges of shotguns. Explain which one you would pick for use and why.

Paragraph B. Shotgun Ammunition—10 minutes

2. Ammunition malfunction

BSA Requirement 2e.

Explain what a misfire, hangfire, and squib fire are, and explain the procedures to follow in response to each.

*Reference *Shotgun Shooting* merit badge pamphlet page 21, “Ammunition Malfunctions.”

Paragraph C. Determining the Dominant Eye—10 minutes

Follow the NRA FIRST Steps Lesson Plan.

*Reference *Shotgun Shooting* merit badge pamphlet pages 34–35.

Paragraph D. The Fundamentals of Shotgun Shooting—20 minutes

BSA Requirement 2e.

Identify and explain the fundamentals of safely shooting a shotgun.

*Reference *Shotgun Shooting* merit badge pamphlet pages 34–39, “Fundamentals of Shotgun Shooting.”

Practicing the Seven Fundamentals of Shotgun Shooting—65 minutes

Follow the NRA FIRST Steps Lesson Plan.

Paragraph E. Conclude Lesson

Follow the NRA FIRST Steps Lesson Plan.

Day 3

Lesson III. Introduction to Shotgun Shooting at Straightaway Targets—2 Hours

Paragraph A. Introduce Lesson—5 minutes
Follow the NRA FIRST Steps Lesson Plan.

Paragraph B. Range Safety and Shooting Facility Orientation—5 minutes
Teach Steps 1–4 as written in the NRA FIRST Steps Lesson Plan.

Paragraph C. Rules for Safe Shooting—5 minutes

BSA Requirement 2f.

Identify and explain each rule for safely shooting a shotgun.

BSA Requirement 1c.

Explain the need for and use and types of eye and hearing protection.

*Reference *Shotgun Shooting* merit badge pamphlet pages 26–28, “Rules for Using or Storing a Shotgun.”

Paragraph D. Preparation for Shooting Exercises—5 minutes
Follow the NRA FIRST Steps Lesson Plan.

Paragraph E. Shooting Straightaway Targets—90 minutes

BSA Requirement 2g.

Demonstrate the knowledge, skills, and attitude necessary to safely shoot moving targets, using the fundamentals of shotgun shooting.

*Reference *Shotgun Shooting* merit badge pamphlet pages 34–44, “Fundamentals of Shotgun Shooting.”

Note: Teach BSA *Shotgun Shooting* merit badge pamphlet page 5 requirement 2k. This requirement is listed below along with a reference to teach from. **This requirement is not found in the FIRST Steps Shotgun Lesson Plan.** Teach this requirement prior to continuing with the FIRST Steps Shotgun Lesson Plan Paragraph F *Conclude Lesson*.

BSA Requirement 2k.

Shooting score required—Hit at least 12 out of 25 targets (48 percent) in two 25-target groups. The two groups need not be shot in consecutive order.

Instructor’s Note: The second Paragraph E. Review of Shooting Practice is a printing mistake. Re-letter the paragraph F and Paragraph F Conclude Lesson to letter G.

Paragraph F. Review of Shooting Practice—5 minutes
Follow the NRA FIRST Steps Lesson Plan.

Paragraph G. Conclude Lesson—5 minutes
Follow the NRA FIRST Steps Lesson Plan.

Day 4

Lesson IV. Introduction to Shotgun Cleaning, Storage, and Training Opportunities—2 Hours

Paragraph A. Introduce Lesson—5 minutes
Follow the NRA FIRST Steps Lesson Plan.

Paragraph B. Cleaning a Shotgun—15 minutes
Teach steps 1–3 as written.

BSA Requirement 2h.

Identify the materials needed to clean a shotgun.

*Reference *Shotgun Shooting* merit badge pamphlet pages 28–29, “Cleaning Your Shotgun.”

Teach step 4 *Practical Exercise* as written below.

BSA Requirement 2i.

Demonstrate how to clean a shotgun properly and safely.

*Reference *Shotgun Shooting* merit badge pamphlet pages 30–31, “Steps in Cleaning.”

Paragraph C. Hygienic Guidelines Following Exposure to Airborne Particulate Lead or Cleaning Solvent Residue—5 minutes
Follow the NRA FIRST Steps Lesson Plan.

BSA Requirement 1g.

Explain to your counselor the proper hygienic guidelines used in shooting.

*Reference *Shotgun Shooting* merit badge pamphlet page 32, “Shooting Hygiene.”

Paragraph D. Storing a Shotgun—5 minutes
Teach steps 1–2 as written.

Teach requirement 2j on page 5 of the BSA *Shotgun Shooting* merit badge pamphlet. Reference “Choosing a Shotgun” on pages 46–49.—5 minutes

NOTE: The requirement is listed below along with a reference to teach from. **This requirement is not found in the FIRST Steps Shotgun Lesson Plan.** Teach this requirement after paragraph D: *Storing a Gun* and prior to continuing the FIRST Steps Shotgun Lesson Plan Paragraph E: *The Next Step*.

BSA Requirement 2j.

Discuss what points you would consider in selecting a shotgun.

*Reference *Shotgun Shooting* merit badge pamphlet pages 46–49, “Choosing a Shotgun.”

Paragraph E. The “Next Step”: Additional Shotgun Shooting Activities—5 minutes
Follow the NRA FIRST Steps Lesson Plan.

Teach merit badge requirements 1d through f and 1h through i, as listed on page 4 of the BSA *Shotgun Shooting* merit badge pamphlet. Other Shooting Activities—20 minutes

Note: The requirements are listed below along with references to teach from. **These requirements are not found in the FIRST Steps Shotgun Lesson Plan.** Teach these requirements following paragraph E-4: *Other Shooting Activities*.

BSA Requirement 1d.

Explain the main points of the laws for owning and using guns in your community or state.

*Consult state or local law enforcement.

BSA Requirement 1e.

Explain how hunting is related to the wise use of renewable wildlife resources.

*Reference *Shotgun Shooting* merit badge pamphlet pages 81–83, “Conservation and Hunting.”

BSA Requirement 1f.

Successfully complete a state hunter education course, or obtain a copy of the hunting laws for your state, then do the following:

(1) Explain the main points of hunting laws in your state and give any special laws on the use of guns and ammunition, and

(2) List the kinds of wildlife that can be legally hunted in your state.

*Refer to your state’s hunting regulations handbook

BSA Requirement 1h.

Identify and explain three shotgun sports. Identify places in your community where you could shoot these sports and explain how you can join or be a part of shooting sport activities.

*Reference *Shotgun Shooting* merit badge pamphlet pages 51–59, “Clay Target Sports.”

BSA Requirement 1i.

Give your counselor a list of sources that you could contact for information on firearms and their use.

*Reference *Shotgun Shooting* merit badge pamphlet pages 94–95, “Shotgun Shooting Resources.”

Merit Badge Worksheet review—25 minutes

Conclusion—5 minutes

Day 5

Continue Qualification Shooting as Needed: Merit Badge Qualification, Plus Winchester/NRA Qualification Program—2 Hours

**NRA
FIRST Steps
RIFLE
ORIENTATION**

**INSTRUCTOR'S
LESSON PLANS**

**BOY SCOUTS OF AMERICA
RIFLE SHOOTING
MERIT BADGE TEACHING GUIDE**

**NRA FIRST Steps Firearm Instruction, Responsibility, and Safety Training Program
First Edition**

©1995 The National Rifle Association of America

All rights reserved. Printed in the United States of America. This material may not be reproduced in whole or in part, by photocopying, mimeograph or by any other means without written permission. For information, write: Training Department, National Rifle Association, 11250 Waples Mill Road, Fairfax, VA 22030

TABLE OF CONTENTS

Introduction	5
Day 1, Lesson I.	
Introduction to Rifle Safety, Parts, and Operation	7
Day 2, Lesson II.	
Introduction to Ammunition and the Fundamentals of Rifle Shooting.....	9
Day 3, Lesson III.	
Introduction to Rifle Shooting From the Benchrest Position	10
Day 4, Lesson IV.	
Introduction to Rifle Cleaning, Storage, and Training Opportunities	11

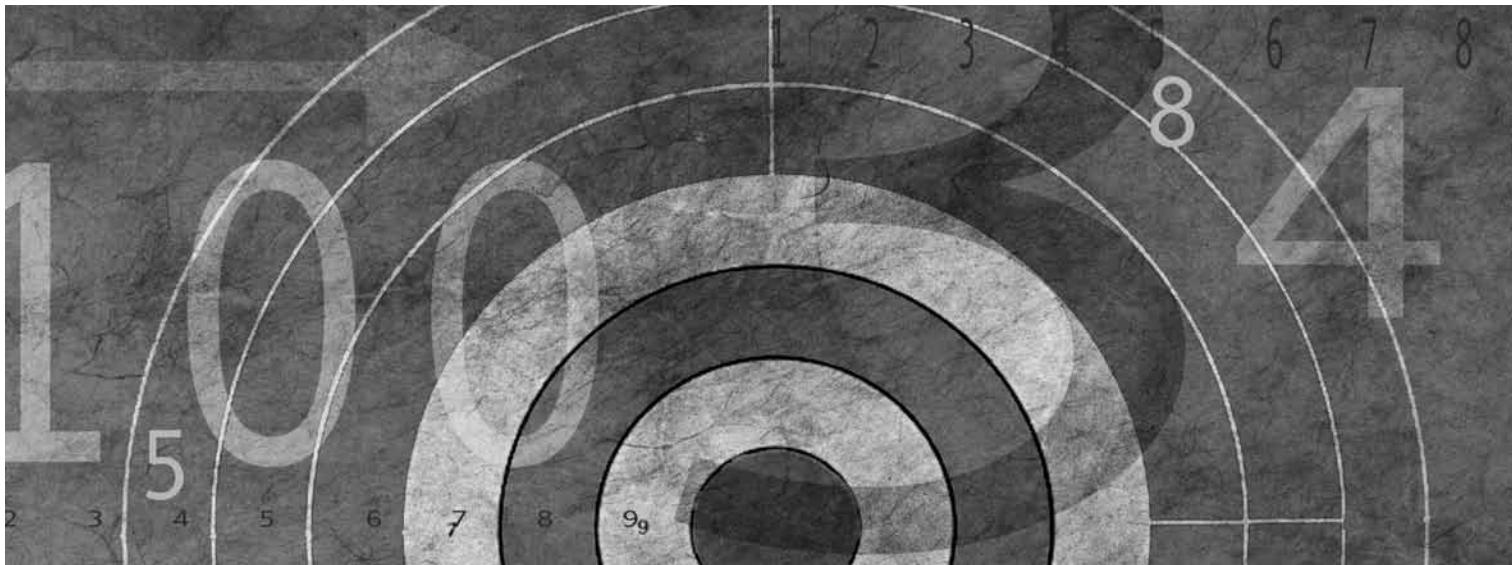

INTRODUCTION

The certified NRA rifle instructor who is serving as the merit badge counselor will need the following reference materials:

NRA FIRST Steps Rifle and Orientation Lesson Plans, No. 13212-1/2009, and BSA *Rifle Shooting* merit badge pamphlet, No. 35492.

The purpose of this manual is to integrate the BSA *Rifle Shooting* merit badge pamphlet with the NRA FIRST (Firearm Introduction, Responsibility and Safety Training) Steps Rifle Orientation Lesson Plans to allow those NRA certified rifle instructors who teach according to this manual to accumulate the five courses and a total of 25 students required to be eligible to attend an NRA Training Counselor Workshop.

In teaching the Rifle Shooting merit badge, the counselor/instructor must:

1. Follow the NRA FIRST Steps Rifle Orientation Lesson Plans, adding the BSA merit badge requirements as noted. This outline applies **ONLY** to Merit Badge Option A—Modern cartridge type.
2. Reference **BOTH** the BSA *Rifle Shooting* merit badge pamphlet and the NRA FIRST Steps Rifle Orientation Lesson Plans to complete the Training Counselor Workshop eligibility requirement.

NOTE: There are a few requirements of the Rifle Shooting merit badge that are not covered in the NRA FIRST Steps Rifle Orientation Lesson Plans which must be supplemented accordingly.

Each Scout should have his own copy of the BSA *Rifle Shooting* merit badge pamphlet.

Day 1

Lesson I. Introduction to Rifle Safety, Parts, and Operation—2 Hours

Paragraph A. Orientation—5 minutes

Step 1: Ask Scouts to fill out the Merit Badge Record Card or council-furnished documentation.

Steps 2–9: Follow the NRA FIRST Steps Lesson Plans.

Step 10: Distribute the BSA *Rifle Shooting* merit badge pamphlet instead of the NRA FIRST Steps Rifle Book. Distribute a Merit Badge Worksheet to each student.

Paragraph B. Introduce Lesson—10 minutes

Follow the NRA FIRST Steps Lesson Plan.

Paragraph C. Rifle Safety—10 minutes

Steps 1–2: Follow the NRA FIRST Steps Lesson Plan.

Step 3: Teach the NRA's Three Fundamental Rules for Safe Gun Handling.

BSA Requirement 2b.

Identify and demonstrate the three fundamental rules for safe gun handling.

*Refer Scouts to *Rifle Shooting* merit badge pamphlet page 17, “Fundamental Rules for Safe Gun Handling,” and use NRA FIRST Steps Rule 3.

Teach BSA *Rifle Shooting* merit badge pamphlet page 4 requirements 1a and b.—5 minutes

Note: These requirements are not found in the FIRST Steps Rifle Lesson Plan. Teach these requirements prior to continuing with the FIRST Steps Rifle Lesson Plan to paragraph D. *Safe Rifle Handling Practical Exercise* listed below.

BSA Requirement 1a.

Explain why BB and pellet air guns must always be treated with the same respect as firearms.

*Refer Scouts to *Rifle Shooting* merit badge pamphlet page 26, “Air Rifles.”

BSA Requirement 1b.

Describe how you would react if a friend visiting your home asked to see your or your family's firearm(s).

*Refer Scouts to *Rifle Shooting* merit badge pamphlet page 18, “Store guns so they are not accessible to unauthorized persons.”

Paragraph D. Safe Rifle Handling Practical Exercise—15 minutes

Follow the NRA FIRST Steps Lesson Plan.

BSA Requirement 2b.

Identify and demonstrate the three fundamental rules for safe gun handling.

*Refer Scouts to *Rifle Shooting* merit badge pamphlet page 17, “Fundamental Rules for Safe Gun Handling.”

Paragraph E. Rifle Parts: Major Components—5 minutes

Steps 1–3: Teach from the box below.

BSA Requirement 2a.

Identify the three main parts of a rifle, and tell how they function.

*Refer Scouts to *Rifle Shooting* merit badge pamphlet page 8 plus diagram.

Paragraph F. Rifle Parts—15 minutes
Teach as written in the NRA First Steps Lesson Plan.

BSA Requirement 2a.

Identify the three main parts of a rifle, and tell how they function.

*Refer Scouts to *Rifle Shooting* merit badge pamphlet page 9 plus diagram.

Paragraph G. Skipped in FIRST Steps Book (No info)

Paragraph H. Rifle Parts: Review—5 minutes
Follow the NRA FIRST Steps Lesson Plan.

Paragraph I. Rifle Operation—5 minutes
Steps 1: loading; 2: unloading. Follow the NRA FIRST Steps Lesson Plan.

Paragraph J. Rifle Operation Practical Exercise—15 minutes
Follow the NRA FIRST Steps Lesson Plan.

Assessment shooting (5 rounds) Minimal coaching—focus on safety—25 minutes

Paragraph K. Conclude Lesson—5 minutes
Steps 1–3: Follow the NRA FIRST Steps Lesson Plan.

Day 2

Lesson II. Introduction to Ammunition and the Fundamentals of Rifle Shooting—2 Hours

Paragraph A. Introduce Lesson—5 minutes
Follow the NRA FIRST Steps Lesson Plan.

Paragraph B. Rifle Ammunition—5 minutes
1. Ammunition compatibility

BSA Requirement 2c.

Identify the two types of cartridges, their parts, and how they function.

*Refer Scouts to *Rifle Shooting* merit badge pamphlet pages 33–34, “Ammunition.”

Paragraph B. Rifle Ammunition—15 minutes
2. Cartridge malfunction

BSA Requirement 2d.

Explain to your counselor what a misfire, hangfire, and squib fire are, and explain the procedures to follow in response to each.

*Reference *Rifle Shooting* merit badge pamphlet page 35, “Malfunctions.”

Paragraph C. Determining the Dominant Eye—10 minutes
Follow the NRA FIRST Steps Lesson Plan.

*Reference *Rifle Shooting* merit badge pamphlet, pages 36–37.

Paragraph D. Shooting Position—15 minutes
Steps a and b

Paragraph E. Fundamentals of Firing a Shot—25 minutes
Follow the NRA FIRST Steps Lesson Plan.

BSA Requirement 2e.

Identify and demonstrate the five fundamentals of shooting a rifle safely.

*Reference *Rifle Shooting* merit badge pamphlet pages 36–41, “Rifle Shooting Fundamentals.”

Follow up shooting—minimal coaching—focus on safety—40 minutes

Paragraph F. Conclude Lesson—5 minutes

Day 3

Lesson III. Introduction to Rifle Shooting From the Benchrest Position—2 Hours

Paragraph A. Introduce Lesson—5 minutes
Follow the NRA FIRST Steps Lesson Plan.

Paragraph B. Range Safety and Shooting Facility Orientation—10 minutes
Teach Steps 1–4 as written in the NRA FIRST Steps Lesson Plan.

Paragraph C. Rules for Safe Shooting—10 minutes

BSA Requirement 2f.

Identify and explain each rule for safe shooting.

BSA Requirement 1c.

Explain the need for, and use and types of, eye and hearing protection.

*Reference *Rifle Shooting* merit badge pamphlet pages 16–18, “Gun Safety.”

Paragraph D. Preparation for Shooting Exercises—10 minutes
Follow the NRA FIRST Steps Lesson Plan.

Paragraph E. Shooting From the Benchrest Position—75 minutes

BSA Requirement 2g.

Demonstrate the knowledge, skills, and attitude necessary to safely shoot a rifle from the benchrest position or supported prone position while using the five fundamentals of rifle shooting.

*Reference *Rifle Shooting* merit badge pamphlet pages 36–41, “Rifle Shooting Fundamentals,” and pages 51–54, “Firing Your First Shots.”

Note: Follow BSA *Rifle Shooting* merit badge pamphlet page 5 requirements 2k and 2l. The requirements are listed below along with references to teach from. **These requirements are not found in the FIRST Steps Rifle Lesson Plan.** Teach these requirements prior to continuing with the NRA FIRST Steps Rifle Lesson Plan, Paragraph F: Conclude Lesson.

BSA Requirement 2k.

Using a .22 caliber rimfire rifle and shooting from a benchrest or supported prone position at 50 feet, fire five groups (three shots per group) that can be covered by a quarter. Using these targets, explain how to adjust sights to zero a rifle.

BSA Requirement 2l.

Adjust sights to center the group on the target and fire five groups (five shots per group). According to the target used, each shot in the group must meet the following score: (1) A-32 targets—9; (2) A-17 or TQ-1 targets—7; (3) A-36 targets—5.

Editor’s Note: The second Paragraph E. Review of Shooting Practice is a printing error. Re-letter the paragraph to read “F,” and change Paragraph F. Conclude Lesson to read “G.”

Paragraph F. Review of Shooting Practice—5 minutes
Follow the NRA FIRST Steps Lesson Plan.

Paragraph G. Conclude Lesson—5 minutes
Follow the NRA FIRST Steps Lesson Plan.

Day 4

Lesson IV. Introduction to Rifle Cleaning, Storage, and Training Opportunities—2 Hours

Paragraph A. Introduce Lesson—5 minutes
Follow the NRA FIRST Steps Lesson Plan.

Paragraph B. Cleaning a Rifle—40 minutes
Follow steps 1–3 as written.

BSA Requirement 2h.

Identify the basic safety rules for cleaning a rifle, and identify the materials needed.

*Reference *Rifle Shooting* merit badge pamphlet page 30, “Cleaning Your Rifle.”

Teach step 4 Practical Exercise as written below.

BSA Requirement 2i.

Demonstrate how to clean a rifle properly and safely.

*Reference *Rifle Shooting* merit badge pamphlet pages 30–31, “Steps in Cleaning.”

Paragraph C. Hygienic Guidelines Following Exposure to Airborne Particulate Lead or Cleaning Solvent Residue—5 minutes
Follow the NRA FIRST Steps Lesson Plan.

BSA Requirement 1h.

Explain to your counselor the proper hygienic guidelines used in shooting.

* Reference *Rifle Shooting* merit badge pamphlet page 55, “Shooting Hygiene.”

Paragraph D. Storing a Rifle—5 minutes
Teach steps 1–2 as written.

Teach merit badge requirement 2j about selecting a rifle.

Note: The requirement is listed below along with a reference to teach from. **This requirement is not found in the FIRST Steps Rifle Lesson Plan.** Teach this requirement after paragraph D: *Storing a Gun* and prior to continuing the FIRST Steps Rifle Lesson Plan Paragraph E: *The Next Step*.

BSA Requirement 2j—5 minutes

Discuss what points you would consider in selecting a rifle.

*Reference *Rifle Shooting* merit badge pamphlet pages 21–25, “Choosing a Rifle.”

Paragraph E: The “Next Step”: Additional Rifle Shooting Activities—30 minutes
Follow the NRA FIRST Steps Lesson Plan.

Note: Teach merit badge requirements 1d through f and 1h and i listed on page 4 of the BSA *Rifle Shooting* merit badge pamphlet. The requirements are listed below along with references to teach from. **These requirements are not found in the NRA FIRST Steps Rifle Lesson Plan.** Teach these requirements following paragraph E-4: *Other Shooting Activities*.

BSA Requirement 1d.

Give the main points of the laws for owning and using guns in your community and state.

*Consult local and state law enforcement for this information.

BSA Requirement 1e.

Explain how hunting is related to the wise use of renewable wildlife resources.

*Reference *Rifle Shooting* merit badge pamphlet pages 82–83, “Conservation and Hunting.”

BSA Requirement 1f.

Obtain a copy of the hunting laws for your state. Explain the main points of hunting laws in your state and give any special laws on the use of guns and ammunition.

*Reference *Rifle Shooting* merit badge pamphlet pages 83–84.

BSA Requirement 1g.

Identify and explain how you can join or be a part of shooting sport activities.

*Reference *Rifle Shooting* merit badge pamphlet pages 57–59, “Olympic Games and Shooting.”

BSA Requirement 1i.

Give your counselor a list of sources that you could contact for information on firearms and their uses.

*Reference *Rifle Shooting* merit badge pamphlet pages 95–96, “Shotgun Shooting Resources.”

Merit Badge Worksheet review—25 minutes

Conclusion—5 minutes

Day 5

Continue Qualification Shooting as Needed: Merit Badge Qualification, Plus Winchester/NRA Qualification Program—2 Hours

Appendix 3

SAMPLE ONLY

This is an example of one council's standard operating procedures.

Your council will need to write its SOP to account for individual range situations unique to its camp.

Standard Operating Procedures for Rifle, Shotgun, and Pistol Ranges

I. Authorized Use of Range Facilities

- A. The council camp shooting ranges may be in operation only when the camp ranger gives permission. For special council/district events, shooting ranges must have the permission of council camping director.
- B. Council ranges will be under the supervision of a range safety officer, 21 years of age or older, holding a current NRA range safety officer certification. There must also be one or more NRA instructor(s) certified for that firearm, 21 years of age or older, holding a current NRA instructor certification. The ratio of NRA firearm-specific instructors to students is specified below.
- C. All range safety officers and NRA-certified firearm instructors must have a copy of their certification(s) on file with the NRA training team/shooting sports committee as well as on their person while operating the range.
- D. The range safety officer is responsible for the operation of a specific range. He or she is to run the range, maintain safety, and ensure all rules are followed. In order to fulfill these duties, the range safety officer cannot be involved in any instruction during live fire.
- E. Rifle ranges have a ratio of one instructor to a maximum of eight students. There is also one range safety officer per range.
- F. Shotgun ranges have a ratio of one instructor to one student. Current facilities can service no more than two shooters and one trap. There is also one range safety officer per range.
- G. Pistol ranges have a ratio of one instructor to three students. Current facilities can service no more than six shooters. There is also one range safety officer per range.
- H. Range operation will conform to current national BSA standards and the *Guide to Safe Scouting*. Booklets may be obtained from your council or through www.scouting.org/HealthandSafety/GSS/toc.aspx.
- I. For every one hour that you are open exclusively for your own unit, you must be open two hours to the camp. If there are only a couple of troops, you can contact them first to see if they are interested and then set hours accordingly.

- J. Range equipment and ammunition will be checked out by the camp ranger to the range safety officer and checked back in to the camp ranger.
- K. You may have only one class and caliber of firearm and ammunition on the range during live fire.
- L. The log with the standard operating procedures must be signed each time you run a range.

II. Opening Range

- A. Check that there is sufficient eye and ear protection equipment present.
- B. Check the range and equipment for safety issues prior to the start of your sessions.
- C. When ready to open, put the range flag up to show that you are ready. (Current flag locations are marked.)

III. Range Safety Briefing

- A. While gathered at a location outside the firing line:
 1. Introduce the range staff and who will be in charge of the range.
 2. Review the three "Fundamental Rules for Safe Gun Handling" (verbatim):
 - a. **Always** keep the gun pointed in a safe direction. (Declare that on this range "safe direction" means "toward the targets.")
 - b. **Always** keep your finger off the trigger until ready to shoot.
 - c. **Always** keep the gun unloaded until ready to use.
 3. Review general range rules:
 - Know and obey all range commands.
 - No running or horseplay.
 - Listen to and obey the range safety officer and instructor(s) at all times.
 - Shoot only at authorized targets.
 - Raise your hand to ask questions or to indicate a misfire (explain misfire).
 - Point out the spectator area.
 - Point out when and where eye and ear protection is or is not required.
 - Spectators must not converse with shooters while they are on the range.
 - Shooters and spectators ask permission to enter or exit the range.
 - **Remember SAFETY first.**
 4. Review equipment:
 - Explain how to hold the gun.
 - Explain how to operate the gun.
 - Explain how to sight in on the target.
 - Explain sight picture.
 - Explain how to load the gun and prepare to fire.
 5. Review the targets:
 - Explain to the shooters what they will be shooting at.
 - Explain to them what they are attempting to do.
 - Discuss shot groupings.
 6. Eye and ear protection. Explain how to properly put them on and fit them as required.

7. Eye dominance. Eye dominance should be checked with all shooters.
8. Shooting Fundamentals. Review the five shooting fundamentals:
 - Position
 - Sight picture
 - Breathing
 - Trigger control
 - Follow-through
9. To indicate an EMERGENCY OR HAZARDOUS CONDITIONS.
 - Use the command: **“CEASE FIRE!”**
 - Purpose: To stop all shooting routinely or, in the case of an emergency, immediately.
 - Action: Participants immediately stop shooting, continue to keep their muzzle pointed downrange, remove their finger from within the trigger guard, unload and clear the firearm as instructed, and wait for further instructions.
 - **A cease-fire can be called by anyone!**

B. Range commands and actions:

1. To prepare the range for live fire, the following commands are recommended for you to use. Please use your discretion in using them:
 - a. Command: **“Move forward/take your position on the firing line.”**
 - Purpose: To get shooters into position to prepare to begin shooting.
 - Action: Shooters will move from behind the ready line to their assigned position. Remind them as required: **DO NOT TOUCH YOUR RIFLE!** Let them get comfortable, and ensure they are in the correct position.
 - b. Command: **“Protective gear on.”**
 - Action: Shooters should put on their eye protection first, then ear protection.
 - c. Command: **“You may pick up your rifles.”**
 - Action: Shooters will pick up their rifle, sight in on the target, make any final adjustments, and prepare to load.
 - d. Command: **“Load!”**
 - Purpose: To notify the shooters that they may load their first round.
 - Action: Shooters will load their first round, close the bolt, keep their finger off the trigger, and wait for the next command.
 - e. Command: **“Is the line ready?”**
 - Purpose: To determine if all shooters along the line are ready.
 - Action: All shooters NOT ready should indicate their status to the range master. Sufficient time will be allowed for the shooter to complete his/her preparation.
 - f. Command: **“Ready on the right?”**
 - Purpose: To declare that the shooters have indicated they are ready on the right side of the range.
 - Action: Any shooter not ready at this command may choose to either alert the range master that he/she is not ready or to complete the process of getting ready before the final command has been given.

- g. Command: **“Ready on the left?”**
 - Purpose: To declare that the shooters have indicated they are ready on the left side of the range.
 - Action: Any shooter not ready at this command may choose to either alert the range master that he/she is not ready or to complete the process of getting ready before the final command has been given.
 - h. Command: **“The firing line is ready.”**
 - Purpose: To notify all shooters that the range is about to be under live fire.
 - Action: Shooters simply await the next command. If anyone is not ready at that point, he/she should notify a range master. (Audible or raised hand)
 - i. Command: **“Commence firing!”**
 - Purpose: To declare that the range is formally open for live fire.
 - Action: The shooters may commence the prescribed course of fire.
2. To stop firing and declare the range safe:
 - a. Command: **“Cease fire!”**
 - Purpose: To stop all firing.
 - Action: All shooters shall open the bolt, lay the rifle down with the bolt up, and remain in position until given further instructions.
 - b. Command: **“Range is clear.”**
 - Purpose: The range safety officer is telling all shooters that all guns are unloaded.
 - c. Command: **“Remove protective gear.”**
 - d. Command: **“Pick up your brass, place it in the bucket, and get a new target.”**
 - e. Command: **“You may go change your targets.”**
 - Actions: Shooters may move through the gate to the target area.
- C. Move to the firing line gate:
 1. Review again the three Fundamental Rules for Safe Gun Handling (verbatim).
 2. Point out the ready line:
 - Shooters DO NOT cross the line until instructed to do so by the range safety officer.
 - Shooters move back and forth across the line ONLY when instructed to do so by the range safety officer.
 - Shooters DO NOT touch the guns until instructed to do so by the range safety officer.

IV. Move Onto the Firing Line

- A. Stay behind the ready line.
- B. Explain the “prescribed course of fire,” e.g., how many rounds, time, targets, etc.
- C. Explain “Misfire!” and procedures:
 - A misfire occurs when you pull the trigger and the gun does not fire.
 - Continue to keep the gun pointed at the target and raise your hand, and an instructor will assist you. Also explain “hang fire” and the procedure to be followed.

- D. Review the command “**Load.**”
- Upon this command, shooters may load one round and prepare to fire, but **MUST NOT** fire until the command “Commence firing” is given.
- E. Review the command “**Cease fire**” and explain that shooters may also call “Cease fire.”
- F. Begin the firing session:
- Command: “**Move forward/take your position on the firing line.**”
 - Command: “**Protective gear on.**”
 - Command: “**You may pick up your rifles.**”
 - Command: “**Load.**”
 - Command: “**Is the line ready?**”
 - Command: “**Ready on the right?**”
 - Command: “**Ready on the left?**”
 - Command: “**Ready on the firing line?**”
 - Command: “**Commence firing.**”
 - Command: “**Cease fire.**”
 - Command: “**Range is clear.**”
 - Command: “**Remove protective gear.**”
 - Command: “**Pick up your brass, place it in the bucket, and get a new target.**”
 - Command: “**You may go change your targets.**”
- G. Repeat the commands for each firing sequence.
- H. Leave the range through the gate.

V. Closing Procedures

- A. Clear the range of all nonessential personnel.
- B. Put all range equipment away appropriately.
- C. Clean firearms properly.
- D. Remove flag when leaving range.
- E. Return all equipment to the ranger.
- F. Return signed SOP log book to the ranger.

VI. Emergency Procedures

- A. Take charge of the situation.
- B. Render aid.
- C. Call for help.
- D. Direct medical help to the location.
- E. Take notes and file an incident report. (Incident report forms can be obtained from the ranger, council staff, or council office and must be filed with the ranger and council office.)

Boy Scouts of America

Shooting Sports Decision Tree

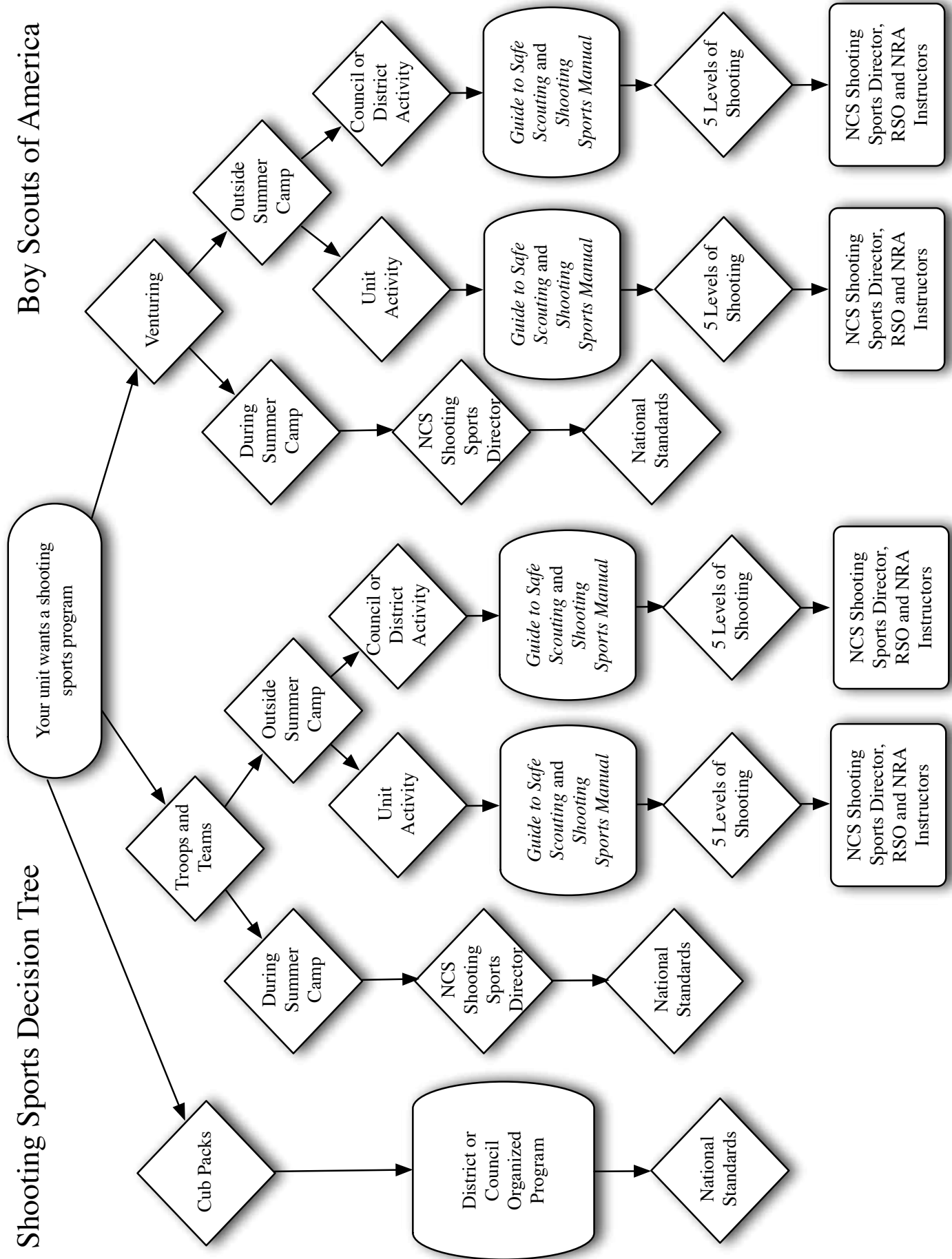

Appendix 5



ACTIVITY CONSENT FORM AND APPROVAL BY PARENTS OR LEGAL GUARDIAN

This form is recommended for unit use to obtain approval and consent for Tiger Cubs, Cub Scouts, Webelos Scouts, Boy Scouts, Varsity Scouts, Venturers, and guests (if applicable) under 21 years of age to participate in a den, pack, team, troop, or crew trip, expedition, or activity. This form is required for use with flying plans and should be attached to the flying plan application. It is recommended that parents keep a copy of the form and contact the tour leader in the event of any questions or in case emergency contact is needed. Additional copies of this form along with the *Guide to Safe Scouting* are available for download from Scouting Safely at www.scouting.org/forms.

First name of participant and middle initial _____ Last name _____

Address _____ Birth date (month/day/year) ____/____/____ Age during activity _____

Additional address (need street address if you have a P.O. box) _____

City _____ State _____ Zip _____

Has approval to participate in _____
(Name of activity, orientation flight, outing trip, etc.)

From _____ to _____
(Date) (Date)

- Without restrictions
- Special considerations or restrictions: _____

HOLD HARMLESS AGREEMENT

I understand that participation in Scouting activities involves a certain degree of risk and can be physically, mentally, and emotionally demanding. I have carefully considered the risk involved and have given consent for myself or my child to participate in this activity. I also understand that participation in this activity is entirely voluntary and requires participants to abide by applicable rules and standards of conduct. I release the Boy Scouts of America, the local council, the activity coordinators, and all employees, volunteers, related parties, or other organizations associated with the activity from any and all claims or liability arising out of this participation.

In case of emergency involving my child, I understand every effort will be made to contact me. In the event I cannot be reached, I hereby give my permission to the medical provider selected by the adult leader in charge to secure proper treatment, including hospitalization, anesthesia, surgery, or injections of medication for my child. Medical providers are authorized to disclose to the adult in charge examination findings, test results, and treatment provided for purposes of medical evaluation of the participant, follow-up and communication with the participant's parents or guardian, and/or determination of the participant's ability to continue in the program activities.

Participant's signature _____ Date _____

Parent/guardian printed name _____

Parent/guardian signature _____ Date _____

_____ Area code and telephone number (best contact and emergency contact) _____ Email (for use in sharing more details about the trip or activity)

Contact the adult tour leader with any questions:

Name _____

Phone _____ Email _____

Appendix 6

Resources

People

- Who to call for help:
 - Contact your local council's shooting sports committee chair
 - Boy Scouts of America: Curt Palmer at curt.palmer@scouting.org
- Local council websites
- Contacts at the National Rifle Association:
 - Youth programs coordinator: Mark Belli at mbelli@nrahq.org
- Contact USA Archery www.usaarchery.org:
 - Darin Erskine, email derskine@usarchery.org
- Contacts at the National Shooting Sports Foundation:
 - Zach Snow, email zsnow@nssf.org

Facilities

- Boy Scout local council camps
- Local shooting sports clubs:
 - National Wild Turkey Foundation, www.nwtf.org
 - Issac Walton League, www.iwla.org
- Local shooting sports ranges:
 - State wildlife ranges. Contact your local department of natural resources.
 - Law enforcement ranges
 - National Forest Service ranges
- Local gun and archery businesses:
 - May have local range information as to where you can shoot

Materials/Literature

- National Rifle Association, www.nra.org
- National Alliance for the Development of Archery, www.teacharchery.com
- National Archery in the Schools Program, www.archeryintheschools.org
- After School Archery Program, www.afterschoolarchery.com
- National Sporting Clays Association, www.mynsca.com
- National Skeet Shooters Association, www.mynssa.com
- International Hunters Education Association, www.ihea.com
- National Muzzleloading Rifle Association, www.nmlra.org

Equipment

- National Shooting Sports Foundation, www.nssf.org
- Archery Trade Association, www.archerysearch.com
- Daisy, www.daisy.com
- Crosman, www.crosman.com
- Benelli, www.benelliusa.com
- Beretta USA, www.berettausa.com
- Browning, www.browning.com
- Remington, www.remington.com
- Winchester, www.winchester.com
- Federal Premium Ammunition, www.federalpremium.com

Programs

Advancement

- Boy Scout:
 - Merit badges. Refer to Chapter 3, "Merit Badge Counselors," rifle shooting, shotgun shooting, archery.
 - NRA Outstanding Youth Achievement Award. Refer to Chapter 2 and www.nrahq.org.
- Cub Scout: BB Shooting and Archery belt loops and pins. Refer to Chapter 2, "A Wealth of Year-Round Opportunities."
- Venturing:
 - Ranger Award
 - BSA Shooting Sports Outstanding Achievement Award. Refer to www.scouting.org.
 - NRA Outstanding Youth Achievement Award. Refer to Chapter 2 and www.nrahq.org.

Events

- Unit: Cub Scouts may participate in shooting events only at council- and/or district-level activities. Boy Scout troop, Varsity team, Venturing crew, and Sea Scout ship activities are based on qualifications of personnel and adequacy of ranges that meet or exceed BSA requirements spelled out in this manual and the *Guide to Safe Scouting*.
- District: Cub Scout day camp programs
- Council:
 - Summer camp programs
 - Cub Scout resident camp programs
 - NRA postal matches. Refer to Chapter 2 and www.nrahq.org/compete/dept-postal.asp.
 - NRA Day. NRA Day is a great way to introduce youth to shooting sports and shows what the NRA has to offer. The event can be tailored to meet the needs of the group with many themes to choose from. Contact the NRA at 703-267-1591 or email youthprograms@nrahq.org.

Notes

Notes

Notes

Prepared. For Life.™



BOY SCOUTS OF AMERICA
1325 West Walnut Hill Lane
P.O. Box 152079
Irving, TX 75015-2079
<http://www.scouting.org>

SKU 430029

