

Owner's Manual

AMC

720

760

800

900_{THX}

Snell

SPECIFICATIONS	AMC720	AMC760
Frequency Response (± 3 dB)	65 Hz–20 kHz	62 Hz–20 kHz
Recommended Amplifier	10–125W	10–150W
Nominal Impedance	8 ohms	8 ohms
Sensitivity (2.83v at 1m)	87dB SPL	89dB SPL
Tweeter(s)	1" aluminum dome, ferrofluid cooling and heatsink. Steerable "Directed Power" waveguide	1" aluminum dome, ferrofluid cooling and heatsink. Steerable "Directed Power" waveguide
Midrange	n/a	n/a
Bass Driver	5 $\frac{1}{4}$ -inch (132mm) copolymer with butyl rubber surround	6 $\frac{1}{2}$ -inch (165mm) copolymer with butyl rubber surround
Crossover Point	2.7 khz	2.7 khz
Composite Baffle	Specialty adhesive between two $\frac{1}{4}$ " layers of HD fiberboard	Specialty adhesive between two $\frac{1}{4}$ " layers of HD fiberboard
Grille	White cloth over MDF frame	White cloth over MDF frame
Dimensions (HxWxD)	14 x 8 $\frac{1}{2}$ x 3 $\frac{3}{4}$ inches (356 x 216 x 95mm)	17 x 10 $\frac{1}{2}$ x 3 $\frac{3}{4}$ inches (432 x 267 x 95mm)
Rough Opening Cutout (HxW)	12 $\frac{7}{8}$ x 7 $\frac{3}{8}$ inches (327 x 187mm)	15 $\frac{7}{8}$ x 9 $\frac{3}{8}$ inches (403 x 238mm)
Finish*	White trim, suitable for painting	White trim, suitable for painting
Weight	21 lbs (9.5kg) / pair	23 lbs (10.5kg) / pair

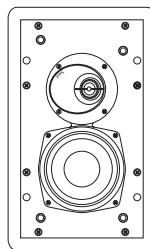
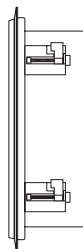

AMC720

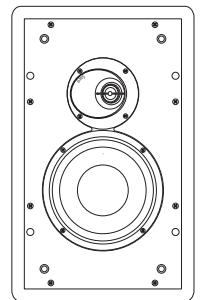
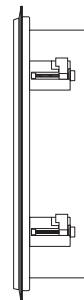

AMC760

AMC800**AMC900_{THX}**

65 Hz-20 kHz

78 Hz-20 kHz

10-200W

10-150W

4 ohms

6 ohms

90dB SPL

87dB SPL

1" Aluminum dome, ferrofluid cooling and heatsink. Steerable "Directed Power" waveguide

(2) 1" aluminum dome, ferrofluid cooling and heatsink. "Directed Power" waveguide in dipole configuration

n/a

3 1/2" Midrange, edge-mounted in dipole configuration

6 1/2-inch (165mm) copolymer with butyl rubber surround

6 1/2-inch (165mm) copolymer with butyl rubber surround

600 Hz, 3kHz 2 1/2 way

400 Hz, 2.5 kHz, 12dB/octave

Specialty adhesive between two 1/4" layers of HD fiberboard

Specialty adhesive between two 1/4" layers of HD fiberboard

White cloth over MDF frame

White cloth over MDF frame

23 1/4 x 13 1/4 x 3 3/4 inches
(590 x 336 x 95mm)

23 1/4 x 13 1/4 x 3 3/4 inches
(590 x 336 x 95mm)

22 x 12 inches
(559 x 305mm)

22 x 12 inches
(559 x 305mm)

White trim, suitable for painting

White trim, suitable for painting

22 lbs (10kg) each

22 lbs (10kg) each

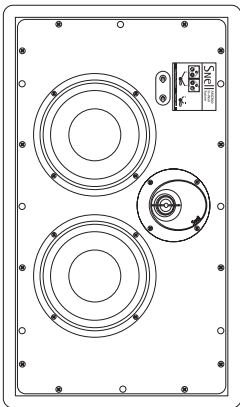
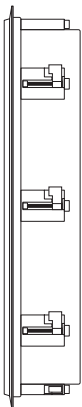

AMC800

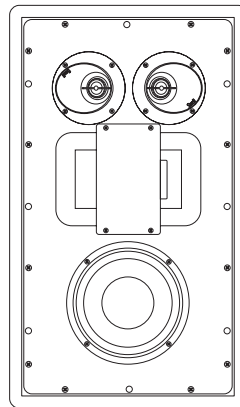
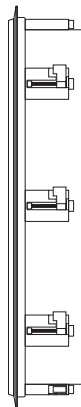
AMC900_{THX}

INTRODUCTION: WHAT IS A HIGH END IN-WALL?

The new Snell AMC series units bring a novel approach to the design and construction of in-wall loudspeakers, expanding the boundaries of in-wall performance.

Our primary goal was to develop loudspeakers that delivered performance that was as close as possible to that of our highly regarded freestanding loudspeakers, like the K.5 mk2 and E.5 mk2. To do this, several issues had to be addressed.

The bass performance of conventional loudspeakers mounted in wall cavities is very unpredictable. Cavity volume can be large, which should be good for bass performance. However, with one very short dimension (approximately 4") and one very long dimension (up to 8'), the wall cavity takes on the characteristics of a closed-end organ pipe. This creates a strong resonance that tends to null out the bass. Lining this cavity with fiberglass will reduce the "Q" of the notch but not restore the bass. What is needed is a defined volume of a more regular size. This is best done with fully enclosed in-wall speakers.

The Snell AMC loudspeaker enclosure is a thin, but strong, aluminum tub. It is both damped and braced. This largely contains the back radiated sound of the woofer within the enclosure. An added benefit of containing the woofer output is a reduced chance that resonances will be excited in the house walls. Furthermore, sound "bleed through" to adjacent rooms is reduced.

To minimize resonances in the Snell enclosure, the speaker baffle uses a technique first pioneered on our .5 and XA series loudspeakers. The baffle is a three part composite with MDF (fiberboard) outer layers around a thin, but highly effective, damping layer. This controls the panel resonances of the baffle that can obscure midrange clarity. As we have found with our freestanding loudspeakers, a better loudspeaker cabinet means a better sounding loudspeaker.

Conventional in-wall speakers also suffer from poor stereo imaging. Freestanding speakers can be angled inward to produce a better central image and make listening position much less critical. In-wall speakers obviously cannot be angled in this way. Some in-wall speakers use a pivoting post-mounted tweeter in attempt to overcome this limitation. The pivoting mechanism produces reflections that adversely affect the tweeter's response and sound. Also, the small baffle area of the pivoting tweeters means that only the highest frequencies can be angled inward.

The Snell solution is a unique tweeter that incorporates a waveguide with a fixed 20 degree angle. The DPT ("Directed Power Tweeter") waveguide design controls reflections to ensure smooth response. The waveguide is also large enough to function effectively over the full range of the tweeter. The DPT driver can be easily unfastened and rotated to any of eight positions in 45 degree increments. This, together with the designed-in angle of the driver, lets you direct the sound inward to focus a stereo image. Or the sound can be directed away from the listening area to produce a more diffuse sound field when the AMC 720, AMC 760 or AMC 800 are used as surround speakers.

In addition to these unique solutions, all traditional Snell attributes are retained. Highly coherent in-phase crossover networks ensure a seamless blend from driver to driver. Drivers are designed for smooth, wide range response and low distortion. Long sessions of listening and adjusting give each system that special, characteristic Snell sound. Finally, that Snell sound is guaranteed in every production pair by Snell's proprietary 0.5dB production tuning techniques.

PLACEMENT OF THE FRONT CHANNEL SPEAKERS

A home theatre system includes three loudspeakers placed across the front of the listening room. The distance between the left and right speakers determines the width of the stereo image. If the speakers are placed too close together, the image will be too narrow; too far apart and the blend will suffer, creating a hole in the middle. When properly placed, your speakers will create a continuous "virtual image" from left to right, with an illusion of sound outside, in front of, and behind the speaker systems.

We recommend an angular separation between 45 degrees and 60 degrees (when viewed from above). This is equivalent to a separation between the speaker systems that is about 85% of the distance to either of the speakers.

Creation of sounds between the speakers requires some precise placement. The distance from the left speaker, right speaker, and center channel to the listener location should all be as equal as possible. We advise using a tape measure to equalize these two distances to the primary listening location.

Ideally the front channel speakers should be installed at the same height as the ears of a seated listener. Try to keep the front channel tweeters within two vertical feet of that height. If speakers must be installed more than 2-3 feet above or below the ideal position, take advantage of the DPT rotating feature. For example, aim the tweeter downward when the speakers are mounted high on the wall. For more information, refer to the "Aiming the DPT" section.

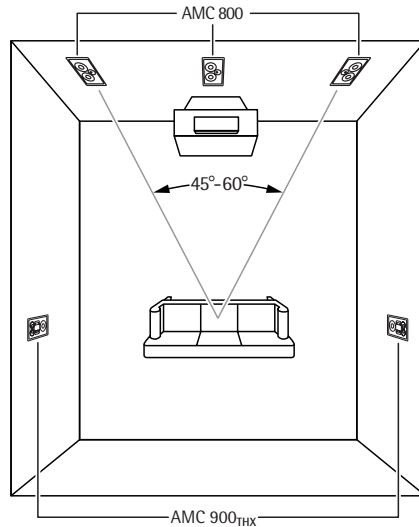

PLACEMENT OF THE SURROUND SPEAKERS

There are many opinions about where surround or "rear" speakers should be mounted. The following is based on the findings of the best academics, and on our experience with many installations. These placement recommendations apply to all the AMC models, whether you are using AMC 900THX (dipole surrounds) or AMC 720, AMC 760 or AMC 800 (direct speakers).

When selecting installation locations for the AMC 720, AMC 760 or AMC 800, remember that you can increase the diffusion of their sound by aiming their DPT drivers away from the listening area (see the "Aiming the DPT" section). The tweeters can be aimed toward a reflecting surface, or a surface that will scatter the sound, such as a shelf full of books or other irregular surface. The AMC 900THX tweeters should *not* be repositioned.

If two surrounds are used in a standard 5.1 configuration (not 7.1 or EX), they are best mounted to the sides of the listening area. This means straight to the sides of the listener or in line with the primary row of seating, plus or minus 15 degrees. This is preferred over back wall mounting for several reasons: It places the surrounds at locations where the difference between left ear and right ear discrimination is at a maximum. This gives the maximum sense of "envelopment" or being surrounded by sound. Rear mounted speakers force a huge angular gulf between the front primary speakers and the rear speakers. The sound image is inherently discontinuous. Also, front to rear aural discrimination is not very strong. Differentiation between front and rear speakers will not be as strong as the effect of adding speakers to the side. 7.1 or EX systems that use side and rear speakers together overcome all of these obstacles and give both maximum envelopment and a more continuous surround effect.

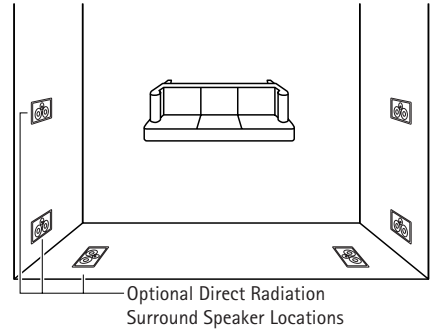

A second factor to consider is the evenness of sound coverage over the seating area. Most surround processors have features for setting the balance of all channels. A circulating noise signal is adjusted in each channel until the apparent or measured sound level is even. Of course, moving to another seat will shift this balance somewhat. Well-placed surround speakers will minimize the level variation from seat to seat. The best way to achieve evenness is to increase the distance of the surround speakers from the listening area. Mount them high on the side walls or even on the ceiling. As a good rule of thumb, surrounds should be on the side walls at least one foot above the height of a standing listener. If the speakers are ceiling-mounted, they should be close to the side walls, well away from an overhead position.

If a large theater room with three or more rows of seats is planned, then more than one pair of surround speakers should be used to give more even coverage and a more diffuse sound field. We recommend that a pair of surrounds be used for every other seating row (the first, the third, the fifth, etc.). This follows standard cinema practice.

Special Considerations for the AMC 900THX

Placement of a dipole surround speaker, such as the AMC 900THX, requires another consideration. For a dipole to give a properly diffuse sound the listeners should be on or near the "null plane". Imagine a line running down the middle of the front of the AMC 900THX (along the longer dimension), between the two tweeters and across the center of the woofer. A plane sticking straight out from this line (at 90 degrees to the wall) defines the null plane. For any listener on this plane, the output of the two tweeters and the midrange will be at maximum cancellation. A listener at this position will hear the speaker only via multiple wall reflections. This is why the dipole sounds diffuse.

So the AMC 900THX should be installed where the null plane will run through the primary listening area. This can be achieved either with the AMC 900THX installed in a side wall (with the long axis of the speaker oriented vertically) or on the ceiling (with the long axis of the speaker oriented across the width of the room).

AIMING THE DPT (AMC720, AMC 760 and AMC800 only)

In addition to providing an extremely clean wide range response, the DPT have the added feature of an adjustable waveguide (in 45 degree increments). This unique Snell feature provides the opportunity to toe-in conventionally mounted in-wall systems or compensate for the less than ideal placements that occur in the real world. This feature will greatly improve imaging.

To adjust the DPT rotation, remove the four wood screws with a 5/64" allen driver and rotate the driver to the desired positions.

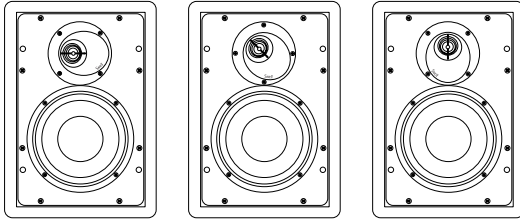

Three examples of how the DPT waveguide tweeter can be rotated in 45° increments.

MULTIPLE DISPERSION PATTERNS (AMC 800 only)

The AMC800 can be set to reproduce two dispersion patterns. You determine the dispersion pattern by selecting which of the two bass units will operate as the midbass driver. The dispersion pattern can be seen as an ellipse, whose length is a line perpendicular to the tweeter/midbass combination as shown below.

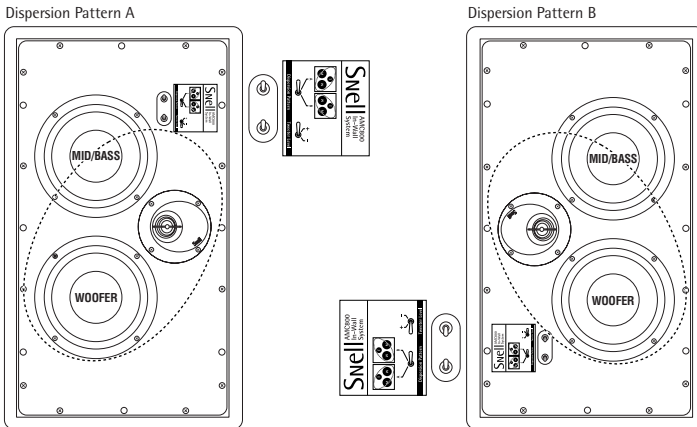

Setting the Dispersion Switch

The illustrations below show the recommended Dispersion Switch setting for most common placement options for the AMC 800.

Horizontal Placement

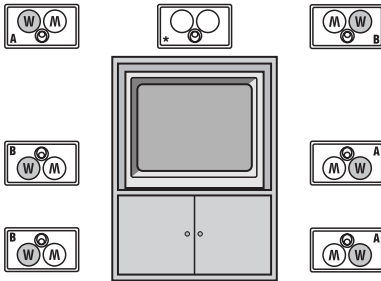

Vertical Placement

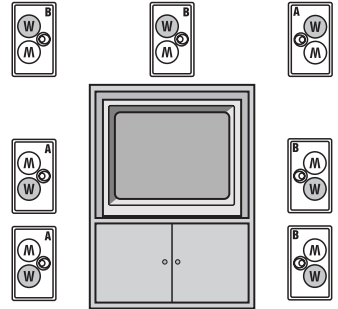

*Note: When the AMC 800 is used as a center channel speaker and is placed horizontally, the dispersion switch may be set in either position.

INSTALLATION INSTRUCTIONS

IMPORTANT: This manual assumes that the installer possesses skill in the proper use of hand and power tools, knowledge of local building and fire codes, and a familiarity with the environment behind the wall or ceiling in which the speakers will be installed.

Optional preconstruction brackets are available for each model.

PAINTING THE SPEAKERS

If you intend to paint the speakers, it is best to do so before installation.

- 1) Remove the speaker grille.
- 2) Mask the baffle.
- 3) After painting, carefully remove the paint mask.

Note: Custom paint and grilles are available for an extra charge.

PREPARING FOR INSTALLATION

Map out the wiring paths from the speakers to the amplifier. We recommend 16-gauge wire for runs up to 25 feet, and 14-gauge wire for longer runs. Be sure the speaker wire does not rest or rub against any sharp or pointed objects.

The speakers should be mounted on a flat surface to form a good seal between the speaker flange and the mounting surface.

When connecting more than two speakers per amplifier channel, you should use series/parallel wiring. In all cases, make certain that the total impedance does not fall below the amplifier's rating. If you are not sure, contact your Snell Acoustics dealer.

You will Need:

- 1) A utility knife, an electric jigsaw, or other means of cutting a hole in the mounting surface.
- 2) A #2 Phillips screwdriver.
- 3) A wire cutter or stripper for preparing the speaker wires.

With the supplied hardware, the speaker can be installed in existing walls or ceilings from 1/2" (12mm) to 1 1/2" (38mm). For thinner walls, you will need to use spacers for the mounting legs (contact your Snell dealer for this optional rubber part).

INSTALLATION

For convenient installation, the Snell AMC720, AMC760, AMC 800 and AMC 900_{THX} use a dog-leg mounting system (see illustrations below). This provides a quick and clean install. Furthermore, the dog-legs can be removed if a particular situation requires to speaker to be directly attached to a stud.

Note: As an added security feature, the speaker tubs can be pre-mounted without the baffle, drivers, and crossovers installed. This will allow you to protect the delicate speaker components from debris if significant construction work is being done near the speaker installation location.

- 1) Make an appropriate size speaker mounting cutout in the wall material.
- 2) Run the wire from the amplifier to the cutout. Allow an extra foot of wire at the cutout. Strip 1/2" (12mm) off the wire, and tightly twist the wire strands together.
- 3) Remove the speaker grille.
- 4) Insert the speaker wires into the spring terminal binding posts.

Important: Typically, one side of the wire is smooth. Connect this side to the - (black) speaker terminal. The other side has a rib or stripe. Connect this to the + (red) speaker terminal. Connect wire at the amplifier in the same way. Failure to do so will result in degraded sound.

Warning! To prevent electrical shock, always switch off the amplifier or receiver when making connections to the speaker system.

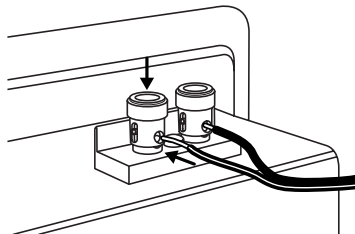

Continued

- 5) Place the speaker into the rough opening.
- 6) Level the speaker and tighten the screws, being careful not to over tighten them. See diagram below for details.

Turn the mounting clamps against the enclosure, then place the speaker in the mounting hole. Use a phillips head screwdriver to deploy the mounting clamps and pull them against the back of the drywall.

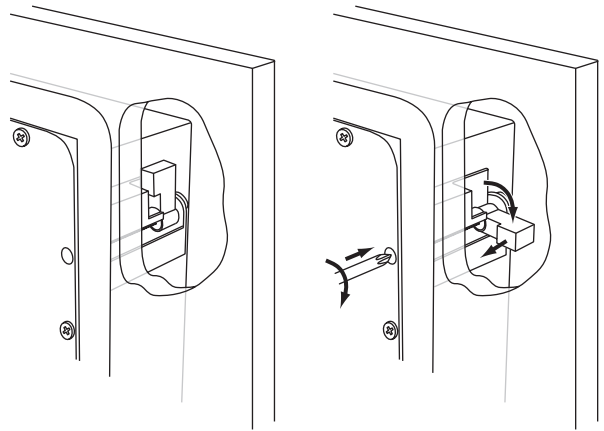

- 7) Replace the speaker grille.

Note: The AMC 900_{THX} is sold in pairs. On the cabinet, near the input terminals, is a temporary label to specify screen direction. The response will be slightly superior in this direction. Install the two AMC 900_{THX}'s so that the arrows BOTH point toward the screen. If listeners are not going to be located on or near the center axis of the speaker, the speaker should be oriented with the arrow toward the listener location (even if this is away from the screen).

LISTENING LEVELS AND POWER HANDLING

The power recommendation for the system assumes you will operate the amplifier in a way that will not produce distortion. All speakers can be damaged by even a modest amplifier if it is producing distortion. If you hear a gritty noise or other signs of strain, turn down the volume. Prolonged or repeated operation of your speakers with a distorted signal can cause damage that is not covered by the warranty. It is especially important that you do not overdrive the bass capability of smaller speakers. Watch for noises, such as pops, caused by the music's bass line. Use of the loudness control and/or full bass boost at louder volumes is likely to overdrive the woofer. Use such controls sparingly.

HOW TO CARE FOR YOUR SPEAKERS

- ▶ Use a soft terry cloth towel slightly dampened with water, glass cleaner, or a diluted mild detergent. The towel should be just damp enough to wipe the surface clean without leaving a trail of moisture.
- ▶ Do not use abrasive cleaners or any cleaner containing chemicals harsher than those found in glass cleaner.

LIMITED WARRANTY

For five years from the date of purchase, Snell Acoustics will repair for the original owner any defect in materials or workmanship that occurs in normal use of the speaker system, without charge for parts and labor.

Your responsibilities are to use the product according to the instructions supplied, to provide safe and secure transportation to an authorized Snell Acoustics service representative, and to present proof of purchase from an authorized Snell dealer in the form of your sales slip when requesting service.

Excluded from this warranty is damage that results from abuse, misuse, accidents, shipping, repairs, or modifications by anyone other than an authorized Snell Acoustics service representative. This warranty is void if the serial number has been removed or defaced.

This warranty gives you specific legal rights, and you may also have other rights that vary from state to state.

If Service Seems Necessary

Contact the dealer from whom you purchased the speaker system. If that is not possible, call us at 978-373-6114, or write to:

Snell Acoustics
143 Essex Street
Haverhill, MA 01832

We will promptly advise you of what action to take. If it is necessary to return your speaker system to the factory, please ship it prepaid in the original factory packaging. Please note that Snell Acoustics will not be held liable for shipping damage due to improper packaging. After it has been repaired, we will return it freight prepaid in the U.S. or Canada.

Snell

143 Essex Street
Haverhill, MA 01832
phone: 978-373-6114
fax: 978-373-6172
email: info@snellacoustics.com
www.snellacoustics.com

©2002 Snell Acoustics. All Rights Reserved.
Specifications are subject to change without notice.
Covered by patents issued and/or pending.
Part #542-1026