

ETHOS *CFD AMP*

USER'S MANUAL



A Product of
CUSTOM TONES LLC
WWW.CUSTOMTONESINC.COM

SPECIFICATIONS SUBJECT TO CHANGE WITHOUT NOTICE

ETHOS CFD AMP

Overview

Custom Tones LLC is pleased to introduce the Ethos CFD AMP. Designed to incorporate 15 years of valued customer feedback, this *versatile* two channel preamp/pedal/AMP is inspired by the iconic Fender® Deluxe Reverb® and the much sought after Dumble® Overdrive Special®. The Ethos Clean Fusion Deluxe is *feature rich* while being *old school friendly* where complex menus, displays, and a software degree are not required to use its *straight forward* analog user interface. Versatile in nature, it can be used for multiple applications, e.g. guitar pedal, direct interface for FOH or recording and a GUITAR AMP.



Key Features

- F-Clean Channel – Fender® Deluxe Reverb® Voiced
- D-Overdrive Channel – Dumble® Overdrive Special® (DD Channel) SN 102, Skyliner Tone Stack Voiced
- Integrated 30W RMS @ 8 ohms, POWER AMP
- HRM Post EQ with Boost – Foot Switch Selectable and assignable to either or both F and D Channels
- Preamp Boost (PAB) – Foot Switch Selectable Boost (Tones Stack Lift) for D-Channel
- HICUT – Top End Attenuation, Independent level controls for each channel
- REVERB – Plate Type, Independent level controls for each channel
- MASTER Contour Circuits – Used to tune the unit to its destination; guitar amp, power amp, direct
- Effect Loop – Post Drive, Zin Imegohm, Zout Ikohm
- Head Phone Interface
- Speaker Sim Out – G1265/RWB Based, TRS out, Direct Applications: eg PA-FOH, DAW-recording
- Remove Foot Switch Interface – RJ45, Active, Channel Select, HRM EQ, PAB, D – Brite, D- Mid Select
- Top Mounted Jacks
- Compact size: 10"W x 2.9D" x 3.2H"

Configured in a *compact package*, the Ethos Clean Fusion Deluxe Amp allows the artist to access various tones *on-the-fly* as well as providing functional control via an optional remote foot switch

SPECIFICATIONS SUBJECT TO CHANGE WITHOUT NOTICE

ETHOS CFD AMP

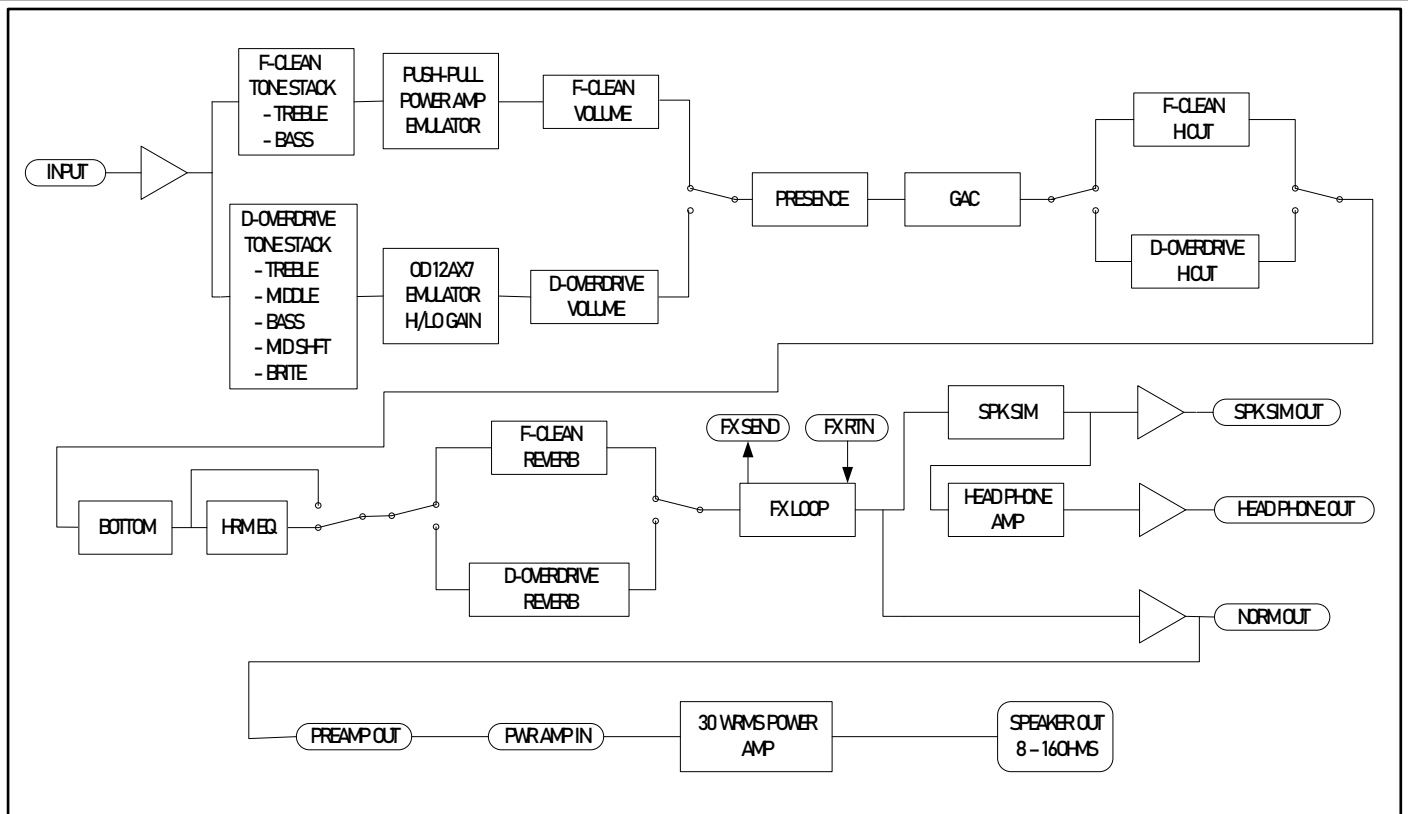

BLOCK DIAGRAM

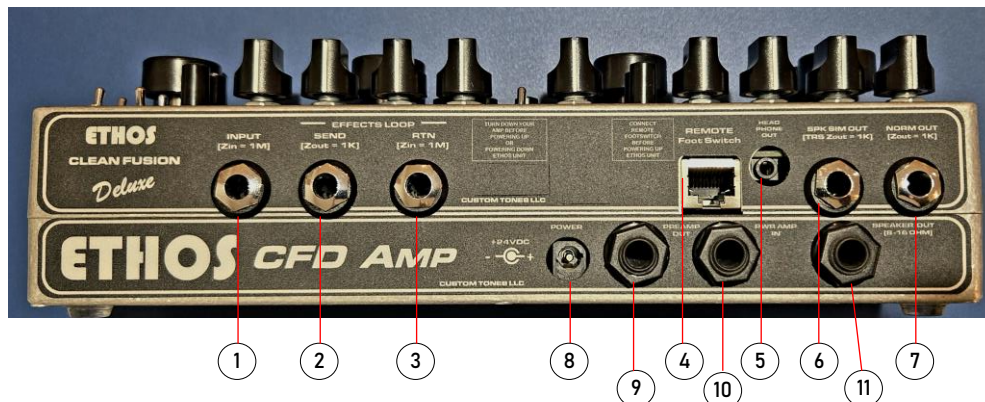

SPECIFICATIONS SUBJECT TO CHANGE WITHOUT NOTICE

ETHOS *CFD* AMP

TOP PANEL SPECIFICATIONS			
No	Function	Feature	Details
1	F-CHANNEL	GAIN CONTROL	Determines Gain Level of Preamp Stage
2		TREBLE CONTROL	Controls Pre-Drive Treble Response of Channel
3		BASS CONTROL	Controls Pre-Drive Bass Response of Channel
4		VOLUME CONTROL	Controls Overall Output Volume of Channel
5		HICUT CONTROL	Post Drive Hi Frequency Cut
6		REVERB CONTROL	Controls Reverb Level of Channel, Post Drive
7	D-CHANNEL	GAIN CONTROL	Determines Gain Level of Preamp Stage
8		ACCENT SWITCH	3 Position: UP = Mid shift boost, CENTER = Off, DOWN = Brite,
9		GAIN SWITCH	2 Position: Down: Low Gain, UP : High Gain, Pre Drive
10		TREBLE CONTROL	Controls Pre-Drive Treble Response of Channel
11		MIDDLE CONTROL	Controls Pre-Drive Mids Response of Channel
12		BASS CONTROL	Controls Pre-Drive Bass Response of Channel
13		VOLUME CONTROL	Controls Overall Output Volume of Channel
14		HICUT CONTROL	Post Drive Hi Frequency Cut
15		REVERB CONTROL	Controls Reverb Level of Channel, Post Drive
16	MASTER	GAC SWITCH	Activates Guitar Amp Compensation Circuit. (-) UP : Off (H) CENTER : Use with heavily notched amps amp tone stacks (L) DOWN : Use with subtlety notched amp tone stacks,
17		HRM SELECT SWITCH	Assigns HRM EQ when activated via HRM Footswitch (F) UP: Assigned to F-Channel (B) CENTER: Assigned to both F-Channel and D-Channel (D) DOWN: Assigned to D-Channel
18		PRESENCE SWITCH	Post Channel Hi Freq Filter (H) UP: Boost (-) CENTER: OFF (L) DOWN: Cut
19		BOTTOM SWITCH	Post Channel Lo Freq Filter (H) UP: MAX Boost (-) CENTER: OFF (L) DOWN: MIN Boost
	HRM EQ	BOOST CONTROL	Controls the Overall Level of HRM EQ
21		HI CONTROL	Controls Post Drive High Frequency Response
22		MID CONTROL	Controls Post Drive Mid Frequency Response
23		LO CONTROL	Controls Post Drive Bass Frequency Response
24	FOOTSWITCH	ACTIVE	Activates Unit, Indicated by Yellow LED
25		HRM	Activates HRM EQ, Indicated by Orange LED
26		PAB	Activates PAB, Indicated by Red LED
27		CHANNEL SELECT	Selects F-Channel/D-Channel Indicated by Green/Red LEDs

SPECIFICATIONS SUBJECT TO CHANGE WITHOUT NOTICE

ETHOS CFD AMP

<i>REAR PANEL SPECIFICATIONS</i>		
No.	Feature	Details
1	INPUT	Instrument Inpu, Zin = 1 Megohm, ¼" JACK
2	FX SEND	Effects Loop Send , Zout = 1Kohm, ¼" JACK
3	FX RETURN	Effects Loop Return, Zin = 1 Megohm, ¼" JACK
4	REMOTE FS JACK	Remote Footswitch Jack, RJ45 JACK
5	HEADPHONE OUT	1/8" Jack, Tapped form Speak Sim Output
6	SPEAKER SIM OUT	61265/RWB Based, TRS ¼" JACK
7	OUTPUT	Preamp Output, Zout = 1Kohm, ¼" JACK
8	POWER INPUT	+24VDC (Regulated), 2amp, Jack 2.5 mm x 5.5mm (center cond (+) polarity
9	PREAMP OUT	Preamp Output, Zout = 1Kohm, ¼" JACK
10	PWR AMP IN	Power Amp Input, Zin = 1Mohm, ¼" JACK
11	SPEAKER OUT	Power Amp Output, 8 - 16 ohms

<i>PHYSICAL SPECIFICATIONS</i>	
Feature	Details
Weight	1.8 lbs (power supply not included)
Size	10" x 2.9" x 3.2" (W x D x H) H = Height to footswitch topper

GROUND LOOPS:

The Ethos CFD Amp's power supply utilizes an earth ground (third pin on plug). If the Ethos CFD Amp is connected to other devices, e.g. guitar amps, mixers, effect, etc., that also utilizes an earth ground, a ground loop may be generated. In some instances the ground loop may create a 60Hz hum or other possible audible noises. To remove the noise the loop needs to be broken. This can be done two ways.:

- A. An isolation plug can be used on the Ethos CFD Amp's power plug that isolates that device's earth ground.
- B. An isolation transformer can be placed in series between the audio connection of the Ethos CFD amp and the other device that has the earth ground plug.

REMINDER:

TO AVOID HEARING POWER TRANSIENTS
TURN DOWN YOUR AMP, PA, DAW and UNPLUG YOUR HEADPHONES
BEFORE POWERING UP or POWERING DOWN the ETHOS CLEAN FUSION DELUXE
[Power Up / Power Down transition time = 20 seconds]

SPECIFICATIONS SUBJECT TO CHANGE WITHOUT NOTICE

ETHOS CFD AMP

APPLICATIONS

NOTE: All outputs can be used at the same time.

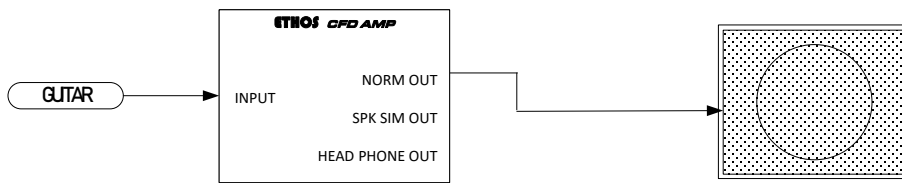

Guitar >> ECFDA >> Speaker

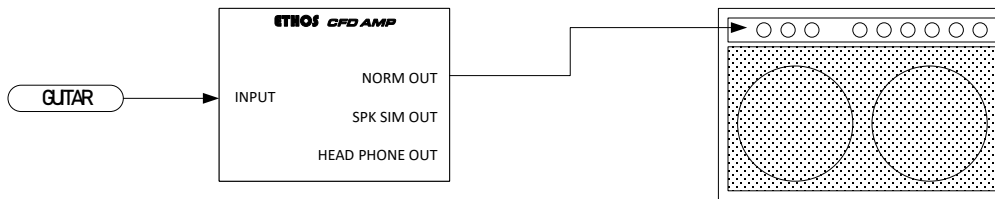

Guitar >> ECFDA >> Guitar Amp

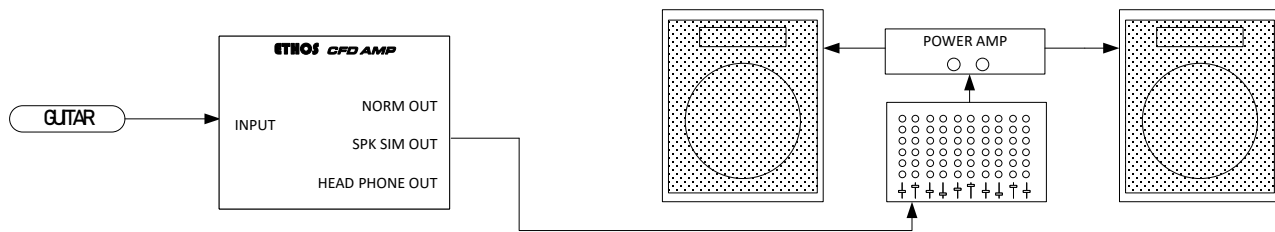

Guitar >> ECFDA >> PA (FOH)

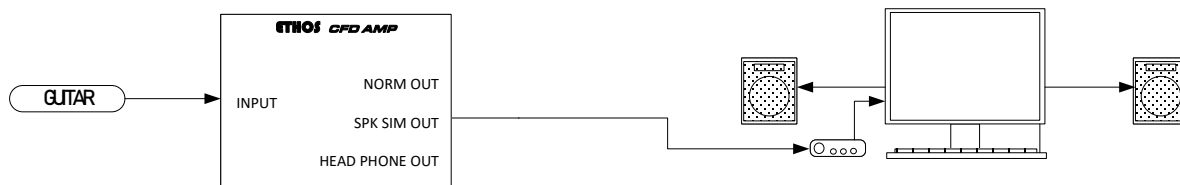

Guitar >> ECFD >> DAW Recording

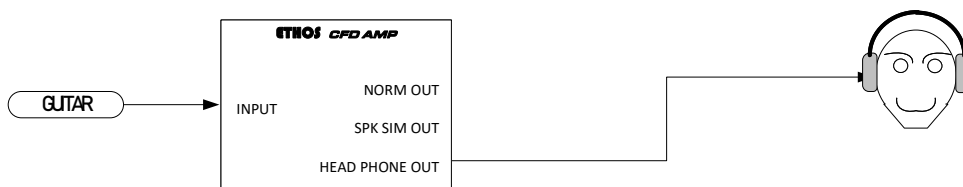

Guitar >> ECFDA >> Headphones

SPECIFICATIONS SUBJECT TO CHANGE WITHOUT NOTICE

ETHOS CFD AMP

TONE TIPS

1. Tuning the Ethos CFD Amp to Your Set-Up using the MASTER Switches

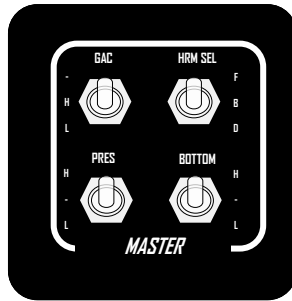

1.1 Guitar Amp Compensation (GAC) Switch (Used when plugging into a guitar amp)

The guitar amp compensation (GAC) switch is a 3 mode switch that is used to make you set-up more flat band to emulate a power amp. Most guitar amps tone stack have a notch frequency response. The GAC circuit fills that notch to obtain a flatter response. The GAC circuit has 3 modes, Up = OFF, Center = HI Fill, Down = Low Fill. If your guitar amp has a large notch you would set the GAC switch to center. If it has a subtle notch you would set it to Down.

1.2 BOTTOM Switch

Bottom Switch selects 3 modes of post channel low frequency boost, Up = Hi boost, Center = OFF, Down = Low Boost. If you want a low end boost this circuit provides it. If you want a Tight Low End (TLE) Response to your tone, you can select one of the bottom boost settings and turn down the BASS controls of the channel.

1.3 PRES Switch

The Presence switch selects 3 modes of post channel high frequency boost, Up = Hi boost, Center = OFF, Down = Hi-Cut. If you have a bright amp, set the switch DOWN, if you have a dark amp, you can set the switch UP. If your amp top end is OK, set to CENTER. Using the Channel HI-CUT controls in conjunction with the Presence switch allows you to dial in the top end of the Ethos CFD Amp to your needs.

1.4 HRM SEL Switch

The HRM Sel switch assigns the HRM EQ to one or both channels when the HRM footswitch is selected. When set to the CENTER position, the HRM EQ can be heard via both the F and D Channels. When set to the F position, the HRM EQ can only be heard when the F Channel is selected. When set to the D position, the HRM EQ can only be heard when the D Channel is selected.

ETHOS CFD AMP

TONE TIPS (Cont.)

2. HRM EQ

2.1 OVERVIEW

The HRM EQ is voiced to sound similar to a Marshall® Tone Stack. The HRM EQ is located post Channels. The HRM EQ circuit includes a Boost control that provides 0 to +15db boost.

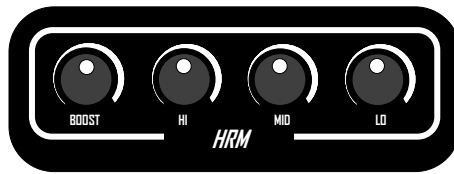

2.2 FLAT

The HRM EQ HI-MID-LO settings below provide a flat frequency response. This setting is useful when used in conjunction with the Boost control if you are looking for a flat band volume boost.

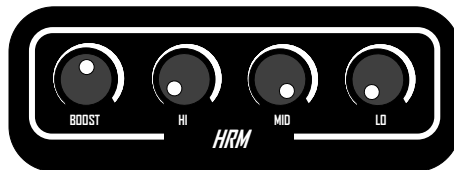

2.3 BIG CAB

The HRM EQ HI-MID-LO settings below provide a BIG CAB tone. This setting when used in conjunction with the D Channel and PAB Active creates a distinctive Rock Tone.

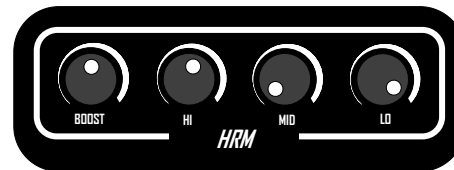

2.4 FAT JAZZ

The HRM EQ HI-MID-LO settings below provide a FAT JAZZ tone. This setting can transform the F Channel when set to a sweet tone to a nice round FAT JAZZ tone.

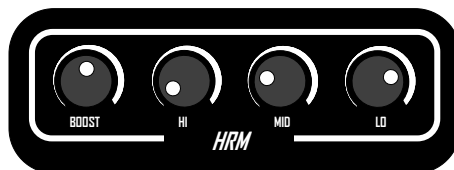

ETHOS *CFD* AMP

TONE TIPS (Cont.)

3. REVERB

3.1 OVERVIEW

The Ethos Clean CFD Amp offers a “plate-like” Reverb for both channels. The Reverb is located post drive for each channel.

3.2 INDEPENDENT LEVEL CONTROLS

The LEVEL mix for the Reverb can be adjusted independently for each channel. CCW = no reverb, CW = max reverb mix.



3.3 REVERB DELAY:

The bottom side of the unit allows access to trimming the delay(dwelling) time of the REVERB. You don't need to open the unit, just use a small flat head screw driver and you can get a short (small room) reverb CCW to longer (expansive hall-auditorium) reverb CW. The idea is set it and forget it. The delay control is set to medium delay (12:00) when shipped from the factory.



4. HI CUT :

The HICUT control is a very effective control that taper the highs as it is turned clockwise. The HICUT is located post drive in the signal chain. If you need to warm up or take the edge off your tone, simply turn up the HICUT control A dedicated HI-Cut control is provided for each channel.



ETHOS *CFD AMP*

*All product names are trademarks of their respective owners, which are in no way associated or affiliated with Custom Tones LLC. Fender® , Deluxe Reverb® are registered trademarks of Fender Musical Instruments Corporation. Marshall® is a registered trademark of Marshall Amplification Plc Product, Dumble® is a registered trademark of Dumble, Howard Alexander, and Overdrive Special® is a registered trademark of Swanson, Matthew R. Names are used solely for the purpose of identifying the specific products that were studied during Custom Tones, LLC's sound voicing development. Use of these names does not imply any cooperation or endorsement.