



Product of  
Athens Technical Specialists, Inc.

# ***X80 DL Wireless Camera*** **User's Manual**

Revision 1.0

***[www.buckeyecam.com](http://www.buckeyecam.com)***



This manual is written with the idea that the user has a general knowledge of X80 Wireless network operation. If you are not familiar with X80 Wireless networks, please read ***X80 Wireless Network User's Manual***. The manual can be downloaded from [www.buckeyecam.com](http://www.buckeyecam.com).

## **Table of Contents**

1.Warnings.....	2
2.Overview.....	3
3.Register Camera.....	4
4.Camera Control Panel.....	6
5.Camera Settings.....	8
6.Camera Installation.....	11
7.Camera Technical Specifications.....	14
8.Additional Information.....	17
9.Warranty and Service.....	18

## 1. Warnings



Contains FCC ID:MCQ-XB900HP The enclosed device complies with Part 15 of the FCC Rules. Operation is subject to the following two conditions: (i.) this device may not cause harmful interference and (ii.) this device must accept any interference received, including interference that may cause undesired operation.



If the camera is used with any antenna other than the portable antenna supplied with the X Series Camera Unit or PCBase Unit, the system may not comply with the FCC regulation Part 15.247, Operation within the license-free band 902 – 928 MHz. Contact manufacturer regarding use of optional high-gain antennas with the X80 Wireless Camera System.



To satisfy FCC RF exposure requirements for mobile transmitting devices, a separation distance of 20 cm or more should be maintained between the antenna of this device and persons during device operation. To ensure compliance, operations at closer than this distance are not recommended. The antenna used for this transmitter must not be co-located in conjunction with any other antenna or transmitter.



This product should not be used in any application where product failure may cause injury to persons, loss of life, or catastrophic property damage.

## **2. Overview**

The camera is designed to operate on an X80 wireless network.

The camera has a built-in motion detector that can be used to trigger the camera and take a picture or record a video. The camera can also be triggered from hardwired external sensors<sup>1</sup> or other X80 wireless devices operating on the same X80 network. Pictures taken by the camera are transmitted to the computer or server running the X80 Network Manager.

Just like other X80 wireless devices the camera has a repeater function, allowing it to extend the range of the network.

Power is supplied to the camera from an external battery pack. The battery pack contains a 12 Volt sealed lead-acid type battery. The camera can take thousands of pictures on a single charge. Optional solar panel chargers are available to extend battery life indefinitely. Refer to page 14 of section 7. *Camera Technical Specifications* for available power options.

The camera is housed in watertight, weatherproof aluminum enclosure.

The X80 DL Camera contains two image sensor/lens assemblies. The top lens is used to take color pictures during the day. The bottom lens is used to take black and white infrared images at night or when not enough light is available to take a color picture.

For infrared images, the scene is illuminated with an infrared flash that is invisible to the human eye.

An X80 DL camera has the following components:

1. X80 Network antenna
2. Bluetooth antenna
3. Infrared flash
4. Camera lens, day mode
5. Camera lens, night mode
6. Light sensor and walk test LED
7. PIR (Passive Infrared) motion detector
8. Battery connector

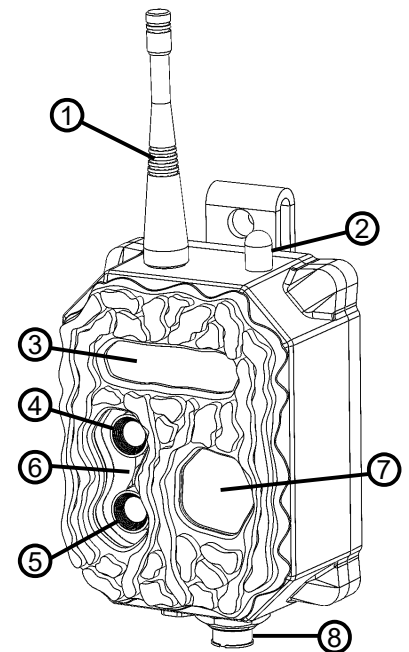

The standard color of the camera enclosure is matte black. Green and tan color options available.

X80 Remote app installed on your iOS or Android powered smartphone or tablet can be used in the field to help set up the camera. Using the app a user can check the status of the battery, check RF signal strength, change camera routing, verify motion sensor detection area by performing a walk test, and preview the picture to help aim the camera.

<sup>1</sup> Smart Battery Pack must be used to power the camera to trigger from a hardwired sensor.

### 3. Register Camera

- ! Before a camera can be used in the field, it must be registered to an X80 wireless network.
- X80 Network Manager must be running and connected to a base.

Instructions below show how to manually register a camera to the X80 Network Manager software. A camera can also be registered using remote registration. For information on how to register a device, refer to X80 Wireless Network User's Manual.

**Register Step 1**

**Connect the camera antenna.**

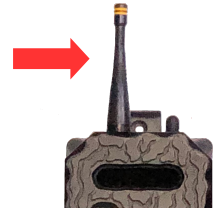

**Register Step 2**

**Apply power to the camera.** If powered from a Smart Battery pack, make sure it has 12V battery (UB1290) installed. The red wire connects to positive battery terminal (+). The black wire connects to the negative battery terminal (-). Refer to page 14 of section 7. *Camera Technical Specifications* for available power options.



**Register Step 3**

**Connect camera to the battery pack using the supplied power cable.** Connect the cable to the middle connector on the battery pack. Connect the other end of the cable to the power connector on the camera.



**Register Step 4**

**Make sure the camera is powered on and ready to be registered.** The camera status can be checked using the X80 Remote app or using the Smart Battery Pack.

- ! If the camera is already registered to another network, it must be unregistered before registering to the new network.

Check status using Smart Battery Pack

Press the **Check Status** button. If the camera is not registered, you will see the LED indicators as shown on the on the right.

Notice: The LED for “Device Registered” is not illuminated.

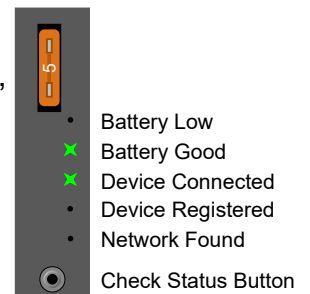

### 3.Register Camera

Check status using X80 Remote app.

Open the X80 Remote app and make sure you are in range of the camera. In the app, tap on the camera to connect to it. If the camera is not registered you should see status lines “Not registered” and “Waiting for registration...”.

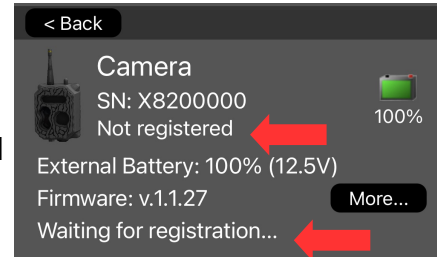

#### Register Step 5

**Register the camera using X-Series Network Manager Software.** Click **+ Add / Remove Device** located on the toolbar and click **Search** to find the unregistered camera.

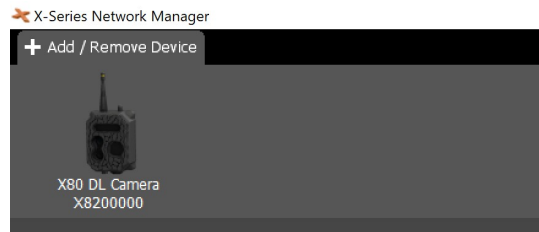

In the software, drag the unregistered camera and drop it into the network to register. If the registration is successful, the camera will be added to the network. If the camera fails to register make sure the power is still on and the antenna is connected.

When finished, click **Done** to close the registration panel.

#### Register Step 6

**Check to make sure the camera is registered.**

Check status using Smart Battery Pack

Press the **Check Status** button. If the camera is registered, you will see the LED indicators as shown on the right.

Notice: The LED for “Device Registered” is now illuminated.

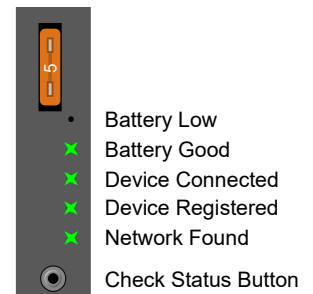

Check status using X80 Remote app.

In the app, tap on the camera to connect to it. The status should now be “Registered”.

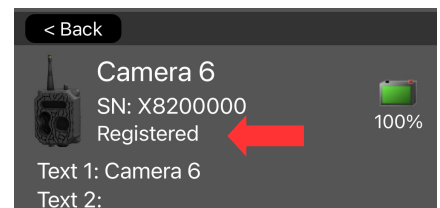

## 4. Camera Control Panel

In the X-Series Network Manager software, click on the camera icon in the network view to open the control panel.

### Picture Preview

Picture Preview section at the top shows the latest picture. The user can scroll through the pictures clicking on the left or the right side of the picture. Double click on the picture to open it in Picture Viewer. Click on  icon to open the folder where pictures from this camera are stored.

### Commands

Commands section has commands such as **Check Status** and **Settings** that are common for all X80 devices as well as camera specific commands.

**Check Status** – Software sends a request to the camera to get the latest battery level, RF signal, and picture count information.

**Manual Trigger** – Triggers a camera to take a picture or record a video based on the current camera settings.

**Discard Pictures** – Discard any pictures that the camera has buffered and ready to transmit to the base including the currently transmitting picture.

**Disable Sensor** – Disables motion sensor for a user-selected period of time. The sensor will be automatically re-enabled after the selected time elapses or the camera is restarted or power-cycled. When the sensor is disabled, the camera icon in the network will be updated to reflect the status. Click on the disabled symbol to see the cause for the disabled state.

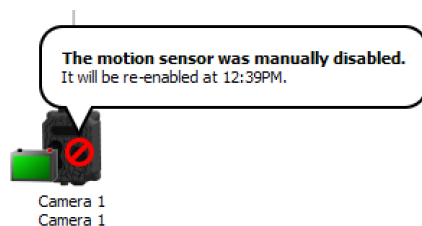

**Enable Sensor** – The command allows the user to re-enable the sensor before the time in “Disable Sensor” command elapses. This command will not re-enable the sensor if it is disabled under camera settings.

**Restart Camera** – This command reboots the camera. Any pictures or video that have not yet transmitted to the base will be discarded.

**Settings** – Open camera settings.

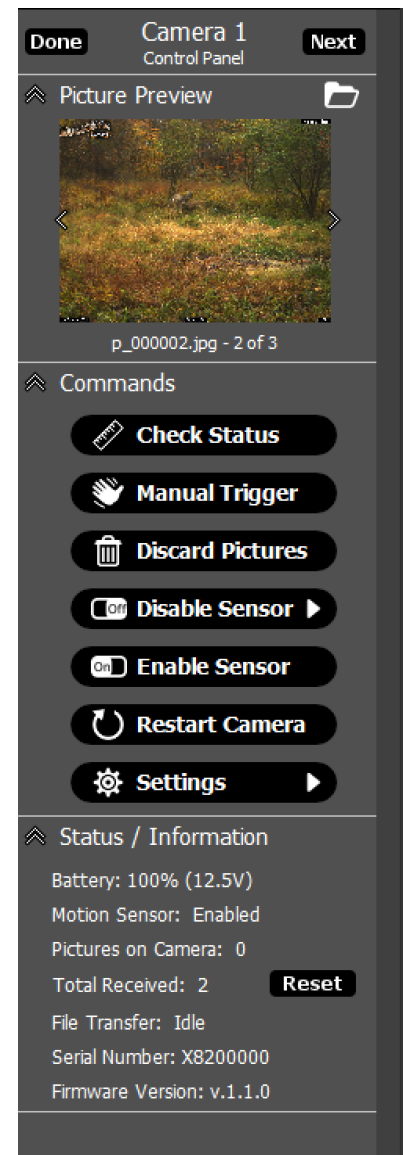

### Status / Information

Status / Information section displays device information such as serial number and firmware version, and status information such as battery level, signal strength, number of pictures received, pictures a the camera to be transmitted.

*Pictures on camera* shows the number of pictures or video files that that are currently buffered at the camera and still need to be transmitted. This number will increment every time the camera takes a picture or records a video. The number will decrement when the picture or video is received by the X80 Network Manager.

*Total Received* counter can be used to track the total number of pictures the camera took and transmitted. To reset the count to '0' click  button next to the count value.

*File Transfer* shows the status of the picture transfer. If the camera is transmitting a picture or video, the progress bar will be shown along with the current file transfer rate.



## 5. Camera Settings

To access the camera settings, click on the camera icon in the network view to open the camera *Control Panel*. Click on the **Settings** button from the camera *Control Panel*.

Note: The *X-Series Network Manager* window is re-sizable. If you do not see the **Settings** button, you may need to use the scroll bar on the right side of the window to scroll down.

### Text 1 and Text 2

User-defined text fields can be used to reference a location or give a name to the device. This text may be added to pictures by checking the box next to each field.

### Stamps on pictures

Time, Date, Moon Phase, and Temperature may be added to pictures by checking the appropriate box.

### Image format

Select the picture resolution or video format.

### Delay between motion triggers

Select the delay between motion triggers. If a camera receives a motion trigger, it will not respond to another trigger until the delay time has elapsed.

### Motion sensor

Click on the arrow to select the motion sensor sensitivity. To disable the motion sensor, set the sensitivity to Off.

### Pictures per motion trigger

Click the arrow to select the pictures per motion trigger value. When the value is set to 1, the camera will take 1 picture each time it is triggered. To take multiple pictures with each trigger, set the value greater than 1. For example, if the value is set to 3, the camera will take 3 pictures, as fast as possible, each time it is triggered.

### Blink LED when motion detected

Click the Yes/No toggle button to enable or disable a blinking LED when the camera detects motion. This is a visible red LED on the front of the camera. It is very useful for doing a “walk test” in front of the camera to verify that it is triggering correctly. (Note: If camera concealment is

important, this option should be set to No after the camera is installed in the permanent location.)

### **Enable external trigger input**

Toggle to Yes if an external trigger is connected to the Smart Battery pack powering the camera.

### **Camera schedule**

Click the Yes/No toggle button to turn the camera schedule on or off. Using the camera schedule, the camera may be disabled at certain times of the day, or can use different settings a different times of the day.

### **Trigger Cameras**

Select cameras to be triggered when this camera is triggered by the motion sensor. The selected cameras must be within direct RF communication range to receive trigger commands.

### **Trigger Remote Flashes**

If an X80 Remote Flash is registered on the network, it can be selected to be activated to increase IR illumination when infrared pictures are taken.

### **Transmit latest picture first**

Click the On/Off toggle button to turn on “transmit last picture first”. This setting controls how the camera transmits pictures when there is more than one picture waiting to be transmitted. If this button is set to Off, the pictures will be transmitted in the order they were taken. If it is set to On, they are transmitted latest picture first.

### **Use IR flash at night**

If the setting is Off, the IR flash on the camera will not be activated when taking infrared night picture. This setting only applies to on-camera flash. If an X80 Remote Flash is selected, it will be activated regardless of this setting.

### **Enhance night images**

When the option is turned on, the image is processed to improve contrast and increase depth of IR flash illumination.

### **Power down camera when battery is low**

When this option is turned on, the camera will shut down when low battery is detected. When shut down, the power consumption will be reduced to the minimum. In this state the camera will not respond to commands. If a solar panel is connected to the Smart Battery Pack, the camera will power back up when the battery voltage reaches 12.2V.

### **Define GPS coordinates**

Select Yes to embed GPS coordinates into image metadata. GPS coordinates must be entered manually.

### **Bluetooth always On**

When Yes is selected, the Bluetooth is always on and X80 Remote app can be connected to the camera at any time as long as the smartphone or tablet running the app are within connectivity range (30ft). When No is selected, the Bluetooth is turned on for 2 minute after power-up. Pressing

## 5.Camera Settings

“Status” button in Smart Battery Pack also activates Bluetooth for 2 minutes.

If Bluetooth is set to “Always On”, the user has an option to assign a four character access code. If the code is set, the user would be required to enter it when connecting to the camera using X80 Remote app.

### Automatically delete files

Click the arrow to change this setting. This can be used to have *X-Series Network Manager* automatically delete pictures from your computer after a certain period of time. If it is set to Never, *X-Series Network Manager* will never delete pictures from your computer.

### Time Lapse

Click the Add Time Lapse button to setup a time lapse schedule.

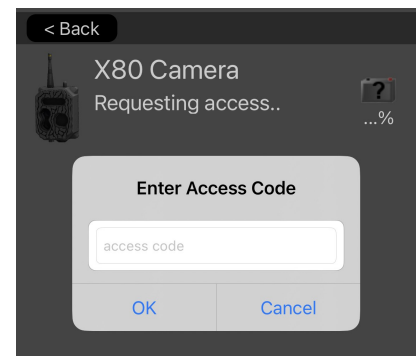

## 6. Camera Installation

### Install Step 1

#### Attach camera to a solid structure.

The supplied spring buckle strap may be used to attach the camera to a tree, vertical post, or other solid structure. Alternatively, it may be attached with a screw or nail using the hole in the top of the mounting bracket.

The best height for the camera will depend on the primary target of interest. Usually, the camera should be placed at about the height of the center of mass of the primary target of interest.

For maximum motion trigger distance, the face of the camera should be perpendicular to the ground.

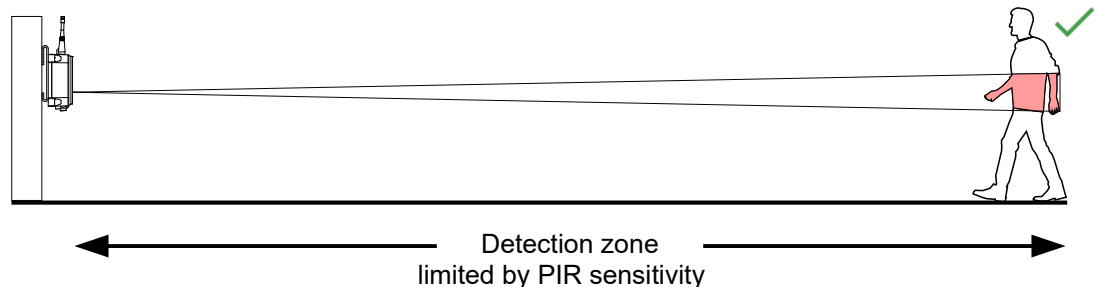

If maximum motion trigger distance is not critical, the camera may be placed at an angle.

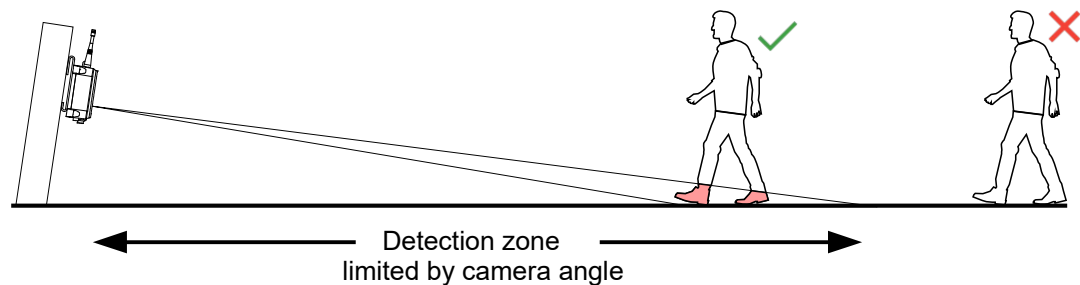

Adjustable mounts can be used to mount a camera. Those mounts allow a user to change the direction and tilt making it easy to aim the camera in the field after it is mounted. Visit [www.buckeyecam.com](http://www.buckeyecam.com) for available mounts.

### Install Step 2

#### Connect power.

Attach the Smart Battery Pack to the same solid structure as the camera using the same strap. It may also be attached with a screw or nail using the hole in the top of the bracket. Alternatively, the battery pack may be placed on the ground. This may make it easier to conceal.

Once the battery pack is in place, connect it to the camera with the supplied cable.

### Install Step 3

#### Verify connectivity to the network.

If using X80 Remote app, connect to the camera and verify connectivity of the camera to the X80 network. “Route to Base: OK” means that the camera was able to communicate with the base.

Use **Check** button to verify signal strength to the Base (if routed directly to the base) or to the next device in route (if routed through another device).

If needed, reroute the camera using **Reroute...** function in the app.

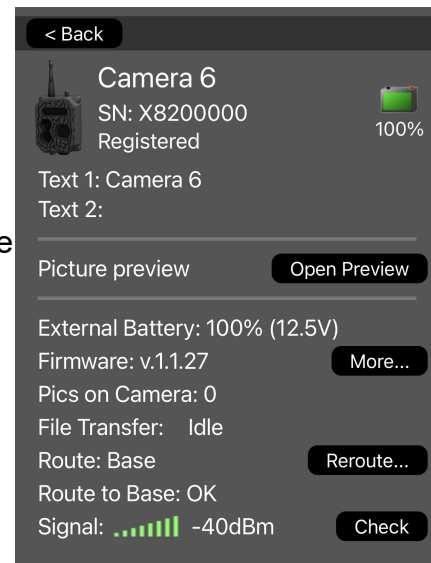

If X80 Remote app is not available, use **Check Status** button in the Smart Battery Pack to verify presence of other devices registered to the same network. “Network Found” is illuminated if the camera was able to get a response from the base or another device on the same network and can be routed to that device from the X80 Network Manager software.

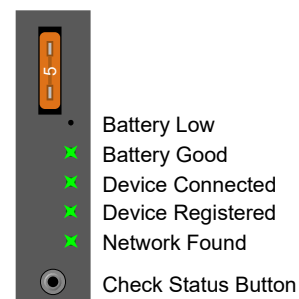

### Install Step 4

#### Do a “walk test”.



Tap **Open Preview** button in X80 Remote app to open preview mode. Walk in front of the camera to verify motion detection. A red LED on the front of the camera will blink when the motion sensor is triggered. The camera will also take a picture and transmit it to the app.

If necessary, adjust the positioning of the camera until the visible LED triggers in the desired range. Small changes in the angle can have a significant effect on the trigger

## 6.Camera Installation

distance.

You can also use Trigger button to manually trigger the camera.

Make sure to tap **< Back** button to exit the preview mode.

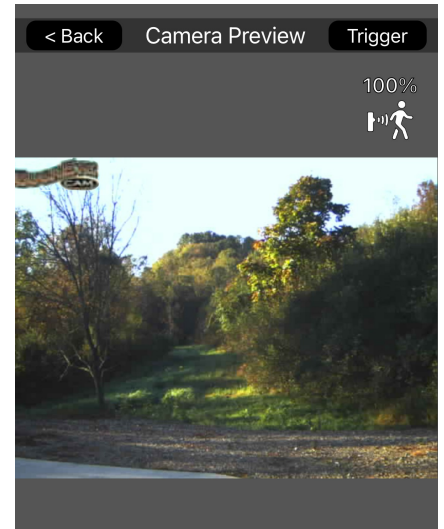

## **7. Camera Technical Specifications**

### **Acceptable Camera Power Option**

X80 DL Camera can only be powered using the following power sources:

#### **Smart Battery Pack**



- Powered with UB1290, 12V SLA battery.
- Check status of connected device
- Solar charger port, for optional solar panel
- External input<sup>(1)</sup> for optional external triggers
- “Dry contact” relay output<sup>(2)</sup> for optional relay output

<sup>1,2</sup> Available with certain devices

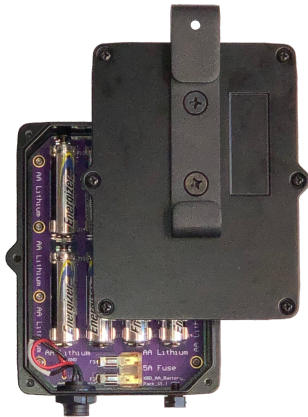

#### **AA battery Pack**

- Powered with 8 × AA Lithium batteries
- Smaller size



#### **External SLA Battery Cable**

- Powered with 12V, 75 AH, SLA battery (UBL12750)
- Longer battery life

**X80 DL Camera Dimensions**

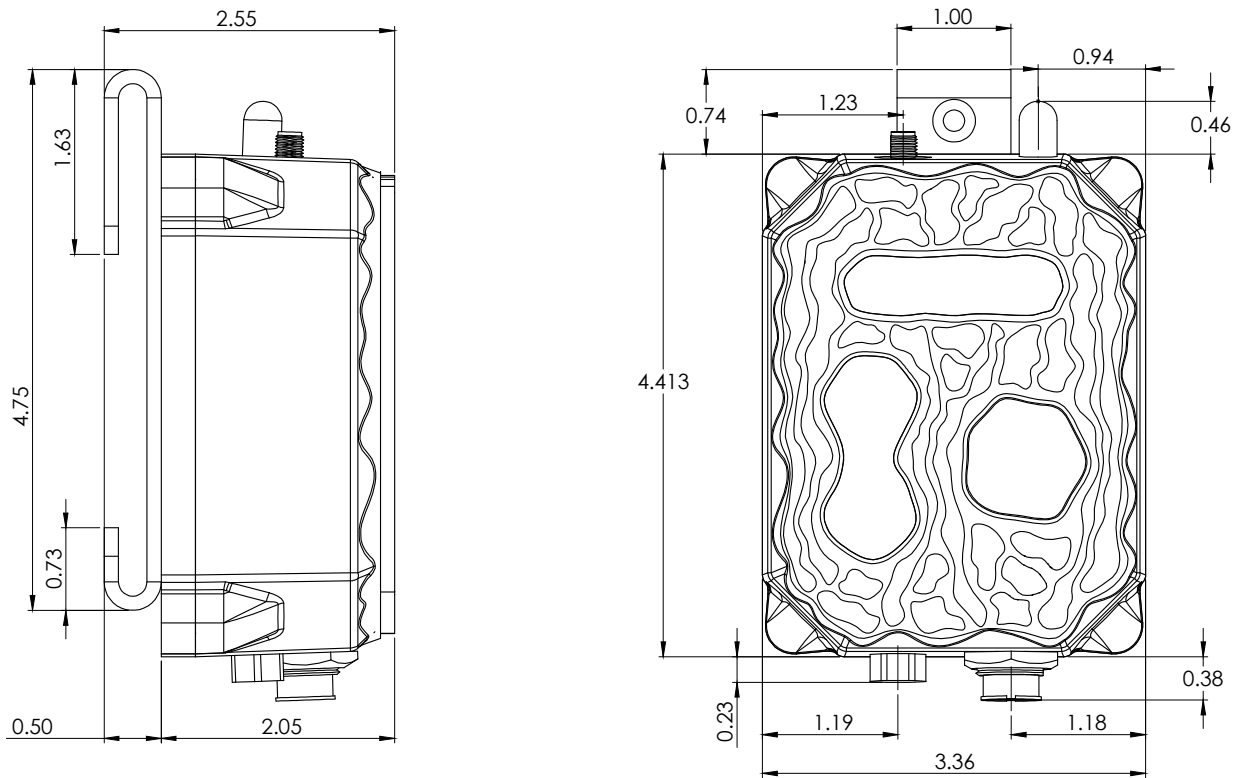

**Note:**

All linear dimensions are in inches.



**Camera Specification Table <sup>1</sup>**

Picture Format	User Selectable. 4 Megapixel (Mp), 3 Mp HD, 3Mp 1080 HD, 1 Mp, 720 HD, 0.3 Mp
Video Format	640 x 360 pixels, 20 fps 640 x 480 pixels, 20 fps 1280x720 pixels, 11 fps
Video Length	5 to 30 seconds.
Motion Detector Type	Passive Infrared (PIR)
Motion Detector Range <sup>2</sup>	User adjustable. Up to 100 feet
Motion Detector Detection Angle <sup>3</sup>	Approximately 10 degrees
Reaction Time <sup>4</sup>	0.2 Seconds
Delay Between Pictures	User selectable. 1 second to 2 hours.
Stamps on Picture	User selectable. Date, Time, Temperature, Moon Phase, and 2 custom text fields.
Additional Optional Settings <sup>5</sup>	Custom camera schedules. Time lapse photography. Pictures or video emailed or uploaded to secure LiveCam Web-site.
RF Transmission Range <sup>6</sup>	Up to 2 miles with standard antennas. Up to 30 miles with high-gain antennas and/or repeaters
Transmission Speed <sup>6</sup>	Up to 9 kilo bytes per second (Approx. 6 sec for 0.3Mp picture)
Maximum allowable antenna gain	15.1 dBi (including cable losses)
Operating Temperature	-40 to 140 F
Battery Type	12V SLA UB1270 sold separately
Supply Current (Typical, at 12.5V) <sup>7</sup>	1 mA when in low power sleep mode (i.e. no activity) 67 mA when transmitting 40 mA during 20 second idle state after transmission 2 A when IR flash is on
Solar Panel	Optional solar panels sold separately
Communication Frequency Band	902 to 928 MHz, software selectable channel mask for interference immunity
Transmitter Output Power	Up to 250 mW
Spread Spectrum	FHSS
Regulatory Approvals	
FCC (USA)	MCQ-XB900HP
IC (Canada)	1846A-XB900HP
C-Tick (Australia)	Yes
Anatel (Brazil)	Pending

<sup>1</sup> Specifications are subject to change and may not be available in all firmware or software versions.

<sup>2</sup> Motion detector range may be affected by camera mounting angle and ambient temperature.

<sup>3</sup> Approximately the center of camera field of view.

<sup>4</sup> Time from the moment motion is detected until the picture (or video) is captured.

<sup>5</sup> An optional LiveCam account requires a paid subscription.

<sup>6</sup> Transmission range and speed will depend on the type of antennas that are used and the surrounding terrain.

<sup>7</sup> Average supply current will vary depending on the number of images taken, signal strength, IR usage, etc..

## **8. Additional Information**

### **Video Tutorials**

X80 Network Manager video tutorials are available at [www.buckeyecam.com](http://www.buckeyecam.com).

### **LiveCam**

Images that are received by X80 Network Manager may be automatically uploaded to an optional LiveCam account. Images that are uploaded to LiveCam may be viewed from any computer that has an Internet connection by logging into your LiveCam account. The account may be public or private. The LiveCam service requires a yearly subscription fee.

To setup a LiveCam account, visit [www.buckeyecam.com](http://www.buckeyecam.com)

### **Other X80 Wireless Devices**

The Buckeye Cam X80 device family also includes auxiliary sensors, repeaters, actuators, and remote IR flash. All of the available devices work seamlessly together and may be controlled and monitored with the *X-Series Network Manager* software application.

Visit [www.buckeyecam.com](http://www.buckeyecam.com) for the latest product information.

## **9. Warranty and Service**

For service or repair, contact ATSI/Buckeye Cam at:

ATSI

8157 US Hwy 50 • Athens, OH 45701

(866) 325-8172 • (740) 592-2874

Fax (740) 594-2875

[www.buckeyecam.com](http://www.buckeyecam.com)

Athens Technical Specialists, Inc. (ATSI) warrants Products (BuckEye Cam™ ) sold by it and guarantees to correct, by repair or replacement at our option, any defects of material and workmanship which develop under normal and proper use within six (6) months from the date of the original purchase when inspection proves the fault to be of manufacturing. Circuit board components only receive a twelve (12) month warranty. All such Products must be returned to our service center, transportation charges prepaid. This warranty does not apply to any of our Products which have been repaired or altered by unauthorized persons or service centers in any way so as, in our judgment, to injure their stability or reliability, or which have been subject to misuse, negligence, or accident or which have had their serial number altered, effaced or removed.

We will not assume any expense or liability for repairs made by other parties without our written consent. ATSI is not responsible for damage to any associated equipment or apparatus, nor shall we be held liable for loss of profit or other special damages. There is no other guarantee or warranty except as herein stated. The Buyer, his employees, or others assumes all risks and liabilities for the operation, the use and the misuse of the product described herein and agree to defend and to save the seller harmless from any and all claims arising from any cause whatsoever, including seller's negligence for personal injury incurred in connection with the use of the said product.

ATSI reserves the right to discontinue models at any time or change specifications, price or design without notice and without incurring any obligation. The express warranties are in lieu of all other warranties, guarantees, promises, affirmations, or representations, express or implied which would be deemed applicable to the goods sold hereunder. No express warranties and no implied warranties, whether of merchantability, fitness for any particular use or purpose, against infringement, or otherwise (except as to title) other than those expressly set forth herein, shall apply.