



Price list

2024

Add 10% to Pricelist

Table of Contents

| | |
|---|---------|
| Conditions of Sales | 4 |
| Modern Industrial Table Series | 5 |
| Modern Industrial Top Specifications | 6 - 7 |
| Modern Industrial Pricing | 8 - 11 |
| Rockefeller | 12 |
| Rockefeller Top Specifications | 13 - 14 |
| Rockefeller Pricing | 15 - 16 |
| Element Table Series | 17 |
| Element Top Specifications | 18 - 19 |
| Element Pricing | 20 - 23 |
| CM10 Conference Table | 24 |
| CM10 Top Specifications | 25-26 |
| CM10 Pricing | 27 - 30 |
| Modern Industrial Credenza | 31 |
| Modern Industrial Credenza Specifications | 32 - 33 |

Table of Contents

| | |
|--------------------------------------|---------|
| Modern Industrial Credenza Pricing | 34 |
| Great Lakes Collection | 35 |
| Great Lakes Collection Specification | 36 |
| Great Lakes Collection Pricing | 37 |
| Cornerstone Furniture Finishes | 38 - 41 |
| Cornerstone Furniture Power & Data | 42 - 44 |

Conditions of Sale

✓ ■ Ordering

All orders received by Cornerstone Furniture, Inc. are subject to approval by our credit department. Orders are accepted by U.S. Mail, fax and email. Duplicate orders received and not properly marked are the responsibility of the customer.

✓ ■ Acknowledgments

All orders will be acknowledged in writing. Orders will be manufactured and invoiced based upon the information on the acknowledgment. Acknowledgments must be signed, dated and faxed back to Cornerstone Furniture showing approval and acceptance. The acknowledgment supersedes all other documents or agreements whether written or oral. Please be sure to contact Cornerstone immediately of any discrepancy. All pieces are made to order. When your order is received, it is placed in our schedule and a tentative date is given based on this placement. A delay in your acceptance and return of the acknowledgment may mean a loss of your placement in the schedule. In this case, when the approved acknowledgment is received, a new tentative completion date will be given.

✓ ■ Delivery

A tentative delivery schedule will be established when acknowledging orders, based on customer's request and by our estimated ability to deliver. Cornerstone's goal is to ship your order as quickly as possible to give you the best customer service available. Delivery times may vary. We attempt to maintain a 6-8 week delivery schedule. All acknowledgments will have an approximate shipping date. Cornerstone is not bound on any order to pay penalties, or special shipping charges or other expenses incurred by failure to deliver on schedule. We will make every effort possible to meet the customer's requirements and keep the customer informed of any changes.

✓ ■ Freight Charges

Cornerstone will specify carrier unless otherwise specified on the order. All freight is prepaid F.O.B. shipping point. All products are accepted by carrier and signed for in good condition. At this point the product becomes the property of the purchaser who is responsible for loss or damage during shipment. Cornerstone strives to reduce shipping costs as much as possible by selecting carriers that give the best service for the least cost. Product will be shipped freight collect and billed by carrier to the customer, unless otherwise specified by purchaser.

✓ ■ Freight Claims

Legal title to merchandise passes to the buyer upon acceptance by the carrier. All shipments should be carefully inspected by the consignee before acceptance. Do not refuse damaged merchandise but take acceptance on the delivery receipt and request immediate inspection by the carrier. Upon inspecting the merchandise received, make notes of any damage to cartons and skids. Any shortages should also be reported. If concealed damage is discovered after unpacking, the carrier must be notified within 15 days from receipt. Do not destroy packing materials until shipment has been inspected. After inspection proceed to file a claim with carrier.

✓ ■ Returns

No merchandise will be accepted by Cornerstone for exchange or credit without expressed, written consent before return shipment is made.

✓ ■ Cancellations

Cancellations will not be permitted without written consent from Cornerstone. A cancellation charge may be added.

✓ ■ Warranty

Cornerstone Furniture, Inc. products are guaranteed against material defect and/or faulty workmanship for a period of ten (10) years from the date of shipment from plant. Accessory items such as electrical components, decorative trim, casters, and mechanical devices not manufactured by Cornerstone carry their individual manufacturer's warranty. Warranty is extended only to products properly installed and maintained given normal and proper ware. After a valid warranty claim has been received, Cornerstone Furniture will either replace or repair the defective product at its discretion.

✓ ■ Terms

Terms are subject to approval by Cornerstone Credit Department. All prices are F.O.B. factory.□

Modern Industrial
Table Series



Top Specifications:

Veneers: Architectural grade veneers. Standards (Walnut, Oak, Maple) Standard veneer layup:

(Walnut - Flat cut (plain sliced) book match), (Oak - Flat cut (plain sliced) book match),

(Maple - Flat cut (plain sliced) Slip match)

Rustic Reclaimed Veneer - Walnut and Oak - Flat cut (plain sliced) Random match

Rustic Reclaimed Core: 1 1/2" thick particle board or Mdf

Core: All tops are fabricated with 1 1/8" thick Industrial grade particleboard 45lb. density or

Mdf (Medium Density Fiberboard)

All tops over 120" are two sections. Veneer grain on multiple section tops is running short grain. (Exception) Rustic Reclaimed Veneer grain runs length wise is random matched unless other wise specified. Laminate woodgrain on multiple section tops is running length wise and is not matched up with grain on other section.

Laminate tops: are fabricated with 1 1/8" thick 45 lb. density particle board core. Laminates are standard colors from **Wilsonart and Formica.**

Laminates:

Standards:

1572-60 Antique White
1573-60 Frosty White
1595-60 Black
D315-60 Platinum Grey
D354-60 Designer White

D90-60 North Sea
D91-60 Slate Grey
D92-60 Dove Grey
D96-60 Shadow
4841-60 Desert Zephyr

Woodgrains:

7909-60 Fusion Maple
7937-38 River Cherry
7946-38 Brazilwood
7997-38 Ebony Recon
7054-60 Wild Cherry

7999k-12 Field Elm
8201k-12 Grey Elm

For all other patterns and laminates, contact factory for pricing and availability

Custom request (Size, Top, Color, etc.) Contact :

Cornerstone Furniture, www.cornerstonefurniture.com , ph. (269)795-3379

Edges: 3mm (3/16" thick solid hardwood) Flat eased or Reverse bevel.

Live Edges: 1 1/2" thick solid hardwoods, Core: 1 1/2" thick particle board or Mdf

Standard Wood Veneer Finishes:

Walnut: Natural Walnut, Light Walnut, Brown Walnut, Grey Walnut

Oak: Natural Oak, Brown Oak, Grey Oak

Maple: Clear Maple, Fusion Maple

Wood is a natural material, slight variations will occur in color, grain configuration, and stain acceptance. Finished pieces may vary slightly in tone or character from the samples given, and no guarantee can be made of an exact match.

Semi-filled finish is standard. Clear Coating : Satin 40 degree sheen , Flat 10 degree sheen

Custom Finish matching is available for a **10% upcharge per order** (\$900.00 minimum list.)

Bases: Industrial grade raw steel, 1" x 3" tube Finishes: Raw steel, Black, Gloss White, Silver Metallic. Levelers: 2 per base

Sample Order:

| (Edge) | Model #. | Shape | Dimensions | Top | Edge | Finish | List \$ |
|---|------------|---------------|------------|--|-------------------|----------------------|---------|
| (RRVLE) | MIVRT48120 | - Rectangular | 48 x 120 | - | White Oak veneer, | # RRVLE , - Grey Oak | \$11059 |
| (RRVLE) Rustic Reclaimed veneer Live edge | | | | MIVRE48120 - Rockefeller table Rectangle, 48" x 120" | | | |

Modern Industrial Specs



Shown in:

Dimensions: 120"l x 48"w x 29"h

Top: Walnut Veneer 1.25" thick

Edge: Flat eased

Bases: Raw industrial metal with black finish

Finish: Walnut Natural #WNT

Custom sizes, woods and finishes are available.
Contact Cornerstone Furniture to discuss options.
Thank you.

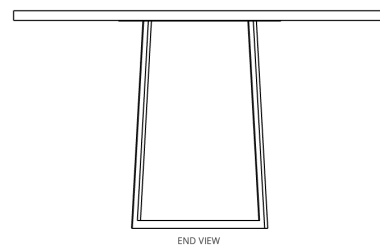
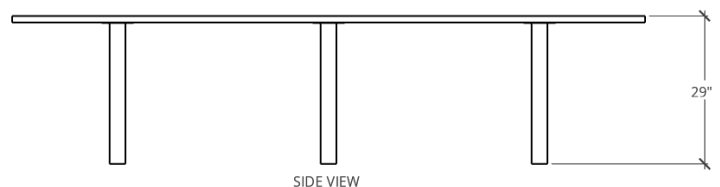
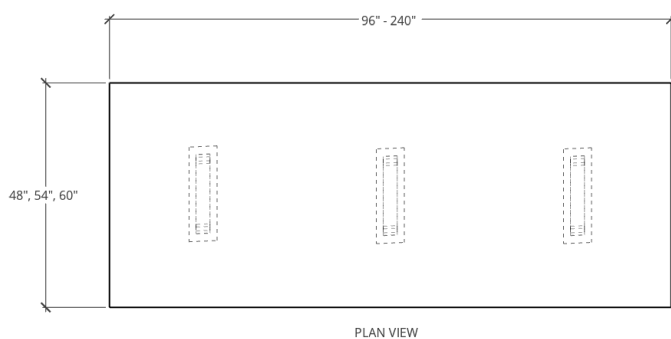

Specifications

Dimensions: 72" - 240" length x 48", 54" and 60" width x 29", 36" and 42" height.
Lengths over 120" are two piece tops.

Tops: Veneer, Designer Veneer, Laminate. Plain sliced, book or slipped matched, balance backer.

Edges: Flat eased, Knife edge, Live Edge

Bases: Raw Industrial metal

Finishes: Check out our finishes in the Price List or contact us for more information.

Power & Data: (Interlink) Silver & Black, 2 outlets standard per unit, data plate is standard and sold separately. (data jacks, e.g. USB, VGA, HDMI, Rj45, Rj11, mini Stereo) Please Contact Cornerstone Furniture for specific A/V needs.

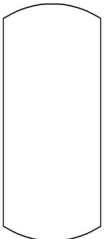

Modern Industrial Conference Tables

| Dimensions width x depth | Bases | Top Sections | Model # | Standard Veneer | Standard Veneer | Rustic Reclaimed | Rustic Reclaimed | Rustic Reclaimed | | |
|---|--|--------------|---------|---------------------------|----------------------------|-----------------------------------|------------------------------------|----------------------------------|-------|---|
| | | | | Top Flat Edge SV3FE | Top Knife Edge SV3KE | Veneer Top Flat Edge RRV3FE | Veneer Top Knife Edge RRV3KE | Veneer Top Live Edge RRVLE | | |
| | | | | List Price \$ | List Price \$ | List Price \$ | List Price \$ | List Price \$ | | |
|  <p>Rectangle (RE)</p> | 48 x 72 | 2 | 1 | MIRE4872 | 4522 | 4710 | 5890 | 6320 | 8957 | |
| | 48 x 96 | 2 | 1 | MIRE4896 | 5931 | 6327 | 6590 | 7365 | 10237 | |
| | 48 x 120 | 3 | 2 | MIRE48120 | 8753 | 9147 | 9113 | 9713 | 12718 | |
| | 48 x 144 | 3 | 2 | MIRE48144 | 9589 | 10035 | 10079 | 10765 | 14221 | |
| | 48 x 168 | 3 | 2 | MIRE48168 | 10418 | 10923 | 11576 | 11820 | 15928 | |
| | 48 x 192 | 3 | 2 | MIRE48192 | 11251 | 11811 | 12501 | 13771 | 17551 | |
| | 48 x 216 | 4 | 2 | MIRE48216 | 13630 | 13630 | 15144 | 15219 | 21083 | |
| | 48 x 240 | 4 | 2 | MIRE48240 | 14387 | 14387 | 15985 | 17173 | 22714 | |
| | 60 x 96 | 2 | 1 | MIRE6096 | 6730 | 7060 | 7447 | 7845 | 11592 | |
| | 60 x 120 | 3 | 2 | MIRE60120 | 9365 | 9786 | 10405 | 10874 | 14545 | |
| | 60 x 144 | 3 | 2 | MIRE60144 | 10377 | 10854 | 11530 | 12060 | 16545 | |
| | 60 x 168 | 3 | 2 | MIRE60168 | 11389 | 11921 | 12654 | 13246 | 18495 | |
| | 60 x 192 | 3 | 2 | MIRE60192 | 12401 | 12988 | 13779 | 14431 | 20494 | |
| | 60 x 216 | 4 | 2 | MIRE60216 | 15411 | 15997 | 17123 | 17772 | 24394 | |
| | 60 x 240 | 4 | 2 | MIRE60240 | 16331 | 16967 | 18146 | 18853 | 26392 | |
| |  <p>Arced End Rectangle (AR)</p> | 48 x 72 | 2 | 1 | MIAR4872 | 4851 | 4965 | 6210 | 6540 | x |
| | | 48 x 96 | 2 | 1 | MIAR4896 | 6652 | 5471 | 6860 | 7365 | x |
| | | 48 x 120 | 3 | 2 | MIAR48120 | 9812 | 7451 | 9113 | 9713 | x |
| 48 x 144 | | 3 | 2 | MIAR48144 | 10788 | 8243 | 10079 | 10765 | x | |
| 48 x 168 | | 3 | 2 | MIAR48168 | 11763 | 9400 | 11050 | 11820 | x | |
| 48 x 192 | | 3 | 2 | MIAR48192 | 12739 | 11162 | 12917 | 13771 | x | |
| 48 x 216 | | 4 | 2 | MIAR48216 | 15227 | 12477 | 14279 | 15219 | x | |
| 48 x 240 | | 4 | 2 | MIAR48240 | 16411 | 14254 | 16147 | 17173 | x | |
| 60 x 96 | | 2 | 1 | MIAR6096 | 7571 | 7959 | 8413 | 8843 | x | |
| 60 x 120 | | 3 | 2 | MIAR60120 | 10589 | 11083 | 11766 | 12314 | x | |
| 60 x 144 | | 3 | 2 | MIAR60144 | 11775 | 12333 | 13083 | 13704 | x | |
| 60 x 168 | | 3 | 2 | MIAR60168 | 12961 | 13584 | 14401 | 15093 | x | |
| 60 x 192 | | 3 | 2 | MIAR60192 | 14146 | 14835 | 15718 | 16483 | x | |
| 60 x 216 | | 4 | 2 | MIAR60216 | 17272 | 17959 | 19191 | 19954 | x | |
| 60 x 240 | | 4 | 2 | MIAR60240 | 18350 | 19096 | 203890 | 21217 | x | |

Modern Industrial Conference Tables

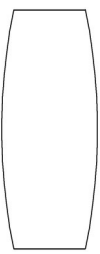
| Dimensions width x depth | Bases | Top Sections | Model # | Standard Veneer | Standard Veneer | Rustic Reclaimed | Rustic Reclaimed | Rustic Reclaimed | |
|--|--|--------------|---------|---------------------------|----------------------------|-----------------------------------|------------------------------------|----------------------------------|------|
| | | | | Top Flat Edge SV3FE | Top Knife Edge SV3KE | Veneer Top Flat Edge RRV3FE | Veneer Top Knife Edge RRV3KE | Veneer Top Live Edge RRVLE | |
| | | | | List Price \$ | List Price \$ | List Price \$ | List Price \$ | List Price \$ | |
|  Racetrack (RT) | 48 x 72 | 2 | 1 | MIRT4872 | 4851 | 4965 | 6210 | 6540 | x |
| | 48 x 96 | 2 | 1 | MIRT4896 | 6652 | 5471 | 6860 | 7365 | x |
| | 48 x 120 | 3 | 2 | MIRT48120 | 9812 | 7451 | 9113 | 9713 | x |
| | 48 x 144 | 3 | 2 | MIRT48144 | 10788 | 8243 | 10079 | 10765 | x |
| | 48 x 168 | 3 | 2 | MIRT48168 | 11763 | 9400 | 11050 | 11820 | x |
| | 48 x 192 | 3 | 2 | MIRT48192 | 12739 | 11162 | 12917 | 13771 | x |
| | 48 x 216 | 4 | 2 | MIRT48216 | 15227 | 12477 | 14279 | 15219 | x |
| | 48 x 240 | 4 | 2 | MIRT48240 | 16411 | 14254 | 16147 | 17173 | x |
| | 60 x 96 | 2 | 1 | MIRT6096 | 7571 | 7959 | 8413 | 8843 | x |
| | 60 x 120 | 3 | 2 | MIRT60120 | 10589 | 11083 | 11766 | 12314 | x |
| | 60 x 144 | 3 | 2 | MIRT60144 | 11775 | 12333 | 13083 | 13704 | x |
| | 60 x 168 | 3 | 2 | MIRT60168 | 12961 | 13584 | 14401 | 15093 | x |
| | 60 x 192 | 3 | 2 | MIRT60192 | 14146 | 14835 | 15718 | 16483 | x |
| | 60 x 216 | 4 | 2 | MIRT60216 | 17272 | 17959 | 19191 | 19954 | x |
| | 60 x 240 | 4 | 2 | MIRT60240 | 18350 | 19096 | 203890 | 21217 | x |
| |  Boat (BT) | 48 x 72 | 2 | 1 | MIBT4872 | 4851 | 4965 | 6210 | 6540 |
| 48 x 96 | | 2 | 1 | MIBT4896 | 6652 | 5471 | 6860 | 7365 | x |
| 48 x 120 | | 3 | 2 | MIBT48120 | 9812 | 7451 | 9113 | 9713 | x |
| 48 x 144 | | 3 | 2 | MIBT48144 | 10788 | 8243 | 10079 | 10765 | x |
| 48 x 168 | | 3 | 2 | MIBT48168 | 11763 | 9400 | 11050 | 11820 | x |
| 48 x 192 | | 3 | 2 | MIBT48192 | 12739 | 11162 | 12917 | 13771 | x |
| 48 x 216 | | 4 | 2 | MIBT48216 | 15227 | 12477 | 14279 | 15219 | x |
| 48 x 240 | | 4 | 2 | MIBT48240 | 16411 | 14254 | 16147 | 17173 | x |
| 60 x 96 | | 2 | 1 | MIBT6096 | 7571 | 7959 | 8413 | 8843 | x |
| 60 x 120 | | 3 | 2 | MIBT60120 | 10589 | 11083 | 11766 | 12314 | x |
| 60 x 144 | | 3 | 2 | MIBT60144 | 11775 | 12333 | 13083 | 13704 | x |
| 60 x 168 | | 3 | 2 | MIBT60168 | 12961 | 13584 | 14401 | 15093 | x |
| 60 x 192 | | 3 | 2 | MIBT60192 | 14146 | 14835 | 15718 | 16483 | x |
| 60 x 216 | | 4 | 2 | MIBT60216 | 17272 | 17959 | 19191 | 19954 | x |
| 60 x 240 | | 4 | 2 | MIBT60240 | 18350 | 19096 | 203890 | 21217 | x |

Modern Industrial Conference Tables

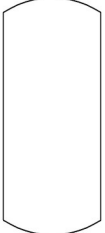
| | Dimensions width x depth | Bases | Top Sections | Model # | Standard Laminate | Standard Laminate | |
|--|---|----------|--------------|-----------|--|---|------|
| | | | | | Top Flat Edge SV3FE List Price \$ | Top Knife Edge SV3KE List Price \$ | |
|  Rectangle (RE) | 48 x 72 | 2 | 1 | MIRE4872 | 3548 | 5325 | |
| | 48 x 96 | 2 | 1 | MIRE4896 | 3649 | 5726 | |
| | 48 x 120 | 3 | 2 | MIRE48120 | 5018 | 8296 | |
| | 48 x 144 | 3 | 2 | MIRE48144 | 5879 | 9279 | |
| | 48 x 168 | 3 | 2 | MIRE48168 | 6662 | 10233 | |
| | 48 x 192 | 4 | 2 | MIRE48192 | 7249 | 11115 | |
| | 48 x 216 | 4 | 2 | MIRE48216 | 9490 | 13524 | |
| | 48 x 240 | 5 | 2 | MIRE48240 | 10664 | 14562 | |
| | 60 x 96 | 2 | 1 | MIRE6096 | 4047 | 6494 | |
| | 60 x 120 | 3 | 2 | MIRE60120 | 4971 | 8812 | |
| | 60 x 144 | 3 | 2 | MIRE60144 | 5558 | 9827 | |
| | 60 x 168 | 3 | 2 | MIRE60168 | 6341 | 10914 | |
| | 60 x 192 | 4 | 2 | MIRE60192 | 7123 | 12002 | |
| | 60 x 216 | 4 | 2 | MIRE60216 | 10128 | 15073 | |
| | 60 x 240 | 5 | 2 | MIRE60240 | 10911 | 16087 | |
| |  Arced End Rectangle (AR) | 48 x 72 | 2 | 1 | MIAR4872 | 4001 | 5785 |
| | | 48 x 96 | 2 | 1 | MIAR4896 | 4375 | 6216 |
| | | 48 x 120 | 3 | 2 | MIAR48120 | 5758 | 8966 |
| 48 x 144 | | 3 | 2 | MIAR48144 | 6203 | 9820 | |
| 48 x 168 | | 3 | 2 | MIAR48168 | 6797 | 10700 | |
| 48 x 192 | | 4 | 2 | MIAR48192 | 7688 | 11630 | |
| 48 x 216 | | 4 | 2 | MIAR48216 | 9936 | 14003 | |
| 48 x 240 | | 5 | 2 | MIAR48240 | 10530 | 14812 | |
| 60 x 96 | | 2 | 1 | MIAR6096 | 5091 | 7076 | |
| 60 x 120 | | 3 | 2 | MIAR60120 | 6179 | 9633 | |
| 60 x 144 | | 3 | 2 | MIAR60144 | 6773 | 10668 | |
| 60 x 168 | | 3 | 2 | MIAR60168 | 7367 | 11703 | |
| 60 x 192 | | 4 | 2 | MIAR60192 | 7960 | 12739 | |
| 60 x 216 | | 4 | 2 | MIAR60216 | 10777 | 15706 | |
| 60 x 240 | | 5 | 2 | MIAR60240 | 11370 | 16657 | |

Modern Industrial Conference Tables

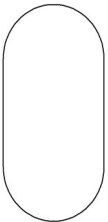
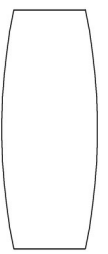
| | Dimensions width x depth | Bases | Top Sections | Model # | Standard Laminate | Standard Laminate |
|--|-----------------------------|-------|--------------|-----------|--|---|
| | | | | | Top Flat Edge SV3FE List Price \$ | Top Knife Edge SV3KE List Price \$ |
|  Racetrack (RT) | 48 x 72 | 2 | 1 | MIRT4872 | 4001 | 5785 |
| | 48 x 96 | 2 | 1 | MIRT4896 | 4375 | 6216 |
| | 48 x 120 | 3 | 2 | MIRT48120 | 5758 | 8966 |
| | 48 x 144 | 3 | 2 | MIRT48144 | 6203 | 9820 |
| | 48 x 168 | 3 | 2 | MIRT48168 | 6797 | 10700 |
| | 48 x 192 | 4 | 2 | MIRT48192 | 7688 | 11630 |
| | 48 x 216 | 4 | 2 | MIRT48216 | 9936 | 10627 |
| | 48 x 240 | 5 | 2 | MIRT48240 | 10530 | 11023 |
| | 60 x 96 | 2 | 1 | MIRT6096 | 5091 | 7076 |
| | 60 x 120 | 3 | 2 | MIRT60120 | 6179 | 9633 |
| | 60 x 144 | 3 | 2 | MIRT60144 | 6773 | 10668 |
| | 60 x 168 | 3 | 2 | MIRT60168 | 7367 | 11703 |
| | 60 x 192 | 4 | 2 | MIRT60192 | 7960 | 12739 |
| | 60 x 216 | 4 | 2 | MIRT60216 | 10777 | 15706 |
| | 60 x 240 | 5 | 2 | MIRT60240 | 11370 | 16657 |
|  Boat (BT) | 48 x 72 | 2 | 1 | MIBT4872 | 4001 | 5785 |
| | 48 x 96 | 2 | 1 | MIBT4896 | 4375 | 6216 |
| | 48 x 120 | 3 | 2 | MIBT48120 | 5758 | 8966 |
| | 48 x 144 | 3 | 2 | MIBT48144 | 6203 | 9820 |
| | 48 x 168 | 3 | 2 | MIBT48168 | 6797 | 10700 |
| | 48 x 192 | 4 | 2 | MIBT48192 | 7688 | 11630 |
| | 48 x 216 | 4 | 2 | MIBT48216 | 9936 | 10627 |
| | 48 x 240 | 5 | 2 | MIBT48240 | 10530 | 11023 |
| | 60 x 96 | 2 | 1 | MIBT6096 | 5091 | 7076 |
| | 60 x 120 | 3 | 2 | MIBT60120 | 6179 | 9633 |
| | 60 x 144 | 3 | 2 | MIBT60144 | 6773 | 10668 |
| | 60 x 168 | 3 | 2 | MIBT60168 | 7367 | 11703 |
| | 60 x 192 | 4 | 2 | MIBT60192 | 7960 | 12739 |
| | 60 x 216 | 4 | 2 | MIBT60216 | 10777 | 15706 |
| | 60 x 240 | 5 | 2 | MIBT60240 | 11370 | 16657 |

Rockefeller



Top Specifications:

Veneers: Architectural grade veneers. Standards (Walnut, Oak, Maple) Standard veneer layup:
(Walnut - Flat cut (plain sliced) book match), (Oak - Flat cut (plain sliced) book match),
(Maple - Flat cut (plain sliced) Slip match)

Rustic Reclaimed Veneer - Walnut and Oak - Flat cut (plain sliced) Random match

Rustic Reclaimed Core: 1 1/2" thick particle board or Mdf

Core: All tops are fabricated with 1 1/8" thick Industrial grade particleboard 45lb. density or Mdf (Medium Density Fiberboard)

All tops over 120" are two sections. Veneer grain on multiple section tops is running short grain. (Exception) Rustic Reclaimed Veneer grain runs length wise is random matched unless other wise specified. Laminate woodgrain on multiple section tops is running length wise and is not matched up with grain on other section.

Laminate tops: are fabricated with 1 1/8" thick 45 lb. density particle board core. Laminates are standard colors from **Wilsonart and Formica.**

Laminates:

Standards:

1572-60 Antique White
1573-60 Frosty White
1595-60 Black
D315-60 Platinum Grey
D354-60 Designer White

D90-60 North Sea
D91-60 Slate Grey
D92-60 Dove Grey
D96-60 Shadow
4841-60 Desert Zephyr

Woodgrains:

7909-60 Fusion Maple
7937-38 River Cherry
7946-38 Brazilwood
7997-38 Ebony Recon
7054-60 Wild Cherry

7999k-12 Field Elm
8201k-12 Grey Elm

For all other patterns and laminates, contact factory for pricing and availability

Custom request (Size, Top, Color, etc.) Contact :

Cornerstone Furniture, www.cornerstonefurniture.com , ph. (269)795-3379

Edges: 3mm (3/16" thick solid hardwood) Flat eased or Reverse bevel.

Live Edges: 1 1/2" thick solid hardwoods, Core: 1 1/2" thick particle board or Mdf

Standard Wood Veneer Finishes:

Walnut: Natural Walnut, Light Walnut, Brown Walnut, Grey Walnut

Oak: Natural Oak, Brown Oak, Grey Oak

Maple: Clear Maple, Fusion Maple

Wood is a natural material, slight variations will occur in color, grain configuration, and stain acceptance. Finished pieces may vary slightly in tone or character from the samples given, and no guarantee can be made of an exact match.

Semi-filled finish is standard. Clear Coating : Satin 40 degree sheen , Flat 10 degree sheen

Custom Finish matching is available for a 10% upcharge per order (\$500.00 minimum list.)

Bases: Industrial grade raw steel I beams 6" x 5" H frame. Finishes: Raw steel or Black. Levelers: 2 per base

Sample Order:

| (Edge) | Model # , | Shape , | Dimensions , | Top , | Edge , | Finish , | List \$ |
|---------|-----------------------------------|---------------|--------------|-------|---|-------------|--------------------|
| (RRVLE) | ETRT48120 | - Rectangular | 48 x 120 | - | White Oak veneer, | # RRVLE , - | Grey Oak - \$11059 |
| (RRVLE) | Rustic Reclaimed veneer Live edge | | | | RFRE48120 - Rockefeller table Rectangle, 48" x 120" | | |

Rockefeller Specs



Shown in:

Dimensions: 120"l x 48"w x 29"h

Top: Rustic Walnut Veneer 1.75" thick

Edge: Flat eased

Bases: Raw Industrial Grade Steel I beams

Finish: Walnut Light #WLT

Power & Data: (Interlink) Black

Custom sizes, woods and finishes are available.
Contact Cornerstone Furniture to discuss options.
Thank you.

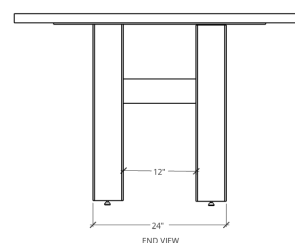
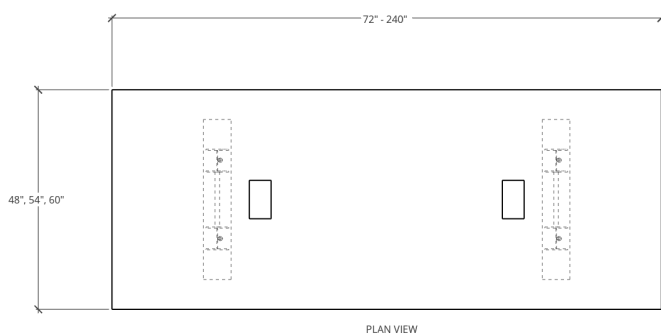

Specifications

Dimensions: 72" - 240" length x 48", 54" and 60" width x 29", 36" and 42" height.
Lengths over 120" are two piece tops.

Tops: Veneer, Designer Veneer, Laminate. Plain sliced, book or slipped matched, balance backer.

Edges: Flat eased, Knife edge, Live Edge

Bases: Raw Industrial Grade Steel I Beams, Blackened Steel is available.

Finishes: Check out our finishes in the Price List or contact us for more information.

Power & Data: (Interlink) Silver & Black, 2 outlets standard per unit, data plate is standard and sold separately. (data jacks, e.g. USB, VGA, HDMI, Rj45, Rj11, mini Stereo) Please Contact Cornerstone Furniture for specific A/V needs.



Rockefeller

| Dimensions width x depth | Bases | Top Sections | Model # | Standard Veneer | Standard Veneer | Rustic Reclaimed | Rustic Reclaimed | Rustic Reclaimed |
|-----------------------------|-------|--------------|-----------|---------------------------|----------------------------|-----------------------------------|------------------------------------|----------------------------------|
| | | | | Top Flat Edge SV3FE | Top Knife Edge SV3KE | Veneer Top Flat Edge RRV3FE | Veneer Top Knife Edge RRV3KE | Veneer Top Live Edge RRVLE |
| | | | | List Price \$ | List Price \$ | List Price \$ | List Price \$ | List Price \$ |
| 48 x 72 | 2 | 1 | RFRE4872 | 6123 | 6307 | 7490 | 7920 | 9857 |
| 48 x 96 | 2 | 1 | RFRE4896 | 7080 | 7385 | 7866 | 8206 | 11337 |
| 48 x 120 | 3 | 2 | RFRE48120 | 10466 | 10860 | 11629 | 12067 | 14384 |
| 48 x 144 | 3 | 2 | RFRE48144 | 11308 | 11757 | 12565 | 13064 | 15949 |
| 48 x 168 | 3 | 2 | RFRE48168 | 12150 | 12654 | 13500 | 14061 | 17513 |
| 48 x 192 | 4 | 2 | RFRE48192 | 12992 | 13552 | 14436 | 15057 | 20560 |
| 48 x 216 | 4 | 2 | RFRE48216 | 15947 | 16508 | 17719 | 18342 | 23603 |
| 48 x 240 | 5 | 2 | RFRE48240 | 16712 | 17324 | 18569 | 19249 | 25171 |
| 60 x 96 | 2 | 1 | RFRE6096 | 7886 | 8217 | 8762 | 9130 | 12744 |
| 60 x 120 | 3 | 2 | RFRE60120 | 11657 | 12078 | 12952 | 13420 | 16142 |
| 60 x 144 | 3 | 2 | RFRE60144 | 12680 | 13157 | 14089 | 14619 | 18054 |
| 60 x 168 | 3 | 2 | RFRE60168 | 13703 | 14235 | 15226 | 15817 | 19957 |
| 60 x 192 | 4 | 2 | RFRE60192 | 14727 | 15314 | 16363 | 170163 | 23373 |
| 60 x 216 | 4 | 2 | RFRE60216 | 17745 | 18331 | 19717 | 20368 | 26771 |
| 60 x 240 | 5 | 2 | RFRE60240 | 18676 | 19315 | 20751 | 21458 | 28688 |



Rectangle
(RE)

Rockefeller

| Dimensions width x depth | Bases | Top Sections | Model # | Standard Laminate | Standard Laminate |
|-----------------------------|-------|--------------|-----------|--|---|
| | | | | Top Flat Edge SV3FE List Price \$ | Top Knife Edge SV3KE List Price \$ |
| 48 x 72 | 2 | 1 | RFRE4872 | 4560 | 6557 |
| 48 x 96 | 2 | 1 | RFRE4896 | 4760 | 6837 |
| 48 x 120 | 3 | 2 | RFRE48120 | 6672 | 9950 |
| 48 x 144 | 3 | 2 | RFRE48144 | 7533 | 10993 |
| 48 x 168 | 3 | 2 | RFRE48168 | 8316 | 11887 |
| 48 x 192 | 4 | 2 | RFRE48192 | 8903 | 12796 |
| 48 x 216 | 4 | 2 | RFRE48216 | 11712 | 15746 |
| 48 x 240 | 5 | 2 | RFRE48240 | 12886 | 16784 |
| 60 x 96 | 2 | 1 | RFRE6096 | 5158 | 7605 |
| 60 x 120 | 3 | 2 | RFRE60120 | 7193 | 11035 |
| 60 x 144 | 3 | 2 | RFRE60144 | 7780 | 12050 |
| 60 x 168 | 3 | 2 | RFRE60168 | 8563 | 13137 |
| 60 x 192 | 4 | 2 | RFRE60192 | 9346 | 14224 |
| 60 x 216 | 4 | 2 | RFRE60216 | 12351 | 17295 |
| 60 x 240 | 5 | 2 | RFRE60240 | 13133 | 18310 |



Rectangle
(RE)

Element Table Series



Top Specifications:

Veneers: Architectural grade veneers. Standards (Walnut, Oak, Maple) Standard veneer layup:
(Walnut - Flat cut (plain sliced) book match), (Oak - Flat cut (plain sliced) book match),
(Maple - Flat cut (plain sliced) Slip match)

Rustic Reclaimed Veneer - Walnut and Oak - Flat cut (plain sliced) Random match

Rustic Reclaimed Core: 1 1/2" thick particle board or Mdf

Core: All tops are fabricated with 1 1/8" thick Industrial grade particleboard 45lb. density or Mdf (Medium Density Fiberboard)

All tops over 120" are two sections. Veneer grain on multiple section tops is running short grain. (Exception) Rustic Reclaimed Veneer grain runs length wise is random matched unless other wise specified. Laminate woodgrain on multiple section tops is running length wise and is not matched up with grain on other section.

Laminate tops: are fabricated with 1 1/8" thick 45 lb. density particle board core. Laminates are standard colors from **Wilsonart and Formica.**

Laminates:

Standards:

1572-60 Antique White
1573-60 Frosty White
1595-60 Black
D315-60 Platinum Grey
D354-60 Designer White

D90-60 North Sea
D91-60 Slate Grey
D92-60 Dove Grey
D96-60 Shadow
4841-60 Desert Zephyr

Woodgrains:

7909-60 Fusion Maple
7937-38 River Cherry
7946-38 Brazilwood
7997-38 Ebony Recon
7054-60 Wild Cherry

7999k-12 Field Elm
8201k-12 Grey Elm

For all other patterns and laminates, contact factory for pricing and availability

Custom request (Size, Top, Color, etc.) Contact :

Cornerstone Furniture, www.cornerstonefurniture.com , ph. (269)795-3379

Edges: 3mm (3/16" thick solid hardwood) Flat eased or Reverse bevel.

Live Edges: 1 1/2" thick solid hardwoods, Core: 1 1/2" thick particle board or Mdf

Standard Wood Veneer Finishes:

Walnut: Natural Walnut, Light Walnut, Brown Walnut, Grey Walnut

White Oak: Natural Oak, Brown Oak, Grey Oak

Maple: Clear Maple, Fusion Maple

Wood is a natural material, slight variations will occur in color, grain configuration, and stain acceptance. Finished pieces may vary slightly in tone or character from the samples given, and no guarantee can be made of an exact match.

Semi-filled finish is standard. Clear Coating : Satin 40 degree sheen , Flat 10 degree sheen

Custom Finish matching is available for a 10% upcharge per order (\$500.00 minimum list.)

Bases: Rectangular open center with access door and wire management rails. Finishes: To match tops.

Sample Order:

| (Edge) | Model #. | Shape | Dimensions | Top | Edge | Finish | List \$ |
|---------|-------------------------------|---------------|---|-----|-------------------|----------------------|---------|
| (SV3FE) | ETRE48120 | - Rectangular | 48 x 120 | - | White Oak veneer, | # SV3FE , - Grey Oak | \$11059 |
| (SV3FE) | Standard veneer 3mm Flat edge | | ETRT48120 - Element table Rectangle, 48" x 120" | | | | |

Element Specs



Shown in:

Dimensions: 120"l x 48"w x 29"h

Top: Walnut veneer 1.25" thick

Edge: Knife Edge

Bases: Hollow core panels with access doors and wire management rails (depending on size of top)

Finish: Walnut Grey #WGT

Power & Data: (Interlink) Silver

Custom sizes, woods and finishes are available.
Contact Cornerstone Furniture to discuss options.

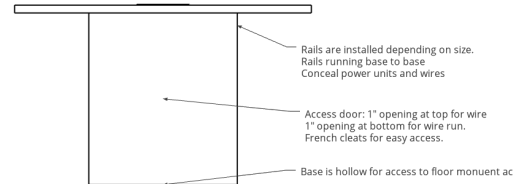
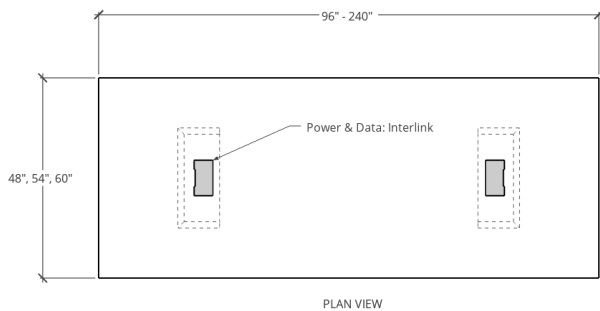

Specifications

Dimensions: 72" - 240" length x 48", 54" and 60" width x 29", 36" and 42" height. Lengths over 120" are two piece tops.

Tops: Veneer, Designer Veneer, Laminate. Plain sliced, book or slipped matched, balance backer. 1.25 thick top

Edges: Flat eased, Knife edge, Live Edge



Bases: A/V hollow core panels with access doors and wire management rails. Ample capacity with access to floor core electrical and telecommunications.

Finishes: Check out our finishes in the Price List or contact us for more information.



Power & Data: (Interlink) Silver & Black, 2 outlets standard per unit, data plate is standard and sold separately. (data jacks, e.g. USB, VGA, HDMI, Rj45, Rj11, mini Stereo) Please Contact Cornerstone Furniture for specific A/V needs.





Element Table Series

| Dimensions width x depth | Bases | Top Sections | Model # | Standard Veneer | Standard Veneer | Rustic Reclaimed | Rustic Reclaimed | Rustic Reclaimed | | |
|---|---|--------------|---------|---------------------------|----------------------------|-----------------------------------|------------------------------------|----------------------------------|-------|---|
| | | | | Top Flat Edge SV3FE | Top Knife Edge SV3KE | Veneer Top Flat Edge RRV3FE | Veneer Top Knife Edge RRV3KE | Veneer Top Live Edge RRVLE | | |
| | | | | List Price \$ | List Price \$ | List Price \$ | List Price \$ | List Price \$ | | |
|  <p>Rectangle (RE)</p> | 48 x 72 | 2 | 1 | ETRE4872 | 7500 | 7685 | 8860 | 9293 | 11234 | |
| | 48 x 96 | 2 | 1 | ETRE4896 | 7475 | 7780 | 8305 | 8645 | 13375 | |
| | 48 x 120 | 3 | 2 | ETRE48120 | 11059 | 11453 | 12288 | 12725 | 17961 | |
| | 48 x 144 | 3 | 2 | ETRE48144 | 11901 | 12350 | 13233 | 13722 | 20125 | |
| | 48 x 168 | 3 | 2 | ETRE48168 | 12743 | 13247 | 14159 | 14719 | 22294 | |
| | 48 x 192 | 4 | 2 | ETRE48192 | 13585 | 14144 | 19217 | 20081 | 24448 | |
| | 48 x 216 | 4 | 2 | ETRE48216 | 17428 | 17990 | 19365 | 19988 | 29198 | |
| | 48 x 240 | 4 | 2 | ETRE48240 | 18189 | 18805 | 20215 | 20895 | 31369 | |
| | 60 x 96 | 2 | 1 | ETRE6096 | 8553 | 8884 | 9503 | 9871 | 15637 | |
| | 60 x 120 | 3 | 2 | ETRE60120 | 12595 | 13016 | 13994 | 14463 | 20973 | |
| | 60 x 144 | 3 | 2 | ETRE60144 | 13618 | 14095 | 15131 | 15661 | 23436 | |
| | 60 x 168 | 3 | 2 | ETRE60168 | 14642 | 15174 | 16268 | 16860 | 25894 | |
| | 60 x 192 | 4 | 2 | ETRE60192 | 15665 | 16252 | 17406 | 18058 | 28345 | |
| | 60 x 216 | 4 | 2 | ETRE60216 | 19720 | 20307 | 21912 | 22563 | 33845 | |
| | 60 x 240 | 4 | 2 | ETRE60240 | 20651 | 21287 | 22945 | 23653 | 36313 | |
| |  <p>Boat (BT)</p> | 48 x 72 | 2 | 1 | ETBT4872 | 7500 | 7685 | 8860 | 9513 | x |
| | | 48 x 96 | 2 | 1 | ETBT4896 | 8203 | 8562 | 9115 | 9513 | x |
| | | 48 x 120 | 3 | 2 | ETBT48120 | 121360 | 12591 | 13477 | 13990 | x |
| 48 x 144 | | 3 | 2 | ETBT48144 | 13116 | 13642 | 14575 | 15158 | x | |
| 48 x 168 | | 3 | 2 | ETBT48168 | 14103 | 14694 | 15670 | 16326 | x | |
| 48 x 192 | | 4 | 2 | ETBT48192 | 14496 | 15152 | 16107 | 16836 | x | |
| 48 x 216 | | 4 | 2 | ETBT48216 | 19004 | 19701 | 21160 | 21890 | x | |
| 48 x 240 | | 4 | 2 | ETBT48240 | 19941 | 20657 | 22156 | 22952 | x | |
| 60 x 96 | | 2 | 1 | ETBT6096 | 9404 | 9792 | 10449 | 10880 | x | |
| 60 x 120 | | 3 | 2 | ETBT60120 | 12894 | 13388 | 14327 | 14876 | x | |
| 60 x 144 | | 3 | 2 | ETBT60144 | 14094 | 14652 | 15659 | 16280 | x | |
| 60 x 168 | | 3 | 2 | ETBT60168 | 15293 | 15916 | 16992 | 17684 | x | |
| 60 x 192 | | 4 | 2 | ETBT60192 | 16492 | 17180 | 18324 | 19089 | x | |
| 60 x 216 | | 4 | 2 | ETBT60216 | 21602 | 22289 | 24002 | 24766 | x | |
| 60 x 240 | | 4 | 2 | ETBT60240 | 22692 | 23438 | 25214 | 26042 | x | |

Element Table Series

| | Dimensions width x depth | Bases | Top Sections | Model # | Standard Veneer | Standard Veneer | Rustic Reclaimed | Rustic Reclaimed | Rusti Reclaimed |
|--|---|---------|--------------|-----------|---------------------------|----------------------------|-----------------------------------|------------------------------------|----------------------------------|
| | | | | | Top Flat Edge SV3FE | Top Knife Edge SV3KE | Veneer Top Flat Edge RRV3FE | Veneer Top Knife Edge RRV3KE | Veneer Top Live Edge RRVLE |
| | | | | | List Price \$ | List Price \$ | List Price \$ | List Price \$ | List Price \$ |
|  Racetrack (RT) | 48 x 72 | 2 | 1 | ETRT4872 | 7500 | 7685 | 8860 | 9513 | x |
| | 48 x 96 | 2 | 1 | ETRT4896 | 8203 | 8562 | 9115 | 9513 | x |
| | 48 x 120 | 3 | 2 | ETRT48120 | 121360 | 12591 | 13477 | 13990 | x |
| | 48 x 144 | 3 | 2 | ETRT48144 | 13116 | 13642 | 14575 | 15158 | x |
| | 48 x 168 | 3 | 2 | ETRT48168 | 14103 | 14694 | 15670 | 16326 | x |
| | 48 x 192 | 4 | 2 | ETRT48192 | 14496 | 15152 | 16107 | 16836 | x |
| | 48 x 216 | 4 | 2 | ETRT48216 | 19004 | 19701 | 21160 | 21890 | x |
| | 48 x 240 | 4 | 2 | ETRT48240 | 19941 | 20657 | 22156 | 22952 | x |
| | 60 x 96 | 2 | 1 | ETRT6096 | 9404 | 9792 | 10449 | 10880 | x |
| | 60 x 120 | 3 | 2 | ETRT60120 | 12894 | 13388 | 14327 | 14876 | x |
| | 60 x 144 | 3 | 2 | ETRT60144 | 14094 | 14652 | 15659 | 16280 | x |
| | 60 x 168 | 3 | 2 | ETRT60168 | 15293 | 15916 | 16992 | 17684 | x |
| | 60 x 192 | 4 | 2 | ETRT60192 | 16492 | 17180 | 18324 | 19089 | x |
| | 60 x 216 | 4 | 2 | ETRT60216 | 21602 | 22289 | 24002 | 24766 | x |
| | 60 x 240 | 4 | 2 | ETRT60240 | 22692 | 23438 | 25214 | 26042 | x |
| |  Arced End Rectangle (AR) | 48 x 72 | 2 | 1 | ETAR4872 | 7500 | 7685 | 8860 | 9513 |
| 48 x 96 | | 2 | 1 | ETAR4896 | 8203 | 8562 | 9115 | 9513 | x |
| 48 x 120 | | 3 | 2 | ETAR48120 | 121360 | 12591 | 13477 | 13990 | x |
| 48 x 144 | | 3 | 2 | ETAR48144 | 13116 | 13642 | 14575 | 15158 | x |
| 48 x 168 | | 3 | 2 | ETAR48168 | 14103 | 14694 | 15670 | 16326 | x |
| 48 x 192 | | 4 | 2 | ETAR48192 | 14496 | 15152 | 16107 | 16836 | x |
| 48 x 216 | | 4 | 2 | ETAR48216 | 19004 | 19701 | 21160 | 21890 | x |
| 48 x 240 | | 4 | 2 | ETAR48240 | 19941 | 20657 | 22156 | 22952 | x |
| 60 x 96 | | 2 | 1 | ETAR6096 | 9404 | 9792 | 10449 | 10880 | x |
| 60 x 120 | | 3 | 2 | ETAR60120 | 12894 | 13388 | 14327 | 14876 | x |
| 60 x 144 | | 3 | 2 | ETAR60144 | 14094 | 14652 | 15659 | 16280 | x |
| 60 x 168 | | 3 | 2 | ETAR60168 | 15293 | 15916 | 16992 | 17684 | x |
| 60 x 192 | | 4 | 2 | ETAR60192 | 16492 | 17180 | 18324 | 19089 | x |
| 60 x 216 | | 4 | 2 | ETAR60216 | 21602 | 22289 | 24002 | 24766 | x |
| 60 x 240 | | 4 | 2 | ETAR60240 | 22692 | 23438 | 25214 | 26042 | x |

Element Table Series

| | Dimensions width x depth | Bases | Top Sections | Model # | Standard Laminate | Standard Laminate | |
|---|--|----------|--------------|-----------|--|---|-------|
| | | | | | Top Flat Edge SV3FE List Price \$ | Top Knife Edge SV3KE List Price \$ | |
|  | 48 x 72 | 2 | 1 | ETRE4872 | 4890 | 6980 | |
| | 48 x 96 | 2 | 1 | ETRE4896 | 5155 | 7232 | |
| | 48 x 120 | 3 | 2 | ETRE48120 | 7265 | 10542 | |
| | 48 x 144 | 3 | 2 | ETRE48144 | 8126 | 11526 | |
| | 48 x 168 | 3 | 2 | ETRE48168 | 8909 | 12480 | |
| | 48 x 192 | 4 | 2 | ETRE48192 | 9496 | 13362 | |
| | 48 x 216 | 4 | 2 | ETRE48216 | 13194 | 17227 | |
| | 48 x 240 | 4 | 2 | ETRE48240 | 14368 | 18266 | |
| | 60 x 96 | 2 | 1 | ETRE6096 | 5824 | 8272 | |
| | 60 x 120 | 3 | 2 | ETRE60120 | 8131 | 11973 | |
| | 60 x 144 | 3 | 2 | ETRE60144 | 8719 | 12988 | |
| | 60 x 168 | 3 | 2 | ETRE60168 | 9501 | 14075 | |
| | 60 x 192 | 4 | 2 | ETRE60192 | 10284 | 15162 | |
| | 60 x 216 | 4 | 2 | ETRE60216 | 14326 | 19270 | |
| | 60 x 240 | 4 | 2 | ETRE60240 | 15109 | 20285 | |
| |  | 48 x 72 | 2 | 1 | ETAR4872 | 5354 | 7981 |
| | | 48 x 96 | 2 | 1 | ETAR4896 | 5880 | 8272 |
| | | 48 x 120 | 3 | 2 | ETAR48120 | 8005 | 11213 |
| 48 x 144 | | 3 | 2 | ETAR48144 | 8450 | 12067 | |
| 48 x 168 | | 3 | 2 | ETAR48168 | 9044 | 12947 | |
| 48 x 192 | | 4 | 2 | ETAR48192 | 9935 | 13876 | |
| 48 x 216 | | 4 | 2 | ETAR48216 | 13640 | 17707 | |
| 48 x 240 | | 4 | 2 | ETAR48240 | 14233 | 18515 | |
| 60 x 96 | | 2 | 1 | ETAR6096 | 6474 | 8459 | |
| 60 x 120 | | 3 | 2 | ETAR60120 | 9340 | 12793 | |
| 60 x 144 | | 3 | 2 | ETAR60144 | 9933 | 13829 | |
| 60 x 168 | | 3 | 2 | ETAR60168 | 10527 | 14864 | |
| 60 x 192 | | 4 | 2 | ETAR60192 | 11121 | 15899 | |
| 60 x 216 | | 4 | 2 | ETAR60216 | 14974 | 19904 | |
| 60 x 240 | | 4 | 2 | ETAR60240 | 15568 | 20854 | |

Element Table Series

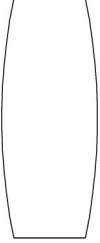
| | Dimensions width x depth | Bases | Top Sections | Model # | Standard Laminate | Standard Laminate |
|--|--|---------|--------------|-----------|--|---|
| | | | | | Top Flat Edge SV3FE List Price \$ | Top Knife Edge SV3KE List Price \$ |
|  Racetrack (RT) | 48 x 72 | 2 | 1 | ETRT4872 | 5354 | 7981 |
| | 48 x 96 | 2 | 1 | ETRT4896 | 5880 | 8272 |
| | 48 x 120 | 3 | 2 | ETRT48120 | 8005 | 11213 |
| | 48 x 144 | 3 | 2 | ETRT48144 | 8450 | 12067 |
| | 48 x 168 | 3 | 2 | ETRT48168 | 9044 | 12947 |
| | 48 x 192 | 4 | 2 | ETRT48192 | 9935 | 13876 |
| | 48 x 216 | 4 | 2 | ETRT48216 | 13640 | 17707 |
| | 48 x 240 | 4 | 2 | ETRT48240 | 14233 | 18515 |
| | 60 x 96 | 2 | 1 | ETRT6096 | 6474 | 8459 |
| | 60 x 120 | 3 | 2 | ETRT60120 | 9340 | 12793 |
| | 60 x 144 | 3 | 2 | ETRT60144 | 9933 | 13829 |
| | 60 x 168 | 3 | 2 | ETRT60168 | 10527 | 14864 |
| | 60 x 192 | 4 | 2 | ETRT60192 | 11121 | 15899 |
| | 60 x 216 | 4 | 2 | ETRT60216 | 14974 | 19904 |
| | 60 x 240 | 4 | 2 | ETRT60240 | 15568 | 20854 |
| |  Boat (BT) | 48 x 72 | 2 | 1 | ETBT4872 | 5354 |
| 48 x 96 | | 2 | 1 | ETBT4896 | 5880 | 8272 |
| 48 x 120 | | 3 | 2 | ETBT48120 | 8005 | 11213 |
| 48 x 144 | | 3 | 2 | ETBT48144 | 8450 | 12067 |
| 48 x 168 | | 3 | 2 | ETBT48168 | 9044 | 12947 |
| 48 x 192 | | 4 | 2 | ETBT48192 | 9935 | 13876 |
| 48 x 216 | | 4 | 2 | ETBT48216 | 13640 | 17707 |
| 48 x 240 | | 4 | 2 | ETBT48240 | 14233 | 18515 |
| 60 x 96 | | 2 | 1 | ETBT6096 | 6474 | 8459 |
| 60 x 120 | | 3 | 2 | ETBT60120 | 9340 | 12793 |
| 60 x 144 | | 3 | 2 | ETBT60144 | 9933 | 13829 |
| 60 x 168 | | 3 | 2 | ETBT60168 | 10527 | 14864 |
| 60 x 192 | | 4 | 2 | ETBT60192 | 11121 | 15899 |
| 60 x 216 | | 4 | 2 | ETBT60216 | 14974 | 19904 |
| 60 x 240 | | 4 | 2 | ETBT60240 | 15568 | 20854 |

CM10 Conference Table



Top Specifications:

Veneers: Architectural grade veneers. Standards (Walnut, Oak, Maple) Standard veneer layup:
(Walnut - Flat cut (plain sliced) book match), (Oak - Flat cut (plain sliced) book match),
(Maple - Flat cut (plain sliced) Slip match)

Core: All tops are fabricated with 1 1/8" thick Industrial grade particleboard 45lb. density or
Mdf (Medium Density Fiberboard)

Rustic Reclaimed Veneer - Walnut and Oak - Flat cut (plain sliced) Random match

Rustic Reclaimed Core: 1 1/2" thick particle board or Mdf

All tops over 120" are two sections. *Veneer* grain on multiple section tops is running short grain. (*Exception*) *Rustic Reclaimed Veneer* grain runs length wise is random matched unless other wise specified. *Laminate* woodgrain on multiple section tops is running length wise and is not matched up with grain on other section.

Laminate tops: are fabricated with 1 1/8" thick 45 lb. density particle board core. Laminates are standard colors from **Wilsonart and Formica.**

Laminates:

Standards:

1572-60 Antique White
1573-60 Frosty White
1595-60 Black
D315-60 Platinum Grey
D354-60 Designer White

D90-60 North Sea
D91-60 Slate Grey
D92-60 Dove Grey
D96-60 Shadow
4841-60 Desert Zephyr

Woodgrains:

7909-60 Fusion Maple
7937-38 River Cherry
7946-38 Brazilwood
7997-38 Ebony Recon
7054-60 Wild Cherry

7999k-12 Field Elm
8201k-12 Grey Elm

For all other patterns and laminates, contact factory for pricing and availability

Custom request (Size, Top, Color, etc.) Contact :

Cornerstone Furniture, www.cornerstonefurniture.com , ph. (269)795-3379

Edges: 3mm (3/16" thick solid hardwood) Flat eased or Reverse bevel.

Live Edges: 1 1/2" thick solid hardwoods, Core: 1 1/2" thick particle board or Mdf

Standard Wood Veneer Finishes:

Walnut: Clear Walnut, Natural Walnut, Warm Walnut, Dark Walnut.

Oak: Clear White Oak, Natural White Oak, Brown Oak, Pewter Oak, Charcoal Oak

Maple: Clear Maple, Fusion Maple

Wood is a natural material, slight variations will occur in color, grain configuration, and stain acceptance. Finished pieces may vary slightly in tone or character from the samples given, and no guarantee can be made of an exact match.

Semi-filled finish is standard. *Clear Coating :* *Satin* 40 degree sheen , *Flat* 10 degree sheen

Custom Finish matching is available for a **10% upcharge per order** (**\$500.00** minimum list.)

Bases: 2" tubular steel. Finishes: Powder coats: Black, Dark tone, Silver, Medium Gray, White.
Polished or Satin Chrome— add to list \$160 each base

Sample Order:

| (Edge) | Model #. | Shape. | Dimensions. | Top. | Edge. | Finish. | List \$ |
|---------|-----------|---------------|-------------|------|-------------------|--------------------------|---------|
| (SV3FE) | CMRE48120 | - Rectangular | 48 x 120 | - | White Oak veneer, | # SV3FE , - Pewter Oak - | \$5859 |

Cm10 Specs



Shown in:

Dimensions: 120"l x 48"w x 29"h

Top: Oak veneer 1.25" thick

Edge: Knife Edge

Bases: Double T Bases

Finish: Field Elm 7999-12

Power & Data: (Interlink) Silver

Custom sizes, woods and finishes are available.
Contact Cornerstone Furniture to discuss options.
Thank you.

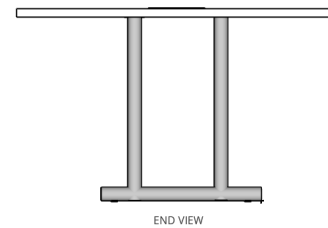
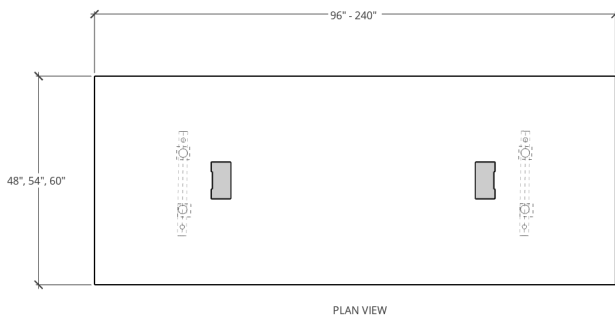

Specifications

Dimensions: 72" - 240" length x 48", 54" and 60" width x 29", 36" and 42" height. Lengths over 120" are two piece tops.

Tops: Veneer, Designer Veneer, Laminate. Plain sliced, book or slipped matched, balance backer. 1.25 thick top

Edges: Flat eased, Knife edge, Live Edge



Bases: Double T Bases

Finishes: Check out our finishes in the Price List or contact us for more information.

Power & Data: (Interlink) Silver & Black, 2 outlets standard per unit, data plate is standard and sold separately. (data jacks, e.g. USB, VGA, HDMI, Rj45, Rj11, mini Stereo) Please Contact Cornerstone Furniture for specific A/V needs.



CM10 Conference Tables

| | Dimensions width x depth | Bases | Top Sections | Model # | Standard Veneer | Standard Veneer | Rustic Reclaimed | Rustic Reclaimed | Rustic Reclaimed | |
|---|--|----------|--------------|-----------|---------------------------|----------------------------|-----------------------------------|------------------------------------|-----------------------------------|---|
| | | | | | Top Flat Edge SV3FE | Top Knife Edge SV3KE | Veneer Top Flat Edge RRV3FE | Veneer Top Knife Edge RRV3KE | Veneer Top Live Edge RRV3LE | |
| | | | | | List Price \$ | List Price \$ | List Price \$ | List Price \$ | List Price \$ | |
|  | 48 x 72 | 2 | 1 | CMRE4872 | 3670 | 3857 | 5025 | 5452 | 7405 | |
| | 48 x 96 | 2 | 1 | CMRE4896 | 4421 | 4621 | 6000 | 6502 | 8898 | |
| | 48 x 120 | 3 | 2 | CMRE48120 | 5859 | 6177 | 7824 | 8426 | 11440 | |
| | 48 x 144 | 3 | 2 | CMRE48144 | 6638 | 6971 | 8783 | 9481 | 12943 | |
| | 48 x 168 | 3 | 2 | CMRE48168 | 7775 | 8117 | 9759 | 10532 | 14450 | |
| | 48 x 192 | 4 | 2 | CMRE48192 | 9067 | 9455 | 11206 | 12063 | 16426 | |
| | 48 x 216 | 4 | 2 | CMRE48216 | 10259 | 10770 | 12562 | 13510 | 18494 | |
| | 48 x 240 | 5 | 2 | CMRE48240 | 11590 | 12120 | 14011 | 15032 | 20474 | |
| | 60 x 96 | 2 | 1 | CMRE6096 | 5210 | 5411 | 6892 | 7443 | 10236 | |
| | 60 x 120 | 3 | 2 | CMRE60120 | 6814 | 7140 | 8935 | 9574 | 13087 | |
| | 60 x 144 | 3 | 2 | CMRE60144 | 7781 | 8120 | 10118 | 10835 | 14887 | |
| | 60 x 168 | 3 | 2 | CMRE60168 | 9090 | 9441 | 11284 | 12100 | 16684 | |
| | 60 x 192 | 4 | 2 | CMRE60192 | 10598 | 10984 | 12932 | 13831 | 18957 | |
| | 60 x 216 | 4 | 2 | CMRE60216 | 11963 | 12484 | 14512 | 15500 | 21334 | |
| | 60 x 240 | 5 | 2 | CMRE60240 | 13481 | 14021 | 16170 | 17226 | 23610 | |
| |  | 48 x 72 | 2 | 1 | CMAR4872 | 3670 | 3857 | 5025 | 5452 | x |
| | | 48 x 96 | 2 | 1 | CMAR4896 | 4421 | 4621 | 6000 | 6502 | x |
| | | 48 x 120 | 3 | 2 | CMAR48120 | 5859 | 6177 | 7824 | 8426 | x |
| 48 x 144 | | 3 | 2 | CMAR48144 | 6638 | 6971 | 8783 | 9481 | x | |
| 48 x 168 | | 3 | 2 | CMAR48168 | 7775 | 8117 | 9759 | 10532 | x | |
| 48 x 192 | | 4 | 2 | CMAR48192 | 9067 | 9455 | 11206 | 12063 | x | |
| 48 x 216 | | 5 | 2 | CMAR48216 | 10259 | 10770 | 12562 | 13510 | x | |
| 48 x 240 | | 4 | 2 | CMAR48240 | 11590 | 12120 | 14011 | 15032 | x | |
| 60 x 96 | | 2 | 1 | CMAR6096 | 5210 | 5411 | 6892 | 7443 | x | |
| 60 x 120 | | 3 | 2 | CMAR60120 | 6814 | 7140 | 8935 | 9574 | x | |
| 60 x 144 | | 3 | 2 | CMAR60144 | 7781 | 8120 | 10118 | 10835 | x | |
| 60 x 168 | | 3 | 2 | CMAR60168 | 9090 | 9441 | 11284 | 12100 | x | |
| 60 x 192 | | 4 | 2 | CMAR60192 | 10598 | 10984 | 12932 | 13831 | x | |
| 60 x 216 | | 4 | 2 | CMAR60216 | 11963 | 12484 | 14512 | 15500 | x | |
| 60 x 240 | | 5 | 2 | CMAR60240 | 13481 | 14021 | 16170 | 17226 | x | |

CM10 Conference Tables

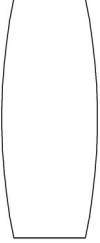
| | Dimensions width x depth | Bases | Top Sections | Model # | Standard Veneer | Standard Veneer | Rustic Reclaimed | Rustic Reclaimed | Rustic Reclaimed |
|---|--|---------|--------------|-----------|---------------------------|----------------------------|-----------------------------------|------------------------------------|-----------------------------------|
| | | | | | Top Flat Edge SV3FE | Top Knife Edge SV3KE | Veneer Top Flat Edge RRV3FE | Veneer Top Knife Edge RRV3KE | Veneer Top Live Edge RRV3LE |
| | | | | | List Price \$ | List Price \$ | List Price \$ | List Price \$ | List Price \$ |
|  | 48 x 72 | 2 | 1 | CMRT4872 | 3670 | 3857 | 5025 | 5452 | x |
| | 48 x 96 | 2 | 1 | CMRT4896 | 4421 | 4621 | 6000 | 6502 | x |
| | 48 x 120 | 3 | 2 | CMRT48120 | 5859 | 6177 | 7824 | 8426 | x |
| | 48 x 144 | 3 | 2 | CMRT48144 | 6638 | 6971 | 8783 | 9481 | x |
| | 48 x 168 | 3 | 2 | CMRT48168 | 7775 | 8117 | 9759 | 10532 | x |
| | 48 x 192 | 4 | 2 | CMRT48192 | 9067 | 9455 | 11206 | 12063 | x |
| | 48 x 216 | 5 | 2 | CMRT48216 | 10259 | 10770 | 12562 | 13510 | x |
| | 48 x 240 | 4 | 2 | CMRT48240 | 11590 | 11642 | 14011 | 15032 | x |
| | 60 x 96 | 2 | 1 | CMRT6096 | 5210 | 5411 | 6892 | 7443 | x |
| | 60 x 120 | 3 | 2 | CMRT60120 | 6814 | 7140 | 8935 | 9574 | x |
| | 60 x 144 | 3 | 2 | CMRT60144 | 7781 | 8120 | 10118 | 10835 | x |
| | 60 x 168 | 3 | 2 | CMRT60168 | 9090 | 9441 | 11284 | 12100 | x |
| | 60 x 192 | 4 | 2 | CMRT60192 | 10598 | 10984 | 12932 | 13831 | x |
| | 60 x 216 | 4 | 2 | CMRT60216 | 11963 | 12484 | 14512 | 15500 | x |
| | 60 x 240 | 5 | 2 | CMRT60240 | 13481 | 14021 | 16170 | 17226 | x |
| |  | 48 x 72 | 2 | 1 | CMBT4872 | 3670 | 3857 | 5025 | 5452 |
| 48 x 96 | | 2 | 1 | CMBT4896 | 4421 | 4621 | 6000 | 6502 | x |
| 48 x 120 | | 3 | 2 | CMBT48120 | 5859 | 6177 | 7824 | 8426 | x |
| 48 x 144 | | 3 | 2 | CMBT48144 | 6638 | 6971 | 8783 | 9481 | x |
| 48 x 168 | | 3 | 2 | CMBT48168 | 7775 | 8117 | 9759 | 10532 | x |
| 48 x 192 | | 4 | 2 | CMBT48192 | 9067 | 9455 | 11206 | 12063 | x |
| 48 x 216 | | 4 | 2 | CMBT48216 | 10259 | 10770 | 12562 | 13510 | x |
| 48 x 240 | | 5 | 2 | CMBT48240 | 11590 | 11642 | 14011 | 15032 | x |
| 60 x 96 | | 2 | 1 | CMBT6096 | 5210 | 5411 | 6892 | 7443 | x |
| 60 x 120 | | 3 | 2 | CMBT60120 | 6814 | 7140 | 8935 | 9574 | x |
| 60 x 144 | | 3 | 2 | CMBT60144 | 7781 | 8120 | 10118 | 10835 | x |
| 60 x 168 | | 3 | 2 | CMBT60168 | 9090 | 9441 | 11284 | 12100 | x |
| 60 x 192 | | 4 | 2 | CMBT60192 | 10598 | 10984 | 12932 | 13831 | x |
| 60 x 216 | | 4 | 2 | CMBT60216 | 11963 | 12484 | 14512 | 15500 | x |
| 60 x 240 | | 5 | 2 | CMBT60240 | 13481 | 14021 | 16170 | 17226 | x |

CM10 Conference Tables

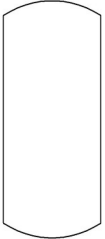
| | Dimensions width x depth | Bases | Top Sections | Model # | Standard Laminate | Standard Laminate |
|---|--|---------|--------------|-----------|--|---|
| | | | | | Top Flat Edge SV3FE List Price \$ | Top Knife Edge SV3KE List Price \$ |
|  | 48 x 72 | 2 | 1 | CMRE4872 | 1850 | 2120 |
| | 48 x 96 | 2 | 1 | CMRE4896 | 2025 | 2340 |
| | 48 x 120 | 3 | 2 | CMRE48120 | 3190 | 3830 |
| | 48 x 144 | 3 | 2 | CMRE48144 | 3360 | 4067 |
| | 48 x 168 | 3 | 2 | CMRE48168 | 3703 | 4526 |
| | 48 x 192 | 4 | 2 | CMRE48192 | 4199 | 5036 |
| | 48 x 216 | 4 | 2 | CMRE48216 | 5160 | 6322 |
| | 48 x 240 | 5 | 2 | CMRE48240 | 5890 | 6940 |
| | 60 x 96 | 2 | 1 | CMRE6096 | 2120 | 2465 |
| | 60 x 120 | 3 | 2 | CMRE60120 | 3435 | 4155 |
| | 60 x 144 | 3 | 2 | CMRE60144 | 3671 | 4472 |
| | 60 x 168 | 3 | 2 | CMRE60168 | 4107 | 5083 |
| | 60 x 192 | 4 | 2 | CMRE60192 | 4603 | 5589 |
| | 60 x 216 | 4 | 2 | CMRE60216 | 5598 | 6941 |
| | 60 x 240 | 5 | 2 | CMRE60240 | 6201 | 7584 |
| |  | 48 x 72 | 2 | 1 | CMAR4872 | 1850 |
| 48 x 96 | | 2 | 1 | CMAR4896 | 2025 | 2340 |
| 48 x 120 | | 3 | 2 | CMAR48120 | 3190 | 3830 |
| 48 x 144 | | 3 | 2 | CMAR48144 | 3360 | 4067 |
| 48 x 168 | | 3 | 2 | CMAR48168 | 3703 | 4526 |
| 48 x 192 | | 4 | 2 | CMAR48192 | 4199 | 5036 |
| 48 x 216 | | 4 | 2 | CMAR48216 | 5160 | 6322 |
| 48 x 240 | | 5 | 2 | CMAR48240 | 5890 | 6940 |
| 60 x 96 | | 2 | 1 | CMAR6096 | 2120 | 2465 |
| 60 x 120 | | 3 | 2 | CMAR60120 | 3435 | 4155 |
| 60 x 144 | | 3 | 2 | CMAR60144 | 3671 | 4472 |
| 60 x 168 | | 3 | 2 | CMAR60168 | 4107 | 5083 |
| 60 x 192 | | 4 | 2 | CMAR60192 | 4603 | 5589 |
| 60 x 216 | | 4 | 2 | CMAR60216 | 5598 | 6941 |
| 60 x 240 | | 5 | 2 | CMAR60240 | 6201 | 7584 |

CM10 Conference Tables

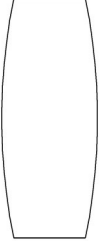
| | Dimensions width x depth | Bases | Top Sections | Model # | Standard Laminate | Standard Laminate | |
|---|--|---------|--------------|-----------|--|---|------|
| | | | | | Top Flat Edge SV3FE List Price \$ | Top Knife Edge SV3KE List Price \$ | |
|  | 48 x 72 | 2 | 1 | CMRT4872 | 1850 | 2120 | |
| | 48 x 96 | 2 | 1 | CMRT4896 | 2025 | 2340 | |
| | 48 x 120 | 3 | 2 | CMRT48120 | 3190 | 3830 | |
| | 48 x 144 | 3 | 2 | CMRT48144 | 3360 | 4067 | |
| | 48 x 168 | 3 | 2 | CMRT48168 | 3703 | 4526 | |
| | 48 x 192 | 4 | 2 | CMRT48192 | 4199 | 5036 | |
| | 48 x 216 | 4 | 2 | CMRT48216 | 5160 | 6322 | |
| | 48 x 240 | 5 | 2 | CMRT48240 | 5890 | 6940 | |
| | 60 x 96 | 2 | 1 | CMRT6096 | 2120 | 2465 | |
| | 60 x 120 | 3 | 2 | CMRT60120 | 3435 | 4155 | |
| | 60 x 144 | 3 | 2 | CMRT60144 | 3671 | 4472 | |
| | 60 x 168 | 3 | 2 | CMRT60168 | 4107 | 5083 | |
| | 60 x 192 | 4 | 2 | CMRT60192 | 4603 | 5589 | |
| | 60 x 216 | 4 | 2 | CMRT60216 | 5598 | 6941 | |
| | 60 x 240 | 5 | 2 | CMRT60240 | 6201 | 7584 | |
| | Racetrack | | | | | | |
| |  | 48 x 72 | 2 | 1 | CMBT4872 | 1850 | 2120 |
| | | 48 x 96 | 2 | 1 | CMBT4896 | 2025 | 2340 |
| 48 x 120 | | 3 | 2 | CMBT48120 | 3190 | 3830 | |
| 48 x 144 | | 3 | 2 | CMBT48144 | 3360 | 4067 | |
| 48 x 168 | | 3 | 2 | CMBT48168 | 3703 | 4526 | |
| 48 x 192 | | 4 | 2 | CMBT48192 | 4199 | 5036 | |
| 48 x 216 | | 4 | 2 | CMBT48216 | 5160 | 6322 | |
| 48 x 240 | | 5 | 2 | CMBT48240 | 5890 | 6940 | |
| 60 x 96 | | 2 | 1 | CMBT6096 | 2120 | 2465 | |
| 60 x 120 | | 3 | 2 | CMBT60120 | 3435 | 4155 | |
| 60 x 144 | | 3 | 2 | CMBT60144 | 3671 | 4472 | |
| 60 x 168 | | 3 | 2 | CMBT60168 | 4107 | 5083 | |
| 60 x 192 | | 4 | 2 | CMBT60192 | 4603 | 5589 | |
| 60 x 216 | | 4 | 2 | CMBT60216 | 5598 | 6941 | |
| 60 x 240 | | 5 | 2 | CMBT60240 | 6201 | 7584 | |
| Boat | | | | | | | |

Modern Industrial Credenza



Top Specifications:

Veneers: Architectural grade veneers. Standards (Walnut, Oak, Maple) Standard veneer layup:
(Walnut - Flat cut (plain sliced) book match), (Oak - Flat cut (plain sliced) book match),
(Maple - Flat cut (plain sliced) Slip match)

Core: All tops are fabricated with 1 1/8" thick Industrial grade particleboard 45lb. density or
Mdf (Medium Density Fiberboard)

Rustic Reclaimed Veneer - Walnut and Oak - Flat cut (plain sliced) Random match

Rustic Reclaimed Core: 1 1/2" thick particle board or Mdf

All tops over 120" are two sections. *Veneer* grain on multiple section tops is running short grain. (*Exception*) *Rustic Reclaimed Veneer* grain runs length wise is random matched unless other wise specified. *Laminate* woodgrain on multiple section tops is running length wise and is not matched up with grain on other section.

Laminate tops: are fabricated with 1 1/8" thick 45 lb. density particle board core. Laminates are standard colors from **Wilsonart and Formica.**

Laminates:

Standards:

1572-60 Antique White
1573-60 Frosty White
1595-60 Black
D315-60 Platinum Grey
D354-60 Designer White

D90-60 North Sea
D91-60 Slate Grey
D92-60 Dove Grey
D96-60 Shadow
4841-60 Desert Zephyr

Woodgrains:

7909-60 Fusion Maple
7937-38 River Cherry
7946-38 Brazilwood
7997-38 Ebony Recon
7054-60 Wild Cherry

7999k-12 Field Elm
8201k-12 Grey Elm

For all other patterns and laminates, contact factory for pricing and availability

Custom request (Size, Top, Color, etc.) Contact :

Cornerstone Furniture, www.cornerstonefurniture.com , ph. (269)795-3379

Edges: 3mm (3/16" thick solid hardwood) Flat eased or Reverse bevel.

Live Edges: 1 1/2" thick solid hardwoods, Core: 1 1/2" thick particle board or Mdf

Standard Wood Veneer Finishes:

Walnut: Clear Walnut, Natural Walnut, Warm Walnut, Dark Walnut.

Oak: Clear White Oak, Natural White Oak, Brown Oak, Pewter Oak, Charcoal Oak

Maple: Clear Maple, Fusion Maple

Wood is a natural material, slight variations will occur in color, grain configuration, and stain acceptance. Finished pieces may vary slightly in tone or character from the samples given, and no guarantee can be made of an exact match.

Semi-filled finish is standard. *Clear Coating :* *Satin* 40 degree sheen , *Flat* 10 degree sheen

Custom Finish matching is available for a **10% upcharge per order** (**\$500.00** minimum list.)

Bases: 2" tubular steel. Finishes: Powder coats: Black, Dark tone, Silver, Medium Gray, White. Polished or Satin Chrome— add to list \$160 each base

Sample Order:

| (Edge) | Model #. | Shape. | Dimensions. | Top. | Edge. | Finish. | List \$ |
|---------|-----------|---------------|-------------|------|-------------------|--------------------------|---------|
| (SV3FE) | CMRE48120 | - Rectangular | 48 x 120 | - | White Oak veneer, | # SV3FE , - Pewter Oak - | \$5859 |

Modern Industrial Credenza Specs



Shown in:

Dimensions: 72"l x 20"w x 31"h

Top: Walnut veneer .75" thick

Edge: Flat eased

Bases: Metal rectangle mount

Finish: Walnut Natural #WNT

Custom sizes, woods and finishes are available.
Contact Cornerstone Furniture to discuss options.
Thank you.

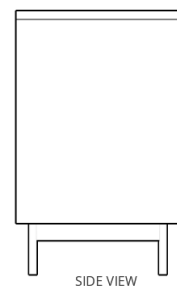
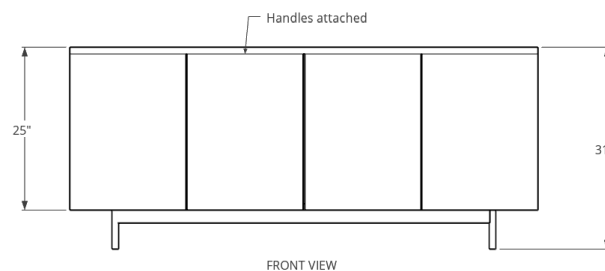
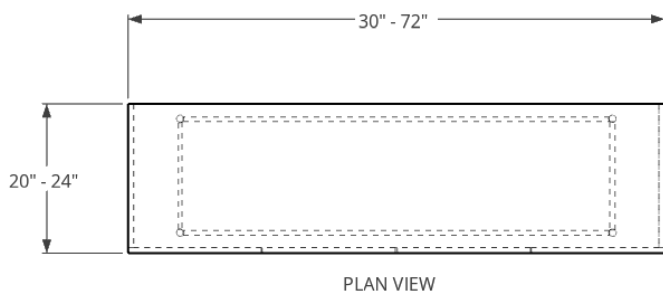

Specifications

Dimensions: 30" - 72" length x 20" & 24" Depth x 31" height.

Tops: Veneer, Designer Veneer, Laminate. Plain sliced, book or slipped matched, balance backer.

Edges: Flat eased

Bases: Metal rectangle mount

Finishes: Check out our finishes in the Price List or contact us for more information.

Handles: Handles are provided by Cornerstone Furniture



Modern Industrial Credenza

| Dimensions W x D x H | Doors | Model # | Veneer | Laminate | Model # |
|----------------------|-------|-----------|---------------|---------------|-----------|
| | | | List Price \$ | List Price \$ | |
| 60x20x29 | 3 | CRV602029 | 5678.00 | 4655.00 | CRL602029 |
| 72x20x29 | 4 | CRV722029 | 6234.00 | 5238.00 | CRL722029 |
| 60x20x36 | 3 | CRV602036 | 6362.00 | 4959.00 | CRL602036 |
| 72x20x36 | 4 | CRV722036 | 7078.00 | 5789.00 | CRL722036 |

| Credenzas Options: | List Price \$ |
|--------------------|---------------|
| Gold legs | 2289 |

Great Lakes Collection



Great Lakes Collection Specs



Shown in:

Dimensions: 24" diameter

Top: Walnut .75" thick

Edge: Eased

Bases: Hairpin

Finish: Natural

Custom sizes, woods and finishes are available.
Contact Cornerstone Furniture to discuss options.
Thank you.

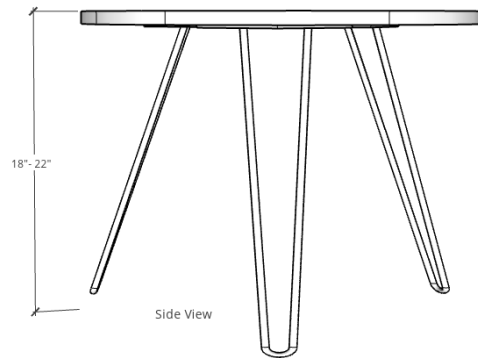
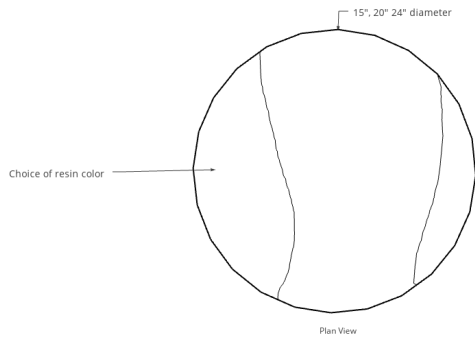

Specifications

Dimensions: 15", 20", 24" diameter

Tops: Solid wood

Edges: Eased

Bases: hairpin

Resin Color: Black, Caribbean Blue, Clear

Finishes: Natural



Great Lakes Collection

| | | | | Walnut (Blue, Black, Clear Resin) List Price \$ | Special (Blue, Black, Clear Resin) List Price \$ |
|---|----------|-------|---------|---|--|
| | Diameter | Bases | Model # | | |
|  | 15" | 1 | C15 | 2111 | 2111 |
| | 20" | 3 | C20 | 3326 | 3326 |
| | 24" | 3 | C24 | 3551 | 3551 |

Circle
(C)



Finishes

Cornerstone Furniture
Finishes

Standard Laminates



Designer White
D354-60

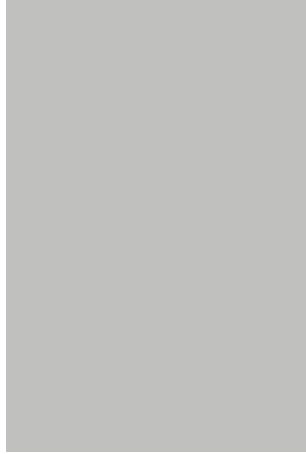

Platinum
D315-60

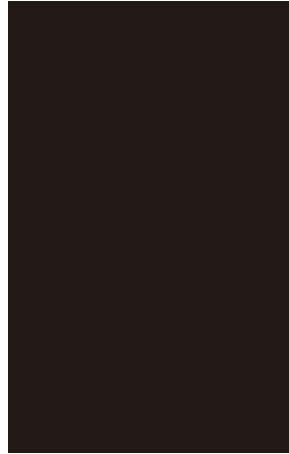

Black
1595-60

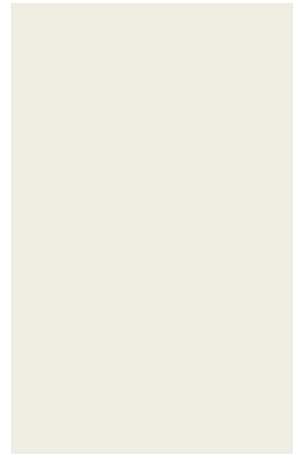

Frosty White
1573-60



Antique White
1572-60



Desert Zephyr
4841-60

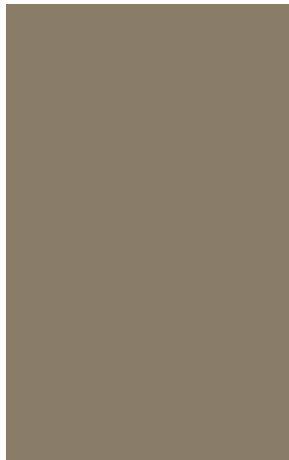

Shadow
D96-60



Dove Grey
D92-60

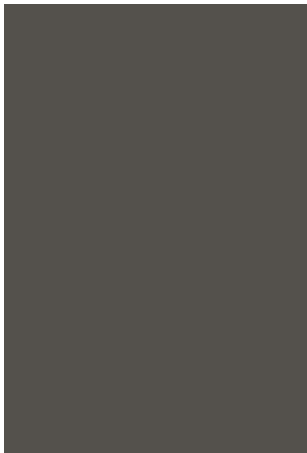

Slate Grey
D91-60



North Sea
D90-60

Standard Laminates Woodgrains



Ebony Recon
7997-38



Brazilwood
7946-38



River Cherry
7937-38



Fusion Maple
7909-38



Wild Cherry
7054-60



Field Elm
7999-12



Grey Elm
8201k-12

Standard Veneers
&
Rustic / Reclaimed



Walnut
Natural #WNT



Walnut
Light #WLT

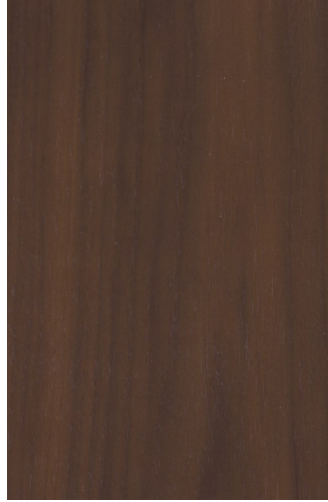

Walnut
Brown #WBT



Walnut
Grey #WGT



White Oak
Natural #ON1



White Oak
Brown #OB1



White Oak
Grey #OG1



Power & Data

Conference table

Power & Data

Power & Data

Interlink



| Part # | Finish | Description | Cord Length | \$List Price |
|--------------|-----------------|---|---------------|--------------|
| INTERLINK | Silver or Black | 2 Power receptacles and a Cutout for 1 Telecom plate, | 72 " cord | 650.00 |
| INTERLINK HW | Silver or Black | 3rd outlet on underside to be used as convenience outlet. | 72 " Hardwire | 690.00 |

A Duo



| Part # | Finish | Description | Cord Length | \$List Price |
|----------|-----------------|--|--------------------|--------------|
| A Duo | Silver or Black | 2 power outlets and 2 usb ports. Offered in clamp-on, under, and bezel mounting options. | 6' or 10' cord | \$ 494.00 |
| A Duo HW | Silver or Black | | 6' or 10' Hardwire | \$ 525.00 |

Perimeter System

FEATURES:

Applications

Under
Desks
Training tables

Standard Finishes -

(For Smart Box Power Infeed)
Die Cast/Sheet Metal Housing/Black Coating

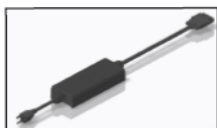
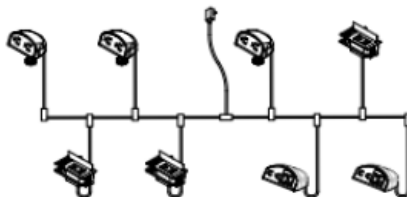

Smart Box Power Infeed
Component 1

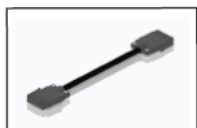

Jumper Cable
Component 2



Compatible Product
Example: Mini Adapt
Component 3

Contact :
Cornerstone Furniture
for custom quote

Telecom Plates

| Top Telecom Plates | Part Number | Configuration | List Price Per plate |
|--|----------------|---|----------------------|
|  | A-BL-A-B | RJ11 Cat 3 Phone and RJ45 Cat 6 Data | 175.00 |
|  | A-BL-B-B | 2 RJ45 Cat 6 Connectors | 221.00 |
|  | A-BL-B-B-B | 3 RJ45 Cat 6 Connectors | 325.00 |
|  | A-BL-B-B-B-B | 4 RJ45 Cat 6 Connectors | 431.00 |
|  | A-BL-102 | USB Type A/A with 72" patch cord attached | 119.00 |
|  | A-BL-102-102 | RJ11 Cat 3 phone, RJ45 Cat6 Data and USB with 72" patch cord attached | 218.00 |
|  | A-BL-A-B-102 | RJ11 Cat 3 phone with 72" patch cord attached | 281.00 |
|  | A-BL-B | RJ45 cat 6 Data | 118.00 |
|  | A-BL-B-B-C45 | 2 RJ45 Cat 6 Connectors and HDMI Female/Female with 36" patch cord attached | 468.00 |
|  | A-BL-CRDMINDER | Cordminder Plate-2-5/8" Holes and 1-7/8" Holes | 68.00 |
|  | A-BL-C45-C51-L | HDMI Female/Female with 36" patch cord attached, Mini Stereo inline, and 15 pin HD VGA Female/Female with 60" patch cord attached | 506.00 |
|  | A-BL-C45-C51 | HDMI Female/Female with 36" patch cord attached, and 15 pin HD VGA Female/Female with 60" patch cord attached | 437.00 |
|  | A-BL-C45 | HDMI Female/Female with 36" patch cord | 256.00 |
|  | A-BL-A-B-B | 1 RJ11 Cat3 Phone and 2 RJ45 Cat6 data | 281.00 |
|  | A-BL | Blank Telecom Plate | 12.00 |

