

April 2023

www.nmra-scwd.org

Volume 54 No. 8

See page 5 for Board of Directors voting information.

Super's Report

Phil Hottmann
Division Superintendent

It's been four years already that I have been Superintendent. With elections coming up in the April meeting, I'm hoping someone will want to step up and become the next Superintendent. This job will give you a little bit different perspective on our club. As many of us are getting older it's very important that we start bringing in some young people.

The Youth Group is starting to get our feet on the ground with two meetings now complete. We have been meeting at Noble Knights which has not worked out as well as we thought it might. The community area has been full of at least a hundred folks doing various gaming activities during the time that we are there. We are considering moving this to the Verona Senior Center if they have openings.

We are still collecting names of people that would like nametags. The more names we get will reduce the price. We hope to get the price down to around \$10. Please email me by March 27th if you would like to get on the list.

The Banquet is scheduled for Friday May 5th. A number of you have already signed up, but I would like to see us get a great group together this year.

Thanks to John Haverberg for organizing the Spring Rail Fan Trip. Unfortunately, we did not get enough interest to justify renting a bus. So, this year's trip will be cancelled.

Next SCWD Meet

Verona Senior Center, Verona (Map Page 9)

April 2, 2023 at 1 PM

Next Youth Group

Verona Senior Center, Verona

April 8, 2023 1 PM

Next BOD Meeting:

April 10, 2023 at 7 PM

ZOOM Meeting



The other day Ellen and I made a trip to Mineral Point and discovered a model railroad in one of the art galleries. The owner decided to build the layout during Covid. The layout is in the store front window to attract customers. It was interesting to see how, an artist approached model railroading. If you're in the area, it's worth stopping in. Of course, there is also the model railroad in the museum which is wonderful.



April will be the last meeting held here. May's meeting will be in Rockford and I'm hoping many of you plan to travel with us!

I guess I better get downstairs to complete my Modeling Project.

Phil

Clinic Column

By Ken Hojnacki

Ken Mosny did a great job introducing us to the new world of 3D printing. It's amazing what can be done and the technology is only in its infancy. On a sad note, Ken lost his wife just a few days after his presentation here and we wish him comfort in this terrible time.



We have all undoubtedly seen the fantastic work done by military modelers and war gamers. The detail and techniques they employ often go far beyond what we model railroaders produce. Phil Hottmann has mentioned Nobel Knights at some of our meetings and the Youth Group has started meeting at their facility in Fitchburg. For our first clinic this month, Aaron Filter, HR Manager/Process Improvement Coordinator for Nobel Knight Games will present his clinic "Model Railroading and Wargaming: Birds of a Feather." Aaron will tell us about his personal journey of being a life long model railroader as well as a miniature war gamer. The two hobbies are more alike than many would imagine and use many of the same products and techniques to create amazing scenery. Noble Knight Games is more than a game retailer, in fact they are also a full-service hobby store that carries a vast array of paints, scenery and other materials that both model railroaders and wargamers use while enjoying their hobbies. Being familiar with our hobby, Aaron will show us some of the techniques and products the military and fine scale modelers use to make their dioramas look so real and that might help us with our own modeling.

For our second clinic, Bob Wundrock MMR is always updating his talents with photo backdrops. If you haven't seen his Minneapolis and Duluth backdrops, you're in for a treat. Bob will show us the evolution of producing his photo backdrops over the past 20 years. He'll show various backdrops on his past and current layout along with the techniques he uses to expand his model railroad horizons.

Ken

Layout Tours

Phil Hottmann Chair

It was great to see a new layout being started! John Krueger's layout is going to be one of the largest layouts in the area. It's a triple deck, full basement size layout. This layout is designed for operations so I'm looking forward to the day when operations begin. In the meantime, John is looking for volunteers to help out on construction. You may be able to see in the photos the drawings of the completed layout.

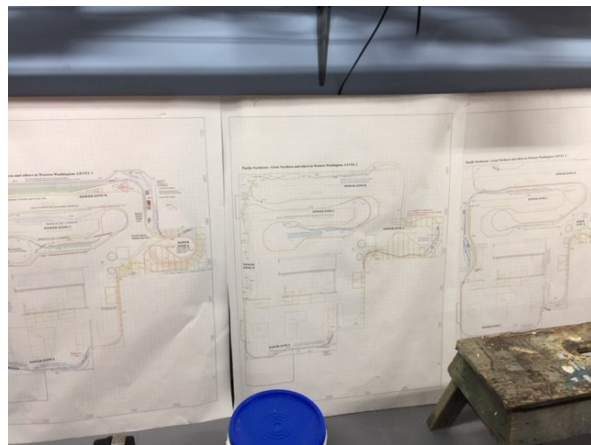

For April we will be visiting Ron Halvorson's Union Pacific – Pocatello Subdivision layout. It's been a few years since we have seen Ron's layout, and I'm very interested in seeing what's been added.

Phil

Contest Column

Dave Down, Chair

We have completed our schedule of popular vote contests for the 2022-23 year. Thank you to everyone who submitted entries this year. We had some really marvelous entries, so we all won because of the entries everybody brought in.

Our March contest was one of the best of the year for participation. The results are recorded below. Our contests will resume in September for the 2023-24 year and a list of the contest themes will be in the bad order and put on the website.

If you haven't had enough contests, you are invited to participate in the contest at Rockford in May. The theme of their contest is flat cars with loads.

Here are the results of the March contests:

March 5 Popular Vote Contest Results - Off-Track Vehicles

Models

Cat. A Commercial Trucks / Vans

- 1st Rusty Dramm: White dump truck
2nd Dave Lendved: Wisconsin Bell telephone truck
3rd Dave Casey: Ice delivery truck



Cat. B Automobiles / Pickup trucks

- 1st Don Swinton: Station wagon with luggage rack
2nd Dave Casey: Fearings appliance truck
3rd Rusty Dramm: Porsche 917 - 1971 LeMans



Cat. C Agriculture

- 1st Rusty Dramm: Cat 518 log skidded
2nd Dave Casey: Dodge stake bed truck
3rd Bob Stone: John Deere tractors on flat car



Cat. D RR Maintenance Trucks and Equipment

- 1st Dave Casey: C&NW pickup truck
2nd Dave Casey: C&NW Ford stakebed truck
3rd Bob Stone: GN bus



Prototype Photos

Cat. A Commercial Trucks / Vans

- 1st Dave Down: Berghof Beer truck
2nd Dave Down: Glacier National Park bus

Cat. D RR Maintenance Trucks and Equipment

- 1st Dave Down: Wis & Southern front end loaders on trailers
2nd Dave Down: Wis & Southern flatbed straight truck
3rd Dave Down: Loram rail services truck

Dave

2022 - 2023

POPULAR VOTE MODEL AND PHOTOGRAPHY CONTEST THEMES

September: Tourist Train

- East. (More than 2 states from Mississippi)
- Central. (2 states on either side of Mississippi)
- West. (More than 2 states from Mississippi)
- Free lance (Model) Foreign (Photo)

October: Box Cars

- Wood
- Outside braced
- Double door
- All door

November: Kit built. (You bought it, you built it)

- Locomotive
 - Freight car
 - Passenger Car
 - Non-revenue
- (Photo contest will be models only, no prototype)

December: Reefers

- Ice
- Mechanical
- Cryogenic
- Milk

January: No contest. RAIL SCHOOL

February: Non-trackside building

- Commercial, retail, factory
- Residential (house, apt.)
- Farm
- Miscellaneous

March: Off-track vehicles

- Commercial trucks/vans
- Automobiles/pickups
- Agriculture
- RR maintenance trucks and equipment (non-rail)

April: No Contest. MODEL PROJECT

May: At Rockford

AP Corner

~~Judge for~~ Evaluate Yourself

Ken Hojnacki



Yes, it has been a while since the last AP Corner. For folks new to the Division, the Achievement Program is an educational aspect of NMRA membership devoted to improving members' skills and knowledge of model railroading. Through a series of categories involving model building, track and electrical skills and service to the hobby, one can work their way through the requirements necessary to become recognized as a Master Model Railroader. No, no monetary rewards, no parades or special considerations—just the opportunity to learn new skills, build some models, build a railroad of your own and share your knowledge with the next person down the line. Our version of “pay it forward.” It's not a bragging thing. It's a challenge to yourself, an acknowledgement of your growth in the hobby and the camaraderie that comes with it and pride in your own accomplishments. You can learn more about the program from the NMRA website. Just look under the Education tab on the home page and go to Achievement Program.

So, what's this got to do with judging—er, evaluating yourself? In the categories of Cars, Locomotives, Structures, Scenery, Track and Electrical, the required items must be evaluated ideally by three people to ensure all requirements have been met. With Cars, Locomotives and Structures, models must earn a score of 87.5 points based on various construction criteria to meet those requirements. While using the same scoring structure as a judged model contest, Achievement Program models are viewed slightly different and are evaluated rather than judged.

In the past, we have had a number of Master Model Railroaders in the Division and other AP Certificate holders who could perform these evaluations. Unfortunately, those numbers have dwindled and we lack sufficient members who are qualified to perform these evaluations. The SCWD Board has requested that I recruit members interested in becoming evaluators (and thereby also being qualified to judge any formal model contest models as well) and arrange for some training in how to approach the required scoring. While evaluators are not compensated for their time, you do get credit toward the hours required for the Association Volunteer AP Certificate.

Our old friend Gary Children, a vastly experienced judge on the Division and Region levels, has agreed to help in our training effort. I envision an afternoon session, 3 hours or so, to go over the scoring procedures and use some actual models as hands-on examples of how it's done. I don't expect any of us to be experts by the end of that but with that background, and help from a couple

of active members still in a position to help us keep focused, we will be ready to handle any models that we are asked to evaluate. I know there are a couple of members working on models that will soon need to be evaluated so now is the time to prepare.

I am hoping to hear from many of you who may be interested in learning the ropes to help others succeed in their AP journey. And if you think about it, if you learn how your own models will be looked at for AP evaluation or model contest judging, you'll be that much further ahead when deciding your own construction approach. So please contact me at khojnacki@charter.net with your interest. I would like to try to arrange the training session for sometime this summer or early fall. So why not try something new, learn some helpful hints and help out the NMRA, the SCWD and your fellow members as well.

Ken

Youth Group

By Steve Preston



Hi all, our youth group team was attended by Bill Mitchell, Phil Hottmann, Jerry Lawler, Chris Bradley, Steve Preston. Our team had set up a small layout for a few kids that had brought some cars and engines. Phil showed them how to solder some terminals, and Bill had explained to them some basics tools for their tool boxes. Bill had also brought some basic things to give to the kids while they were there. Bill had purchased some safety glasses, and some olfa knives and a few other things including a membership card to show at Madison Hobby Stop and Noble Knights for discounts on their supplies they'll need, good work Bill.

The kids were each given a 1" by 1x2ft piece of Styrofoam and some modeling kits to build at home. These kits were a telephone shanty and a loading platform. They were also given some trees and some extra telephone poles, thanks to your donations.

In the next session they will be mounting some things on the Styrofoam, and be given some small quiz on railroad terms and slang. We had 6 kids in attendance and 2 were new to our group. They will have the opportunity to glue and paint their kits and outline where they would like to lay track and trees. Jerry had given them each a piece of track so they could get an idea of where to put everything.

Thanks to all of our team and to you our group for making this a success.

Steve Preston
Membership Chairman and
Youth Group Director



Online absentee and early voting available under the Newsletter tab on the SCWD Website until March 31. In person voting will also be held at the April 2nd Division meeting.

Candidates in Alphabetical Order

Art Dawson

Like many others I had an HO train loop on a sheet of plywood when I was young, and mine had a slot car track in the middle of it too! As a child, my family road the Empire Builder out to Seattle (dome cars and all) with my two brothers and I dressed in red polo shirts. All mom had to do was ask any car attendant were we were, and they knew.



After forays into model airplanes, rockets and cars, then school, girls, and work followed by family took up all my time until my son was old enough to show some interest. By then I had learned that my grandfather and great-grand father worked on the section gang for the Nickle Plate in central Illinois. I've been hooked on that prototype ever since. As my son got old enough, we joined the SCWD youth group and participated in the show for a couple of years and attended meetings. When Hank Brown decided he was burnt out as Show Chairman, I asked what was involved one meeting, and if you knew Hank, he talked me into taking over as chairman. The rest was history as I had that role for 20 years.

Being back in the area for a few years now, and working the show office for the last two years, I decided it was time for the next step and agreed to run for the SCWD Board this year. I will do my best to support the division in that capacity if elected.

David Dingman

With retirement becoming more than a light at the end of the tunnel and another weekend spent at the Mad City Model Railroad Show in the spring of 2016 I decided to join the NMRA and SCWD to become more actively involved in



model railroading again. Since becoming a member of the SCWD, I have been asked to become AV Chair and volunteered to be part of the setup crew for the Mad City Model Railroad Show. I have also been the Train Show Ticket Master for the 2020 (assistant), 2022 and 2023 shows. It has been my honor to have served on the SCWD Board of Directors for the last three years. I hope to continue serving on the SCWD BOD for the coming year.

Dave Down

Hello SCWD members. My name is Dave Down and I am running for re-election to our Division's Board of Directors. I have been interested in model railroading starting with my first train when I was 8 years old. I had a large American Flyer set which was big enough to run around both our living room and parlor. My father also introduced me to HO trains when I was 12 when he gave me a refrigerator car (which I still have). While I was in college my parents moved and had an auction, which was the last time I saw the American Flyer. After that time I was pretty much a closet model railroader until I approached retirement.



During the next 45 years I read magazines, acquired some engines and cars, and started work on a couple different layouts. Work took me on the road and gave me too many chances to procrastinate, so when I approached retirement I set a goal of becoming a model railroader for real. I decided to become a member of the SCWD in the fall of 2015 with the goal of meeting and getting to know people who have already had success in the hobby, and to find which aspect of the hobby will give me the most satisfaction. As a result, I have acquired a model railroad layout based on the Soo Line (Bill Ehlert's Rugby Junction) and hope to have it ready soon for visits, virtual or in person, as the pandemic allows.

I continue to believe the SCWD can only be successful in building the hobby when it is effective in helping modelers develop their skills and expand their interests. To me that effectiveness is based in the opportunities and challenges the SCWD gives its members to use their abilities and skills and actually pursue their interests. I am running for the Board of Directors in an effort to give back to the organization and the hobby. My goal is to encourage others to get involved and to make SCWD an attractive organization to current, new, and future members.

Continued next page

Phil Hottmann

I have been a model railroader for 28 years. Most recently I have served on the SCWD B.O.D as Superintendent and have also been organizing our layout tours.



My focus in the hobby has been on highly detailed and weathered structures. I find this hobby to be extremely interesting and challenging. With recent developments in digital technologies, we have seen a new level of realism. This has also reduced the amount of effort required and has created a real boost to the hobby.

I have enjoyed attending the SCWD meetings and have often been amazed at all of the information provided by the members and for the members. I would like to see the division continue to grow and develop and serve on the Board for another term.

John Kosobucki

As is often the story in model railroading, I was introduced to trains by my parents at Christmas time when I was 7 years old. The Lionel freight train set I received then is still operational, and occupies a 4 x 8 space in the basement along with a few accessories, scenery, and some upgrades. I was introduced to model railroad operations by the late Hank Brown when I was investigating a burglary to one of his properties, and he invited me to see his layout and become one of the regular operating crew. I became an NMRA, and SCWD member in 1997.



We have some truly talented members of the SCWD, and I am utterly amazed at the detail and workmanship so many of them have accomplished on their layouts. I have been honored to operate on several of these layouts that belong to the best modelers I know.

Outside of the hobby, my professional life included 8 years as a journal clerk for the Wisconsin State Senate; 20 years as a deputy and sergeant for the Dane County Sheriff's Office; and 11 years as the site administrator for a national phone company that contracted with the Dane County Jail for inmate phone service.

As many of you have, I too have volunteered for many years at the SCWD Annual Train Show in Madison. It is great that so many of you have answered the call to make this annual event the success that it is. However, there is so much more that goes on behind the scenes for months and months leading up to this two-day event. Your SCWD BOD plays a significant role in making all of this happen.

I was honored when asked to throw my hat into the ring

to run for a position on the SCWD Board of Directors. As the new guy, I know there will be a lot to learn, but I want to serve you, the members of the SCWD, and would be honored to have your vote.

Bill Mitchell

I have been a member of the National Model Railroad Association since 1967 and became a LIFE member of the NMRA in 1988.



Back in April 2020, I was appointed by the Board of Directors to fill a vacancy on the board due to a resignation. I volunteered to take the position of Clerk. I was elected to the Board of Directors at the next annual membership meeting in the Spring of that 2020.

I enjoy being a member of the SCWD Board of Directors and would like to be re-elected for the 2023 - 2024 term. If elected, I would be like to continue in the position of Clerk.

Steve Preston

Thank you for letting me serve on the board for the past few years. I am glad to have been a part of our Division's decision-making process. Hopefully we will continue to serve our Division well and keep our commitment to run a well organization such as ours.





It's banquet time!

May 5th 2023

To be held at the:

American Legion Hall

207 Legion Street

Verona, WI 53593

Cocktails at 6pm



Dinner will be served starting at 7pm — so don't be late.

Reservations must be received by May 1st

Cost of meal: SCWD/NMRA members, \$15.00

Non-NMRA attendees, \$25.00

Children 12 & under, \$5.00

Name:	Rail	Non-Rail	\$

Note: If you are an NMRA member, your spouse, child over 12 or significant other is the same price as you.

Make sure you indicate rail or non-rail. If more than 4 then add to a separate piece of paper and send it along with your reservation

Address: _____

City: _____ WI Zip _____

Send your reservation to:

Phil Hottmann

1147 Willow Run

Verona, WI 53593

Amount enclosed: \$ _____ Checks should be made payable to the S.C.W.D.

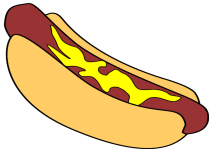

SCWD 2023 Annual Summer Picnic

Saturday, July 15, 2023



For the past several years, except for 2020, the SCWD has held a catered picnic at Little Amerricka Park in Marshall on their “Whiskey River Railway Day”. The SCWD Board has agreed to do so again this summer on Saturday, July 15th. Reservations have been made with the amusement park for use of their Blue Rose Pavilion and catering is being arranged. The park opens at noon and closes at 5 pm. Lunch will be served starting at 1:00 pm. As was done in 2019 and 2022, the Board has decided to defray part of the catering cost by charging a \$5.00 fee for each attendee, six years old and above. Five and under get the meal for free. Railway equipment can be viewed for free, but train and other rides require purchased tickets from the Park. SCWD members and their families, Youth Club members and their families and other invited guests approved by the Board can attend the picnic. To determine the food quantities for the caterer, you will have to sign up and pay by Saturday, July 1, 2023.

Little Amerricka is located on STH 19 on the east edge of Marshall. Parking directly at the Blue Rose Pavilion can be reached off Box Elder Rd. intersecting USH 19 just east of the Park’s regular entrance.

SCWD 2022 Annual Picnic Sign-up and Payment Sheet

SCWD Member and Family Attendee(s) names:

Cost(each):

Total Enclosed \$ _____

Please print and fill out the form and send with payment (cash or checks - payable to the SCWD) by 7/1 to:

John Haverberg
4797 Delmara Rd.
Middleton, WI 53562



Any questions, contact me at E-mail address:
haverdj@tds.net, Phone: 608-836-7963

Verona Senior Center
108 Paoli Street
Verona, WI 53593

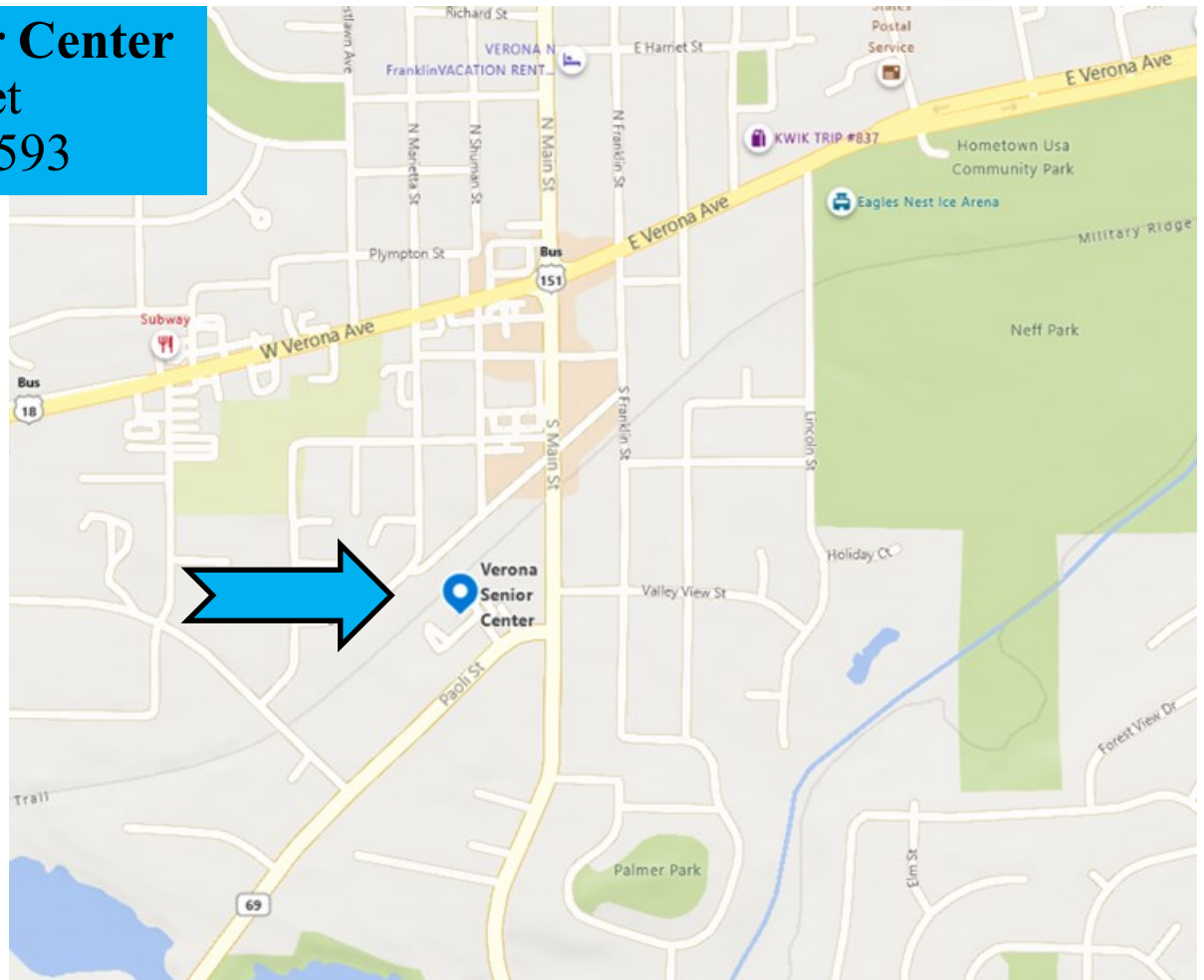

A Puzzle for You

You like trains, or train watching, but have you ever wanted to go to an OPS (Operating Session) and run trains on someone else's layout, but were afraid you wouldn't know what to do?



Model Railroad Operation is a fun and interesting role-playing game where the players (operators) use model trains to simulate the movements of the prototype railroad. Operators fill the roles of railroad employees like engineers, conductors, yardmasters, dispatchers, and more. Many of our SCWD members participate each month at multiple layouts to enjoy this fun and stimulating practice of critical thinking and problem solving in the context of railroad operations.

Now, there is a way for you to get your feet wet in this critical thinking and problem-solving railroad environment in the privacy of your own home through the use of railroad switching puzzles.

In July 2020, a group of SCWD members started a project to introduce more of our members to the enjoyment of railroad operations, or as our wives call it, playing trains. Some of us have been engaged in operating sessions for 20 years or more, and would like to get more of you involved.

The project involves getting one to solve a series of train switching puzzles (on paper, or your computer) in the least number of moves possible. You can then submit your solution to see if yours was done in the least number of moves.

Beginners can start with **3 introductory puzzles** to show the kinds of skills used in railroad switching operations. Then, you can advance to a series of more advanced puzzles written and based on actual SCWD member area layouts. Or, if you have already been to an OPS session, you could do an introductory puzzle, and jump right into the more challenging ones.

Join the SCWD listserv now and begin learning what this is all about!

Email Steve Lanphear at scwdmemberlist@mhtc.net to be added to the list and start receiving your puzzles now!

Happy Railroading!
Steve



Enjoy receiving interesting rail photos, model railroad tips, Operating puzzles, and challenging Mystery Photos??

Join The 120+ SCWD members and members from other Midwest Regional Divisions who are participating in the SCWD listserv. You can expect 5 - 10 photos of railfan photos or model railroad photos or other items per week on average, as well as SCWD announcements, monthly Mystery Photo contests, Modelers Corner, and OPS Corner Puzzles. The listserv has been running this since April 2012, and it has been quite popular.

The listserv is a one-way email broadcast to you, not a social media type service. The emails are sent in bulk, but as a BCC: type email.

Please save this email so you know how to get a hold of me. So, if you would like to try out this FREE member service, just send me your **Name** and **email address**, and **City/State** to the address below. You may drop out at any time by sending an email stating such to the same address below.

Steve Lanphear
SCWD listserv Coordinator
scwdmemberlist@mhtc.net



OPS Puzzles

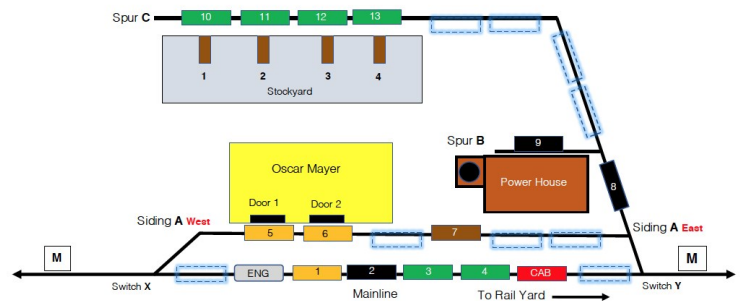

OPS Puzzles have arrived! We now have a section on the SCWD Website that has all 11 puzzles that we have published on the listserv, including the handouts and diagrams. You can start from the beginning, or pick and choose which puzzles you would like to try.

www.nmra-scwd.org/ops-puzzles.html

Steve Lanphear and the Puzzle Development Team.



NMRA NEWS



TEXAS EXPRESS    

AUGUST 20-26
Dallas/Fort Worth
GAYLORD RESORT, GRAPEVINE

SUPERCHARGED - HIGH SPEED - STREAMLINED

NATIONAL TRAIN SHOW

August 25-27

SPENCER CHRISTIAN

Banquet Speaker

GAYLORD RESORT

4-star Hotel and Water Park

BNSF HQ TOUR

Dispatching Center and Intermodal Yard

CLINICS

SIG ACTIVITIES

LAYOUT TOURS

OPERATION SESSIONS

CONTEST AND DISPLAY

FREEMO-N OPERATIONS



RAIL TOURS

- Texo Grain Mill
- Private Railcars
- TexRail Back Shop
- Texas State Railroad
- Trinity Rail Car Plant
- BNSF Intermodal Yard
- Six Flags Railroad Shop
- Grapevine Vintage Railroad
- McKinney Ave Trolley Shops
- Trinity Tank Car Cleaning Plant
- BNSF National Operations Center
- Museum of the American Railroad
- BNSF Private Western Art Collection
- T&P, Santa Fe, & Dallas Union Stations
- Fort Worth & Western Railroad Back Shop
- Union Pacific Dallas International Terminal
- Light Rail & Commuter Shops (DART & TRE)

GENERAL INTEREST

- George W Bush Library
- Fort Worth Stockyards
- Grapevine Wine Tour
- Sixth Floor Museum
- Fort Worth Modern
- Holocost Museum
- Kimbell Museum
- Globe Life Park
- AT&T Stadium
- Dealey Plaza

NMRA *National Convention*
2023 TEXAS EXPRESS.COM



**Minutes SCWD Board Meeting
7:00 pm, 13 February 2023
via Zoom meeting**



The meeting of the South Central Wisconsin Division Board of Directors was called to order at 6:39 pm by Superintendent Phil Hottmann. Phil Hottmann, Bob McGeever, Dr. Bill Clancy, Dave Dingman, Steve Preston, and Bill Mitchell were present. John Kosobucki joined a bit later. John Haverberg attended as a guest. (Meeting start times may vary due to BOD members schedules.)

BOD Meetings: Members of the SCWD are invited to join a Board of Directors meeting. Meeting dates are published in the **Bad Order**. Send a request to Phil Hottmann or another member of the SCWD Board for a ZOOM link to the upcoming meeting. The members' contact information is in the **RED BOOK**.

Minutes

Motion by McGeever, second by Dingman, to approve the minutes of the January 9, 2023, meeting which included grammatical corrections suggested by John Kosobucki. Motion carried.

Paymaster Report

Motion by Mitchell, second by Dingman, to approve the January Paymaster Report as written. Motion carried.

Committee Reports

Achievement Program - Nothing to report.

Advertising - Nothing to report.

Bad Order - Articles are due for the March newsletter by February 14. Phil Hottmann will send in his Superintendent's Report after the February 18 - 19 Madison Model Railroad Show and Sale.

Special Note 1: The email list comes directly from the NMRA membership list, so please keep your membership active and your email current with the NMRA. All SCWD members are requested to inform the NMRA when their email address changes.

Special Note 2: Kathy, our newsletter editor, is always in need of articles. Please submit articles as soon as possible to have them included in the next publication of the Bad Order to SCWDKATHY@AOL.com via email with attachments in a WORD formatted document.

Clinics - Clinics are being lined up for the March membership meeting.

Contests - Model and Photography - The contests are on schedule. The May contests are canceled due to the joint meeting.
Details of the May joint meeting will be announced at a later date.

Modeling Project - The modeling projects are due at the SCWD Membership Meeting on April 2, 2023.

Door Prizes - The door prizes are all purchased.

Layout Tours - The layout tours are lined up for March. Phil is still looking for future layout tours to be scheduled. We need members to suggest layouts to be set up for tours.

Our SCWD organization is always looking for more people to host virtual or in-person layout tours. Please contact Phil Hottmann about the possibility of opening up your layout for a virtual or in-person tour. Phil's contact information is in the REDBOOK.

Membership - Steve Preston - 1 member still needs to re-new their NMRA membership.

The current SCWD membership list is sent to Steve Preston on a monthly basis. The email address of the SCWD members associated with the membership list is used for the Constant Contact electronic communications system. Each member is responsible for making sure that their email address is valid. If someone has problems renewing their NMRA-SCWD membership using the ON-LINE systems, please contact Steve Preston. His contact information is in the RED BOOK.

Picnic - John Haverberg - The SCWD July Summer Picnic is scheduled for July 15, 2023, at **Little Americka Park** in Marshall on their "Whiskey River Railway Day".

The cost to attend the 2022 Summer Picnic: **Adults, Children Age 6 years old and above \$5.00**
Children 5 years old and under FREE

Motion by McGeever, second by Dr. Clancy, to keep the price of the 2023 July picnic the same as 2022. Motion carried.

Publicity - Nothing to report.

Rail School - Dr. Clancy informed the Board of Directors that a new person is needed to take on the position of Rail School Coordinator for 2024. The new Rail School Coordinator will be able to plan the event using all of Dr. Clancy's notes.

Rail Show - February 19th and 20th - Bob McGeever is meeting with the Exposition Center people on Wednesday, February 15, to go over the final details for the Rail Show. Bob and his group will be laying out the floor plan, setting up and labeling tables for the vendors and exhibitors on Thursday, February 16. "Move-In / Set-Up" will be on Friday, February 17.

A small group of people will meet for breakfast before going over to the SCWD storage facility to load the truck with the Rail Show equipment and Company Store items.

Website - Tom Morrison has the new link to the SCWD **VIMEO** videos in the website. YouTube videos will be phased out.

Thank you, Tom!

VIMEO Note: There is no cost to people viewing videos on VIMEO.

The www.nmra.org website is *UNDERUSED* by its members. There is a direct link from our SCWD website to the National Model Railroad Association website. You will need to register your NMRA membership to view the "members only" information on the different pages of the NMRA website.

Old Business:

Youth Group - Steve Preston will be writing a Youth Group article for the **BAD ORDER**. 5 youth attended the meeting at **NOBLE KNIGHTS GAMES** in Fitchburg on Saturday, February 11. The next meeting will be at 1:00 pm on Saturday, March 11, at **NOBLE KNIGHTS GAMES**. Bob McGeever will be purchasing some gift certificates for the rest of the year for the Youth Group. The cost of the gift certificates are in the Youth Group budget. Plans are currently being made for the March meeting.

Youth Group Notes - Youth 18 years of age and under are welcome to join the SCWD Youth Group. A parent or designated adult is required to attend with the youth. The Youth Group Committee is looking for more members. Also, SCWD members are needed to present model railroading topics.

For the security of our Youth Group members, no images or last names of Youth Group members will be posted in the SCWD Facebook page.

Spring Banquet - Phil Hottmann has scheduled the banquet on Friday, May 5th, at the Verona American Legion Hall. Cocktails Hour is at 6:00 pm. Dinner will be served around 7:00 pm. The event details will be published in the **BAD ORDER** as more details become available.

The cost to attend the 2022 Spring Banquet:

SCWD/NMRA members	\$15.00
Non-NMRA attendees	\$25.00
Children 12 & under	\$5.00

If you are an NMRA member, your spouse, child over 12 or significant other is the same price as you.

Motion made by McGeever, second by Kosobucki, to keep the price of the 2023 Spring Banquet the same as 2022. Motion carried.

Spring Trip - John Haverberg continues to work on the details for a Spring trip to view a number of model railroad club layouts in the Greater Milwaukee area. Costs for a Motor Coach that can carry at least 31 passengers is being investigated.

New Business:

Verona Senior Center Membership Meetings - The microphone issues for the sound system are being addressed. The ZOOM presenters need to be reminded to stay in front of their computer and speak into the computer's microphone.

Youth Group Attendance Registration - The registration sheets for the Youth Group meetings will need to include the Parent or Designated Adult name, the youth members name, and contact information. The registration sheets will be kept for a period of 1 year.

Adjournment:

A motion was made by McGeever, second by Kosobucki, to adjourn the meeting. Motion carried. The meeting was adjourned at 8:02 pm.

Bill Mitchell - Clerk

FROM the NMRA Please Keep in Touch



Please make sure the NMRA has your current contact information. You will not be able to access the full range of NMRA benefits unless we can reach you.

- Please visit nmra.org/members
- Use your email address and password to log in.
- If you have not yet registered, or forgot your password, there are buttons for that. Take a moment to easily correct any problems.
- Once logged in, click on Member Info (top right corner).
- Make sure your information is correct.
- If not, please go to:

nmra.org/request-membership-info-changes

to submit a request for changes to be made.

Thank you!

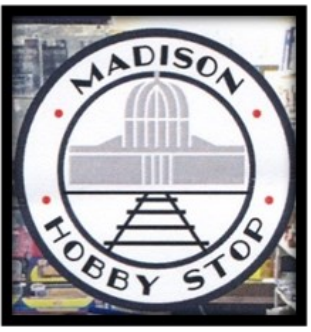

MADISON HOBBY STOP

6622 Mineral Point Road, Madison, WI 53705

Ph: 608-829-3820 • Fax: 608-829-3852 • www.madisonhobbystop.com

Hours: Monday – Friday (10 am – 8 pm) and Saturday (10 am – 5 pm)

Model Railroading • Plastic Model Kits • Rockets & Accessories • Pine Car •
Paints • Tools & more!

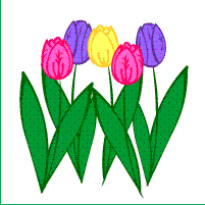

HAPPY SPRING!!

After this long winter,

there's still time to work on the layout and run trains.

Before the yard work starts

keep having fun with the railroad!

New/ Old stock continues to come in and is selling good.

We are now closed Sunday's till the end of November

Thank you for your continued support.



**Preorders are 25% off regular price except
Walthers Proto which is 20% off**

New/old consignment coming in weekly, stop in for best selection

**Remember, most model railroad items are 20% off
with a valid NMRA or other club id card**

Excludes discounted or sale items, magazines, and consignments

Gift Certificates Available

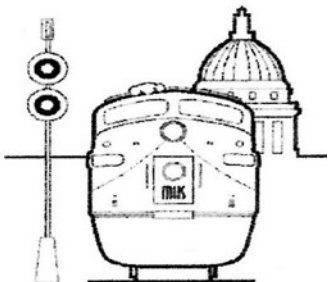

Madison Hobby Stop
Chris Roosli, Proprietor

The Hobby Depot

Brian Stackpole, owner



See us on the web at: www.hobbydepotmonroe.com



835-17th Street
Monroe, Wisconsin 53566

Phone: 608-325-5107

Call ahead to be sure we're open!

email: hobbydpo@tds.net

TRAINS & MORE

South Central Wisconsin Division of the
National Model Railroad Association

Publishes eleven issues yearly of the

BAD ORDER

Official Mailing Address:
BAD ORDER
3940 Trempealeau Trail
Verona, WI 53593

Photos in the Bad Order, unless otherwise noted,
are by Kathy Clancy

Deadline for submissions: **14th of the month**
prior to publication. Email Bad
Order Editor at SCWDKATHY@AOL.com

New Berlin Model Train Swap

April 23, 2023

New Location - More Vendor Tables!
OAW Indoor Sports Complex

5330 S Racine Ave.
New Berlin, WI
9am - 1pm

Admission only \$5

Future Shows

• July 16

• September 24



For more information or to be a vendor, email:
newberlinmodelswap@gmail.com - or - (262)-676-7014

Looking for scenery materials?
Visit our promotion sponsor at
www.superiorscenics.com or on Facebook!



**If you change your
email address**

don't forget to notify
the NMRA and
Kathy Clancy
Bad Order Editor

Thank you!

Place your ad here!!!

Contact

Kathy Clancy

Bad Order Editor

SCWDKathy@aol.com

PLEASE PATRONIZE OUR AREA HOBBY STORES

The Hobby Depot – 835 17th Street – Monroe WI
Madison Hobby Stop – 6622 Mineral Point Rd (inside Clock Tower) – Madison WI *

* = Train Show Ticket advance sales

SCWD 2022-2023 Meeting Schedule

Regular Meeting	BOD	Youth Group
April 2, 2023	April 10, 2023	April 8, 2023
May 7, 2023 (Rockford)	May 8, 2023	May 13, 2023
	June 12, 2023	
	August 14, 2023	

A Word about Constant Contact e-mail

Each Constant Contact e-mail includes links to update or unsubscribe your e-mail address. **Please do not use these links.** If you unsubscribe using the Constant Contact link, your e-mail address will be removed from the NMRA membership database, from the Midwest Region e-mail database and probably from your Division's records. If you get an e-mail that you don't want, just hit the delete key. Furthermore, if you use the update link, your change may not be timely posted to the NMRA membership database.

If you need to change your email address with the NMRA please follow these directions:

The direct way is to log on to the "Members" page of the NMRA website, choose the "View your NMRA membership" box on the right side of the screen, scroll down to the bottom of the page and select "Update". Enter the new email address in the appropriate box and click "Submit".