

COTTER PINS

Zinc Plated

- One prong is extended for easy insertion.
- Use to lock clevis pins, slotted nuts, and other fasteners.

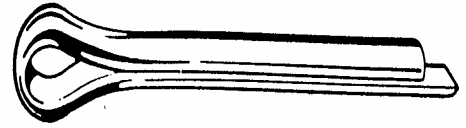

1/16 DIAMETER		
J&B #	SIZE	QTY
12330	1/16 x 1/2	100
12331	1/16 x 3/4	100
12332	1/16 x 1	100
12333	1/16 x 1-1/4	100
12334	1/16 x 1-1/2	100
12335	1/16 x 1-3/4	100
12336	1/16 x 2	100

5/64 DIAMETER		
J&B #	SIZE	QTY
12325	5/64 x 1	100
12327	5/64 x 2	100

7/64 DIAMETER		
J&B #	SIZE	QTY
12328	7/64 x 1	100
12329	7/64 x 2	100

3/32 DIAMETER		
J&B #	SIZE	QTY
12337	3/32 x 1/2	100
12338	3/32 x 3/4	100
12339	3/32 x 1	100
12340	3/32 x 1-1/4	100
12341	3/32 x 1-1/2	100
12342	3/32 x 1-3/4	100
12343	3/32 x 2	100
12345	3/32 x 2-1/2	100

5/32 DIAMETER		
J&B #	SIZE	QTY
12356	5/32 x 3/4	100
12357	5/32 x 1	100
12358	5/32 x 1-1/4	100
12359	5/32 x 1-1/2	100
12361	5/32 x 2	100
12363	5/32 x 2-1/2	100
12364	5/32 x 3	100

1/8 DIAMETER		
J&B #	SIZE	QTY
12346	1/8 x 1/2	100
12347	1/8 x 3/4	100
12348	1/8 x 1	100
12349	1/8 x 1-1/4	100
12350	1/8 x 1-1/2	100
12351	1/8 x 1-3/4	100
12352	1/8 x 2	100
12353	1/8 x 2-1/4	100
12354	1/8 x 2-1/2	100
12355	1/8 x 3	100

COTTER PINS

Zinc Plated

- One prong is extended for easy insertion.
- Use to lock clevis pins, slotted nuts, and other fasteners.

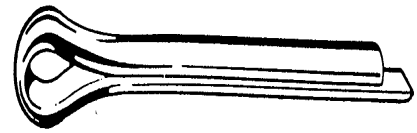

3/16 DIAMETER		
J&B #	SIZE	QTY
12365	3/16 x 3/4	100
12366	3/16 x 1	100
12367	3/16 x 1-1/4	100
12368	3/16 x 1-1/2	100
12369	3/16 x 1-3/4	100
12370	3/16 x 2	100
12371	3/16 x 2-1/4	100
12372	3/16 x 2-1/2	100
12373	3/16 x 3	100
25149	3/16 x 4	50

1/4 DIAMETER		
J&B #	SIZE	QTY
12374	1/4 x 1	50
12375	1/4 x 1-1/4	50
12376	1/4 x 1-1/2	50
12377	1/4 x 1-3/4	50
12378	1/4 x 2	50
12380	1/4 x 2-1/2	50
12381	1/4 x 3	50
12382	1/4 x 3-1/2	50
12383	1/4 x 4	50
12931	1/4 x 6	25

5/16 DIAMETER		
J&B #	SIZE	QTY
12384	5/16 x 1	50
12385	5/16 x 1-1/2	50
12386	5/16 x 2	50
12388	5/16 x 3	25
12390	5/16 x 4	25
12932	5/16 x 6	25

3/8 DIAMETER		
J&B #	SIZE	QTY
12392	3/8 x 2	25
12393	3/8 x 3	25
12394	3/8 x 3-1/2	25
12395	3/8 x 4	25
12933	3/8 x 6	25

1/2 DIAMETER		
J&B #	SIZE	QTY
12396	1/2 x 3	25
12397	1/2 x 4	25
20084	1/2 x 6	25

5/8 DIAMETER		
J&B #	SIZE	QTY
* 12399	5/8 x 6	25

* Unplated

SPRING LOCK PINS

Zinc Plated

- Chamfered ends for easier starting.
- Carbon steel construction for superior strength.
- Tap in and pin expands to grip tightly.



1/16 DIAMETER		
J&B #	LENGTH	QTY
12401	1/4	50
12406	3/8	50
12400	1/2	50
12402	3/4	50
12487	1	50

5/64 DIAMETER		
J&B #	LENGTH	QTY
12403	1/4	50
12405	1/2	50
12413	5/8	50
12407	3/4	50
12412	1	50

3/32 DIAMETER		
J&B #	LENGTH	QTY
12410	1/2	50
12411	3/4	50
12414	1	50
12485	1-1/2	50

1/8 DIAMETER		
J&B #	LENGTH	QTY
12415	3/8	50
12416	1/2	50
12417	5/8	50
12418	3/4	50
12420	1	50
12421	1-1/4	50
12422	1-1/2	50
25166	1-3/4	25
32086	2	25

5/32 DIAMETER		
J&B #	LENGTH	QTY
12423	1/2	50
12425	3/4	50
12426	1	50
12427	1-1/4	50
12428	1-1/2	25

3/16 DIAMETER		
J&B #	LENGTH	QTY
12429	1/2	50
12431	3/4	50
12432	1	25
12433	1-1/4	25
12434	1-1/2	25
12435	1-3/4	25
12436	2	25

SPRING LOCK PINS

Zinc Plated

- Chamfered ends for easier starting.
- Carbon steel construction for superior strength.
- Tap in and pin expands to grip tightly.



7/32 DIAMETER		
J&B #	LENGTH	QTY
12437	3/4	25
12438	1	25
12439	1-1/4	25
12440	1-1/2	25
12484	1-3/4	50
12442	2	25

1/4 DIAMETER		
J&B #	LENGTH	QTY
25170	5/8	50
12443	3/4	50
12444	1	25
12445	1-1/4	25
12447	1-1/2	25
12446	1-3/4	25
12448	2	25
12486	2-1/4	25
12450	2-1/2	25
12452	3	25

5/16 DIAMETER		
J&B #	LENGTH	QTY
32085	3/4	25
12466	1	25
12468	1-1/2	25
12470	2	25
12472	2-1/2	20

3/8 DIAMETER		
J&B #	LENGTH	QTY
12453	1	25
12455	1-1/2	25
12457	2	25
12459	2-1/2	20
12461	3	15

7/16 DIAMETER		
J&B #	LENGTH	QTY
12481	1-1/2	20

1/2 DIAMETER		
J&B #	LENGTH	QTY
25171	1-1/4	10
12482	1-1/2	10
25172	2	10
12483	3	10
25173	4	10

HAIRPINS

ZINC PLATED (Pictures Actual Size)

- Easily inserted and quickly removed.
- Universal usage such as on shafts, wheels, small engines, to hold washers in place.



J&B #13264



J&B #13266



J&B #13268



J&B #13270



J&B #13272



J&B #13274



J&B #13276



J&B #13254

J&B #	DRILL HOLE SIZE	WIRE DIA.	OVERALL LENGTH	QTY
13264	1/32	.028	.600	100
13266	3/64	.042	1	100
13268	1/16	.047	1-9/16	100
13270	5/64	.062	1-9/16	100
13272	5/64	.072	1-7/8	100
13274	3/32	.080	1-9/16	100
13276	7/64	.093	1-5/8	50
13254	7/64	.093	2-5/16	50

HAIRPINS

ZINC PLATED
(Pictures Actual Size)



J&B #13278



J&B #13262



J&B #13256



J&B #13280



J&B #13282

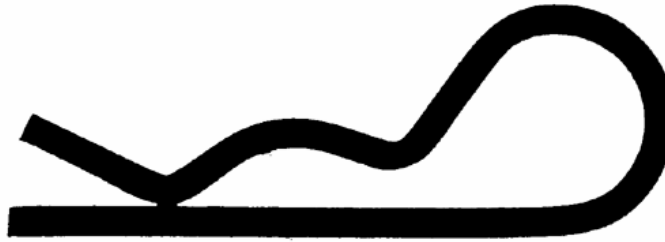

J&B #13260

J&B #	DRILL HOLE SIZE	WIRE DIA.	OVERALL LENGTH	QTY
13278	1/8	.105	1-1/4	50
13262	9/64	.125	1-15/16	50
13256	9/64	.125	2-1/2	25
13280	9/64	.125	2-7/8	25
13282	5/32	.148	2-15/16	25
13260	3/16	.177	3-3/4	10

WOODRUFF KEYS

- Low-carbon steel.
- Smooth finish for easy insertion.
- Ideal for machine repair.



J&B #	IND. #	T L	H	QTY
12586	# 2	3/32 x 1/2	3/16	25
12587	# 4	3/32 x 5/8	1/4	25
12588	# 3	1/8 x 1/2	3/16	25
12589	# 5	1/8 x 5/8	1/4	25
12590	# 6	5/32 x 5/8	1/4	25
12591	# 8	5/32 x 3/4	19/64	25
12592	#10	5/32 x 7/8	23/64	20
12593	# 9	3/16 x 3/4	19/64	25
12594	#11	3/16 x 7/8	23/64	20
12595	#13	3/16 x 1	27/64	20
12596	#91	1/4 x 3/4	19/64	20
12597	# A	1/4 x 7/8	23/64	20
12598	#15	1/4 x 1	15/32	15
12599	#18	1/4 x 1-1/8	27/64	10
12600	#21	1/4 x 1-1/4	17/32	10
12601	# B	5/16 x 1	27/64	10
12602	# C	5/16 x 1-1/8	15/32	10
12603	# D	5/16 x 1-1/4	17/32	10
12604	#152	3/8 x 1	27/64	10
12605	# E	3/8 x 1-1/4	17/32	10

WIRE ROPE

WIRE ROPE CLIPS

Zinc Plated

- Hot dip galvanized; malleable iron.
- Accurately formed wire rope channels on saddle eliminates damage to cable.



J&B #	SIZE	QTY
13223	1/8	10
13224	3/16	10
13226	1/4	10
13227	5/16	10
13228	3/8	10
13230	1/2	10
13232	5/8	5
13233	3/4	5

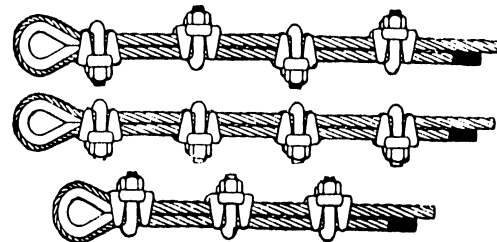

To give adequate holding force, U-bolt clips must be spaced along the rope at equal intervals. . . usually at a distance of six wire-rope diameters. Before the rope is placed under tension, the nuts are tightened. But after the load is applied to the rope, the nuts must be tightened again.

THIMBLES

- Carbon steel; hot galvanized.
- Recommended for light duty service.

J&B #	SIZE (ROPE DIA.)	APPROX. LENGTH OVERALL	MIN. INSIDE WIDTH	QTY
41490	1/8	1-3/4	11/16	10
41491	3/16	1-3/4	11/16	10
41492	1/4	1-7/8	11/16	10
41493	5/16	2	13/16	10
41494	3/8	2-1/2	25/32	10
41496	1/2	3	1-1/8	10



OVAL CABLE SLEEVES

J&B #	SIZE	QTY
V56990	1/8	50
V56991	3/16	50
56992	1/4	10



LINKAGE HARDWARE

ANCHOR SHACKLES

With Screw Pin

- Zinc plated.
- GR30.

J&B #	SIZE	PIN DIAMETER	WORKING LOAD LIMIT	QTY
41527	1/4	5/16	400 LB	5
41521	5/16	3/8	700 LB	5
41522	3/8	7/16	1000 LB	5
41523	1/2	1/2	2000 LB	5
41524	5/8	5/8	3000 LB	5
41525	3/4	3/4	4000 LB	5



ANCHOR SHACKLES

With Clevis Pin

- Drop forged carbon steel.
- Self colored.
- Safe working load permanently shown on each shackle.

J&B #	SIZE	PIN DIAMETER	WORKING LOAD LIMIT	QTY
41435	3/8	7/16	1 TON	5



SWIVEL SAFETY HASP

- Zinc plated.

J&B #	SIZE	QTY
V56985	4-1/2"	EA



LINKAGE HARDWARE

SNAP PINS

- Quick connect and disconnect offers thousands of applications on equipment, shafts and trailers.
- Headed shank formed of 1010 carbon steel, retainer wire formed of MB spring steel.
- Zinc plated for corrosion resistance.

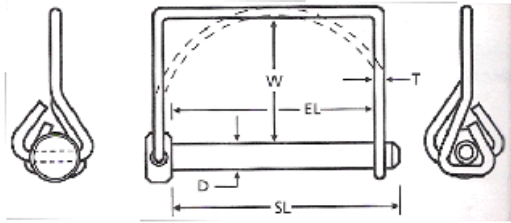

Square Handle

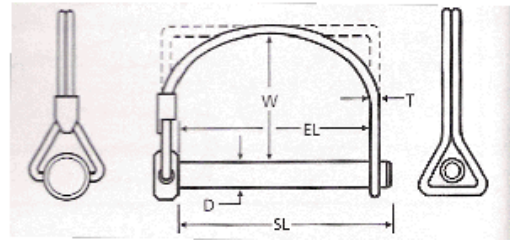

Round Handle

J&B #	NOMINAL (D)	EFFECTIVE LENGTH (EL)	SHANK LENGTH (SL)	WIRE CLEARANCE (W)	WIRE DIA. (T)	HANDLE STYLE	QTY
41055	1/4	1-3/8	1-5/8	1.625	.091	Round	5
41054	1/4	2-1/4	2-1/2	1.625	.091	Square	5
41056	5/16	2-1/4	2-1/2	1.75	.091	Square	5
41061	3/8	2-1/4	2-1/2	1.50	.091	Square	5

HITCH PINS

- Red plastisol coated head, Heavy duty, made of high tensile strength, heat treated.
- Includes hairpin.



J&B #	SHAFT DIAMETER	USEABLE LENGTH	QTY
41483	3/8	4"	6
41484	1/2	3-5/8"	6
41485	5/8	5-1/2"	6
41486	3/4	6-1/2"	6

LINKAGE HARDWARE

LYNCH PINS

- Forged, gold dichromate plating.
- Quick disconnect fastener.

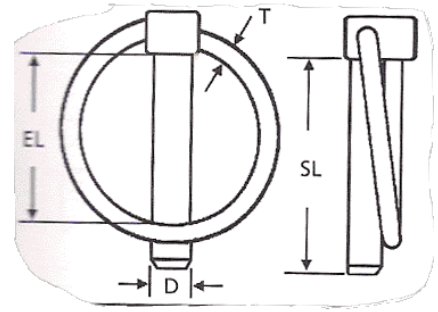

J&B #	NOMINAL (D)	EFFECTIVE LENGTH (EL)	SHANK LENGTH (SL)	WIRE DIAMETER (T)	QTY
41057	3/16	1"	1-1/4	.118	10
41062	3/16	1-1/4	1-9/16	.138	10
41063	1/4	1-1/4	1-9/16	.138	10
41059	1/4	1-5/16	1-3/4	.138	10
41066	5/16	1-1/4	1-9/16	.138	10
41064	5/16	1-3/8	1-3/4	.138	10
41060	7/16	1-5/8	1-15/16	.138	10
*41065	7/16	1-3/4	2-1/4	.177	10

*plain

BOLT SNAP

- Swiveling round eye. Polished solid bronze.



J&B #	SIZE	DESCRIPTION	OPENING	QTY
R51339	3-5/32	3/4 Round swivel eye	3/8	EA

SNAP LINK

- Malleable iron with zinc finish.

J&B #	SIZE	QTY
41050	1/4	10
41051	5/16	10
41052	3/8	10
41044	7/16	10
41045	1/2	10
41047	5/8	10



LINKAGE HARDWARE

CLEVIS GRAB HOOKS

Grade 43



Grade 70



WORKING LOAD LIMIT MUST NOT BE EXCEEDED

- Forged Steel. Zinc plated finish
- Forged Steel. Yellow chromate finish
- Transport Grade

J&B #	CHAIN SIZE	WORKING LOAD LIMIT - LBS.	QTY
38710	1/4	2,600	EA
38711	5/16	3,900	EA
38712	3/8	5,400	EA

J&B #	CHAIN SIZE	WORKING LOAD LIMIT - LBS.	QTY
57038	1/4	3,150	EA
57039	5/16	4,700	EA
57046	3/8	6,600	EA
38713	1/2	11,300	EA

CLEVIS SLIP HOOKS

Grade 43

- Forged Steel. Zinc plated finish.

J&B #	CHAIN SIZE	WORKING LOAD LIMIT - LBS.	QTY
R52058	1/4	2,600	EA
R52059	5/16	3,900	EA
R52060	3/8	5,400	EA



5/16 & 3/8 with latch



1/4 without latch

LINKAGE HARDWARE

UNIVERSAL CLEVIS PINS

Zinc Plated

J&B #	SIZE	QTY
13185	1/4 x 2	10
13186	5/16 x 2	10
13187	3/8 x 2	10
13188	7/16 x 2	10
13189	1/2 x 2	10
38960	5/8 x 3	5
38961	3/4 x 3	5



* Length is under the head to the end of pin.

STANDARD CLEVIS PINS

Zinc Plated



* Length is under the head to the end of pin.

J&B #	SIZE	QTY
37480	3/16 x 1/2	10
37481	3/16 x 3/4	10
37482	3/16 x 1	10
37483	3/16 x 1-1/2	10

J&B #	SIZE	QTY
37486	1/4 x 3/4	10
37500	1/4 x 1	10
37501	1/4 x 1-1/4	10
37502	1/4 x 1-1/2	10
37450	1/4 x 1-3/4	10
37451	1/4 x 2	10

J&B #	SIZE	QTY
37506	5/16 x 1	10
37507	5/16 x 1-1/4	10
37508	5/16 x 1-1/2	10
37456	5/16 x 1-3/4	10
37457	5/16 x 2	10

J&B #	SIZE	QTY
37525	5/8 x 2	10
37526	5/8 x 3	10

J&B #	SIZE	QTY
37512	3/8 x 1	10
37513	3/8 x 1-1/4	10
37514	3/8 x 1-1/2	10
37462	3/8 x 1-3/4	10
37463	3/8 x 2	10
37464	3/8 x 2-1/4	10
37465	3/8 x 2-1/2	10

J&B #	SIZE	QTY
37490	7/16 x 1-1/4	10
37524	7/16 x 1-1/2	10
37469	7/16 x 2	10
37470	7/16 x 2-1/2	10

J&B #	SIZE	QTY
40505	1/2 x 1-1/2	10
37473	1/2 x 1-3/4	10
37474	1/2 x 2	10
37475	1/2 x 2-1/4	10
37498	1/2 x 2-1/2	10
37499	1/2 x 3	10

J&B #	SIZE	QTY
39031	3/4 x 3	5

BRAKE CHAMBER YOKE

J&B #	DESCRIPTION	QTY
40500	5/8-18 NF Thread 1 29/32" Length 1/2" Pin Hole	10



* Use Clevis pin 40505 for brake chamber yoke

CHAIN HARDWARE

DOUBLE CLEVIS LINKS

- Designed for linking all popular sizes of chain to rings, end links, eye hooks, pad eyes, tractor eyebolts, etc.
- Pin can be removed with pliers or screwdriver.
- All pins alloy steel, quenched and tempered.

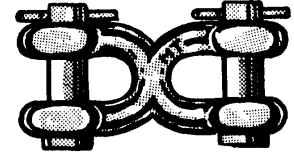
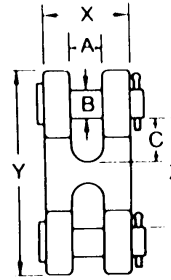

J&B #	CHAIN SIZE HIGH TEST GRADE 43	CHAIN SIZE TRANSPORT GRADE 70	A	B	C	X	Y	Z	WORK LOAD LIMIT	QTY
41502	1/4 or 5/16	1/4	13/32	3/8	7/16	1-1/8	2-5/8	1-5/16	3,900	2

COLD SHUTS

- Zinc plated.

J&B #	SIZE OF CHAIN	WORK LOAD LIMIT	QTY
41518	1/4	800	10
41519	5/16	1,300	10
41520	3/8	1,900	10

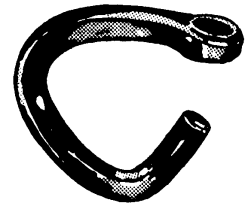

QUICK LINK

- Beveled hex nut. Steel with zinc finish.

J&B #	SIZE	WORK LOAD LIMIT	QTY
R79101	1/8	220 LBS	EA
R52622	3/16	660 LBS	EA
R52623	1/4	880 LBS	EA
R52624	5/16	1,760 LBS	EA
R52625	3/8	2,200 LBS	EA
R52604	1/2	3,300 LBS	EA

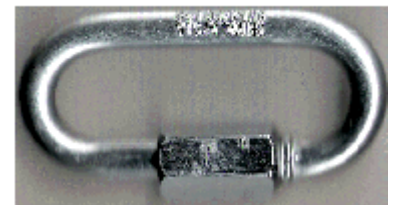

CHAIN

ASA STANDARD ROLLER CHAIN

- For chain drive power transmission.
- The finest quality imported roller chain with longer wear life and higher resistance to fatigue.
- Connecting parts are made to American standard specifications.
- One connecting link furnished.

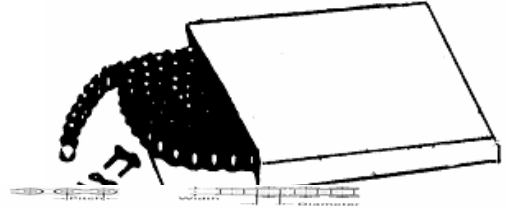

ASA NO.	J&B #	PITCH IN INCHES	ROLLER IN INCHES		TENSILE STRENGTH	QTY
			WIDTH	DIAMETER		
40	38944	1/2	5/16	.156	3700	10 FT.
50	39006	5/8	3/8	.400	6100	10 FT.
60	39007	3/4	1/2	15/16	8500	10 FT.
80	39008	1	5/8	5/8	14500	10 FT.

CONNECTING LINKS

- Connecting links are inserted between sections (10 Ft.) of roller chain.



J&B #	INDUSTRIAL #	QTY
13478	#35	4
13480	#40	4
13479	#41	4
13481	#50	4
13482	#60	3
13491	#80	2

OFFSET LINKS

- Offset links are used to adjust the length of the chain.



J&B #	INDUSTRIAL #	QTY
13486	#35	4
13483	#40	4
13487	#41	4
13484	#50	4
13485	#60	3
13492	#80	2

Replacement links fit specified chain size requirements for repairs on:

- Smaller farm machinery
- Small tractors, tillers
- Printing presses, conveyors
- Cement mixers, washing machines
- Motorcycles and mini-bikes
- Bicycles and Go-Carts
- Industrial Machines
- Aqua-Cats, lawn mowers

HARDWARE

COMMON NAILS

- Bright smooth shank.



J&B #	SIZE	LENGTH	QTY
46450	4D	1-1/2	1 lb
46451	6D	2"	1 lb
46452	8D	2-1/2	1 lb
46453	10D	3"	1 lb
46454	12D	3-1/4	1 lb
46455	16D	3-1/2	1 lb
46456	20D	4"	1 lb

*Cannot break a box

HEAVY OPEN S HOOKS

- Zinc plated steel.
- Do not use for overhead lifting, support of human weight, athletic or playground equipment. When safety is involved, consult the manufacturer.



J&B #	SIZE	WEIGHT LIMIT	DIAMETER	UNIT WEIGHT	QTY
46400	1"	20 lbs.	1/8	.006	50
46401	1-1/2"	40 lbs.	3/16	.021	50
46402	2"	125 lbs.	1/4	.064	25
46403	2-1/2"	140 lbs.	5/16	.108	25

SCREW HOOKS

- Zinc plated steel.
- Do not use for overhead lifting, support of human weight, athletic or playground equipment. When safety is involved, consult the manufacturer.



J&B #	SIZE	WEIGHT LIMIT	QTY
70020	1/4 x 4-1/4	60 lbs.	10
70021	5/16 x 4-1/2	115 lbs.	10
70022	3/8 x 4-7/8	150 lbs.	10

RIVETS

DOMED HEAD

- Aluminum rivets have a polished and sealed finish.
- Steel mandrels are plain with a corrosion protective coating.



ALUMINUM DOME / ALUMINUM MANDREL				
J&B #	DIA. X LENGTH	DRILL #	GRIP RANGE	QTY
13319	1/8 x .275	#30	1/16 to 1/8	250
13322	1/8 x .400	#30	3/16 to 1/4	250
32091	1/8 x .462	#30	1/4 to 5/16	250
13323	1/8 x .525	#30	5/16 to 3/8	250
12260	1/8 x .650	#30	3/8 to 1/2	250
13326	5/32 x .425	#20	3/16 to 1/4	250
13330	3/16 x .450	#11	1/8 to 1/4	250
13332	3/16 x .575	#11	1/4 to 3/8	250
13334	3/16 x .700	#11	3/8 to 1/2	250
32116	3/16 x .950	#11	5/8 to 3/4	250
32127	3/16 x 1.075	#11	3/4 to 7/8	250
39015	1/4 x .625	F	1/4 to 3/8	100

STEEL DOME / STEEL MANDREL				
J&B #	DIA. X LENGTH	DRILL #	GRIP RANGE	QTY
13317	1/8 x .275	#30	1/16 to 1/8	250
13320	1/8 x .400	#30	3/16 to 1/4	250
12262	1/8 x .525	#30	5/16 to 3/8	250
12263	1/8 x .650	#30	3/8 to 1/2	250
32092	3/16 x .325	#11	1/16 to 1/8	250
32093	3/16 x .450	#11	3/16 to 1/4	250
32094	3/16 x .575	#11	1/4 to 3/8	250
32095	3/16 x .700	#11	3/8 to 1/2	250
32096	1/4 x .625	F	1/4 to 3/8	100
32097	1/4 x .750	F	3/8 to 1/2	100

DOMED HEAD (Large Flange)



ALUMINUM DOME / ALUMINUM MANDREL				
J&B #	DIA. X LENGTH	DRILL #	GRIP RANGE	QTY
13337	3/16 x .575	#11	1/4 to 3/8	250
13338	3/16 x .700	#11	3/8 to 1/2	250
39018	3/16 x .950	#11	5/8 to 3/4	250

STEEL DOME / STEEL MANDREL				
J&B #	DIA. X LENGTH	DRILL #	GRIP RANGE	QTY
12269	3/16 x .700	#11	3/8 to 1/2	250

RIVET CHART

(ACTUAL SIZES)

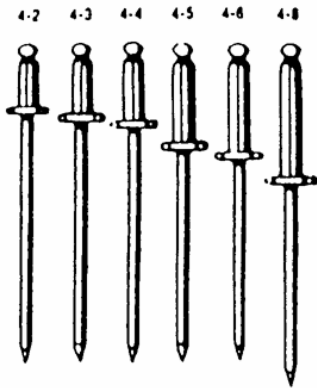

1/8 Diameter

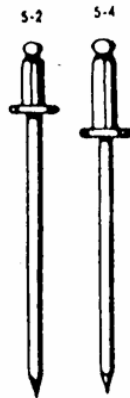

5/32 Diameter

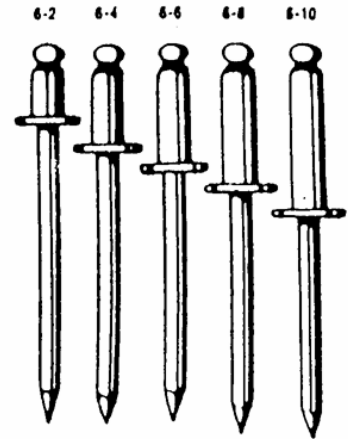

3/16 Diameter

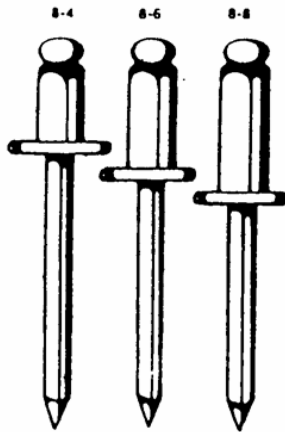

1/4 Diameter

COUNTERSUNK HEAD



1/8 Diameter

LARGE FLANGE

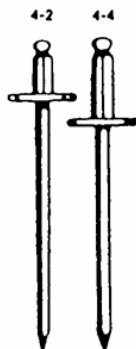

1/8 Diameter

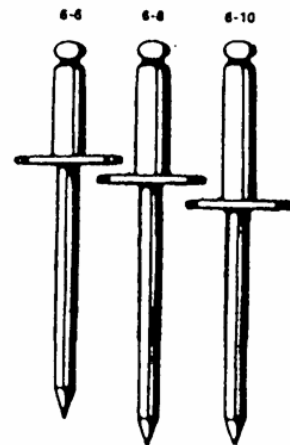

3/16 Diameter

RIVETS

STRUCTURAL - SELF-PLUGGING RIVETS

- **HIGH CLAMP-UP:** The T Rivet will draw sheets firmly together, even when separated by as much as 3/16".
- **NON-CRITICAL HOLE SIZE:** The T Rivet will function properly in holes as much as 1/32" oversize.
- **EXTREMELY HIGH SHEAR AND TENSILE STRENGTH:** The hardened mandrel in the T Rivet provides high tensile strength and shear values comparable to solid rivets or machine screws.

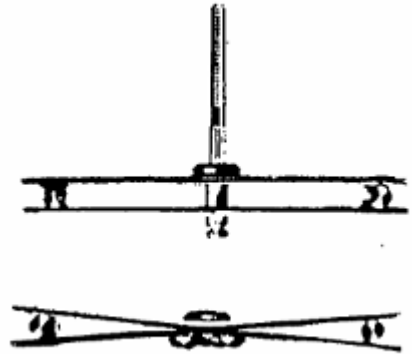

J&B #	GRIP RANGE	DESCRIPTION	QTY	
39196	.030 / .140	Window Regulator Rivet	25	
39194	090 / .115	Outside Door Handle Rivet	25	

"PEEL TYPE" RIVET

J&B #	MAKE & YR	PANEL RANGE	HOLE DIA	QTY	
41879	GM, FORD, CHRYSLER 71-ON	1/32 – 9/64	1/4	50	
41881	GM, FORD, CHEVY 76-ON	33/64 – 19/32	1/4	25	

"SPLIT-TYPE" RIVET

J&B #	MAKE & YR	PANEL RANGE	HOLE DIA	QTY	
45904	FORD 92' -On CHRYSLER 92 - On	3/16 - 3/8	1/4	25	

RIVETS

BACK UP WASHERS

- Use with domed head rivets.
- Use when fastening soft materials or to compensate for oversize holes.

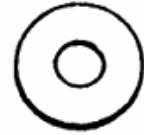

J&B #	MATERIAL	HOLE SIZE	DIAMETER	QTY
39010	STEEL	1/8	3/8	250
39011	STEEL	3/16	1/2	250
39012	ALUM	1/8	3/8	250
39013	ALUM	3/16	1/2	250

NYLON BLIND RIVET

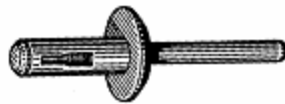

J&B #	AUVECO #	MAKE & YR	PANEL RANGE	HOLE DIA	QTY
45830	13747	GM, FORD	1/16 – 11/64	13/64	25
45834	13752	GM	3/32 – 3/16	17/64	25
42098	13753	GM	3/32 – 3/16	17/64	25
45832	13751	GM, FORD, CHRY	5/32 – 13/32	1/4	25
41842	13750	GM, FORD, CHRY	5/32 – 13/32	1/4	25
45836	13755	CHRY	15/64 – 25/64	13/64	25
40914	17101	CHRY, FORD	5/16 – 15/32	1/4	25

ALUMINUM SPLIT-TYPE RIVET





J&B #	AUVECO #	MAKE & YR	GRIP RANGE	FLANGE DIA	DIA	QTY
45858	16864	APV Vans 90' - On	3/64 – 11/32	3/8	3/16	25
45860	17121	GM, FORD	5/64 – 15/64	7/16	3/16	25
59127	14127	FORD 82' - On	3/8 – 1/2	9/16	3/16	25

RIVETS

ALUMINUM SPLIT-TYPE RIVET

Black

J&B #	MAKE & YR	GRIP RANGE	FLANGE DIA	DIA	QTY
59134	Ford T-Bird & Mercury cougar 89-on 	1/8 – 3/16	3/8	1/8	50
59136	Bumper Fascia & General Purpose GM 1990-on 	3/64 – 23/64	5/8	3/16	25

RIVETS

HEAVY DUTY LEVER RIVET GUN RivetKing

- Full capacity riveting tool capable of setting full range of blind rivet sizes from 1/8" (nose piece sold separately), 5/32", 3/16" and 1/4".
- The geared head design reduces operator effort and fatigue.
- Nose pieces are stored onboard for easy accessibility (5/32", 3/16" & 1/4").



J&B #	QTY
1808	EA

HEAVY DUTY PISTOL RIVET GUN RivetKing

- Full capacity riveting tool capable of setting full range of blind rivet sizes up to 5/32" and 3/16" materials excluding high force or structural rivets).
- The best in manual squeeze riveting.
- Nose pieces are stored onboard for easy accessibility (3/32", 1/8", 5/32" & 3/16").

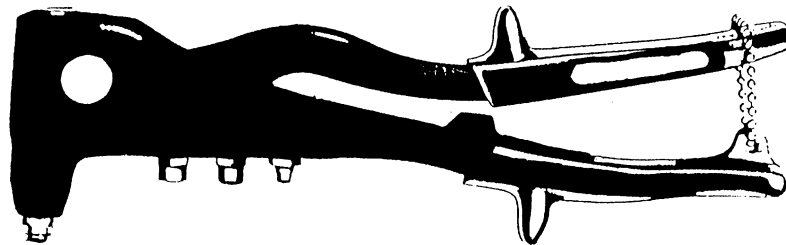

J&B #	QTY
1404	EA

RIVETS

PNEUMATIC RIVET GUN RivetKing

- Economy grade pneumatic rivet gun for use on all materials.
- For use on 3/32", 1/8", 5/32" and 3/16" rivets.
- Comes with nose pieces for all the above sizes.

J&B #	MODEL#	QTY
24235	RK-187	EA

- Max. air pressure: 90 PSI * Traction power: 1980 lbs *
Stroke: .625" * Air consumption: .017 CuFt. * Min.
Hose Size: 3/8" ID * Air inlet: 1/4" NPT * Net Weight:
3.3 lbs.



RUBBER 'O' RINGS

- O-Rings effectively resist petroleum-based oils, most silicone fluids, hydraulic, and nonaromatic fuels and solvents.
- Excellent working properties such as low compression set, high tensile strength, and high abrasion resistance.
- Has excellent compression set. Temperature range -65° to +275°.
- Material is Buna N. Durometer is 70.

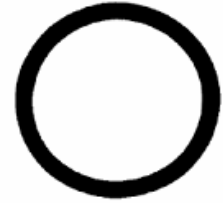

O-RING CROSS REFERENCE

All "O" Rings are manufactured to commercial 6227 specifications for hydraulic use. The OR-number shown is an industry wide numbering system and is used in conjunction with the spec number i.e. 6227-1.

1/16" DIAMETER					
J&B #	I. D.	O. D.	NAT. #	ARP #	QTY
12606	1/8	1/4	OR-1	ARP-006	25
12607	5/32	9/32	OR-2	ARP-007	25
12608	3/16	5/16	OR-3	ARP-008	25
12609	7/32	11/32	OR-4	ARP-009	25
12610	1/4	3/8	OR-5	ARP-010	25
12611	5/16	7/16	OR-6	ARP-011	25
12612	3/8	1/2	OR-7	ARP-012	25
39900	7/16	9/16		ARP-013	15
39901	1/2	5/8		ARP-014	15
39902	9/16	11/16		ARP-015	15
39903	5/8	3/4		ARP-016	15
39904	11/16	13/16		ARP-017	15
39905	3/4	7/8		ARP-018	15
39906	13/16	15/16		ARP-019	15
39907	7/8	1		ARP-020	15
39908	15/16	1-1/16		ARP-021	15
39909	1	1-1/8		ARP-022	10
39910	1-1/8	1-1/4		ARP-024	10
39911	1-1/4	1-3/8		ARP-026	10
39912	1-3/8	1-1/2		ARP-028	10
39913	1-1/2	1-5/8		ARP-029	10
39914	1-5/8	1-3/4		ARP-030	5
39915	1-3/4	1-7/8		ARP-031	5
39916	1-7/8	2		ARP-032	5

RUBBER 'O' RINGS

O-RING CROSS REFERENCE

3/32" DIAMETER					
J&B #	I. D.	O. D.	NAT. #	ARP #	QTY
12613	3/8	9/16	OR- 8	ARP-110	25
12614	7/16	5/8	OR- 9	ARP-111	25
12615	1/2	11/16	OR-10	ARP-112	25
12616	9/16	3/4	OR-11	ARP-113	10
12617	5/8	13/16	OR-12	ARP-114	10
12618	11/16	7/8	OR-13	ARP-115	10
12619	3/4	15/16	OR-14	ARP-116	10
39940	13/16	1		ARP-117	10
39941	7/8	1-1/16		ARP-118	10
39942	15/16	1-1/8		ARP-119	10
39943	1	1-3/16		ARP-120	10
39944	1-1/16	1-1/4		ARP-121	10
39945	1-1/8	1-5/16		ARP-122	10
39946	1-3/16	1-3/8		ARP-123	10
39947	1-1/4	1-7/16		ARP-124	10
39948	1-3/8	1-9/16		ARP-126	5
39949	1-1/2	1-11/16		ARP-128	5
39950	1-5/8	1-13/16		ARP-130	5
39951	1-3/4	1-15/16		ARP-132	5
39952	1-7/8	2-1/16		ARP-134	5
39953	2	2-3/16		ARP-136	5

1/8" DIAMETER					
J&B #	I. D.	O. D.	NAT. #	ARP #	QTY
39986	11/16	15/16	OR-15	ARP-209	10
12620	3/4	1	OR-16	ARP-210	10
12621	13/16	1-1/16	OR-17	ARP-211	10
12622	7/8	1-1/8	OR-18	ARP-212	10
12623	15/16	1-3/16	OR-19	ARP-213	10
12624	1	1-1/4	OR-20	ARP-214	10
12625	1-1/16	1-5/16	OR-21	ARP-215	10
12626	1-1/8	1-3/8	OR-22	ARP-216	10
12627	1-3/16	1-7/16	OR-23	ARP-217	10
12628	1-1/4	1-1/2	OR-24	ARP-218	10
12629	1-5/16	1-9/16	OR-25	ARP-219	10
12630	1-3/8	1-5/8	OR-26	ARP-220	10
12631	1-7/16	1-11/16	OR-27	ARP-221	10
12632	1-1/2	1-3/4		ARP-222	10
39980	1-5/8	1-7/8		ARP-223	5
39981	1-3/4	2		ARP-224	5
39982	1-7/8	2-1/8		ARP-225	5
39983	2	2-1/4		ARP-226	5
39984	2-1/8	2-3/8		ARP-227	5
39985	2-1/4	2-1/2		ARP-228	5

RUBBER 'O' RINGS

O-RING CROSS REFERENCE

3/16" DIAMETER					
J&B #	I. D.	O. D.	NAT. #	ARP #	QTY
12633	1-1/2	1-7/8	OR-28	ARP-325	10
12634	1-5/8	2	OR-29	ARP-326	10
12635	1-3/4	2-1/8	OR-30	ARP-327	10
13448	1-7/8	2-1/4	OR-31	ARP-328	5
13449	2	2-3/8	OR-32	ARP-329	5
13450	2-1/8	2-1/2	OR-33	ARP-330	5
13451	2-1/4	2-5/8	OR-34	ARP-331	5
13452	2-3/8	2-3/4	OR-35	ARP-332	5
13453	2-1/2	2-7/8	OR-36	ARP-333	5
13454	2-5/8	3	OR-37	ARP-334	5
13455	2-3/4	3-1/8	OR-38	ARP-335	5
13456	2-7/8	3-1/4	OR-39	ARP-336	5
13457	3	3-3/8	OR-40	ARP-337	5

RUBBER 'O' RINGS

1/16" WIDTH



12606	QTY. 25
1/8 ID	1/4 OD

12607	QTY. 25
5/32 ID	9/32 OD

12608	QTY. 25
3/16 ID	5/16 OD

12609	QTY. 25
7/32 ID	11/32 OD



12610	QTY. 25
1/4 ID	3/8 OD

12611	QTY. 25
5/16 ID	7/16 OD

12612	QTY. 25
3/8 ID	1/2 OD

RUBBER 'O' RINGS

3/32" WIDTH



12613	QTY. 25
3/8 ID	9/16 OD

12614	QTY. 25
7/16 ID	5/8 OD

12615	QTY. 25
1/2 ID	11/16 OD

12616	QTY. 10
9/16 ID	3/4 OD



12617	QTY. 10
5/8 ID	13/16 OD

12618	QTY. 10
11/16 ID	7/8 OD

12619	QTY. 10
3/4 ID	15/16 OD

1/8" WIDTH



12620	QTY. 10
3/4 ID	1" OD

12621	QTY. 10
13/16 ID	1-1/16 OD

12622	QTY. 10
7/8 ID	1-1/8 OD

12623	QTY. 10
15/16 ID	1-3/16 OD

RUBBER 'O' RINGS

1/8" WIDTH



12624	QTY. 10
1" ID	1-1/4 OD



12625	QTY. 10
1-1/16 ID	1-5/16 OD

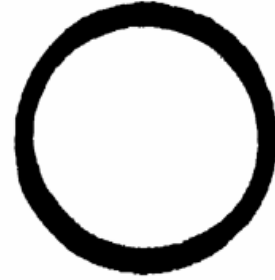

12626	QTY. 10
1-1/8 ID	1-3/8 OD

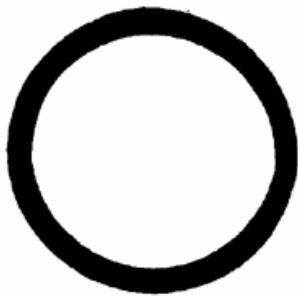

12627	QTY. 10
1-3/16 ID	1-7/16 OD

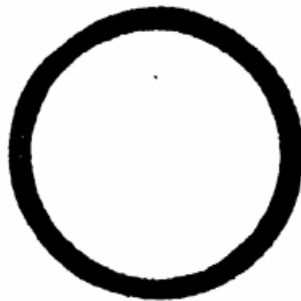

12628	QTY. 10
1-1/4 ID	1-1/2 OD

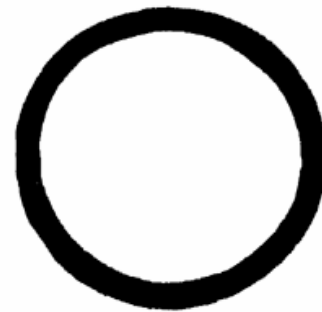

12629	QTY. 10
1-5/16 ID	1-9/16 OD



12630	QTY. 10
1-3/8 ID	1-5/8 OD

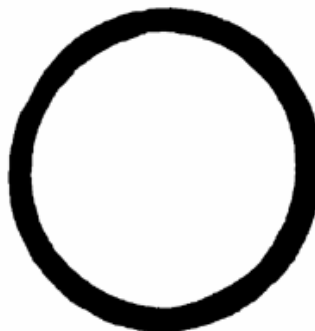

12631	QTY. 10
1-7/16 ID	1-11/16 OD

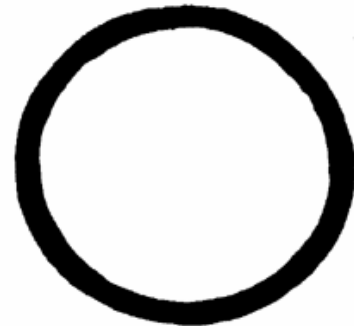

12632	QTY. 10
1-1/2 ID	1-3/4 OD

RUBBER 'O' RINGS

3/16" WIDTH

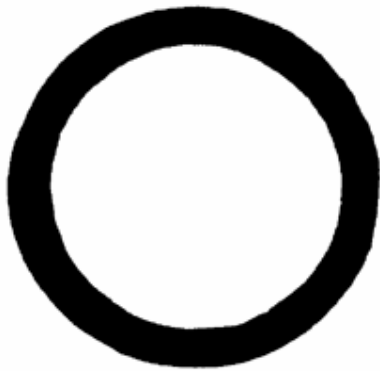

12633	QTY. 10
1-1/2 ID	1-7/8 OD



12634	QTY. 10
1-5/8 ID	2" OD

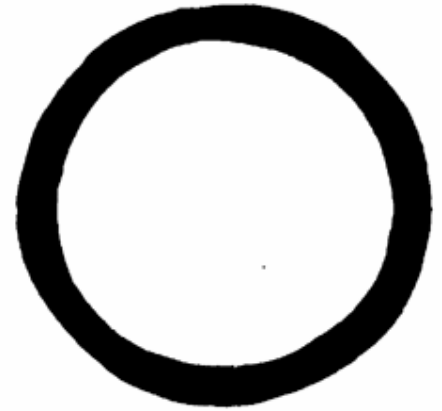

12635	QTY. 10
1-3/4 ID	2-1/8 OD

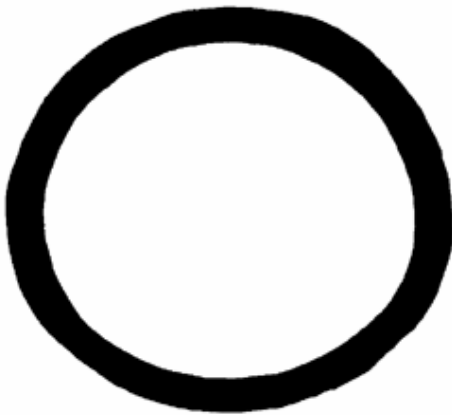

13448	QTY. 5
1-7/8 ID	2-1/4 OD

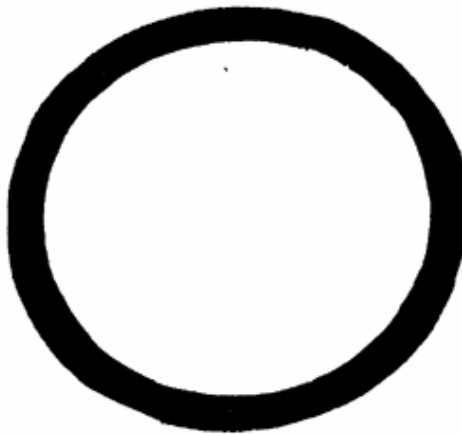

13449	QTY. 5
2" ID	2-3/8 OD

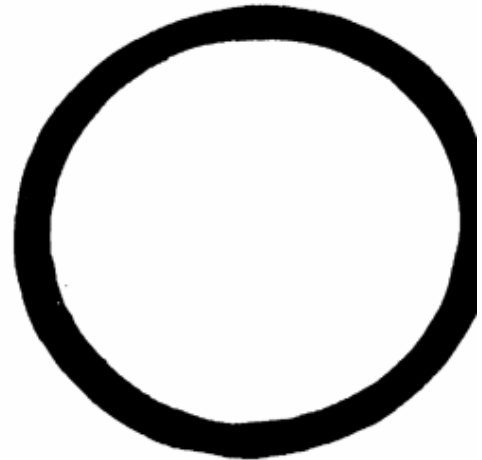

13450	QTY. 5
2-1/8 ID	2-1/2 OD

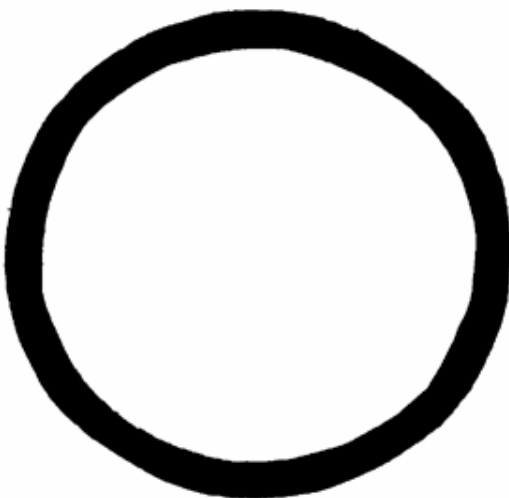

13451	QTY. 5
2-1/4 ID	2-5/8 OD

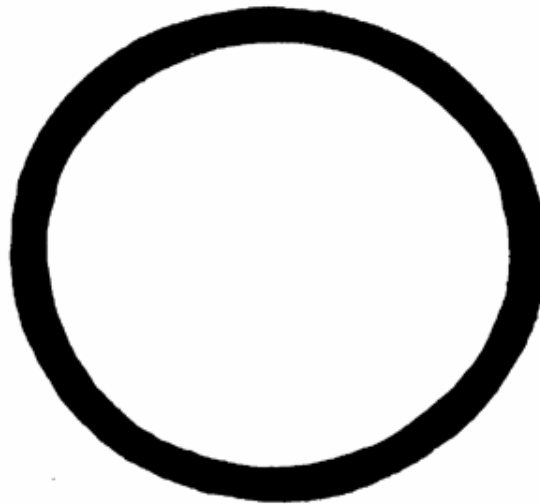

13452	QTY. 5
2-3/8 ID	2-3/4 OD



RUBBER 'O' RINGS

3/16" WIDTH

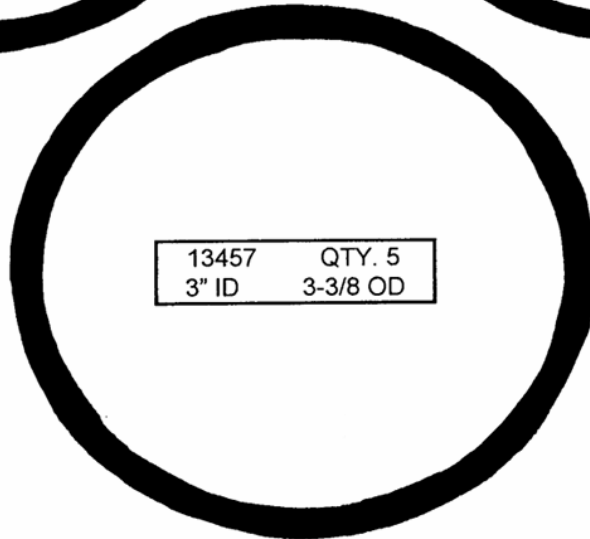
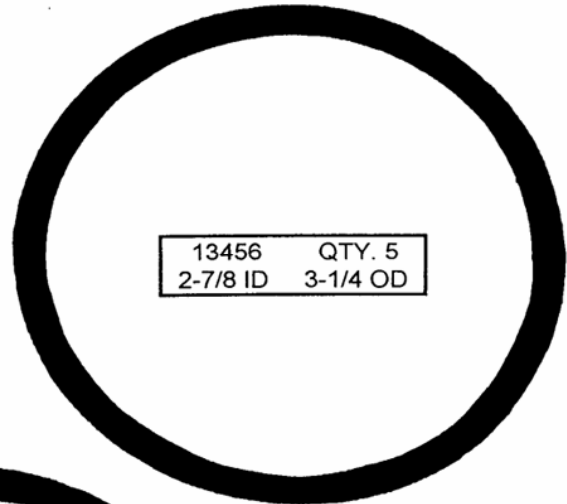
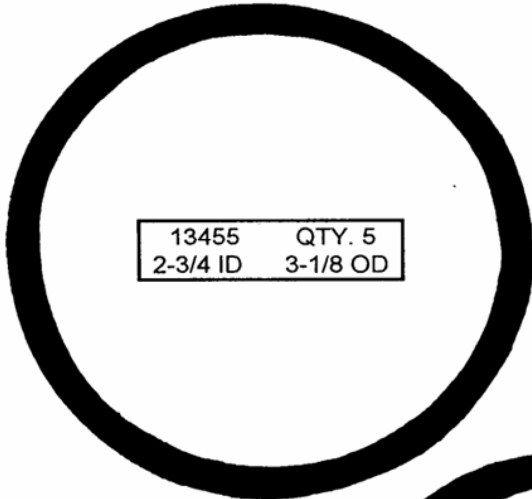
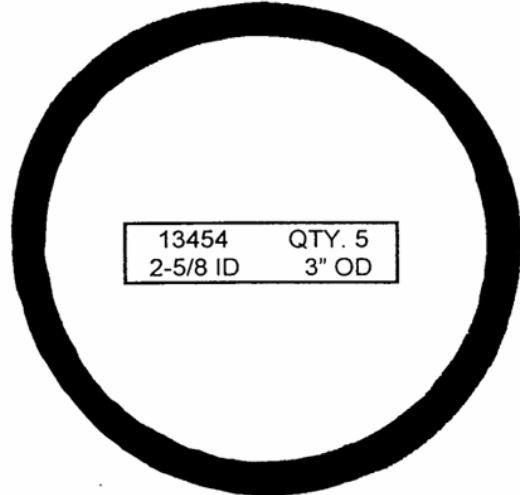
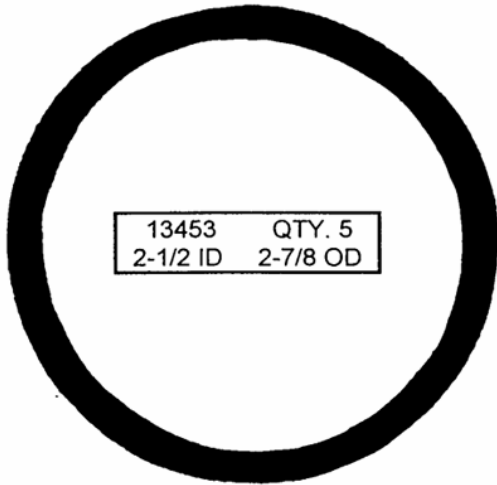

RUBBER 'O' RINGS

SIZING CHART

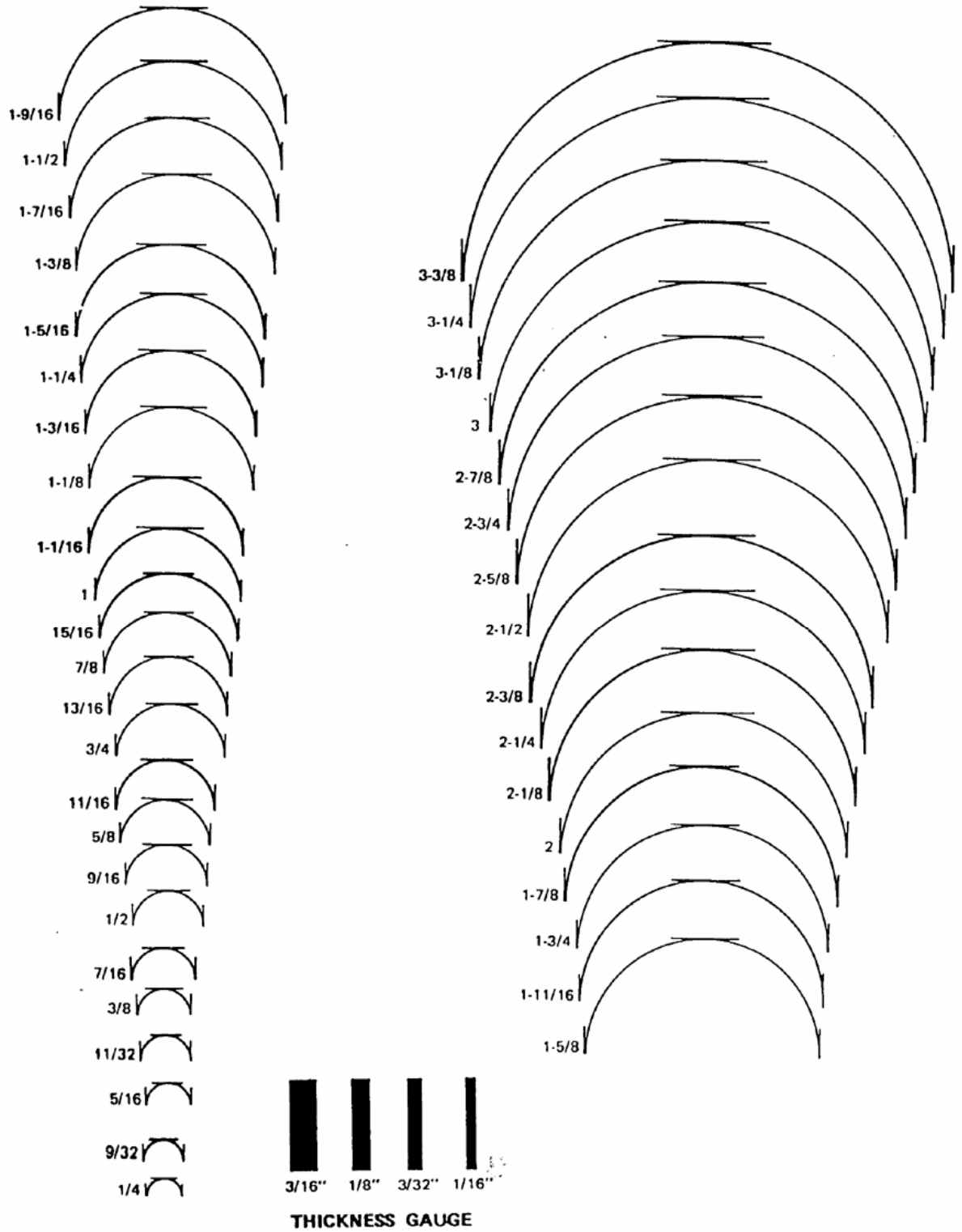

RUBBER 'O' RINGS

HNBR O-RING ASSORTMENT High Temperature

- 270 piece kit contains 18 popular o-ring sizes.
- Hydrogenated Nitrile Butadiene Rubber (HNBR), also known as Highly Saturated Nitrile (HSN) is a special class of nitrile rubber & is for mission critical applications.
- Temperature range of -49 F (-45 C) to 329 F (165 C).
- HNBR is classified by ASTM as DH-type polymer.
- Suitable for many hydrocarbons, fats, oils, gas, etc..
- **NOT SUITABLE FOR USE WITH BRAKE FLUIDS.**
- Good Abrasion resistance & resistant to compression.
- High Tensile strength.



I/D	Section	I/D	Section
7/32	1/16	7.8	1.9
1/4	1/16	8.8	1.9
5/16	1/16	13.9	1.9
7/16	1/16	8	2
11/16	1/16	11	2
7/16	3/32	12	2
9/16	3/32	14	2
11/16	1/8	15	2
6.8	1.9	17	2

J&B #	QTY
2283	EA

**O-RING ASSORTMENTS...
SEE PAGES 2546 – 2549 & PAGE 2592**

METRIC O-RINGS LOCATED ON PAGE 2549

RUBBER 'O' RINGS

O-RING SPLICING KIT

- Makes any size O-ring from cord or wrong size keys.
- Eliminates delays from out-of-stock situations.
- Works with most ring materials.
- Replaces rings without machine disassembly.

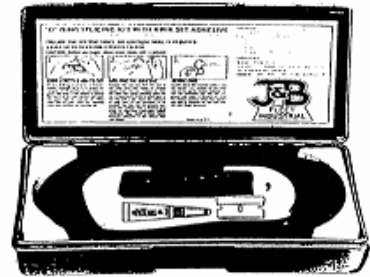

J&B #	QTY
38800	EA

REPLACEMENT BUNA-N CORD STOCK

J&B #	DIAMETER	LENGTH	QTY
39045	3/32	3'	EA
39046	1/8	3'	EA
39047	3/16	3'	EA
39048	1/4	3'	EA



RUBBER GROMMETS

- For protecting and insulating automotive and industrial wiring, cables, tubing, etc., installed through metal paneling.
- Used to prevent vibration, wire or tubing damage, and shorts.

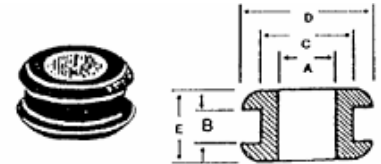

J&B #	A BORE DIAMETER	B GROOVE WIDTH	C GROOVE DIAMETER	D OUTSIDE DIAMETER	E OVERALL THICKNESS	QTY
38201	1/8	3/32	3/8	1/2	5/16	25
38172	5/32	1/16	1/4	3/8	3/16	25
38202	3/16	1/16	5/16	1/2	1/4	25
38173	3/16	1/4	5/16	7/16	3/8	25
38204	1/4	1/16	7/16	5/8	3/16	25
38205	1/4	1/16	1"	1-1/4	1/4	25
38206	5/16	1/16	9/16	13/16	5/16	25
38207	5/16	1/8	9/16	13/16	3/8	25
38208	5/16	1/4	9/16	13/16	1/2	25
38209	3/8	1/16	1/2	5/8	9/32	25
38210	3/8	1/16	1"	1-1/4	1/4	25
38213	1/2	3/32	3/4	31/32	9/32	25
38216	1/2	1/4	13/16	1-1/16	1/2	25
38217	5/8	1/8	7/8	1-1/8	3/8	25
38218	5/8	1/16	7/8	1-1/8	5/16	25
38220	3/4	1/16	1-1/16	1-3/8	3/8	25
38221	3/4	1/16	1-1/4	1-5/8	1/4	25
38222	3/4	1/4	1-1/4	1-5/8	7/16	25

RETAINING RINGS

INTERNAL SNAP TYPE

(Rings Actual Size)

- Internal rings fit in a groove in the housing bore.
- Unlimited universal applications: Industrial, power equipment, cars, trucks, garden equipment.



#10638 QTY. 50
1/4" Housing



#10639 QTY. 50
5/16" Housing



#10640 QTY. 25
3/8" Housing



#10641 QTY. 25
7/16" Housing



#10642 QTY. 25
1/2" Housing



#10643 QTY. 25
9/16" Housing



#10644 QTY. 20
5/8" Housing



#40030 QTY. 15
11/16" Housing



#10645 QTY. 25
3/4" Housing



#40031 QTY. 15
13/16" Housing



#10646 QTY. 15
7/8" Housing

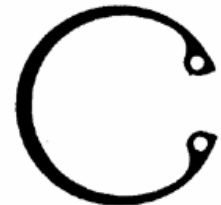

#10647 QTY. 10
1" Housing

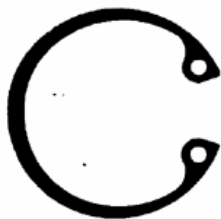

#40032 QTY. 10
1-1/16" Housing



#10648 QTY. 10
1-1/8" Housing

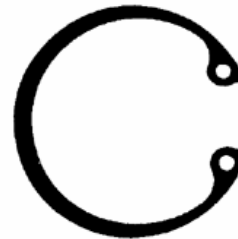

#40033 QTY. 10
1-3/16" Housing

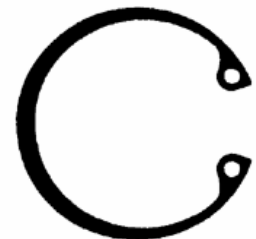

#10649 QTY. 10
1-1/4" Housing

RETAINING RINGS

INTERNAL SNAP TYPE (Rings Actual Size)

- Internal rings fit in a groove in the housing bore.
- Unlimited universal applications: Industrial, power equipment, cars, trucks, garden equipment.

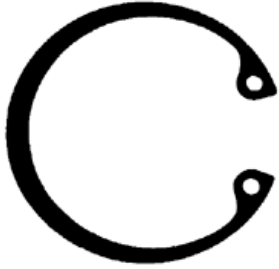

#40044 QTY. 10
1-5/16" Housing

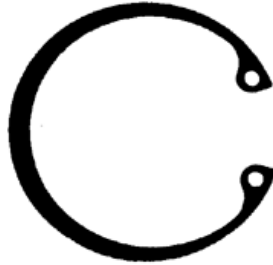

#40045 QTY. 10
1-3/8" Housing

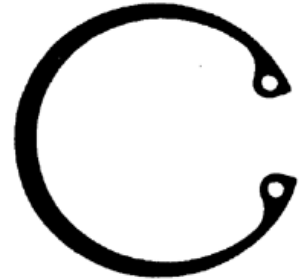

#40046 QTY. 10
1-7/16" Housing

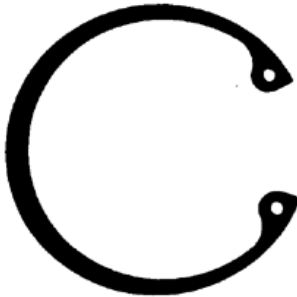

#40047 QTY. 10
1-1/2" Housing

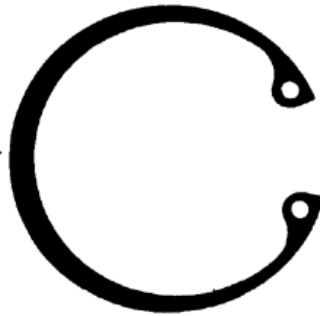

#40048 QTY. 10
1-5/8" Housing

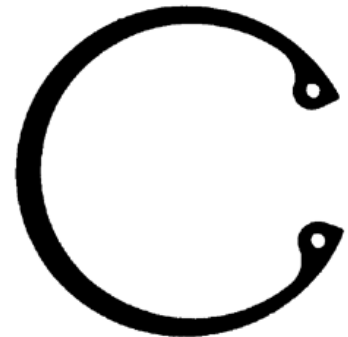

#40049 QTY. 10
1-3/4" Housing

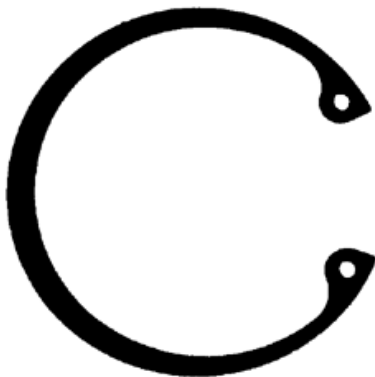

#86999 QTY. 10
2" Housing

RETAINING RINGS

EXTERNAL SNAP TYPE (Rings Actual Size)

- Rings require a groove on the shaft.
- Unlimited universal applications: cars, trucks, industrial, power equipment.



#87000 QTY. 50
1/8" Shaft



#40055 QTY. 50
3/16" Shaft



#10650 QTY. 50
1/4" Shaft



#40056 QTY. 50
9/32" Shaft



#10651 QTY. 50
5/16" Shaft



#40057 QTY. 50
11/32" Shaft



#10652 QTY. 25
3/8" Shaft



#87001 QTY. 25
13/32" Shaft



#10653 QTY. 25
7/16" Shaft



#10654 QTY. 25
1/2" Shaft



#10655 QTY. 20
9/16" Shaft



#10656 QTY. 20
5/8" Shaft



#10762 QTY. 15
11/16" Shaft



#10657 QTY. 15
3/4" Shaft



#87002 QTY. 15
13/16" Shaft



#10658 QTY. 15
7/8" Shaft

RETAINING RINGS

EXTERNAL SNAP TYPE (Rings Actual Size)

- Rings require a groove on the shaft.
- Unlimited universal applications: cars, trucks, industrial, power equipment.



#87003 QTY. 10
15/16" Shaft



#10659 QTY. 10
1" Shaft



#40058 QTY. 10
1-1/16" Shaft



#10660 QTY. 10
1-1/8" Shaft



#40059 QTY. 10
1-3/16" Shaft



#10661 QTY. 10
1-1/4" Shaft



#40060 QTY. 10
1-5/16" Shaft



#40061 QTY. 10
1-3/8" Shaft



#40062 QTY. 10
1-7/16" Shaft

RETAINING RINGS

EXTERNAL SNAP TYPE (Rings Actual Size)

- Rings require a groove on the shaft.



#40063 QTY. 10
1-1/2" Shaft



#40064 QTY. 10
1-5/8" Shaft



#40065 QTY. 10
1-3/4" Shaft



#87004 QTY. 10
1-7/8" Shaft



#40066 QTY. 10
2" Shaft



#87005 QTY. 5
2-1/8" Shaft



#87006 QTY. 5
2-1/4" Shaft

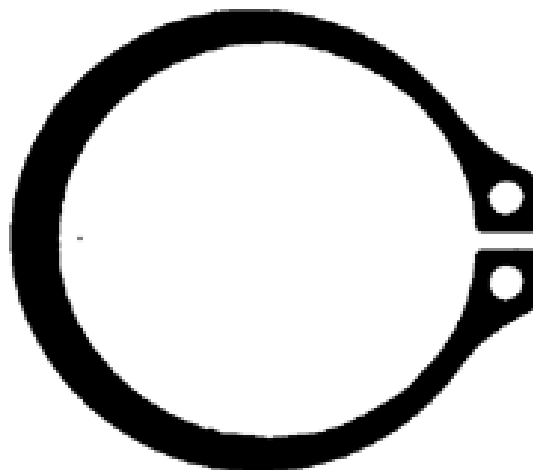

#87007 QTY. 5
2-3/8" Shaft

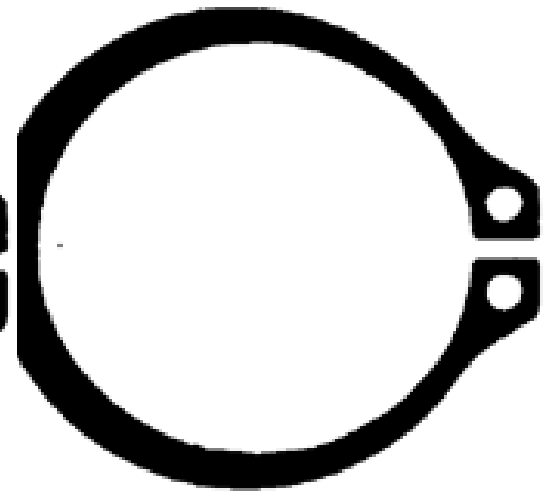

#87008 QTY. 5
2-1/2" Shaft

RETAINING RINGS

E TYPE

(Rings Actual Size)

- These external rings provide three-way contact.
- Unlimited universal applications: Industrial, machinery, cars, trucks, snow plows.



#12706 QTY 100
1/16" Shaft



#12711 QTY 100
3/32" Shaft



#12712 QTY 100
1/8" Shaft



#12707 QTY 100
9/64" Shaft



#12713 QTY 100
5/32" Shaft



#12708 QTY 100
11/64" Shaft



#12714 QTY 100
3/16" Shaft



#12717 QTY 100
7/32" Shaft



#12715 QTY 50
1/4" Shaft



#12716 QTY 50
5/16" Shaft



#10951 QTY. 25
3/8" Shaft



#12718 QTY. 25
7/16" Shaft



#12719 QTY. 25
1/2" Shaft



#12768 QTY. 25
9/16" Shaft



#11094 QTY. 25
5/8" Shaft

RETAINING RINGS

E TYPE (Rings Actual Size)

- These external rings provide three-way contact.
- Unlimited universal applications: Industrial, machinery, cars, trucks, snow plows.



#11095 QTY. 25
3/4" Shaft



#11096 QTY. 20
7/8" Shaft



#11097 QTY. 20
1" Shaft



#12709 QTY. 20
1-3/16" Shaft



#12710 QTY. 20
1-3/8" Shaft

RETAINING RINGS

SNAP RING PLIERS

- Vise-grip, 4 piece, convertible snap ring pliers.
- **One pair replaces 2 for internal or external use.**
- Includes 4 interchangeable tips for ease in moving from 1 project to the next.
- Pro touch grips provide extra comfort for less hand fatigue.
- Retaining ring pliers set includes two 180 degrees tips, one 90 degree tip & one 45 degree tip.

J&B #	QTY
57048	EA





J&B Fleet - Industrial Supply

























22428 Harrisburg-Westville Rd. Alliance, Ohio 44601 Phone: (330) 821-6342 Fax: (330) 821-0411

www.jbfleet.com



PART # 2021

COTTER PINS 1/16 – 5/32

<p>12330 ¹</p>  <p>50 1/16 X 1/2</p>	<p>12331 ²</p>  <p>50 1/16 X 3/4</p>	<p>12332 ³</p>  <p>50 1/16 X 1</p>	<p>12333 ⁴</p>  <p>50 1/16 X 1-1/4</p>	<p>12334 ⁵</p>  <p>50 1/16 X 1-1/2</p>	<p>12336 ⁶</p>  <p>50 1/16 X 2</p>
<p>12337 ⁷</p>  <p>50 3/32 X 1/2</p>	<p>12338 ⁸</p>  <p>50 3/32 X 3/4</p>	<p>12339 ⁹</p>  <p>50 3/32 X 1</p>	<p>12340 ¹⁰</p>  <p>50 3/32 X 1-1/4</p>	<p>12341 ¹¹</p>  <p>50 3/32 X 1-1/2</p>	<p>12343 ¹²</p>  <p>50 3/32 X 2</p>
<p>12347 ¹³</p>  <p>50 1/8 X 3/4</p>	<p>12348 ¹⁴</p>  <p>50 1/8 X 1</p>	<p>12349 ¹⁵</p>  <p>50 1/8 X 1-1/4</p>	<p>12350 ¹⁶</p>  <p>50 1/8 X 1-1/2</p>	<p>12351 ¹⁷</p>  <p>50 1/8 X 1-3/4</p>	<p>12352 ¹⁸</p>  <p>50 1/8 X 2</p>
<p>12356 ¹⁹</p>  <p>50 5/32 X 3/4</p>	<p>12357 ²⁰</p>  <p>50 5/32 X 1</p>	<p>12358 ²¹</p>  <p>50 5/32 X 1-1/4</p>	<p>12359 ²²</p>  <p>50 5/32 X 1-1/2</p>	<p>12361 ²³</p>  <p>50 5/32 X 2</p>	<p>12363 ²⁴</p>  <p>50 5/32 X 2-1/2</p>



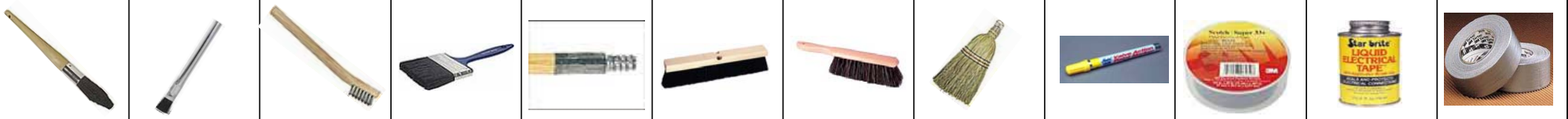

























J&B Fleet - Industrial Supply

22428 Harrisburg-Westville Rd. Alliance, Ohio 44601 Phone: (330) 821-6342 Fax: (330) 821-0411

www.jbfleet.com

PART # 2095

COTTER PINS

 12330 ¹ 1/16 X 1/2 50	 12337 ² 3/32 X 1/2 50	 12347 ³ 1/8 X 3/4 50	 12356 ⁴ 5/32 X 3/4 25	 12365 ⁵ 3/16 X 3/4 20	 12376 ⁶ 1/4 X 1-1/2 10
 12332 ⁷ 1/16 X 1 50	 12339 ⁸ 3/32 X 1 50	 12348 ⁹ 1/8 X 1 50	 12359 ¹⁰ 5/32 X 1-1/2 25	 12368 ¹¹ 3/16 X 1-1/2 20	 12378 ¹² 1/4 X 2 10
 12334 ¹³ 1/16 X 1-1/2 50	 12341 ¹⁴ 3/32 X 1-1/2 50	 12350 ¹⁵ 1/8 X 1-1/2 25	 12361 ¹⁶ 5/32 X 2 25	 12370 ¹⁷ 3/16 X 2 10	 12385 ¹⁸ 5/16 X 1-1/2 5
 12336 ¹⁹ 1/16 X 2 25	 12343 ²⁰ 3/32 X 2 25	 12352 ²¹ 1/8 X 2 25	 12363 ²² 5/32 X 2-1/2 20	 12374 ²³ 1/4 X 1 10	 12386 ²⁴ 5/16 X 2 5



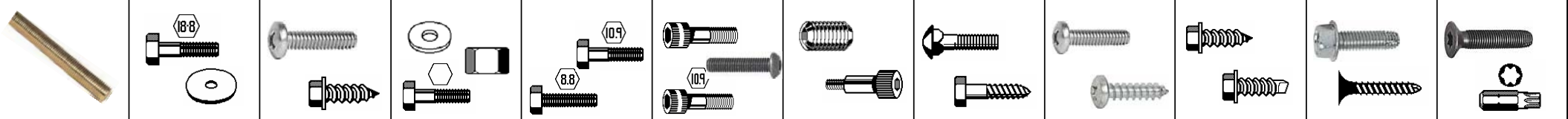

























J&B Fleet - Industrial Supply

22428 Harrisburg-Westville Rd. Alliance, Ohio 44601 Phone: (330) 821-6342 Fax: (330) 821-0411

www.jbfleet.com

PART # 2020

COTTER PINS 3/16 – 3/8

<p>12365 ¹</p>  <p>35</p> <p>3/16 X 3/4</p>	<p>12366 ²</p>  <p>35</p> <p>3/16 X 1</p>	<p>12367 ³</p>  <p>35</p> <p>3/16 X 1-1/4</p>	<p>12368 ⁴</p>  <p>35</p> <p>3/16 X 1-1/2</p>	<p>12370 ⁵</p>  <p>35</p> <p>3/16 X 2</p>	<p>12373 ⁶</p>  <p>35</p> <p>3/16 X 3</p>
<p>12372 ⁷</p>  <p>35</p> <p>3/16 X 2-1/2</p>	<p>12374 ⁸</p>  <p>15</p> <p>1/4 X 1</p>	<p>12375 ⁹</p>  <p>15</p> <p>1/4 X 1-1/4</p>	<p>12376 ¹⁰</p>  <p>15</p> <p>1/4 X 1-1/2</p>	<p>12381 ¹¹</p>  <p>15</p> <p>1/4 X 3</p>	<p>12384 ¹²</p>  <p>15</p> <p>1/4 X 3</p>
<p>12377 ¹³</p>  <p>15</p> <p>1/4 X 1-3/4</p>	<p>12378 ¹⁴</p>  <p>15</p> <p>1/4 X 2</p>	<p>12380 ¹⁵</p>  <p>15</p> <p>1/4 X 2-1/2</p>	<p>12384 ¹⁶</p>  <p>15</p> <p>5/16 X 1</p>	<p>12388 ¹⁷</p>  <p>10</p> <p>5/16 X 3</p>	<p>12388 ¹⁸</p>  <p>10</p> <p>5/16 X 3</p>
<p>12385 ¹⁹</p>  <p>15</p> <p>5/16 X 1-1/2</p>	<p>12386 ²⁰</p>  <p>15</p> <p>5/16 X 2</p>	<p>12392 ²¹</p>  <p>10</p> <p>3/8 X 2</p>	<p>12392 ²²</p>  <p>10</p> <p>3/8 X 2</p>	<p>12393 ²³</p>  <p>10</p> <p>3/8 X 3</p>	<p>12393 ²⁴</p>  <p>10</p> <p>3/8 X 3</p>

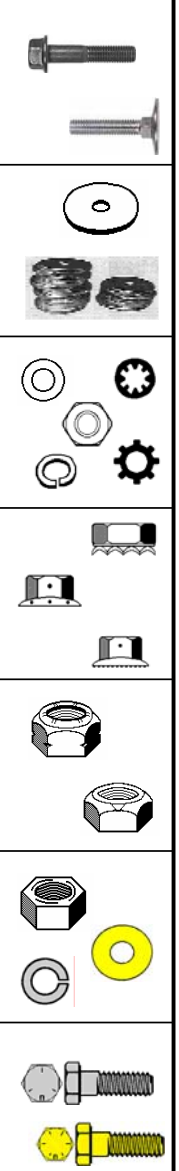































J&B Fleet - Industrial Supply

22428 Harrisburg-Westville Rd. Alliance, Ohio 44601 Phone: (330) 821-6342 Fax: (330) 821-0411

www.jbfleet.com

PART # 2218

COTTER PINS

 12330 ¹ 1/16 X 1/2 50	 12332 ² 1/16 X 1 50	 12334 ³ 1/16 X 1-1/2 50	 12336 ⁴ 1/16 X 2 25	 12337 ⁵ 3/32 X 1/2 50	 12339 ⁶ 3/32 X 1 50	 12341 ⁷ 3/32 X 1-1/2 50	 12343 ⁸ 3/32 X 2 25
 12347 ⁹ 1/8 X 3/4 50	 12348 ¹⁰ 1/8 X 1 50	 12349 ¹¹ 1/8 X 1-1/4 25	 12350 ¹² 1/8 X 1-1/2 25	 12352 ¹³ 1/8 X 2 25	 12356 ¹⁴ 5/32 X 3/4 25	 12357 ¹⁵ 5/32 X 1 25	 12358 ¹⁶ 5/32 X 1-1/4 25
 12359 ¹⁷ 5/32 X 1-1/2 25	 12361 ¹⁸ 5/32 X 2 25	 12365 ¹⁹ 3/16 X 3/4 20	 12366 ²⁰ 3/16 X 1 20	 12367 ²¹ 3/16 X 1-1/4 20	 12369 ²² 3/16 X 1-1/2 10	 12370 ²³ 3/16 X 2 10	 12374 ²⁴ 1/4 X 1 10
 12375 ²⁵ 1/4 X 1-1/4 10	 12376 ²⁶ 1/4 X 1-1/2 10	 27	 12378 ²⁸ 1/4 X 2 10	 29	 12385 ³⁰ 5/16 X 1-1/2 5	 31	 12386 ³² 5/16 X 2 5



LET US HELP YOU MAKE THE CONNECTION

PART# 3004

COTTER PINS



J & B FLEET-INDUSTRIAL SUPPLY
PHONE: 330-821-6342



12330 1/16 X 1/2 25	12332 1/16 X 1 25	12339 3/32 X 1 25	12341 3/32 X 1-1/2 25	12348 1/8 X 1 25	12350 1/8 X 1-1/2 10
12352 1/8 X 2 10	12359 5/32 X 1-1/2 10	12361 5/32 X 2 10	12365 3/16 X 3/4 10	12368 3/16 X 1-1/2 10	12370 3/16 X 2 5



















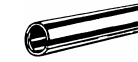







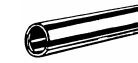
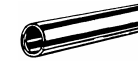

J&B Fleet - Industrial Supply

22428 Harrisburg-Westville Rd. Alliance, Ohio 44601 Phone: (330) 821-6342 Fax: (330) 821-0411

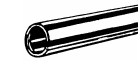
www.jbfleet.com

PART #2246

SPRING PINS

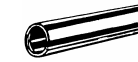
 12400 ¹ 1/16 X 1/2 25	 12402 ² 1/16 X 3/4 25	 12405 ³ 5/64 X 1/2 20	 12407 ⁴ 5/64 X 3/4 20	 12411 ⁵ 3/32 X 3/4 20	 12414 ⁶ 3/32 X 1 20	 12418 ⁷ 1/8 X 3/4 20	 12420 ⁸ 1/8 X 1 20
 12421 ⁹ 1/8 X 1 1/4 15	 12422 ¹⁰ 1/8 X 1 1/2 15	 12426 ¹¹ 5/32 X 1 15	 12428 ¹² 5/32 X 1-1/2 10	 12432 ¹³ 3/16 X 1 10	 12433 ¹⁴ 3/16 X 1-1/4 10	 12434 ¹⁵ 3/16 X 1-1/2 10	 12436 ¹⁶ 3/16 X 2 5
 12438 ¹⁷ 7/32 X 1 10	 12440 ¹⁸ 7/32 X 1-1/2 5	 12442 ¹⁹ 7/32 X 2 5	 12444 ²⁰ 1/4 X 1 10	 12445 ²¹ 1/4 X 1-1/4 10	 12447 ²² 1/4 X 1-1/2 5	 12448 ²³ 1/4 X 2 5	12449 ²⁴
 12466 ²⁵ 5/16 X 1 5	 12468 ²⁶ 5/16 X 1-1/2 5	 12470 ²⁷ 5/16 X 2 5	12471 ²⁸	 12453 ²⁹ 3/8 X 1 5	 12455 ³⁰ 3/8 X 1-1/2 5	 12457 ³¹ 3/8 X 2 5	12458 ³²





J&B Fleet - Industrial Supply





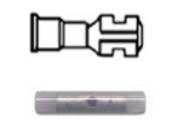

22428 Harrisburg-Westville Rd. Alliance, Ohio 44601 Phone: (330) 821-6342 Fax: (330) 821-0411

www.jbfleet.com

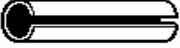
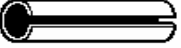
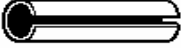
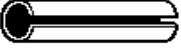
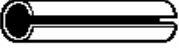
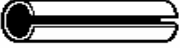
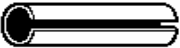
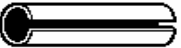
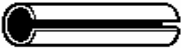
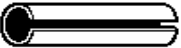
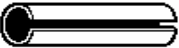
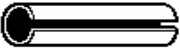
PART # 2016

ROLL PINS 1/16 – 1/4

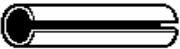
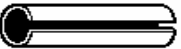
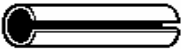
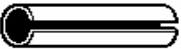
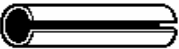
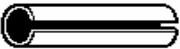

<p>12401 ¹</p>  <p>25 1/16 X 1/4</p>	<p>12400 ²</p>  <p>25 1/16 X 1/2</p>	<p>12402 ³</p>  <p>25 1/16 X 3/4</p>	<p>12403 ⁴</p>  <p>25 5/64 X 1/4</p>	<p>12405 ⁵</p>  <p>25 5/64 X 1/2</p>	<p>12407 ⁶</p>  <p>25 5/64 X 3/4</p>
<p>12410 ⁷</p>  <p>25 3/32 X 1/2</p>	<p>12411 ⁸</p>  <p>25 3/32 X 3/4</p>	<p>12414 ⁹</p>  <p>25 3/32 X 1</p>	<p>12415 ¹⁰</p>  <p>25 1/8 X 3/8</p>	<p>12418 ¹¹</p>  <p>25 1/8 X 3/4</p>	<p>12422 ¹²</p>  <p>20 1/8 X 1-1/2</p>
<p>12423 ¹³</p>  <p>25 5/32 X 1/2</p>	<p>12426 ¹⁴</p>  <p>25 5/32 X 1</p>	<p>12428 ¹⁵</p>  <p>20 5/32 X 1-1/2</p>	<p>12429 ¹⁶</p>  <p>25 3/16 X 1/2</p>	<p>12432 ¹⁷</p>  <p>20 3/16 X 1</p>	<p>12436 ¹⁸</p>  <p>15 3/16 X 2</p>
<p>12437 ¹⁹</p>  <p>25 7/32 X 3/4</p>	<p>12440 ²⁰</p>  <p>20 7/32 X 1-1/2</p>	<p>12442 ²¹</p>  <p>15 7/32 X 2</p>	<p>12444 ²²</p>  <p>20 1/4 X 1</p>	<p>12448 ²³</p>  <p>10 1/4 X 2</p>	<p>12452 ²⁴</p>  <p>5 1/4 X 3</p>

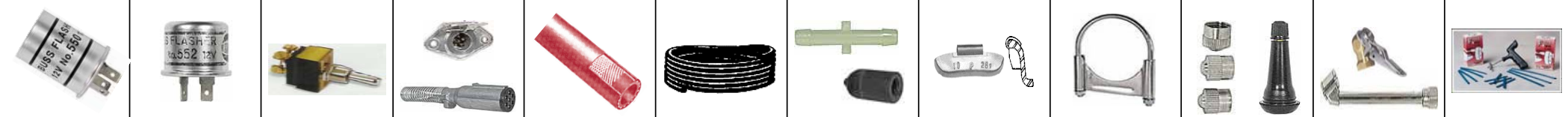













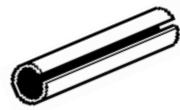

J&B Fleet - Industrial Supply

22428 Harrisburg-Westville Rd. Alliance, Ohio 44601 Phone: (330) 821-6342 Fax: (330) 821-0411

www.jbfleet.com

PART # 2017

ROLL PINS 5/16 – 1/2

 32085 1 15 5/16 X 3/4	 12466 2 15 5/16 X 1	 12468 3 10 5/16 X 1-1/2	 12470 4 10 5/16 X 2
 12453 5 10 3/8 X 1	 12455 6 10 3/8 X 1-1/2	 12457 7 5 3/8 X 2	 12459 8 5 3/8 X 2-1/2
 12461 9 10 3/8 X 3	 25172 14 5 1/2 X 2	 12481 11 5 7/16 X 1-1/2	 25171 12 5 1/2 X 1-1/4
 12482 13 10 1/2 X 1-1/2	 12483 15 5 1/2 X 3	 25173 16 3 1/2 X 4	

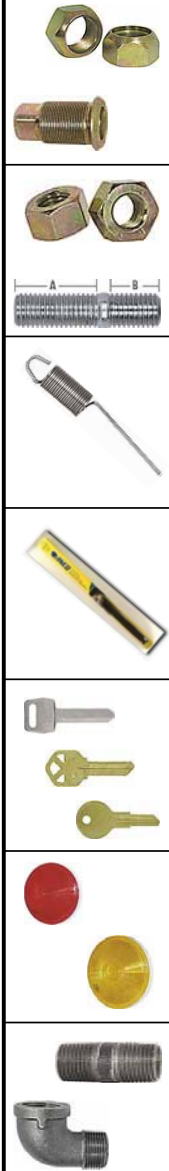



















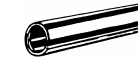







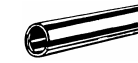
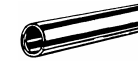

J&B Fleet - Industrial Supply

22428 Harrisburg-Westville Rd. Alliance, Ohio 44601 Phone: (330) 821-6342 Fax: (330) 821-0411

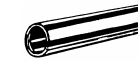
www.jbfleet.com

PART #2246

SPRING PINS

 12400 ¹ 1/16 X 1/2 25	 12402 ² 1/16 X 3/4 25	 12405 ³ 5/64 X 1/2 20	 12407 ⁴ 5/64 X 3/4 20	 12411 ⁵ 3/32 X 3/4 20	 12414 ⁶ 3/32 X 1 20	 12418 ⁷ 1/8 X 3/4 20	 12420 ⁸ 1/8 X 1 20
 12421 ⁹ 1/8 X 1 1/4 15	 12422 ¹⁰ 1/8 X 1 1/2 15	 12426 ¹¹ 5/32 X 1 15	 12428 ¹² 5/32 X 1-1/2 10	 12432 ¹³ 3/16 X 1 10	 12433 ¹⁴ 3/16 X 1-1/4 10	 12434 ¹⁵ 3/16 X 1-1/2 10	 12436 ¹⁶ 3/16 X 2 5
 12438 ¹⁷ 7/32 X 1 10	 12440 ¹⁸ 7/32 X 1-1/2 5	 12442 ¹⁹ 7/32 X 2 5	 12444 ²⁰ 1/4 X 1 10	 12445 ²¹ 1/4 X 1-1/4 10	 12447 ²² 1/4 X 1-1/2 5	 12448 ²³ 1/4 X 2 5	12449 ²⁴
 12466 ²⁵ 5/16 X 1 5	 12468 ²⁶ 5/16 X 1-1/2 5	 12470 ²⁷ 5/16 X 2 5	12471 ²⁸	 12453 ²⁹ 3/8 X 1 5	 12455 ³⁰ 3/8 X 1-1/2 5	 12457 ³¹ 3/8 X 2 5	12458 ³²



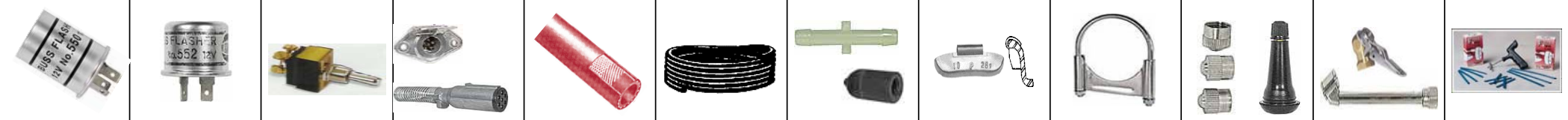



















J&B Fleet - Industrial Supply

www.jbfleet.com

22428 Harrisburg-Westville Rd. Alliance, Ohio 44601 Phone: (330) 821-6342 Fax: (330) 821-0411

PART # 2137

SPRING PINS

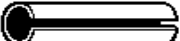
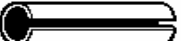
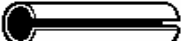
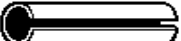
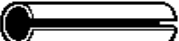
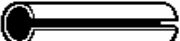
 12400 ¹ 1/16 X 1/2 20	 12402 ² 1/16 X 3/4 20	 12405 ³ 5/64 X 1/2 20	 12407 ⁴ 5/64 X 3/4 20	 12411 ⁵ 3/32 X 3/4 20	 12452 ⁶ 1/4 X 3 5
 12414 ⁷ 3/32 X 1 20	 12418 ⁸ 1/8 X 3/4 20	 12420 ⁹ 1/8 X 1 20	 12422 ¹⁰ 1/8 X 1-1/2 20	 12426 ¹¹ 5/32 X 1 20	 12457 ¹² 3/8 X 2 5
 12428 ¹³ 5/32 X 1-1/2 20	 12432 ¹⁴ 3/16 X 1 10	 12436 ¹⁵ 3/16 X 2 10	 12440 ¹⁶ 7/32 X 1 10	 12442 ¹⁷ 7/32 X 2 10	 12461 ¹⁸ 3/8 X 3 5
 12444 ¹⁹ 1/4 X 1 10	 12448 ²⁰ 1/4 X 2 10	 12466 ²¹ 5/16 X 1 10	 12470 ²² 5/16 X 2 5	 12453 ²³ 3/8 X 1 5	 12483 ²⁴ 1/2 X 3 5



LET US HELP YOU MAKE THE CONNECTION

Part # 3005

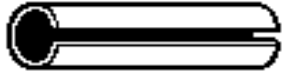

ROLL PINS



J & B FLEET-INDUSTRIAL SUPPLY
PHONE: 330-821-6342

12402 1/16 x 3/4 10	12414 3/32 x 1 10	12420 1/8 x 1 10	12422 1/8 x 1-1/2 10	12426 5/32 x 1 10	12428 5/32 x 1-1/2 10
12432 3/16 x 1 10	12436 3/16 x 2 10	12440 7/32 x 1 10	12442 7/32 x 2 10	12444 1/4 x 1 10	12448 1/4 x 2 10



















J&B Fleet - Industrial Supply

www.jbfleet.com

22428 Harrisburg-Westville Rd. Alliance, Ohio 44601 Phone: (330) 821-6342 Fax: (330) 821-0411

PART # 2089

HAIRPINS

 50 13264 1/32 X 5/8	 10 13276 7/64 X 1-5/8	 10 13256 9/64 X 2-1/2	 3 41055 PIN DIA 1/4 EFFECTIVE LENGTH 1-3/8
 50 13266 3/64 X 1"	 10 13254 7/64 X 2-5/16	 10 13280 9/64 X 2-7/8	 3 41056 PIN DIA 5/16 EFFECTIVE LENGTH 2-1/4
 25 13268 1/16 X 1-9/16	 10 13278 1/8 X 1-1/4	 5 13282 5/32 X 2-15/16	
 25 13270 5/64 X 1-9/16	 10 13262 9/64 X 1-15/16	 3 13260 3/16 X 3-3/4	
 25 13272 5/64 X 1-7/8			
 25 13274 3/32 X 1-9/16			

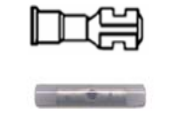

LET US HELP YOU MAKE THE CONNECTION

PART # 3008

HAIRPINS



J & B FLEET-INDUSTRIAL SUPPLY
PHONE: 330-821-6342



13270	13274	13254	13256	13282	13260
5/64 x 1-9/16	3/32 x 1-9/16	7/64 x 2-5/16	9/64 x 2-1/2	5/32 x 2-15/16	3/16 x 3-3/4
25	25	10	10	10	5













J&B Fleet - Industrial Supply

www.jbfleet.com

22428 Harrisburg-Westville Rd. Alliance, Ohio 44601 Phone: (330) 821-6342 Fax: (330) 821-0411

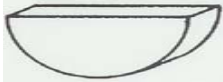
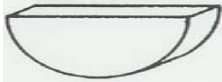
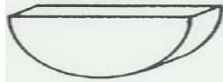
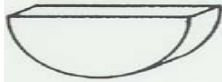
PART # 2032

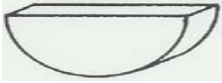
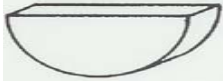
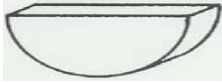
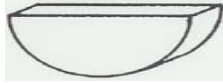
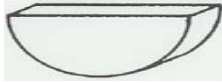
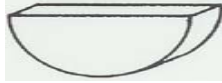
WOODRUFF KEYS

<p>12586 ¹</p>  <p>15 3/32 X 1/2</p>	<p>12587 ²</p>  <p>15 3/32 X 5/8</p>	<p>12588 ³</p>  <p>15 1/8 X 1/2</p>	<p>12589 ⁴</p>  <p>15 1/8 X 5/8</p>	<p>12590 ⁵</p>  <p>10 5/32 X 5/8</p>	<p>12591 ⁶</p>  <p>10 5/32 X 3/4</p>
<p>12592 ⁷</p>  <p>10 5/32 X 7/8</p>	<p>12593 ⁸</p>  <p>10 3/16 X 3/4</p>	<p>12594 ⁹</p>  <p>10 3/16 X 7/8</p>	<p>12595 ¹⁰</p>  <p>10 3/16 X 1</p>	<p>12596 ¹¹</p>  <p>5 1/4 X 3/4</p>	<p>12597 ¹²</p>  <p>5 1/4 X 7/8</p>
<p>12598 ¹³</p>  <p>5 1/4 X 1</p>	<p>12599 ¹⁴</p>  <p>5 1/4 X 1-1/8</p>	<p>12600 ¹⁵</p>  <p>5 1/4 X 1-1/4</p>	<p>12601 ¹⁶</p>  <p>5 5/16 X 1</p>	<p>12602 ¹⁷</p>  <p>5 5/16 X 1-1/8</p>	<p>12603 ¹⁸</p>  <p>5 5/16 X 1-1/4</p>
<p>12604 ¹⁹</p>  <p>3 3/8 X 1</p>	<p>12605 ²⁰</p>  <p>3 3/8 X 1-1/4</p>	<p>21</p>	<p>22</p>	<p>23</p>	<p>24</p>



LET US HELP YOU MAKE THE CONNECTION

PART # 3007

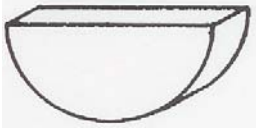

WOODRUFF KEYS



J & B FLEET-INDUSTRIAL SUPPLY
PHONE: 330-821-6342

12586 3/32 x 1/2 5	12587 3/32 x 5/8 5	12588 1/8 x 1/2 5	12589 1/8 x 5/8 5	12590 5/32 x 5/8 5	12591 5/32 x 3/4 5
12593 3/16 x 3/4 5	12594 3/16 x 7/8 5	12595 3/16 x 1 5	12596 1/4 x 3/4 3	12597 1/4 x 7/8 3	12598 1/4 x 1 3
12600 1/4 x 1-1/4 3	12601 5/16 x 1 2	12602 5/16 x 1-1/8 2	12603 5/16 x 1-1/4 2	12604 3/8 x 1 2	12605 3/8 x 1-1/4 2



J&B Fleet - Industrial Supply

www.jbfleet.com

22428 Harrisburg-Westville Rd. Alliance, Ohio 44601 Phone: (330) 821-6342 Fax: (330) 821-0411

PART # 2238

SNAP & LYNCH PINS

<p>41055 1</p> <p>5 PIN DIA. 1/4 EFFECTIVE LENGTH 1-3/8</p>	<p>41057 2</p> <p>5 PIN DIA. 3/16 EFFECTIVE LENGTH 1</p>	<p>41066 3</p> <p>5 PIN DIA. 5/16 EFFECTIVE LENGTH 1-1/4</p>
<p>41054 4</p> <p>5 PIN DIA. 1/4 EFFECTIVE LENGTH 2-1/4</p>	<p>41062 5</p> <p>5 PIN DIA. 3/16 EFFECTIVE LENGTH 1-1/4</p>	<p>41064 6</p> <p>5 PIN DIA. 5/16 EFFECTIVE LENGTH 1-3/8</p>
<p>41056 7</p> <p>5 PIN DIA. 5/16 EFFECTIVE LENGTH 2-1/4</p>	<p>41063 8</p> <p>5 PIN DIA. 1/4 EFFECTIVE LENGTH 1-1/4</p>	<p>41060 9</p> <p>5 PIN DIA. 7/16 EFFECTIVE LENGTH 1-5/8</p>
<p>41061 10</p> <p>5 PIN DIA. 3/8 EFFECTIVE LENGTH 2-1/4</p>	<p>41059 11</p> <p>5 PIN DIA. 1/4 EFFECTIVE LENGTH 1-5/16</p>	<p>41065 12</p> <p>5 PIN DIA. 7/16 EFFECTIVE LENGTH 1-3/4</p>

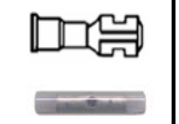

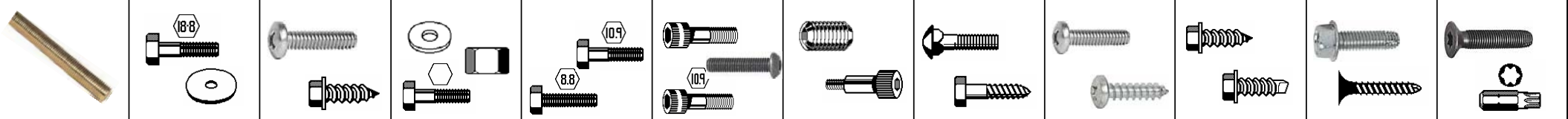

J&B Fleet - Industrial Supply

22428 Harrisburg-Westville Rd. Alliance, Ohio 44601 Phone: (330) 821-6342 Fax: (330) 821-0411

www.jbfleet.com

PART # 2225

CHAIN LINKS

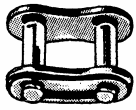
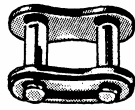
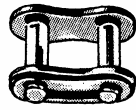
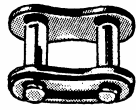
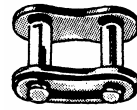
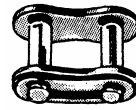
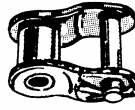
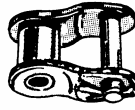
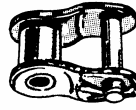
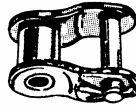
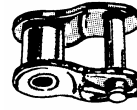
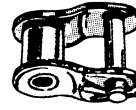
<p>13478 ¹</p>  <p>#35 CONNECTING LINKS</p> <p>4</p>	<p>13480 ²</p>  <p>#40 CONNECTING LINKS</p> <p>4</p>	<p>13479 ³</p>  <p>#41 CONNECTING LINKS</p> <p>4</p>	<p>13481 ⁴</p>  <p>#50 CONNECTING LINKS</p> <p>4</p>	<p>13482 ⁵</p>  <p>#60 CONNECTING LINKS</p> <p>3</p>	<p>13491 ⁶</p>  <p>#80 CONNECTING LINKS</p> <p>2</p>
<p>⁷</p>	<p>⁸</p>	<p>⁹</p>	<p>¹⁰</p>	<p>¹¹</p>	<p>¹²</p>
<p>13486 ¹³</p>  <p>#35 OFFSET LINKS</p> <p>4</p>	<p>13483 ¹⁴</p>  <p>#40 OFFSET LINKS</p> <p>4</p>	<p>13487 ¹⁵</p>  <p>#41 OFFSET LINKS</p> <p>4</p>	<p>13484 ¹⁶</p>  <p>#50 OFFSET LINKS</p> <p>4</p>	<p>13485 ¹⁷</p>  <p>#60 OFFSET LINKS</p> <p>3</p>	<p>13492 ¹⁸</p>  <p>#80 OFFSET LINKS</p> <p>2</p>
<p>¹⁹</p>	<p>²⁰</p>	<p>²¹</p>	<p>²²</p>	<p>²³</p>	<p>²⁴</p>



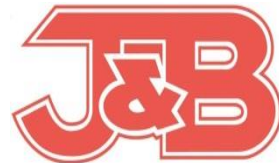











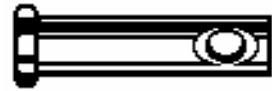
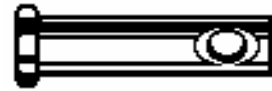



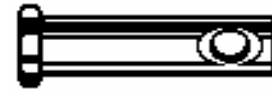







J&B Fleet - Industrial Supply

22428 Harrisburg-Westville Rd. Alliance, Ohio 44601 Phone: (330) 821-6342 Fax: (330) 821-0411

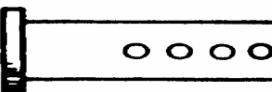
www.jbfleet.com

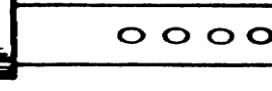
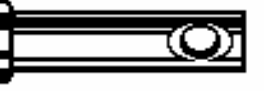
PART # 2198

CLEVIS PINS (zinc plated)

 37480 ¹ 5 3/16 X 1/2	 37481 ² 5 3/16 X 3/4	 37482 ³ 5 3/16 X 1	 37483 ⁴ 5 3/16 X 1-1/2	 37486 ⁵ 5 1/4 X 3/4	 37499 ⁶ 2 1/2 X 3
 37500 ⁷ 5 1/4 X 1	 37501 ⁸ 5 1/4 X 1-1/4	 37502 ⁹ 5 1/4 X 1-1/2	 13185 ¹⁰ 5 1/4 X 2	 37506 ¹¹ 5 5/16 X 1	 37498 ¹² 2 1/2 X 2-1/2
 37507 ¹³ 5 5/16 X 1-1/4	 37508 ¹⁴ 5 5/16 X 1-1/2	 13186 ¹⁵ 5 5/16 X 2	 37512 ¹⁶ 5 3/8 X 1	 37513 ¹⁷ 5 3/8 X 1-1/4	 13189 ¹⁸ 2 1/2 X 2
 37514 ¹⁹ 5 3/8 X 1-1/2	 13187 ²⁰ 5 3/8 x 2	 37490 ²¹ 2 7/16 x 1-1/4	 37524 ²² 2 7/16 x 1-1/2	 13188 ²³ 2 7/16 x 2	 40505 ²⁴ 2 1/2 X 1-1/2





















J&B Fleet - Industrial Supply

www.jbfleet.com

22428 Harrisburg-Westville Rd. Alliance, Ohio 44601 Phone: (330) 821-6342 Fax: (330) 821-0411

PART # 2061

ALUMINUM BLIND RIVETS

<p>39012</p>  <p>1/8 BACK-UP WASHER</p> <p>50</p>	<p>13323</p>  <p>DOMe HEAD 1/8 DIAMETER</p> <p>GRIP .313 - .375</p> <p>50</p>	<p>13332</p>  <p>DOMe HEAD 3/16 DIAMETER</p> <p>GRIP .251 - .375</p> <p>50</p>	<p>13337</p>  <p>LARGE FLANGE</p> <p>DOMe HEAD 3/16 DIAMETER</p> <p>GRIP .251 - .375</p> <p>25</p>
<p>13319</p>  <p>DOMe HEAD 1/8 DIAMETER</p> <p>GRIP .065 - .125</p> <p>50</p>	<p>12260</p>  <p>DOMe HEAD 1/8 DIAMETER</p> <p>GRIP .375 - .500</p> <p>50</p>	<p>13334</p>  <p>DOMe HEAD 3/16 DIAMETER</p> <p>GRIP .376 - .500</p> <p>50</p>	<p>13338</p>  <p>LARGE FLANGE</p> <p>DOMe HEAD 3/16 DIAMETER</p> <p>GRIP .375 - .500</p> <p>25</p>
<p>13322</p>  <p>DOMe HEAD 1/8 DIAMETER</p> <p>GRIP .188 - .250</p> <p>50</p>	<p>39013</p>  <p>3/16 BACK-UP WASHER</p> <p>50</p>	<p>32116</p>  <p>DOMe HEAD 3/16 DIAMETER</p> <p>GRIP .625 - .750</p> <p>50</p>	<p>13338</p>  <p>LARGE FLANGE</p> <p>DOMe HEAD 3/16 DIAMETER</p> <p>GRIP .375 - .500</p> <p>25</p>
<p>32091</p>  <p>DOMe HEAD 1/8 DIAMETER</p> <p>GRIP .250 - .313</p> <p>50</p>	<p>13330</p>  <p>DOMe HEAD 3/16 DIAMETER</p> <p>GRIP .126 - .250</p> <p>50</p>	<p>13330</p>  <p>DOMe HEAD 3/16 DIAMETER</p> <p>GRIP .126 - .250</p> <p>50</p>	<p>13338</p>  <p>LARGE FLANGE</p> <p>DOMe HEAD 3/16 DIAMETER</p> <p>GRIP .375 - .500</p> <p>25</p>



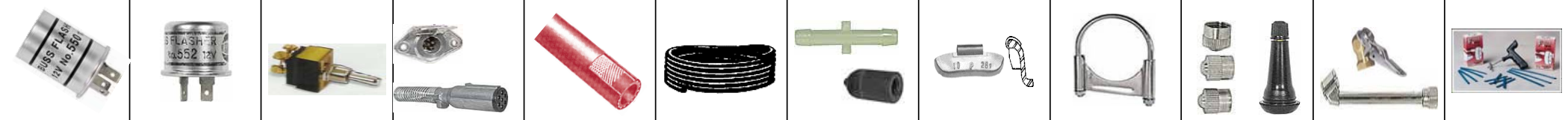











J&B Fleet - Industrial Supply

www.jbfleet.com

22428 Harrisburg-Westville Rd. Alliance, Ohio 44601 Phone: (330) 821-6342 Fax: (330) 821-0411

PART # 2062

STEEL BLIND RIVETS

<p>13317 1</p>  <p>DOME HEAD 1/8 DIAMETER GRIP .065 - .125</p> <p>50</p>	<p>13320 2</p>  <p>DOME HEAD 1/8 DIAMETER GRIP .188 - .250</p> <p>50</p>	<p>12262 3</p>  <p>DOME HEAD 1/8 DIAMETER GRIP .313 - .375</p> <p>50</p>
<p>12263 4</p>  <p>DOME HEAD 1/8 DIAMETER GRIP .375 - .500</p> <p>50</p>		<p>39010 6</p>  <p>1/8 BACK-UP WASHER</p> <p>50</p>
<p>32092 7</p>  <p>DOME HEAD 3/16 DIAMETER GRIP .188 - .150</p> <p>50</p>	<p>32093 8</p>  <p>DOME HEAD 3/16 DIAMETER GRIP .250 - .375</p> <p>50</p>	<p>32094 9</p>  <p>DOME HEAD 3/16 DIAMETER GRIP .375 - .500</p> <p>50</p>
<p>12269 10</p>  <p>LARGE FLANGE DOME HEAD 3/16 DIAMETER GRIP .375 - .500</p> <p>25</p>		<p>39011 12</p>  <p>3/16 BACK-UP WASHER</p> <p>50</p>





































J&B Fleet - Industrial Supply

www.jbfleet.com

22428 Harrisburg-Westville Rd. Alliance, Ohio 44601 Phone: (330) 821-6342 Fax: (330) 821-0411

PART # 2076

O-RINGS # 1

<p>12606 ¹</p>  <p>006</p> <p>1/8 ID X 1/4 OD 15 1/16 THICK</p>	<p>12607 ²</p>  <p>007</p> <p>5/32 ID X 9/32 OD 15 1/16 THICK</p>	<p>12608 ³</p>  <p>008</p> <p>3/16 ID X 5/16 OD 15 1/16 THICK</p>	<p>12609 ⁴</p>  <p>009</p> <p>7/32 ID X 11/32 OD 15 1/16 THICK</p>	<p>12610 ⁵</p>  <p>010</p> <p>1/4 ID X 3/8 OD 15 1/16 THICK</p>	<p>12611 ⁶</p>  <p>011</p> <p>5/16 ID X 7/16 OD 15 1/16 THICK</p>	<p>12612 ⁷</p>  <p>012</p> <p>3/8 ID X 1/2 OD 15 1/16 THICK</p>	<p>39900 ⁸</p>  <p>013</p> <p>7/16 ID X 9/16 OD 10 1/16 THICK</p>
<p>39901 ⁹</p>  <p>014</p> <p>1/2 ID X 5/8 OD 10 1/16 THICK</p>	<p>39902 ¹⁰</p>  <p>015</p> <p>9/16 ID X 11/16 OD 10 1/16 THICK</p>	<p>39903 ¹¹</p>  <p>016</p> <p>5/8 ID X 3/4 OD 10 1/16 THICK</p>	<p>39904 ¹²</p>  <p>017</p> <p>11/16 ID X 13/16 OD 10 1/16 THICK</p>	<p>39905 ¹³</p>  <p>018</p> <p>3/4 ID X 7/8 OD 10 1/16 THICK</p>	<p>39906 ¹⁴</p>  <p>019</p> <p>13/16 ID X 15/16 OD 10 1/16 THICK</p>	<p>39907 ¹⁵</p>  <p>020</p> <p>7/8 ID X 1 OD 10 1/16 THICK</p>	<p>39908 ¹⁶</p>  <p>021</p> <p>15/16 ID X 1-1/16 OD 10 1/16 THICK</p>
<p>39909 ¹⁷</p>  <p>022</p> <p>1 ID X 1-1/8 OD 5 1/16 THICK</p>	<p>39910 ¹⁸</p>  <p>024</p> <p>1-1/8 ID X 1-1/4 OD 5 1/16 THICK</p>	<p>39911 ¹⁹</p>  <p>026</p> <p>1-1/4 ID X 1-3/8 OD 5 1/16 THICK</p>	<p>39912 ²⁰</p>  <p>028</p> <p>1-3/8 ID X 1-1/2 OD 5 1/16 THICK</p>	<p>39913 ²¹</p>  <p>029</p> <p>1-1/2 ID X 1-5/8 OD 5 1/16 THICK</p>	<p>39914 ²²</p>  <p>030</p> <p>1-5/8 ID X 1-3/4 OD 3 1/16 THICK</p>	<p>39915 ²³</p>  <p>031</p> <p>1-3/4 ID X 1-7/8 OD 3 1/16 THICK</p>	<p>39916 ²⁴</p>  <p>032</p> <p>1-7/8 ID X 2 OD 3 1/16 THICK</p>
<p>12613 ²⁵</p>  <p>110</p> <p>3/8 ID X 9/16 OD 15 3/32 THICK</p>	<p>12614 ²⁶</p>  <p>111</p> <p>7/16 ID X 5/8 OD 15 3/32 THICK</p>	<p>12615 ²⁷</p>  <p>112</p> <p>1/2 ID X 11/16 OD 15 3/32 THICK</p>	<p>12616 ²⁸</p>  <p>113</p> <p>9/16 ID X 3/4 OD 5 3/32 THICK</p>	<p>12617 ²⁹</p>  <p>114</p> <p>5/8 ID X 13/16 OD 5 3/32 THICK</p>	<p>12618 ³⁰</p>  <p>115</p> <p>11/16 ID X 7/8 OD 5 3/32 THICK</p>	<p>12619 ³¹</p>  <p>116</p> <p>3/4 ID X 15/16 OD 5 3/32 THICK</p>	<p>39940 ³²</p>  <p>117</p> <p>13/16 ID X 1 OD 5 3/32 THICK</p>



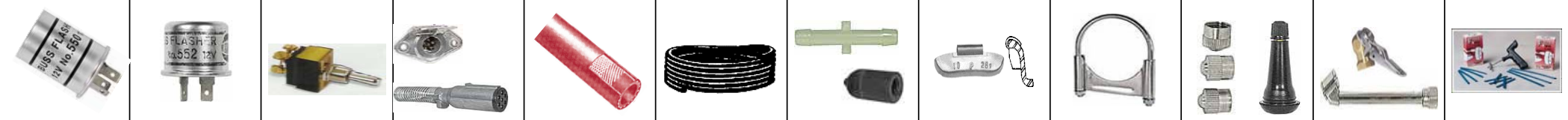

































J&B Fleet - Industrial Supply

www.jbfleet.com

22428 Harrisburg-Westville Rd. Alliance, Ohio 44601 Phone: (330) 821-6342 Fax: (330) 821-0411

PART # 2077

O-RINGS #2

 39941 ¹ 118 7/8 ID X 1-1/16OD 10 3/32 THICK	 39942 ² 119 15/16 ID X 1-1/8OD 10 3/32 THICK	 39943 ³ 120 1 ID X 1-3/16 OD 10 3/32 THICK	 39944 ⁴ 121 1-1/16ID X 1-1/4OD 10 3/32 THICK	 39945 ⁵ 122 1-1/8ID X 1-5/16OD 10 3/32 THICK	 39946 ⁶ 123 1-3/16ID X 1-3/8O 10 3/32 THICK	 39947 ⁷ 124 1-1/4ID X 1-7/16OD 10 3/32 THICK	 39948 ⁸ 126 1-3/8ID X 1-9/16OD 5 3/32 THICK
 39949 ⁹ 128 1-1/2ID X 1-11/16O 5 3/32 THICK	 39950 ¹⁰ 130 1-5/8ID X 1-13/16O 5 3/32 THICK	 39951 ¹¹ 132 1-3/4ID X 1-15/16O 3 3/32 THICK	 39952 ¹² 134 1-7/8ID X 2-1/16O 3 3/32 THICK	 39953 ¹³ 146 2ID X 2-3/16OD 3 3/32 THICK	 39986 ¹⁴ 209 11/16 ID X 15/16O 10 1/8 THICK	 12620 ¹⁵ 210 3/4 ID X 1 OD 10 1/8 THICK	 12621 ¹⁶ 211 13/16ID X 1-1/16OD 10 1/8 THICK
 12622 ¹⁷ 212 7/8 ID X 1-1/8OD 5 1/8 THICK	 12623 ¹⁸ 213 15/16 ID X 1-3/16O 5 1/8 THICK	 12624 ¹⁹ 214 1 ID X 1-1/4 OD 5 1/8 THICK	 12625 ²⁰ 215 1-1/16ID X 1-5/16O 5 1/8 THICK	 12626 ²¹ 216 1-1/8ID X 1-3/8O 5 1/8 THICK	 12627 ²² 217 1-3/16ID X 1-7/16O 5 1/8 THICK	 12628 ²³ 218 1-1/4ID X 1-1/2OD 5 1/8 THICK	 12629 ²⁴ 219 1-5/16ID X 1-9/16O 5 1/8 THICK
 12630 ²⁵ 220 1-3/8ID X 1-5/8OD 5 1/8 THICK	 12631 ²⁶ 221 1-7/16ID X 1-11/16O 5 1/8 THICK	 12632 ²⁷ 222 1-1/2ID X 1-3/4OD 5 1/8 THICK	 39980 ²⁸ 223 1-5/8ID X 1-7/8OD 5 1/8 THICK	 39981 ²⁹ 224 1-3/4 ID X 2 OD 5 1/8 THICK	 39982 ³⁰ 225 1-7/8ID X 2-1/8OD 3 1/8 THICK	 39983 ³¹ 226 2 ID X 2-1/4 OD 3 1/8 THICK	 39984 ³² 227 2-1/8ID X 2-3/8OD 3 1/8 THICK



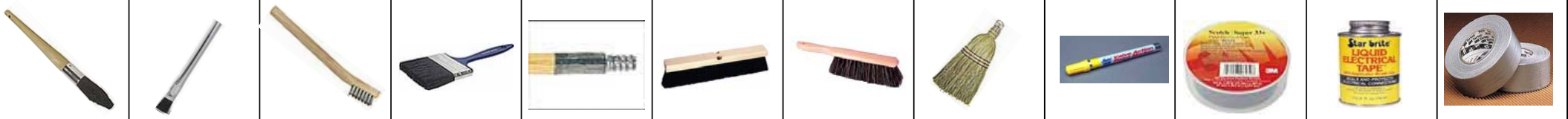















J&B Fleet - Industrial Supply

22428 Harrisburg-Westville Rd. Alliance, Ohio 44601 Phone: (330) 821-6342 Fax: (330) 821-0411

www.jbfleet.com

PART # 2078

O-RINGS # 3

 39985 1 228 2-1/4 ID X 2-1/2 OD 1/8 THICK	 12633 2 325 1-1/2 ID X 1-7/8 OD 3/16 THICK	 12634 3 326 1-5/8 ID X 2 OD 3/16 THICK	 12635 4 327 1-3/4 ID X 2-1/8 OD 3/16 THICK
 13448 5 328 1-7/8 ID X 2-1/4 OD 3/16 THICK	 13449 6 329 2 ID X 2-3/8 OD 3/16 THICK	 13450 7 330 2-1/8 ID X 2-1/2 OD 3/16 THICK	 13451 8 331 2-1/4 ID X 2-5/8 OD 3/16 THICK
 13452 9 332 2-3/8 ID X 2-3/4 OD 3/16 THICK	 13453 10 333 2-1/2 ID X 2-7/8 OD 3/16 THICK	 13454 11 334 2-5/8 ID X 3 OD 3/16 THICK	 13455 12 335 2-3/4 ID X 3-1/8 OD 3/16 THICK
 13456 13 336 2-7/8 ID X 3-1/4 OD 3/16 THICK	 13457 14 337 3 ID X 3-3/8 OD 3/16 THICK	15	16





J&B Fleet - Industrial Supply

































22428 Harrisburg-Westville Rd. Alliance, Ohio 44601 Phone: (330) 821-6342 Fax: (330) 821-0411

www.jbfleet.com

PART # 2030

O-RINGS #4

pictures not actual size

<p>12606 ¹</p>  <p>006</p> <p>1/8 ID X 1/4 OD 15 1/16 THICK</p>	<p>12607 ²</p>  <p>007</p> <p>5/32 ID X 9/32 OD 15 1/16 THICK</p>	<p>12608 ³</p>  <p>008</p> <p>3/16 ID X 5/16 OD 15 1/16 THICK</p>	<p>12609 ⁴</p>  <p>009</p> <p>7/32 ID X 11/32 OD 15 1/16 THICK</p>	<p>12610 ⁵</p>  <p>010</p> <p>1/4 ID X 3/8 OD 15 1/16 THICK</p>	<p>12611 ⁶</p>  <p>011</p> <p>5/16 ID X 7/16 OD 15 1/16 THICK</p>	<p>12612 ⁷</p>  <p>012</p> <p>3/8 ID X 1/2 OD 15 1/16 THICK</p>	<p>39900 ⁸</p>  <p>013</p> <p>7/16 ID X 9/16 OD 15 1/16 THICK</p>
<p>39901 ⁹</p>  <p>014</p> <p>1/2 ID X 5/8 OD 10 1/16 THICK</p>	<p>39902 ¹⁰</p>  <p>015</p> <p>9/16 ID X 11/16 OD 10 1/16 THICK</p>	<p>12613 ¹¹</p>  <p>110</p> <p>3/8 ID X 9/16 OD 10 3/32 THICK</p>	<p>12614 ¹²</p>  <p>111</p> <p>7/16 ID X 5/8 OD 10 3/32 THICK</p>	<p>12615 ¹³</p>  <p>112</p> <p>1/2 ID X 11/16 OD 10 3/32 THICK</p>	<p>12616 ¹⁴</p>  <p>113</p> <p>9/16 ID X 3/4 OD 10 3/32 THICK</p>	<p>12617 ¹⁵</p>  <p>114</p> <p>5/8 ID X 13/16 OD 10 3/32 THICK</p>	<p>39940 ¹⁶</p>  <p>115</p> <p>11/16 ID X 7/8 OD 5 3/32 THICK</p>
<p>12618 ¹⁷</p>  <p>115</p> <p>11/16 ID X 7/8 OD 5 3/32 THICK</p>	<p>12619 ¹⁸</p>  <p>116</p> <p>3/4 ID X 15/16 OD 5 3/32 THICK</p>	<p>39941 ¹⁹</p>  <p>117</p> <p>13/16 ID X 1 OD 5 3/32 THICK</p>	<p>39942 ²⁰</p>  <p>118</p> <p>7/8 ID X 1-1/16 OD 5 3/32 THICK</p>	<p>39943 ²¹</p>  <p>119</p> <p>15/16 ID X 1-1/8 OD 5 3/32 THICK</p>	<p>39944 ²²</p>  <p>120</p> <p>1 ID X 1-3/16 OD 5 3/32 THICK</p>	<p>39944 ²³</p>  <p>121</p> <p>1-1/16 ID X 1-1/4 OD 5 3/32 THICK</p>	<p>39944 ²⁴</p>  <p>122</p> <p>1 ID X 1-3/16 OD 5 3/32 THICK</p>
<p>39986 ²⁵</p>  <p>209</p> <p>11/16 ID X 15/16 OD 5 1/8 THICK</p>	<p>12620 ²⁶</p>  <p>210</p> <p>3/4 ID X 1 OD 5 1/8 THICK</p>	<p>12621 ²⁷</p>  <p>211</p> <p>13/16 ID X 1-1/16 OD 5 1/8 THICK</p>	<p>12622 ²⁸</p>  <p>212</p> <p>7/8 ID X 1-1/8 OD 5 1/8 THICK</p>	<p>12623 ²⁹</p>  <p>213</p> <p>15/16 ID X 1-3/16 OD 5 1/8 THICK</p>	<p>12624 ³⁰</p>  <p>214</p> <p>1 ID X 1-1/4 OD 5 1/8 THICK</p>	<p>12625 ³¹</p>  <p>215</p> <p>1-1/16 ID X 1-5/16 OD 5 1/8 THICK</p>	<p>12626 ³²</p>  <p>216</p> <p>1-1/8 ID X 1-3/8 OD 5 1/8 THICK</p>



























J&B Fleet - Industrial Supply

22428 Harrisburg-Westville Rd. Alliance, Ohio 44601 Phone: (330) 821-6342 Fax: (330) 821-0411

www.jbfleet.com

PART # 2031

O-RINGS #5

<p>12627 ¹</p>  <p>217</p> <p>1-3/16 ID X 1-7/16 OD</p> <p>5 1/8 THICK</p>	<p>12628 ²</p>  <p>218</p> <p>1-1/4 ID X 1-1/2 OD</p> <p>5 1/8 THICK</p>	<p>12629 ³</p>  <p>219</p> <p>1-5/16 ID X 1-9/16 OD</p> <p>5 1/8 THICK</p>	<p>12630 ⁴</p>  <p>220</p> <p>1-3/8 ID X 1-5/8 OD</p> <p>5 1/8 THICK</p>	<p>12631 ⁵</p>  <p>221</p> <p>1-7/16 ID X 1-11/16 OD</p> <p>5 1/8 THICK</p>	<p>13453 ⁶</p>  <p>333</p> <p>2-1/2 ID X 2-7/8 OD</p> <p>3 3/16 THICK</p>
<p>12632 ⁷</p>  <p>222</p> <p>1-1/2 ID X 1-3/4 OD</p> <p>5 1/8 THICK</p>	<p>39980 ⁸</p>  <p>223</p> <p>1-5/8 ID X 1-7/8 OD</p> <p>5 1/8 THICK</p>	<p>39981 ⁹</p>  <p>224</p> <p>1-3/4 ID X 2 OD</p> <p>5 1/8 THICK</p>	<p>39982 ¹⁰</p>  <p>225</p> <p>1-7/8 ID X 2-1/8 OD</p> <p>5 1/8 THICK</p>	<p>39983 ¹¹</p>  <p>226</p> <p>2 ID X 2-1/4 OD</p> <p>3 1/8 THICK</p>	<p>13454 ¹²</p>  <p>334</p> <p>2-5/8 ID X 3 OD</p> <p>3 3/16 THICK</p>
<p>39984 ¹³</p>  <p>227</p> <p>2-1/8 ID X 2-3/8 OD</p> <p>3 1/8 THICK</p>	<p>39985 ¹⁴</p>  <p>228</p> <p>2-1/4 ID X 2-1/2 OD</p> <p>3 1/8 THICK</p>	<p>12633 ¹⁵</p>  <p>325</p> <p>1-1/2 ID X 1-7/8 OD</p> <p>5 3/16 THICK</p>	<p>12634 ¹⁶</p>  <p>326</p> <p>1-5/8 ID X 2 OD</p> <p>5 3/16 THICK</p>	<p>12635 ¹⁷</p>  <p>327</p> <p>1-3/4 ID X 2-1/8 OD</p> <p>5 3/16 THICK</p>	<p>13455 ¹⁸</p>  <p>335</p> <p>2-3/4 ID X 3-1/8 OD</p> <p>3 3/16 THICK</p>
<p>13448 ¹⁹</p>  <p>328</p> <p>1-7/8 ID X 2-1/4 OD</p> <p>5 3/16 THICK</p>	<p>13449 ²⁰</p>  <p>329</p> <p>2 ID X 2-3/8 OD</p> <p>5 3/16 THICK</p>	<p>13450 ²¹</p>  <p>330</p> <p>2-1/8 ID X 2-1/2 OD</p> <p>5 3/16 THICK</p>	<p>13451 ²²</p>  <p>331</p> <p>2-1/4 ID X 2-5/8 OD</p> <p>3 3/16 THICK</p>	<p>13452 ²³</p>  <p>332</p> <p>2-3/8 ID X 2-3/4 OD</p> <p>3 3/16 THICK</p>	<p>24</p>

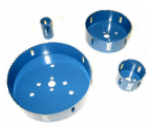
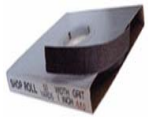

LET US HELP YOU MAKE THE CONNECTION

PART # 3017



O-RINGS



J & B FLEET-INDUSTRIAL SUPPLY
PHONE: 330-821-6342

12607 9/32 OD 1/16 THICK 25	12608 5/16 OD 1/16 THICK 25	12609 11/32 OD 1/16 THICK 25	12610 3/8 OD 1/16 THICK 25	12611 7/16 OD 1/16 THICK 25	12612 1/2 OD 1/16 THICK 25
12613 9/16 OD 3/32 THICK 25	12614 5/8 OD 3/32 THICK 25	12615 11/16 OD 3/32 THICK 25	12616 3/4 OD 3/32 THICK 10	12617 13/16 OD 3/32 THICK 10	12618 7/8 OD 3/32 THICK 10
12619 15/16 OD 3/32 THICK 10	12620 1" OD 1/8 THICK 10	12621 1-1/16 OD 1/8 THICK 10	12622 1-1/8 OD 1/8 THICK 10	12623 1-3/16 OD 1/8 THICK 10	12624 1-1/4 OD 1/8 THICK 10

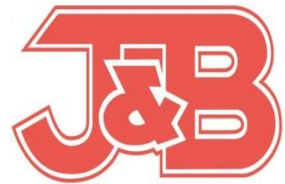
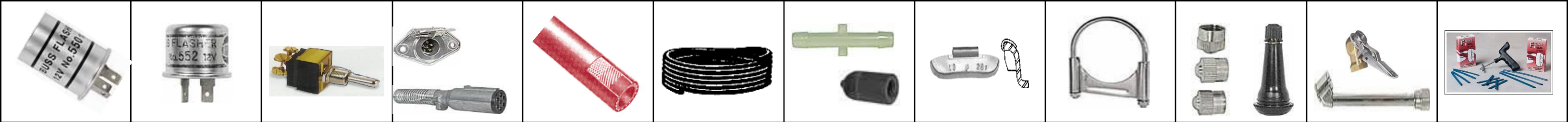









J&B Fleet - Industrial Supply

22428 Harrisburg-Westville Rd. Alliance, Ohio 44601 Phone: (330) 821-6342 Fax: (330) 821-0411

www.jbfleet.com

O-RING FACE SEAL O-RING 90 DUROMETER NITRILE

PART # 2810

<p>56230</p>  <p>-4 1/4" END SIZE</p> <p>10</p>	<p>56233</p>  <p>-10 5/8" END SIZE</p> <p>10</p>	<p>56236</p>  <p>-16 1" END SIZE</p> <p>5</p>	
<p>56231</p>  <p>-6 3/8" END SIZE</p> <p>10</p>	<p>56234</p>  <p>-12 3/4" END SIZE</p> <p>5</p>	<p>56237</p>  <p>-20 1-1/4" END SIZE</p> <p>5</p>	
<p>56232</p>  <p>-8 1/2" END SIZE</p> <p>10</p>	<p>56235</p>  <p>-14 7/8" END SIZE</p> <p>5</p>	<p>56238</p>  <p>-24 1-1/2" END SIZE</p> <p>5</p>	













PART # 2811

J&B Fleet - Industrial Supply

22428 Harrisburg-Westville Rd. Alliance, Ohio 44601 Phone: (330) 821-6342 Fax: (330) 821-0411

www.jbfleet.com

**SAE STRAIGHT THREAD PORT O-RINGS
90 DUROMETER NITRILE**

<p>56260</p>  <p>-4 1/4" END SIZE</p> <p>20</p>	<p>56266</p>  <p>-8 1/2" END SIZE</p> <p>15</p>	<p>56272</p>  <p>-16 1" END SIZE</p> <p>10</p>	
<p>56262</p>  <p>-5 5/16" END SIZE</p> <p>20</p>	<p>56268</p>  <p>-10 5/8" END SIZE</p> <p>10</p>	<p>56274</p>  <p>-20 1-1/4" END SIZE</p> <p>5</p>	
<p>56264</p>  <p>-6 3/8" END SIZE</p> <p>20</p>	<p>56270</p>  <p>-12 3/4" END SIZE</p> <p>10</p>		



O-RING ASSORTMENTS

METRIC

- Convenient re-sealable plastic case.
- 419 o-rings. 32 sizes.

I/D	Section	I/D	Section
3	1.5mm	20	3.5mm
4.4	2.0mm	22	3.5mm
5	2.0mm	23.5	3.5mm
7	1.5mm	25	3.5mm
10	1.5mm	26.5	3.5mm
13	1.5mm	28	3.5mm
10	2.5mm	30	3.5mm
11	2.5mm	31	3.5mm
13	2.5mm	33	3.5mm
14	2.5mm	34.5	3.5mm
16	2.5mm	36	3.5mm
18	2.5mm	38	3.5mm
19	2.5mm	41	3.5mm
21	2.5mm	44	3.5mm
22	2.5mm	47	3.5mm
18	3.5mm	50	3.5mm



J&B #

2072

STANDARD

- Convenient re-sealable plastic case.
- 382 o-rings. 30 sizes.

I/D	Section	I/D	Section
1/8	1/16	13/16	1/8
5/32	1/16	7/8	1/8
3/16	1/16	15/16	1/8
7/32	1/16	1"	1/8
1/4	1/16	1-1/16	1/8
5/16	1/16	1-1/8	1/8
3/8	1/16	1-3/16	1/8
3/8	3/32	1-1/4	1/8
7/16	3/32	1-5/16	1/8
1/2	3/32	1-3/8	1/8
9/16	3/32	1-7/16	1/8
5/8	3/32	1-1/2	1/8
11/16	3/32	1-1/2	3/16
3/4	3/32	1-5/8	3/16
3/4	1/8	1-3/4	3/16



J&B #

2071

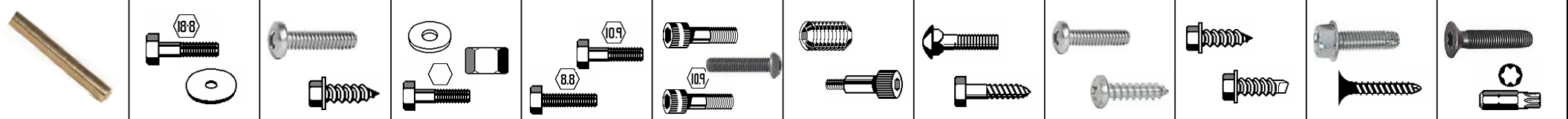

























J&B Fleet - Industrial Supply

22428 Harrisburg-Westville Rd. Alliance, Ohio 44601 Phone: (330) 821-6342 Fax: (330) 821-0411

www.jbfleet.com

PART # 2220

RUBBER GROMMETS

<p>38201 ¹</p>  <p>1/8 BORE 3/32 GROOVE 1/2 OD 5/16 THICKNESS</p> <p>5</p>	<p>38172 ²</p>  <p>5/32 BORE 1/16 GROOVE 3/8 OD 3/16 THICKNESS</p> <p>5</p>	<p>38202 ³</p>  <p>3/16 BORE 1/16 GROOVE 1/2 OD 1/4 THICKNESS</p> <p>5</p>	<p>38173 ⁴</p>  <p>3/16 BORE 1/4 GROOVE 7/16 OD 3/8 THICKNESS</p> <p>5</p>	<p>38204 ⁵</p>  <p>1/4 BORE 1/4 GROOVE 5/8 OD 3/16 THICKNESS</p> <p>5</p>	<p>38205 ⁶</p>  <p>1/4 BORE 1/4 GROOVE 1-1/4 OD 1/4 THICKNESS</p> <p>5</p>
<p>38206 ⁷</p>  <p>5/16 BORE 1/16 GROOVE 13/16 OD 5/16 THICKNESS</p> <p>5</p>	<p>38207 ⁸</p>  <p>5/16 BORE 1/8 GROOVE 13/16 OD 3/8 THICKNESS</p> <p>5</p>	<p>38208 ⁹</p>  <p>5/16 BORE 1/4 GROOVE 13/16 OD 1/2 THICKNESS</p> <p>5</p>	<p>38209 ¹⁰</p>  <p>3/8 BORE 1/16 GROOVE 5/8 OD 9/32 THICKNESS</p> <p>5</p>	<p>38210 ¹¹</p>  <p>3/8 BORE 1/16 GROOVE 1-1/4 OD 1/4 THICKNESS</p> <p>5</p>	<p>38211 ¹²</p>  <p>5</p>
<p>38213 ¹³</p>  <p>1/2 BORE 3/32 GROOVE 31/32 OD 9/32 THICKNESS</p> <p>5</p>	<p>38216 ¹⁴</p>  <p>1/2 BORE 1/4 GROOVE 1-1/16 OD 1/2 THICKNESS</p> <p>5</p>	<p>38217 ¹⁵</p>  <p>5/8 BORE 1/8 GROOVE 1-1/8 OD 3/8 THICKNESS</p> <p>5</p>	<p>38218 ¹⁶</p>  <p>5/8 BORE 1/16 GROOVE 1-1/8 OD 5/16 THICKNESS</p> <p>5</p>	<p>38219 ¹⁷</p>  <p>5</p>	<p>38220 ¹⁸</p>  <p>5</p>
<p>38220 ¹⁹</p>  <p>3/4 BORE 1/16 GROOVE 1-3/8 OD 3/8 THICKNESS</p> <p>5</p>	<p>38221 ²⁰</p>  <p>5</p>	<p>38221 ²¹</p>  <p>3/4 BORE 1/16 GROOVE 1-5/8 OD 1/4 THICKNESS</p> <p>5</p>	<p>38222 ²²</p>  <p>5</p>	<p>38222 ²³</p>  <p>3/4 BORE 1/4 GROOVE 1-5/8 OD 7/16 THICKNESS</p> <p>5</p>	<p>38223 ²⁴</p>  <p>5</p>

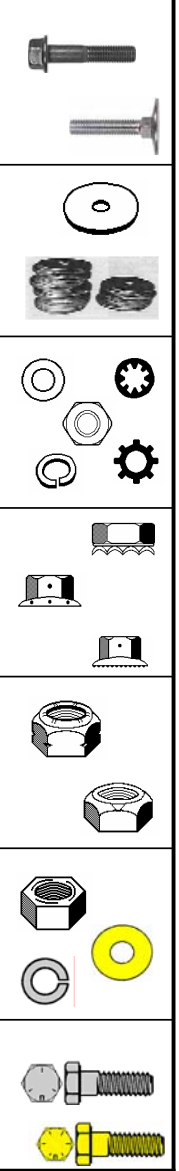

LET US HELP YOU MAKE THE CONNECTION

PART # 3035



GROMMETS



J & B FLEET-INDUSTRIAL SUPPLY
PHONE: 330-821-6342

<p>38201</p> <p>1/8 BORE 3/32 GROOVE 1/2 OD 5/16 THICKNESS</p> <p>5</p>	<p>38172</p> <p>5/32 BORE 1/16 GROOVE 3/8 OD 3/16 THICKNESS</p> <p>5</p>	<p>38202</p> <p>3/16 BORE 1/16 GROOVE 1/2 OD 1/4 THICKNESS</p> <p>5</p>	<p>38173</p> <p>3/16 BORE 1/4 GROOVE 7/16 OD 3/8 THICKNESS</p> <p>5</p>	<p>38204</p> <p>1/4 BORE 1/4 GROOVE 7/16 OD 3/16 THICKNESS</p> <p>5</p>	<p>38205</p> <p>1/4 BORE 1/4 GROOVE 1-1/4 OD 1/4 THICKNESS</p> <p>5</p>
<p>38206</p> <p>5/16 BORE 1/16 GROOVE 13/16 OD 5/16 THICKNESS</p> <p>5</p>	<p>38207</p> <p>5/16 BORE 1/8 GROOVE 13/16 OD 3/8 THICKNESS</p> <p>5</p>	<p>38208</p> <p>5/16 BORE 1/4 GROOVE 13/16 OD 1/2 THICKNESS</p> <p>5</p>	<p>38209</p> <p>3/8 BORE 1/16 GROOVE 5/8 OD 9/32 THICKNESS</p> <p>5</p>	<p>38213</p> <p>1/2 BORE 3/32 GROOVE 31/32 OD 9/32 THICKNESS</p> <p>5</p>	

























J&B Fleet - Industrial Supply

22428 Harrisburg-Westville Rd. Alliance, Ohio 44601 Phone: (330) 821-6342 Fax: (330) 821-0411

www.jbfleet.com

PART # 2068

INTERNAL RETAINING RINGS

 10638 ¹ 10 1/4	 10642 ² 10 1/2	 10645 ³ 15 3/4	 40032 ⁴ 5 1-1/16	 40046 ⁶ 2 1-7/16
 10639 ⁷ 10 5/16	 10643 ⁸ 10 9/16	 40031 ⁹ 10 13/16	 10648 ¹⁰ 5 1-1/8	 40047 ¹² 2 1-1/2
 10640 ¹³ 10 3/8	 10644 ¹⁴ 10 5/8	 10646 ¹⁵ 10 7/8	 40033 ¹⁶ 5 1-3/16	 40044 ¹⁷ 2 1-5/16
 10641 ¹⁹ 10 7/16	 40030 ²⁰ 10 11/16	 10647 ²¹ 10 1"	 10649 ²² 5 1-1/4	 40045 ²³ 2 1-3/8
				 40048 ¹⁸ 2 1-5/8
				 40049 ²⁴ 2 1-3/4





































J&B Fleet - Industrial Supply

22428 Harrisburg-Westville Rd. Alliance, Ohio 44601 Phone: (330) 821-6342 Fax: (330) 821-0411

www.jbfleet.com

PART # 2036

RETAINING RINGS

 10638 ¹ 20 1/4	 10639 ² 20 5/16	 10640 ³ 20 3/8	 10641 ⁴ 15 7/16	 10642 ⁵ 15 1/2	 10643 ⁶ 10 9/16	 10644 ⁷ 10 5/8	 10645 ⁸ 5 3/4
 10646 ⁹ 5 7/8	 10647 ¹⁰ 5 1	 10648 ¹¹ 3 1-1/8	 10649 ¹² 3 1-1/4	 40044 ¹³ 3 1-5/16	 40045 ¹⁴ 3 1-3/8	 40047 ¹⁵ 3 1-1/2	 40049 ¹⁶ 2 1-3/4
 10650 ¹⁷ 20 1/4	 10651 ¹⁸ 20 5/16	 10652 ¹⁹ 20 3/8	 10653 ²⁰ 15 7/16	 10654 ²¹ 15 1/2	 10655 ²² 10 9/16	 10656 ²³ 10 5/8	 10657 ²⁴ 5 3/4
 10658 ²⁵ 5 7/8	 10659 ²⁶ 5 1	 10660 ²⁷ 3 1-1/8	 10661 ²⁸ 3 1-1/4	 40060 ²⁹ 3 1-5/16	 40061 ³⁰ 3 1-3/8	 40063 ³¹ 3 1-1/2	 40065 ³² 2 1-3/4



LET US HELP YOU MAKE THE CONNECTION

PART # 3013



INTERNAL SNAP RINGS



J & B FLEET-INDUSTRIAL SUPPLY
PHONE: 330-821-6342

10638 1/4" 10	10639 5/16" 10	10640 3/8" 10	10641 7/16" 5	10642 1/2" 5	10643 9/16" 4
10644 5/8" 4	40030 11/16" 4	10645 3/4" 4	40031 13/16" 4	10646 7/8" 4	10647 1" 4
40032 1-1/16" 2	10648 1-1/8" 2	40033 1-3/16" 2	10649 1-1/4" 2	40044 1-5/16" 2	40045 1-3/8" 2

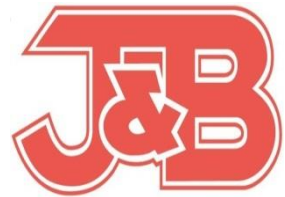

































J&B Fleet - Industrial Supply

www.jbfleet.com

22428 Harrisburg-Westville Rd. Alliance, Ohio 44601 Phone: (330) 821-6342 Fax: (330) 821-0411

EXTERNAL RETAINING RINGS

PART # 2066

 87000 ¹ 10 1/8"	 10651 ² 10 5/16"	 10653 ³ 10 7/16"	 10762 ⁴ 5 11/16"	 87003 ⁵ 5 15/16"	 40059 ⁶ 3 1-3/16"	 40062 ⁷ 3 1-7/16"	 87004 ⁸ 2 1-7/8"
 40055 ⁹ 10 3/16"	 40057 ¹⁰ 10 11/32"	 10654 ¹¹ 10 1/2"	 10657 ¹² 10 3/4"	 10659 ¹³ 5 1"	 10661 ¹⁴ 3 1-1/4"	 40063 ¹⁵ 2 1-1/2"	 40066 ¹⁶ 2 2"
 10650 ¹⁷ 20 1/4"	 10652 ¹⁸ 10 3/8"	 10655 ¹⁹ 10 9/16"	 87002 ²⁰ 5 13/16"	 40058 ²¹ 5 1-1/16"	 40060 ²² 3 1-5/16"	 40064 ²³ 2 1-5/8"	 87006 ²⁴ 2 2-1/4"
 40056 ²⁵ 10 9/32"	 87001 ²⁶ 10 13/32"	 10656 ²⁷ 10 5/8"	 10658 ²⁸ 5 7/8"	 10660 ²⁹ 5 1-1/8"	 40061 ³⁰ 3 1-3/8"	 40065 ³¹ 2 1-3/4"	 87008 ³² 2 2-1/2"

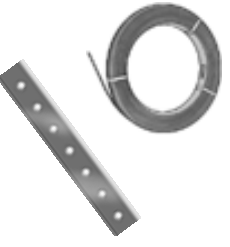

LET US HELP YOU MAKE THE CONNECTION

PART # 3009



RETAINING RINGS



J & B FLEET-INDUSTRIAL SUPPLY
PHONE: 330-821-6342

10650 1/4" External 10	10651 5/16" External 10	10652 3/8" External 10	10653 7/16" External 5	10654 1/2" External 5	10655 9/16" External 4
10656 5/8" External 4	10657 3/4" External 4	10659 1" External 4	10638 1/4" Internal 10	10639 5/16" Internal 10	10640 3/8" Internal 10
10641 7/16" Internal 5	10642 1/2" Internal 5	10643 9/16" Internal 4	10644 5/8" Internal 4	10645 3/4" Internal 4	10647 1" Internal 4

LET US HELP YOU MAKE THE CONNECTION

PART # 3011



EXTERNAL SNAP RINGS



J & B FLEET-INDUSTRIAL SUPPLY
PHONE: 330-821-6342

10650 1/4" 10	40056 9/32" 10	10651 5/16" 10	40057 11/32" 5	10652 3/8" 5	10653 7/16" 4
10654 1/2" 4	10655 9/16" 4	10656 5/8" 4	10657 3/4" 4	10658 7/8" 4	10659 1" 4
40058 1-1/16" 2	10660 1-1/8" 2	40059 1-3/16" 2	10661 1-1/4" 2	40060 1-5/16" 2	40061 1-3/8" 2

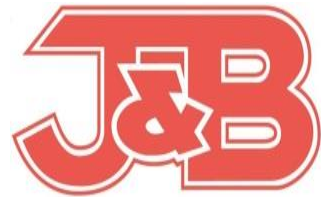





















J&B Fleet - Industrial Supply

www.jbfleet.com

22428 Harrisburg-Westville Rd. Alliance, Ohio 44601 Phone: (330) 821-6342 Fax: (330) 821-0411

PART # 2039

RETAINING RINGS

<p>12706 ¹</p>  <p>25 1/16"</p>	<p>12711 ²</p>  <p>25 3/32"</p>	<p>12712 ³</p>  <p>25 1/8"</p>	<p>12707 ⁴</p>  <p>25 9/64"</p>	<p>12713 ⁵</p>  <p>25 5/32"</p>	<p>12708 ⁶</p>  <p>25 11/64"</p>	<p>12714 ⁷</p>  <p>25 3/16"</p>	<p>12717 ⁸</p>  <p>25 7/32"</p>
<p>12715 ⁹</p>  <p>25 1/4"</p>	<p>12716 ¹⁰</p>  <p>25 5/16"</p>	<p>10951 ¹¹</p>  <p>25 3/8"</p>	<p>12718 ¹²</p>  <p>25 7/16"</p>	<p>12719 ¹³</p>  <p>25 1/2"</p>	<p>12768 ¹⁴</p>  <p>25 9/16"</p>	<p>11094 ¹⁵</p>  <p>25 5/8"</p>	<p>11095 ¹⁶</p>  <p>25 3/4"</p>
<p>11096 ¹⁷</p>  <p>20 7/8"</p>	<p>11097 ¹⁸</p>  <p>20 1"</p>	<p>12709 ¹⁹</p>  <p>20 1-3/16"</p>	<p>12710 ²⁰</p>  <p>20 1-3/8"</p>	<p>²¹</p>	<p>²²</p>	<p>²³</p>	<p>²⁴</p>
<p>²⁵</p>	<p>²⁶</p>	<p>²⁷</p>	<p>²⁸</p>	<p>²⁹</p>	<p>³⁰</p>	<p>³¹</p>	<p>³²</p>

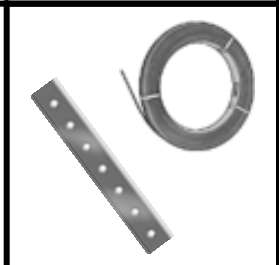

LET US HELP YOU MAKE THE CONNECTION

PART # 3015



E - RINGS



J & B FLEET-INDUSTRIAL SUPPLY
PHONE: 330-821-6342

12706 1/16" 20	12711 3/32" 20	12712 1/8" 20	12707 9/64" 20	12713 5/32" 20	12708 11/64" 15
12714 3/16" 15	12717 7/32" 15	12715 1/4" 15	12716 5/16" 10	10951 3/8" 10	12718 7/16" 10
12719 1/2" 10	12768 9/16" 5	11094 5/8" 5	11095 3/4" 5	11096 7/8" 5	11097 1" 5