

Super Complete

U. S. Suggested Retail Price List
Jan-19

Mini, Small, Medium, Large

Phone: 260-665-2769

Fax: 260-665-3047

Email: iim@mobility-usa.com

www.mobility-usa.com

Quote: _____

P.O. _____

Bill To

Dealer: _____ Contact: _____

Address: _____

City: _____ State: _____ Zip: _____

Phone: _____ Fax: _____

Email: _____ Mark For: _____

Ship To

Same as Bill To _____

Dealer: _____ Contact: _____

Address: _____

City: _____ State: _____ Zip: _____

Phone: _____ Fax: _____

Email: _____ Mark For: _____

Grillo Features and Specifications Mini, Small, Medium, Large

- **Quick Adjustment** - Grillo adjusts easily and tool-free for user growth, transportation, or multiple patient use.
- **Easy Transport** - In just one motion, Grillo folds into a small compact unit easy to transport. No tools required.
- **Exclusively-Designed Wheels** - Grillo wheels come standard with anti-rollback, independently adjustable tension drag, and brakes. The wheels are suitable for indoor and outdoor use.
- **Chest & Pelvic Supports** - Padded and adjustable in angle, height, inclination, and circumference. The chest and pelvic supports work independently.
- **Ergonomic Harness** - The harness supports the user if necessary without generating pressure and is breathable, adjustable, and removable.
- **Measurement Bars** - allow for quick, easy, and accurate adjustment.
- **Grillo** - has the widest range of height adjustment on the market.



Grillo Frame Options

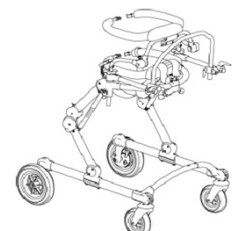

Part Number	Description	Price
	Posterior SC - includes frame, pelvic support, ergonomic harness, chest support, horizontal bars, hand grips, directional locks	
_____ GRP	Super Complete Grillo Mini	\$3,400.00
_____ GRP-1/2	Super Complete Grillo Small	\$3,500.00
_____ GRP-3/4	Super Complete Grillo Medium	\$3,800.00
_____ GRP-5	Super Complete Grillo Large	\$4,300.00
	Anterior SC - includes frame, pelvic support, ergonomic harness, chest support, horizontal bars, multi axis hardware, handle bar, directional locks	
_____ GRA	Super Complete Grillo Mini	\$3,500.00
_____ GRA-1/2	Super Complete Grillo Small	\$3,625.00
_____ GRA-3/4	Super Complete Grillo Medium	\$3,950.00
_____ GRA-5	Super Complete Grillo Large	\$4,475.00



Handle Options

Part Number	Description	Price	
_____ GR927	Posterior Hand Grips Mn requires GR835	\$50.00	
_____ GR927-1/2	Posterior Hand Grips Sm, Md, Lg requires GR835-1, GR835-3	\$50.00	
_____ GR926	Anterior Handlebar Mn requires GRI-HW, GR835	\$100.00	
_____ GRI845-1	Anterior Handle Bar Sm requires GRI-HW-1, GR835-1	\$100.00	
_____ GRI845-3	Anterior Handle Bar Md requires GRI-HW-1, GR835-3	\$125.00	
_____ GRI845-5	Anterior Handle Bar Lg requires GRI-HW-1, GR835-3	\$150.00	
_____ GRI939	Ergonomic Handles Mn, Sm, Md, Lg requires GRI-HW, GR835	\$125.00	
_____ GRI-HW	Multi Axis Hardware Mn	\$75.00	
_____ GRI-HW-1	Multi Axis Hardware Sm, Md, Lg	\$75.00	

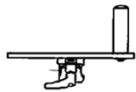
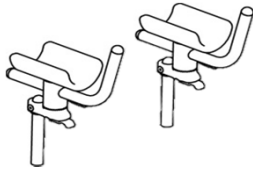
Arm Support Options

Part Number	Description	Price	
_____ GR809	Arm Supports Mn 7" long 4" wide requires GRI-HW, GR835	\$550.00	
_____ GRI809-1	Arm Supports Sm 6" long 4" wide requires GRI-HW-1, GR835-1	\$600.00	
_____ GRI809-3	Arm Supports Md 7.5" long 4.5" wide requires GRI-HW-1, GR835-3	\$650.00	
_____ GRI809-5	Arm Supports Lg 8" long 5" wide requires GRI-HW-1, GR835-5	\$650.00	
<u>Description:</u> Works with Anterior and Posterior. Adjustable in height, direction, depth, tilt, and inclination.			
_____ 943	Arm Straps Mn, Sm (pair)	\$40.00	
_____ 943-3	Arm Straps Md, Lg (pair)	\$40.00	
_____ 32707	Elbow Stop Sm, Md, Lg 4"x3" padded elbow stop (pair)	\$385.00	
_____ 50048	Elbow Stop Cover with Gel Insert (pair) requires 32707	\$250.00	

Accessories

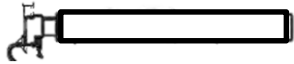
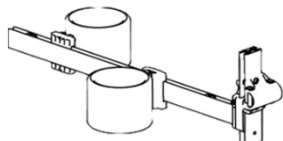
Part Number	Description	Price	
_____ GRI865	Headrest Sm, Md, Lg POSTERIOR ONLY 10" height adjustment Requires Chest Support	\$550.00	
_____ GR890-0	Padded Leg Divider Mn 22" long	\$350.00	
_____ GRI890-1	Leg Divider Sm 21" long, cuff size 10" - 16"	\$650.00	
_____ GRI890-3	Leg Divider Md 23" long, cuff size 14" - 20"	\$700.00	
_____ GRI890-5	Leg Divider Lg 28" long, cuff size 18" - 26"	\$750.00	

Description: Adjustable in height and stride length.

Accessories

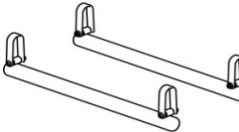
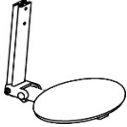
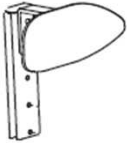
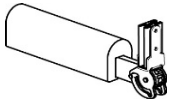
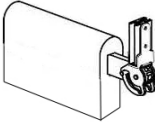
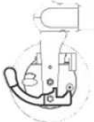
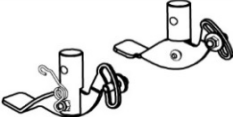
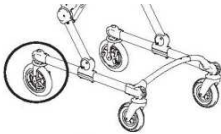
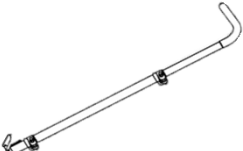
Part Number	Description	Price	
<u> </u> GR1810-1	Weight Bars Sm 11.5 lbs. total	\$275.00	
<u> </u> GR1810-3	Weight Bars Md, Lg 15 lbs. total	\$295.00	
<u> </u> GR918-1	Folding Seat Sm POSTERIOR ONLY 10" deep, 6" wide	\$335.00	
<u> </u> GR918-3	Folding Seat Md POSTERIOR ONLY 11" deep, 7" wide	\$365.00	
<u> </u> GR1919-1	Lumbar Support Sm POSTERIOR ONLY 3" tall, 8" wide	\$280.00	
<u> </u> GR1919-3	Lumbar Support Md POSTERIOR ONLY 4" tall, 9.5" wide	\$280.00	
<u> </u> GR815-1	Abduction Saddle Sm pad W: 2.5" H: 3.5" L: 10" Overall L: 14"	\$345.00	
<u> </u> GR815-3	Abduction Saddle Md pad W: 3" H: 3.5" L: 12" Overall L: 16"	\$365.00	
<u> </u> GR815-5	Abduction Saddle Lg pad W: 3" H: 4" L: 14" Overall L: 19" distance between pelvic harness and saddle top hole 4.5" bottom hole 6"	\$445.00	
<u> </u> 34429	Saddle Extension Sm 6" of extended abduction requires GR815-1	\$175.00	
<u> </u> 34430	Saddle Extension Md 6" of extended abduction requires GR815-3	\$185.00	
<u> </u> 34431	Saddle Extension Lg 6" of extended abduction requires GR815-5	\$195.00	
<u> </u> GR929-0	Pedal Parking Brakes Mn Comes attached to wheel	\$275.00	
<u> </u> GR929	Pedal Parking Brakes Sm, Md, Lg	\$275.00	
<u> </u> GR928-3/4	Narrow Rear Wheels Md with pedal brakes In-line wheel makes the overall width 27" instead of 30"	\$675.00	
<u> </u> GR928-5	Narrow Rear Wheels Lg with pedal brakes In-line wheel makes the overall width 28.5" instead of 31.5" for Lg	\$675.00	
<u> </u> GR923	Assistant Push Handle Mn, Sm, Md, Lg	\$290.00	

Client Measurements

A Back height: _____ F Lower leg length: _____
 B Chest depth: _____ G Head height: _____
 C Chest width: _____ H Arm height: _____
 D Seat depth: _____ Age: _____
 E Seat width: _____ Weight: _____

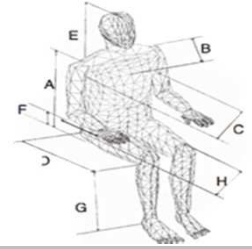

Dimensions

Measurements in Inches

Grillo	Mini	Small	Medium	Large
Max Capacity	77 lbs	99 lbs	198 lbs	242 lbs
User Height	29 - 39	35 - 53	43 - 65	59 - 75
Unit Weight	28 lbs	36 lbs	43 lbs	51 lbs
A	21 - 31	23.5 - 34	29 - 47	33 - 55
B	20 - 29.5	27 - 39	30 - 49	32 - 56
C	16.5 - 24	19 - 33	21 - 39	25 - 46
D	29	29.5	36	43.5
E	22.5	25.5	30	31.5

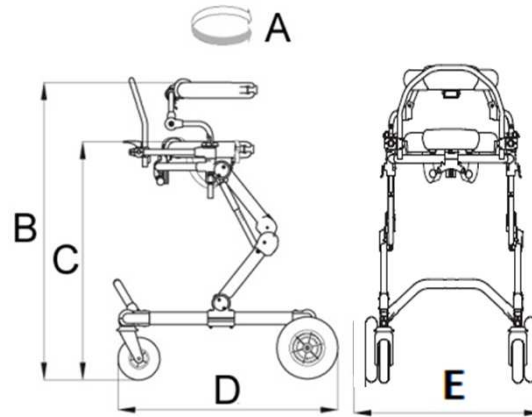

One Frame → 7 Configurations

Grillo Small & Medium

Note: All specification and prices are subject to change without notice. Prices listed are only valid if ordering with a gait trainer. The HCPCS codes provided are not intended to be billing or legal advice, rather Innovation In Motion's interpretation of the code definitions. Use of the codes provided does not ensure coverage or payment for the item. For coverage information, verify the policy of the appropriate payer. It is recommended to contact Innovation In Motion with any questions regarding proper ordering of the chair at 1-260-665-2769.