



BEAST-TEK
INSTRUMENTS

PIXEL DRUM v1.3.13

BUILD GUIDE

www.beast-tek.com



Pixel Drum IO Board BOM			
D1,D2	0.56" High Brigness 7 segment display	Red	2
N/A	Arcylic Screen	Transparent Grey	1
LED1, LED2	5mm high brightness LED	Red	2
JP1	14 Way Pin Header Single Row MALE		1
JP2	20 Way Pin Header Single Row MALE		1
SW1	Push button quadrature Encoder		1
SW2	SPDT Switch ON-ON		1
POI, POII, POIII, POP	9mm Round shaft 10KB Potentiometer		4
POD, POE	9mm T18 shaft 10KB Potentiometer		2
N/A	PJ301BM 3.5mm Mono Jack		11
L1	100uH Inductor R.F. Choke		1
C1	100nf Blue Monolithic Capacitor	104	1
R8, R19	220 OHM Resistor 1%	Red-Red-Black-Black-Brown	2
R15, R16, R17, R18, R20	1K Ohm Resistor 1%	Brown-Black-Black-Brown-Brown	5
R3, R4, R5 , R6, R12, R14	100K Ohm Resistor 1%	Brown-Black-Black-Orange-Brown	6
R13	150K Ohm Resistor 1%	Brown- Green -Black-Orange-Brown	1
R1, R2, R7, R9, R10, R11	200K Ohm Resistor 1%	Red-Black-Black-Orange-Brown	6

Pixel Drum Main (CPU) Board BOM			
IC1, IC2	74HC595N	74HC595N	2
IC3	dsPIC33f128FJ128GP802-I/SP		1
IC4, IC8, IC9, IC10, IC11, IC12	MCP602/MCP6022 High precision op-amp 5v		6
IC5	LD1117V33 3.3v Linear Regulator	LD1117V33	1
IC6	TL071	TL072	1
IC7	79L05 100MA -5v Regulator	79L05	1
C3	10uf Tantalum Capacitor	10uf	1
C18	1uf Bipolar Electrolytic Capacitor	1uf	1
C10, C16, C19, C20	100uf Electrolytic Capacitor 25+v	100uf	4
C1, C2, C4, C5, C6, C7, C8, C9, C11, C12, C13, C14, C15, C17	100nf Blue Monolithic Capacitor		14
F1, F2	Axial Ferrite Beads	N/A	2
D1, D2	1N4004 Power Diode	1N4004	2
D3	1N4148 Signal Diode	1N4148	1
L1	100uH Inductor R.F. Choke		1
R1, R2, R3, R4, R5, R6, R7, R8, R9, R10, R11, R12, R13, R14	220 OHM Resistor 1%	Red-Red-Black-Black-Brown	14
R19, R21, R44, R45, R46	10K Ohm Resistor 1%	Brown-Black-Black-Red-Brown	5
R16, R17, R18, R20, R23, R24, R25, R26, R28, R30, R37, R40	100K Ohm Resistor 1%	Brown-Black -Black-Orange-Brown	12
R29, R31, R32, R33, R34, R35, R39	150K Ohm Resistor 1%	Brown-Green-Black-Orange-Brown	7
R15, R43	200K Ohm Resistor 1%	Red-Black-Black-Orange-Brown	2
R36	300K Ohm Resistor 1%	Orange-Black-Black-Orange-Brown	1
R22, R38	1M Ohm Resistor 1%	Brown-Black-Black-Yellow-Brown	2
POWER	Shrouded 10pin (2x5) IDC Header (Eurorack Power)		1
JP1	14 Way Pin Header Single Row FEMALE		1
JP2	20 Way Pin Header Single Row FEMALE		1
JP3	6 Way Pin Header Single Row MALE	ISCP Header for PicKit3 Firmware Updates	1

IO Board – Step 1

Install and solder the five 1K resistors R15, R16, R17, R18 and R20

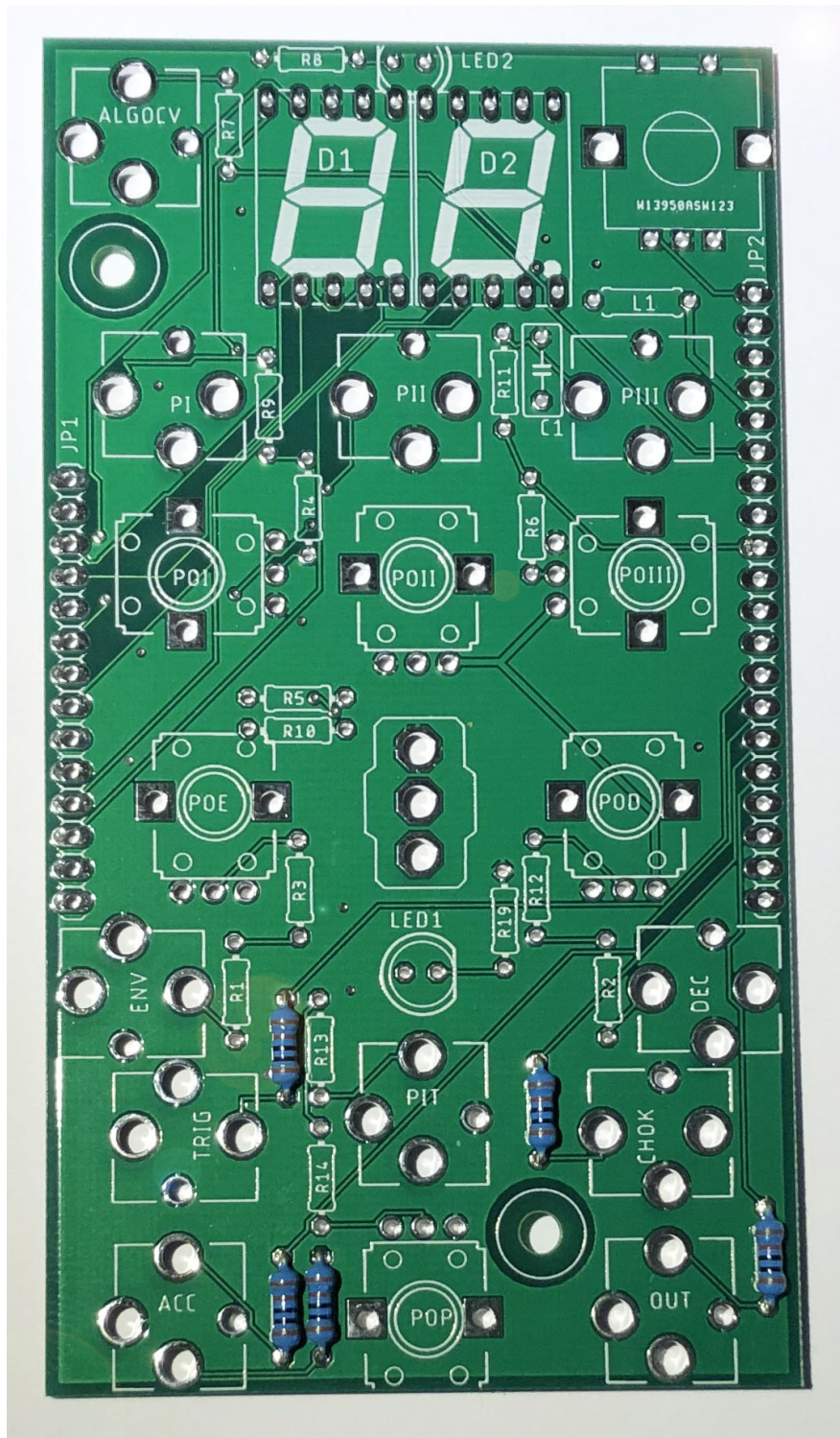

IO Board – Step 2

Install and solder the six 100K resistors R3, R4, R5, R6, R12 and R14

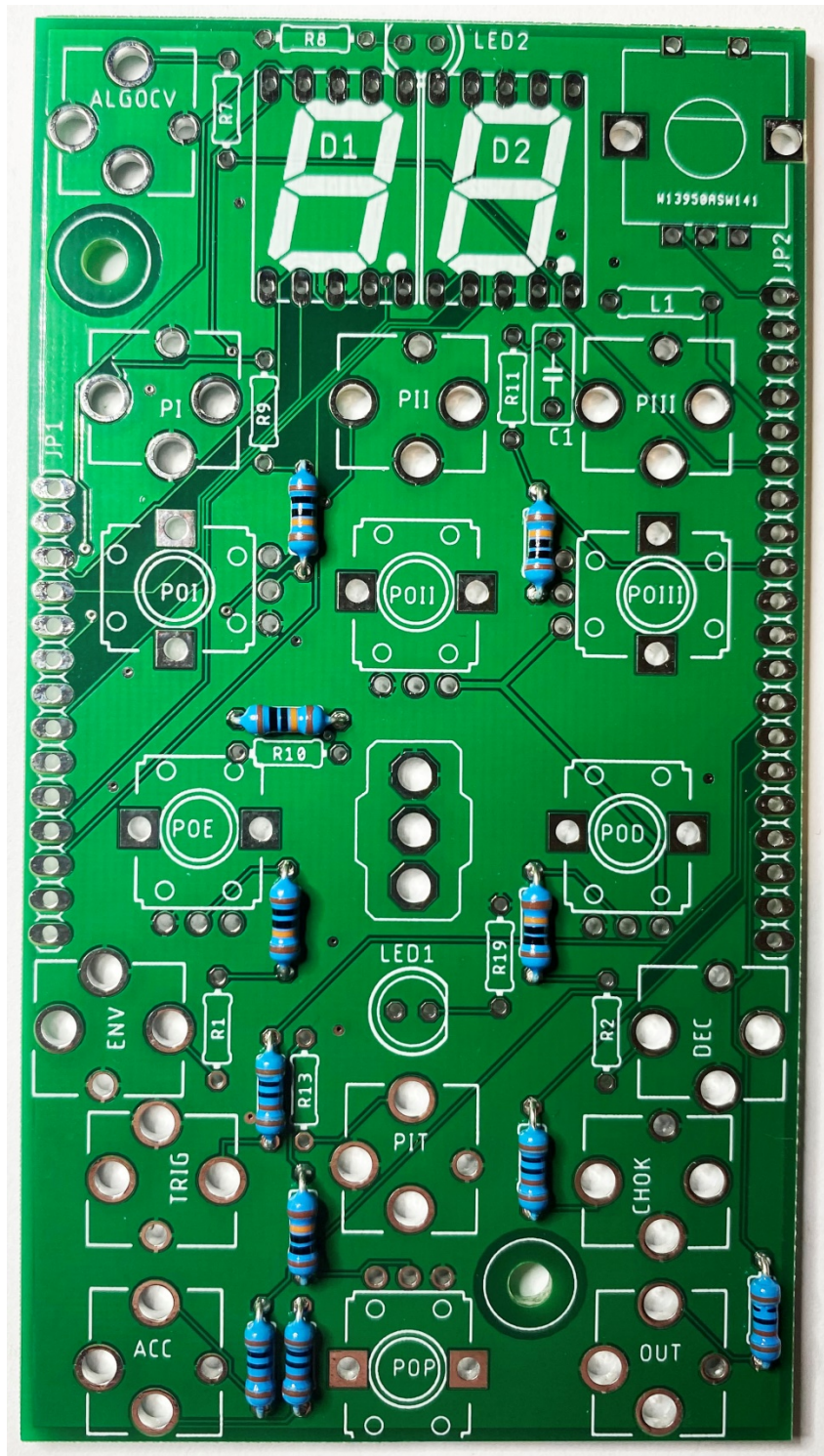

IO Board – Step 3

Install and solder the six 200K resistors R1, R2, R7, R9, R10, R11

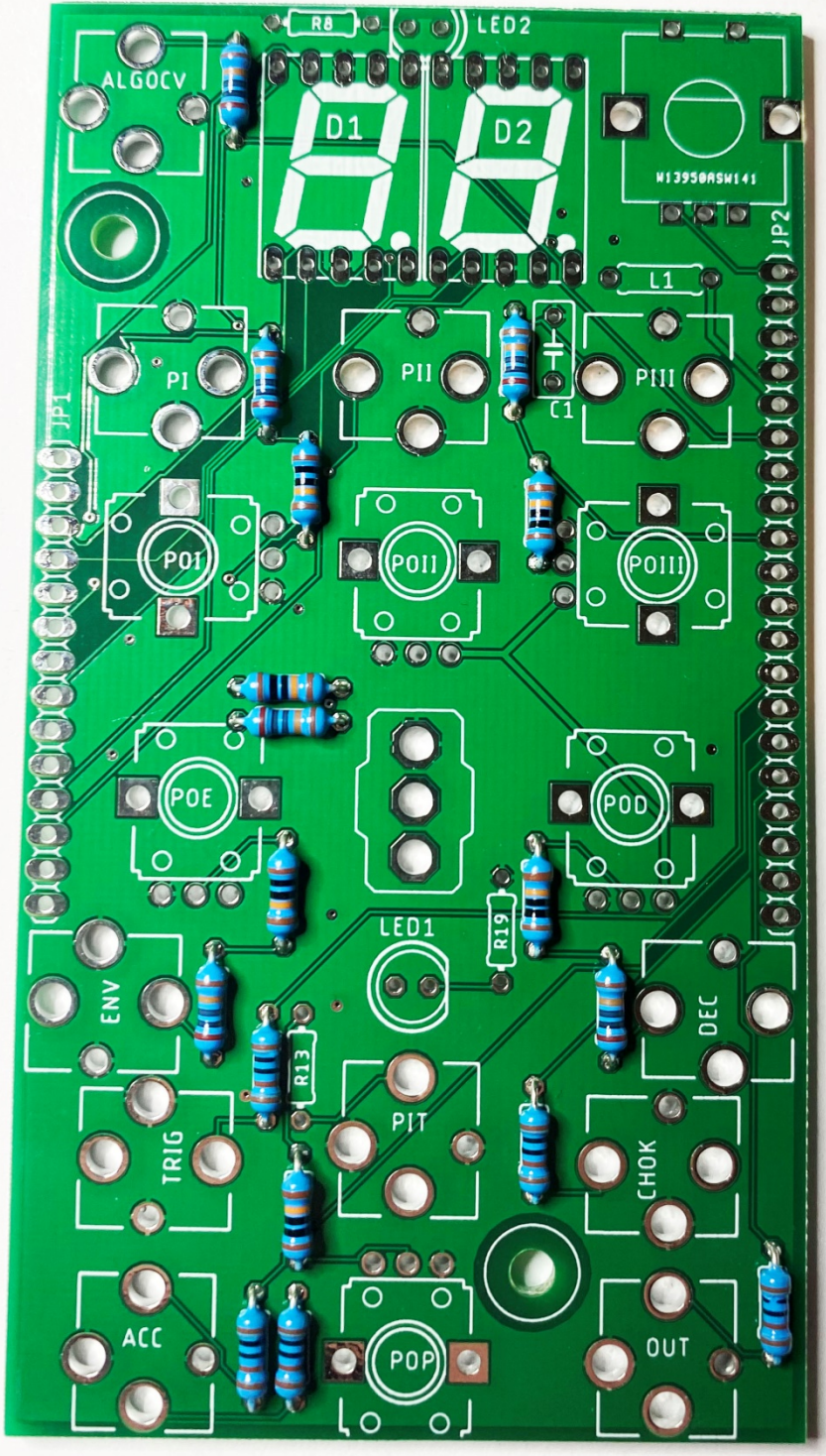

IO Board – Step 4

Install and solder the one 150K resistor R13

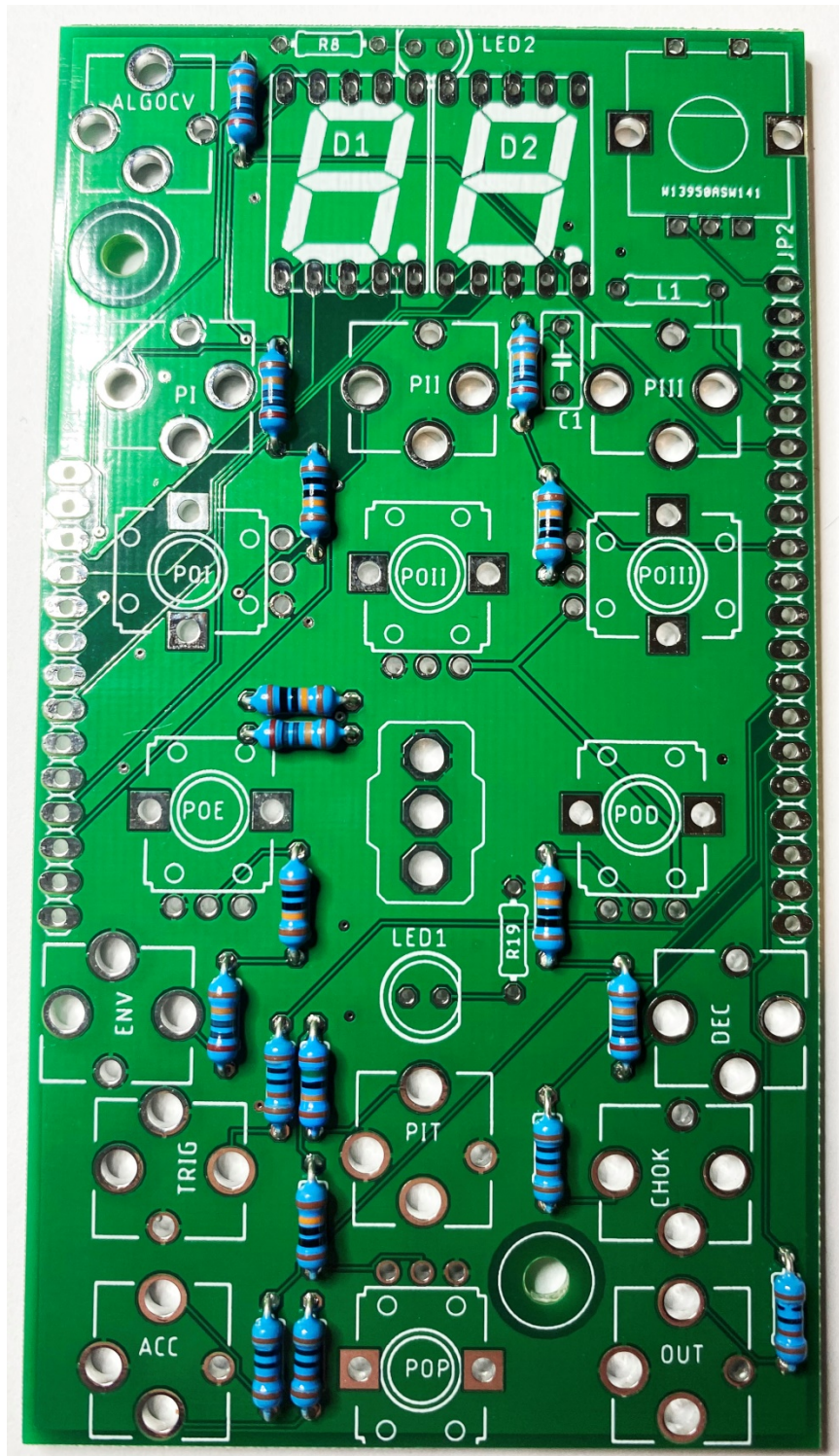

IO Board – Step 5

Install and solder the two 220 ohm resistors R8 and R19

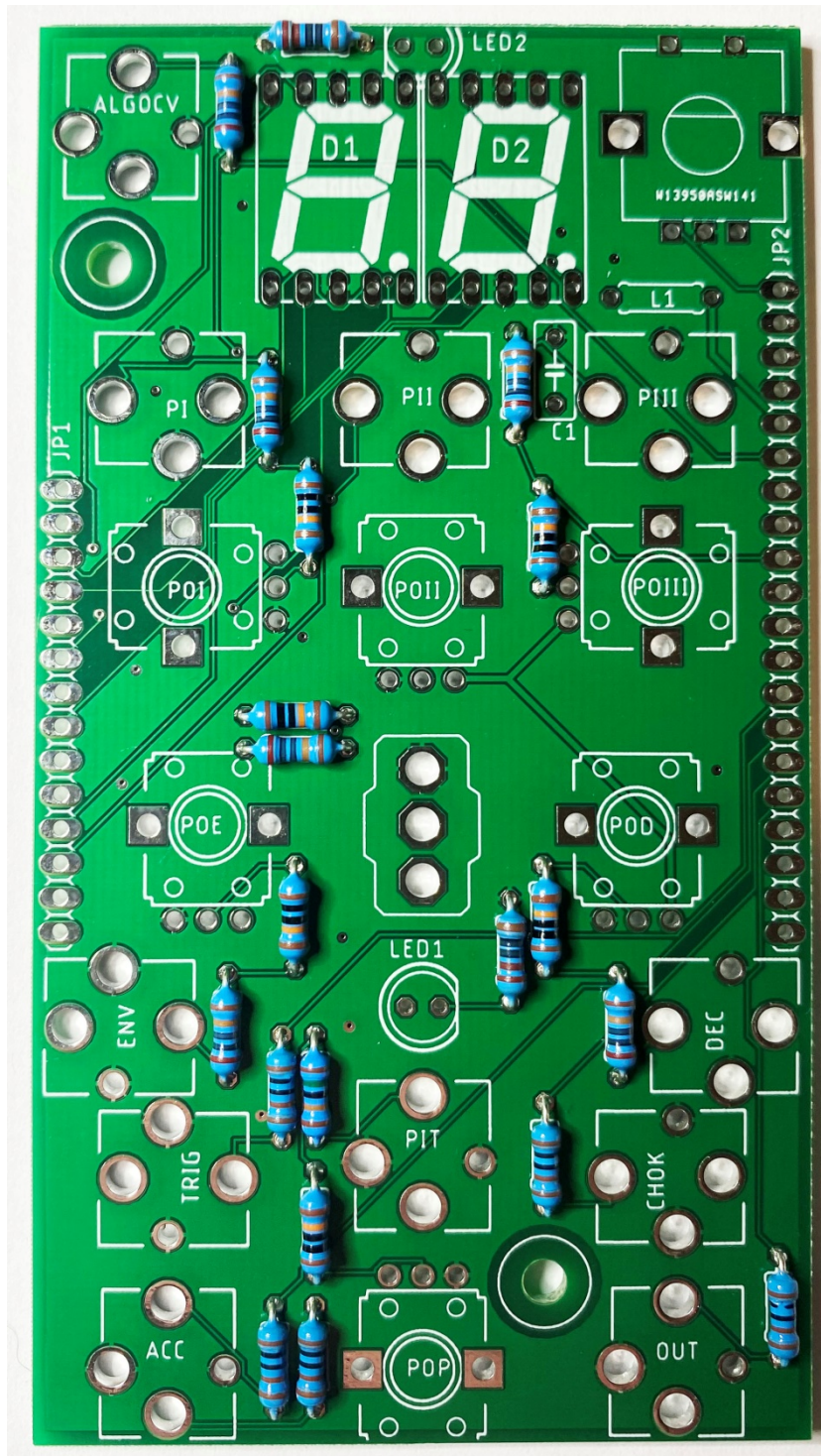

IO Board – Step 6

Install and solder C1 and L1

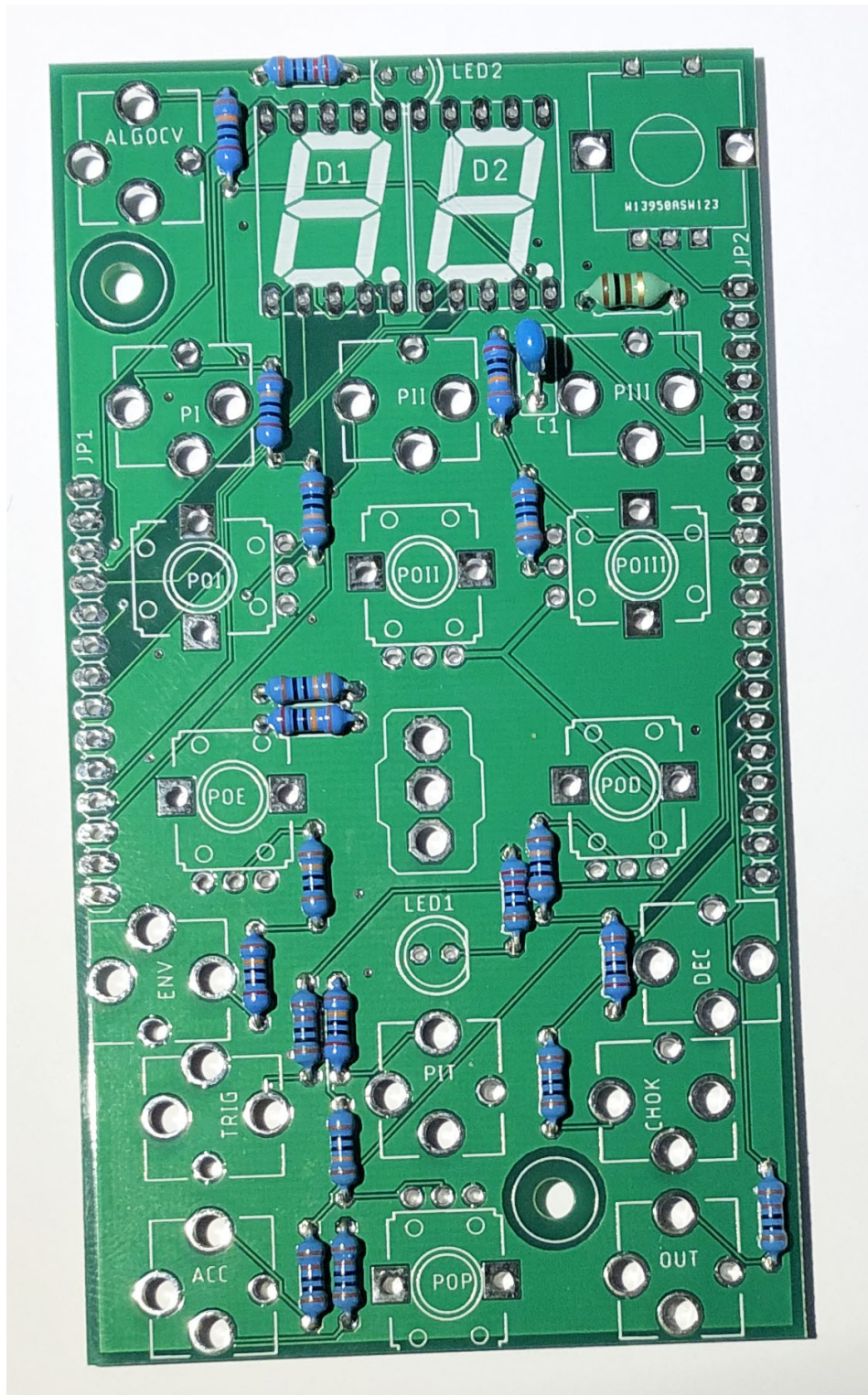

IO Board – Step 7

Install and solder the two seven segment displays D1 and D2

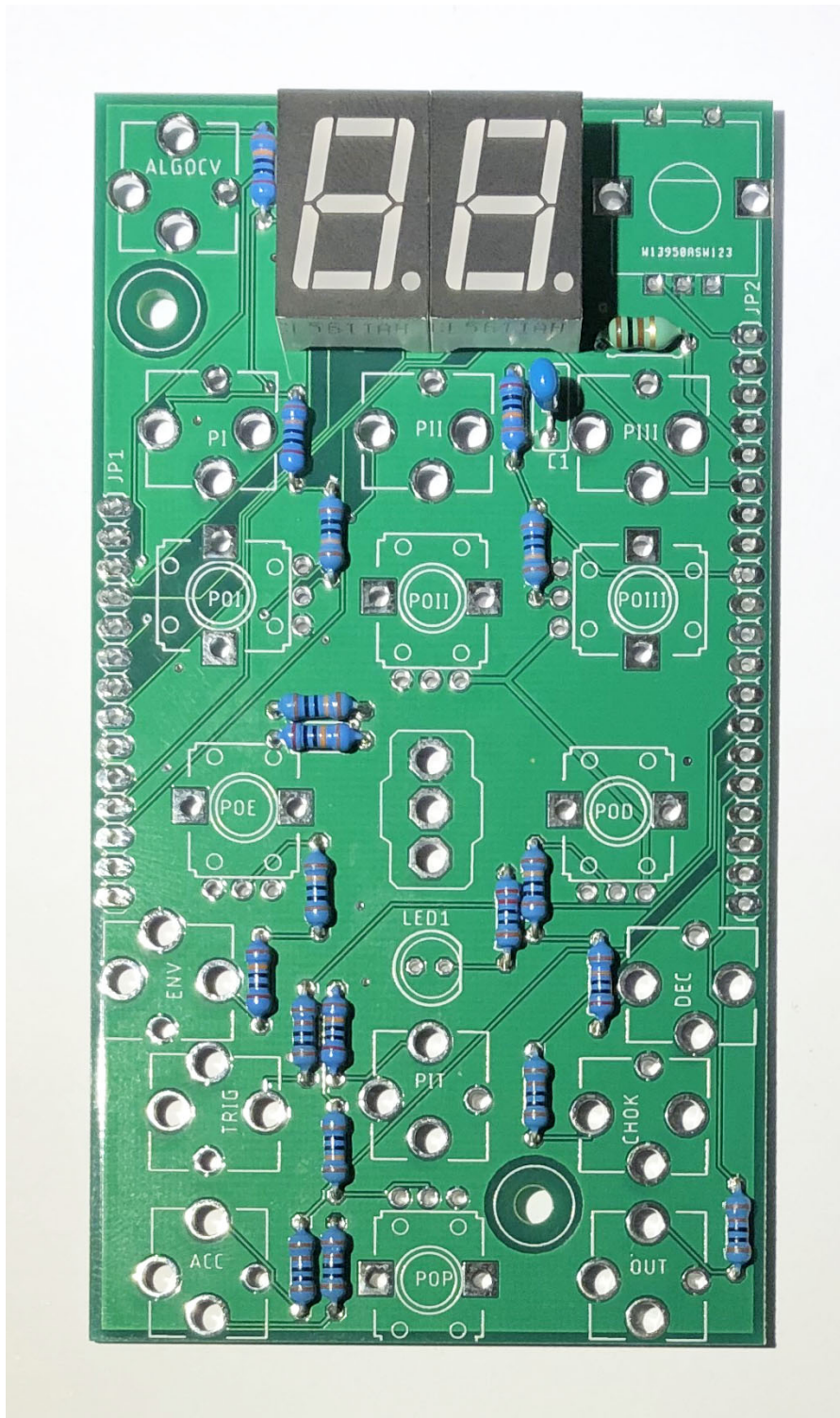

IO Board – Step 8

Cut the male header pin strip to size and solder in place, making sure it is at right angle to the PCB

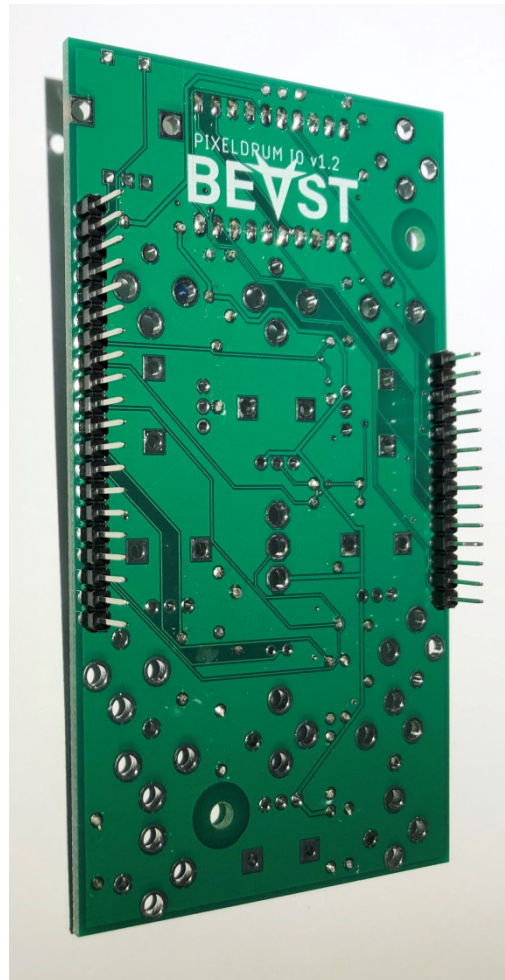
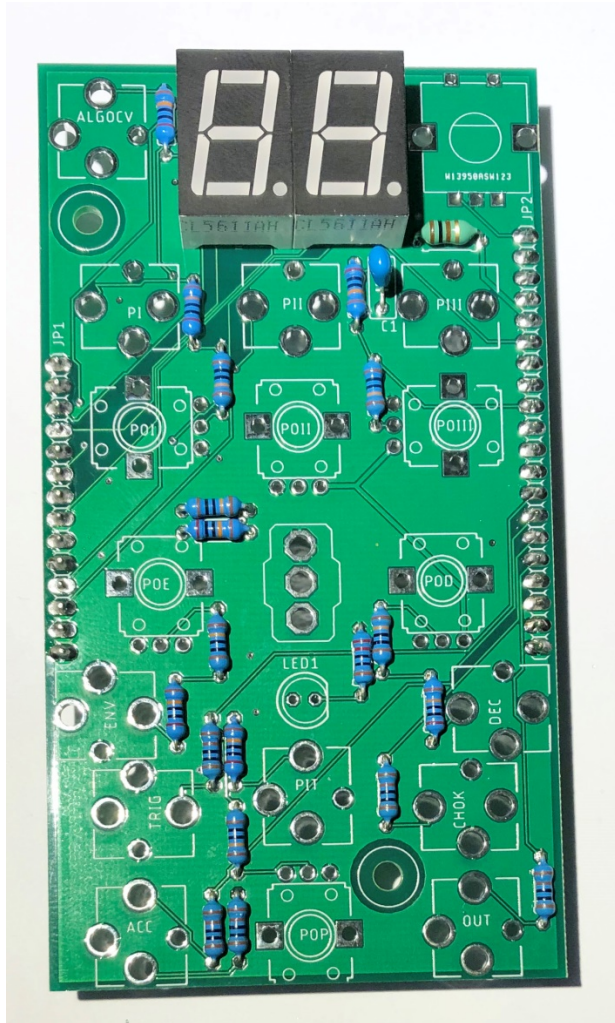

IO Board – Step 9

Install the two brass stand offs/spacers with screws.

Install the pots, jacks and two LED's – DO NOT SOLDER YET!!! Note: The SPDT switch should not be installed yet!

Use something to support the board from beneath – a solder roll works perfectly.

Take the panel and place it carefully over the jacks and pots so they do not fall out.

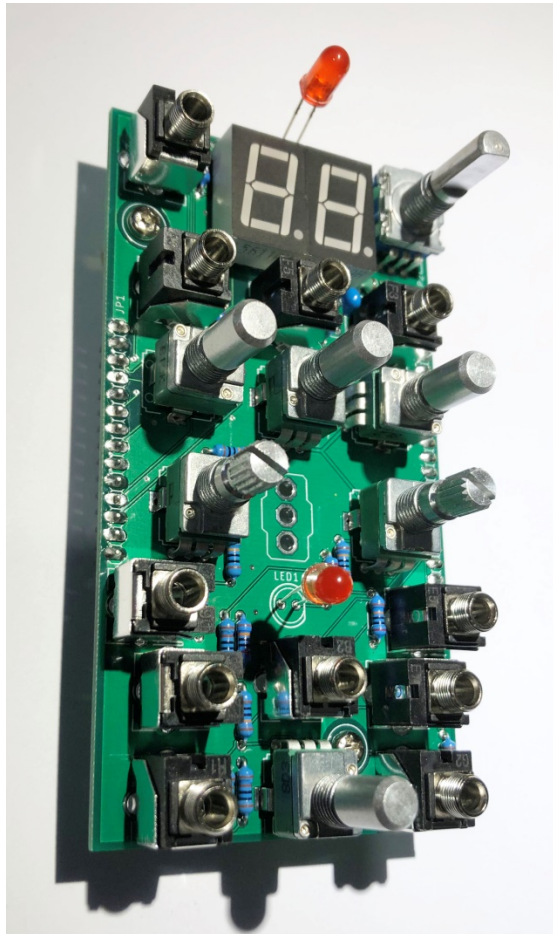

IO Board – Step 10

Carefully place a washer and nut on the P1 and P111 pots. Also place two knurled jack nuts on the accent and out jacks. Very gently tighten the nuts until they are “finger tight” DO NOT over tighten them as they will twist the pots and jacks and/or pins will be bent.

Use a tube spanner or special tool like the awesome Rocket Sockets from Peppers Pedals to avoid scratching and damaging the panel.

This should be enough to hold things together so that it can be flipped over to solder. Only solder one pin of each jack and each pot to hold things in place.



IO Board – Step 11

Remove the nuts and panel.

Remove the protective cover from the acrylic panel and place over the rotary encoder. Install the SPDT switch.

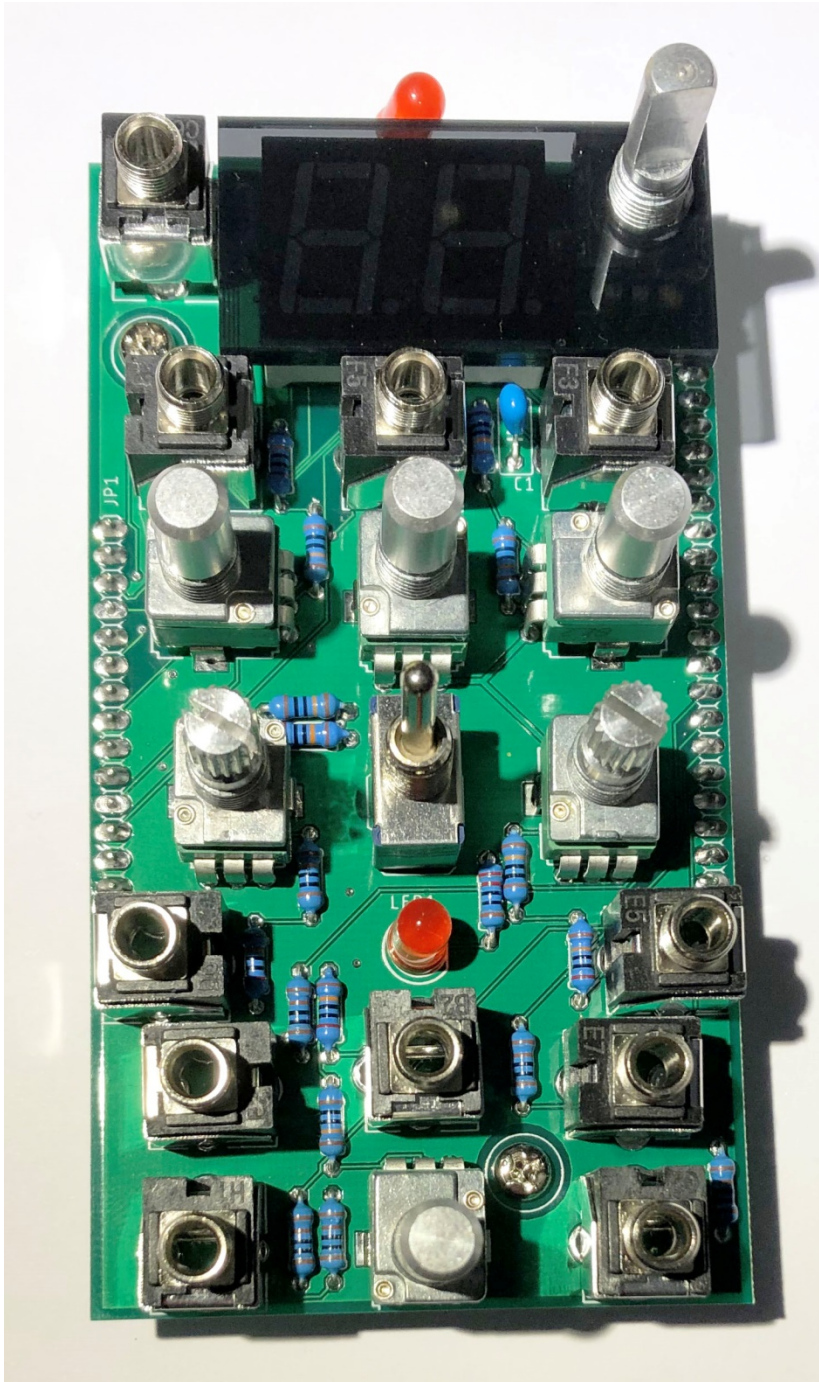

IO Board – Step 12

Place the panel back on. Place the nut for the SPDT switch on and finger tighten.



IO Board – Step 13

Install the remaining nuts and washers and finger tighten. Inspect everything and make sure everything is sitting nicely.



IO Board – Step 14

When everything is level and sitting nicely, flip it over and solder the remaining joints for the switch, jacks, pots. Maneuver the LED so it aligns up with the transparent parts of the panel as closely as possible and solder in place.

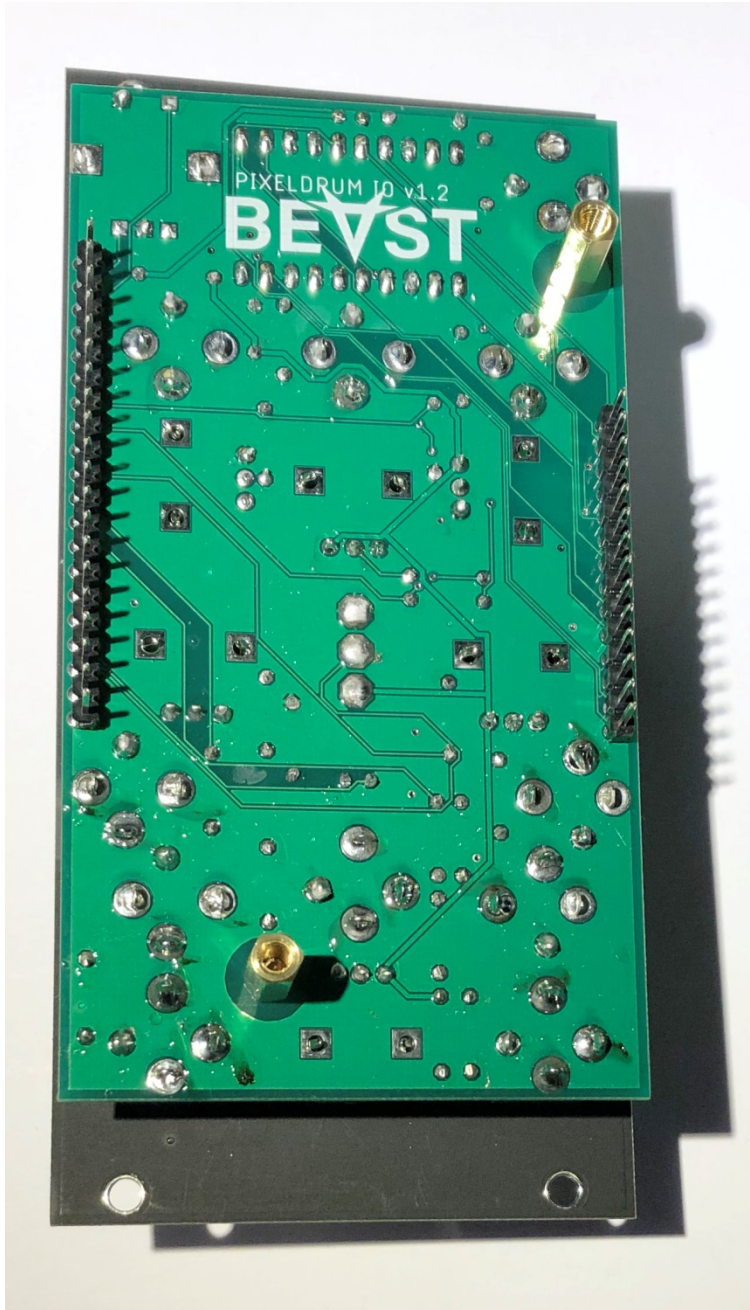

Brain Board – Step 1

Install and solder the fourteen 220R resistors R1 through R14

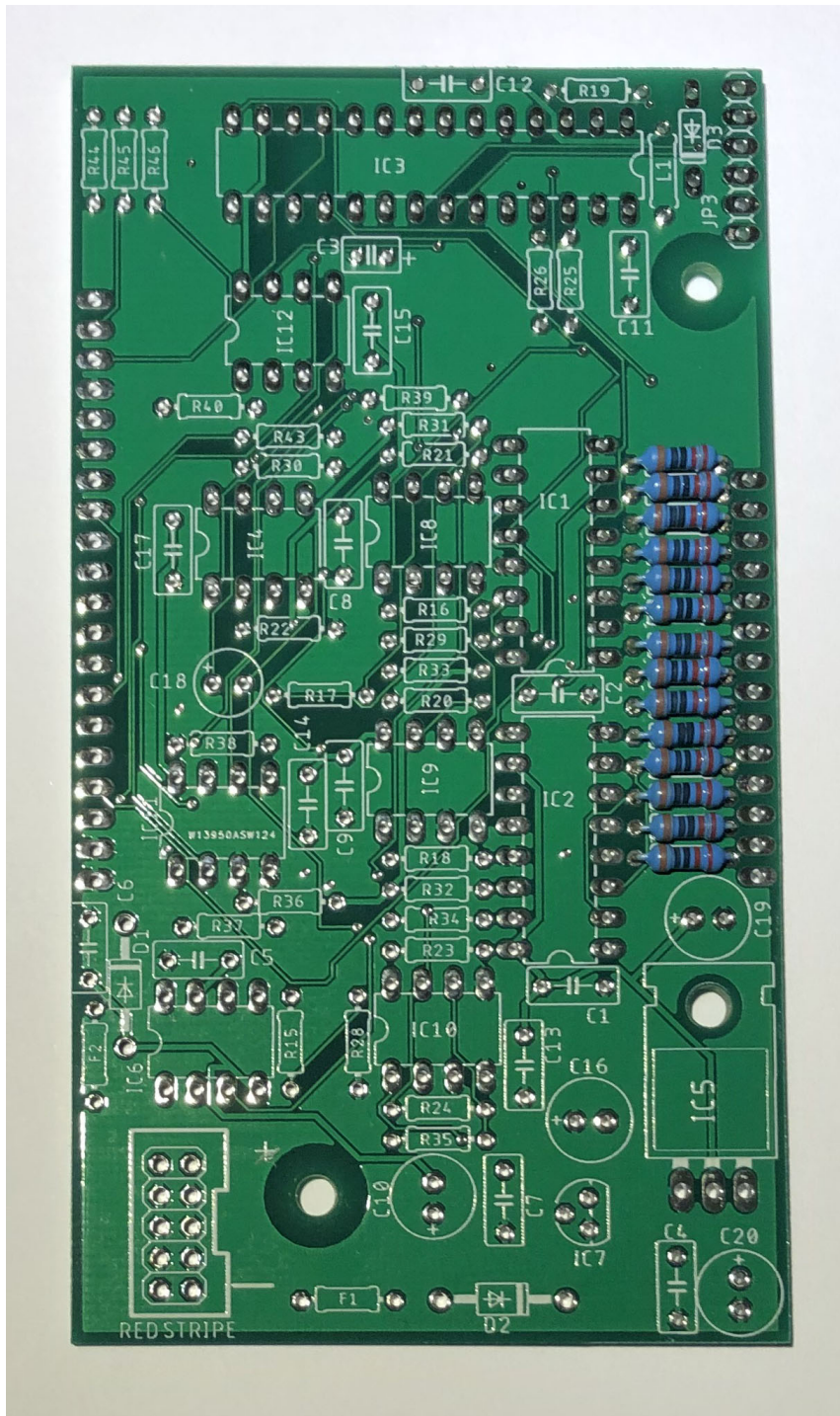

Brain Board – Step 2

Install and solder the five 10K resistors R19, R21, R44, R45 and R46

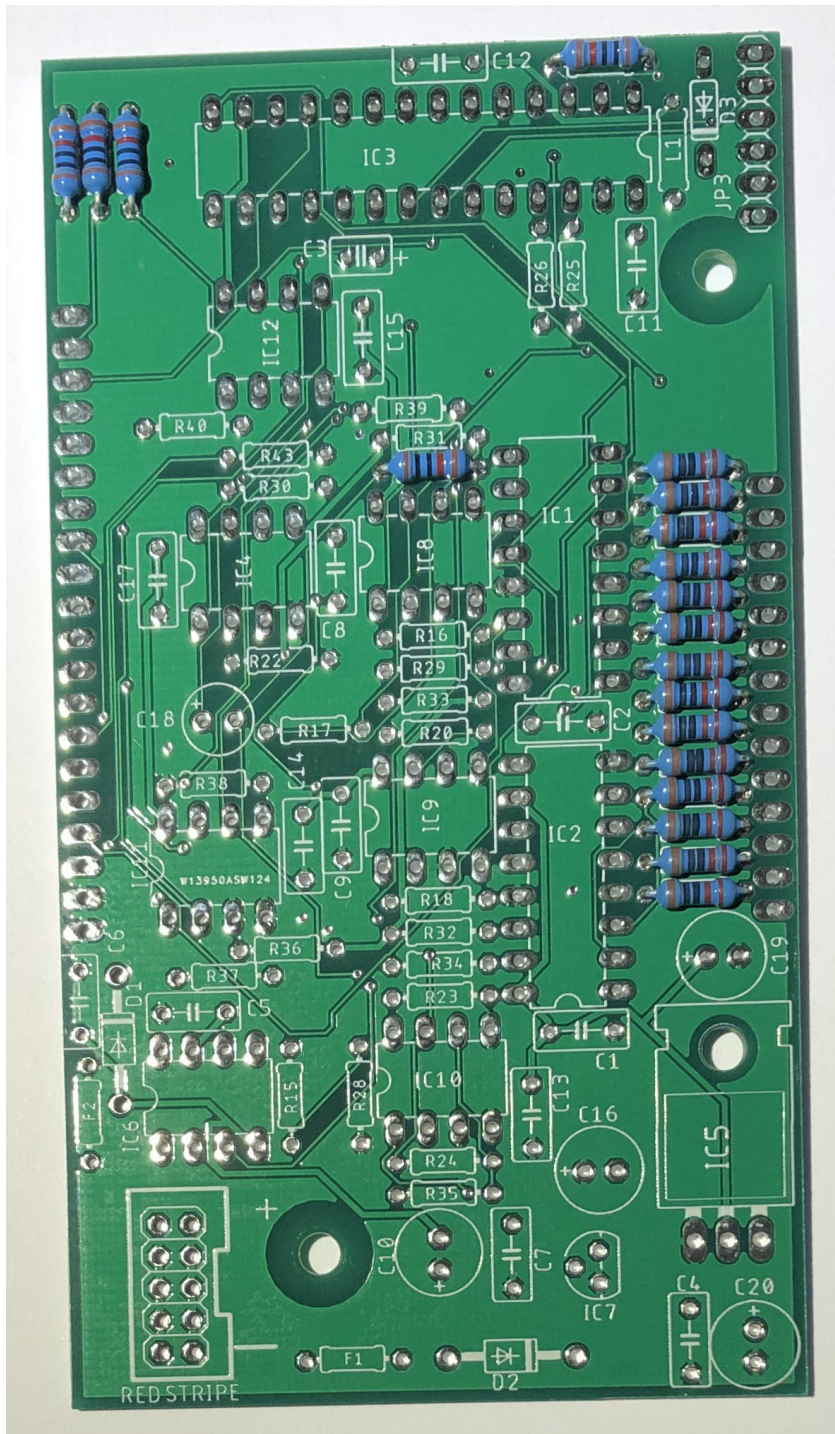

Brain Board – Step 3

Install and solder the twelve 100K resistors R16, R17, R18, R20, R23, R24, R25, R26, R28, R30, R37 and R40

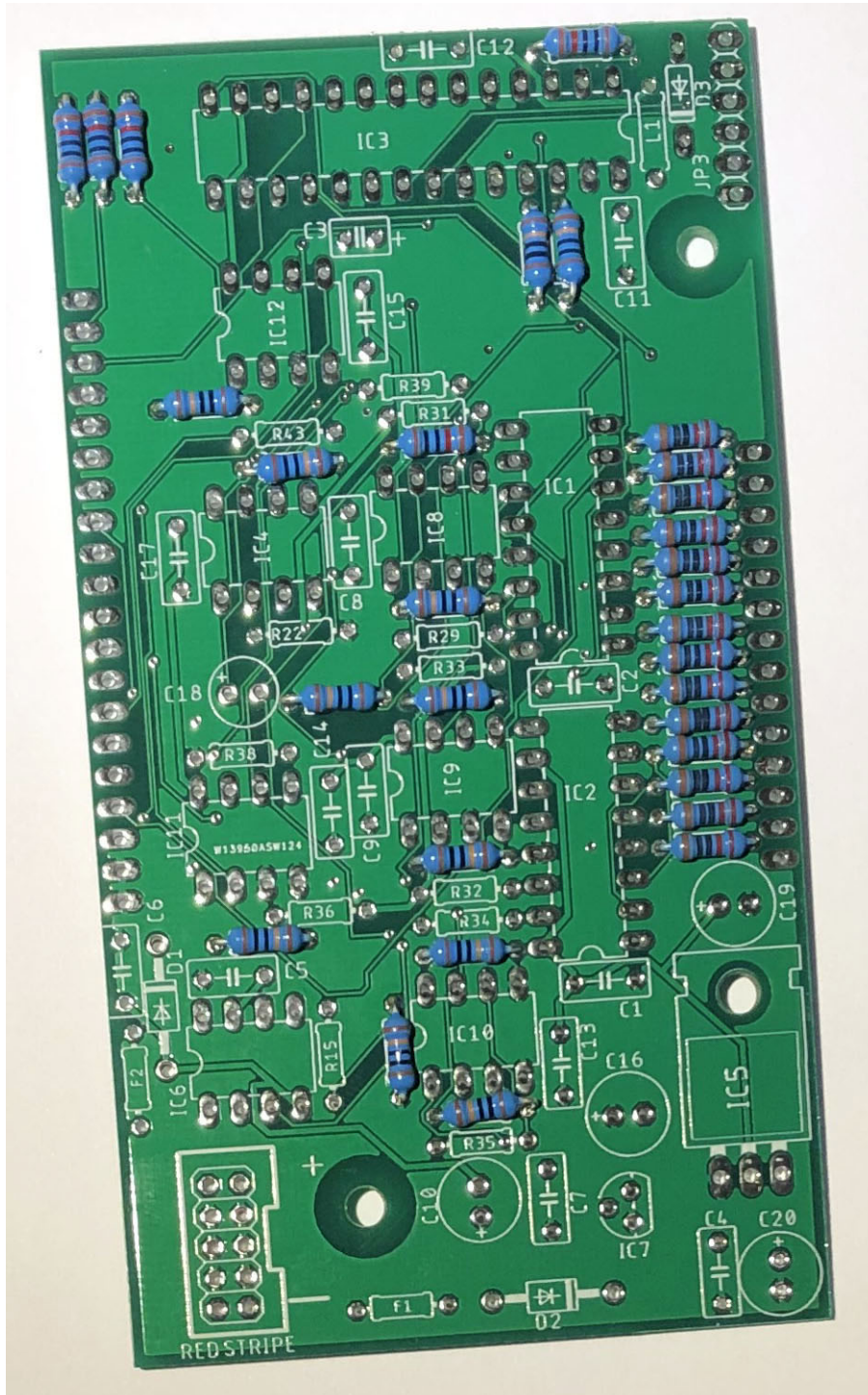

Brain Board – Step 4

Install and solder the seven 150K resistors R29, R31, R32, R33, R34, R35 and R39

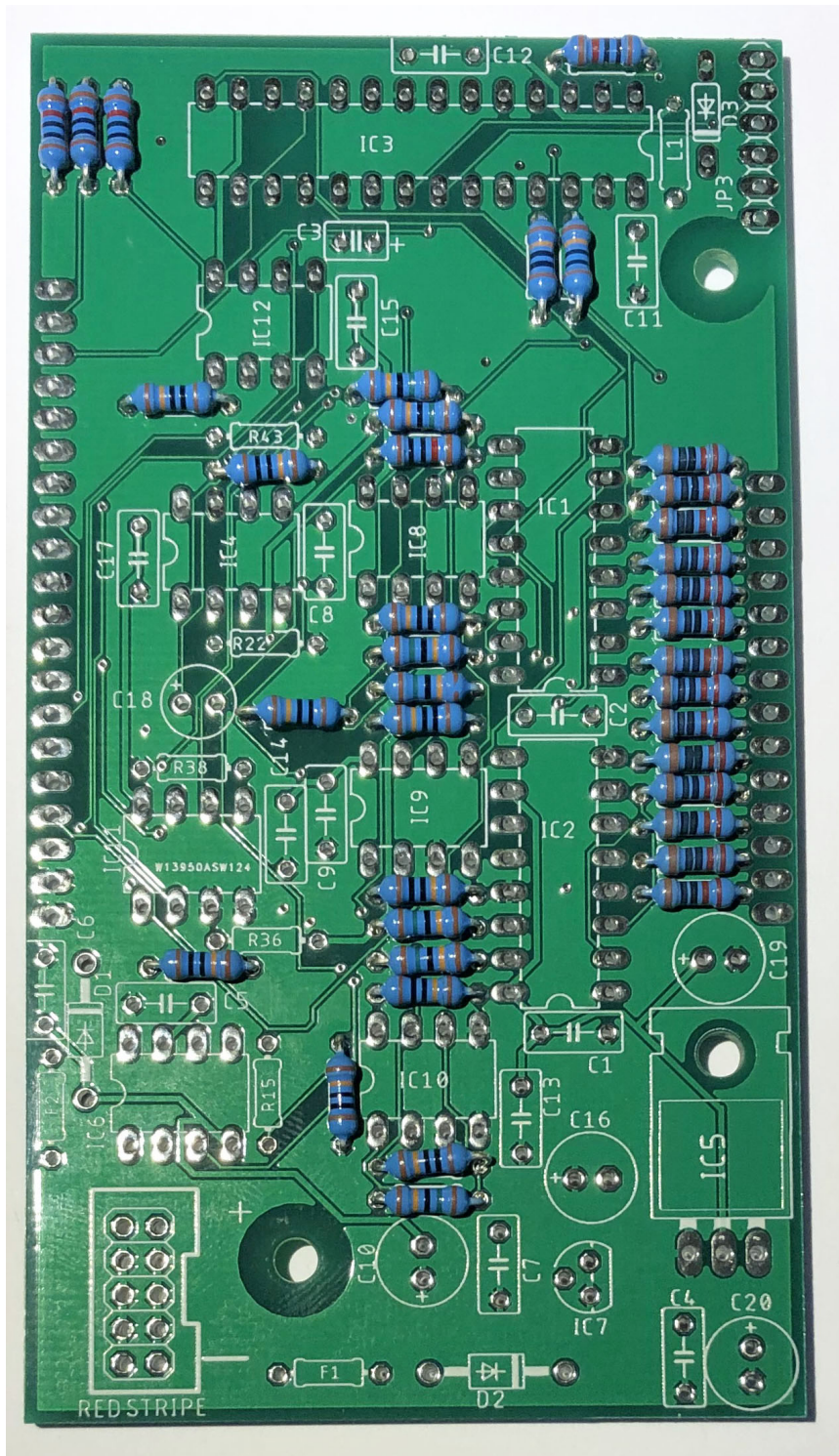

Brain Board – Step 5

Install and solder the two 200K resistors R15 and R43

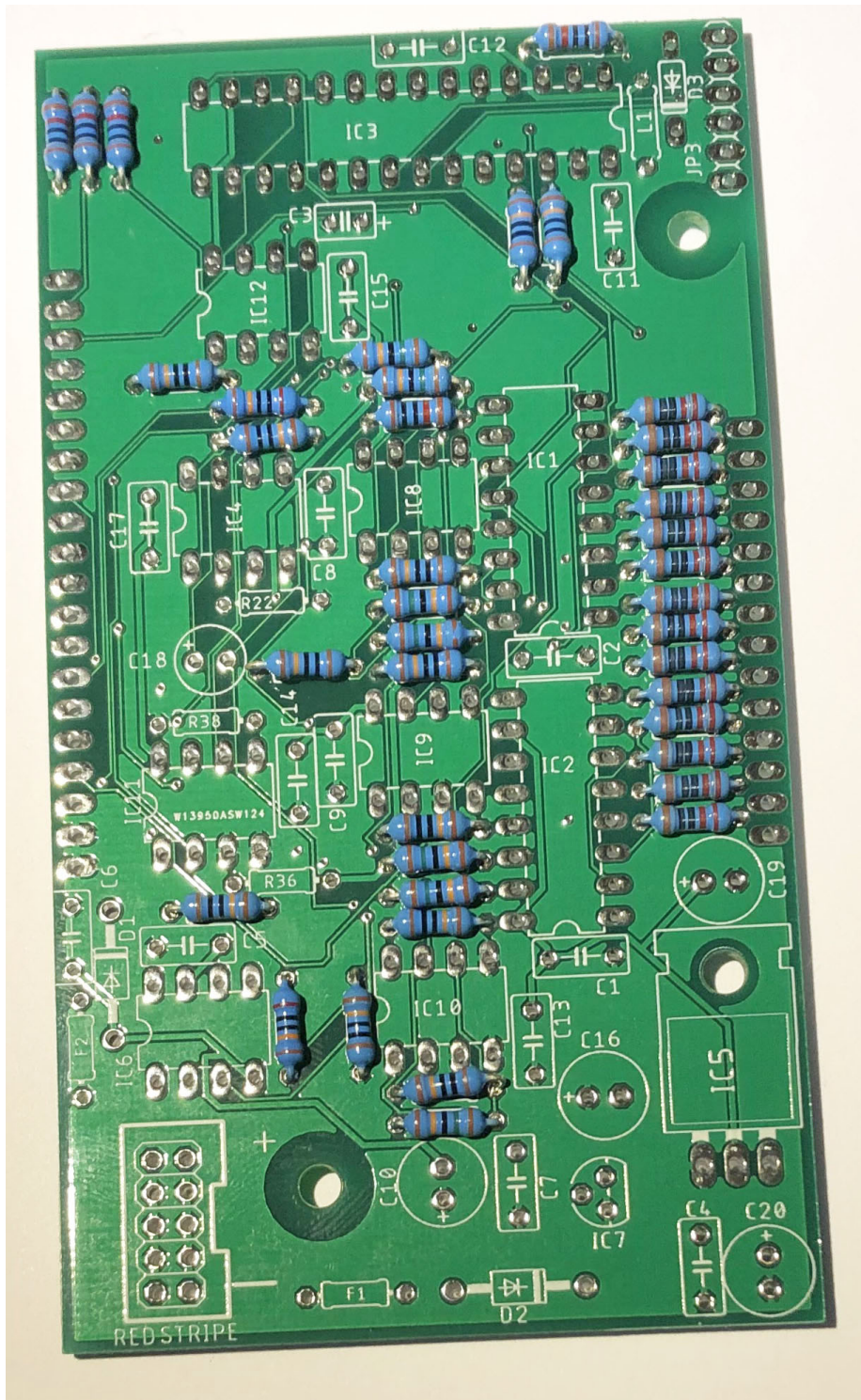

Brain Board – Step 6

Install and solder the 300K resistor R36

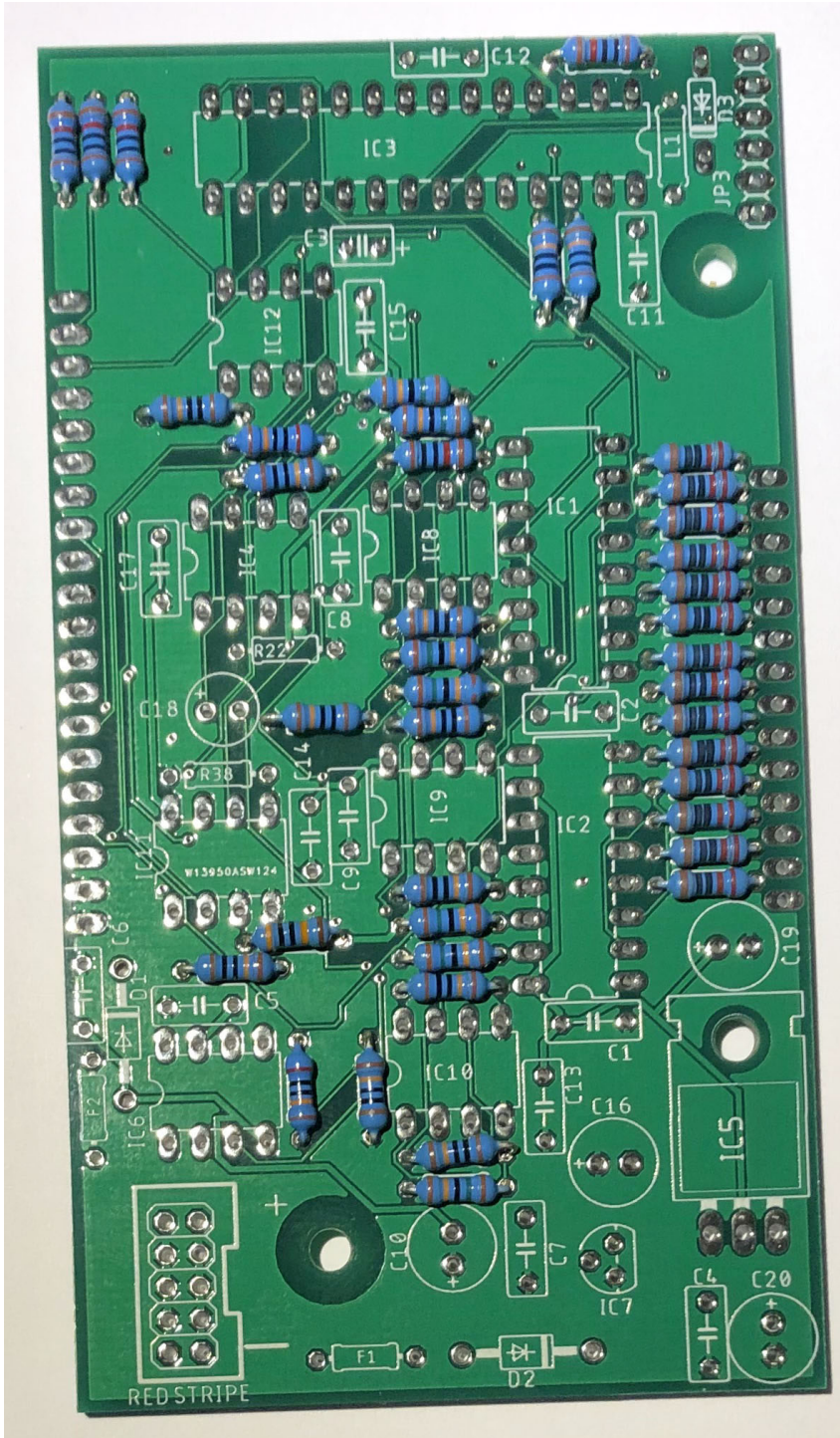

Brain Board – Step 7

Install and solder the two 1M resistors R22 and R38

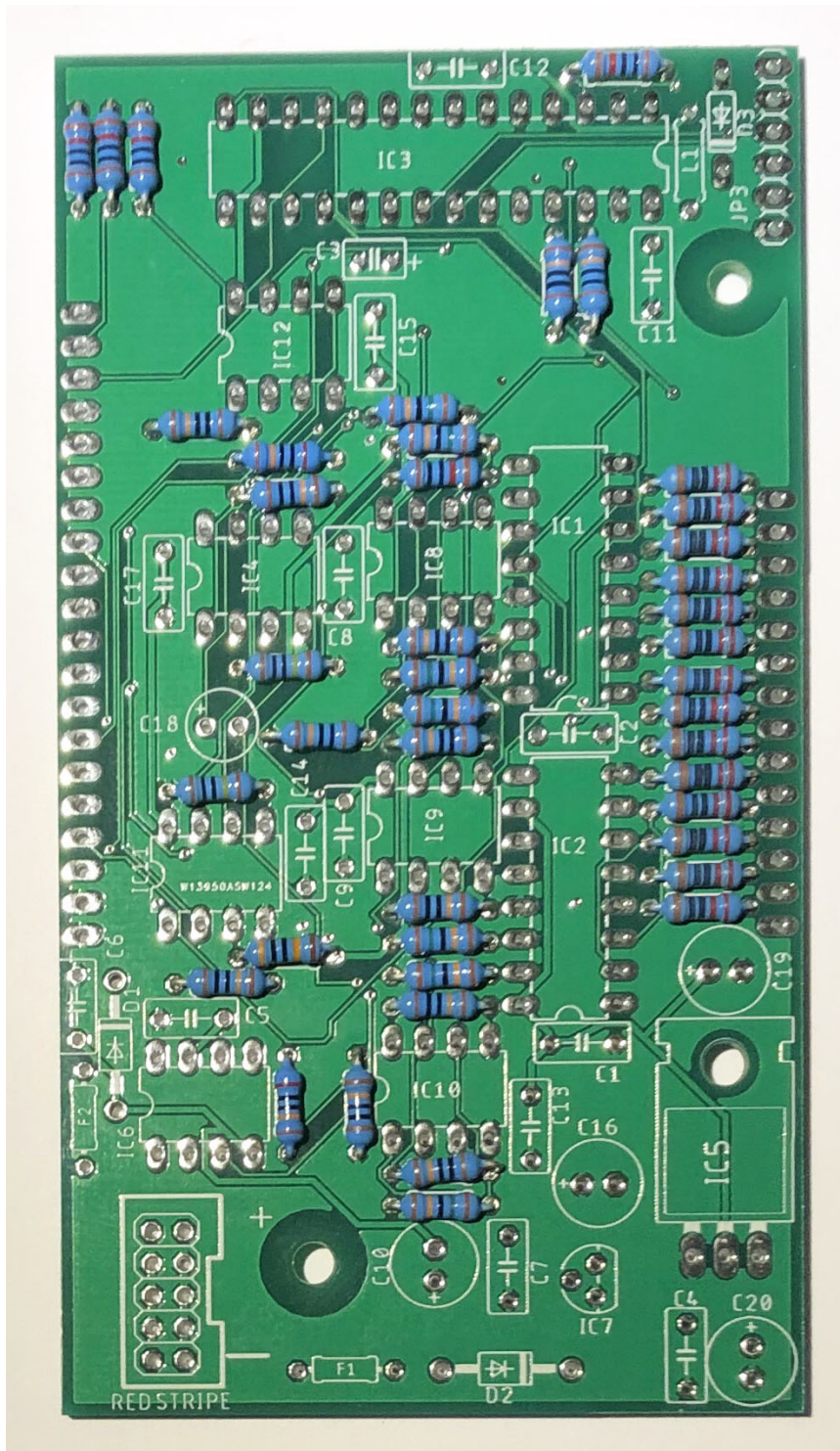

Brain Board – Step 8

Install and solder the two ferrite beads F1 and F2, the 100uh inductor L1, the two 1N4004 power diodes D1 and D2 and the 1N4148 signal diode D3. **NOTE:** Diodes are polarized and must be installed in the correct direction. Make sure the stripe on the diodes matches the stripes on the PCB board!!!!

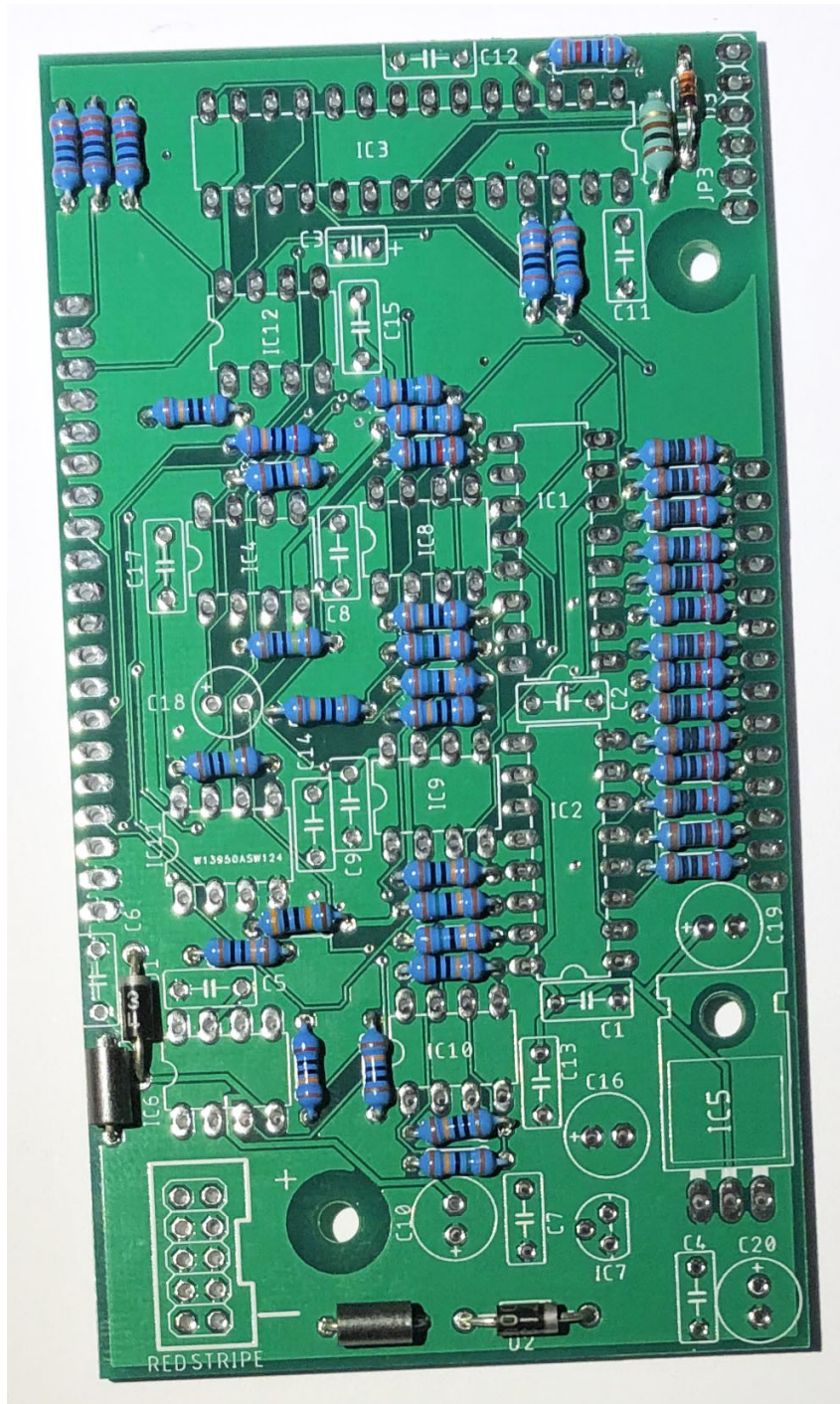

Brain Board – Step 9

Cut the IC socket strips to the correct sizes. Start with the larger ones first to ensure there will be enough length remaining. Once all are cut to the correct sizes, install them and solder into place. Use a piece of cardboard, book etc to hold them in place while flipping the PCB over to solder.

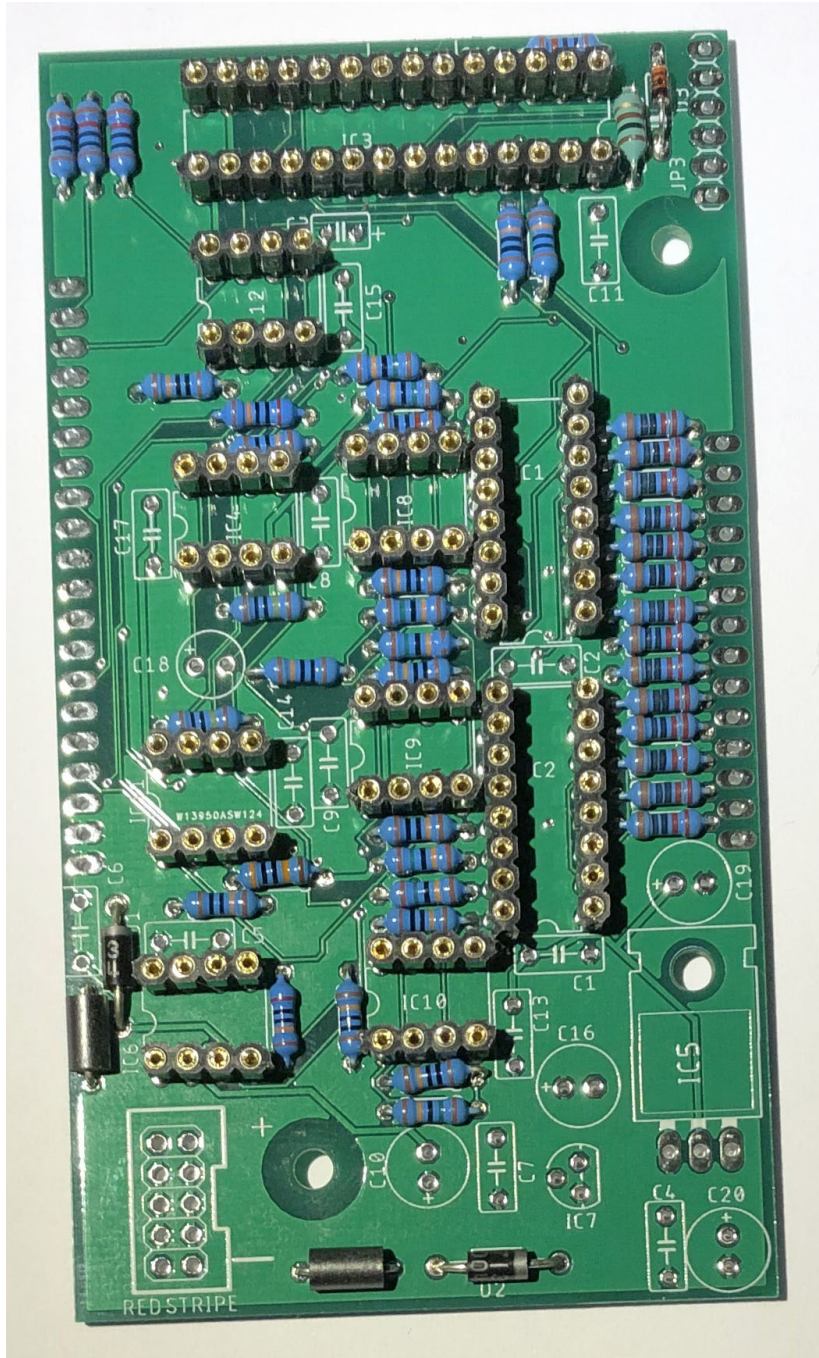

Brain Board – Step 10

Install the fourteen 100nf COG capacitors C1, C2, C4, C5, C6, C7, C8, C9, C11, C12, C13, C14, C15 and C17. Also install the LD1117V33 voltage regulator.

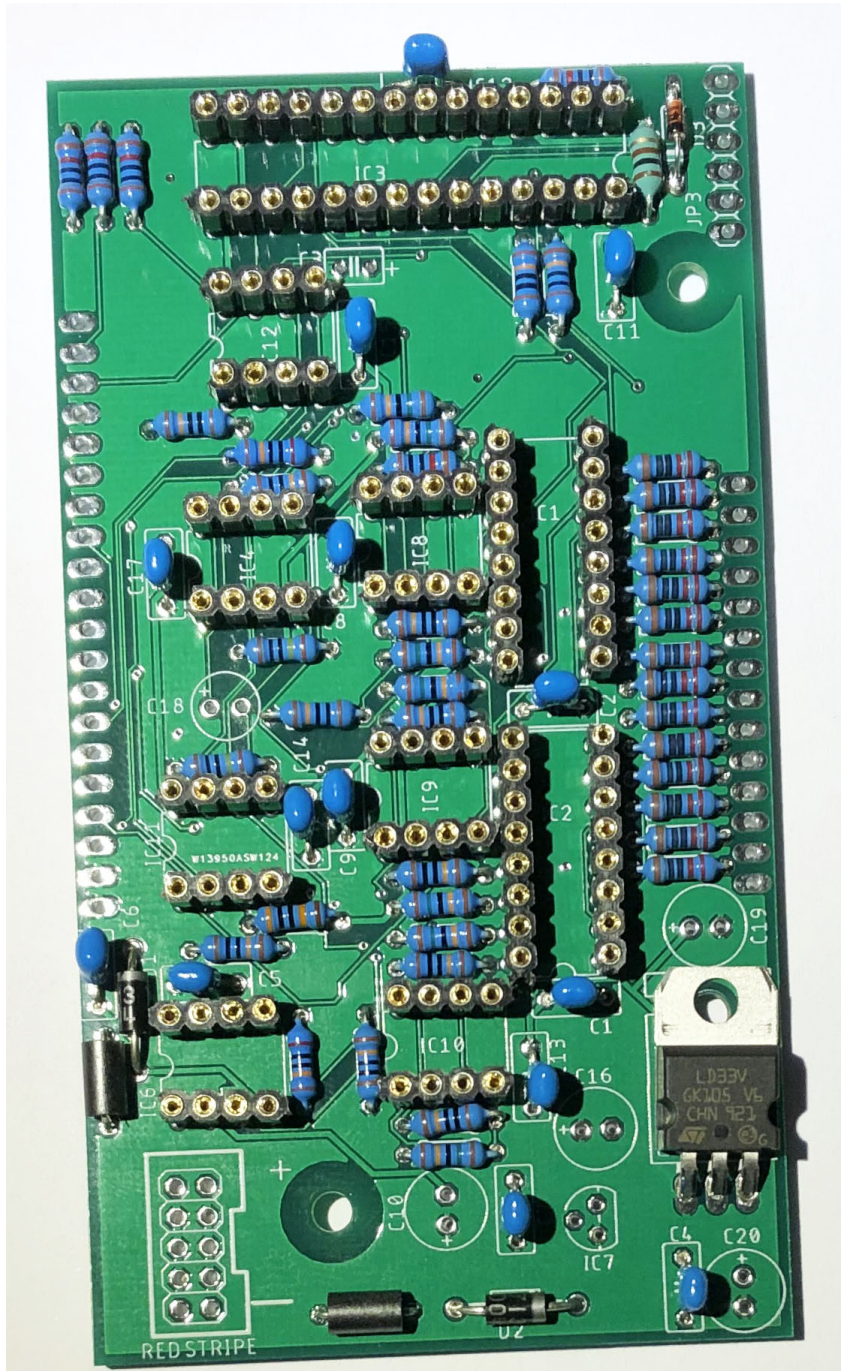

Brain Board – Step 11

Install the 10 PIN IDC Eurorack power header, making sure the header key/"cut-out" is oriented facing the right hand side of the board as per the photo below.

Also install and solder the 10uf Tantalum capacitor C3

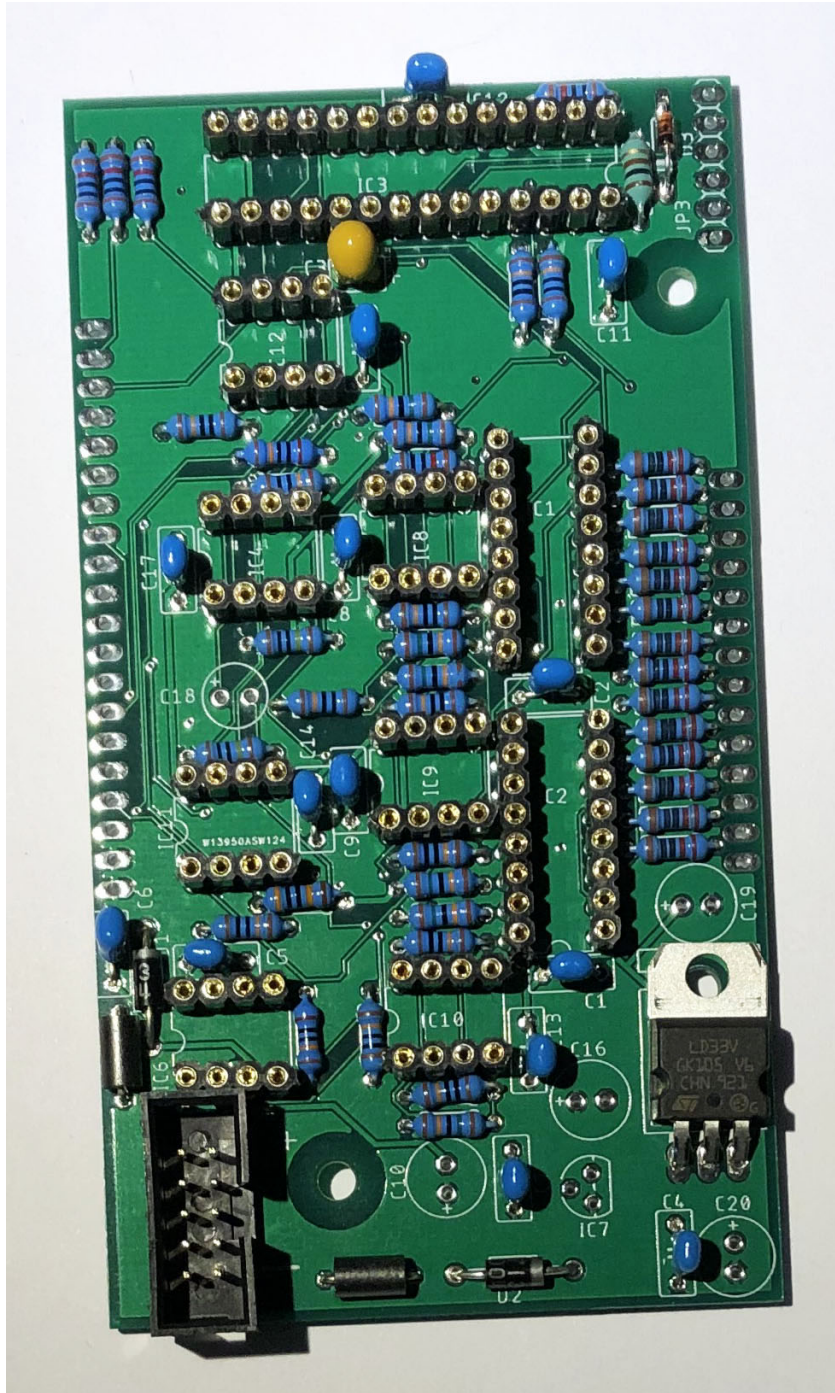

Brain Board – Step 12

Install the one 1uF non polarized electrolytic capacitor C18 and the four 100uF electrolytic capacitors C10, C16, C19 and C20 paying attention to polarity – the longer lead is positive lead, the shorter lead pointed to by the arrow is the negative lead.

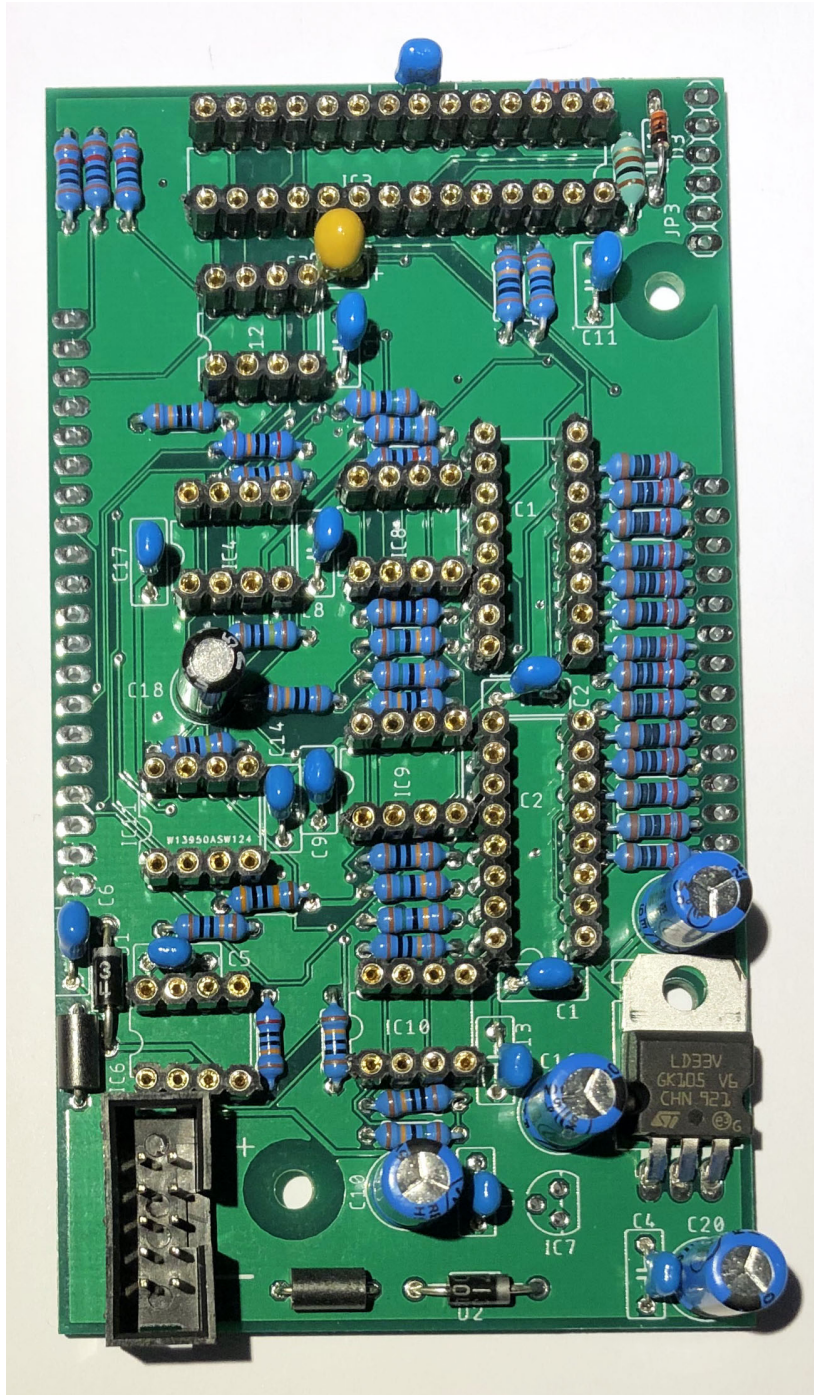

Brain Board – Step 13

Install the 79L05 voltage regulator IC7. Make sure the flat side is facing the same direction as the silkscreen on the PCB.

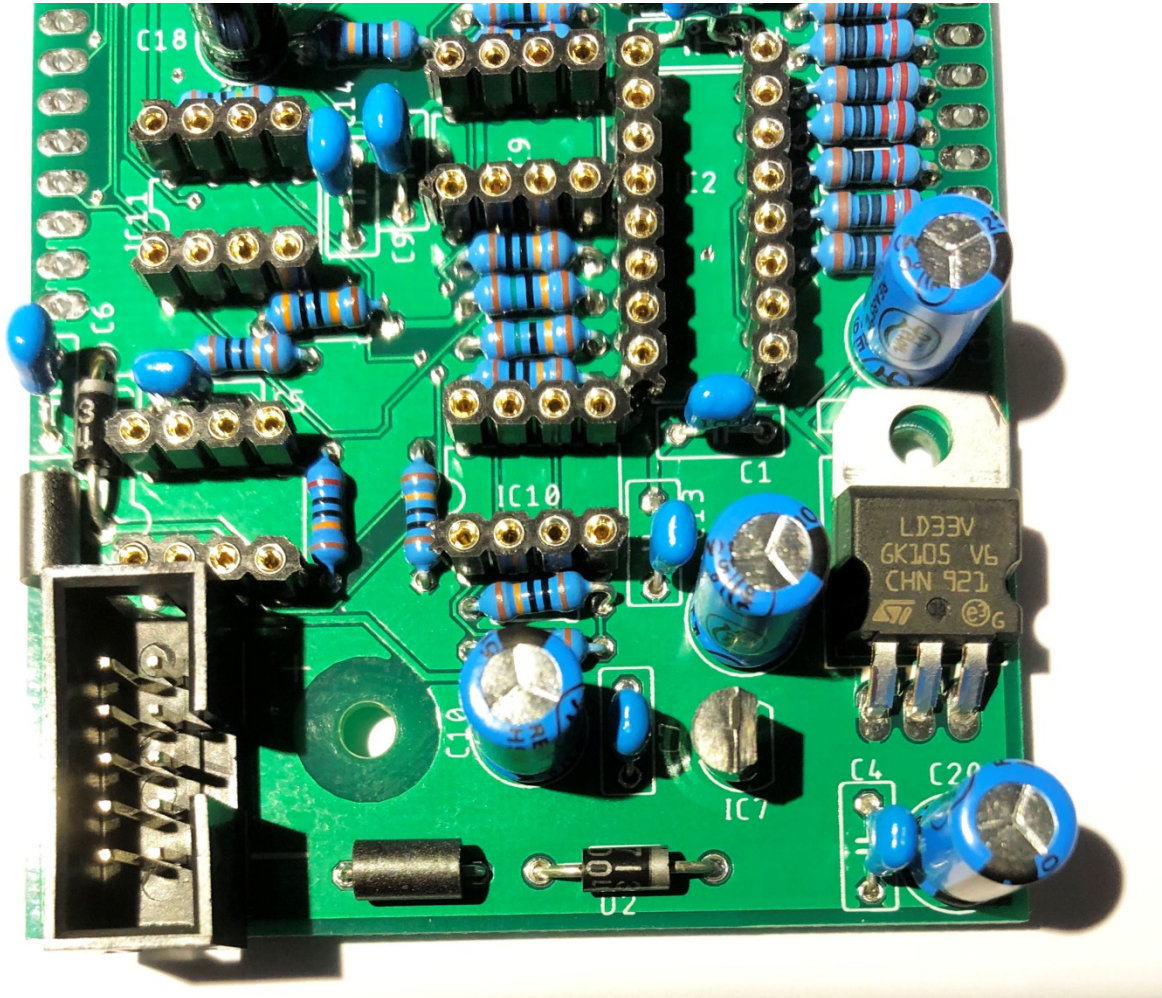

Brain Board – Step 14

Cut a 1x6 piece of male pin header and install it into JP3 – this can be used to connect a PicKit3 programmer for firmware updates.

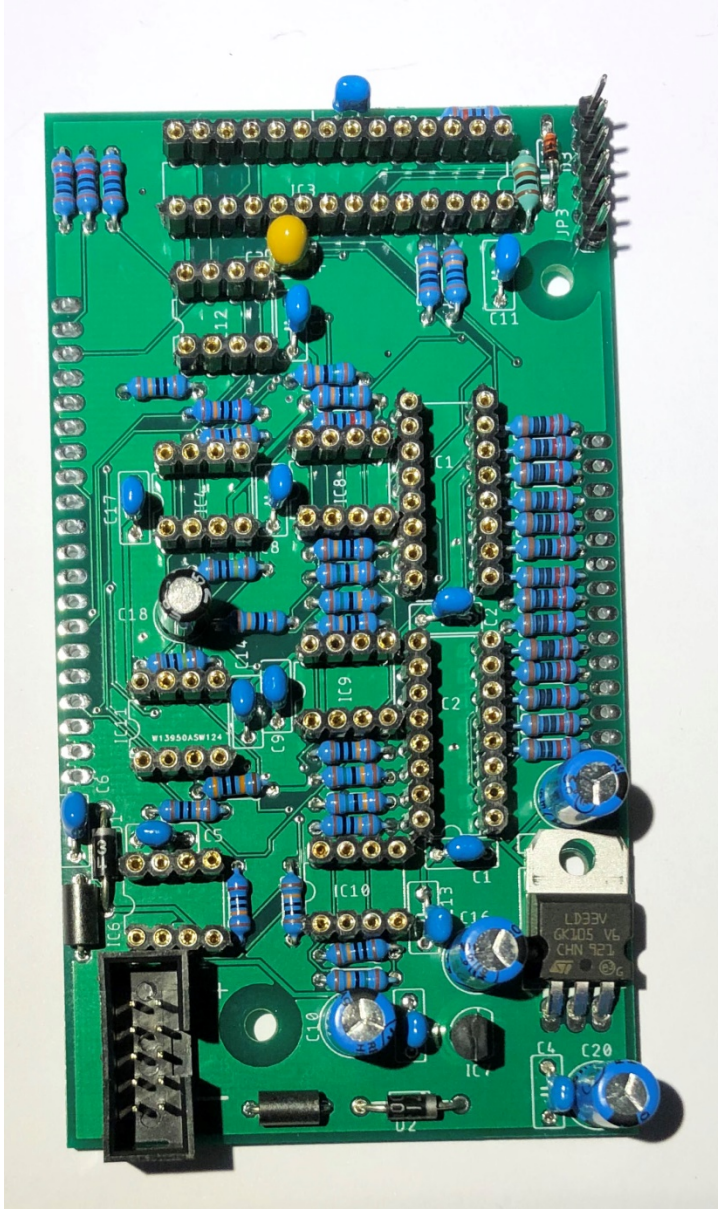

Brain Board – Step 15

Cut the female pin headers to size, install on the opposite side of the board and solder one pin on each header. Now connect the brain board to the IO board.



Brain Board – Step 16

When the boards are connected and everything is sitting nicely, solder the remaining pins of the pin header.

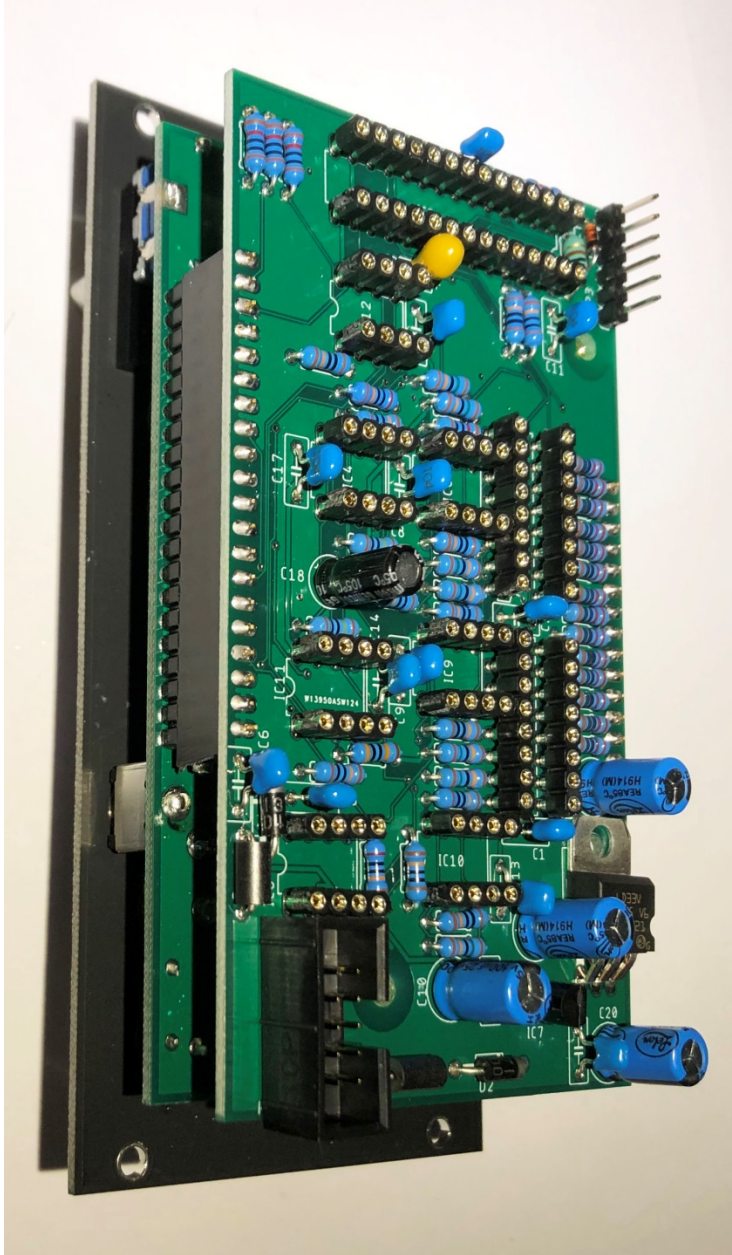

Brain Board – Step 17

Now install the IC's paying VERY close attention to the orientation. Start with IC6 which is the TL071 as it is different to the rest. Next install the six MCP 602's, followed by the two 74HC595's and lastly the dsPIC microcontroller.

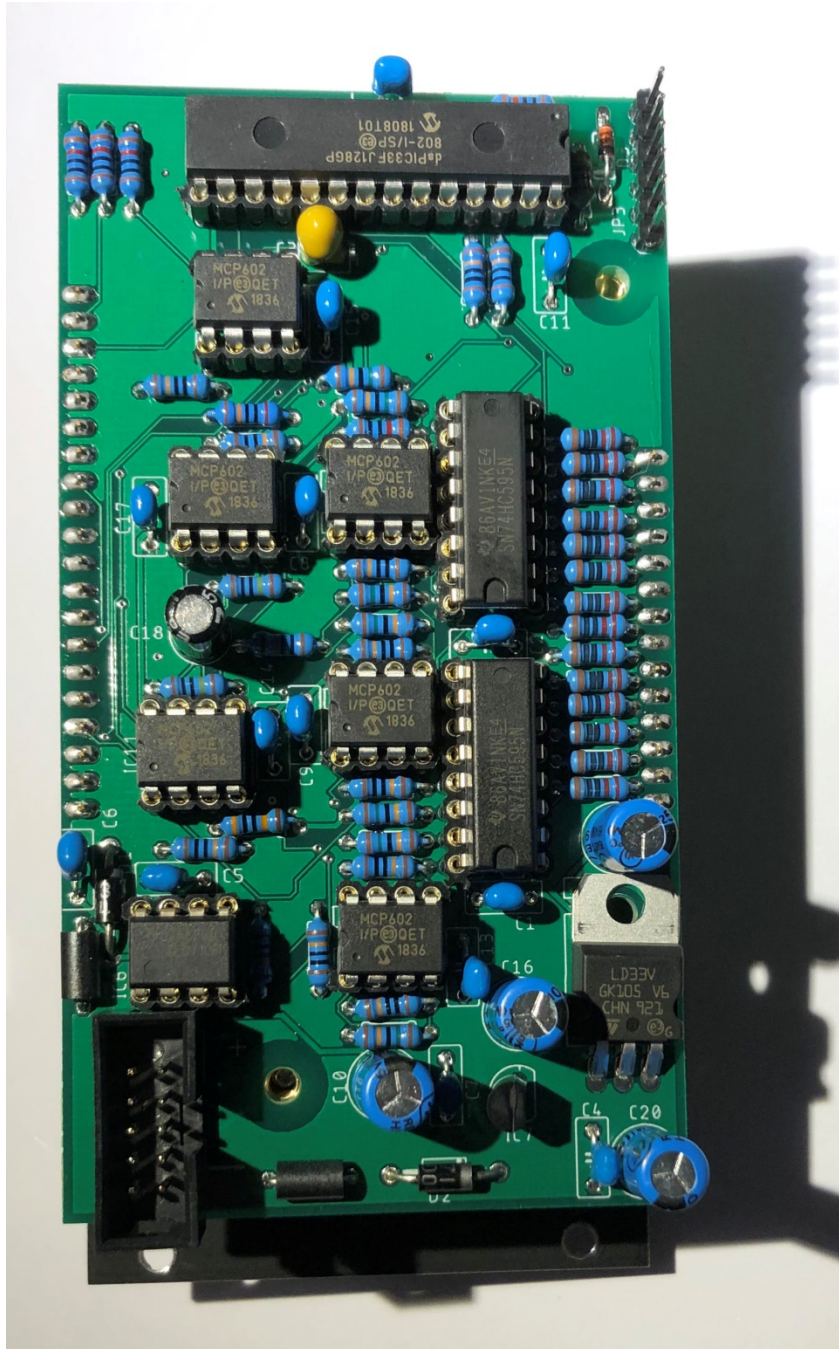

Brain Board – Step 18

Separate the IO and brain boards. Double check all solder joints and look for shorts. When you are happy join the boards together and do a quick power on test. If everything appears to work, install the two screws in the brain board to the standoffs to secure the boards together. Lastly install the knobs.

