



PVC SEWER & DRAIN FITTINGS LIST PRICE SHEET

PRICES EFFECTIVE JUNE 17, 2019



COUPLING (H x H)



Part Number	Size	Qty	List Price
V-103	3"	50	\$5.20
V-104	4"	50	6.28
V-106	6"	24	23.22

REPAIR COUPLING (H x H - NO STOP)



Part Number	Size	Qty	List Price
V-144	4"	30	\$7.67

REDUCER COUPLING (H x H)



*Tapered

Part Number	Size	Qty	List Price
V-1043	4x3"	40	\$9.92
V-1064	6x4"	24	31.23
V-1064T*	6X4"	15	32.79

ADAPTER COUPLING (H x DWV H)



*Tapered

Adapter fits over the Spigot End of the Sewer Pipe and allows for the transition to DWV pipe

Part Number	Size	Qty	List Price
V-2043	4x3"	40	\$11.68
V-2044	4x4"	25	15.53
V-2046	4x6"	24	38.12
V-2046T*	4x6"	24	40.03
V-2066	6x6"	12	51.59

COUPLING DWV SCHEDULE 40 (DWV H x DWV H)



Part Number	Size	Qty	List Price
D-104	4"	40	\$11.84

FLUSH BUSHING (S x H)



Part Number	Size	Qty	List Price
V-1143 (FLUSH)	4x3"	25	\$11.86

EXTENDED BUSHING (S x H)



Part Number	Size	Qty	List Price
V-2064 (EXTENDED)	6x4"	24	30.67

Adapter fits into Sewer Hub and allows for connection to Sewer Pipe

ECCENTRIC BUSHING (S x H)



Part Number	Size	Qty	List Price
V-2164	6x4"	15	\$34.56

Adapter fits into Sewer Hub and allows for connection to Sewer Pipe

REDUCER BUSHING (S x DWV H)



Part Number	Size	Qty	List Price
V-1031	3x1½"	25	\$14.56
V-1041	4x1½"	25	19.40
V-1042	4x2"	25	19.40

THREADED REDUCER BUSHING (S x DWV H)



Part Number	Size	Qty	List Price
V-2031	3x1½"	25	\$14.56
V-2041	4x1½"	25	19.40

EXTENDED BUSHING (S x DWV H)



Part Number	Size	Qty	List Price
V-2664 (EXTENDED)	6x4"	12	\$38.32

BUSHING DWV ADAPTER SLEEVE (DWV S x H)



Part Number	Size	Qty	List Price
V-3033	3X3"	25	\$12.11
V-3044	4x4"	25	12.11
V-3066	6x6"	10	48.04

Adapter fits into DWV Hub and allows for transition to Sewer Pipe

90° 1/4 BEND LONG TURN (H x H)



Part Number	Size	Qty	List Price
V-303	3"	25	\$10.19
V-304	4"	36	10.80
V-366	6"	8	62.39

90° 1/4 BEND SHORT TURN (H x H)



Part Number	Size	Qty	List Price
V-3303	3"	25	\$8.19
V-3304	4"	25	10.31
V-306	6"	12	35.01

90° 1/4 BEND STREET ELL LONG TURN (H x S)



Part Number	Size	Qty	List Price
V-403	3"	25	\$11.84
V-404	4"	36	13.34
V-466	6"	8	116.21

90° 1/4 BEND STREET ELL SHORT TURN (H x S)



Part Number	Size	Qty	List Price
V-3403	3"	25	\$12.92
V-3404	4"	25	13.77
V-406	6"	12	51.64

45° 1/8 BEND (H x H)



Part Number	Size	Qty	List Price
V-503	3"	30	\$6.98
V-504	4"	60	7.27
V-506	6"	18	35.55

45° 1/8 BEND STREET ELL (H x S)



Part Number	Size	Qty	List Price
V-603	3"	30	\$8.19
V-604	4"	60	8.46
V-606	6"	18	39.42

22-1/2° 1/16 BEND (H x H)



Part Number	Size	Qty	List Price
V-703	3"	25	\$9.70
V-704	4"	30	10.80
V-706	6"	20	38.77

22-1/2° 1/16 BEND STREET ELL (H x S)



Part Number	Size	Qty	List Price
V-713	3"	25	\$10.80
V-714	4"	30	11.43
V-716	6"	20	43.09

CAP (H)



Part Number	Size	Qty	List Price
V-1403	3"	30	\$4.37
V-1404	4"	30	5.00
V-1406	6"	30	20.43

Fits over the Spigot end of Sewer Pipe

TEE (H x H x H)



Part Number	Size	Qty	List Price
V-803	3"	30	\$9.23
V-804	4"	30	12.29
V-806	6"	8	51.64

REDUCING TEE (H x H x H)



Part Number	Size	Qty	List Price
V-8064	6x4"	8	\$47.36

CLEANOUT TEE (H x H x FIP)



Part Number	Size	Qty	List Price
V-8804	4"	30	\$30.17

45° WYE (H x H x H)



Part Number	Size	Qty	List Price
V-903	3"	25	\$14.90
V-904	4"	24	17.91
V-906	6"	6	73.19

45° REDUCING WYE (H x H x H)



Part Number	Size	Qty	List Price
V-9064	4x6"	8	\$60.26

SANITARY TEE (H x H x H)



Part Number	Size	Qty	List Price
V-1103	3"	24	\$12.49
V-1104	4"	25	17.06
V-1106	6"	6	107.62

TWO-WAY CLEANOUT (H x H x H)



Part Number	Size	Qty	List Price
V-2204	4"	10	\$35.15

TWO-WAY CLEANOUT (H x DWV H x H)



Part Number	Size	Qty	List Price
V-2214	4"	10	\$63.52

SADDLE TEE (DWV HUB x S&D PIPE)



Part Number	Size	Qty	List Price
V-1204	1½x4"	25	\$21.51

CROSS (H x H x H x H)



Part Number	Size	Qty	List Price
V-1304	4"	24	\$33.41

CORRUGATED ADAPTER (S x CI)



Part Number	Size	Qty	List Price
V-44	4x4"	60	\$11.34

CLAY ADAPTER (H x CLAY SPIGOT)



Part Number	Size	Qty	List Price
V-1504	4"	24	\$30.17

CAST IRON ADAPTER (H x CAST IRON SPIGOT)



Part Number	Size	Qty	List Price
V-1604	4"	24	\$30.17

DOWNSPOUT ADAPTER (D x H)



Part Number	Size	Qty	List Price
V-1703	2x3x3"	50	\$10.31
V-1704	2x3x4"	50	9.70
V-1705	3x4x4"	25	10.98

The first two sizes are the dimensions of the Downspout Square, the third size refers to the Sewer Pipe

OFFSET FLUSH-FIT DOWNSPOUT ADAPTER (D x H)



Part Number	Size	Qty	List Price
V-1713	2x3x3	24	\$10.31
V-1714	2x3x4"	25	9.70
V-1715	3x4x4"	25	13.64
V-1706	4x6x6"	15	55.94

DRAIN GRATE



Part Number	Size	Qty	List Price
V-1803	3"	50	\$6.05
V-1804	4"	40	7.56
V-1806	6"	30	33.41

Drops into the Hub end of Sewer Pipe or Fitting

FITTING CLEANOUT (SEWER SPIGOT x FIP)



Part Number	Size	Qty	List Price
V-1903	3"	40	\$9.70
V-1904	4"	20	9.70
V-1906	6"	12	47.36

PLUG (IPS THREAD)



Part Number	Size	Qty	List Price
V-2003	3"	50	\$5.83
V-2004	4"	50	6.05
V-2006	6"	12	29.95

COUNTERSUNK PLUG (IPS THREAD)



Part Number	Size	Qty	List Price
V-2014	4"	48	\$11.12
V-2016	6"	12	46.91

FITTING CLEANOUT with PLUG



Part Number	Size	Qty	List Price
V-1924	4"	50	\$14.15

FEMALE ADAPTER (H x FIP)



Part Number	Size	Qty	List Price
V-2103	3"	24	\$12.92
V-2104	4"	24	12.53
V-2106	6"	12	47.21

PVC SEWER & DRAIN FITTINGS

WHITE SOLVENT WELD SDR 35 | CONFORMS TO ASTM D3034 | EFFECTIVE JUNE 17, 2019

Fittings Socket Dimensions - Inches

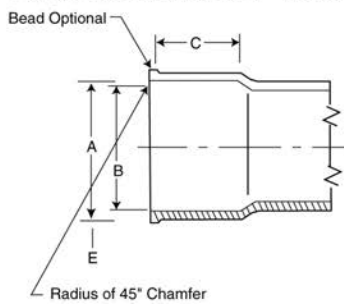

Nominal Size In.	A	B	C
4	4.235 ± 0.009	4.210 ± 0.009	1.75
6	6.305 ± 0.011	5.270 ± 0.011	3.000

Pipe Dimensions

Nominal Size	Outside Diameter		Minimum Wall Thickness
	Average	Tolerance On Average	SDR 35
4	4.215	± 0.009	0.120
6	6.275	± 0.011	0.180

1/4 Bend

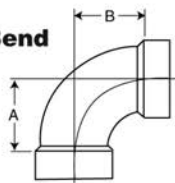

Part No.	Size	Description	A	B
V-304	4"	HXH	3 11/16	3 11/16
V-366	6"	HXH	5 3/16	5 3/16

1/8 Bend

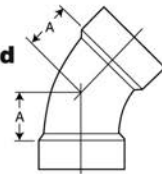

Part No.	Size	Description	A
V-504	4"	HXH	7/8
V-506	6"	HXH	1 3/8

Vent Ell

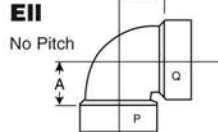

Part No.	Size	Description	A
V-3304	4"	HXH	2 5/32
V-306	6"	HXH	3 3/16

1/16 Bend

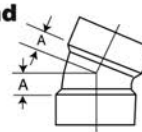

Part No.	Size	Description	A
V-704	4"	HXH	7/8
V-706	6"	HXH	1 3/8

Tee No Pitch

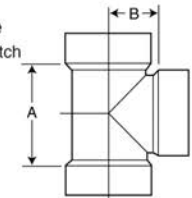

Part No.	Size	Description	A	B
V-804	4"	HXHXH	4 5/16	2 5/32
V-806	6"	HXHXH	6 3/8	3 3/16

Wye

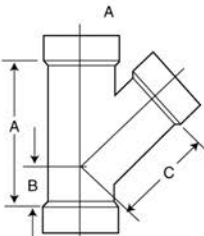

Part No.	Size	Description	A	B	C
V-904	4"	HXHXH	6	5 1/8	5
V-906	6"	HXHXH	1 5/16	7 11/16	7 1/2

Sanitary Tee

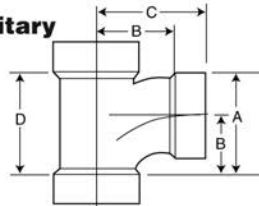

Part No.	Size	Description	A	B	C	D
V-1104	4"	HXHXH	5 7/16	3 11/16	5 7/16	7 3/16
V-1106	6"	HXHXH	9	5 3/16	8 1/25	8 1/2

Coupling

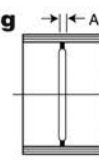

Part No.	Size	Description	A
V-104	4"	HXH	1/89
V-106	6"	HXH	3/16

Adapter Coupling

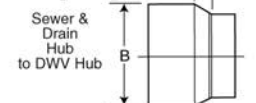

Part No.	Size	Description	A	B
V-2043	4x3	HXH	25/32	4.215
V-2044	4x4	HXH	1/4	4.215

Pipe In increaser Reducer

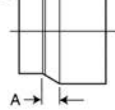

Part No.	Size	Description	A
V-1043	4x3	HXH	1/4
V-1064	6x4	HXH	3/16

Slip Cap

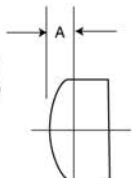

Part No.	Size	Description	A
V-1404	4"	CAP	9/64
V-1406	6"	CAP	31/64

Fitting Cleanout Adapter

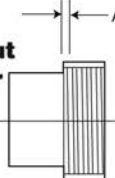

Part No.	Size	Description	A
V-1904	4"	SPGXFPT	1/8
V-1906	6"	SPGXFPT	7/32

Female Adapter



Part No.	Size	Description	A
V-2104	4	HXFPT	1 5/8
V-2104	6	HXFPT	2 1/32

Cleanout Plug

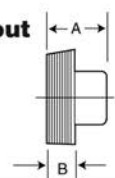

Part No.	Size	Description	A	B
V-2004	4"	MPT	1 7/8	7/8
V-2006	4"	MPT	2	1



324 DELAWARE AVENUE | OAKMONT PA 15139

ORDERS@NORMANDYPRODUCTS.COM | (T): 800.322.9463 | (F): 800.910.0134 | WWW.NORMANDYPRODUCTS.COM