

Shooter's Guide to *POSITION AIR RIFLE*

A Jr. Shooting Sports USA Publication
by Leo R. Lujan
Copyright © 1996

Table of Contents

Chapter	Page
I Introduction	1-1
II Equipment, Clothing and Supplies	2-1
III Gun Safety and Range Commands	3-1
IV Operation of the Air Rifle	4-1
V Standing Position	5-1
VI Aiming and Trigger Control	6-1
VII Mental Training	7-1
VIII Prone Position	8-1
IX Sight Adjustment and Scoring	9-1
X Kneeling Position	10-1
XI Building and Testing Your Skills	11-1



Distributed by The American Legion
with permission from the author.

Price: \$4.00 U.S.

This text belongs to _____

Student's Name

FOREWORD

This Guide provides a thorough explanation of the essential fundamentals needed for success as an entry level competitive shooter. It is part of a Position Air Rifle Course package which includes the following:

Instructor's Guide (IG): Background information, preparation checklists, and lesson plans to teach the course.

Student Handout Set: Five quizzes and a final exam.

Shooting Skill Awards: A program of self-paced skill awards which recognize achievement and motivate continued self-improvement.

ACKNOWLEDGMENTS

I wrote the first edition of this text in 1980 when I was associated the National Guard Marksmanship Program. Since that time, more than 300,000 copies of the various editions have been printed and distributed to junior shooting programs around the world. This third comprehensive revision of the text is undertaken to prune the text down to bare essentials and to make it easier for the shooter to read and understand.

Since retiring from the military in 1991, I have served as varsity rifle coach for Montgomery Bell Academy in Nashville, Tennessee. This current revision incorporates all that I have learned from my junior shooters.

Over the years, many individuals have helped with the text; I am grateful to the following for their contributions: Randy Lamson, photographer; Jan Manning, writer; Bernie Shuman, illustrator; and Jack Duncan, coach.

For their help with this current revision, I want to thank Bill Krilling, International Rifle Coach at the U.S. Army Marksmanship Unit, for technical advice and my son, Nathan Lujan, for his photography.

Your suggestions to improve this Shooter's Guide will be appreciated.

Leo R. Lujan
PO Box 3207
Brentwood, TN 37024

CHAPTER I

Introduction

Marksmanship is a proud part of our national heritage. Our forefathers fought the Revolutionary War to gain their freedom as individuals and independence as a nation. Just a few years later the United States of America was called upon to defend its newly-won independence in the War of 1812.

In both of these wars, skilled American riflemen played a deciding role. It is easy to understand why Americans were skilled marksmen during the Revolutionary period.

They had to know how to shoot accurately to put food on the table and for their own protection. Marksmanship skills have been valuable national assets.

There is still a need for these skills. Today there is another call for expert marksmen in the exciting sport of competitive shooting. In recent

years, the United States has been a dominant force in international shooting competition. This includes such events as the World Shooting Championships, the Pan American Games and the Olympic Games.

You are starting a sport that can, with study, practice and hard work on your part, lead you all the way to the Olympics.

Competitive marksmanship does not require great physical size or strength. Even though physical fitness and stamina are important, mental qualities determine whether a shooter will ever become a champion. Being able to concentrate completely on a task and being able to relax under pressure are two of the mental keys to success.

See what you can learn from the following stories which applies to you.

Profiles of Three Olympic Champions:

Gary Anderson

Pretend it's 1956 and you're growing up in the isolated Nebraska farm country where guns are used for one primary purpose: hunting. You want to learn something about "target shooting," but it seems as if no one in the area has ever heard of such a thing! You can't find anyone to teach you the sport. You don't know what equipment you need and can hardly afford it anyway. And even if you do learn the sport, there's no one in the area you can compete with.

If you were in this situation, it would be ridiculous for you to ever dream you could win an Olympic gold medal for target shooting. Right?

Wrong! Gary Anderson, won two Olympic gold medals, claimed seven World Championships and set six individual world records. Don't tell this self-taught Nebraska farm boy it can't be done!

When Gary was about 15, he had two avid interests: guns and sports. He liked hunting and

appreciated the craftsmanship in firearms. He was also a sports fan interested in all kinds of athletic competitions—especially the Olympics. Gary was an avid reader. One day, while browsing through a gun magazine, he made an exciting discovery that would forever change his life: target shooting was an Olympic sport! "That was all the inspiration I needed to get serious about shooting," he recalls. "But I lived in an area where there were no gun clubs, no instructors, no assistance of any kind to help get me started."

His solution? He collected every magazine article he could find on target rifle shooting.

Through reading, he learned about the various shooting positions and the equipment he would need. He taught himself, as best he could, the techniques of precision target shooting.

Gary knew he wanted to become a champion shooter, but he still didn't know how to make that dream a reality. Finally he found an article in a

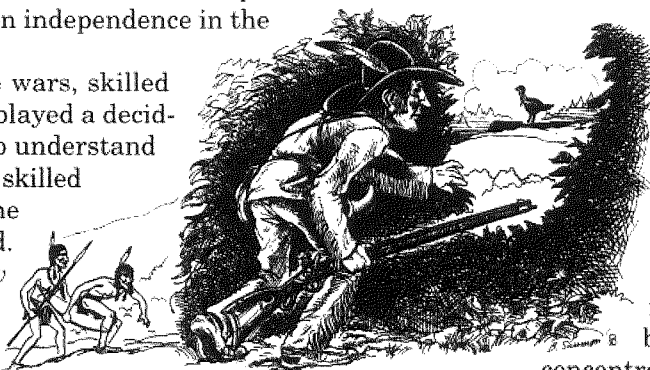

1955 issue of *The American Rifleman* that provided him a passport to international success in the sport. It was written by a Russian named Anatoli Bogdanov and explained the training regimen that had made this particular Russian a world-class shooter.

“Bogdanov spoke of shooting thousands of rounds and dry-firing (practicing without live ammunition) for hours and hours,” Anderson says. “His article made me realize the commitment necessary to become a world champion. That was the standard after which I chose to pattern myself.”

Gary, however, couldn’t afford “thousands of rounds” of ammunition for practice. So he improvised. “I got an old, beat-up .22-caliber rifle and every day I dry-fired from the time I got home from school until supper, and then again after supper. When I was a senior in high school, I was putting in three to four hours of dry-firing each day.”

He then went to the University of Nebraska for a year, where he shot on the college rifle team. The range was open for four hours a day, and Gary spent nearly all his free time there, practicing and perfecting his craft. By now he was winning every local match; but he was still a virtual “unknown” in the world of competitive shooting.

Pat Spurgin

Pat Spurgin was only 18 years old when she won an Olympic gold medal in air rifle at the 1984 Olympic Games.

Eighteen! That’s a tough time of life to give up Friday night movies and parties and spend your time practicing at a rifle range instead. But as Pat looks back on it now, that Olympic gold medal was well worth the sacrifices.

Besides, by the time she was eighteen, shooting — and winning — had become a way of life for her. She’d already been doing it for about nine years.

“My dad managed a sporting goods store,” explains Pat, a native of Billings, Montana. The local gun club had put up a poster in the store, encouraging all junior shooters to come to the range and shoot on a special night reserved just for them. “My dad

At that point, he decided the best way for him to reach his goals would be to join the Army and request an assignment at Fort Benning, GA., home of the U.S. Army Marksmanship Unit (AMU) and the Army’s international rifle team. He tried out for the team and was accepted. With a little more training, he made his first U.S. Shooting Team in 1959 and competed in the Pan American Games, where he won his first two international medals — a bronze for 50-meter, three-position smallbore, and a silver for 300-meter large-bore. In 1960 he went to his first Olympics as an alternate on the U.S. team. In 1962 he won four gold medals at the World Championships. In 1963 he again went to the Pan Am Games and brought home two gold medals.

The highlights of his illustrious shooting career, however, were the 1964 and 1968 Olympic Games; Gary Anderson won gold medals in both!

Some people might say the odds were against Anderson ever developing into an Olympic medalist. After all, as a youngster he lacked the fine equipment and proper coaching available to many beginning shooters today. But young Gary Anderson did possess the most important element of all: determination. Once he’d decided he wanted to become an Olympic champion, he didn’t let anything stop him!

thought that sounded like a good idea, so he took my brothers and sisters and me down there. That’s how we got started.”

At that time, she was shooting only smallbore rifle, and with minimal success. In fact, she was ready to quit shortly after she’d begun.

“Friday night was Beginners’ Night,” she says, “and Friday night was a pretty big night to use on something I wasn’t very good at — something I didn’t particularly enjoy. I kind of resented that. It would have been much more fun for me to go to slumber parties like the rest of my friends.”

She was only nine years old then. “But my dad figured that if my older brothers and sisters could do it, I probably could too,” she recalls. Her mother also encouraged Pat to stick with it. “She wouldn’t let us quit anything new without giving it a fair try,” Pat says.

By the time she was ten, Pat was shooting regional matches. “The first real match I shot was



a Wyoming State Championship. I wasn't a prone shooter and never have been—I don't particularly enjoy shooting prone—but my coach made me shoot all prone in that match, and I won by default." No one else in her age group classification, which was called "Sub-Junior," had entered that particular match.

Next, she began shooting junior sectionals—bigger matches with more "on the line." By the time she was twelve, she was competing on a National Championship level and winning the Sub-Junior awards.

Pat reached a turning point just three years later in 1981. She'd been shooting air rifle in addition to smallbore, and at age fifteen she shot in the tryouts for the U.S. Air Gun Team. "I was only one person away from making that team, and it really made me mad to come so close and still miss out!" she says. "I felt I should have been on it. So, right then, I promised myself I'd be on the next team."

She kept the promise. In 1982 she was selected to the U.S. Development Team. From there on, her shooting steadily improved, and Pat Spurgin was well on her way to an Olympic Gold Medal.

On that fateful July day in 1984, Pat recalls struggling with every one of her 40 Olympic shots. "I fired my first shot and said to myself, 'Good grief, 39 more of these to go!' I'm a very conscious shooter; I'm very aware of what's going on around me while I'm shooting." Consequently, she felt extreme pressure; after all, the whole world was watching her shoot and the United States was depending on her!

But Pat feels the nervousness actually helped her that day. "If you're not afraid of nerves, they don't hurt you at all. In fact, I think nerves make you a little more aware of what's going on; they make you a little sharper mentally, a little more

decisive physically. I usually only get nervous if I'm shooting badly and need to catch up, or if I'm shooting better than I normally do." And that day, she says, she knew she was at her best. "When I finished and walked off the line, I knew I'd had the best performance of my life."

She didn't know, however, that she'd won the gold medal. At that point, it didn't even matter to her, she says. "The feeling of winning, of actually receiving the medal, wasn't as spectacular as knowing I'd performed to the absolute best of my ability."

What had inspired her to become the best in the world? "I just set a personal goal to be really good at something, and shooting happened to be it. Once I made the U.S. team, I felt a tremendous responsibility to shoot well, to justify my position and win medals for our country."

Pat advises beginning shooters to set goals for themselves. You can't get anywhere without them," she cautions. "Start with small goals and work up from there. You may eventually win an Olympic gold medal, but that shouldn't be your primary goal. If the small goals aren't met first, you'll never walk up to the big ones."

As for sacrifices like Friday nights, she says, "After I started shooting a lot and improving, it really became enjoyable. I made new friends who were all connected with the sport. Shooting became an important part of my life."

It still is. After attending four years of college on a shooting scholarship at Murray State University in Kentucky, she moved to Fairbanks, where she now assists with the University of Alaska shooting program. Her life is truly centered around the sport.

So don't talk to Pat Spurgin about sacrifices. As she puts it, "Doing something you really enjoy is never a sacrifice!"



Lanny Bassham

When Lanny Bassham was in grade school, he noticed that kids who found sports they were good at seemed to have more fun. He decided, right then, that he wanted to find such a sport.

But there was a problem. Lanny wasn't blessed with

natural athletic ability. Not even a little bit. He was smaller than many of his classmates, and he lacked coordination. As he puts it, "I never won a race in my life. I wasn't even good enough to be average."

However, Lanny possessed something the other youngsters didn't: a burning desire and drive to become a winner. He craved the recognition that winners received. He wanted to share in it so desperately that he tried his hand at a number of different sports.

Baseball, for example. He was the last person picked for the team. "I got alternate right field," he grimly recalls. "If you've ever played Little League

baseball, you know that's where they put their worst player. And I was the alternate!"

Finally one day, a friend told Lanny he was going to the rifle range. Lanny often relates the fateful conversation the two shared that day I asked him, "Rifle shooting? What's that?"

"It's an Olympic sport," he said. An Olympic sport? I was interested!

"Tell me," I asked, "how strong do you have to be to be a rifle shooter?"

"You don't have to be strong!" he said.

"How tall do you have to be to be a rifle shooter?"

"You don't have to be tall!"

"Tell me, how fast do you have to be to be a rifle shooter?"

"You don't understand," he replied. "You don't have to be tall or strong or fast. All you have to do is stand still."

"Great!" I exclaimed. "An Olympic sport where all you have to do is be still! I've finally found something? I can be good at!" That was the beginning of my shooting career.

With his father's encouragement, Lanny tried shooting and was delighted to discover a sport at which he was "average." He stuck with it and became better and better. When the other kids were going to movies, Lanny was practicing. He realized that if he truly dedicated himself to the sport, he could become far above average and even win matches. When he was 15, he accompanied his dad to the National Rifle Championships at Camp Perry, Ohio, where he won the "HPR Junior Championships. He excelled on the high school smallbore team, and traveled on to the collegiate level. After four years as an NCAA All-American shooter, he joined the Army and was assigned to the AMU where he trained daily with the Army's international rifle team.

The training and discipline he gained paid off. In 1972 he realized a childhood dream and made it to the Olympics in Munich as a member of the U.S.

Shooting Team. But the dream quickly turned into a nightmare when Lanny got to the firing line and found himself so overwhelmed by match pressure that he was unable to perform anywhere near his capability.

I felt like my world had ended," he recalls. "I had failed my country, my family and myself. Ten years of training had not prepared me for that day." He still managed to win the silver medal. He resolved to return to the Olympics and win the gold. "I knew," he adds, "that I'd need a mental game plan."

He set out to discover the psychological secrets of winners. He searched for an expert who could tell him how to be mentally prepared and how to control match pressure. No one had a simple answer, but he managed to glean bits and pieces which he eventually fit together in his own mental training program, "Mental Management." He discovered that, having long since mastered the physical mechanics of good shooting, the mental mechanics were every bit as important.

His shooting took a quantum leap forward. In 1974 he set a smallbore national record, that stood for more than 12 years. He won 15 medals, including eight gold, at the World Championships in Switzerland. But it was 1976 in Montreal, when Lanny truly fulfilled his life long dream; he won an Olympic gold medal. This time he performed like a true champion. He was calm, relaxed, and ready. He knew while he was shooting that "The Gold" would be his.

As if that weren't enough, he went on to repeat his gold-medal performance two years later at the World Championships in Seoul, Korea. Since then, he's been teaching others how to achieve their goals using the same mental training techniques that helped him win the Olympics.

Lanny Bassham is proof-positive that anyone—short, tall, big, small, fast or slow—can be a winner. All you have to do is set your mind to it!

CHAPTER II

Equipment, Clothing and Supplies

When compared to firearms, air guns offer many advantages to the competitive shooter. They are fairly quiet so they can usually be fired without disturbing others. Enclosed spaces are readily available which can be quickly and easily converted into a safe air rifle range. This makes it easier to find a place to shoot an air gun. And lastly, pellets are a great deal less expensive than the comparable grades of bullets.

When you consider that it takes the very same skills to fire an air gun with precision as it does to shoot a firearm, you can see why nearly all of the top national and international competitive shooting champions train with air guns to sharpen their skills.

The shooting sports are expensive. Just the cost of equipment, which can run into the thousands of dollars, keeps most juniors out of the sport unless they can get financial support from their family or an organization.

So that the largest possible number of juniors could learn gun safety and the fundamentals of position shooting, several national youth organizations have established tournaments which limit competitors to moderately priced equipment. These limits encourage more youth to try the sport and it allows all who enter the tournaments an equal opportunity to do well based on skill rather than equipment.

The equipment you will be needing to complete the Position Air Rifle Course and to take part in the follow-on programs sponsored by the National Guard and the American Legion is covered in this chapter.

Position Air Rifle

We have established that the rifles used in our entry level program will be .177 caliber air rifles manufactured in the United States with a cost to affiliated organizations or their members not to exceed \$180. The rifles must come equipped with a hooded front sight, a rear sight with micrometer adjustments for windage and elevation, and a web sling. They may not be break barrel rifles as they are too difficult to load and charge safely in position shooting.

Based on tests for accuracy and function, the preferred rifles are currently the Daisy Model 853 and Daisy Model 953. Other rifles, however, may be used in the program if they meet the requirements spelled out above. All U.S. manufacturers are invited to submit air rifles for test and evaluation for use in this program.

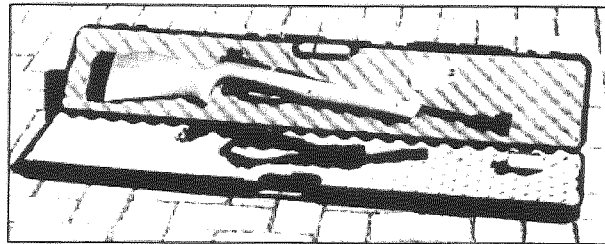

Hard Shell Gun Case

The only way to really protect a rifle for storage and transit is to use a hard shell case that is lined with two layers of sponge rubber. When closed, the rifle is surrounded by the sponge rubber and will be protected even if dropped. Sturdy cases with a plastic shell can be purchased for about \$20— well worth the investment. A case with a metal shell will cost a good deal more.

Soft leather or canvas gun cases give little or no protection to a rifle except to protect the finish from scratches. Sights can be severely damaged in a soft case.

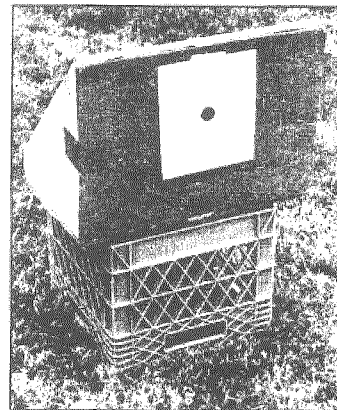

Pellet Trap

Most pellet traps are made of sheet steel and come in many different sizes. When purchasing a pellet trap, you should make sure that the face or opening of the trap is large enough to safely hold the 10-Bull AR-5/10 Air Rifle Target which is 10.5" wide and 12" high.

Shooting Mat

A shooting mat is needed for comfort and stability in the prone and kneeling positions. Its dimensions should be about 30" wide and about 72" long, and no more than about 3/4" thick. A shooting mat may be purchased from a shooting supply house for about \$55 or it can be made out of surplus

carpet for nothing. Most carpet stores will give you a brand new piece of excess carpet that can be cut down to the appropriate size.

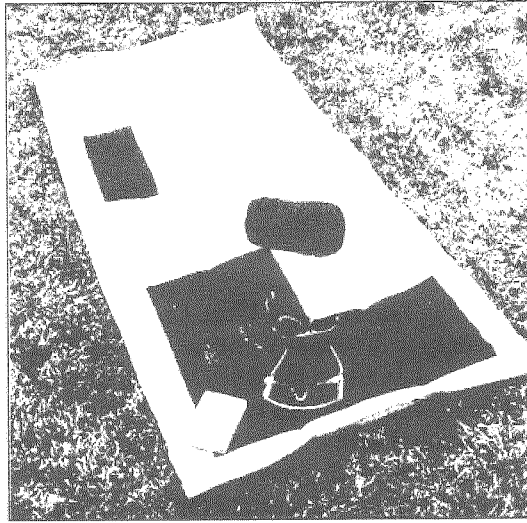

Kneeling Roll

The kneeling roll is an essential piece of personal shooting equipment both for comfort and for stability in the kneeling position. A kneeling roll may be purchased for about \$16 from a shooting supply house or they may be made at home for about \$2 in materials

Shooting Glove

Without a shooting glove, a tight sling may cause discomfort as it extends across the back of the hand that supports the rifle. It may also provide some stability to the rifle. A shooting glove may be purchased from a shooting supply house for about \$18. A cloth work glove costing two to three dollars a pair may also be used. If you use a work glove, the fingers beyond the knuckle should be cut off the glove.

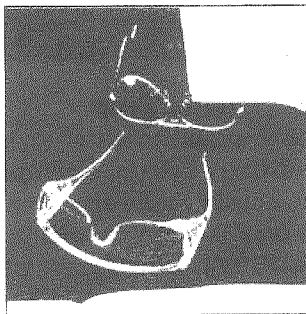

Shooting Glasses

One of the most essential pieces of safety equipment you will ever own are your shooting glasses. If you already wear prescription glasses with hardened lenses, you don't need special glasses. Everyone, however, should wear some form of shatter resistant glasses while shooting. Impact resistant

plastic glasses may be obtained for as little as \$3 a pair. Regular shooting glasses with impact resistant lenses will run about \$18.

Hearing Protection

Special hearing protection is not a safety requirement when shooting an air rifle. It is, however, essential when shooting a firearm. As a result, some shooters who switch back and forth between air guns and powder guns will wear ear protection during both types of shooting so that one or the other will not feel awkward.

Clothing

No special shooting coats, shooting pants, or shooting boots are allowed in this course and follow-on entry level programs. They are expensive, juniors may quickly outgrow them, and their purchase can wait until an individual reaches an advanced skill level. Additional sweatshirts may be worn at the option of the shooter to absorb pulse beat. No boots or shoes higher than the ankle are allowed. Most beginning shooters fire in a comfortable running shoe.

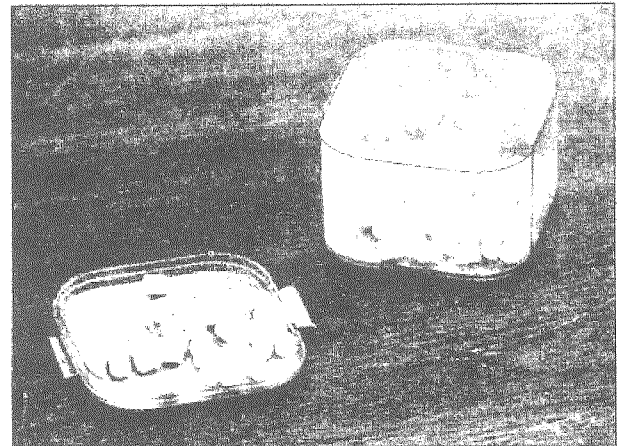

Pellets

Pellets in .177 caliber are available at most hardware stores and discount stores which sell air rifles. You should shop around as the price may vary widely from store to store for the same product. Pellets used in target shooting have a flat nose, so that they make a clean scorable hole in the target.

Targets

Three different targets are used in this program; they are the Air Rifle Tyro Target, AR 5/5 and AR 5/10 (the number after the slash designates the number of bulls). They are not usually available locally. These targets may be obtained from one of the specialty firms that print targets. You should shop around for the best price.

Miscellaneous Items

You will need some method of elevating your pellet trap-about 16" for prone and more for the other positions. Milk crates or boxes may serve this purpose.

A piece of 1/8" wood dowel is useful in removing jammed pellets without damaging the barrel.

You should obtain a three-ring notebook for this handbook, your note-taking in the BMC, and to keep track of your scores and sight adjustment data.

Sources of Supply

See back cover for information on firms which can provide nearly all your shooting needs.

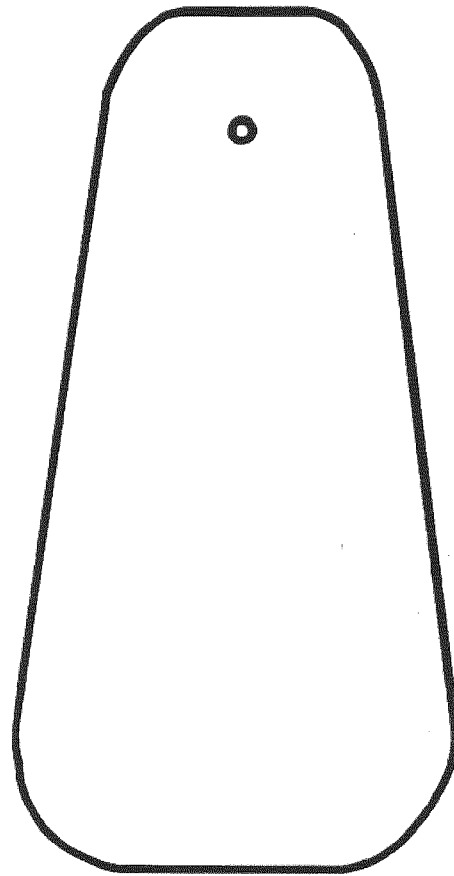

BLINDER TEMPLATE
(See Chapter VI for use)

CHAPTER III

Gun Safety and Range Commands

Competitive shooting is the safest of all competitive sports. No other sport has a lower rate of injury to either participants or spectators. There are two reasons for this remarkable fact. First, safety is taught from the moment a new shooter enters a shooting program. Secondly, safety rules are stringently enforced on all properly run ranges – from the local shooting club to the Olympics.

The general public does not seem to be aware of

the serious consequences resulting from a lack of knowledge about guns, nor is there a proper respect for the potential danger involved with the unsafe handling of guns. Because of ignorance or carelessness, thousands of tragic accidents occur every year with guns that result in injury or death. These points are illustrated in the newspaper articles shown below.

Teen dead from shooting mishap

Jonathon Feeney, 16, a Shreveport resident who police said formerly lived in Carlton and attended Pine Lakes High School was accidentally killed in a shooting incident Thursday at a townhouse on Miller Circle in Carlton.

According to police officials, three Carlton juveniles aged 15 to 17, one of whom lived at the Miller Circle townhouse, were examining a .44 caliber magnum rifle at about 3:30 p.m. The Feeney youth and four other teenagers arrived to visit the townhouse resident and knocked on the front door.

Unaware that the rifle was loaded, the 15-year-old juvenile inside the home picked up the firearm, cocked it and aimed it at the front door. When Feeney walked in, the youth pulled the trigger.

The shot hit Feeney in the head. He was dead on arrival at ACCESS.

Police ruled the death accidental and said no charges would be filed in the incident.

Gun Safety Lessons Come Hard

Donald K. Larson was holding a pistol on his lap while he drove to a friend's house, near Spence Road. He missed the turn and braked hard. The gun fell to the floor and went off; a bullet went through his left leg.

Larson is one of thousands who suffer from accidental gunshot wounds each year, said a Police spokesman. Many others, not so lucky as Larson die because of carelessness with firearms.

"I've always respected firearms," said

the 27-year-old man in his hospital room Tuesday.

But he got overconfident Sunday night and accidentally shot himself.

"It hurt right away," he said. "I bled excessively and lost consciousness. But I didn't think I was dying.

He woke in Smithburg General Hospital. "I never carry a loaded gun," he said. But this time I forgot to check the chamber, and there was a round in it."

"Unloaded guns" cause accidents

By BRUCE SMITH, Staff writer

The tragedies of gun accidents often unfold in strange ways. Like the child investigating his father's study who finds a pistol in the drawer; the child begins playing with it as if it were a toy.

The child's older brother, seeing the door open, walks in and is shot and killed by the child playing cops and robbers.

There is also the man showing a gun to a friend who is positive the gun is unloaded. However, when he points the gun at a neighbor's house to show the trigger mechanism, he finds out there was still a bullet in the chamber. He also finds out he has wounded his neighbor. These are not actual accounts, but happenings like it occur too many times. People who don't know anything about handguns, or people who think they know more than they do, begin fooling around with a deadly weapon and, usually, someone gets hurt.

In Maryland alone last year, 51 people were injured by an accidental gunshot.

Toddler dies of revolver wound

By Joe Nawrozki
News American Staff

Three-year-old Damon Williams had spent a lot of time inside recently, recovering from an automobile accident. And when he found a 38-caliber revolver wrapped in a brown paper bag and stuffed beneath a bench cushion at his home, he apparently thought it was another toy.

It went off while he was handling it in the basement of his northwest Baltimore home, and he died from the wound.

Police were attempting to determine where the gun came from and who owned it. Members of the child's family say it might have belonged to a relative who lived at the house.

According to police Damon Williams found the gun Sunday.

The most common refrain following a gun accident is, "I didn't know the gun was loaded!" said with remorse and stunned disbelief. There is one cardinal rule of gun handling - **Treat every gun as if it were loaded!** If everyone would follow this maxim, hundreds of accidents could be avoided.

At home, **make sure that guns are stored where they can't be reached by children too young to understand and practice gun safety.** Gun accidents can be prevented by treating all guns with respect and concern. Safety must be the number one concern of all shooting athletes. You must learn how to handle a gun safely before you learn how to shoot accurately.

Nearly all gun accidents are caused by:

- Lack of concern for the potential danger involved in the careless handling of a gun, or
- Ignorance of how a gun operates.

Gun Safety Rules that you should know, understand and practice if you are to be a responsible citizen are shown on the back cover. The Four Safety Rules that you must demonstrate that you know before you can handle a gun in this course are:

1. Always point the muzzle in a **safe direction.** On a shooting range, that is "down range" toward the targets or straight up.

2. **Keep your finger off the trigger** until you are ready to shoot. The trigger guard will allow you to hold the gun comfortably with your finger off the trigger.

3. **Keep the action open and unloaded** until you are ready to shoot. When you first pick up a gun, open the action and make sure that it is unloaded. When you finish firing, open the action and put the gun down.

4. **Don't touch** your gun unless you are told to do so by the range officer or the person in command of the firing line. In particular do not touch your gun while someone is down range!

With the help of your instructor, you will soon learn to follow these rules without conscious thought. You must, however, always guard against becoming careless and correct anyone who does not follow these rules on the range.

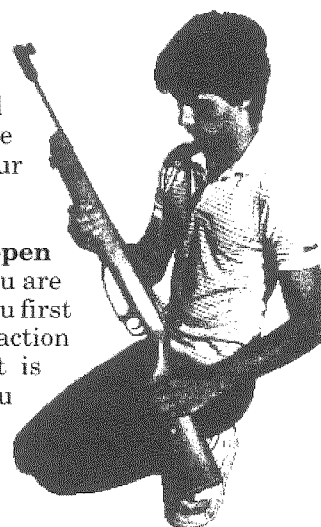

Range Commands

Range commands are the instructions given by the range officer to effect the orderly and safe operation of the range. Some of the terms may seem strange at first but you will soon learn to respond properly to each command. In time, you will probably even learn to give them yourself. A typical sequence of commands (bold type) is shown below followed by the action expected of the shooter:

RELAY ONE TO THE FIRING LINE.

Shooters go to their assigned firing points.

GO FORWARD AND HANG YOUR TARGET.

Shooters go down range, hang their targets and return to their firing points. When all shooters have returned,

THE LINE IS NO LONGER SAFE. YOU MAY HANDLE YOUR RIFLES. THIS WILL BE THE (??) COURSE OF FIRE.

Shooters prepare for the course of fire given in the command.

IS THE LINE READY?

If you are not ready, raise a hand and call out "Not ready!" If you are ready, remain silent. If the line is not ready, the range officer will usually allow time to get ready. When the line is ready, the range officer will call out

THE LINE IS READY, COMMENCE FIRING, YOU HAVE (??) MINUTES.

Shooters may now charge and load their air guns and start firing. At the end of the allowed time (or in an emergency), the range office commands

CEASE FIRE. CLEAR AND GROUND ALL RIFLES. MAKE THE LINE SAFE.

Shooters must stop firing immediately, pull the bolt to the rear, and ground their rifle. If you still have a loaded rifle, you must take the additional step of raising your hand and calling out "Loaded Rifle!" The range officer will give you instructions on what to do next. When all guns appear to be cleared (actions open and unloaded) and grounded, the range officer will ask

IS THE LINE SAFE?

Silence indicates that the line is safe (all guns grounded with actions open and unloaded). If there is any unsafe condition, a shooter should raise a hand and call out "Not Safe!" When the safety problem is resolved, the range officer will say

THE LINE IS SAFE, GO FORWARD AND REPLACE (or REMOVE) YOUR TARGETS

Target exchange should be done quickly without visiting with other shooters. More shooting time is lost because of slow target exchange than any other reason.

We are back at the start of a new sequence and the range officer will start a new series of instructions or tell you to remove your gear from the line.

One last thing you should know about range commands. Anyone on the firing line, even a spectator, may call out "**CEASE FIRE!**" if a life threatening situation is observed.

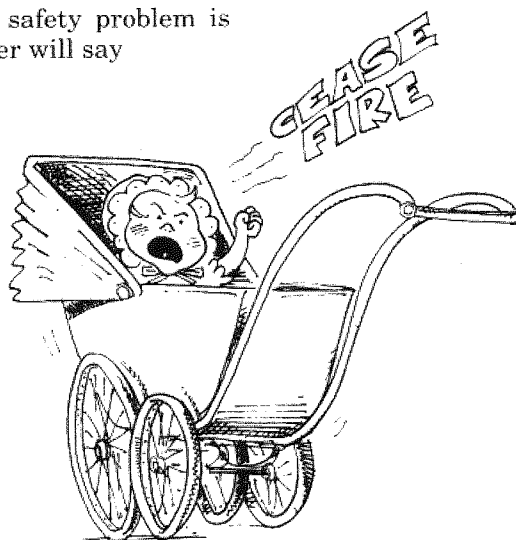

CHAPTER IV

Operation of Air Rifle

If you are to use your air rifle safely and with skill, it is very important that you know how it works and how to take care of it. That is the purpose of this chapter. The parts of the air rifle which you must be familiar with are shown below:

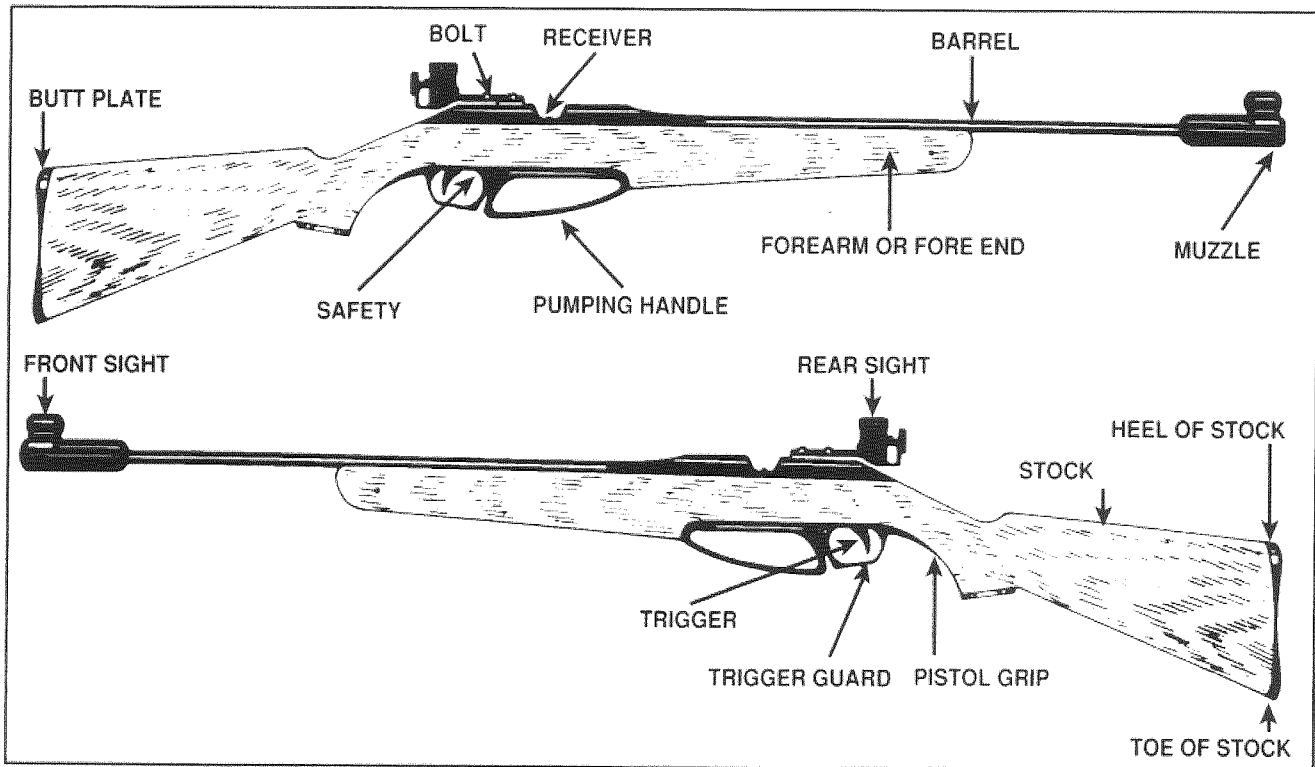

The rifles currently recommended for use in entry level position training are the Daisy Models 853 and 953. These guns were selected for their moderate price, durability and function. The 953 is the same as the 853 except that it has a stock design that is more suitable for competition shooting.

In the specifications, it refers to the rifles as “pneumatic single stroke pump.” This means the rifle is powered by a gas (air) which is compressed with a single stroke of the pump handle. The air is trapped in the chamber under pressure until you pull the trigger. The trigger releases the air which propels the pellet out of the rifle. The muzzle velocity (speed of the pellet as it leaves the barrel) will depend upon the amount of air trapped in the chamber; more air trapped in the chamber results in more velocity and less air in less velocity.

It is very important for accuracy that the muzzle velocity be consistent from shot to shot. Actual velocity is not as important as consistent velocity from shot to shot.

How you pump the rifle will affect the accuracy of the rifle. When you pump the rifle, a measured

amount of air is compressed in a chamber. Your pumping action can change the amount of air in the chamber. Failure to fully extend the pump handle and pause for one full second may result in a partial

853/953 SPECIFICATIONS

- Action:**
Pneumatic single stroke pump bolt:
- Ammunition:**
.177 caliber
- Barrel:**
Rifled steel
- Safety:**
Manual
- Sights:**
Hooded front sight with aperture inserts. Fully adjustable rear peep sight with micrometer calibrations.
- Weight:**
5.5 lbs. (2.5 kg)
- Length:**
39 inches
- Muzzle Velocity:**
545 Feet Per Second

charge of the rifle and a reduction of accuracy.
Therefore, when you pump:

- Open the pump handle until it is fully extended.
- Pause for one full second while the pump fills with air.
- Then close the pump handle in one steady motion.

How to Operate the Rifle

Whenever you take the rifle out of a gun case or out of a storeroom, the first thing you should do is open the bolt if it is not already open. After you fire a shot, the first thing you do is open the bolt. Therefore, we start the following operations sequence with the assumption that the bolt is already open.

Step One. PUMP

With the rifle pointed in a safe direction, fully extend the pump handle, pause one second, and close the pump handle.



Step Two. LOAD

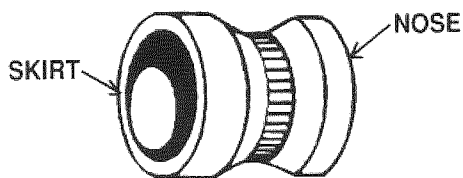

PELLET ENLARGEMENT

Place one pellet on the loading ramp. Make sure that the nose (solid tip) of the pellet is pointed toward the muzzle and the skirt to the rear. If the pellet is not aligned properly, rotate the rifle and allow the pellet to fall out of the rifle into your hand - then start again.

In time, you will be able to duplicate the execution of this action almost exactly each time you do it.

If you pump the Model 853/953 more than once without firing it, you will not gain additional pressure nor will you damage the rifle; any charge in the rifle is released when you extend the pump handle.

Step Three. CLOSE THE BOLT

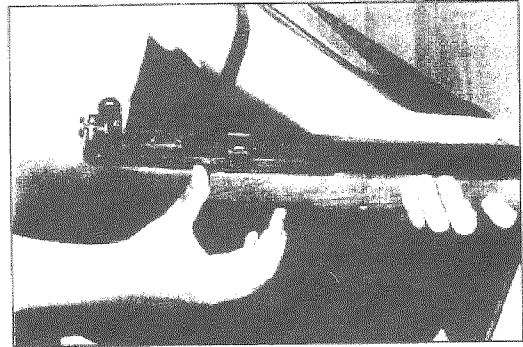

Slowly push the bolt forward until the bolt is closed.

Step Four. AIM

Step Five. FIRE

Fully explained in later chapters

Step Six. OPEN BOLT

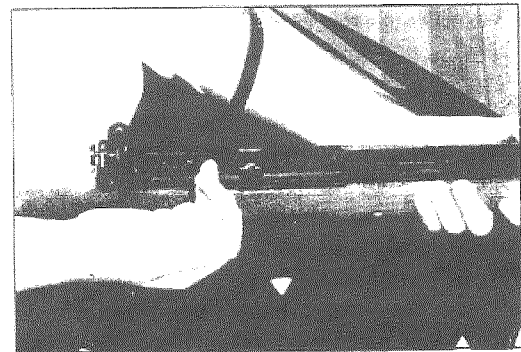

Pull the bolt to the rear until it stops.

Safety

The safety device on a gun, meant to prevent it from firing, is not routinely used on a competitive shooting range. To prevent accidents, personnel are not allowed down range unless all bolts are open and all rifle are grounded. In addition, no one may pick up or touch a rifle while there are personnel down range.

There may, however, be unusual circumstances which require the rifle's safety device to be used. In

that event, the range officer will state:

"ALL RIFLES ON THE FIRING LINE ARE TO BE PUT ON SAFE."

To do this, open the bolt. Then push the red button above the trigger guard near the stock from left to the right. The button now exposed on right side of the trigger guard will be black. Then ground your rifle and step back from the line.

Cleaning

Because there is no powder fouling with air rifles, they do not need as frequent cleaning as firearms. Your air rifle should be cleaned about every 500 to 1,000 rounds. To clean your rifle bore, obtain some .177 caliber felt cleaning pellets. Put a drop of 30 weight motor oil on a pellet and then fire it through the barrel. A straightened paper clip may be useful in getting the felt pellet to load properly as they are slightly oversized and tend to go in at an angle which can jam them in the barrel. Fire a second oiled felt pellet down the barrel and then fire dry felt pellets down the barrel until they

come out clean and dry. Firing the felt pellets into a pile of cloth rags will make it easier to find them to see if they are clean. Never fire the felt pellets at another person as they can be just as dangerous as a lead pellet.

Warning: Do not use a light weight oil or a bore solvent when you clean an air rifle. Both are capable of causing a diesel reaction (light oil or solvent when mixed with air may self-ignite under pressure) when the rifle is pumped.

Malfunctions

Malfunctions in the shooting sports are when your rifle won't work or won't work as it should. Common problems are:

Seals. Nearly every air rifle will at some time develop a leaky seal. This may be the result of a small nick in the seal or a piece of dirt lodged against the seal. When you have a leak, you can usually hear it if the range is quiet. Another indication of a leak is an obvious loss of air pressure in the rifle. If a seal needs to be replaced, it is best to send the gun back to the factory unless an experienced armorer is available locally. If under warranty, the factory will do it for you at no cost.

Double Loading. If two pellets are loaded into the rifle, you may be able to fire them out - the result is usually two low hits on the target. A barrel obstruction may also result from loading more than one pellet and serious damage may be done to the rifle by continuing to fire. The best procedure for removing a barrel obstruction or a double load is to push a piece of 1/8" wood dowel down the barrel from the muzzle. The dowel should be smaller in diameter than the bore and about two inches longer than the barrel. Do not use a coat hanger or welding rod as the metal rubbing against the crown of the rifle can harm the accuracy of the gun.

CHAPTER V

Standing Position

In building a position, your goal is to construct a device which will allow you to hold the rifle immobile as possible while you aim and cause the rifle to fire. Given complete freedom to choose materials, you might select steel and concrete. Your "hold" (how still you can keep the rifle while aiming and firing) would be perfect, but unfortunately, it is against the rules.

To build your position, you are limited to bone, muscle, and a sling as your primary materials. Actually you are going to learn to build three positions - prone, standing and kneeling. We are starting with the standing position because it is the least stable and it forces you to learn to deal with immobility. Because a sling is not allowed in standing and the fact that it is the most natural position, it is the quickest and easiest to assume.

Getting into the Standing Position

All descriptions of position in this guide will be of shooters firing with the stock in their right shoulder and aiming with their right eye. Those firing from the left shoulder should reverse all directions. It may be helpful for individuals firing from the left shoulder to go through the position descriptions using a pen or pencil to change the words right to left and left to right in the text.

The critical elements of the standing position are as follows.

1. Feet a comfortable shoulder width apart and pointed 90 degrees away from the target. Weight evenly distributed over both feet.

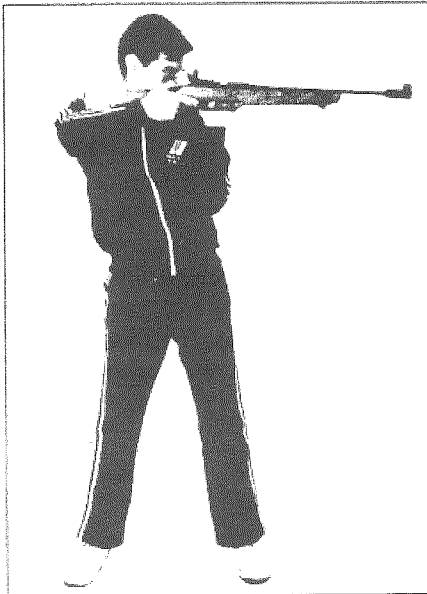

2. Legs should be straight without locking the knees.

3. Hips should be level. Any bend needed to balance the rifle should be above the hips.

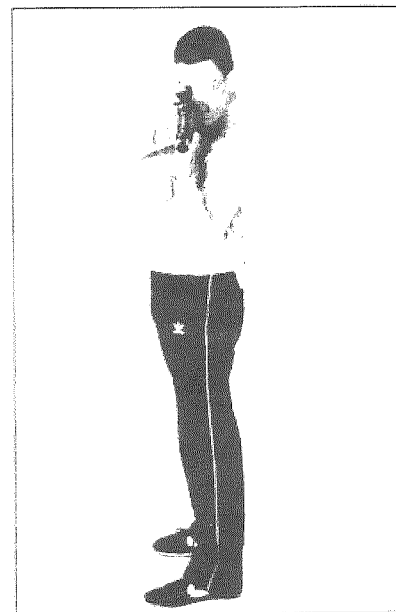

4. Left arm carries the weight of the rifle. The upper left arm rests on the rib cage. The forearm comes straight up from the elbow to support the rifle. This is the most difficult part of the standing position for the new shooter to become comfortable with.

5. The right elbow extends out from the shoulder and the hand exerts gentle pressure to snug the stock into the shoulder pocket.

6. Head erect or tipped slightly forward (should not tilt to either side). The stock rests high in the shoulder pocket bringing the sights up to the eyes to keep from tipping the head forward to aim.

7. Looking from the front, there is a straight line from the left hand, down through the wrist, forearm, hip, and leg to the foot.

8. With the left hand, support the rifle just forward of the trigger guard. The support should be just forward of the trigger guard and the gun should be slightly muzzle heavy. There are several variations of left hand support of the rifle; you should use the one needed to bring the rifle up to eye level. They are illustrated below:

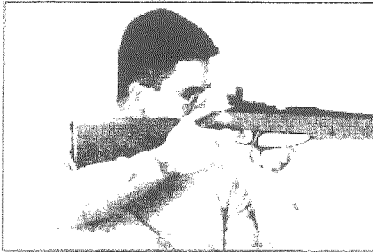

You may support the rifle with a clenched fist. Most shooters using this method will use a shooting glove.



A "V" formed by your thumb and fingers.



Or over the heel of your hand with the fingers relaxed.

You don't have to hold the gun in place, gravity will take care of that.

Refining your standing position may take several weeks until you find all the adjustments that provide for comfort and at the same time allow you to have the best possible hold - as nearly motionless as possible. You must, however, come to grips with the fact that in standing you may never achieve complete immobility.

...tips by Bassham

Getting the most out of your training time. Most shooters think that the fastest way to improve is to fire as many pellets (or bullets) as they can. Unfortunately for them, most of the time, what they are doing is learning how to fire bad shots. Every time they fire a bad shot and it prints on paper, the more likely they are to fire another bad shot.

The most powerful training tool you have is dry fire. Over the next several months, while you are learning to master the fundamentals and learn the positions, over 75% of your shooting should be dry fire that will gradually drop to less than 50% within a year. There are many advantages to dry fire but the most important for you is that you can work on your technique without firing any bad shots. No bad shots is important for your self image and perfect repetition builds your subconscious skill.

In dry fire, work to do your very best on every shot, visualize firing a dead center shot, and when your follow through is completed, feast on your success by saying to yourself, "That is like me!"

CHAPTER VI

Aiming and Trigger Control

Aiming and trigger control are the two most important fundamentals you must understand and master to fire an accurate shot. Before we start

firing, there is a great deal to learn about your eyes, the process of aiming, and trigger control.

Vision

There is no such thing as "perfect vision." The term "20/20 vision" means only that a person can read the alphabet letters 8.7 millimeters high from a distance of 20 feet. Anyone without serious eye defects can usually have 20/20 vision, either naturally or with the help of prescription lenses. If you need glasses, get them; some of the world's best shooters wear corrective lenses. With or without corrective glasses, you must have good vision and your eyes must be used correctly if you are to aim each shot to the best of your ability.

Protect your vision by always wearing glasses with impact-resistant lenses while you are shooting.

Dominant Eye

People are called right or left-handed, depending on which hand they use most frequently. You also have one eye that does most of the work. It is called the dominant eye. You must know which eye is dominant since it will affect the way you aim and hold the rifle. If you don't already know which is your dominant eye, perform the steps in the Dominant Eye Exercise (to the right). You should know which is your dominant eye before proceeding with your reading.

The dominant eye is the brain's primary source for the visual image of what we see. The non-dominant eye is used primarily for depth perception or our sense of direction. Both eyes together give us a reference point for our sense of balance, as you will see when we start working on position shooting.

All beginning shooters should learn to shoot a rifle with the stock in the shoulder on the side of their dominant eye and aim with their dominant eye, regardless of which "handed" they are.

Dominant Eye Exercise



1. Pick a small object on a wall some distance from you such as a light switch.
2. Face the object and extend both of your arms.
3. With both eyes open, form a tight circle around the object with your thumbs and index fingers.



4. Making sure you continue to look at the object with both eyes open, draw your hands back to your face.
5. You will be looking through the circle at the object with your dominant eye.

Get The Most From Your Eyes

By learning how to use your eyes properly, you can see better and work them longer. To do so, practice the techniques outlined below.

Proper Head Position. Keep your head as close as possible to a position which allows your eyes to look straight forward from the eye socket. To illustrate the penalty for not doing this, try moving your eyes as far in one direction as you can (up, down, right or left) in the eye socket. Instantly you will feel a strain on the eyes. The closer you can position your head so that your eyes are looking straight forward from the eye socket, the more relaxed your eye muscles will be. It is okay to tilt your head forward slightly, but you must resist allowing it to tilt to the left or right as that affects your sense of balance.

Both Eyes Open. Your eyes are designed to work together as a team and there is a "sympathetic reaction" between each of your eyes. If you do anything to one eye, it will also affect the other eye. This is illustrated by the following interactions between the eyes:

- Close one eye and you will soon feel the muscle strain of keeping the other eye open.

- Cover one eye, blocking out all light, and its pupil will dilate (open up). The other pupil remains partially closed to block out some of the light. This results in tension between the two eyes and eventual eye fatigue.

- If you get a small piece of dirt in one of your eyes, both eyes will flood with tears to wash away the irritation that is in only one of your eyes.

When aiming, your eyes work best if they are both open and looking as straight forward as possible. Keeping both eyes open, however, while you look through the sights with the dominant eye may cause you to see a double image. Double vision can be easily solved by using a blinder.

Blinder. A blinder can be mounted on the rifle's rear sight to block your view of the target with the non-dominant eye. It should be made out of material which will allow light to pass through but not allow images to be seen through it. Most plastic milk jugs are made out of a translucent material which can be used for a blinder. Cut a rectangle large enough to block your view while aiming. Then punch a small hole on one side of the blinder so that it can be mounted on your rear sight. Unscrew the peep sight, mount the blinder on the threaded extension and then screw the peep sight back on.

Avoid Fixed Vision. If you fix your vision on one object, such as a target bullseye, for more than a few seconds, you will burn the image of the bull into your eye and see a "ghost" image of the bull when you glance to the side. It is especially important for shooters to avoid this fixed vision, because it results in a loss of visual perception and can greatly hinder your shooting performance. To avoid fixed vision, you need only to blink or slightly shift your vision every four or five seconds.

Eye Relief

Eye relief is the distance between the eye and the rear sight. Depending on a shooter's individual build and position, this distance is usually two to five inches. Strive to achieve an eye relief that is comfortable, natural, and allows you to see a circle of light around the front sight as you look through the rear sight. It is important to maintain the same eye relief from shot to shot and to find an eye relief that allows you to keep your head as erect as possible during the shooting process. If you get closer to the sight than 2", the line of white around the front sight becomes larger and more difficult to keep aligned.

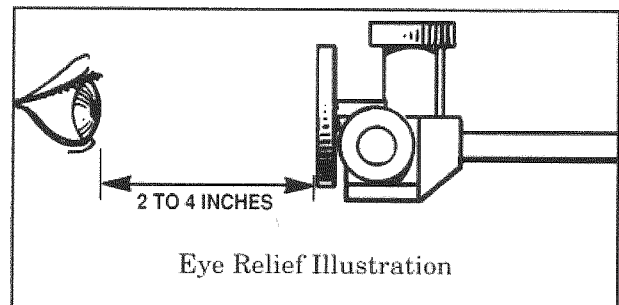

Sight Alignment

Sight alignment is the most critical element of the aiming process. It is the alignment of the dominant eye, the rear sight, and the front sight.

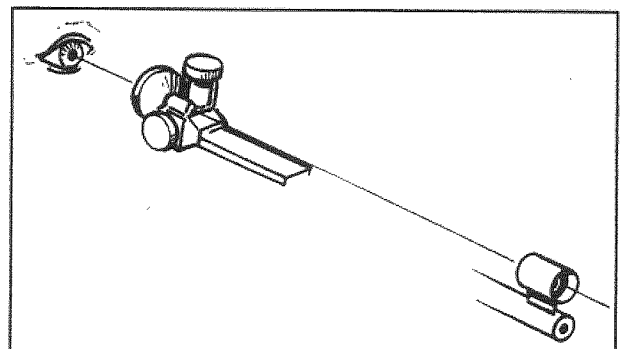

We have discussed the eyes rather thoroughly. Before getting into sight alignment, let's examine the other two elements of the process—the front and rear sights.

Front sight. The front sight on the Daisy 853/953 is hooded; this is a feature found on most competition rifles to shield the front sight aperture from overhead or side light. The hood is formed by a short tube; it is supported by a slender base which is attached to the rifle barrel. The hooded front sight will look like this:

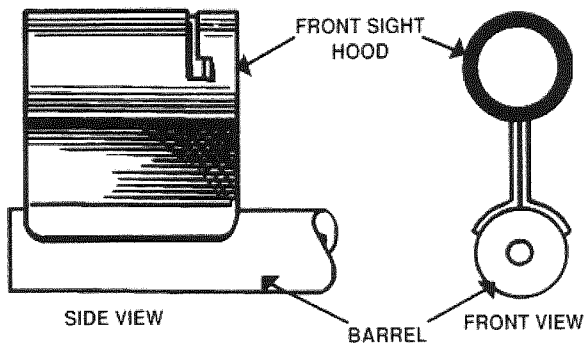

There are several types of inserts which can be used with the front sight but only the aperture insert is discussed here as it is favored by competitive shooters. The size of the aperture can be changed to vary the amount of light around the bull.

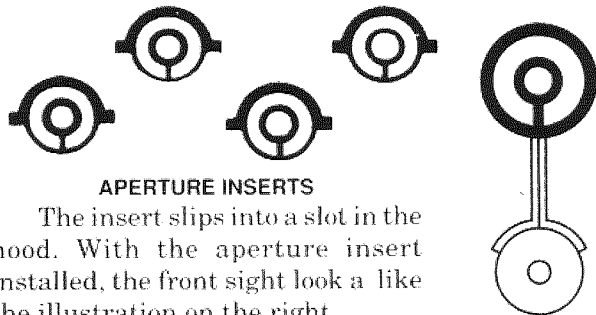

The insert slips into a slot in the hood. With the aperture insert installed, the front sight look a like the illustration on the right.

Rear Sight. The part of the rear sight which you look through is the peep sight. It is a small disk about the size of a penny with a very small hole in it.

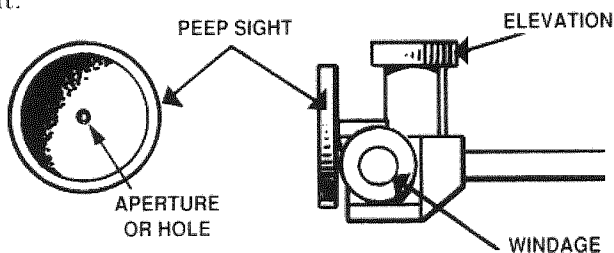

Rear Sight

Now let's return to a discussion of sight alignment during the aiming process. Remember that sight alignment is the relationship between

the front sight and the rear sight with respect to your eye.

When you bring your eye 2" to 4" from the rear sight, you will find that the small hole is large enough to look through and see all of the front sight. This is what you see when you have achieved proper sight alignment.

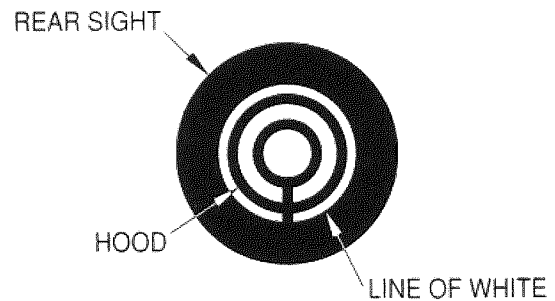

Proper sight alignment is a matter of centering the front sight hood in the rear sight. The hood will not quite fill the rear sight and you will be able to see light around the outside of the hood; we call this a "line of white." **To keep your sights properly aligned, the line of white must be equal on all sides.**

Sight Picture

To obtain sight picture, simply add a bullseye to the innermost ring. Your goal during the aiming process is to maintain proper sight alignment while keeping the bull centered in the front sight. When you can achieve it, sight picture will look like this:

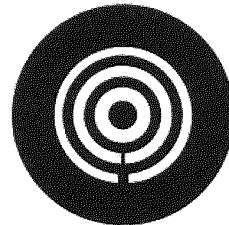

The ultimate goal is to have all the circles in perfect alignment but even some Olympians can only reach this perfection and hold it for no more than a few seconds at a time.

To a shooter who is concentrating on sight alignment, any movement of the rifle while aiming will make it appear as though the bull is moving around within the front sight aperture. This apparent movement of the bull should not overly concern the beginning shooter.

NOTE: Gary Anderson suggests using a front sight aperture that will give you a light ring around the bull which is one-half the width of the bull.

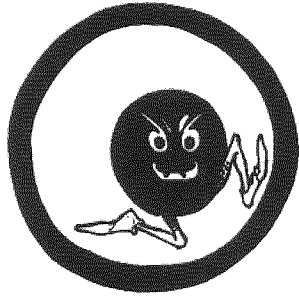

As long as your sights are aligned properly, you will have a fairly good shot result, even if the bullseye is slightly off center in the front aperture when the shot is fired. By contrast, when sight alignment is only slightly off, even if the bullseye is exactly centered in the front aperture, your hit may be completely out of the scoring area of the target.

A very small error in sight alignment will cause a dramatic change in the placement of a shot on the target. With the bull properly centered in the front sight, sight alignment errors will result as follows:

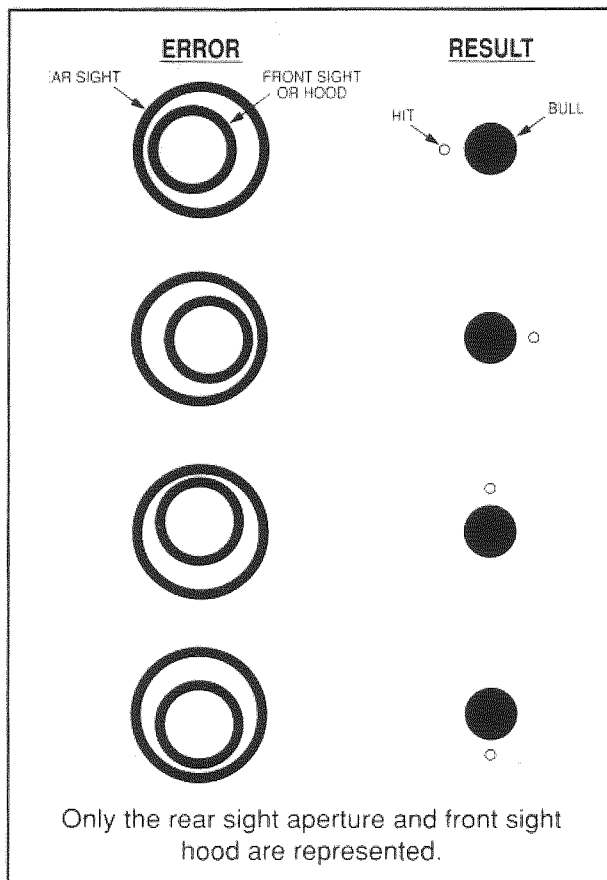

Sight Alignment Error and Results

You must constantly strive to maintain proper sight alignment. It is the most critical element of the aiming process.

Trigger Control

Trigger control is the act of causing the rifle to fire without disturbing aim. In time, it will become a reflex action which you don't consciously think about as you are shooting. When all of the conditions are present, your trigger finger will move on sub-conscious command.

Trigger control involves the following steps:

- Bring the rifle to your shoulder and align your sights keeping the bullseye centered to obtain your initial sight picture. Then place your finger on the trigger and apply light pressure to take up any slack (looseness) in the trigger.

- As your sight picture improves (the circles become more concentric), steadily increase your pressure on the trigger until the shot fires. This steady increase in pressure may take from three to five seconds and the exact timing of the shot, if done correctly, will be a surprise.

- You must hold your position for one additional second after the shot breaks. There should be no relaxation of your hold when the shot breaks and this includes all your efforts toward achieving the best possible sight picture. This step is called follow-through.

- The instant the shot breaks, make a mental image of your sight picture and based on that image, call your shot — that is, tell yourself where the shot went on the target. You can't really do this until you have zeroed your rifle but you should learn now that "calling the shot" is a part of the trigger control process.

Trigger control is explained as four separate steps; but as you learn to apply the steps, you will find that trigger control is actually a seamless process that flows from start to finish.

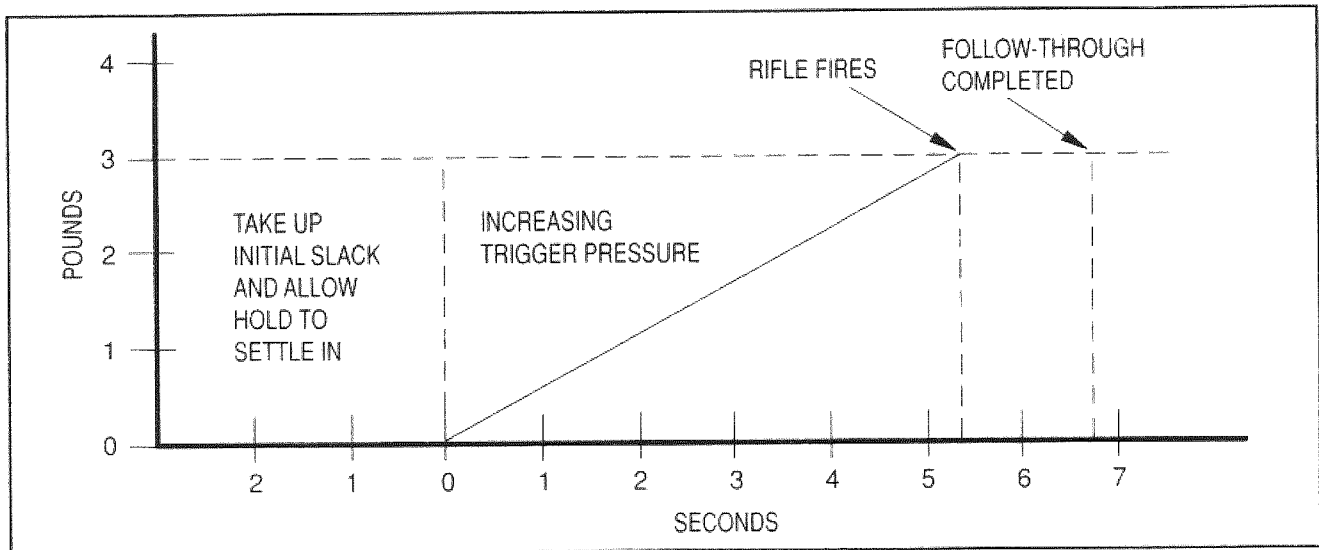

The time graph shown above can be used to illustrate the trigger control process. With the Daisy 853/953, a minimum three-pound trigger pull is required to fire the rifle; trigger pressure is shown on the vertical axis of the graph. The time in seconds for the trigger control process is shown on the horizontal axis. The first few seconds involve settling in and obtaining the desired sight picture. When the sight picture settles, the shooter starts applying increasing pressure on the trigger and continues to try to improve sight picture. The point at which the rifle fires should be a surprise to the shooter—there is no relaxation of hold and the shooter continues to try to achieve the best possible sight picture for one full second after the rifle fires. The actual time it takes to complete the entire process may vary from six to eight seconds.

How you place your hand on the stock and how your index finger engages the trigger will effect your ability to fire a good shot. The gun hand grasps the pistol grip of the stock firmly but without strain. The thumb should point forward and rest along the top of the stock—it should not curl over the top of the stock. The index finger should engage the trigger at the first joint or just ahead of the first joint. At no point should the index finger touch the stock. When trigger pressure is applied by the index finger, it must be straight to the rear.

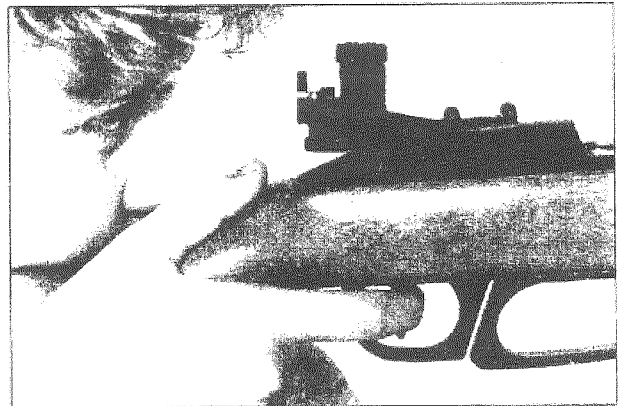

Notice the placement of the thumb along the top of the stock and pointed forward. You can see light between the index finger and the stock—a clear indication that the finger is not rubbing against the stock when pressure is applied to the trigger.

Interrupting The Firing Sequence:

There are situations when a shooter should interrupt the firing sequence; they are:

- Running out of breath.
- Mental distraction
- Deterioration of hold.

If you decide to stop the firing sequence, relax and start over; this, also, is part of trigger control. Stopping the firing sequence, however, can be costly if it is not done properly. It is a two-step process where pressure on the trigger must be released first, then you relax your hold. Should you ignore this sequence and relax your hold just as the rifle fires, you are likely to have a bad shot.

Breathing

There are just two things you should know about breathing:

- Stop breathing when you aim.
 - Taking one (or two) deep breaths and letting it out slowly before each shot will help you relax
-

Shooting Terms

The following terms are used extensively in the balance of the Shooter's Guide and must be understood before going on.

Hold. This is a term frequently used by shooters in describing the process of firing an accurate shot. "Hold" refers to the steadiness with which the shooter can maintain the rifle while aiming and firing. Perfect hold would mean that the shooter was able to aim and fire the rifle without any movement; only the most advanced marksmen are able to achieve this. Beginning shooters must learn to accept movement of the rifle and try to fire each shot while the rifle is steadiest or their "hold" is at its best.

Creep. Any trigger movement from the point after the slack is taken up to the point where the rifle fires is called creep. There is about 1/4 inch of creep in the Daisy 853 trigger. As you are steadily increasing trigger pressure, the trigger will be moving to the rear.

Group. Being able to "group" three shots on a target with some degree of closeness is the first goal a new shooter must accomplish. Group size indicates how well and with what consistency a shooter can aim and fire a rifle. The smaller the group, the better. The best group one could achieve is to fire three or more shots through the same hole, but even champions seldom do this. Beginning shooters should be pleased when they can, after some practice, fire a three-shot group that can be covered by a quarter. Once a shooter is able to consistently group on the target, the task of skill development can proceed.

Jerk. To "jerk" is the most common trigger control mistake made by new shooters. A jerk is when a shooter momentarily sees perfect sight picture and applies immediate trigger pressure causing the rifle to fire an instant after the pres-

sure is applied. This sudden pressure will pull the rifle down before the pellet clears the barrel; it happens so quickly that the shooter may not realize that aim has been radically disturbed. The result is usually a shot outside the scoring ring.

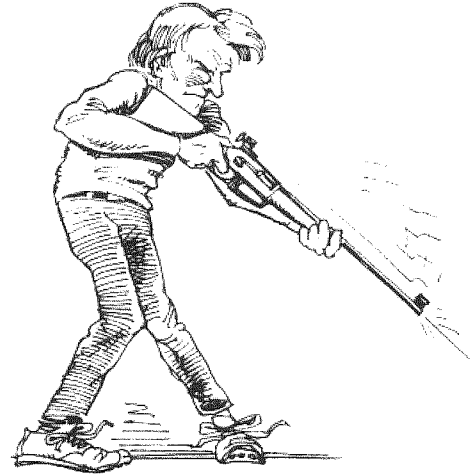

Jerk

Kentucky Windage. Sometimes a hunter, knowing his sights are off in one direction, will aim at a point in the other direction from his target to compensate; this is called "taking Kentucky windage." It is a very imprecise field expedient which is not appropriate for indoor competitive shooting. When you are able to start grouping your shots consistently, it is very likely that the center of your shot group will not be in or near the 10 ring. Resist the temptation to take Kentucky windage to bring your shot group into the middle of the bull. Score has no importance at this point and you must concentrate all your effort on firing the tightest groups possible. You will learn how to adjust your sights (moving the impact of the pellet to the center of the bullseye) in Chapter IX.

Dry Fire. This is one of the most important training techniques for all shooters whether they are beginners or world class athletes. In dry fire, the shooter carefully goes through the steps of aiming and firing a gun that is not loaded. The many benefits of dry fire will be explained later in the text.

... tips by Bassham

Dry fire in a new position. Your first 10 to 15 shots of dry fire when you are learning a new position should be on a blank target. Keep it simple in the beginning. Firing at a blank target allows you to concentrate on maintaining sight alignment. When you feel that you can consistently dry fire a shot while maintaining proper sight alignment, then you can move onto aiming at a bullseye.

CHAPTER VII

Mental Training

If you've watched any sports coverage on television, you've heard it time and again. "This sport is 90 percent mental," says the athlete of his or her event. What does that mean? All you see is the skier skiing, the skater skating, the runner running. It looks very physical, so what's this "mental" stuff all about?

The "mental" aspect is what allows some athletes to out perform equally skilled peers. The mind is the most mysteriously powerful part of the body, and learning to use your mind will give you the competitive edge needed to do your best at any endeavor. You will hear this "mental" aspect addressed by various names; mental training, imagery, and visualization are a few examples.

Lanny Bassham is considered by many to be the foremost authority on "mental training" as it

relates to the sport of shooting. He developed his theories out of a personal need to overcome the "match jitters" that kept him from earning an Olympic Gold Medal in 1972. He studied, researched, and finally formulated a mental training system he calls "Mental Management." Using the system, he returned to the Olympics in 1976 and won the Gold Medal for smallbore rifle shooting.

Bassham went on to win the World Shooting Championship in 1978 before he gave up serious competition to coach, teach and write about mental training.

We have asked Mr. Bassham to write a chapter for this Guide to explain what the beginning shooter needs to know about mental training.

"The Mental Game"

By Lenny Bassham

From my own experience as a shooting coach, I have observed that beginning shooters who start their learning experience with an understanding of the mental process and a few simple techniques will stand a better chance of becoming good shooters; in addition, they will master the fundamentals at a faster pace. My goal is to give you the tools you need to do your best in this course or in any

challenge you face in life.

Before we get started, glance at the model of how the mind works in relation to performance. Performance, no matter what we do, is a function of three mental processes—the conscious mind, the subconscious mind, and the self image. Let's take a look at how each process works.

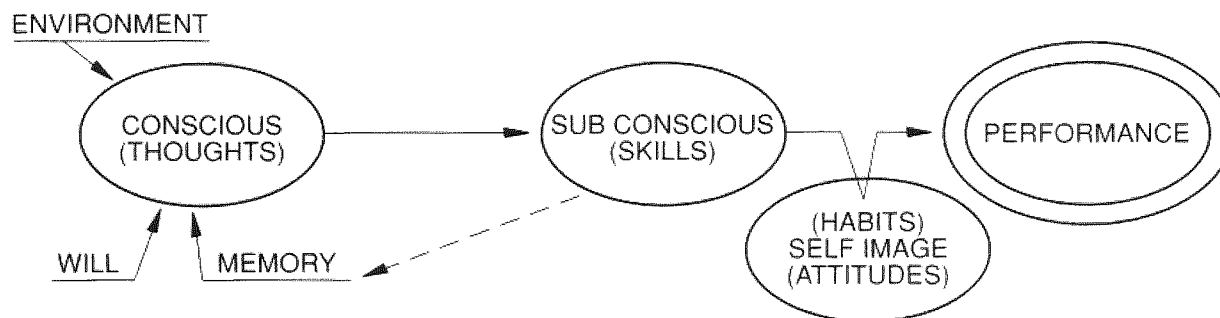

Conscious Mind

The conscious mind has the power to control our thoughts, set our goals, and even distract us and set us dreaming. This is where we concentrate, form our decisions, reason and argue. The conscious mind, however, is limited to just one picture or thought at a time. Anything that requires more

than one thought or picture at a time is too much for the conscious mind to handle.

These pictures or thoughts are generated from three sources: our environment, our memory and our will. We most often tend to think about the picture that our environment presents. When we are in a class, we tend (although not always) to think about what is being taught. Through the will,

we can control our thoughts. We can, if we choose, concentrate on any thought, anytime and anywhere, but just one thought or picture at a time. This is both a strength and weakness of the mental process that we must learn how to use for our own benefit.

Subconscious Mind

Most athletic maneuvers that are flawlessly done look deceptively simple to the uneducated eye. Take the triple jump in ice skating. It looks like one seamless flight of grace and beauty; it is, in fact, dozens of calculated and coordinated steps that have to be executed with split-second timing. The conscious mind can focus on all of the steps just not all at the same time.

The subconscious, however, is quite capable of coordinating all the steps in the jump. In fact, the subconscious mind can perform almost limitless functions at the same time. No one can calculate exactly how many, but the number is in the millions.

Our goal in shooting, as in any athletic maneuver, is to train our subconscious mind to control the act of firing a shot. How do we do this? By repetition.

In the beginning, you will have to control the many steps involved in firing a shot with the conscious mind. You can expect to feel clumsy and it may tax your patience. Don't let this bother you; it is a stage that everybody goes through and is no indicator of how good a shooter you will become.

As you repeat the steps in practice, your subconscious starts to take over and you will begin to develop subconscious skill that allows you to control all of the steps in the shot firing process.

Self Image

Your self image "makes you act like you." It is composed of the sum total of your subconscious habits and your attitudes. The self image is like a great valve that turns success on and off. If we are

doing something far better than our average performance, our self image says, "That is not like me!" and throws in a miscue to get us back in line. If we are performing well below our average, self image will cause us to finish strong so that we fit within the comfort zone of our self image.

Our self image is always changing. We are born neutral and build in our attitudes and habits throughout our lives. This course is structured to help you build a positive self image — a self image that will give you the confidence and drive you need to do your best.

Good performance will result when you have all the circles (the three mental processes) in balance and working together. Now let's take a look at how the three circles will probably be relating as you start through this course.

"The Beginner"

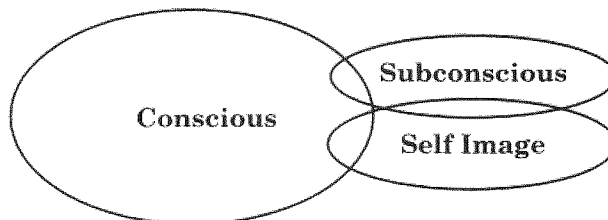

In the beginning, your conscious mind will have to be doing nearly all the work and your subconscious and self image will be underdeveloped. How can you build up your subconscious? There are many steps you can take but for now all you need to be concerned about is one: practice. Practice where you take care to apply the new skill or technique just as it is being taught.

How do you build up the self image? You can start by doing your homework and coming to class prepared. You can also find time for extra practice of the new skills you are learning. These are habits you will be forming that can take you a long way toward being a champion.

This just about wraps up my introduction to mental training; but throughout the text, I will be offering suggestions to help you build your mental circles. They will look like this:

... tips by Bassham

Tips for building your self image.

Expect to do well! Focus on the positive.
When you do something well (like firing a good shot or a good group), say to yourself, "That is like me!"

CHAPTER VIII

Prone Position

Now we move from the standing, the least stable position, to prone, the steadiest of all positions. In the prone position, both the elbows and nearly the entire body are placed in contact the ground, thus providing a large area of support. In

addition, a sling is used to transfer the weight of the rifle from your muscles to your bones; this will provide even more stability. Before dealing with the specifics of the prone position, we must first learn to get into the sling and how to adjust it.

Getting into and Using the Web Sling

To put the sling on you arm, take the following steps.

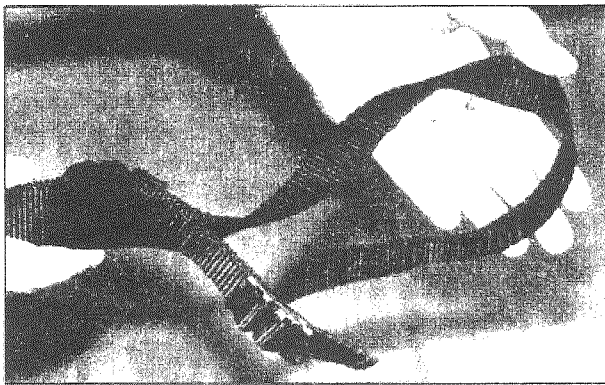

- Open the arm loop wide enough to get it over your upper arm.

- Slip your arm into the loop. If you are shooting right handed and the butt stock is going to rest on your right shoulder, the sling will go on your left arm. The metal keeper should be on the outside of your arm (not on the inside toward the body) with the rounded end pointing to the rear.

- Place the arm loop on your upper arm above the biceps near the shoulder. This will minimize pulse effect and give the best support.

- Tighten the Arm Loop only until it is snug enough to remain in place on your arm. It should never be so tight that it restricts the flow of blood in your arm.



A diaper pin may be used to keep the sling from slipping down on the arm.

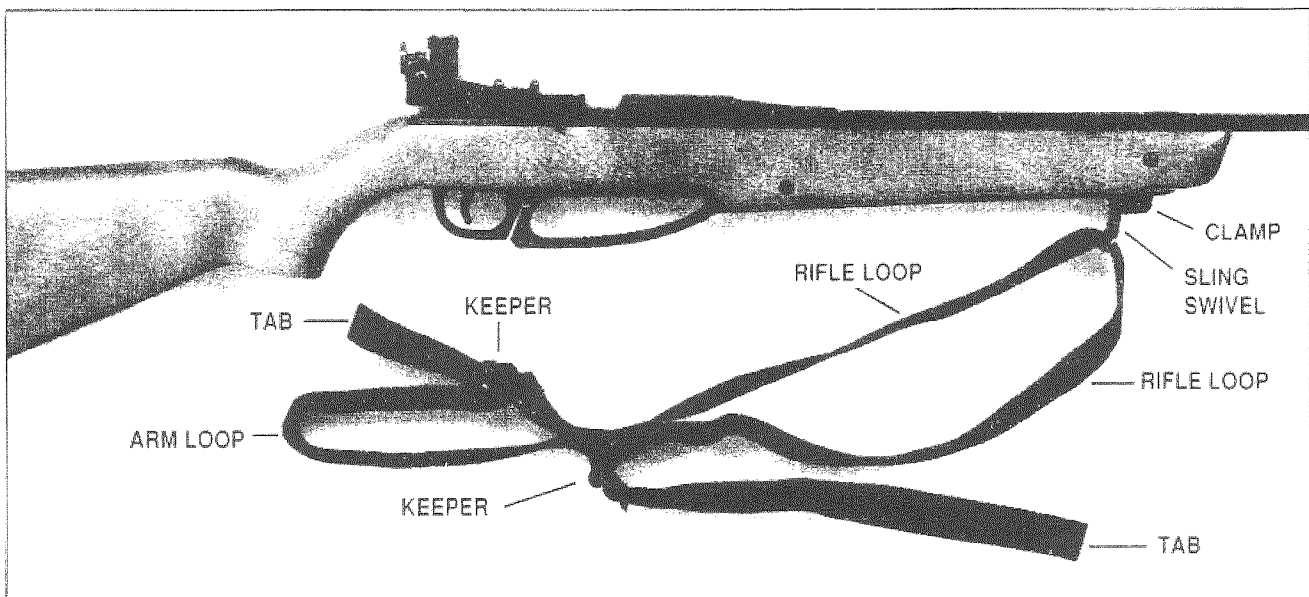

Attaching the Sling to the Rifle.

The sling is attached to the rifle by a detachable sling swivel which connects to a clamp on the forward end of the pump handle. To attach the sling, open the keeper on the sling swivel and take the following steps:

- Hold the rifle with your trigger hand and extend the sling straight forward from your arm without any twist in the sling.

- Twist the sling one half turn clockwise (counterclockwise if shooting from the left shoulder).

- Insert the pin of the sling swivel into the attachment clamp on the rifle and close the keeper over the pin.

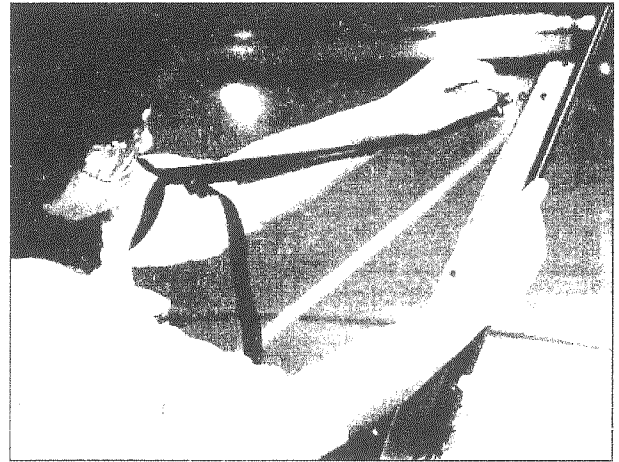
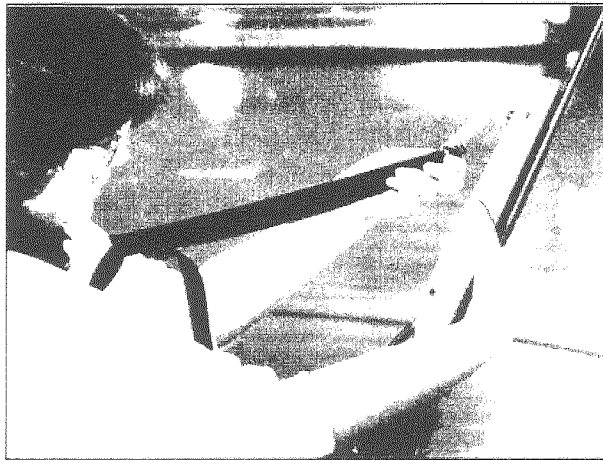

Adjusting the Sling.



Shortening The Sling To shorten the sling, simply pull on the tab end of the rifle loop.

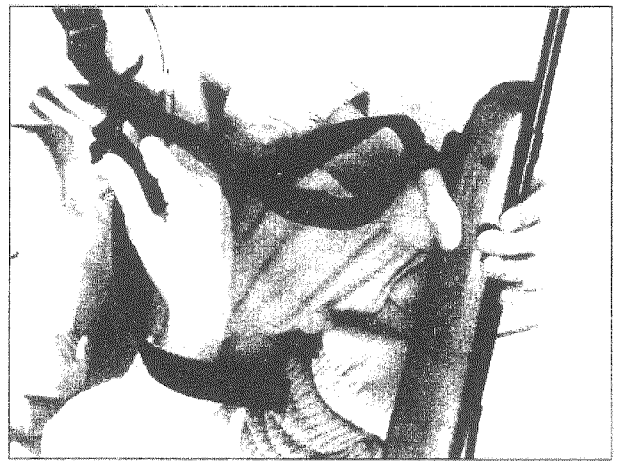

Lengthening the Sling. To lengthen the sling, grab the inner loop of the sling near the keeper, and push on the rounded end of the keeper with your thumb as you pull on the inner loop. You will be able to pull about an inch of webbing through the keeper at a time.

Getting into the sling will seem a bit awkward at first, but with a little practice you will be adjusting it with speed and precision.

Learning the Prone Position

Now we can move on to learn the key elements of the prone position which will be illustrated in photos followed by descriptive narrative.



1. The body is behind the rifle at an angle of 10 to 20 degrees from the line of fire.

2. The left leg is straight with the toe pointed inward or straight back (never to the outside as this creates tension). If you stand directly over the shooter, you should be able to run a straight line from the left hand, through the left arm, left side and left leg.

3. The right leg is drawn up slightly and bent at the knee. This takes some weight off the chest and diaphragm for easier breathing. The right leg below the knee is roughly parallel with the left leg. The right toe points outward.



4. The left elbow should be about one hand width to the left of directly under the rifle.

5. The head is as erect as possible with the cheek resting firmly on the stock. The head may tip forward slightly but should not tip to either side.

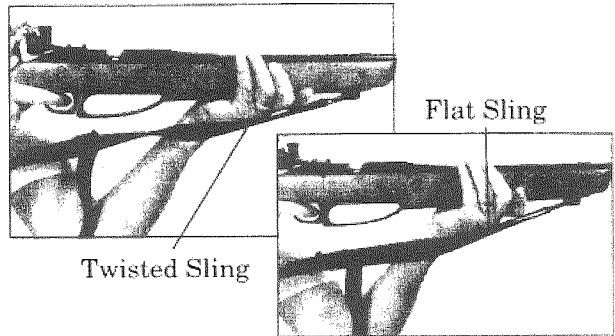

6. The left arm should be relaxed with the sling supporting the weight of the rifle. The sling should be flat (not twisted) as it runs over the back of the hand and wrist.

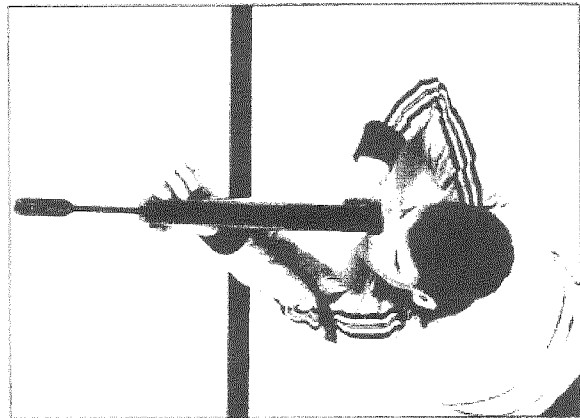

7. The forearm stock rests in the small depression in the palm of the left hand. The fingers and thumb are completely relaxed and do not grip the rifle.

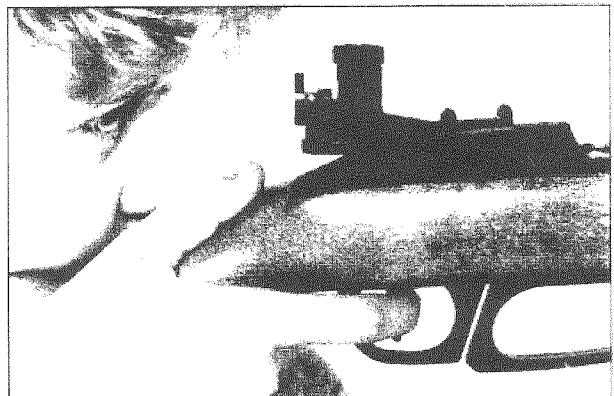

8. The trigger finger is placed so that it does not touch anything except the trigger. If it "drags wood," the friction will disturb you aim and ability to smoothly pull the trigger. By placing the thumb along the top of the stock rather than across it, the trigger finger pressure can be applied straight to the rear more easily.

Natural Point of Aim

The goal in the prone position is to be able to relax almost completely and let bone and the sling support your position. Once you have achieved that, you may not be pointing at the target. If you have to use muscle to force the gun in any direction to bring it to bear on the target, you are defeating your position. Therefore you must move your entire body, as though it were a statue, to bring the gun into position on the target. Use the following procedure to achieve natural point of aim in prone:

- First build your position with general reference to the target. Only bone and sling should be supporting your position.

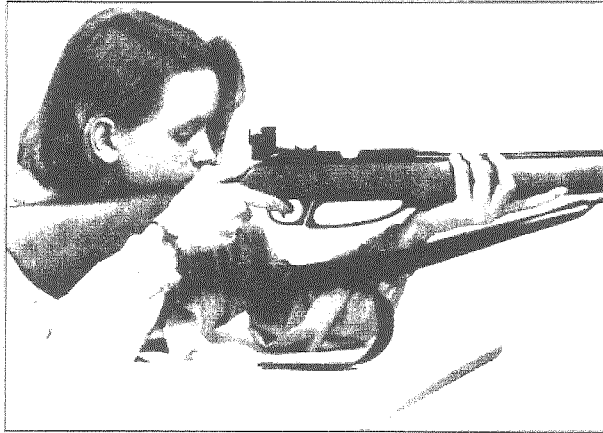

- Look through your sights, then look down and away from your sights without moving your head. Relax, let your position settle. Then look back through your sights and determine if your front sight needs to move right or left to come to bear on the target.

- Now you are going to move your body without altering your position. Using the left elbow as a pivot point, shift your body in the opposite direction that you want to move the front sight.

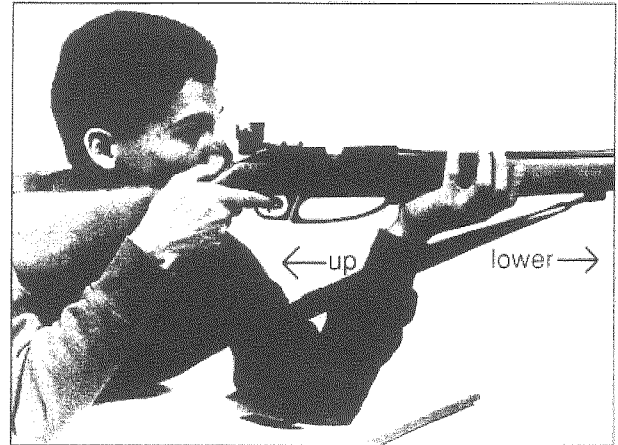

- Repeat the above steps incrementally until your sights are on a vertical line with the target.

- Getting the elevation you need is a simple matter of moving your left hand forward on the stock to lower the front sights or moving it back to raise the front sights.

- After each adjustment, use the technique of looking through your sights, looking away and relaxing, and then looking back through your sights to find your natural point of aim. Continue making small incremental adjustments in your position to bring your sights to bear on the target.

The ultimate in natural point of aim and relaxed support would be to be able to fall asleep in your position and then to wake up and find yourself still on the target. We are still looking for the shooter who can do this!

Charging Your Rifle

Pumping in Prone. To charge the air rifle from the prone position, roll onto your left shoulder and upper arm. Use the most natural/comfortable of the two following methods.

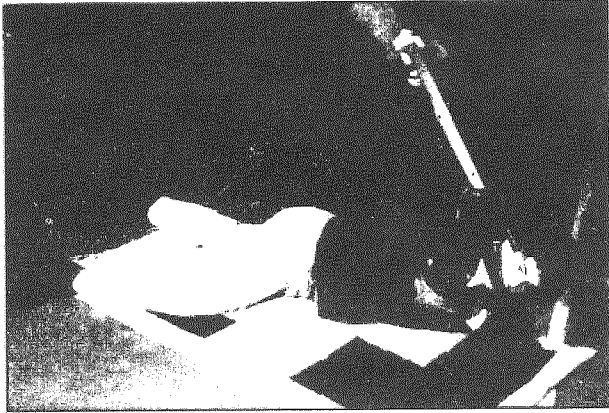

Grasp the pistol grip as shown and extend pump handle by lifting the rifle.

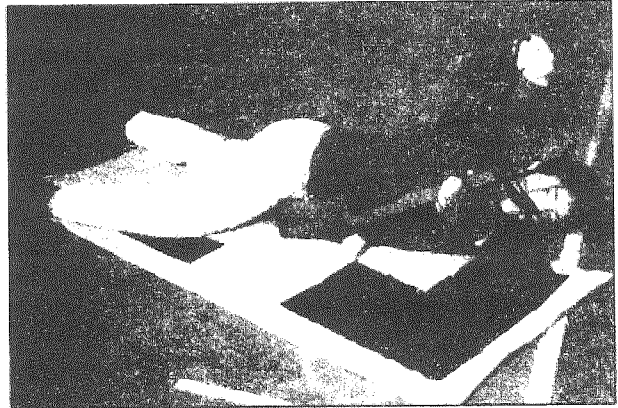

Turn the rifle over, keep rear sights off the floor, hold the stock down with your right leg and lift the pump handle.

. . . tips by Bassham

Don't neglect standing. You are learning the prone position and with the introduction of the sling, it will take a little longer to get all the wrinkles ironed out. As you work on the new position, don't forget about standing. It is your most important position. It is where most matches are won or lost. It is the easiest position to learn and the hardest to master. In any given week, fully 50% of your training time should be spent on the standing position.

CHAPTER IX

Sight Adjustment and Scoring

Up to this point, we have been emphasizing the importance of firing the smallest possible group without worrying about where the group is on your target. Now that you are grouping well, it is time to learn how adjust your sights so that the center of your shot group will be in the center of the target. Done correctly, this will also result in the highest possible score for your shots.

Sight Adjustment. Let's start by learning how the rear sight operates; it has two knobs which

are used to move the point of impact for an aimed shot. The **elevation** knob (on top) moves the shot up or down on the target. The **windage** knob (on the right side) moves the shot to the left or right. The adjustment of the knobs is measured in clicks which can be felt as the knob is turned. It takes six clicks to move the strike of the pellet the width of one scoring ring on the Air Rifle Tyro Target we are using.

Daisy 853/953 Sight Adjustment

Looking down on the sights from above, this is what you will see:

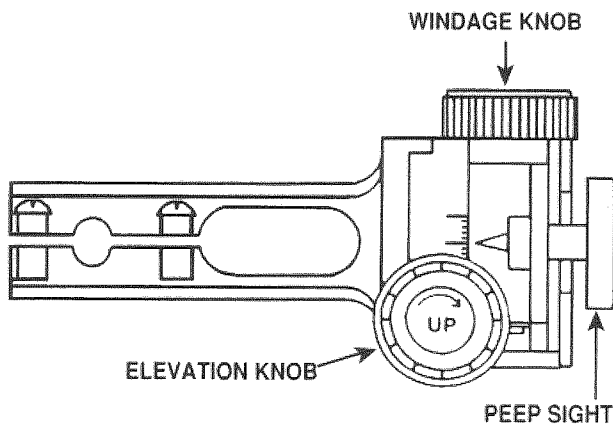

The table below shows the direction that the Daisy sight knobs must be turned to move the shot group.

	<u>Clockwise</u>	<u>Counter Clockwise</u>
Elevation Knob	Up	Down
Windage Knob	Right	Left

There are raised arrows with white paint on the sight knobs indicating the direction to move the sights up for elevation and right for windage. Unfortunately, with heavy usage, these arrows rub off. You should memorize **“Up and right - clockwise/down and left - counter clockwise.”**

Sight adjustment is a four-step process:

- Fire a three-shot group.
- Mark the center point of the shot group.
- Calculate how many clicks of windage and elevation are needed to move the center point of the group to the center of the target.
- Make the needed sight adjustment.

Lets use the three-shot group illustrated below to demonstrate the sight adjustment calculation.

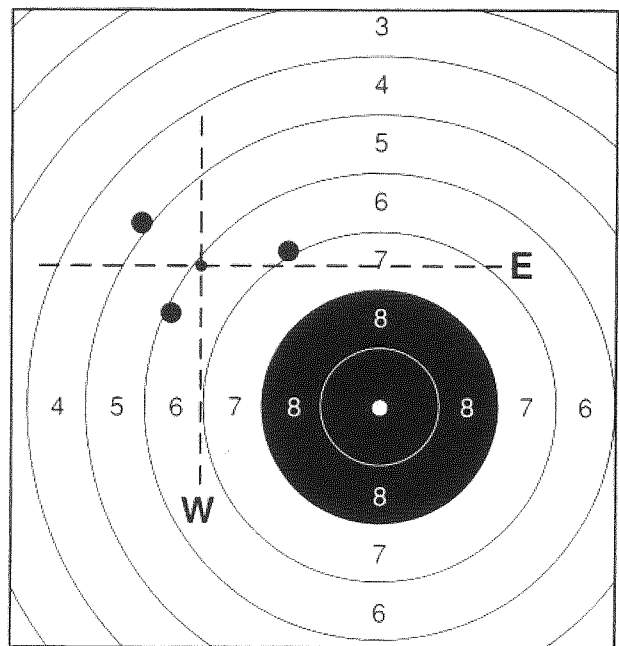

A small dot has been placed in the approximate center of the shot group. A dashed horizontal line has been drawn through the dot with an “E” at one end to use for the elevation calculation. A dashed horizontal line has been drawn through the dot

with a "W" at one end to calculate windage.

Elevation. The line in the illustration is 2 1/2 rings too high. Using six clicks per scoring ring (2.5 rings X 6 clicks per ring = 15), we find that we have to come down 15 clicks. That will require a counter-clockwise turn of the elevation knob.

Windage. The line in the illustration is 3 rings to the left of center. Using our formula (3 rings X 6 clicks per ring = 18), we find that we have to come right 18 clicks. That will require a clockwise turn of the windage knob.

Be bold in moving your sights. Think of it as better to move the sights a little too far than not far enough. If possible, you should try to fire a second three-shot group to check your sight adjustment.

There are many things that can affect your aim and result in subtle movements of your shot-group center. Changes in light conditions, your firing position, eye relief, even your degree of tension or relaxation can all impact on your shot group.

If you are firing for record, don't ignore changes in your shot group. Make sight adjustments as they are needed based on at least three shots.

Backlash

This is a problem inherent in most inexpensive sights. Backlash occurs when you change the direction of movement (or adjustment) of your sights and the sight does not immediately respond in the new direction.

The sights on the Daisy 853/953 may have from one to three clicks of backlash. When you change the direction of movement (i.e., you have been moving your sights to the left and you start moving

back to the right), you must add the number of clicks needed to compensate for the backlash in your sights.

Since it may be different in each set of sights, you will have to determine the backlash on the rifle you are using. This can be done visually by observing the calibration scale when you change direction. In the beginning all you really need to do is add two clicks when you change direction.

Scoring

Beginning shooters are usually over-anxious to start scoring their targets. Their full concentration should be on learning and applying the fundamentals with their success being measured by group size rather than score. Shooters who start the qualification program spelled out in Chapter XI will find that for the Tyro Skill Level, group size and ability to make sight adjustments are more important than score. From this point on, your coach may ask you to score a target as a learning exercise but don't get too excited if your score is high or low in relation to the other shooters.

Scores are used to measure performance. They determine who wins. More importantly, once a shooter has mastered the fundamentals, they provide a means of tracking progress in skill development. The criteria applied in scoring a target must be the same today as next year if scores are to be fairly compared.

Scoring calls for a precise set of rules and the application of honest judgement where the calls are close. In competitions a match official will score your target. As a beginning shooter, you will usually do the initial scoring of your own target and then your coach will check your work. This speeds up scoring and quickly lets the shooter know the results.

The basic rule of scoring are illustrated in the following targets.

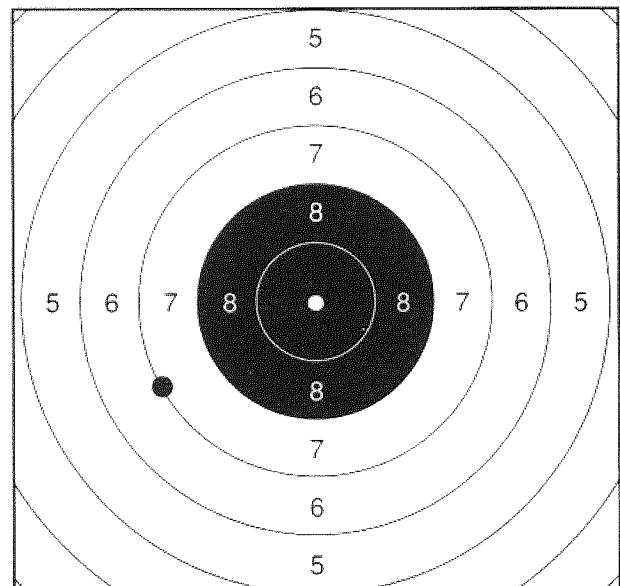

A shot which straddles two scoring rings is assigned the value of the higher ring. The shot illustrated above is scored as a seven.

NOTE: The dot in the center of the bull is the "10 ring."

A shot which cuts the outside line of a higher ring will be awarded the point value of the higher ring. This is an easy call if it actually cuts into the line as shown below.

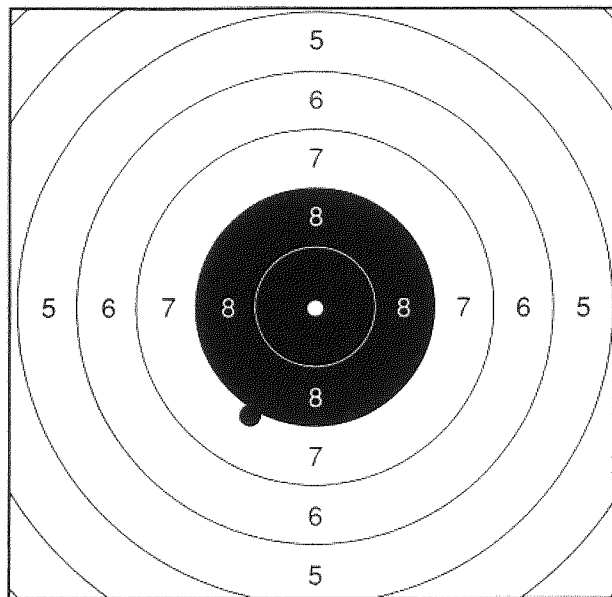

This shot would be an eight.

It is much more difficult to call a shot which merely touched the line because the paper has a tendency to leave a slightly smaller hole than the actual size of the pellet. In this situation you must make your call using your own best judgement and leave the final decision to the individual who verifies the scoring of your target.

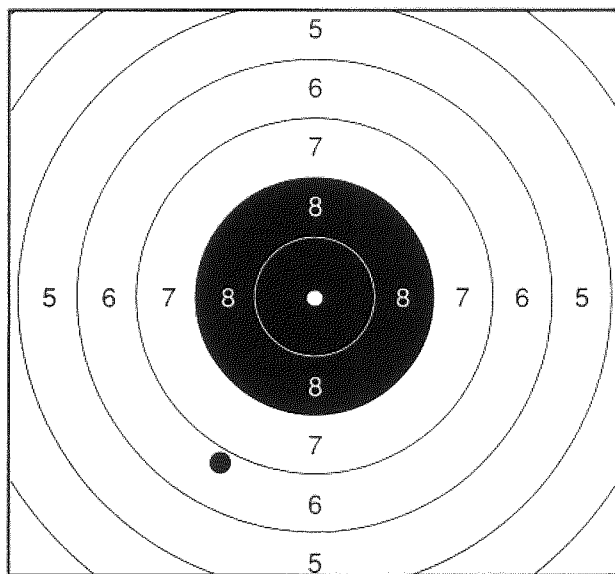

This shot would be a seven when plugged.

The above shot barely touches the line and scores a seven after it has been plugged. **Shooters may never plug their own shots.**

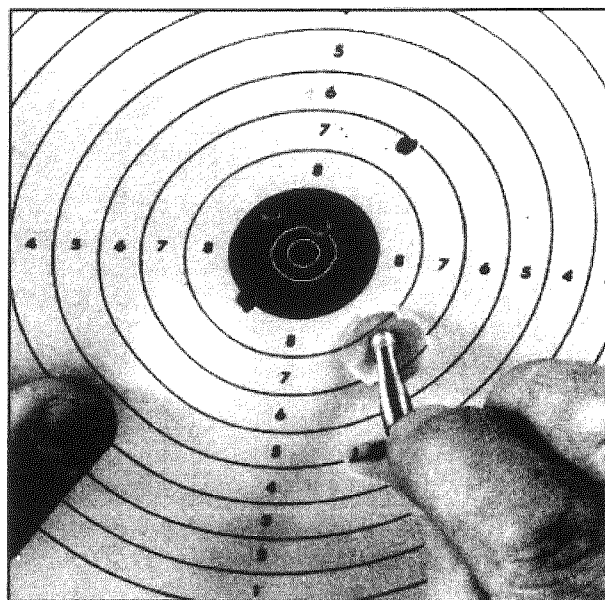

Plug. The person verifying your scoring may use a plug on close or questionable calls. This is piece of metal with a flange that is exactly .177 caliber. When placed in a shot hole, the value of the shot can be more easily determined.

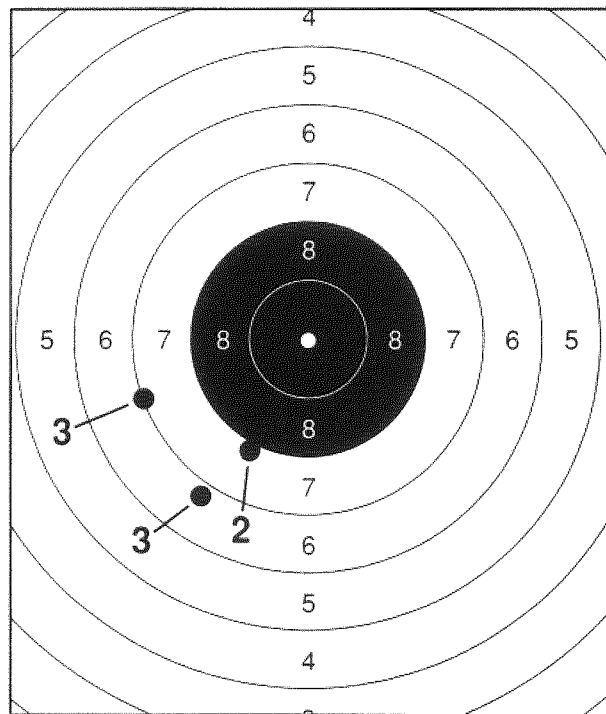

Lost Points Scoring Method. It is generally much faster to add up points lost on each shot rather than the total score. The target above shows the three examples we have just called — two “7’s” and an “8.” Using the lost points scoring method, they would be two “3’s” and a “2”. The target above shows how they should be marked using the Lost Points Method.

Name Brad Anybody
 Position (circle one): P S **K**
 Date May 21

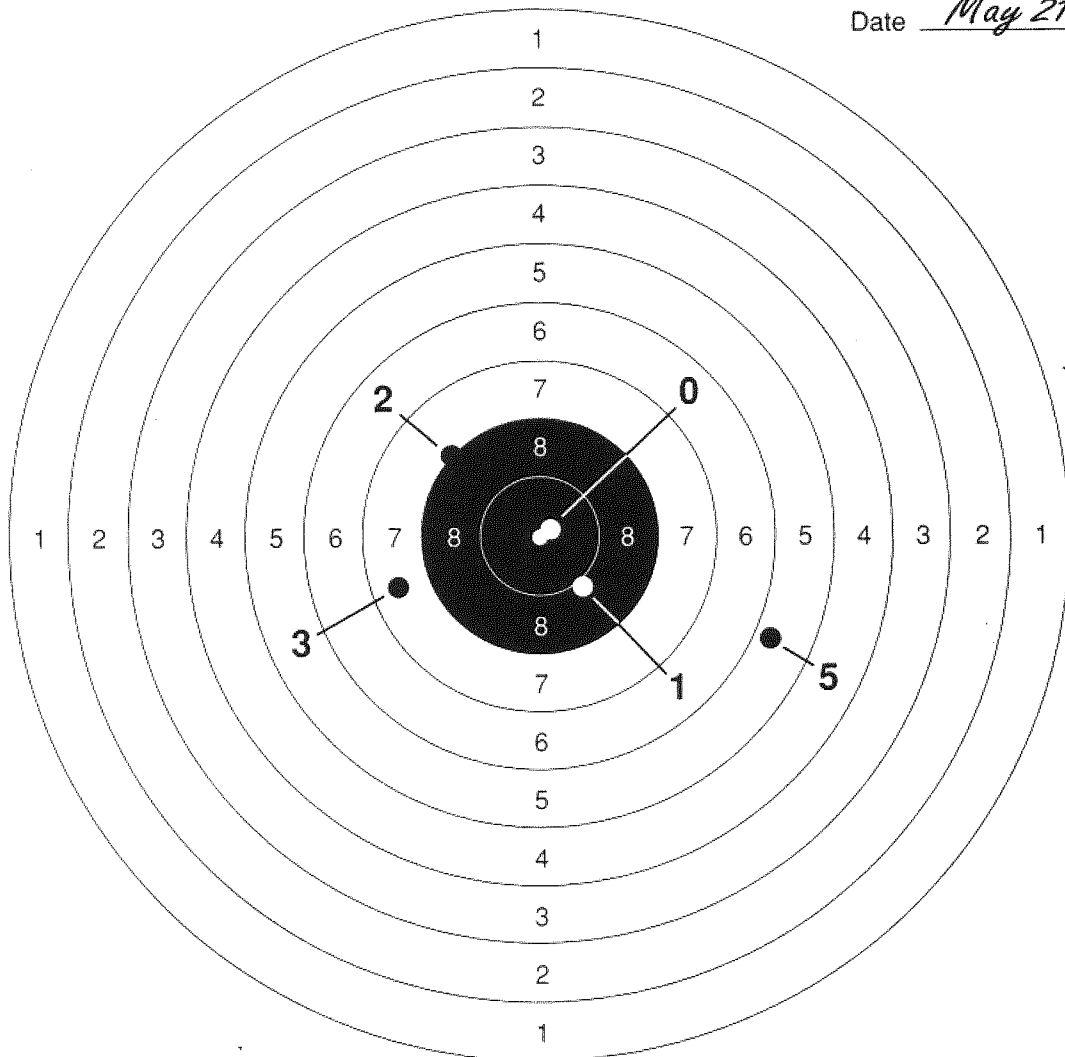

2
0
3
5
1

11
50

-11

39

Air Rifle Tyro Target

USA Shooting

Scoring a Five Shot Target. When you have determined the lost points value (points lost from a maximum value of 10) for a shot, draw a short line radiating out from the shot hole with the number showing the points lost at the end of the line. Do not touch the shot hole with your pen or pencil or in any other way disturb the shot hole. For your total score, add up the lost points and subtract from 50 (for a five shot target). In the example above, we calculate the total score as follows: 50 points possible less 11 points lost = a total score of 39 points. We have done the math on the target but, you will quickly learn to do it in your head. Note that the 10 ring is the small dot in the middle.

... tips by Bassham

Positive thinking. Don't dwell on what you do wrong, don't tell the other shooters how you fired a bad shot, and don't listen to their stories about bad shots. If you have a bad shot, forget about it. Concentrate on your good shots and how you got them.

If you are having difficulty, think of it as a challenge and look for solutions.

CHAPTER X

Kneeling Position

The kneeling position has a smaller area of support than prone and a higher center of gravity; as a result, balance is very important. With practice, kneeling can become a very steady position for you. The key is getting into a solid position and then developing your ability to maintain it.

The critical elements of the kneeling position are listed below. They should be used by both the shooter and the coaching partner when evaluating the position.



1. Right foot and kneeling roll support most of the body weight.

2. Shoulders slump (relax) forward.

3. The back of the left elbow rests on the left knee (or forward of the knee). Most shooters will find they have a flat spot on the back of the arm just above the elbow that will fit against a flat portion of the knee cap.

4. The sling should be high on the left arm above the biceps. The length of the sling should be adjusted until the weight of the rifle is entirely supported by sling and bone.

5. Head is tilted forward slightly with eyes level.

6. The right hand gently grasps the pistol grip and the thumb rests along the top of the stock. The right arm is relaxed.

7. The left shin is vertical when viewed from the front and the left forearm should form a straight line with the lower left leg.



8. The two legs form a 25 to 35 degree angle with each other. If they are nearly parallel, balance can't be maintained.

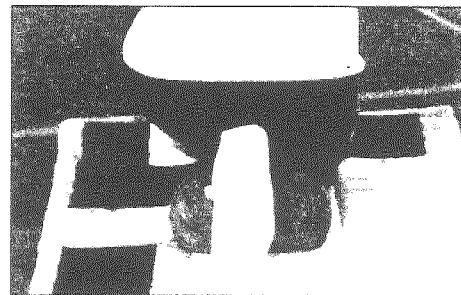

9. The tailbone of the shooter is centered over the heel of the right foot. The right foot is nearly vertical with the toes stretched out and relaxed (rather than curled under in a starter stance).

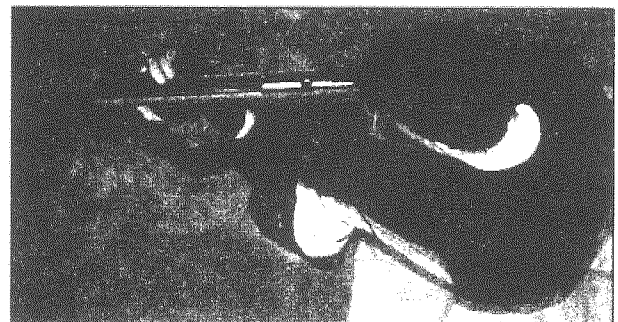

10. Looking from above, the rifle, shoulders and left arm form a triangle of support.

Natural Point of Aim

When you get into the kneeling position, you will be facing 25 to 30 degrees to the right of your target and actually firing somewhat across your position. Once you have achieved a position which provides the most support and the steadiest hold, you may not be pointing at your target. Use the following steps to achieve natural point of aim.

- You have built your position with only general reference to the target. To the degree possible, bone and sling (rather than muscle) support your position.

- Look through your sights, then look down and away and relax (let your position settle). Then look back through your sights and determine if you need to move right or left to come to bear on the target.

- Using your kneeling roll as a pivot point, move your front knee and foot in the direction that

you want your front sight to move. Think of your body as a statue that you are turning slightly to properly aim the rifle.

- Repeat the above steps incrementally until you have the proper lateral relation to the target.

- Getting the proper elevation is again a matter of moving your supporting hand on the forearm of the stock: forward to lower and back to raise the front sights. This may not provide enough adjustment depending on your body configurations and position. Placing the toe of the stock higher in the shoulder will lower the front sight. You can also slide the front foot forward to lower the front sight but this may impact on balance and hold.

Finding the best kneeling position is a series of tradeoffs that will often require considerable experimentation until your optimum hold is achieved.

... tips by Bassham

Rhythm. Learn to be efficient with your time as you prepare for and fire a shot. Some shooters take so long getting ready to fire a shot, that they are exhausted by the time they get around to it. Others will hang on so long trying to fire the perfect shot that they suffer oxygen depletion by the time the shot breaks. You should work for the shot firing sequence with no wasted motion. Develop a rhythm or cadence that keeps you moving. While things are going well, keep moving forward.

This will not come overnight for the new shooter but it is what you should be striving for.

CHAPTER XI

Building and Testing Your Skills

You can't expect to remember and be able to apply everything you have read or studied the first time through the *Student Handbook*. It should be reviewed periodically until you are ready for more advanced material.

If you are using the text as part of a Position Air Rifle Course, you will soon be taking a final exam and shooting a three-position course for record. Your exam grade and fired scores will measure how much you know and how well you can shoot at just one point in time. They give you a benchmark to measure the development of your skills.

If you don't use your shooting skills, they will waste away. Progress, however, will depend upon putting your knowledge and skills to work. Here are some action steps you can take to accelerate your skill development.

Practice. Every sport requires practice and training. Practice allows you to try new techniques and to work out problems. With air guns you are able to practice many places that might not be safe for a firearm. Air guns are also quiet so you can shoot without disturbing others. An important type of practice that is unique to shooting is "dry fire." In dry fire the shooter carefully goes through all the steps of shooting, but the gun is never loaded. This means you can dry fire anywhere—even in front of the TV.

Competition. At least once a month and more often if possible, you should fire in a match against other shooters. This helps you develop the nerves and mental discipline required to be a competitive shooter. It also gives you a new benchmark by which you can measure your progress.

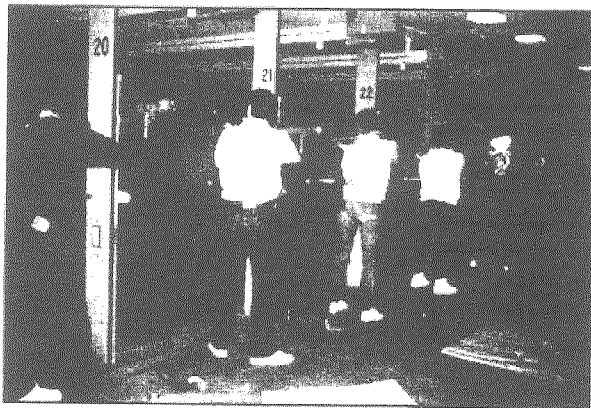

National Guard Junior Air Rifle Championship at the U.S. Military Academy range at West Point.

If you can't get to a "shoulder to shoulder" match, there are postal matches in which you can fire your targets at home and send them off to be scored. It takes longer to get the results but it allows individuals to test their skill against shooters in other parts of the country without leaving home.

Keep Records. By recording your scores, you can measure your improvement and determine what positions need the most practice. Beginning



Margaret Schoap awards a gold medal at the Daisy Airgun Championships.

shooters should expect rather wide swings up and down in their day-to-day scores but the average trend will be upward if you train properly.

Get Your Own Equipment. If you are to practice and compete when and where you want, you need to have your own equipment. The inside of the back cover lists sources for equipment and shooting supplies.

Join an Organized Shooting Club. Pick any sport—individual or team—and you will find that the athletes of that sport form themselves into some sort of club or organization. Why? It is pretty hard to be a team or host a competitive event all by yourself. You need the encouragement and support that you can get from other athletes who are working to overcome some of the same challenges you are, or who are working toward the same goals. Shooting is a sport where you need the help of other shooters. It is also true that trying to teach what you know about shooting to another less skilled shooter will help you understand it better.

Enroll in a Qualification Program. The most effective way for a beginning shooter to chart his or her own progress is to enroll in a self-

paced qualification awards program. There are several available to choose from but we feel that the most effective for entry level shooters using the Daisy Model 853/953 air rifles is the **Jr. Shooting Sports USA Skill Awards Program** developed to complement the Position Air Rifle Course. The initial recognition award (the central patch) is presented after the shooter has demonstrated a solid understanding of the safety rules and an ability to consistently fire three shot groups. The first award is within reach of any

youth willing to learn and apply the fundamentals but the performance standards become more demanding as a shooter progresses up the skill ladder. Only exceptional shooters who have worked diligently to perfect their shooting skill and then refined it in competition will be able to achieve the highest rating of Medalist. The five awards in the order that they must be earned are the Initial Recognition Award (for Safety and Basic Skills) followed by Tyro, Challenger, Advanced, and Medalist.



...tips by Bassham

Goal Setting. What is the difference between a wish and a goal? In both cases you want something. With a wish, that is all there is - just a wish. To have a goal, you must devise a plan for achieving your goal. Now that you are about graduate from this course, it is a good time to think about setting some goals for yourself. Goals should be out of reach (take some time and effort) but not out of sight. The prospect of reaching them should excite you or you won't be motivated to work for them.

The goal setting process is quite simple and you can use it all areas of your life. The steps in the process are listed below. Writing out your answers to each step will greatly increase your probability of achieving your goal.

- Define the Goal. Be specific ("I want to average 90/100 in standing" rather than vague ("I want to improve my standing scores.").
- When do you want it?
- List the pay value (your reasons wanting it).
- Develop your plan to reach it
- Is the prize worth the price?

If no, change the goal.

If yes, schedule the resources (your time, money, and help from other people such as a coach) needed to achieve it.

Once you have completed your goal setting plan, show it to the people who can help you (parents, friends, teachers, coaches) and post it where you can read it every day; this will help you stay focused on your goal.

One last thought. It has been said that "You should write your goals in concrete and your plans in sand!" The point is don't be afraid to change your plan if you can improve it.

Position Air Rifle Progress Record

JR. SHOOTING SPORTS USA SKILL AWARDS

Please Print

SHOOTER'S NAME _____ HOME PHONE _____
first mi last

ADDRESS _____ BIRTHDATE ____/____/____ AGE ____
number & street mo day yr

city state ZIP GRADE IN SCHOOL _____

To be determined by coach: Hand: ____ Eye: ____ Shoot: ____

----- award requirements and progress record follow -----

INITIAL RECOGNITION AWARD

- Pass verbal or written test on the general safety rule and the four range safety rules.
- Properly follow safety rules on the range during training, instruction and practice (duration determined by coach).
- Fire four groups (three shots per group) from the standing position that can be completely covered by a two inch circle.

Groups Fired:

Date _____ Date _____

Date _____ Date _____

Award Presented: _____
date

By _____
signature

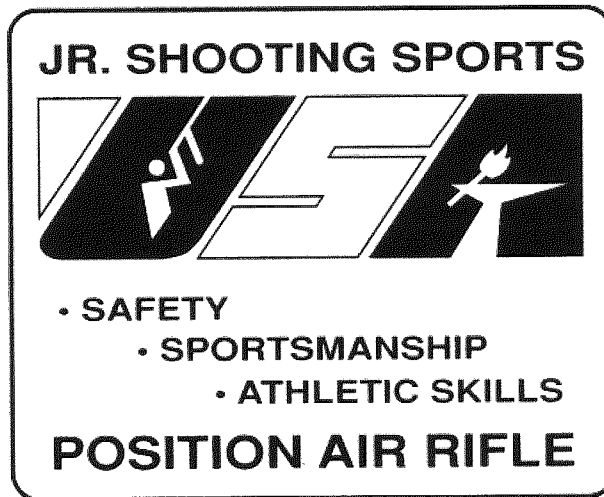
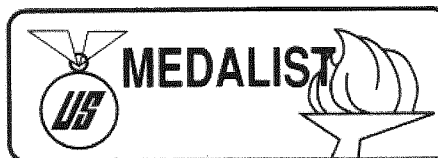

TYRO

CHALLENGER

ADVANCED

TYRO

STANDING:

Level One: Fire four Tyro Air Rifle Targets from the standing position, five shots on each target. To qualify a target, all five shots must be completely **within the six ring**.

<input type="text"/>	_____	<input type="text"/>	_____	<input type="text"/>	_____	<input type="text"/>	_____
SCORE	DATE	SCORE	DATE	SCORE	DATE	SCORE	DATE

Level Two: Fire four Tyro Air Rifle Targets from the standing position, five shots on each target. To qualify a target, all five shots must score as a **seven** or better, each shot must be scored correctly by the shooter, and the math must be correct.

<input type="text"/>	_____	<input type="text"/>	_____	<input type="text"/>	_____	<input type="text"/>	_____
SCORE	DATE	SCORE	DATE	SCORE	DATE	SCORE	DATE

PRONE:

Level One: Fire four Tyro Air Rifle Targets from the prone position, five shots on each target. To qualify a target, all five shots must be completely **within the eight ring**.

<input type="text"/>	_____	<input type="text"/>	_____	<input type="text"/>	_____	<input type="text"/>	_____
SCORE	DATE	SCORE	DATE	SCORE	DATE	SCORE	DATE

Level Two: Fire four Tyro Air Rifle Targets from the prone position, five shots on each target. To qualify a target, all five shots must score as a **nine** or better, each shot must be scored correctly by the shooter, and the math must be correct.

<input type="text"/>	_____	<input type="text"/>	_____	<input type="text"/>	_____	<input type="text"/>	_____
SCORE	DATE	SCORE	DATE	SCORE	DATE	SCORE	DATE

KNEELING:

Level One: Fire four Tyro Air Rifle Targets from the kneeling position, five shots on each target. To qualify a target, all five shots must be completely **within the seven ring**.

<input type="text"/>	_____	<input type="text"/>	_____	<input type="text"/>	_____	<input type="text"/>	_____
SCORE	DATE	SCORE	DATE	SCORE	DATE	SCORE	DATE

Level Two: Fire four Tyro Air Rifle Targets from the kneeling position, five shots on each target. To qualify a target, all five shots must score as an **eight** or better, each shot must be scored correctly by the shooter, and the math must be correct.

<input type="text"/>	_____	<input type="text"/>	_____	<input type="text"/>	_____	<input type="text"/>	_____
SCORE	DATE	SCORE	DATE	SCORE	DATE	SCORE	DATE

The Tyro Award is presented when all of the position requirements have been satisfied.

Tyro Award presented _____ date _____ By _____ signature _____

NOTE: Score is not a determinant at this level but it is recorded to track progress. The main emphasis is on reducing group size, making sight adjustments, learning to determine the value of a shot, and scoring a target correctly.

CHALLENGER

PRONE: Fire five AR 5/5 Targets from the prone position. There should be two shots in each of the five bulls on the target. To qualify a target, the minimum score is **80 out of 100 possible**, each shot must be scored correctly by the shooter, and the math must be correct.

<input type="text"/>	_____	<input type="text"/>	_____	<input type="text"/>	_____	<input type="text"/>	_____	<input type="text"/>	_____
SCORE	DATE	SCORE	DATE	SCORE	DATE	SCORE	DATE	SCORE	DATE

STANDING: Fire five AR 5/5 Targets from the standing position. There should be two shots in each of the five bulls on the target. To qualify a target, the minimum score is **55 out of 100 possible**, each shot must be scored correctly by the shooter, and the math must be correct.

<input type="text"/>	_____	<input type="text"/>	_____	<input type="text"/>	_____	<input type="text"/>	_____	<input type="text"/>	_____
SCORE	DATE	SCORE	DATE	SCORE	DATE	SCORE	DATE	SCORE	DATE

KNEELING: Fire five AR 5/5 Targets from the kneeling position. There should be two shots in each of the five bulls on the target. To qualify a target, the minimum score is **70 out of 100 possible**, each shot must be scored correctly by the shooter, and the math must be correct.

<input type="text"/>	_____	<input type="text"/>	_____	<input type="text"/>	_____	<input type="text"/>	_____	<input type="text"/>	_____
SCORE	DATE	SCORE	DATE	SCORE	DATE	SCORE	DATE	SCORE	DATE

The Challenger Award is presented when all of the position requirements have been satisfied.

Challenger Award presented _____ By _____
date signature

ADVANCED

ADVANCED I: Five 3P courses must be fired with minimum scores of **220 out of 300** possible on the AR 5/5 or the AR 5/10 Air Rifle Targets. Each 3P course of fire must be fired at the same event or practice session.

<input type="text"/>	_____	<input type="text"/>	_____	<input type="text"/>	_____	<input type="text"/>	_____	<input type="text"/>	_____
SCORE	DATE	SCORE	DATE	SCORE	DATE	SCORE	DATE	SCORE	DATE

ADVANCED II: Five 3P courses must be fired with minimum scores of **235 out of 300** possible on the AR 5/5 or the AR 5/10 air rifle targets. Each 3P course of fire must be fired at the same event or practice session.

<input type="text"/>	_____	<input type="text"/>	_____	<input type="text"/>	_____	<input type="text"/>	_____	<input type="text"/>	_____
SCORE	DATE	SCORE	DATE	SCORE	DATE	SCORE	DATE	SCORE	DATE

The Advanced Award is presented when all the requirements of Advanced I and Advanced II have been completed.

Advanced Award presented _____ By _____
date signature

Shooting Equipment and Supplies

Beeman Precision Airguns
5482 Argosy Drive
Huntington Beach, CA 92649
800/227-2744

POC: Don Walker. Feinwerkbau (FWB) air rifles and pistols, accessories, and air gun supplies. Complete line of pellets. Send for catalog.

Daisy Manufacturing Company, Inc.
PO Box 220
Rogers, AR 72757-0220
800/643-3458

POC: Special Market Programs Office. Moderately priced air rifles and pistols, accessories, targets and traps. Send for price list.

Accuracy International
PO Box 2019
Bozeman, MT 59715
406/587-7922

POC: Jack Foster. Complete line of competitive shooting equipment and supplies. Send for catalog.

Champion's Choice
201 International Boulevard
LaVerne, TN 37086
615/793-4066

Competitive shooting supplies. Complete line of shooting apparel (coats, mats & gloves). All air gun equipment. Exclusive agent for Walther. Send for catalog.

Neal Johnson's Gunsmithing, Inc.
208-B West Buchanan Street
Colorado Springs, CO 80907
719/632-3795

Competitive shooting equipment & supplies. National Anschutz Service Center. Fiberglass stocks & custom gun work on target rifles. Supplies & equipment to officiate international competition. Send for catalog.

Speedwell Targets
136 Lincoln Road
Middlesex, NJ 08846
800/243-8274

POC: Mike Panos. Complete line of paper targets. Send for Junior Program Price List.

Advanced Shooting References

Shooting for Gold (Rifle)
by Bill Krilling

Cost: \$12 including shipping. To order, send check and your mailing address to Bill Krilling, 6622 Trapper Way, Midland, GA 31820.

RESOURCES

Program Assistance

Jr. Shooting Sports USA
PO Box 3207
Brentwood, TN 37024-3207
615/831-0485

POC: Leo Lujan. Training material, qualification/skill awards, quarterly newsletter for junior coaches, and shooting program support. Call for personalized assistance.

The American Legion Junior S/S Program
PO Box 1055
Indianapolis, IN 46206
317/630-1210

POC: Mike Buss. Training material and The American Legion Junior Air Rifle Tournament.
<http://www.legion.org>

National Rifle Association
11250 Waples Mill Road
Fairfax, VA 22030
703/267-1473

POC: Margaret Schoap. Training material, qualification awards, and competitive programs.

USA Shooting
One Olympic Plaza
Colorado Springs, CO 80909
719/578-4882

POC: Randy Moeller. Competition and advanced training opportunities. Sanction tournaments for international disciplines. Individual and junior club memberships.

National Guard Marksmanship Center
Camp Robinson
North Little Rock, AR 72118-2200
501/212-4534

POC: Lt Col Bob Baker. Junior Air Rifle Tournament and advanced training opportunities.

Continued on Inside Back Cover

GUN SAFETY RULES TO LIVE BY

- Treat every gun as if it were loaded and ready to shoot.
- Never carry a gun into your home, camp or public place loaded or cocked.
- Always be sure your gun barrel is clean and not plugged.
- Carry your gun so you can control the direction of the muzzle, even if you stumble.
- Be sure of your target before you pull the trigger.
- Never point a gun at anything you do not want to shoot.
- Guns not being used should always be unloaded.
- Never climb a tree or fence or jump a ditch with a loaded gun.
- Never shoot at a flat, hard surface or the surface of water.
- Respect other people's property.