

PRODUCT DATA SHEET

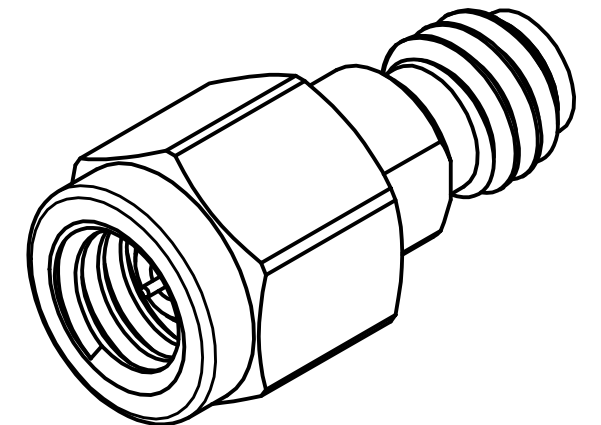
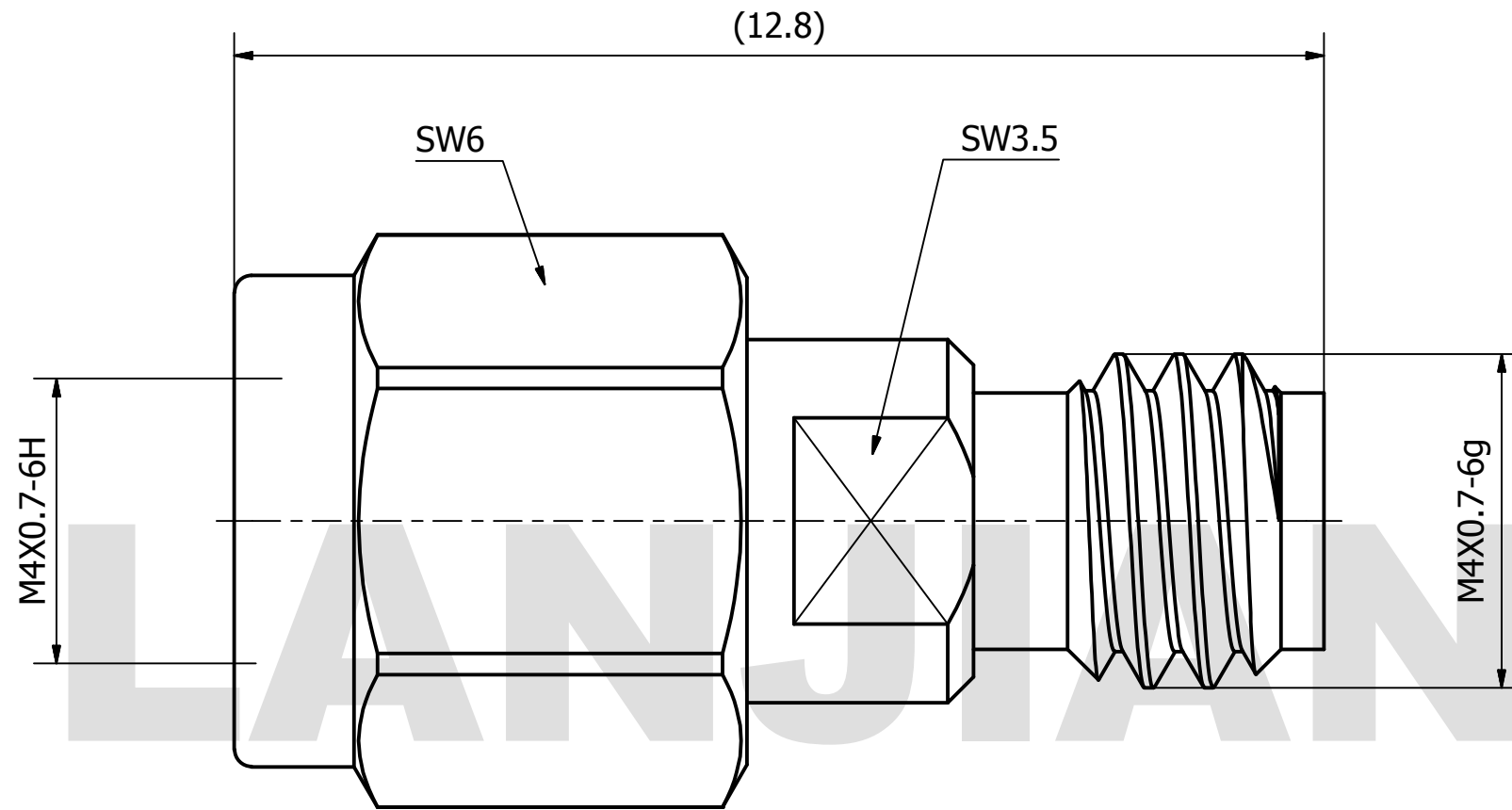

MATERIAL:
 BODY: STAINLESS STEEL PER AMS-5640,
 ALLOY UNS S30300
 CONTACT: BERYLLIUM COPPER PER ASTM B196.
 ALLOY NO. UNS C17300
 INSULATOR: PEI

PERFORMANCE:
 IMPEDANCE: 50 OHMS
 FREQUENCY: DC TO 110 GHz
 VSWR: ≤ 1.50

THIS DOCUMENT CONTAINS CONFIDENTIAL AND PROPRIETARY INFORMATION THAT CANNOT BE REPRODUCED OR DIVULGED, IN WHOLE OR IN PART, WITHOUT WRITTEN AUTHORIZATION FROM "LANJIAN ELECTRONICS"	MATERIAL :			38 Hengtong Road, Xinqu Dingmao Zhenjiang, 212009, Jiangsu, P. R. China	
	UNLESS OTHERWISE SPECIFIED: DIMENSIONS IN MM				
	TOLERANCES :				
	X.X	± 0.20	ANGULAR : $\pm 1^\circ$		DEBURR AND BREAK SHARP EDGES
	X.XX	± 0.10	FILLETS R/C : ± 0.10		
	X.XXX	± 0.01	SURFACE FINISH : Ra 1.6		
	NAME	DATE	SIGNATURE		
DRAWN	YaoJiang	10/24/2018			
CHK'D	HongZhongYan	10/24/2018			
APPV'D	HongZhongYan	10/24/2018			
MFG					
PROJECTION		SIZE	SCALE	DWG No.	REV.
		A3	12 : 1	GCPZ3.640.V.008	A
DO NOT SCALE THE DRAWING				PAGE	1 / 1