

NORTON WOOD GRILLE

Lay-In Installation Instructions

1 - GENERAL

1.1 PRODUCT DESIGN

Norton Flat Backer Wood Panel Grille System consists of 2' x 2' or custom sized panels designed to be installed on conventional 15/16" or 9/16" wide HD t-bar suspension system.

1.2 STORAGE & HANDLING

The ceiling components shall be stored in a dry interior location and shall remain in cartons/crates prior to installation to avoid damage. The cartons shall be stored in a flat, horizontal position. The protectors between panels should not be removed until installation. Proper care should be taken when handling to avoid damage and soiling. Do not store in unconditioned spaces with relative humidity greater than 55% or lower than 20% and temperatures lower than 50°F or greater than 86°F. Panels must not be exposed to extreme temperatures, for example, close to a heating source or near a window where there is direct sunlight.

1.3 SITE CONDITIONS

Norton Wood Grille ceiling materials should be permitted to reach room temperature and have stabilized moisture content for minimum of 72 hours before installation. (Remove shrink wrap, if any, to allow panels to climatize). They should not, however, be installed in spaces where the temperature or humidity conditions vary greatly from the temperatures and conditions that will be normal in the occupied space.

1.4 HVAC DESIGN & OPERATION

Proper design for both supply air and return air, maintenance of the HVAC filters and building interior space are essential to minimize soiling. Before starting the HVAC system, make sure supply air is properly filtered and the building interior is free of construction dust.

1.5 TEMPERATURE & HUMIDITY DURING INSTALLATION

Norton Wood Grilles are interior finish products designed for installation in temperature conditions between 50°F and 86°F, in spaces where the building is enclosed and HVAC systems are functioning and will be in continuous operation. Relative humidity shall not fall below 20% or exceed 55%. There shall be proper ventilation of the plenum in high moisture areas. All plastering, concrete, terrazzo, or any other wet work should be

completely dry. All windows and doors should be in place. The heating, ventilating and air-conditioning system should be installed and operable where necessary to maintain proper temperature and humidity conditions before, during and after installation of the wood panels.

1.6 COLOR

Norton Wood Grilles are made with solid wood or real wood veneers. Natural variations in color and grain are characteristic of wood products. To maximize visual consistency, panels should be unpacked and examined collectively to determine the most desirable arrangement for installation.

2 - SUSPENSION REQUIREMENTS

2.1 GENERAL

The suspension system shall be standard 15/16" or 9/16" exposed HD t-bar grid. The suspension system, whether new or existing, shall be properly installed and leveled using not less than 12-gauge galvanized steel wire. Suspension system installation shall conform to ASTM C-636 and ASTM E-580 (CISCA seismic recommendations). NOTE: The weight of these panels (2 - 3 lb/sf) necessitates that application of ASTM E-580 installation methods for areas subject to severe seismic disturbances. The manufacturer recommends following these guidelines as a minimum standard, regardless of building code requirements. Additional seismic requirements may be imposed by the International Building Code or local authority.

3 - SUSPENSION SYSTEM

3.1 LOAD CAPACITY

Norton Ceiling Grilles weigh approximately 2 - 3 lbs/sf. Main tee must be capable of supporting the weight of the panels plus any additional ceiling components that are not independently supported from the building structure.

3.2 SUSPENSION GRID

Norton Ceiling Grilles install in a 2' x 2' or as needed module. Install main tees 48" on center with a 24" cross tee every 48" at 90° to the main tee minimum. Module may need to be modified if custom sizes are being used.

4 - INSTALLATION

4.1 FIELD CUTTING & COMPONENTS

The panels sit below the grid system. The distance will be equal to the blade depth, so any other components in the ceiling, such as sprinklers, will need to be adjusted for this distance. Any holes cut for these items should be made slightly wider to allow for any shifting. Provided additional backers should be installed near the cut edges to maintain blade alignment and module stability.

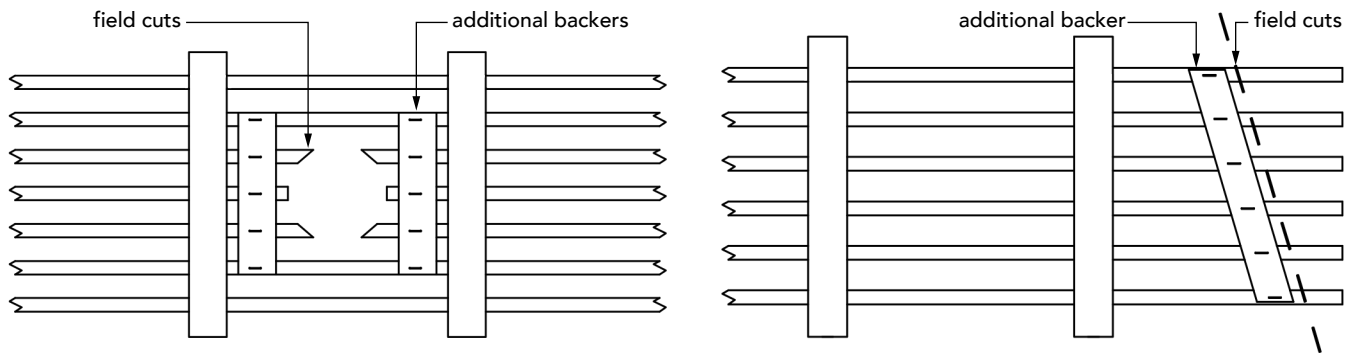

4.2 INSERTION INTO THE GRID

- Cross backers rest on $15/16''$ or $9/16''$ HD t-bar, with grille members hanging below ceiling grid.
- 1" reveal between panels on $15/16''$ grid, or $5/8''$ reveal on $9/16''$ grid.

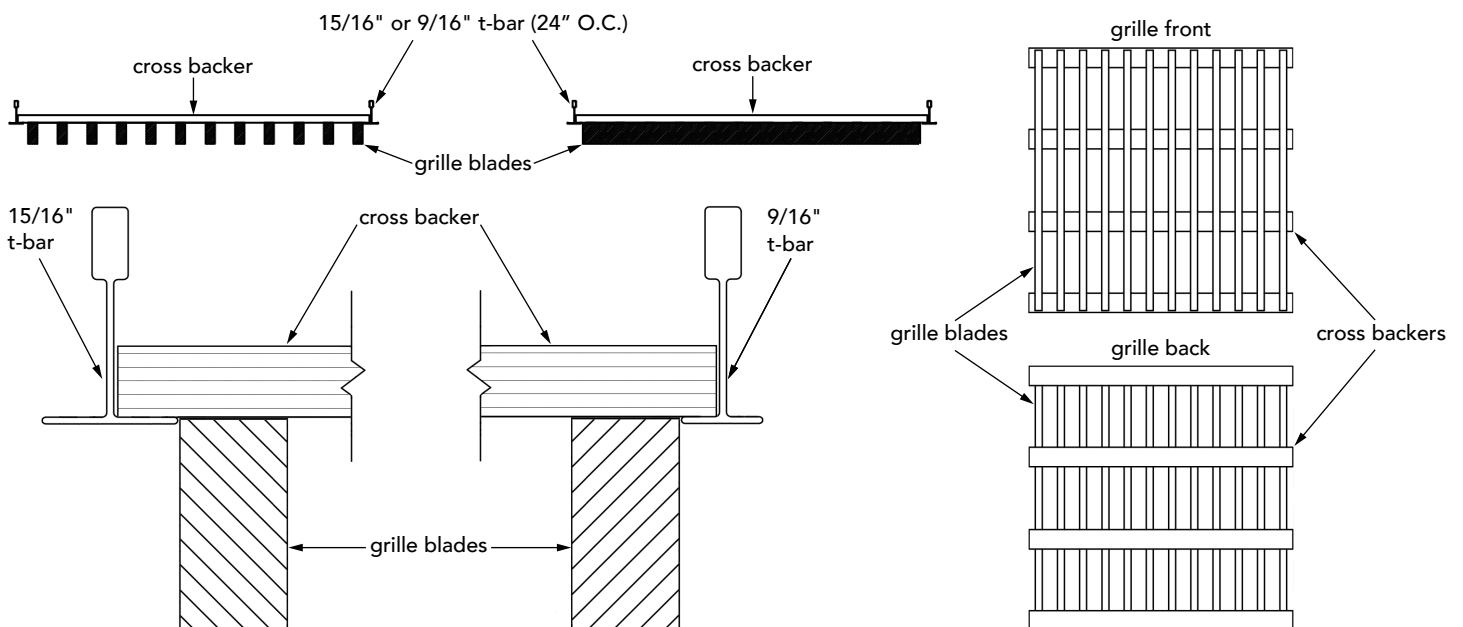

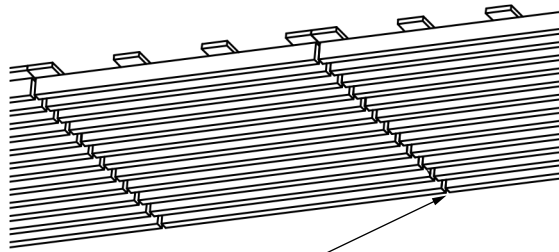

1" (15/16" t-bar) or
5/8" (9/16" t-bar) reveal

standard parallel layout

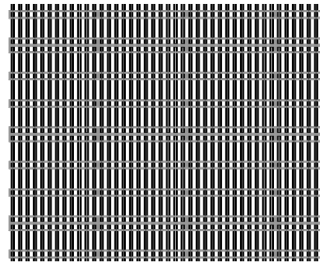

examples of
other possibilities

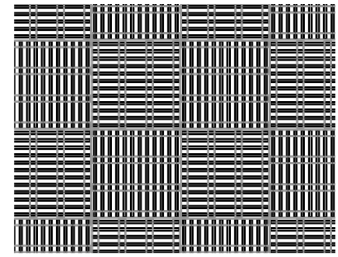
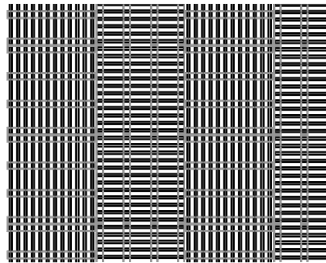
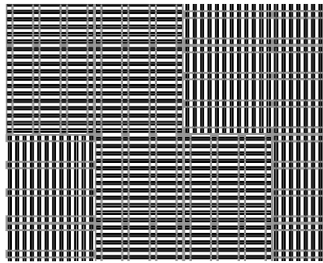

4.3 ODD SIZE GRILLES

Special size grilles are available from Norton Industries, Inc. to accommodate less than full modules within the field of the ceiling. Another option would be to field cut these panels to the required dimension.

CAUTION! WOOD DUST: Sawing, sanding and machining wood products can produce dust. Airborne wood dust can cause respiratory, eye and skin irritation. The International Agency for Research on Cancer (ARC) has classified wood dust as a nasal carcinogen in humans. **PRECAUTIONARY MEASURES:** If power tools are used, they should be equipped with a dust collector. If high dust levels are encountered, use an appropriate NIOSH-designed dust mask. Avoid dust contact with eyes and skin. **FIRST AID MEASURES IN CASE OF IRRITATION:** Flush eyes or skin with water for at least 15 minutes.

**NORTON
INDUSTRIES
INC.**