

SHEET METAL SCREWS

SLOTTED PAN HEAD

Zinc Plated

- Low profile and large head diameter for good driving power.
- Sharp lead point and deep twist resistant slots.
- Greater resistance to breakage and snapping.



# 4 DIAMETER		
J&B #	SIZE	QTY
12938	4 x 1/4	100
12939	4 x 3/8	100
25153	4 x 1/2	100
12940	4 x 5/8	100
25154	4 x 3/4	100
25155	4 x 1	100

# 6 DIAMETER		
J&B #	SIZE	QTY
12941	6 x 1/4	100
12942	6 x 3/8	100
12943	6 x 1/2	100
12944	6 x 5/8	100
12945	6 x 3/4	100
12946	6 x 7/8	100
12947	6 x 1	100
25156	6 x 1-1/4	100
25157	6 x 1-1/2	100
25158	6 x 2	100

# 8 DIAMETER		
J&B #	SIZE	QTY
12948	8 x 1/4	100
12949	8 x 3/8	100
12950	8 x 1/2	100
12951	8 x 5/8	100
12952	8 x 3/4	100
12953	8 x 7/8	100
12954	8 x 1	100
12955	8 x 1-1/4	50
12956	8 x 1-1/2	50
25159	8 x 1-3/4	50
25160	8 x 2	50

# 10 DIAMETER		
J&B #	SIZE	QTY
12958	10 x 3/8	100
12959	10 x 1/2	100
12960	10 x 5/8	100
12961	10 x 3/4	100
12962	10 x 7/8	100
12963	10 x 1	100
12964	10 x 1-1/4	50
12965	10 x 1-1/2	50
12966	10 x 1-3/4	50
12967	10 x 2	25
25161	10 x 2-1/2	25
25162	10 x 3	25

# 12 DIAMETER		
J&B #	SIZE	QTY
12968	12 x 1/2	100
12969	12 x 5/8	100
12970	12 x 3/4	100
12971	12 x 7/8	100
12972	12 x 1	50
12973	12 x 1-1/4	50
12974	12 x 1-1/2	50
12975	12 x 1-3/4	25
12976	12 x 2	25
25163	12 x 2-1/2	25
25164	12 x 3	25

# 14 DIAMETER		
J&B #	SIZE	QTY
12977	14 x 1/2	100
12978	14 x 5/8	100
12979	14 x 3/4	100
12980	14 x 7/8	100
12981	14 x 1	50
12982	14 x 1-1/4	50
12983	14 x 1-1/2	50
12984	14 x 1-3/4	25
12985	14 x 2	25
25165	14 x 2-1/2	25

SHEET METAL SCREWS

PHILLIPS PAN HEAD Zinc Plated

- Low profile and large head diameter provide good driving power.
- Sharp, hardened threads.
- Greater resistance to snapping and breakage.



# 4 DIAMETER		
J&B #	SIZE	QTY
46404	4 x 1/4	100
46405	4 x 3/8	100
46406	4 x 1/2	100
46407	4 x 5/8	100
46408	4 x 3/4	100
46409	4 x 1	100

# 8 DIAMETER		
J&B #	SIZE	QTY
38513	8 x 1/4	100
13044	8 x 3/8	100
13045	8 x 1/2	100
13046	8 x 5/8	100
13047	8 x 3/4	100
38502	8 x 7/8	100
13049	8 x 1	100
13050	8 x 1-1/4	100
13051	8 x 1-1/2	50
46413	8 x 1-3/4	50
40138	8 x 2	50

# 12 DIAMETER		
J&B #	SIZE	QTY
13060	12 x 1/2	100
46414	12 x 5/8	100
13062	12 x 3/4	100
46415	12 x 7/8	100
13064	12 x 1	50
13065	12 x 1-1/4	50
13066	12 x 1-1/2	50
46416	12 x 1-3/4	50
13068	12 x 2	50
38507	12 x 2-1/2	50
46417	12 x 3	50

# 6 DIAMETER		
J&B #	SIZE	QTY
13036	6 x 1/4	100
13037	6 x 3/8	100
13038	6 x 1/2	100
46410	6 x 5/8	100
13040	6 x 3/4	100
46411	6 x 7/8	100
13042	6 x 1	100
38511	6 x 1-1/4	100
38512	6 x 1-1/2	100
46412	6 x 2	50

# 10 DIAMETER		
J&B #	SIZE	QTY
13052	10 x 3/8	100
13053	10 x 1/2	100
13054	10 x 5/8	100
13055	10 x 3/4	100
38503	10 x 7/8	100
13057	10 x 1	100
13058	10 x 1-1/4	100
13059	10 x 1-1/2	50
38504	10 x 1-3/4	50
40139	10 x 2	50
38505	10 x 2-1/2	50
38506	10 x 3	50

# 14 DIAMETER		
J&B #	SIZE	QTY
40129	14 x 1/2	100
38527	14 x 5/8	100
40130	14 x 3/4	100
38528	14 x 7/8	100
40132	14 x 1	50
40133	14 x 1-1/4	50
40134	14 x 1-1/2	50
38529	14 x 1-3/4	50
40136	14 x 2	50
38508	14 x 2-1/2	50
38509	14 x 3	50

SHEET METAL SCREWS

SQUARE RECESSED PAN HEAD

Zinc Plated

- Low profile and large head diameter provide good driving power.
- Sharp, hardened threads.
- Greater resistance to snapping and breakage.



# 8 DIAMETER		
J&B #	SIZE	QTY
15000	8 x 3/4	100
15001	8 x 1	100
15002	8 x 1-1/4	100
15003	8 x 1-1/2	50
15004	8 x 2	50
15005	8 x 3	50

SHEET METAL SCREWS

PHILLIPS FLAT HEAD

Zinc Plated



- Sharp lead points and deep twist resistant slots for easier and faster driving.

# 6 DIAMETER		
J&B #	SIZE	QTY
32170	6 x 1/4	100
32171	6 x 3/8	100
32172	6 x 1/2	100
32173	6 x 5/8	100
32174	6 x 3/4	100
32175	6 x 1	100

# 8 DIAMETER		
J&B #	SIZE	QTY
32176	8 x 3/8	100
32177	8 x 1/2	100
32178	8 x 3/4	100
32179	8 x 1	100
32149	8 x 1-1/4	100
32150	8 x 1-1/2	100
32151	8 x 2	100
32180	8 x 2-1/2	100
32181	8 x 3	100

# 10 DIAMETER		
J&B #	SIZE	QTY
32182	10 x 1/2	100
32183	10 x 3/4	100
32184	10 x 1	100
32185	10 x 1-1/4	100
32186	10 x 1-1/2	100
32187	10 x 1-3/4	100

# 12 DIAMETER		
J&B #	SIZE	QTY
32188	12 x 1/2	100
32189	12 x 3/4	100
32190	12 x 1	100
32191	12 x 1-1/4	100
32192	12 x 1-1/2	100

# 14 DIAMETER		
J&B #	SIZE	QTY
32193	14 x 1/2	100
32194	14 x 3/4	100
32195	14 x 1	100
32196	14 x 1-1/4	100
32197	14 x 1-1/2	100

WOOD SCREWS

STEEL PHILLIPS FLAT HEAD

Zinc Plated

- Head provides flush surface with countersunk hole; use where clearance is important.
- Sharp leader points provide greater resistance to snapping and breakage.



# 4 DIAMETER		
J&B #	SIZE	QTY
32198	4 x 1/2	100
32199	4 x 3/4	100
32200	4 x 1	100

# 5 DIAMETER		
J&B #	SIZE	QTY
32201	5 x 1/2	100
32202	5 x 3/4	100
32203	5 x 1	100
32204	5 x 1-1/4	100
32205	5 x 1-1/2	100

# 6 DIAMETER		
J&B #	SIZE	QTY
32206	6 x 1/2	100
32207	6 x 3/4	100
32208	6 x 1	100
32209	6 x 1-1/4	100
32210	6 x 1-1/2	100

# 7 DIAMETER		
J&B #	SIZE	QTY
32211	7 x 1/2	100
32212	7 x 3/4	100
32213	7 x 1	100

# 8 DIAMETER		
J&B #	SIZE	QTY
32214	8 x 1/2	100
32215	8 x 3/4	100
32216	8 x 1	100
32217	8 x 1-1/4	100
32218	8 x 1-1/2	100
32219	8 x 1-3/4	100
32220	8 x 2	100
32221	8 x 2-1/2	100
32222	8 x 3	100

# 10 DIAMETER		
J&B #	SIZE	QTY
32223	10 x 1/2	100
32224	10 x 3/4	100
32225	10 x 1	100
32226	10 x 1-1/4	100
32227	10 x 1-1/2	100
32228	10 x 2	100
32229	10 x 2-1/2	100

# 12 DIAMETER		
J&B #	SIZE	QTY
32230	12 x 3/4	100
32231	12 x 1	100
32232	12 x 1-1/4	100
32233	12 x 1-1/2	100
32234	12 x 1-3/4	100
32235	12 x 2	100
32236	12 x 2-1/2	100
32237	12 x 3	100

# 14 DIAMETER		
J&B #	SIZE	QTY
32238	14 x 3/4	100
32239	14 x 1	100
32240	14 x 1-1/2	100
32241	14 x 2	100
32242	14 x 2-1/2	100
32243	14 x 3	100

SHEET METAL SCREWS

PHILLIPS OVAL HEAD

Zinc Plated

- Deep burr-free, recessed heads for easier and faster driving.
- Top protrudes slightly above material surface.

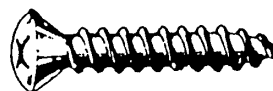

# 6 THREADS		
J&B #	SIZE	QTY
13079	6 x 5/8	100

# 8 THREADS		
J&B #	SIZE	QTY
13089	8 x 1	100
13091	8 x 1-1/2	50

# 10 THREADS		
J&B #	SIZE	QTY
13103	10 x 3/4	100
13109	10 x 2	50

"UNDERSIZED" PHILLIPS OVAL HEAD

Zinc Plated

# 8 THREADS W/ # 6 HEAD		
J&B #	SIZE	QTY
13095	8 x 3/4	100
13096	8 x 1	100
13097	8 x 1-1/4	50
13098	8 x 1-1/2	50

# 10 THREAD W/ # 6 HEAD		
J&B #	SIZE	QTY
13101	10 x 1/2	100
13112	10 x 1	100
12318	10 x 1-1/4	50
12321	10 x 1-1/2	25

* BLACK PHOSPHATE

# 10 THREAD W/ # 8 HEAD		
J&B #	SIZE	QTY
13119	10 x 3/4	100
12316	10 x 1	50
13122	10 x 1-3/4	50

BLACK SCREWS

PHILLIPS OVAL HEAD TRIM

Black Satin Finish

- Deep burr-free slots for easier and faster driving.
- Sharp point for fastening wood or metal trim to wood or metal framing.



# 8 THREADS		
J&B #	SIZE	QTY
11901	8 x 3/4	100



# 10 THREADS W/ # 8 HEAD		
J&B #	SIZE	QTY
13472	10 x 3/4	100
13473	10 x 1	50

SPECIAL TAPPING SCREW

J&B #	DESCRIPTION	QTY	
41843	M4.2-1.41 x 20mm 16mm Washer O.D. Hex Hd. Sems	50	
45820	M4.2-1.41 x 20mm 12mm Washer O.D. 7 mm Hex	100	
45816	M6.3-1.81 x 25mm 17mm Washer O.D. Hex Hd. Sems	50	
41844	M4.2-1.41 x 20mm 12mm Washer O.D. Hex Hd. Sems with teks point	50	
41880	M4.2-1.41 x 20mm 12mm Washer O.D. Hex Hd. Sems	50	
42006	M6.3-1.81 x 20mm 17mm Washer O.D. Hex Hd. Sems	50	
59126	M5-2.2 x 20mm 20mm Washer O.D. Torx Pan Hd Sems	15	

BLACK SCREWS

SPECIAL TAPPING SCREW

J&B #	DESCRIPTION	QTY	
45828	8 x 3/4 Phillips Washer Truss Hd 31/64 Wash Hd. O.D.	100	
45846	8 x 1/2 Phillips Washer truss Hd w/ teks Pt. 7/16 Wash O.D.	50	
40915	8 x 3/4 Phillips Washer truss Hd w/ teks Pt. 7/16 Wash O.D.	50	

PHILLIPS HEAD



BLACK OXIDE		
J&B #	SIZE	QTY
4019	6 x 3/4	100
4020	8 x 1/2	100
13447	8 x 3/4	100
13420	8 x 1	100
4021	8 x 1-1/2	50
4022	10 x 1/2	100
4023	10 x 3/4	100
45806	10 x 1	50
4024	10 x 1-1/4	50

BLACK OXIDE PHILLIPS WASHER HEAD TAPPING SCREW		
J&B #	SIZE	QTY
42062	8 x 1/2	100
4026	8 x 5/8	100
42002	8 x 3/4	100
45812	8 x 1	100
4027	8 x 1-1/4	50
45824	10 x 3/4	50
4028	10 x 1	50
4029	10 x 1-1/4	50

SCREWS

DRYWALL

Bugle Head Phillips – Coarse Thread

J&B #	SIZE	QTY
40480	6 x 1	100
40481	6 x 1-1/8	100
40482	6 x 1-1/4	100
40483	6 x 1-5/8	100
40484	6 x 2	100
40486	6 x 2-1/4	100
41034	8 x 1-1/2	100
41035	8 x 1-5/8	100
41036	8 x 2	100
41037	8 x 2-1/2	100
41041	8 x 3	100

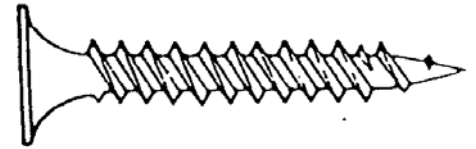

- Head is self-countersinking and designed to resist tearing drywall paper surface.
- Deep phillips recess reduces dropped and misaligned screws.

SHEET METAL SCREWS

SLOTTED HEX WASHER HEAD

Zinc Plated

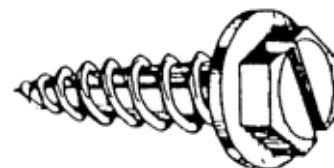

- Eliminates punching or drilling holes in sheet metal.
- Washer face protects metal against wrench disfigurement.
- Provide an excellent bearing surface and cover irregular holes.

# 6 DIAMETER		
J&B #	SIZE	QTY
11284	6 x 3/8	50
32119	6 x 1/2	50
32120	6 x 3/4	50
32121	6 x 1	50

# 6 DIAMETER		
J&B #	SIZE	QTY
32154	6 x 1/4	100
32155	6 x 3/8	100
32156	6 x 1/2	100
32157	6 x 3/4	100
32158	6 x 1	100

# 8 DIAMETER		
J&B #	SIZE	QTY
11286	8 x 1/2	50
11287	8 x 3/4	50
11288	8 x 1	50
11289	8 x 1-1/4	50
11290	8 x 1-1/2	25

# 8 DIAMETER		
J&B #	SIZE	QTY
11612	8x 3/8	100
11613	8 x 1/2	100
11614	8 x 3/4	100
11615	8 x 1	100
32133	8 x 1-1/4	100
11616	8 x 1-1/2	100
41390	8 x 2	50

# 10 DIAMETER		
J&B #	SIZE	QTY
32122	10 x 3/8	50
11291	10 x 1/2	50
11292	10 x 5/8	50
11293	10 x 3/4	50
11294	10 x 1	50
11295	10 x 1-1/4	25
11296	10 x 1-1/2	25

# 10 DIAMETER		
J&B #	SIZE	QTY
32135	10 x 3/8	100
11617	10 x 1/2	100
32137	10 x 5/8	100
11618	10 x 3/4	100
11619	10 x 1	100
11620	10 x 1-1/4	100
11621	10 x 1-1/2	100
41393	10 x 2	50
41394	10 x 3	25

SHEET METAL SCREWS

SLOTTED HEX WASHER HEAD

Zinc Plated

- Eliminates punching or drilling holes in sheet metal.
- Washer face protects metal against wrench disfigurement.
- Provide an excellent bearing surface and cover irregular holes.

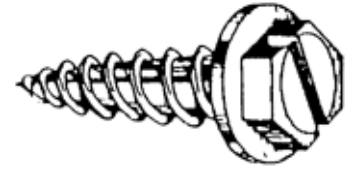

# 12 DIAMETER		
J&B #	SIZE	QTY
32123	12 x 1/2	50
32124	12 x 5/8	50
11297	12 x 3/4	50
11298	12 x 1	50
11299	12 x 1-1/4	25
11300	12 x 1-1/2	25

# 12 DIAMETER		
J&B #	SIZE	QTY
32159	12 x 1/2	100
32160	12 x 5/8	100
11622	12 x 3/4	100
11623	12 x 1	100
11624	12 x 1-1/4	100
11625	12 x 1-1/2	100
41396	12 x 2	50

# 14 DIAMETER		
J&B #	SIZE	QTY
32125	14 x 1/2	50
11301	14 x 3/4	50
11302	14 x 1	25
11303	14 x 1-1/4	25
11304	14 x 1-1/2	25

# 14 DIAMETER		
J&B #	SIZE	QTY
11626	14 x 1/2	100
40396	14 x 5/8	100
11627	14 x 3/4	100
11628	14 x 1	100
11629	14 x 1-1/4	100
11630	14 x 1-1/2	100
41399	14 x 2	50

5/16 DIAMETER		
J&B #	SIZE	QTY
11305	5/16 x 1	25
41384	5/16 x 1-1/2 NO SLOT 7/16 HEX	25



5/16 DIAMETER		
J&B #	SIZE	QTY
32153	5/16 x 1 SLOTTED 1/2 HEX	50

3/8 DIAMETER		
J&B #	SIZE	QTY
41379	3/8 x 1	25
41381	3/8 x 1-1/2 NO SLOT 9/16 HEX	25



SHEET METAL SCREWS

HEX HEAD

Zinc Plated

- Large hex head for easy wrenching.
- Faster and easier to start and drive.
- Install and remove with standard sockets or wrenches for high driving torque.

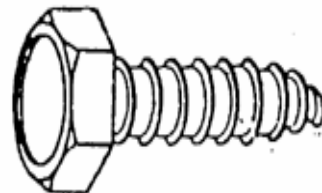

5/16 DIAMETER		
J&B #	SIZE	QTY
11631	5/16 x 3/4	50
11632	5/16 x 1	50
11633	5/16 x 1-1/4	50
11634	5/16 x 1-1/2	50

3/8 DIAMETER		
J&B #	SIZE	QTY
11639	3/8 x 3/4	50
11640	3/8 x 1	50
11641	3/8 x 1-1/4	50
11642	3/8 x 1-1/2	50

HEX WASHER HEAD

(Washer loose from Head)

Plated Finish

# 14 DIAMETER		
J&B #	SIZE	QTY
13147	14 x 3/4 with 3/8 Hex	50

- Provide an excellent bearing surface and cover irregular holes.

TRAILER FASTENERS

TORX BUTTON HEAD

- Provides excellent driving power while the specially designed thread minimizes slippage, increases holding power, and resists stripping.
- Ideal for holding on lower rail on trailers.
- Cadmium plated finish.



J&B #	SIZE	DRIVE SIZE	QTY
40320	3/8-16 x 1-1/4	T45	100

TORX BUTTON HEAD 302 STAINLESS STEEL

- Provides excellent driving power while the specially designed thread minimizes slippage, increases holding power, and resists stripping.
- Ideal for holding on lower rail on trailers.
- 302 Stainless steel finish.



J&B #	SIZE	DRIVE SIZE	QTY
V45954	3/8-16 x 1-1/4	T45	100

TORX TRUSS HEAD

- Provides excellent driving power while the specially designed thread minimizes slippage, increases holding power, and resists stripping.
- Ideal for holding on lower rail on trailers.
- Cadmium plated finish.



J&B #	SIZE	DRIVE SIZE	QTY
V45952	3/8-16 x 1-1/4	T45	100
V45953	3/8-16 x 1-7/8	T45	100

THREAD CUTTING SCREWS

HEX WASHER HEAD

Zinc Plated

J&B #	SIZE	QTY
38523	8-32 x 1/2	100
38524	8-32 x 3/4	100
32152	10/24 x 1/2	100
32164	10/24 x 3/4	100
32165	10/24 x 1	100
38453	1/4-20 x 1/2	100
32166	1/4-20 x 3/4	100
38428	1/4-20 x 1	100
32148	1/4-20 x 1-1/2	50
12915	5/16-18 x 1/2	50
12916	5/16-18 x 3/4	50
12917	5/16-18 x 1	50
32167	5/16-18 x 1-1/4	50
38454	5/16-18 x 1-1/2	25
38455	5/16-18 x 2	25
38429	3/8-16 x 3/4	50
12918	3/8-16 x 1	50
12930	3/8-16 x 1-1/4	50
38430	3/8-16 x 1-1/2	25
38431	3/8-16 x 2	25



- Washer head face provides an excellent bearing surface.
- Head protrudes above material surface.

PHILLIPS FLAT HEAD

Zinc Plated

J&B #	SIZE	QTY
32161	10/24 x 3/4	100
32162	1/4-20 x 1	100
13152	1/4-20 x 1-1/2	100
32163	1/4-20 x 1-3/4	100



- Flat head provides flush surface with countersunk hole.

PHILLIPS PAN HEAD

Zinc Plated

J&B #	SIZE	QTY
45576	10-24 x 1/2	100
45577	10-24 x 3/4	100
45578	10-24 x 1	100
45599	10-24 x 1-1/4	100
45607	1/4-20 x 3/4	100
45608	1/4-20 x 1	100
45609	1/4-20 x 1-1/4	50



- Have low profile and large head diameter for good driving power.

THREAD CUTTING SCREWS

TORX DRIVE SYSTEM

- Provides excellent driving power while the specially designed thread minimizes slippage, increases holding power, and resists stripping.
- Ideal for floorboard fastening.
- Screw head provides flush surface with countersunk hole.



J&B #	SIZE	DRIVE SIZE	QTY
38873	1/4 x 1	T30	100
38874	1/4 x 1-1/4	T30	100
38875	1/4 x 1-1/2	T30	100
38876	1/4 x 2	T30	100
39137	1/4 x 2-1/4	T30	100
38879	1/4 x 2-1/2	T30	100
38880	1/4 x 2-1/2	T30	600
38881	1/4 x 3	T30	50
39135	5/16 x 1	T40	50
39136	5/16 x 1-1/2	T40	50
38882	5/16 x 2	T40	25
39141	5/16 x 2-1/4	T40	50
39133	5/16 x 2-1/2	T40	100
39134	5/16 x 3	T40	50
39131	5/16 x 3-1/2	T40	50

SELF-DRILLING SCREWS

TEKS HEX WASHER HEAD

With Neo Washer

- Drills, taps and fastens in one **quick, easy** motion eliminating alignment problems.
- Tekes fasten metal to metal and a wide range of other materials including wood, synthetics and mechanical components to metal.



8-18 DIAMETER			
J&B #	SIZE	SOCKET SIZE	QTY
39021	8-18 x 3/4	1/4	100

10-16 DIAMETER			
J&B #	SIZE	SOCKET SIZE	QTY
39024	10-16 x 3/4	5/16	100
39025	10-16 x 1	5/16	100

12-14 DIAMETER			
J&B #	SIZE	SOCKET SIZE	QTY
39033	12-14 x 3/4	5/16	50
39034	12-14 x 1	5/16	50
39035	12-14 x 1-1/4	5/16	50
39036	12-14 x 1-1/2	5/16	50

1/4-14 DIAMETER			
J&B #	SIZE	SOCKET SIZE	QTY
39053	1/4-14 x 3/4	3/8	50
39054	1/4-14 x 1	3/8	50
39055	1/4-14 x 1-1/4	3/8	50
39056	1/4-14 x 1-1/2	3/8	50

SELF-DRILLING SCREWS

TEKS HEX WASHER HEAD

Zinc Plated

- Drills, taps and fastens in one **quick, easy** motion eliminating alignment problems.
- Tek screws fasten metal to metal and a wide range of other materials including wood, synthetics and mechanical components to metal.

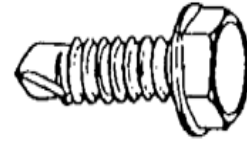

6-20 DIAMETER			
J&B #	SIZE	SOCKET SIZE	QTY
41386	6-20 x 3/8	1/4	100
41387	6-20 x 1/2	1/4	100
39138	6-20 x 5/8	1/4	100
41388	6-20 x 3/4	1/4	100
41389	6-20 x 1	1/4	100

8-18 DIAMETER			
J&B #	SIZE	SOCKET SIZE	QTY
12920	8-18 x 1/2	1/4	100
37530	8-18 x 5/8	1/4	100
12921	8-18 x 3/4	1/4	100
12922	8-18 x 1	1/4	100
41385	8-18 x 1-1/4	1/4	50
37531	8-18 x 1-1/2	1/4	50
41391	8-18 x 2	1/4	50

10-16 DIAMETER			
J&B #	SIZE	SOCKET SIZE	QTY
12923	10-16 x 1/2	5/16	100
37532	10-16 x 5/8	5/16	100
12924	10-16 x 3/4	5/16	100
12925	10-16 x 1	5/16	100
37534	10-16 x 1-1/4	5/16	50
12698	10-16 x 1-1/2	5/16	50
41392	10-16 x 2	5/16	50
41509	10-16 x 2-1/2	5/16	50
41510	10-16 x 3	5/16	50

12-14 DIAMETER			
J&B #	SIZE	SOCKET SIZE	QTY
39139	12-14 x 5/8	5/16	50
41370	12-14 x 3/4	5/16	50
41371	12-14 x 1	5/16	50
41372	12-14 x 1-1/4	5/16	50
41373	12-14 x 1-1/2	5/16	50
41395	12-14 x 2	5/16	50
41511	12-14 x 2-1/2	5/16	50
41512	12-14 x 3	5/16	50

1/4-14 DIAMETER			
J&B #	SIZE	SOCKET SIZE	QTY
41514	1/4-14 x 5/8	3/8	50
12926	1/4-14 x 3/4	3/8	50
12927	1/4-14 x 1	3/8	50
37535	1/4-14 x 1-1/4	3/8	50
12929	1/4-14 x 1-1/2	3/8	50
41515	1/4-14 x 1-3/4	3/8	50
41375	1/4-14 x 2	3/8	50
41376	1/4-14 x 2-1/2	3/8	50
41377	1/4-14 x 3	3/8	50
41517	1/4-14 x 4	3/8	25

5/16-12 DIAMETER			
J&B #	SIZE	SOCKET SIZE	QTY
37952	5/16-12 x 1	3/8	50
37953	5/16-12 x 1-1/2	3/8	50
39143	5/16-12 x 2	3/8	25

SELF-DRILLING SCREWS

TEKS PHILLIPS WAFER HEAD

Zinc Plated

- Also known as plymetal screws because they are ideal for attaching plywood to metal.
- Their large wafer head forms an excellent bearing surface.
- Head countersinks below the wood's surface.



#10 DIAMETER			
J&B #	SIZE	DRILL PT. #	QTY
41481	10-24 x 1	3	100
41482	10-16 x 1-1/2	3	100

PHILLIPS FLAT HEAD TEKS

- Drills, taps and fastens in one **quick, easy** motion eliminating alignment problems.
- TekS fasten metal to metal and a wide range of other materials including wood, synthetics and mechanical components to metal.



6-20 DIAMETER		
J&B #	SIZE	QTY
86048	6-20 x 1/2	100
86050	6-20 x 1-1/4	100

8-18 DIAMETER		
J&B #	SIZE	QTY
86052	8-18 x 3/4	100
86053	8-18 x 1	100
86054	8-18 x 1-1/4	50

10-16 DIAMETER		
J&B #	SIZE	QTY
86056	10-16 x 3/4	100
86057	10-16 x 1	100
86058	10-16 x 1-1/4	50

1/4-14 DIAMETER		
J&B #	SIZE	QTY
86060	1/4-14 x 1	50

TEKS HEX WASHER HEAD

#4 Point - Heavy Gauge Metal

- Stalgard Corrosion Resistant Coating protects any ferrous metal against rust and corrosion better than any conventional coating.
- Fasten decking to bar joist and beams, electrical or plumbing accessories to joist or stud, roof, decking and bridge decking.



J&B #	SIZE	MAX. METAL THICKNESS	QTY
41188	12-24 x 1-1/4	.375	500
41190	12-24 x 1-1/4	.375	50

SELF-DRILLING SCREWS

TEKS PHILLIPS PAN HEAD

Zinc Plated

- Drills, taps and fastens in one **quick, easy** motion eliminating alignment problems.
- Tek screws fasten metal to metal and a wide range of other materials including wood, synthetics and mechanical components to metal.



6-20 DIAMETER		
41404	6 x 3/8	100
41405	6 x 1/2	100
37536	6 x 5/8	100
37537	6 x 3/4	100
37538	6 x 1	100

8-18 DIAMETER		
41400	8 x 3/8	100
12919	8 x 1/2	100
37539	8 x 5/8	100
13283	8 x 3/4	100
37540	8 x 1	100
37541	8 x 1-1/4	50
37542	8 x 1-1/2	50

10-16 DIAMETER		
41401	10 x 1/2	100
37543	10 x 5/8	100
41402	10 x 3/4	100
41403	10 x 1	100
37544	10 x 1-1/4	50
37545	10 x 1-1/2	50
41428	10 x 2	50

12-14 DIAMETER		
37548	12 x 3/4	100
37546	12 x 1	50
37547	12 x 1-1/2	50
41429	12 x 2	50

1/4-14 DIAMETER		
41445	1/4 x 3/4	50
41433	14 x 1	50
41434	14 x 1-1/2	50

PHILLIPS WASHER HEAD

Zinc Plated

J&B #	SIZE	WASHER O.D.	QTY
45808	8 x 1/2	7/16	50
40912	8 x 3/4	7/16	50
40919	8 x 1	7/16	50
40897	8 x 1-1/4	7/16	50





SCREWS

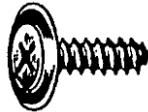



PHILLIPS ROUND HEAD FINISH SCREWS

# 8 THREAD W/ # 6 HEAD				
J&B #	FINISH	SIZE	QTY	
11542	Chrome	8 x 5/8	50	
11543	Chrome	8 x 3/4	50	

PHILLIPS BUTTON HEAD SCREWS

J&B #	FINISH	SIZE	QTY	
39192	Nickel on Brass	SOCKET	100	
39190	Nickel on Brass	8 x 3/8 STUD	25	
39188	Nickel on Brass	8 x 5/8 STUD	25	

MOULDING SCREWS

J&B #	FINISH	SIZE	QTY	
11867	Zinc	8-18 x 3/8	50	
12076	Zinc	8-18 x 3/8	50	
13637	Zinc	8-18 x 1/2	25	
13687	Zinc	8 x 5/8 TEK	25	
38174	Zinc	10 x 3/8	50	

SCREWDRIVING ACCESSORIES

PHILLIPS POWER BITS

- Precision made of special shock resistant, heat treated and tempered steel.

J&B #	SIZE	SHANK	LENGTH	QTY
39485	# 1	1/4	1-15/16"	EA
39576	# 1	1/4	2-3/4"	EA
39486	# 2	1/4	1-15/16"	EA
39479	# 2	1/4	2-3/4"	EA
39478	# 2	1/4	6"	EA
39488	# 3	1/4	1-15/16"	EA
39577	# 3	1/4	2-3/4"	EA
39519	# 3	1/4	6"	EA



PHILLIPS INSERT BITS

J&B #	SIZE	HEX DRIVE	LENGTH	QTY
39520	# 2	1/4	1"	EA
39521	# 3	1/4	1"	EA
39578	# 2	5/16	1-1/4"	EA
39522	# 3	5/16	1-1/4"	EA



HEXAGON SHANK MAGNETIC EZ-CHUCK

- For driving screws into metal with an electric drill.
- Recessed to allow the screw washer to be seated inside the chuck walls.
- Keeps your hex head screws from flipping out on any surface, even round duct.



J&B #	HEX HEAD	SCREW DIA.	SHANK	LENGTH	QTY
38421	1/4 W.A.F.	# 8	1/4	1-3/4	EA
38422	5/16 W.A.F.	#10	1/4	1-3/4	EA
38423	3/8 W.A.F.	1/4	1/4	1-3/4	EA
39579	7/16 W.A.F.	5/16	1/4	1-3/4	EA
39580	1/2 W.A.F.	3/8	1/4	1-3/4	EA

SCREWDRIVING ACCESSORIES

SQUARE INSERT BIT

J&B #	SQUARE SIZE	HEX DRIVE	LENGTH	QTY
39569	# 1	1/4	1	EA
39482	# 2	1/4	1	EA



SQUARE POWER BIT

J&B #	SQUARE SIZE	HEX DRIVE	LENGTH	QTY
39483	# 2	1/4	2	EA
39570	# 2	1/4	3	EA
39518	# 2	1/4	6	EA
39583	# 3	1/4	2	EA
39538	# 3	1/4	3	EA
39539	# 3	1/4	6	EA

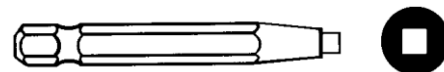

POZIDRIVE BIT

J&B #	POINT SIZE	HEX DRIVE	LENGTH	QTY
39484	# 2	1/4	1	EA



SLOTTED POWER BIT

J&B #	SCREW SIZE	HEX DRIVE	LENGTH	QTY
39487	8F-10R	1/4	1-15/16	EA



SCREWDRIVING ACCESSORIES

IMPACT SOCKET ADAPTER

J&B #	DRIVE	QTY
60090	1/4	2/PK
60091	3/8	2/PK
60092	1/2	2/PK



- Adapters come carded 2 per pack (1 pack sold equals 2 adapters).
- No broken packs.

TORX POWER BIT

J&B #	SIZE	HEX DRIVE	LENGTH	QTY
39543	T-10	1/4	2"	EA
39559	T-15	1/4	2"	EA
39561	T-20	1/4	2"	EA
39562	T-25	1/4	2"	EA
39563	T-27	1/4	2"	EA
39589	T-30	1/4	2"	EA



TORX INSERT DRIVE BITS

J&B #	SIZE	HEX DRIVE	LENGTH	QTY
39587	T-10	1/4	1"	EA
39588	T-15	1/4	1"	EA
39571	T-20	1/4	1"	EA
39572	T-25	1/4	1"	EA
39573	T-27	1/4	1"	EA
39480	T-30	1/4	1"	EA
39574	T-30	5/16	1"	EA
39481	T-40	1/4	1"	EA
39523	T-40	5/16	1-1/4"	EA
39575	T-45	5/16	1-1/4"	EA
39581	T-50	5/16	1-1/4"	EA
39582	T-55	5/16	1-1/4"	EA



SCREWDRIVING ACCESSORIES

MAGNET BIT TIP HOLDER

- 3" magnetic bit tip holder.
- Shock resistant steel for maximum durability.
- Hardened core for extra strength & reduced breakage.
- Heat treated to resist breakage & wear.

J&B #	HEX DRIVE	LENGTH	QTY
39566	1/4	3"	EA



LOCK-N-LOAD QUICK CHANGE EXTENSION

- Carbon steel construction sleeve and body for durability and life.
- Lock-n-load system for one-handed quick release. Magnetic for holding.
- Patented jaw design holds bits securely on 6 flatted shanks, as well as ball detent bits.
- 1/4" quick change range now holds insert bits.

J&B #	SHANK	LENGTH	QTY
38663	1/4	6"	EA



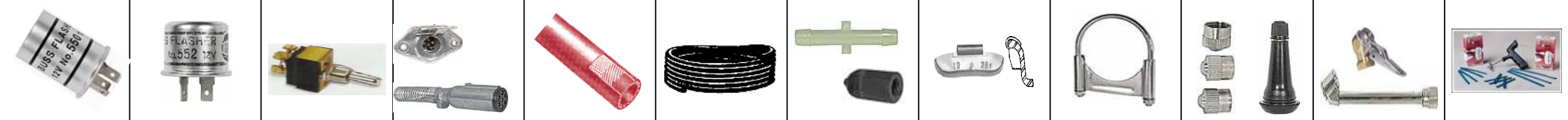



























J&B Fleet - Industrial Supply

22428 Harrisburg-Westville Rd. Alliance, Ohio 44601 Phone: (330) 821-6342 Fax: (330) 821-0411

www.jbfleet.com

PART # 2033

SLOTTED SHEET METAL SCREWS

 12942 1 6 X 3/8 25	 12943 2 6 X 1/2 25	 12945 3 6 X 3/4 25	 12949 4 8 X 3/8 25	 12950 5 8 X 1/2 25	 12952 6 8 X 3/4 25	 12954 7 8 X 1 25	 12955 8 8 X 1-1/4 25
 12956 9 8 X 1-1/2 25	 12958 11 10 X 3/8 25	 12959 12 10 X 1/2 25	 12960 13 10 X 5/8 25	 12961 14 10 X 3/4 25	 12963 15 10 X 1 25	 12964 16 10 X 1-1/4 25	
 12965 17 10 X 1-1/2 25	 12968 19 12 X 1/2 10	 12970 20 12 X 3/4 10	 12972 21 12 X 1 10	 12973 22 12 X 1-1/4 10	 12974 24 12 X 1-1/2 10		
 12977 26 14 X 1/2 10	 12979 27 14 X 3/4 10	 12981 28 14 X 1 10	 12982 29 14 X 1-1/4 10	 12983 31 14 X 1-1/2 10			

































J&B Fleet - Industrial Supply

www.jbfleet.com

22428 Harrisburg-Westville Rd. Alliance, Ohio 44601 Phone: (330) 821-6342 Fax: (330) 821-0411

PART # 2135

PHILLIPS SHEET METAL SCREWS

 13037 ¹ 25 6 X 3/8	 13038 ² 25 6 X 1/2	 13040 ³ 25 6 X 3/4	 13044 ⁴ 25 8 X 3/8	 13045 ⁵ 25 8 X 1/2	 13047 ⁶ 25 8 X 3/4	 38502 ⁷ 25 8 X 7/8	 13049 ⁸ 25 8 X 1
 13050 ⁹ 25 8 X 1-1/4	 13051 ¹⁰ 25 8 X 1-1/2	 13052 ¹¹ 25 10 X 3/8	 13053 ¹² 25 10 X 1/2	 13054 ¹³ 25 10 X 5/8	 13055 ¹⁴ 25 10 X 3/4	 38503 ¹⁵ 25 10 X 7/8	 13057 ¹⁶ 25 10 X 1
 13058 ¹⁷ 25 10 X 1-1/4	 13059 ¹⁸ 25 10 X 1-1/2	 13060 ¹⁹ 10 12 X 1/2	 13062 ²⁰ 10 12 X 3/4	 13064 ²¹ 10 12 X 1	 13065 ²² 10 12 X 1-1/4	 23	 13066 ²⁴ 10 12 X 1-1/2
 25	 40129 ²⁶ 10 14 X 1/2	 40130 ²⁷ 10 14 X 3/4	 40132 ²⁸ 10 14 X 1	 40133 ²⁹ 10 14 X 1-1/4	 30	 40134 ³¹ 10 14 X 1-1/2	 32

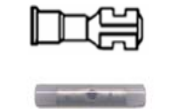

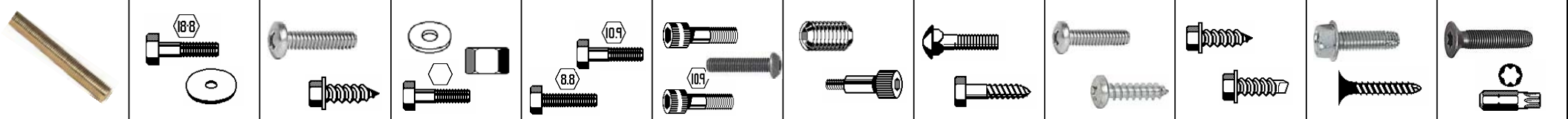























J&B Fleet - Industrial Supply

22428 Harrisburg-Westville Rd. Alliance, Ohio 44601 Phone: (330) 821-6342 Fax: (330) 821-0411

www.jbfleet.com

PART # 2142

WOOD SCREWS

1	32206  6 X 1/2 50	32207  6 X 3/4 50	32208  6 X 1 25	32210  6 X 1-1/2 25	32211  7 X 1/2 50
32213  7 X 1 25	32214  8 X 1/2 50	32215  8 X 3/4 50	32216  8 X 1 25	32218  8 X 1-1/2 25	32212  8 X 1-1/2 25
32223  10 X 1/2 50	32224  10 X 3/4 50	32225  10 X 1 25	32227  10 X 1-1/2 10	32228  10 X 2 10	32230  12 X 3/4 25
32231  12 X 1 25	32233  12 X 1-1/2 10	32238  14 X 3/4 25	32239  14 X 1 25	32240  14 X 1-1/2 10	32241  14 X 2 10

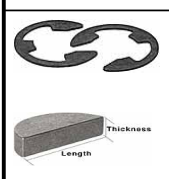
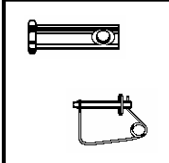
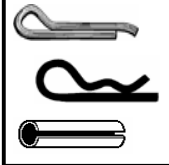
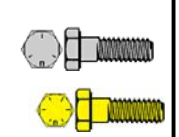
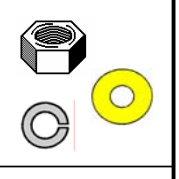
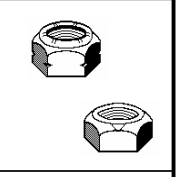
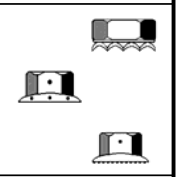
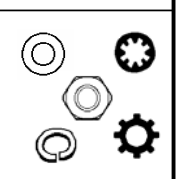



J&B Fleet - Industrial Supply







www.jbfleet.com

22428 Harrisburg-Westville Rd. Alliance, Ohio 44601 Phone: (330) 821-6342 Fax: (330) 821-0411

PART # 2234

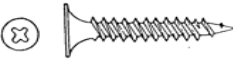
DRY WALL SCREWS

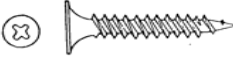
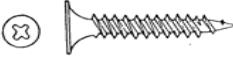
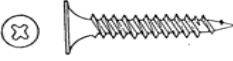
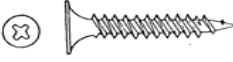
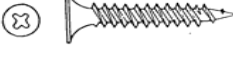

 40480 6 X 1 50	1 50	 40481 6 X 1-1/8 50	2 50	 40482 6 X 1-1/4 50	3 50
 40483 6 X 1-5/8 50	4 50	 40484 6 X 2 50	5 50	 40486 6 X 2-1/4 50	6 50
 41034 8 X 1-1/2 50	7 50	 41035 8 X 1-5/8 50	8 50	 41036 8 X 2 50	9 50
 41037 8 X 2-1/2 50	10 50	 41041 8 X 3 50	11 50		12 50

LET US HELP YOU MAKE THE CONNECTION

PART # 3047

DRYWALL SCREWS



J & B FLEET-INDUSTRIAL SUPPLY
PHONE: 330-821-6342

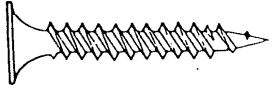

40480	40481	40482	40483	40484	40486
6 X 1"	6 X 1-1/8	6 X 1-1/4	6 X 1-5/8	6 X 2"	6 X 2-1/4
25	25	25	25	25	25



J&B Fleet - Industrial Supply









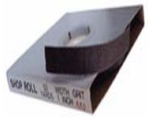













22428 Harrisburg-Westville Rd. Alliance, Ohio 44601 Phone: (330) 821-6342 Fax: (330) 821-0411

www.jbfleet.com

PART # 2048

SLOTTED HEX WASHER HEAD SHEET METAL SCREWS



<p>11284 ¹</p>  <p>6 X 3/8</p> <p>10</p>	<p>32157 ²</p>  <p>6 X 3/4</p> <p>10</p>	<p>11286 ³</p>  <p>8 X 1/2</p> <p>10</p>	<p>11287 ⁴</p>  <p>8 X 3/4</p> <p>10</p>	<p>11288 ⁵</p>  <p>8 X 1</p> <p>10</p>	<p>11289 ⁶</p>  <p>8 X 1-1/4</p> <p>10</p>
<p>11290 ⁷</p>  <p>8 X 1-1/2</p> <p>10</p>	<p>11291 ⁸</p>  <p>10 X 1/2</p> <p>10</p>	<p>11292 ⁹</p>  <p>10 X 5/8</p> <p>10</p>	<p>11293 ¹⁰</p>  <p>10 X 3/4</p> <p>10</p>	<p>11294 ¹¹</p>  <p>10 X 1</p> <p>10</p>	<p>11295 ¹²</p>  <p>10 X 1-1/4</p> <p>10</p>
<p>11296 ¹³</p>  <p>10 X 1-1/2</p> <p>10</p>	<p>11297 ¹⁴</p>  <p>12 X 3/4</p> <p>10</p>	<p>11298 ¹⁵</p>  <p>12 X 1</p> <p>10</p>	<p>11299 ¹⁶</p>  <p>12 X 1-1/4</p> <p>10</p>	<p>11300 ¹⁷</p>  <p>12 X 1-1/2</p> <p>10</p>	<p>11301 ¹⁸</p>  <p>14 X 3/4</p> <p>10</p>
<p>11302 ¹⁹</p>  <p>14 X 1</p> <p>10</p>	<p>11303 ²⁰</p>  <p>14 X 1-1/4</p> <p>10</p>	<p>11304 ²¹</p>  <p>14 X 1-1/2</p> <p>10</p>	<p>32153 ²²</p>  <p>5/16 X 1</p> <p>10</p>	<p>²³</p>	<p>²⁴</p>



















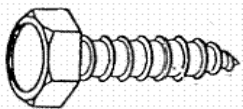

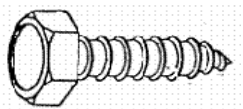

J&B Fleet - Industrial Supply

22428 Harrisburg-Westville Rd. Alliance, Ohio 44601 Phone: (330) 821-6342 Fax: (330) 821-0411

www.jbfleet.com

PART # 2026

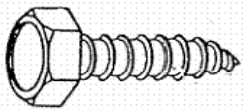
HEX HEAD SHEET METAL SCREWS

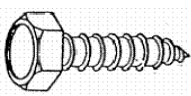
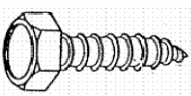
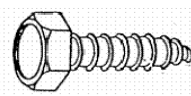
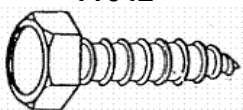
<p>32156 ¹</p>  <p>25 6 X 1/2</p>	<p>32157 ²</p>  <p>25 6 X 3/4</p>	<p>11612 ³</p>  <p>25 8 X 3/8</p>	<p>11613 ⁴</p>  <p>25 8 X 1/2</p>	<p>11614 ⁵</p>  <p>25 8 X 3/4</p>	<p>11634 ⁶</p>  <p>5 5/16 X 1-1/2 UNSLOTTED</p>
<p>11617 ⁷</p>  <p>25 10 X 1/2</p>	<p>11293 ⁸</p>  <p>10 10 X 3/4</p>	<p>11294 ⁹</p>  <p>10 10 X 1</p>	<p>11295 ¹⁰</p>  <p>10 10 X 1-1/4</p>	<p>32123 ¹¹</p>  <p>10 12 X 1/2</p>	<p>11639 ¹²</p>  <p>10 3/8 X 3/4 UNSLOTTED</p>
<p>11297 ¹³</p>  <p>10 12 X 3/4</p>	<p>11298 ¹⁴</p>  <p>10 12 X 1</p>	<p>32125 ¹⁵</p>  <p>10 14 X 1/2</p>	<p>11301 ¹⁶</p>  <p>10 14 X 3/4</p>	<p>11302 ¹⁷</p>  <p>10 14 X 1</p>	<p>11640 ¹⁸</p>  <p>5 3/8 X 1 UNSLOTTED</p>
<p>11303 ¹⁹</p>  <p>10 14 X 1-1/4</p>	<p>11304 ²⁰</p>  <p>10 14 X 1-1/2</p>	<p>11631 ²¹</p>  <p>10 5/16 X 3/4 UNSLOTTED</p>	<p>11632 ²²</p>  <p>10 5/16 X 1 UNSLOTTED</p>	<p>11633 ²³</p>  <p>5 5/16 X 1-1/4 UNSLOTTED</p>	<p>11642 ²⁴</p>  <p>5 3/8 X 1-1/2 UNSLOTTED</p>



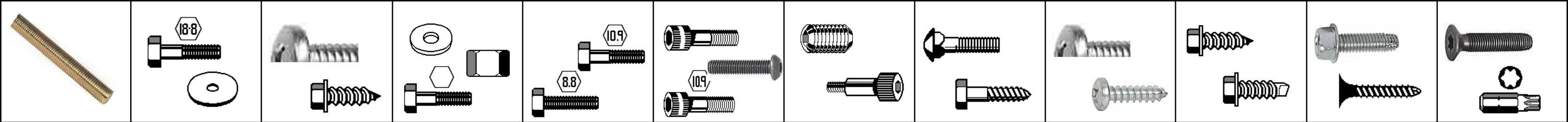

J&B Fleet - Industrial Supply

www.jbfleet.com

22428 Harrisburg-Westville Rd. Alliance, Ohio 44601 Phone: (330) 821-6342 Fax: (330) 821-0411

PART # 2245

THREAD CUTTING SCREWS

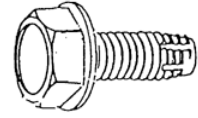
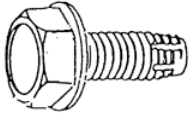
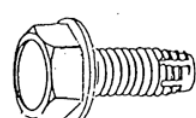
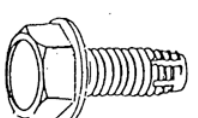
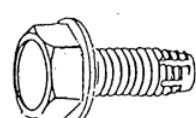
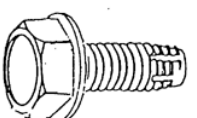
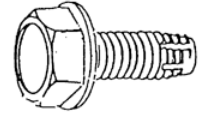
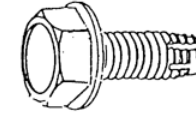
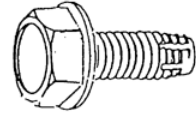
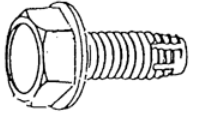
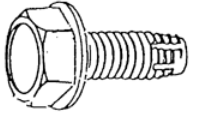
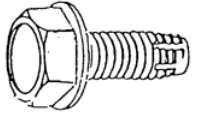
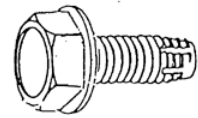
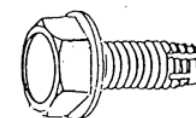
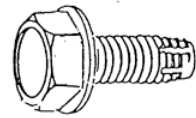
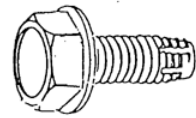
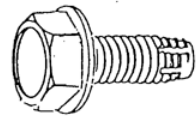
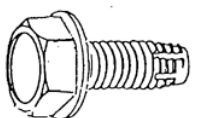
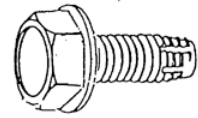
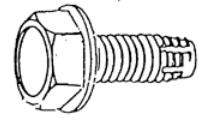
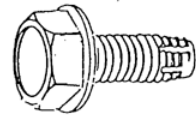
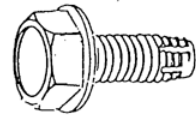
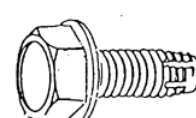
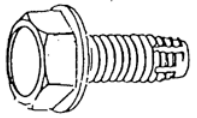
 38523 ¹ 8-32 X 1/2 25	 38524 ² 8-32 X 3/4 25	 32152 ³ 10-24 X 1/2 25	 32164 ⁴ 10-24 X 3/4 25	 32165 ⁵ 10-24 X 1 25	 38431 ⁶ 3/8-16 X 2 5
 38453 ⁷ 1/4-20 X 1/2 25	 32166 ⁸ 1/4-20 X 3/4 25	 38428 ⁹ 1/4-20 X 1 10	 32148 ¹⁰ 1/4-20 X 1-1/2 10	 32148 ¹¹ 10	 12915 ¹² 5/16-18 X 1/2 20
 12916 ¹³ 5/16-18 X 3/4 15	 12917 ¹⁴ 5/16-18 X 1 10	 32167 ¹⁵ 5/16-18 X 1-1/4 10	 32167 ¹⁶ 10	 38454 ¹⁷ 5/16-18 X 1-1/2 10	 38455 ¹⁸ 5/16-18 X 2 5
 38429 ¹⁹ 3/8-16 X 3/4 10	 38429 ²⁰ 10	 12918 ²¹ 3/8-16 X 1 10	 12918 ²² 10	 12930 ²³ 3/8-16 X 1-1/4 10	 38430 ²⁴ 3/8-16 X 1-1/2 5

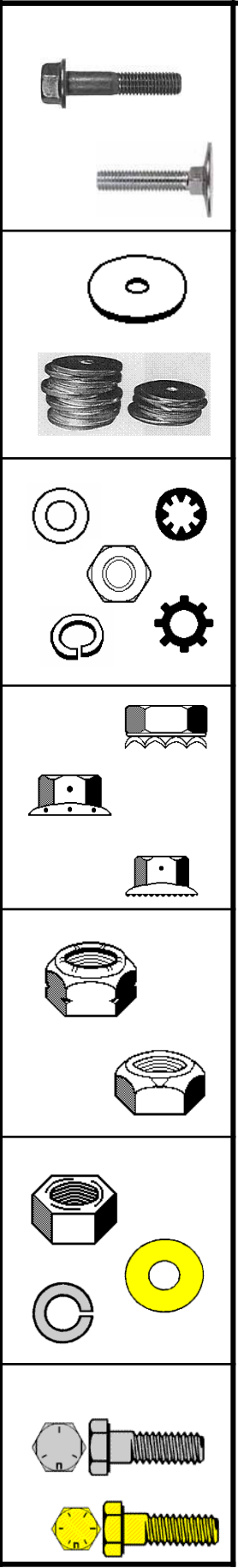

LET US HELP YOU MAKE THE CONNECTION

PART# 3099

PHILLIPS FLAT HD TEK SCREWS



J & B FLEET-INDUSTRIAL SUPPLY
PHONE: 330-821-6342



86050

86052

86053

86057

86058

86060

6 X 1-1/4

8 X 1

8 X 1-1/4

10 X 1

10 X 1-1/4

1/4 X 1

50

50

50

50

50

50









J&B Fleet - Industrial Supply

22428 Harrisburg-Westville Rd. Alliance, Ohio 44601 Phone: (330) 821-6342 Fax: (330) 821-0411

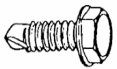
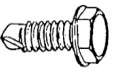
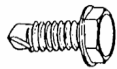
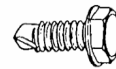
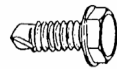
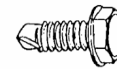
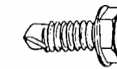
www.jbfleet.com

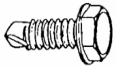
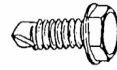
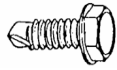
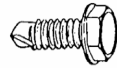
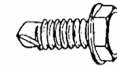
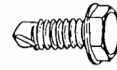
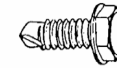
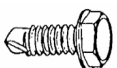
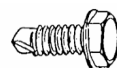
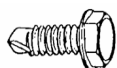
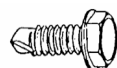
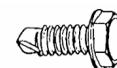
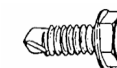
PART #2229

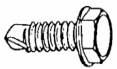
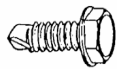
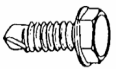
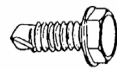
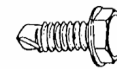
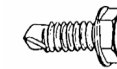
TEKS TAPPING SCREWS

 41386 ¹ 6-20 X 3/8 25	 41387 ² 6-20 X 1/2 25	 41388 ³ 6-20 X 3/4 25	 41389 ⁴ 6-20 X 1 25	 12920 ⁵ 8-18 X 1/2 25	 37530 ⁶ 8-18 X 5/8 25	 12921 ⁷ 8-18 X 3/4 25	 12922 ⁸ 8-18 X 1 25
 41385 ⁹ 8-18 X 1-1/4 10	 37531 ¹⁰ 8-18 X 1-1/2 10	 41391 ¹¹ 8-18 X 2 10	 12923 ¹³ 10-16 X 1/2 25	 37532 ¹⁴ 10-16 X 5/8 25	 12924 ¹⁵ 10-16 X 3/4 25	 12925 ¹⁶ 10-16 X 1 15	
 37534 ¹⁷ 10-16 X 1-1/4 10	 12698 ¹⁸ 10-16 X 1-1/2 10	 41392 ¹⁹ 10-16 X 2 10	 41370 ²¹ 12-14 X 3/4 25	 41371 ²² 12-14 X 1 15	 41372 ²³ 12-14 X 1-1/4 10	 41373 ²⁴ 12-14 X 1-1/2 10	
 41395 ²⁵ 12-14 X 2 10	 12926 ²⁷ 1/4-14 X 3/4 10	 12927 ²⁸ 1/4-14 X 1 10	 37535 ²⁹ 1/4-14 X 1-1/4 10	 12929 ³⁰ 1/4-14 X 1-1/2 10	 41375 ³¹ 1/4-14 X 2 10	 12928 ³² 1/4-14 X 2 10	





J&B Fleet - Industrial Supply

22428 Harrisburg-Westville Rd. Alliance, Ohio 44601 Phone: (330) 821-6342 Fax: (330) 821-0411















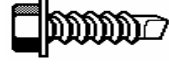

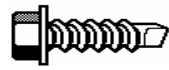
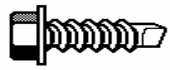
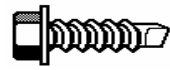



www.jbfleet.com

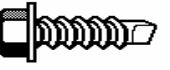

PART # 2132

TEK TAPPING SCREWS

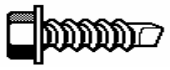
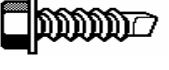

<p>12920 ¹</p>  <p>8-18 X 1/2</p> <p>25</p>	<p>37530 ²</p>  <p>8-18 X 5/8</p> <p>25</p>	<p>12921 ³</p>  <p>8-18 X 3/4</p> <p>25</p>	<p>12922 ⁴</p>  <p>8-18 X 1</p> <p>25</p>	<p>41385 ⁵</p>  <p>8-18 X 1-1/4</p> <p>10</p>	<p>37531 ⁶</p>  <p>8-18 X 1-1/2</p> <p>10</p>
<p>12923 ⁷</p>  <p>10-16 X 1/2</p> <p>25</p>	<p>37532 ⁸</p>  <p>10-16 X 5/8</p> <p>25</p>	<p>12924 ⁹</p>  <p>10-16 X 3/4</p> <p>25</p>	<p>12925 ¹⁰</p>  <p>10-16 X 1</p> <p>15</p>	<p>37534 ¹¹</p>  <p>10-16 X 1-1/4</p> <p>10</p>	<p>12698 ¹²</p>  <p>10-16 X 1-1/2</p> <p>10</p>
<p>41387 ¹³</p>  <p>6-20 X 1/2</p> <p>25</p>	<p>41388 ¹⁴</p>  <p>6-20 X 3/4</p> <p>25</p>	<p>41370 ¹⁵</p>  <p>12-14 X 3/4</p> <p>25</p>	<p>41371 ¹⁶</p>  <p>12-14 X 1</p> <p>15</p>	<p>41372 ¹⁷</p>  <p>12-14 X 1-1/4</p> <p>10</p>	<p>41373 ¹⁸</p>  <p>12-14- X 1-1/2</p> <p>10</p>
<p>¹⁹</p>  <p>1/4-14 X 3/4</p> <p>15</p>	<p>12926 ²⁰</p>  <p>1/4-14 X 3/4</p> <p>15</p>	<p>12927 ²¹</p>  <p>1/4-14 X 1</p> <p>10</p>	<p>37535 ²²</p>  <p>1/4-14 X 1-1/4</p> <p>10</p>	<p>12929 ²³</p>  <p>1/4-14 X 1-1/2</p> <p>10</p>	<p>41375 ²⁴</p>  <p>1/4-14 X 2</p> <p>10</p>

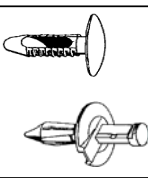

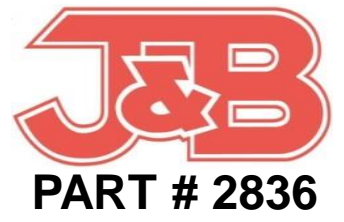
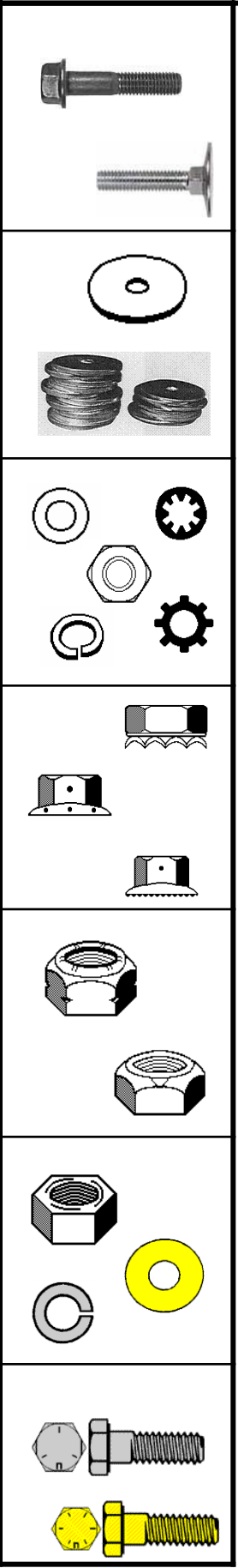
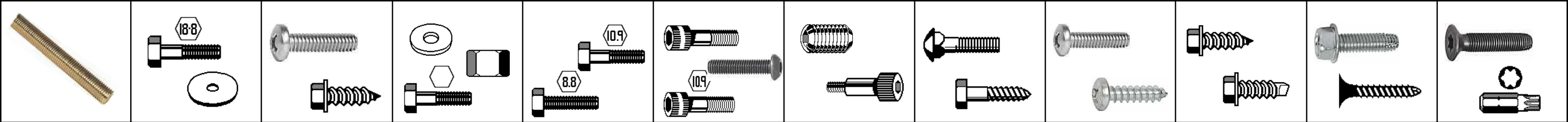

























J&B Fleet - Industrial Supply
 22428 Harrisburg-Westville Rd. Alliance, Ohio 44601 Phone: (330) 821-6342 Fax: (330) 821-0411

www.jbfleet.com

HEX HEAD & PHILLIPS TEK SCREWS

 12920 ¹ 25 8 X 1/2"	 12922 ² 25 8 X 1"	 37531 ³ 10 8 X 1- 1/2"	 12923 ⁴ 25 10 X 1/2"	 12925 ⁵ 25 10 X 1"	 12698 ⁶ 10 10 X 1-1/2"
 41370 ⁷ 25 12 X 3/4"	 41372 ⁸ 10 12 X 1-1/4"	 41395 ⁹ 10 12 X 2"	 12927 ¹⁰ 25 1/4" X 1"	 12929 ¹¹ 10 1/4" X 1-1/2"	 41376 ¹² 10 1/4 X 2-1/2"
 12919 ¹³ 25 8 X 1/2"	 13283 ¹⁴ 25 8 X 3/4"	 37540 ¹⁵ 25 8 X 1"	 37541 ¹⁶ 10 8 X 1-1/4"	 37542 ¹⁷ 10 8 X 1-1/2"	 41401 ¹⁸ 25 10 X 1/2"
 41402 ¹⁹ 25 10 X 3/4"	 41403 ²⁰ 25 10 X 1"	 37544 ²¹ 10 10 X 1-1/4"	 37545 ²² 10 10 X 1-1/2"	 37546 ²³ 25 12 X 1"	 37547 ²⁴ 10 12 X 1- 1/2"



LET US HELP YOU MAKE THE CONNECTION

PART # 3019



TEK SCREWS



J & B FLEET-INDUSTRIAL SUPPLY
PHONE: 330-821-6342



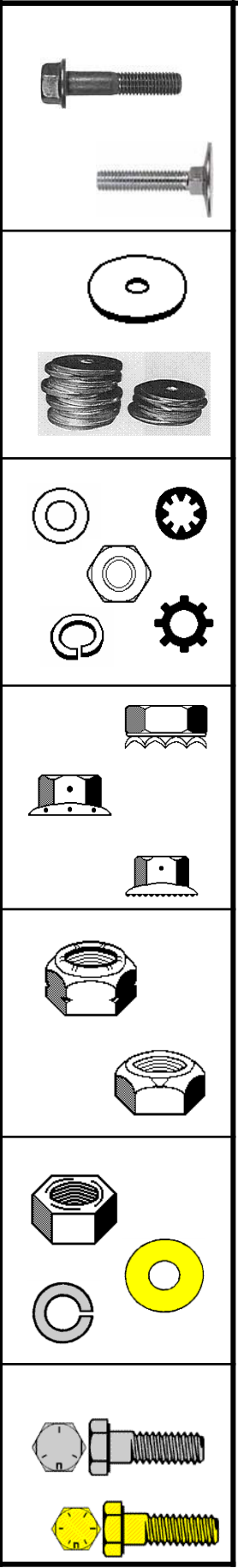
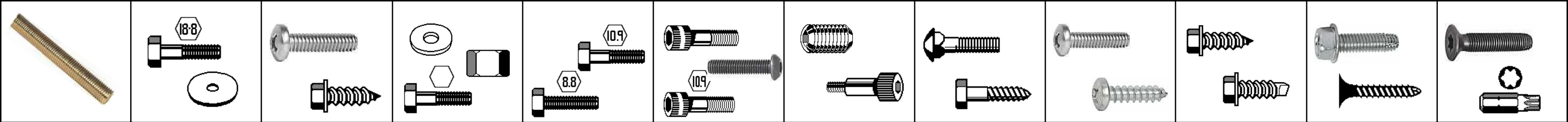





















12922	12924	12925	37534	12927	12929
8-18 X 1"	10-16 X 3/4	10-16 X 1"	10-16 X 1-1/4	1/4-14 X 1"	1/4-14 X 1-1/2
25	25	25	10	10	10



J&B Fleet - Industrial Supply
 22428 Harrisburg-Westville Rd. Alliance, Ohio 44601 Phone: (330) 821-6342 Fax: (330) 821-0411

www.jbfleet.com

HEX HEAD & PHILLIPS TEK SCREWS

 12920 ¹ 25 8 X 1/2"	 12922 ² 25 8 X 1"	 37531 ³ 10 8 X 1- 1/2"	 12923 ⁴ 25 10 X 1/2"	 12925 ⁵ 25 10 X 1"	 12698 ⁶ 10 10 X 1-1/2"
 41370 ⁷ 25 12 X 3/4"	 41372 ⁸ 10 12 X 1-1/4"	 41395 ⁹ 10 12 X 2"	 12927 ¹⁰ 25 1/4" X 1"	 12929 ¹¹ 10 1/4" X 1-1/2"	 41376 ¹² 10 1/4 X 2-1/2"
 12919 ¹³ 25 8 X 1/2"	 13283 ¹⁴ 25 8 X 3/4"	 37540 ¹⁵ 25 8 X 1"	 37541 ¹⁶ 10 8 X 1-1/4"	 37542 ¹⁷ 10 8 X 1-1/2"	 41401 ¹⁸ 25 10 X 1/2"
 41402 ¹⁹ 25 10 X 3/4"	 41403 ²⁰ 25 10 X 1"	 37544 ²¹ 10 10 X 1-1/4"	 37545 ²² 10 10 X 1-1/2"	 37546 ²³ 25 12 X 1"	 37547 ²⁴ 10 12 X 1- 1/2"



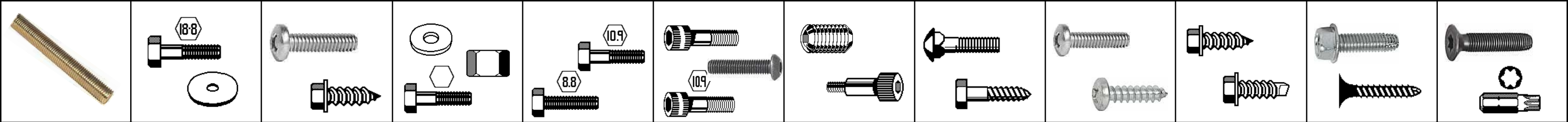

























J&B Fleet - Industrial Supply

www.jbfleet.com

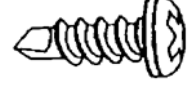
22428 Harrisburg-Westville Rd. Alliance, Ohio 44601 Phone: (330) 821-6342 Fax: (330) 821-0411

PART # 2221

PHILLIPS TEKS SCREWS

 41404 ¹ 6-20 X 3/8 25	 41405 ² 6-20 X 1/2 25	 37536 ³ 6-20 X 5/8 25	 37537 ⁴ 6-20 X 3/4 25	 37538 ⁵ 6-20 X 1 25	 41400 ⁶ 8-18 X 3/8 25
 12919 ⁷ 8-18 X 1/2 25	 37539 ⁸ 8-18 X 5/8 25	 13283 ⁹ 8-18 X 3/4 25	 37540 ¹⁰ 8-18 X 1 25	 37541 ¹¹ 8-18 X 1-1/4 10	 37542 ¹² 8-18 X 1-1/2 10
 41401 ¹³ 10-16 X 1/2 25	 37543 ¹⁴ 10-16 X 5/8 25	 41402 ¹⁵ 10-16 X 3/4 25	 41403 ¹⁶ 10-16 X 1 15	 37544 ¹⁷ 10-16 X 1-1/4 10	 37545 ¹⁸ 10-16 X 1-1/2 10
 37548 ¹⁹ 12-14 X 3/4 15	 37546 ²⁰ 12-14 X 1 15	 37547 ²¹ 12-14 X 1-1/2 10	 41429 ²² 12-14 X 2 10	 41433 ²³ 1/4-14 X 1 10	 41434 ²⁴ 1/4-14 X 1-1/2 10

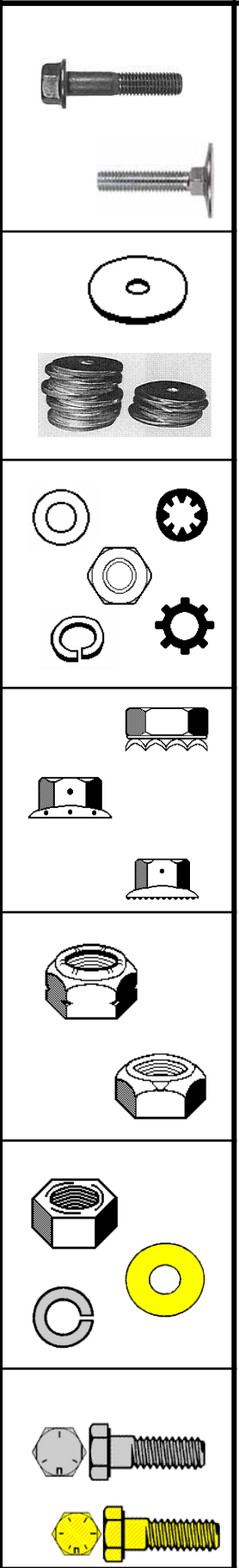

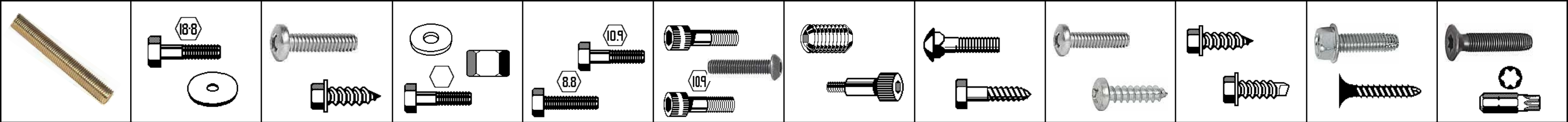











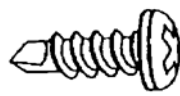









J&B Fleet - Industrial Supply

www.jbfleet.com

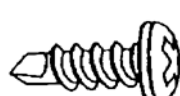
22428 Harrisburg-Westville Rd. Alliance, Ohio 44601 Phone: (330) 821-6342 Fax: (330) 821-0411

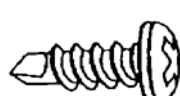
PART # 2221

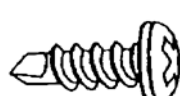
PHILLIPS TEKS SCREWS

<p>41404 ¹</p>  <p>6-20 X 3/8</p> <p>25</p>	<p>41405 ²</p>  <p>6-20 X 1/2</p> <p>25</p>	<p>37536 ³</p>  <p>6-20 X 5/8</p> <p>25</p>	<p>37537 ⁴</p>  <p>6-20 X 3/4</p> <p>25</p>	<p>37538 ⁵</p>  <p>6-20 X 1</p> <p>25</p>	<p>6</p>
<p>41400 ⁷</p>  <p>8-18 X 3/8</p> <p>25</p>	<p>12919 ⁸</p>  <p>8-18 X 1/2</p> <p>25</p>	<p>37539 ⁹</p>  <p>8-18 X 5/8</p> <p>25</p>	<p>13283 ¹⁰</p>  <p>8-18 X 3/4</p> <p>25</p>	<p>37540 ¹¹</p>  <p>8-18 X 1</p> <p>25</p>	<p>12</p>
<p>37541 ¹³</p>  <p>8-18 X 1-1/4</p> <p>10</p>	<p>37542 ¹⁴</p>  <p>8-18 X 1-1/2</p> <p>10</p>	<p>41401 ¹⁵</p>  <p>10-16 X 1/2</p> <p>25</p>	<p>37543 ¹⁶</p>  <p>10-16 X 5/8</p> <p>25</p>	<p>41402 ¹⁷</p>  <p>10-16 X 3/4</p> <p>25</p>	<p>18</p>
<p>41403 ¹⁹</p>  <p>10-16 X 1</p> <p>15</p>	<p>37544 ²⁰</p>  <p>10-16 X 1-1/4</p> <p>10</p>	<p>37545 ²¹</p>  <p>10-16 X 1-1/2</p> <p>10</p>	<p>37548 ²²</p>  <p>12-14 X 3/4</p> <p>15</p>	<p>37546 ²³</p>  <p>12-14 X 1</p> <p>15</p>	<p>37547 ²⁴</p>  <p>12-14 X 1-1/2</p> <p>10</p>

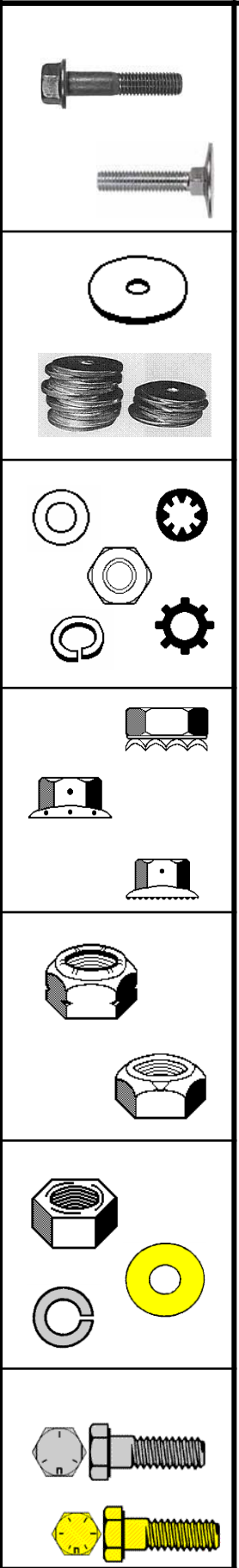

LET US HELP YOU MAKE THE CONNECTION

PART # 3048

PHILLIPS TEKS SCREWS



J & B FLEET-INDUSTRIAL SUPPLY
PHONE: 330-821-6342



41405	12919	13283	41402	41403	37544
6 X 1/2	8 X 1/2	8 X 3/4	10 X 3/4	10 X 1	10 X 1-1/4
25	25	25	25	25	10

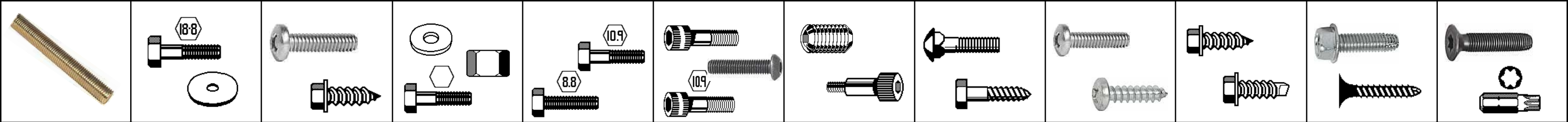

























J&B Fleet - Industrial Supply

22428 Harrisburg-Westville Rd. Alliance, Ohio 44601 Phone: (330) 821-6342 Fax: (330) 821-0411

www.jbfleet.com

PART# 2814

BLACK SHEET METAL SCREWS

<p>41843 ¹</p>  <p>M4.2 - 1.41 X 20MM HEX HD SMS</p> <p>25</p>	<p>41844 ²</p>  <p>M4.2 - 1.41 X 20MM HEX SMS TEKS</p> <p>25</p>	<p>41880 ³</p>  <p>M4.2 - 1.41 X 20MM HEX HD SMS</p> <p>25</p>	<p>42006 ⁴</p>  <p>M6.3 - 1.81 X 20MM HEX HD SMS</p> <p>10</p>	<p>45816 ⁵</p>  <p>M6.3 - 1.81 X 25MM HEX HD SMS</p> <p>10</p>	<p>4020 ⁶</p>  <p>SMS PHIL 8 X 1/2</p> <p>25</p>
<p>13447 ⁷</p>  <p>SMS PHIL 8 X 3/4</p> <p>25</p>	<p>13420 ⁸</p>  <p>SMS PHIL 8 X 1</p> <p>25</p>	<p>4021 ⁹</p>  <p>SMS PHIL 8 X 1-1/2</p> <p>25</p>	<p>4022 ¹⁰</p>  <p>SMS PHIL 10 X 1/2</p> <p>25</p>	<p>4023 ¹¹</p>  <p>SMS PHIL 10 X 3/4</p> <p>25</p>	<p>45806 ¹²</p>  <p>SMS PHIL 10 X 1</p> <p>25</p>
<p>4024 ¹³</p>  <p>SMS PHIL 10 X 1-1/4</p> <p>25</p>	<p>42062 ¹⁴</p>  <p>TAPPING SCREW 8 X 1/2</p> <p>25</p>	<p>4026 ¹⁵</p>  <p>TAPPING SCREW 8 X 5/8</p> <p>25</p>	<p>42002 ¹⁶</p>  <p>TAPPING SCREW 8 X 3/4</p> <p>25</p>	<p>45812 ¹⁷</p>  <p>TAPPING SCREW 8 X 1</p> <p>25</p>	<p>4027 ¹⁸</p>  <p>TAPPING SCREW 8 X 1-1/4</p> <p>25</p>
<p>45824 ¹⁹</p>  <p>TAPPING SCREW 10 X 3/4</p> <p>25</p>	<p>4028 ²⁰</p>  <p>TAPPING SCREW 10 X 1</p> <p>25</p>	<p>4029 ²¹</p>  <p>TAPPING SCREW 10 X 1-1/4</p> <p>25</p>	<p>45828 ²²</p>  <p>TAPPING SCREW 8 X 3/4</p> <p>25</p>	<p>45846 ²³</p>  <p>TAPPING SCREW 8 X 1/2</p> <p>25</p>	<p>40915 ²⁴</p>  <p>TAPPING SCREW 8 X 3/4</p> <p>25</p>

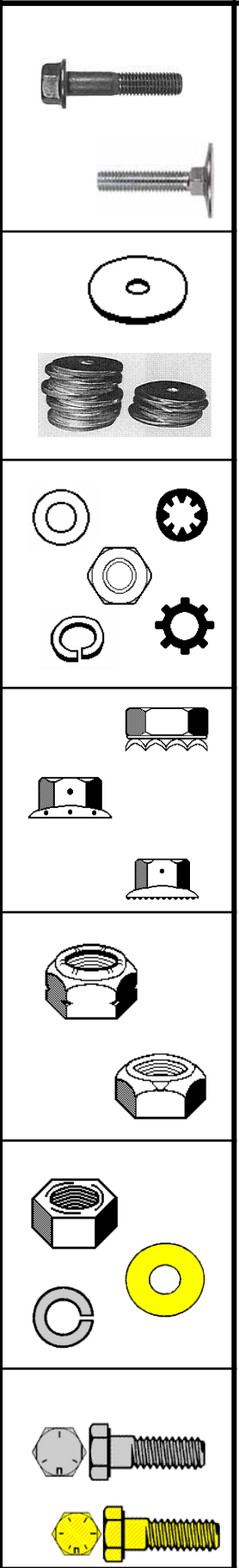



J&B Fleet - Industrial Supply









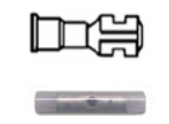

www.jbfleet.com

22428 Harrisburg-Westville Rd. Alliance, Ohio 44601 Phone: (330) 821-6342 Fax: (330) 821-0411

PART # 2249

TEK SCREW NEO WASHER



<p>39021 1</p>  <p>8-18 X 3/4" 1/4" SOCKET</p> <p>50</p>	<p>39024 2</p>  <p>10-16 X 3/4" 5/16" SOCKET</p> <p>50</p>	<p>39025 3</p>  <p>10-16 X 1" 5/16" SOCKET</p> <p>50</p>
<p>39033 4</p>  <p>12-14 X 3/4" 5/16" SOCKET</p> <p>25</p>	<p>39034 5</p>  <p>12-14 X 1" 5/16" SOCKET</p> <p>25</p>	<p>39035 6</p>  <p>12-14 X 1-1/4" 5/16" SOCKET</p> <p>25</p>
<p>39036 7</p>  <p>12-14 X 1-1/2" 5/16" SOCKET</p> <p>25</p>	<p>39053 8</p>  <p>1/4"-14 X 3/4" 3/8" SOCKET</p> <p>25</p>	<p>39054 9</p>  <p>1/4"-14 X 1" 3/8" SOCKET</p> <p>25</p>
<p>39055 10</p>  <p>1/4"-14 X 1-1/4" 3/8" SOCKET</p> <p>25</p>	<p>39056 11</p>  <p>1/4"-14 X 1-1/2" 3/8" SOCKET</p> <p>25</p>	<p>12</p>

LET US HELP YOU MAKE THE CONNECTION

PART # 3046

SCREWDRIVER BITS



J & B FLEET-INDUSTRIAL SUPPLY
PHONE: 330-821-6342

38421 1/4 WAF (#8 SCREW) HEX CHUCK 1	38422 5/16 WAF (#10 SCREW) HEX CHUCK 1	38423 3/8 WAF (1/4 SCREW) HEX CHUCK 1	39482 #2 SHORT SQUARE BIT 1	39483 # 2 LONG SQUARE BIT 1	39484 #2 POZI DRIVE 2
39485 # 1 PHILLIPS 2	39486 # 2 PHILLIPS 2	39480 T—30 (1/4 SCREW) TORX 1	39481 T—40 (5/16 SCREW) TORX 1	39487 8F—10R SLOTTED BIT 2	







































J&B Fleet - Industrial Supply

22428 Harrisburg-Westville Rd. Alliance, Ohio 44601 Phone: (330) 821-6342 Fax: (330) 821-0411

www.jbfleet.com

PART # 2868

SCREWDRIVING BITS

 38421 HEX 1/4 WAF		 38422 HEX 5/16 WAF		 38423 HEX 3/8 WAF		 39579 HEX 7/16 WAF		 39580 HEX 1/2 WAF							
 39520 PH #2 1/4 H	 39521 PH #3 1/4 H	 39578 PH #2 5/16 H	 39522 PH #3 5/16 H	 39485 PH #1 1-5/16 L	 39576 PH #1 2-3/4 L	 39486 PH #2 1-5/16 L	 39479 PH #2 2-3/4 L								
 39478 PH #2 6" L				 39488 PH #3 1-5/16 L		 39577 PH #3 2-3/4 L		 39519 PH #3 6" L							
 39487 SLOT 1-15/16"		 39482 SQ #2 1" LG		 39483 SQ #2 2" LG		 39570 SQ #2 3" LG		 39518 SQ #2 6" LG							
 39523 T-40 TORX 5/16		 39575 T-45 TORX 5/16		 39581 T-50 TORX 5/16		 39582 T-55 TORX 5/16		 39566 MAG BIT HOLD		 39484 POZI #2 1" L		 39583 SQ #3 2" LG			
 39587 T-10 TORX 1/4H		 39588 T-15 TORX 1/4H		 39571 T-20 TORX 1/4H		 39572 T-25 TORX 1/4H		 39573 T-27 TORX 1/4H		 39480 T-30 TORX 1/4H		 39574 T-30 TORX 5/16		 39481 T-40 TORX 1/4H	

