



PLANTERS



INTELLIGENT OFFICE FURNITURE



PLANTERS

Bring life into your workspaces with our selection of custom office planters. Indoor office planters will invoke your employees and patron's true connection with nature and assist in creating a warm and welcoming workspace that will lift spirits, boost company moral and reduce feelings of tension and fatigue. Our curated selection of planters was designed to complement and accentuate office spaces of all kinds to give your spaces a seamless and natural design.

MOUNTED PANEL



PLANTER #1



WIDE

PLANTER #2

STORAGE



PLANTER #3

MEDIA



PLANTER #4



ORGANIZER

PLANTER #5

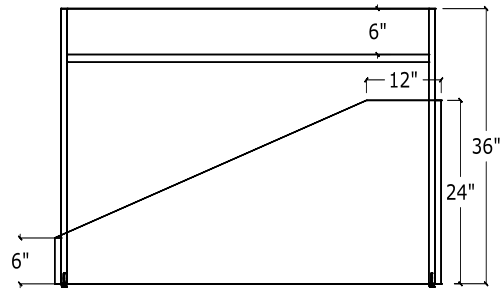
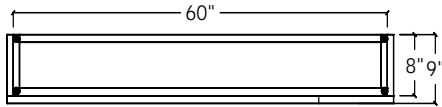

Planter #1

| ITEM | QTY | Code | DESCRIPTION | LIST | EXT LIST |
|------|-----|-------|------------------------------------|--------------|----------------|
| A | 1 | W#001 | CUSTOM PLANTER - 60"W X 9"D X 36"H | \$1,325 | \$1,325 |
| | | | | TOTAL | \$1,325 |

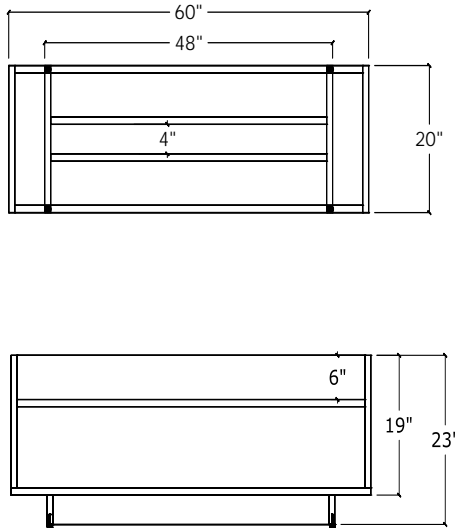

ARTIFICIAL PLANTS RECOMMENDED

Planter #2

| ITEM | QTY | Code | DESCRIPTION | LIST | EXT LIST |
|------|-----|-------|-------------------------------------|--------------|----------------|
| A | 1 | W#001 | CUSTOM PLANTER - 60"W X 20"D X 23"H | \$1,735 | \$1,735 |
| | | | | TOTAL | \$1,735 |

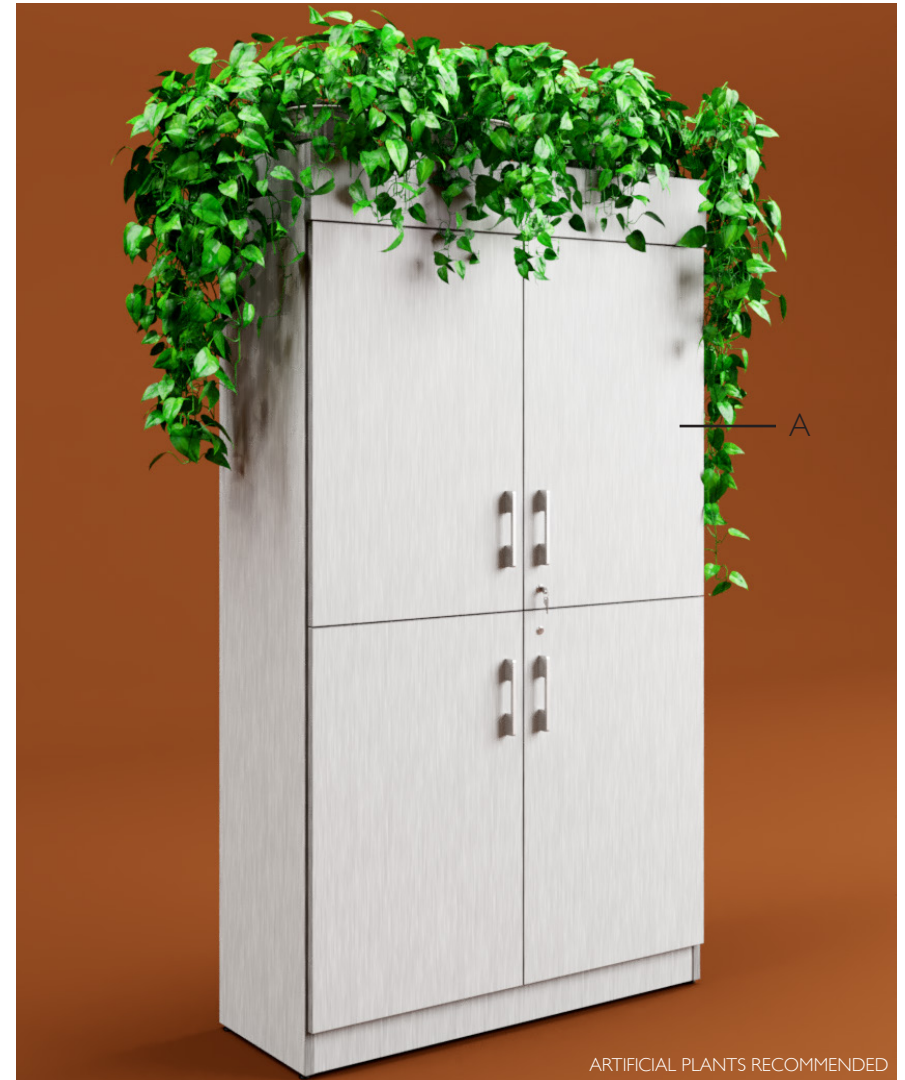
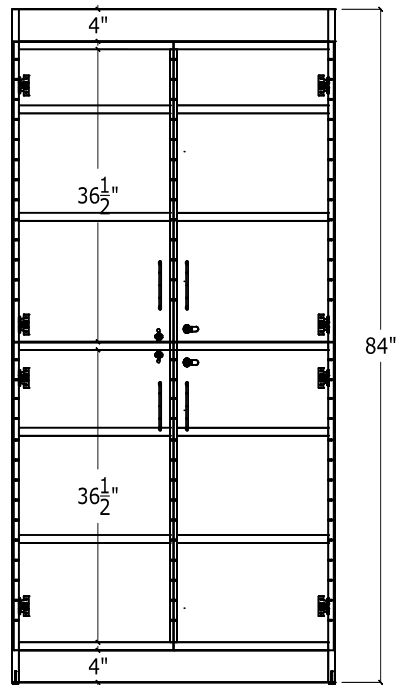
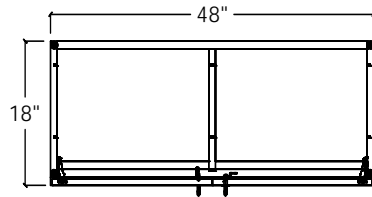

Planter #3

| ITEM | QTY | Code | DESCRIPTION | LIST | EXT LIST |
|------|-----|-------|---|--------------|----------------|
| A | 1 | W#001 | CUSTOM STORAGE PLANTER - 48"W X 18"D X 84"H | \$2,415 | \$2,415 |
| | | | | TOTAL | \$2,415 |

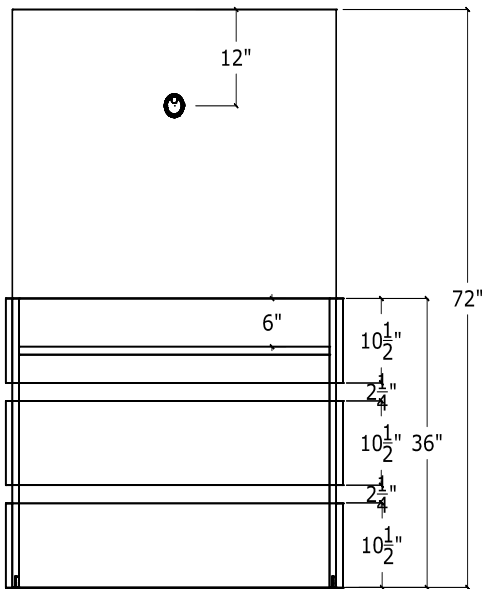
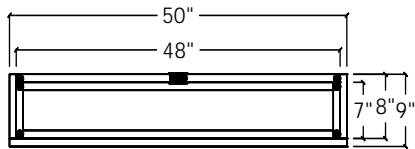

Planter #4

| ITEM | QTY | Code | DESCRIPTION | LIST | EXT LIST |
|------|-----|-------|---|--------------|----------------|
| A | 1 | W#001 | CUSTOM PLANTER - 50"W X 9"D X 36"H | \$1,550 | \$1,550 |
| B | 1 | W#002 | CUSTOM LAMINATE PANEL - 48"W X 1"D X 72"H | \$547 | \$547 |
| | | | | TOTAL | \$2,097 |

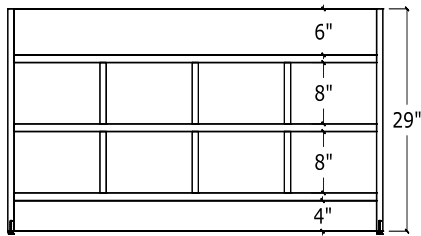
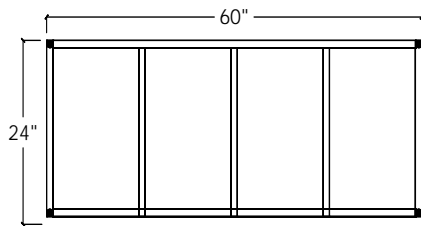

ARTIFICIAL PLANTS RECOMMENDED

Planter #5

| ITEM | QTY | Code | DESCRIPTION | LIST | EXT LIST |
|------|-----|-------|-------------------------------------|--------------|----------------|
| A | 1 | W#001 | CUSTOM PLANTER - 60"W X 24"D X 29"H | \$1,885 | \$1,885 |
| | | | | TOTAL | \$1,885 |

Didn't find what you were looking for? See below for more even more planter options or contact your IOF sales rep to design your own!

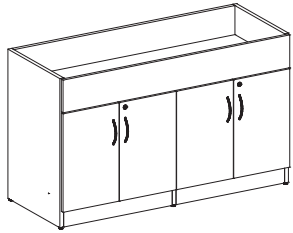

A

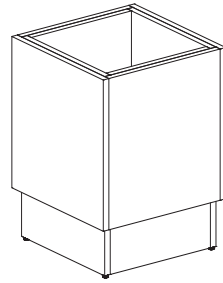

B

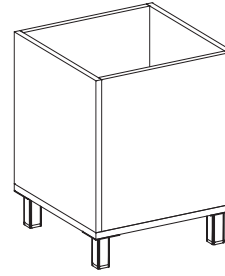

C

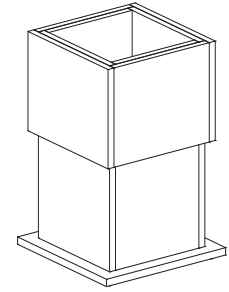

D

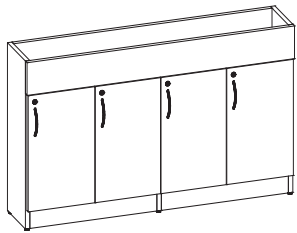

E

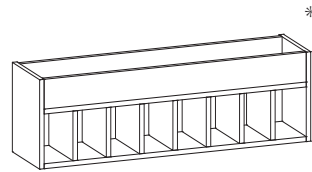

F

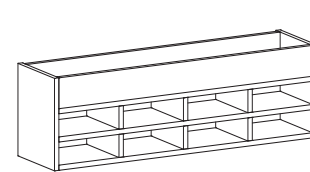

G

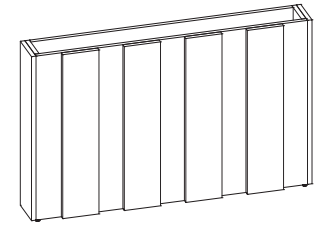

H

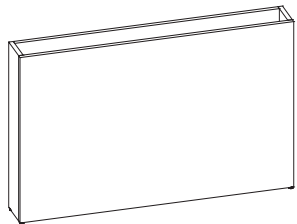

I

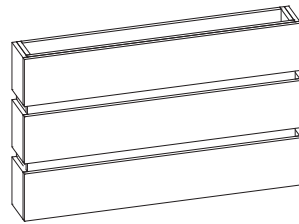

J

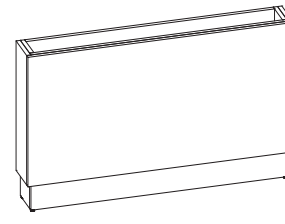

K

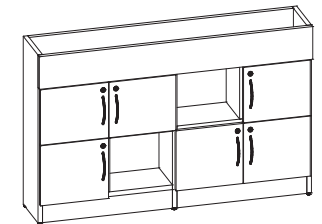

L

NOTES

- * Wall mounted planter
- Plants not included.
- IOF does not include fillers or liners with our planters.
- IOF does not recommend the use of live plants, water damage will not be covered under our warranty.



WWW.IOFLIVE.COM