

ABRASIVE PRODUCTS

GRINDING WHEELS

Reinforced Wheels Depressed Center

FOR USE ON RIGHT
ANGLE GRINDERS



- Aluminum oxide abrasive with a resin bond reinforced by layers of durable fabric to provide wheels of maximum strength and safety.
- **Fast cutting** flexible, extremely durable, and economical.

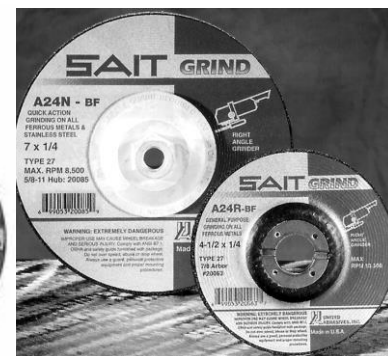

J&B #	MFG #	SIZE	ARBOR	MATERIAL	MAX RPM	QTY	CASE
~ 39061	20015	4 x 1/4	5/8 hole	A24N	13,500	EA	25
~ 38864	20163	4-1/2 x 1/4	5/8-11 nut	A24R	13,300	EA	10
* 49115	A1226H	4-1/2 x 1/4	5/8-11 nut	A24/30T	13,300	EA	10
* V41990	A1203H	4-1/2 x 1/4	5/8-11 nut	A24ALU	13,300	EA	10
* 38865	A1236	4-1/2 x 1/4	7/8 hole	A24T	13,300	EA	25
* V41991	A1203	4-1/2 x 1/4	7/8 hole	A24ALU	13,300	EA	25
~ 38866	20070	5 x 1/4	7/8 hole	A24N	12,200	EA	25
* V20097	A3236	6 x 1/4	7/8 hole	A30N	10,000	EA	25
~ 20098	20086	7 x 1/4	5/8-11 nut	A24R	8,500	EA	10
~ 20146	20195	9 x 1/4	5/8-11 nut	A24T	6,600	EA	10

* = Flexovit Brand ~ = Sait Brand

GENERAL PURPOSE - METAL - FAST CUT (A24N):

- Aggressive grinding with excellent life.
- Grinds aggressively in a wide range of metal applications, including harder materials.
- Aluminum oxide grain. Soft bond for fast stock removal.

HIGH PERFORMANCE - METAL - LONG LIFE (A24R):

- Smooth grinding with maximum life for an aluminum oxide wheel.
- Weld grinding, surface conditioning, notching, cutting, and all general purpose stock removal.
- The standard for long life in metal work.

EDGE GRINDING - METAL - LONG LIFE (A24T):

- Aluminum oxide grain.
- Hard bond designed for edge & bevel grinding & other applications where a harder wheel is preferred.
- Ferrous metals (iron, steel, welds, etc.)

ALUMINUM - LOAD RESISTANT - (A24ALU)

- Ideal for grinding aluminum and nonferrous materials.

ABRASIVE PRODUCTS

GRINDING WHEELS

FOR USE ON BENCH & PEDESTAL MACHINES



- ALUMINUM OXIDE for metal grinding carbon, stainless or alloys.
- Runs cool for long grinding life; maintains shape.
- May be used for general purpose grinding or finishing and sharpening.

J&B #	MFG #	SIZE	ARBOR	NESTED BUSHINGS	STYLE	GRIT	MAX RPM	QTY
39030	U4730	6 x 1	1	1/2, 5/8, 3/4	MED/FN	A60	4,138	EA
38460	U4710	6 x 1	1	1/2, 5/8, 3/4	COARSE	A24	4,138	EA
39032	U5130	8 x 1	1-1/4	1/2, 5/8, 3/4, 1	MED/FN	A60	3,600	EA
38462	U5110	8 x 1	1-1/4	1/2, 5/8, 3/4, 1	COARSE	A24	3,600	EA

BENCH WHEEL DRESSER

- Designed to true bench wheels to correct shape.
- Quickly remove foreign material embedded in the face of the wheel.

J&B #	DIAMETER	THICKNESS	QTY
39127	Up to 10"	Up to 2"	EA
39128	Replacement Cutter		EA

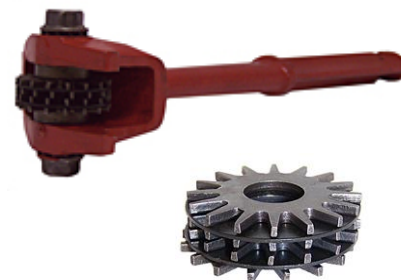

RESIN FIBER ABRASIVE DISCS

Closed Coat

FOR USE ON RIGHT ANGLE GRINDERS



- Closed coat structure for more material removal & better finishing.
- Use for grinding mild steel or stainless, weld preparation, or blending and finishing.

J&B #	MFG #	SIZE	GRIT	QTY
41410	32218	4-1/2 x 7/8	50	25
41412	32220	4-1/2 x 7/8	80	25
*38963	32231	5 x 7/8	24	25
41416	32232	5 x 7/8	36	25
41418	32234	5 x 7/8	60	25
41419	32235	5 x 7/8	80	25
41421	32237	5 x 7/8	120	25

J&B #	MFG #	SIZE	GRIT	QTY
*38965	32246	7 x 7/8	24	25
*38967	S4010G	9 x 7/8	24	25

* These items are sold in box quantities only.

ABRASIVE PRODUCTS

CHALLENGER II GRINDING WHEELS

Semi-Flexible Wheels
ALUMINUM / STAINLESS / METAL

FOR USE ON RIGHT ANGLE GRINDERS



MUST BE USED AT A
MINIMUM 15° ANGLE
- DO NOT USE FLAT -



- Eliminate wheel-change downtime by grinding and finishing with the same wheel.
- **Challenger II** performs well in all metal fabrication applications.
- **Challenger II** runs virtually LOAD-FREE.
- **Challenger II** tackles stainless and hard alloy applications without glazing or dulling.
- Great for Metal, Stainless, or Aluminum.

J&B #	MFG #	SIZE	TYPE	ARBOR	GRIT	MAX RPM	QTY
*42200	27501	4-1/2 x 1/8	29	7/8 hole	60	13,280	EA

25 in a case

* Use backing pad part # 95245 from United Abrasives.



Type 29

ABRASIVE PRODUCTS

ZIRCOTEX PREMIUM FLAP DISCS

Fiberglass Backing Plate

FOR USE ON ANGLE GRINDERS



- Made with premium zirconia alumina abrasive cloth backed by a high strength fiberglass disc.
- Ideal for high production grinding, blending, deburring and finishing.
- Perform well on a wide variety of materials including stainless & carbon steel.
- Durable grain resists loading or clogging on softer materials such as aluminum, brass, bronze & fiberglass.
- The fanned, abrasive cloth flaps wear evenly, constantly exposing new, sharp grain allowing for full use of the disc



J&B #	MFG #	SIZE	GRIT	TYPE	MAX RPM	QTY	CASE
45401	Z4501FH	4-1/2 x 5/8-11	24	29	13,300	EA	10
45402	Z4500FH	4-1/2 x 5/8-11	40	29	13,300	EA	10
45416	Z4505FH	4-1/2 x 5/8-11	60	29	13,300	EA	10
45500	Z4510FH	4-1/2 x 5/8-11	80	29	13,300	EA	10
45422	Z4525F	4-1/2 x 7/8	24	27	13,300	EA	10
45406	Z4530F	4-1/2 x 7/8	40	27	13,300	EA	10
45398	Z4535F	4-1/2 x 7/8	60	27	13,300	EA	10
45408	Z4540F	4-1/2 x 7/8	80	27	13,300	EA	10
47005	Z4545F	4-1/2 x 7/8	120	27	13,300	EA	10
45412	Z4500F	4-1/2 x 7/8	40	29	13,300	EA	10
45409	Z4505F	4-1/2 x 7/8	60	29	13,300	EA	10
45420	Z4510F	4-1/2 x 7/8	80	29	13,300	EA	10

SAIT ENCORE FLAP DISC

Fiberglass Backing Plate

- Heavy duty for long-life and high stock removal.
- Use on carbon and stainless steel, made with premium zirconium abrasive material which provides long-life & high stock removal.



J&B #	MFG #	SIZE	GRIT	TYPE	MAX RPM	QTY	CASE
45399	71205	4-1/2 x 7/8	36	27	13,300	EA	10
45400	71206	4-1/2 x 7/8	40	27	13,300	EA	10
49102	71208	4-1/2 x 7/8	60	27	13,000	EA	10

ABRASIVE PRODUCTS

TORNADO FLAP DISC

Nylon Backing

FOR USE ON ANGLE GRINDERS



- Nylon backing for easy, burn-free trimming.
- Safe & durable, vented for air cooling.
- Integrated, no strip thread –ready for mounting, no flange adaptor required.
- Premium zirconia cloth for high productivity.
- High performance & long life, resists loading & glazing.



Type 29

J&B #	MFG #	SIZE	GRIT	TYPE	MAX RPM	QTY	CASE
42201	Z4500NT	4-1/2 x 5/8-11	40	29	13,300	EA	10
42202	Z4505NT	4-1/2 x 5/8-11	60	29	13,300	EA	10
42203	Z4510NT	4-1/2 x 5/8-11	80	29	13,300	EA	10
42204	Z4520NT	4-1/2 x 5/8-11	120	29	13,300	EA	10

OVATION FLAP DISCS

Fiberglass Backing Plate

FOR USE ON ANGLE GRINDERS



- High pressure is ideal for removing deeper scratches from the work surface.
- Heavy duty / long life for tough applications.
- Premium zirconium grain on a tough, full polyester backing.
- Will not contaminate stainless steel.

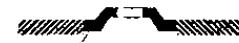

Type 27

J&B #	MFG #	SIZE	GRIT	TYPE	MAX RPM	QTY	CASE
59125	78036	6 x 7/8	40	27	10,200	EA	10

ABRASIVE PRODUCTS

OVATION ATTACKER PLUS

Plastic Backing

FOR USE ON ANGLE GRINDERS



- High performance zirconium grain for a wide variety of grinding and finishing applications.
- Provides long life while maintaining high stock removal rates.
- 40% more material than conventional, regular density flap discs.
- For Stainless steel, high tensile steel, titanium, ferrous metals, non-ferrous metals (aluminum, copper, brass, etc).



Type 27

J&B #	MFG #	SIZE	GRIT	TYPE	MAX RPM	QTY	CASE
V21515	72216	4-1/2 x 7/8	60	27	13,300	EA	10
V21522	72217	4-1/2 x 7/8	80	27	13,300	EA	10

OVATION CERAMIC PLUS

Plastic Backing

FOR USE ON ANGLE GRINDERS



- Premium ceramic grain outlasts conventional zirconium in most applications.
- Cooler cutting and fast, consistent finishes.
- 40% more material than conventional, regular density flap discs.
- For ferrous and/or non-ferrous metals, stainless steel and high tensile steel, titanium.



Type 27

J&B #	MFG #	SIZE	GRIT	TYPE	MAX RPM	QTY	CASE
V21500	72228	4-1/2 x 7/8	60	27	13,300	EA	10

ABRASIVE PRODUCTS

OVATION CERAMIC

FOR USE ON ANGLE GRINDERS



- Premium ceramic grain outlasts conventional Zirconium in most applications.
- Cooler cutting and fast consistent finishes.
- 40% more material than conventional, regular density flap discs.
- For Stainless steel, high tensile steel, titanium, ferrous metals, non-ferrous metals (aluminum, copper, brass, etc).



Type 27

J&B #	MFG #	SIZE	GRIT	TYPE	MAX RPM	QTY
V41424	78261	4-1/2 x 7/8	40	27	13,300	EA

CASE
10

ABRASIVE PRODUCTS

GRINDING WHEELS

FOR USE ON BENCH & PEDESTAL MACHINES



- ALUMINUM OXIDE for metal grinding carbon, stainless or alloys.
- Runs cool for long grinding life; maintains shape.
- May be used for general purpose grinding or finishing and sharpening.

J&B #	MFG #	SIZE	ARBOR	NESTED BUSHINGS	STYLE	GRIT	MAX RPM	QTY
39030	U4730	6 x 1	1	1/2, 5/8, 3/4	MED/FN	A60	4,138	EA
38460	U4710	6 x 1	1	1/2, 5/8, 3/4	COARSE	A24	4,138	EA
39032	U5130	8 x 1	1-1/4	1/2, 5/8, 3/4, 1	MED/FN	A60	3,600	EA
38462	U5110	8 x 1	1-1/4	1/2, 5/8, 3/4, 1	COARSE	A24	3,600	EA

BENCH WHEEL DRESSER

- Designed to true bench wheels to correct shape.
- Quickly remove foreign material embedded in the face of the wheel.

J&B #	DIAMETER	THICKNESS	QTY
39127	Up to 10"	Up to 2"	EA
39128	Replacement Cutter		EA

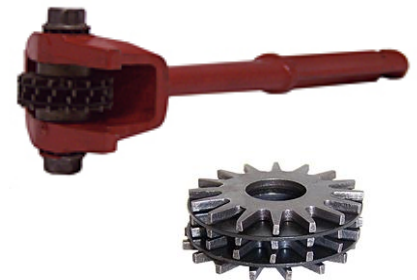

RESIN FIBER ABRASIVE DISCS

Closed Coat

FOR USE ON RIGHT ANGLE GRINDERS



- Closed coat structure for more material removal & better finishing.
- Use for grinding mild steel or stainless, weld preparation, or blending and finishing.

J&B #	MFG #	SIZE	GRIT	QTY
41410	32218	4-1/2 x 7/8	50	25
41412	32220	4-1/2 x 7/8	80	25
*38963	32231	5 x 7/8	24	25
41416	32232	5 x 7/8	36	25
41418	32234	5 x 7/8	60	25
41419	32235	5 x 7/8	80	25
41421	32237	5 x 7/8	120	25

J&B #	MFG #	SIZE	GRIT	QTY
*38965	32246	7 x 7/8	24	25
*38967	S4010G	9 x 7/8	24	25
^43426	66906	9 x 7/8	36	25

* These items are sold in box quantities only.
 ^ 43426 is 3M brand

ABRASIVE PRODUCTS

RESIN FIBER ABRASIVE DISCS

Open Coat

FOR USE ON RIGHT ANGLE GRINDERS



- Open coat structure prevents loading with fast material removal
- Use on ferrous and/or non-ferrous metals, wood and fiberglass.
- Discs come on handy dispenser to prevent bowing.

J&B #	MFG #	SIZE	GRIT	QTY
46439	52480	4-1/2 x 7/8	80	100
46438	52460	4-1/2 x 7/8	60	100
46437	52450	4-1/2 x 7/8	50	100
46436	52436	4-1/2 x 7/8	36	100
*46445	69226	4-1/2 x 7/8	36	100
46430	52750	7 x 7/8	50	100
46036	52736	7 x 7/8	36	100
46429	52724	7 x 7/8	24	50
46440	52716	7 x 7/8	16	100

- Cannot break box quantities -

* Part# 46445 is a closed coat zirconia alumina abrasive material on an X-weight, water resistant polyester/cotton blended backing. For general purpose grinding and finishing on ferrous and non-ferrous metals, cast iron, aluminum, stainless steel and wood materials.

SPIRALCOOL BACKING PAD

- Spiralcool backing pads exclusive rubber, fabric and fiber board construction provide extra strength and reliability.
- Spiral ribs provide contact points and form channels for air flow extending disc life 30% to 50%.



J&B #	MFG #	SIZE	ARBOR	GRADE	MAX RPM	QTY
41959	95011	4-1/2"	5/8	HARD	11,000	EA
41983	95016	5"	5/8	MEDIUM	10,000	EA
41972	95018	7"	5/8-11	MEDIUM	8,500	EA

ABRASIVE PRODUCTS

ULTIMATE CUT CUT-OFF WHEELS

FOR USE ON RIGHT ANGLE GRINDERS



- Best in class – cutting a wide range of stainless thin & thick gauge, flat stock, bar stock, square tubing, etc.
- Exceptional cutting performance on metal & aluminum.
- Maximizes productivity.

J&B #	MFG #	SIZE			TYPE	MAX RPM	QTY
		DIA	THK	ARBOR			
49106	23152	3	.035	1/4	1	25,000	10
38464	22230	4-1/2	.045	7/8	1	13,300	10
38466	22240	6	.045	7/8	1	10,200	10

NOTE: CUT-OFF WHEELS ARE FOR USE ON RIGHT ANGLE GRINDERS EQUIPPED WITH PROPER TYPE 1 FLANGES. DO NOT USE WITH TYPE 27 STYLE FLANGES.

J&B #	DESCRIPTION	QTY
41407	TYPE 1, ADAPTER FLANGE	EA

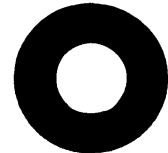

ALUMINUM CUT-OFF WHEELS

FOR USE ON RIGHT ANGLE GRINDERS



- For cutting non-ferrous metals...aluminum, copper, brass, etc. Made of aluminum oxide grain.
- Soft bond for aggressive cutting without loading.
- Use with reusable 5/8-11 adapter to fit angle grinders.

J&B #	MFG #	SIZE			TYPE	MAX RPM	QTY
		DIA	THK	ARBOR			
42065	23314	4-1/2	.045	7/8	1	13,300	10

ABRASIVE PRODUCTS

RAZORBLADE EZ

FOR USE ON RIGHT ANGLE GRINDERS



- This wheel is for applications where getting the job done fast is the priority.
- .040 thickness... thinner than the typical .045 thickness.
- For metal and stainless. Type A60RRT material.



J&B #	MFG #	SIZE			TYPE	MAX RPM	QTY
		DIA	THK	ARBOR			
12525	F1206	4-1/2	.040	7/8	1	13,300	10
45572	F1706	6	.040	7/8	1	10,200	10

NOTE: CUT-OFF WHEELS ARE FOR USE ON RIGHT ANGLE GRINDERS EQUIPPED WITH PROPER TYPE 1 FLANGES. DO NOT USE WITH TYPE 27 STYLE FLANGES.

J&B #	DESCRIPTION	QTY
41407	TYPE 1, ADAPTER FLANGE	EA

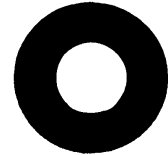

ABRASIVE PRODUCTS

HIGH SPEED CUT-OFF WHEELS

FOR USE ON RIGHT ANGLE GRINDERS



- Cuts ferrous & non ferrous metals (iron, steel, welds, etc.)
- Thin wheel, fast cutting with long life.
- Cut-off wheels are dressed so they cut instantly.
- Premium cutting speed and life in sheet metal or solids. Outstanding in stainless or alloys.

J&B #	SIZE		MFG	TYPE	GRADE	MAX RPM	QTY
	DIA	THK ARBOR					
41408	4-1/2	.045 x 7/8	SAIT 23101	1	A60S	13,300	10
43500	4-1/2	.045 x 7/8	FLEXOVIT F1207	1	A60S	13,300	10
40259	6	.045 x 5/8	SAIT 23105	1	A60S	10,200	10
42122	6	.045 x 7/8	SAIT 23106	1	A60S	10,200	10
42166	6	.045 x 7/8	FLEXOVIT F1707	1	A60S	10,000	10

NOTE: CUT-OFF WHEELS ARE FOR USE ON RIGHT ANGLE GRINDERS EQUIPPED WITH PROPER TYPE 1 FLANGES DO NOT USE WITH TYPE 27 STYLE FLANGES.

J&B #	DESCRIPTION	QTY
41407	TYPE 1, ADAPTER FLANGE	EA



HIGH SPEED CUT-OFF WHEELS

- Aluminum oxide grain.
- Hard bond for aggressive cutting on rough applications.
- Cuts ferrous metals (iron, steel, welds, etc.) and stainless.



J&B #	SIZE		MFG	TYPE	GRADE	MAX RPM	QTY
	DIA	THK ARBOR					
41839	6	.035 x 7/8	SAIT 23210	1	A36T	10,186	10

ABRASIVE PRODUCTS

CUT-OFF WHEELS Depressed Center

FOR USE ON RIGHT ANGLE GRINDERS



- The Razorblade 27 wheel combines fast, chatter free cutting with exceptional wheel life, making it the wheel of choice where wheel usage is high and wheel change downtime is a concern.
- Facilitates flush cutting on flat surfaces.

J&B #	MFG #	SIZE			TYPE	GRADE	MAX RPM	QTY
		DIA	THK	ARBOR				
42042	A0481	4-1/2	x .045	x 7/8	27	A60SST-27	13,300	10
V41989	A2481	6	x .045	x 7/8	27	A60SST-27	10,000	10

CUT-OFF WHEEL Depressed Center

- Unique, thin type 27/ type 42 shape can be used on all angle grinders in accordance with ANSI B7.1.
- Unique formulations offer the fastest cutting, longest lasting thin wheels.
- Externally reinforced with fiberglass layers to provide ultimate safety in a thin wheel.
- Proprietary bonding system allows for faster, burr free cuts.



J&B #	MFG #	SIZE			TYPE	GRADE	MAX RPM	QTY
		DIA	THK	ARBOR				
49108	22021	4-1/2	x .045	x 7/8	27 / 42	A60S	13,300	10

ABRASIVE PRODUCTS

PORTABLE SAW CUT-OFF WHEELS Extremely Fast Cutting

- Special aluminum oxide grain formula.
- Fast cutting action. Non-binding cutting formula.
- Externally reinforced with the highest quality fiberglass.
- Cuts ferrous metals, stainless steel, high tensile alloys.



J&B #	MFG #	SIZE		TYPE	GRADE	MAX RPM	QTY
		DIA	THK ARBOR				
39149	24160	14	1/8 x 20mm	1	XFC	5,460	1

ABRASIVE PRODUCTS

CUBITRON CUT-OFF WHEELS

FOR USE ON PENCIL & DIE GRINDERS



- Cubitron Cut-Off Wheels are designed to provide high cut rates and long life on most all materials including fiberglass, stainless steel, mild steel and aerospace alloys.
- Cubitron Wheels incorporate 3M's patented **Cubitron** ceramic abrasive grain technology and are ideal for use on a wide variety of utility type cut-off tools.



J&B #	SIZE	HOLE	MAX RPM	QTY
*41860	3 x 1/16	3/8"	26,000	5
*45570	4 x 1/32	3/8"	26,250	5

*No broken boxes

CUT-OFF WHEELS

FOR USE ON PENCIL & DIE GRINDERS



- Aluminum oxide grain, hard bond for aggressive cutting on rough applications.
- Easily cuts through tubes, pipes, sheet metal.

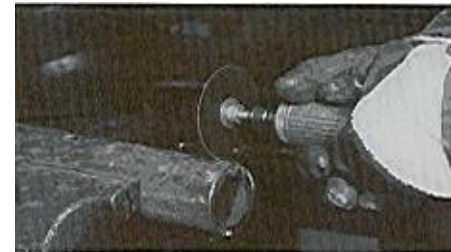

J&B #	MFG #	SIZE	HOLE	MATERIAL	MAX RPM	QTY
*40249	F0220	2-1/2 x 1/16	3/8	A36T	24,446	10
40256	23051	3 x .035	3/8	A60T	25,000	10
*42168	F0310	3 x .035	3/8	A60T	25,000	10
40250	23040	3 x 1/16	3/8	A36T	25,000	10
40252	23065	4 x 1/16	3/8	A36T	19,000	10

* = Flexovit Brand



J&B #	FITS WHEEL SIZE OF: THICKNESS	ARBOR	SHANK SIZE	QTY
40255	.035 to 1/2	3/8	1/4	EA
40251	.035 to 3/16	3/8 or 1/4	1/4	EA

* These mandrel adapters fit 2" to 4" diameter wheels.

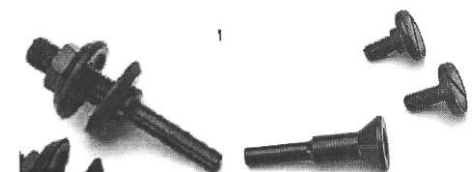

40255

40251

ABRASIVE PRODUCTS

CHOPSAW WHEELS

FOR USE ON CHOPSAWS



- General purpose for profiles and solids; carbon or alloy steels.
- Made of reinforced resinoid for longer life.

J&B #	MFG #	SIZE	HOLE	MATERIAL	MAX RPM	QTY	CASE
39062	24034	12 x 3/32	1"	A30RB	5,100	EA	10
39064	24039	14 x 3/32	1"	A30RB	4,400	EA	10

REDUCING BUSHINGS

- For use with type 1 cut-off wheels.
- Reduces wheel arbor size.

J&B #	SIZE	QTY
13757	7/8 – 5/8	10
13756	1" – 7/8	10
13755	1" – 20mm	10



CIRCULAR SAW WHEELS

FOR USE ON
CIRCULAR SAWS



- Fast cut metal, stainless.
- A general purpose wheel, ideal on carbon or stainless steel shapes or profiles.
- Provides fast cutting action.

J&B #	MFG #	SIZE	HOLE	MATERIAL	MAX RPM	QTY	CASE
45630	23230	7 x 3/32	5/8	A24R	8,500	EA	25

ABRASIVE PRODUCTS

SHOP ROLLS

Aluminum Oxide

FOR HAND USE



- Aluminum oxide abrasive, cloth-backed, glue bonded.
- Comes in handy dispenser box.



J&B #	GRIT	LENGTH	WIDTH	QTY
20880	60	50 YDS	1-1/2	EA
20773	80	50 YDS	1-1/2	EA
20774	100	50 YDS	1-1/2	EA
20775	120	50 YDS	1-1/2	EA
20881	150	50 YDS	1-1/2	EA
20778	180	50 YDS	1-1/2	EA
20776	240	50 YDS	1-1/2	EA
20777	320	50 YDS	1-1/2	EA
20779	400	50 YDS	1-1/2	EA

REGULAR BELTS

Aluminum Oxide

FOR USE ON BELTSANDERS

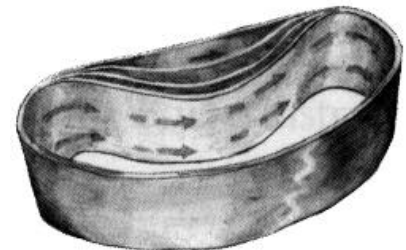

J&B #	GRIT	LENGTH	WIDTH	QTY
*41956	120	18 "	3/4	100

* If breaking a box, must be done in multiples of 10.

ABRASIVE PRODUCTS

ABRASIVE SCREEN

FOR HAND USE



- Made of nylon mesh impregnated with a silicone carbide abrasive.
- Can be used **wet or dry** on metal, wood, and plastic applications.
- Screen mesh design **prevents loading**.
- Can be used on both sides.



J&B #	SIZE	GRIT	QTY
20149	1-1/2 x 75 Ft.	120	EA

CROCUS CLOTH ROLL

FOR HAND USE



- Sharp, long lasting aluminum oxide abrasive.
- Excellent for extra **fine polishing** of metals.



J&B #	SIZE	QTY
20151	1-1/2 x 20 Yds.	EA

ABRASIVE PRODUCTS

PSA SANDING DISCS Stikit

- Pressure sensitive adhesive for press-on, peel-off convenience.
- Discs resist loading and reduce “down time”.
- For use on paint, primer, wood, metal and fiberglass.
- All discs below have no holes.

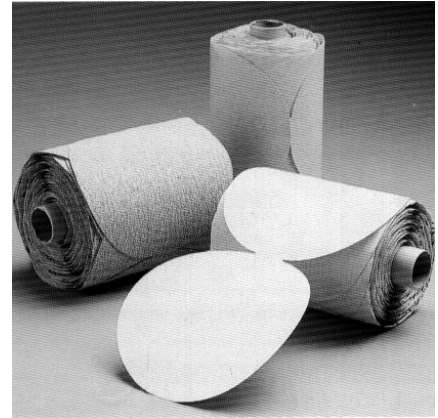

ORDER BY THE ROLL

J&B #	3M #	COLOR	SIZE	GRIT	QTY
40710	051144-21799	GOLD	5"	80F	100/RL
45730	35412 (SAIT)	WHITE	5"	P120 (6A)	100/RL
45610	35413 (SAIT)	WHITE	5"	P150	100/RL

* Cannot break roll quantity.

ORDER BY THE ROLL

PSA BACKING PAD

- For use with PSA adhesive backed sanding discs.
- Threaded pad for dual action/random orbital sanders and right angle grinders/sanders.

J&B #	SIZE	QTY
41961	5 x 5/16-24	EA



ABRASIVE PRODUCTS

FOR HAND USE

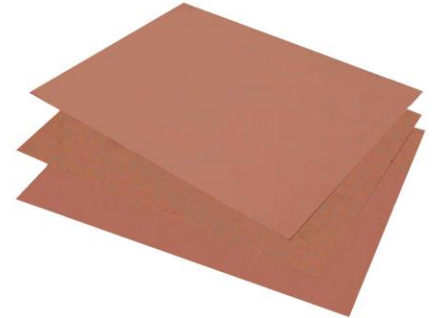

ALUMINUM OXIDE PAPER Open Coat

- Dry sanding only. Open coat resists loading.
- Effective for removing scratches and burrs on metal, shaping and finishing plastic filler, and stripping old paint or varnish off wood.

J&B #	SIZE	GRIT	QTY
9454	9 x 11	80D	50

EMERY CLOTH

- Used for general purpose metal sanding such as light cleanup work and rust removal jobs.

J&B #	SIZE	GRIT	QTY
38058	9 x 11	FINE	EA
38969	9 x 11	MED	EA

CROCUS CLOTH

- Sharp, long lasting aluminum oxide abrasive.
- Excellent for extra fine polishing of metals.

J&B #	SIZE	QTY
38968	9 x 11	EA

ABRASIVE PRODUCTS

TAPERED CARTRIDGE MANDRELS

J&B #	SHANK DIA.	PILOT LENGTH	PILOT DIA.	QTY
41966	1/4"	1"	1/8	EA
41970	1/4"	1-1/2"	3/16	EA



STEEL WOOL

- Heavy duty grade for removing rust, cleaning car engines & removing accumulations of paint & varnish on floors & furniture.
- Packaged in bags of 12.

J&B #	GRADE	STYLE	QTY
40393	#4	EXTRA COARSE	1 BAG

(ORDERING 1 = 1 BAG OF 12)

** NO BROKEN BAGS



STRIP DISC

- Fast, safe removal of surface contaminants.
- Excellent for cleaning welds, removing corrosion, rust, scaling and blending.
- Great for removing paints, varnishes & sealants from Difficult to reach surfaces.

J&B #	SIZE	MAX RPM	QTY
45732	2"	12,000	5
45733	3"	8,500	5
45960	4"	12,000	EA

J&B #	SIZE	QTY
40448	2" Arbor 1/4" Shank	EA
40449	3" Arbor 1/4" Shank	EA



ABRASIVE PRODUCTS

HUB CLEANING DISC

- Extremely tough non-woven web removes rust & corrosion without excessive metal removal or gouging.
- Contains no wire filaments.
- Ideal for effective removal of buildup on brakes.
- Made of silicon carbide mineral that cuts sharp.
- Disc features a hollow center, enabling operators to slide over and around hub without damaging the stud threads.



J&B #	SIZE	GRIT	STYLE	QTY
49090	1-1/2	100	EXTRA COARSE	10
49091	Holder for hub cleaning disc			EA

FLAP WHEELS

- For cleaning, deburring, finishing, and polishing of flat or contoured metal surfaces.
- Hugs concave or convex surfaces, allowing access to hard-to-reach areas.
- Non-loading; the flexibility provided by the coated abrasive flaps prevents loading which occurs with non-flexible grinding products.
- Arbor has a 1/4-20 thread..



J&B #	WHEEL DIAMETER	FACE WIDTH	GRIT	MAX RPM	QTY
49002	2"	1"	40	25,000	EA

ABRASIVE PRODUCTS

3M SCOTCH-BRITE HAND PADS General Purpose Pad



- Made of nylon web - rinse clean – can be used over and over again.
- Handy for doing many chores from Cleaning metal surfaces to sanding wood or ceramic materials.
- Use in a dry medium or with lubricants such as water or oil.

J&B #	SIZE	GRIT	COLOR	QTY
*40391	6 x 9	SUPER FINE	WHITE	20
*12250	6 x 9	FINE	LIGHT GRAY	20
*40700	6 x 9	MEDIUM	MAROON	20
*42063	6 x 9	COARSE	DARK GRAY	20

* Sold in full boxes only.

ALUMINUM OXIDE MOUNTED FLAP WHEELS

- For cleaning, deburring, finishing, and polishing of flat or contoured metal surfaces.
- Hugs concave or convex surfaces, allowing access to hard-to-reach areas.
- Non-loading; the flexibility provided by the coated abrasive flaps prevents loading which occurs with non-flexible grinding products.
- Mandrel mounted on fixed 1/4" solid shank.

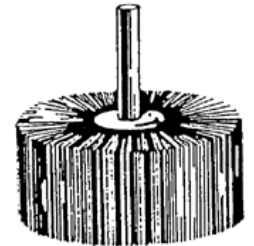

J&B #	WHEEL DIAMETER	FACE WIDTH	GRIT	MAX RPM	QTY
49093	1"	1"	40	30,000	EA
40654	1"	1"	60	30,000	EA
40655	1"	1"	80	30,000	EA
42385	1"	1"	120	30,000	EA
42387	1-1/2"	1"	60	25,000	EA
42388	1-1/2"	1"	80	25,000	EA
40665	1-1/2"	1"	120	25,000	EA
49094	2"	1"	40	25,000	EA
42391	2"	1"	60	25,000	EA
40660	2"	1"	80	25,000	EA
40662	2"	1"	120	25,000	EA
40664	2"	1"	180	25,000	EA
40667	2-1/2"	1"	60	23,000	EA
42393	2-1/2"	1"	80	23,000	EA
40668	2-1/2"	1"	120	23,000	EA
42395	3"	1"	60	23,000	EA
49095	3"	1"	80	23,000	EA
42397	3"	1"	120	23,000	EA

ABRASIVE PRODUCTS

ROL-ON SANDING DISCS

FOR USE ON RIGHT ANGLE SANDERS & GRINDERS



- It is a handy quick change tool for disc grinding.
- Fits any 1/4" drill or air tool.
- Connects quickly and easily to its arbor with a 1/2" right twist and removes with a 1/2" left twist.



J&B #	SIZE	GRIT	QTY
* 41952	2"	120	50
38903	2"	80	25
* 41981	2"	80	50
38893	2"	50	25
* 41980	2"	50	50
38894	2"	36	25
^ 41899	2"	36	25
* 41950	2"	36	50
38895	2"	24	25
^ 41901	2"	24	25
* 41979	2"	24	50
39029	3"	120	25
38966	3"	80	25
* 41985	3"	50	50
38896	3"	50	25
* 41986	3"	36	50
38897	3"	36	25
* 41987	3"	24	50
38898	3"	24	25

J&B #	SIZE	QTY
40448	2" Arbor 1/4" Shank	EA
40449	3" Arbor 1/4" Shank	EA

* 3M discs.

^ Shark discs.

ROL-ON BRISTLE DISCS

- Ideal for cleaning, finishing, blending and deburring.
- Used on corners, welds and for rivet cleaning on all areas where conformability is required.
- Eliminate dangerous flying wires.



J&B #	SIZE	GRIT	COLOR	QTY
42164	2"	FINE	WHITE	5
42160	2"	MEDIUM	YELLOW	5
42162	2"	COARSE	GREEN	5
42163	3"	COARSE	GREEN	5

*Use arbor 40448 for 2" bristle disc & 40449 for 3".

ABRASIVE PRODUCTS

TRIM-KUT DISCS

FOR USE ON RIGHT ANGLE SANDERS & GRINDERS



- Trim-Kut abrasive discs are a unique one piece design with the grinding surface bonded to a hard copolymer backing.
- No backing pad required.
- Grinds, sands, levels weld seams and is an excellent rust/paint remover.
- Aluminum oxide discs.

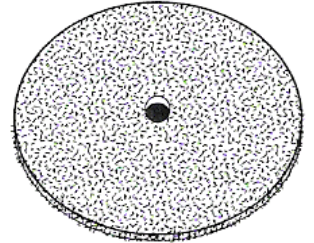

J&B #	SIZE	PRINT COLOR	GRIT	QTY
20441	3"	WHITE	24	25
20442	3"	RED	36	25
20443	3"	ORANGE	60	25
20444	3"	GREEN	120	25

* All boxes contain 1 mandrel.

HEX PREMIUM MANDREL

J&B #	SIZE	QTY
20450	1/4"	EA

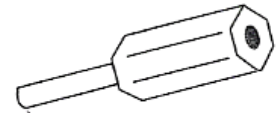

MINI FLAP DISCS

- Long life performance of a flap disc for use in confined spaces.
- More material, longer life than a single layer laminated disc.
- Roloc style allows easy changeover.



J&B #	SIZE	GRIT	QTY
59114	2"	40	EA
59115	2"	80	EA
59117	3"	40	EA
59118	3"	80	EA
40448	2" Arbor (1/4" shank)		EA
40449	3" Arbor (1/4" shank)		EA

ABRASIVE PRODUCTS

ROLON SURFACE CONDITIONING DISCS

FOR USE ON RIGHT ANGLE SANDERS & GRINDERS



- Non-woven surface conditioning products are ideal for deburring, cleaning, blending, and polishing.
- Use on mild steel, stainless, aluminum, plastic or wood.
- Connects quickly and easily to its arbor with a 1/2 right twist and removes with a 1/2 left twist.



J&B #	SIZE	GRIT	COLOR	QTY
38899	2"	FINE	BLUE	25
^ 41988	2"	FINE	BLUE	25
40440	2"	MEDIUM	MAROON	25
^ 41893	2"	MEDIUM	MAROON	25
^ 41894	2"	MEDIUM	MAROON	50
** 20449	2"	MEDIUM	MAROON	50
40442	2"	COARSE	BROWN	25
^ 41895	2"	COARSE	BROWN	25
^ 41896	2"	COARSE	BROWN	50
** 20448	2"	COARSE	BROWN	50
38900	3"	FINE	BLUE	25
^ 41932	3"	FINE	BLUE	25
40444	3"	MEDIUM	MAROON	25
^ 41897	3"	MEDIUM	MAROON	25
40446	3"	COARSE	BROWN	25
^ 41898	3"	COARSE	BROWN	25
40448	2" Arbor (1/4" shank)			EA
40449	3" Arbor (1/4" shank)			EA

** GEMTEX

^ SHARK

VELCRO SURFACE CONDITIONING DISCS

FOR USE ON RIGHT ANGLE SANDERS & GRINDERS



- Non-woven surface conditioning products are ideal for deburring, cleaning, blending, and polishing.
- Use on mild steel, stainless, aluminum, plastic or wood.
- This disc pad connects quickly and easily to any power tool while holding surface conditioning discs securely and safely through the use of dual lock fastening system.



J&B #	SIZE	GRIT	COLOR	QTY
40420	2"	MEDIUM	MAROON	25
40422	2"	COARSE	BROWN	25
40430	2" Arbor (1/4" shank)			EA

ABRASIVE PRODUCTS

INTERLEAF WHEELS

- Mandrel mounted on fixed 1/4" solid shank.
- Medium grade. Excellent for removing heavy oxidation, blending, cleaning and deburring.
- Very fine grade. Excellent for grain finishing, satin finishing and linear scratch patterns.



J&B #	DIA x THICKNESS	GRIT	GRADE	MAX RPM	QTY
46130	2 x 1	60	MEDIUM	15,000	EA
46131	2 x 1	80	MEDIUM	15,000	EA
46132	2 x 1	120	VERY FINE	15,000	EA

NON WOVEN SURFACE CONDITIONING DISCS

Hook & Loop

FOR USE ON RIGHT ANGLE GRINDERS



- Ideal for deburring, cleaning, blending and polishing.
- Use on mild steel, stainless, aluminum, plastic or wood.
- Gripper pad is made perfectly flat from high impact plastics to ensure maximum support and disc adhesion.

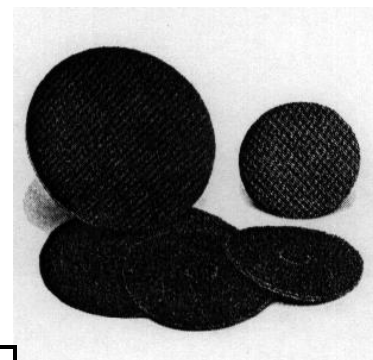

J&B #	SIZE	GRIT	COLOR	QTY
45680	7"	FINE	BLUE	10
45682	7"	COARSE	BROWN	10
45683	7" Gripper Pad (5/8-11" shank)			EA

ROLOC UNITIZED WHEEL

- Roloc unitized wheels are strong, efficient products for edge deburring and finishing.
- They perform well in a variety of metal working applications and on intricate machined parts where close tolerances are important.
- The Roloc holding systems make changing unitized wheels quick and easy.



J&B #	SIZE	GRIT	COLOR	QTY
40477	2"	MEDIUM	TAN	5
40448	2" Arbor (1/4" shank)			EA



ABRASIVE PRODUCTS

MOUNTED GRINDING STONES

Premium Quality

FOR USE ON DIE GRINDERS



- Aluminum oxide vitrified bonded wheels are for all kinds of grinding, deburring, blending and contouring of ferrous and non-ferrous metals.
- Different shapes give access to hard-to-reach areas.



40680
(IND. # A3)



40681
(IND. # A11)



40682
(IND. # A21)

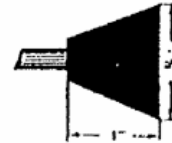

40683
(IND. # A31)



40684
(IND. # A36)



40685
(IND. # B52)



40686
(IND. # W163)



40687
(IND. # W185)

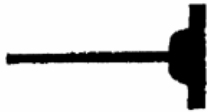

40688
(IND. # W215)



40689
(IND. # W220)



40690
(IND. # W235)



40691
(IND. # W236)

J&B #	IND #	ABRASIVE SHAPE		MANDREL SIZE	MAX RPM	QTY
		DIAM	THICK			
40680	A3	1	2-3/4	1/4	16,100	2
40681	A11	7/8	2	1/4	19,860	2
40682	A21	1	1	1/4	34,500	2
40683	A31	1-3/8	1	1/4	27,780	2
40684	A36	1-5/8	3/8	1/4	23,520	2
40685	B52	3/8	3/4	1/8	45,370	2
40686	W163	1/4	1/2	1/8	60,000	2
40687	W185	1/2	1/2	1/8	34,500	2
40688	W215	1	1/8	1/8	38,200	2
40689	W220	1	1	1/4	25,500	2
40690	W235	1-1/2	1/4	1/4	25,470	2
40691	W236	1-1/2	1/2	1/4	25,470	2

GROUP A SHAPES: Use for medium to heavy duty blending and contouring.

GROUP B SHAPES: Best for light deburring and blending.

GROUP W SHAPES: Suited for off-handed and precision grinding where medium to heavy stock removal is required.



ABRASIVE PRODUCTS

WIRE END BRUSHES

FOR USE ON STRAIGHT GRINDERS

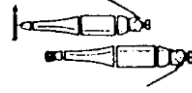

- Use crimped for softer and knotted for more aggressive brushing.
- Use with portable tools or drill presses.
- Ideal for tight to get at areas and blind holes.



APPLICATIONS:

- Carbon Cleaning
- Die, Mold and Tool Polishing
- Rust or Paint Removal
- Burr Removal
- Weld Cleaning
- Rubber or Plastic Removal
- Spot Facing
- Cleaning Castings

42120 / 20960 /

20961

CRIMPED

45702 /

41192

KNOTTED

J&B #	DIA	SHANK	WIRE SIZE	TRIM LENGTH	MAX. SAFE FREE SPEED (RPM)	QTY
20960	1/2"	1/4"	.020	1"	22,000	EA
20961	1"	1/4"	.020	1"	20,000	EA
42120	1-3/4"	1/4"	.012	1"	20,000	EA
45702	3/4"	1/4"	.014	1"	20,000	EA
41192	1-1/8"	1/4"	.020	1"	20,000	EA

TUBE BRUSH

- Deburring and cleaning drilled holes and internal threads, cleaning and finishing internal diameters of pipes and tubes, deburring and cleaning keyways and grooves.

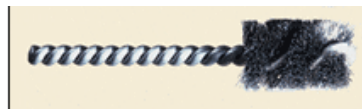

J&B #	DIA	BRUSH LENGTH	OVERALL LENGTH	FILAMENT/ DIAMETER	QTY
41326	7/8"	1"	3-1/2"	.006 CARBON	EA

ABRASIVE PRODUCTS

KNOT WIRE CUP BRUSH

FOR USE ON ANGLE GRINDERS



- Knot wheels provide high impact brushing action for heavy surface conditioning applications.

J&B #	DIA	ARBOR	WIRE SIZE	MATERIAL	MAX. SAFE FREE SPEED (RPM)	QTY
V41877	2-3/4"	5/8-11	.020	Carbon	14,000	EA
41790	3-1/2"	5/8-11	.020	Carbon	12,500	EA
41193	4"	5/8-11	.020	Carbon	9,000	EA

LARGE CRIMPED WIRE CUP BRUSH

FOR USE ON LARGE ANGLE GRINDERS



- For general purpose cleaning and deburring.
- Ideal for light cleaning and paint removal.
- Ideal for flat surfaces and edge cleaning.

J&B #	DIA	ARBOR	WIRE SIZE	MATERIAL	MAX. SAFE FREE SPEED (RPM)	QTY
41791	2-3/4"	5/8-11	.014	Carbon	14,000	EA
41872	3-1/2"	5/8-11	.014	Carbon	12,500	EA

CRIMPED WIRE CUP BRUSH

FOR USE ON DIE GRINDERS, POWER DRILLS, RIGHT ANGLE AIR DIE GRINDERS



J&B #	DIA	ARBOR	WIRE SIZE	MATERIAL	MAX. SAFE FREE SPEED (RPM)	QTY
45729	2"	1/4"	.0118	Carbon	13,000	EA

ABRASIVE PRODUCTS

KNOT WIRE CUP BRUSH Stainless Steel

FOR USE ON ANGLE GRINDERS



- Knot wheels provide high impact brushing action for heavy surface conditioning applications.
- For applications where contamination of the workpiece is a concern. Manufactured with 302 stainless.

J&B #	DIA	ARBOR	WIRE SIZE	MATERIAL	MAX. SAFE FREE SPEED (RPM)	QTY
48710	2-3/4"	5/8-11	.020	Stainless	12,500	EA
48711	3-1/2"	5/8-11	.020	Stainless	12,500	EA

LARGE CRIMPED WIRE CUP BRUSH Stainless Steel

FOR USE ON LARGE ANGLE GRINDERS



- For general purpose cleaning and deburring.
- Ideal for light cleaning and paint removal.
- Ideal for flat surfaces and edge cleaning.
- For applications where contamination of the workpiece is a concern. Manufactured with 302 stainless.

J&B #	DIA	ARBOR	WIRE SIZE	MATERIAL	MAX. SAFE FREE SPEED (RPM)	QTY
48715	2-3/4"	5/8-11	.014	Stainless	12,00	EA
48716	3-1/2"	5/8-11	.014	Stainless	12,500	EA

ABRASIVE PRODUCTS

CRIMPED WIRE WHEEL

FOR USE ON ANGLE GRINDERS



- For light rust and oxide removal, cleaning and conditioning.
- Crimped wire wheel brushes have higher flexibility than knotted wire for application on irregular surfaces and where lighter brushing is required.

J&B #	DIAM	FACE	ARBOR	WIRE SIZE	MAX. SAFE FREE SPEED (RPM)	QTY
40433	4"	1/2"	5/8-11	.014	15,000	EA

KNOTTED WIRE WHEEL

FOR USE ON ANGLE GRINDERS



- Provide high impact action to remove weld scale and splatter.
- Ideal for general cleaning.

J&B #	DIAM	FACE	ARBOR	WIRE SIZE	MAX. SAFE FREE SPEED (RPM)	QTY
40434	4"	3/8"	5/8-11	.020	20,000	EA
46442	6"	1/2"	5/8-11	.023	9,000	EA

ABRASIVE PRODUCTS

KNOTTED WIRE WHEEL

FOR USE ON RIGHT ANGLE SANDERS & GRINDERS



- Cleaning, deburring, roughening.

J&B #	DIAM	FACE	ARBOR	WIRE SIZE	MAX. SAFE FREE SPEED (RPM)	QTY
45731	3"	3/8"	1/4"	.014	25,000	EA
49092	4"	5/8"	1/4"	.020	20,000	EA

CRIMPED WIRE WHEEL

FOR USE ON RIGHT ANGLE SANDERS & GRINDERS



- For light to medium duty applications

Hex Arbor

J&B #	DIAM	THICK	ARBOR	WIRE SIZE	MAX RPM	QTY
38667	2"	3/8	1/4"	.012	5,000	EA
38668	3"	3/8	1/4"	.012	4,500	EA
38669	3"	3/8	1/4"	.008	4,500	EA
38665	4"	1/2"	1/4"	.012	4,500	EA



Smooth Arbor

J&B #	DIAM	THICK	ARBOR	WIRE SIZE	MAX RPM	QTY
38666	1-1/2"	3/8	1/4"	.012	20,000	EA
43012	2"	3/8	1/4"	.012	20,000	EA
43013	3"	1/2	1/4"	.008	20,000	EA
43014	3"	1/2	1/4"	.014	20,000	EA



ABRASIVE PRODUCTS

CRIMPED WIRE WHEELS

Carbon Steel

FOR USE ON BENCH GRINDERS

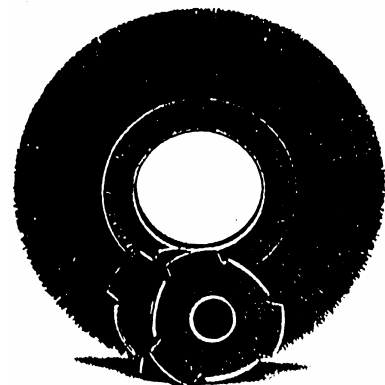

- Designed for maximum productivity; good filament density and additional section construction for extra rigidity.
- Excellent for refining metal surfaces, preparing rubber in vulcanizing, blending surfaces, removing light burrs, paint and corrosion.

J&B #	DIAM.	WIRE SIZE	WIDTH	ARBOR	MAX RPM	QTY
39175	6"	.014	1/2"	1/2, 5/8	6,000	EA
39094	8"	.014	1"	1/2, 5/8	4,500	EA

* Part #39094 comes with 1/2 and 5/8 arbor; 3/4 arbor must be ordered separately.

J&B #	ARBOR
1403	3/4 - (for 8" wheel)

T-C CARBON STEEL WHEELS

FOR USE ON MINI GRINDERS

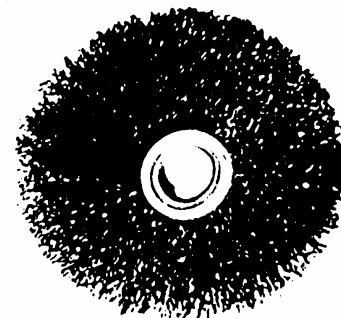

- Designed for use in restricted or hard-to-reach areas.
- Used for deburring, blending and cleaning of surfaces.

J&B #	DIAM.	WIRE SIZE	WIDTH	ARBOR	MAX RPM	QTY
40141	2"	.012	1/4	1/2	20,000	EA
40142	2-1/2"	.014	1/4	1/2	20,000	EA
40143	3"	.012	1/4	1/2	20,000	EA

ARBOR



Metal arbor for use in portable tools and drill presses with 1/4" capacity chucks 1/4" shank, 1/2" diameter brush to be used in adapting small diameter brushes with 1/2" diameter hole. **DO NOT USE WITH GRINDING WHEELS.**

J&B #	QTY
40140	EA



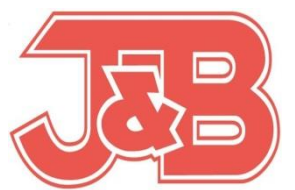
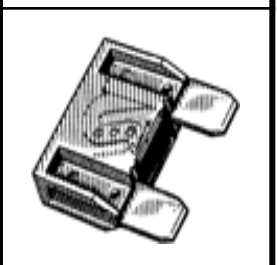
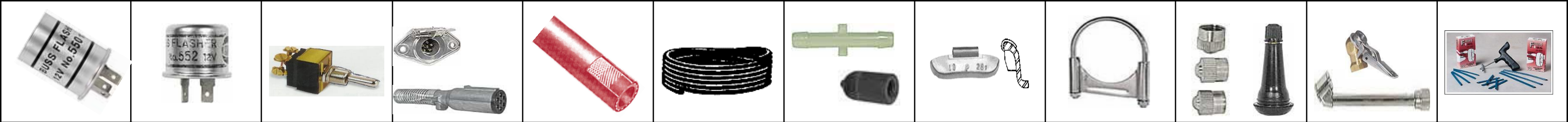



PART# 2851

J&B Fleet - Industrial Supply

22428 Harrisburg-Westville Rd. Alliance, Ohio 44601 Phone: (330) 821-6342 Fax: (330) 821-0411

www.jbfleet.com

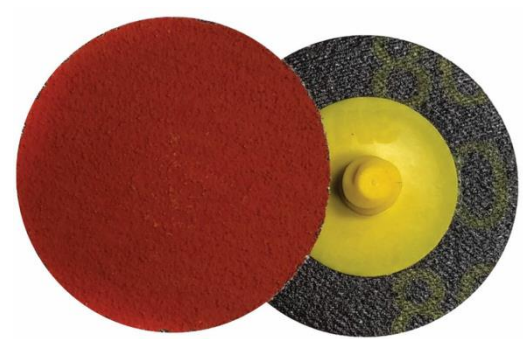
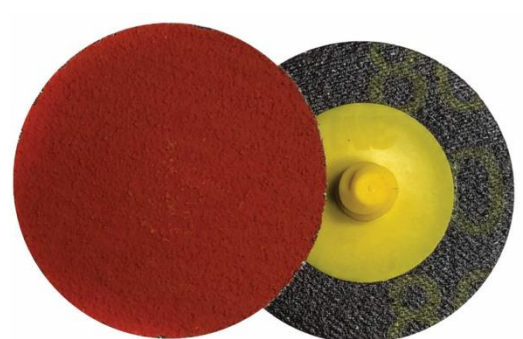
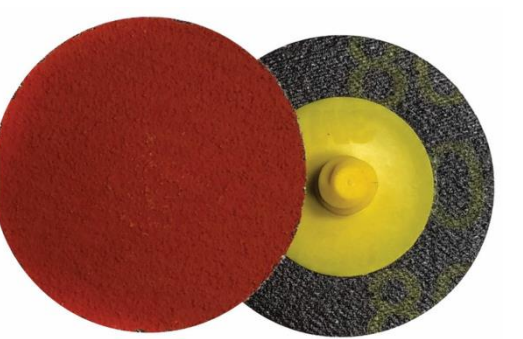
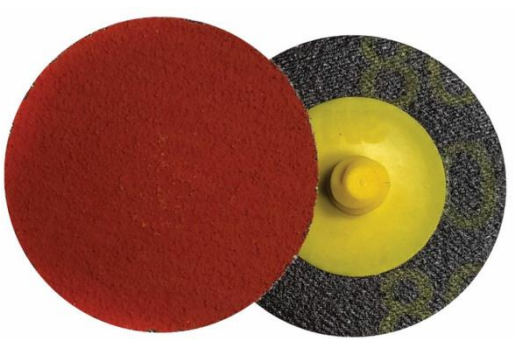
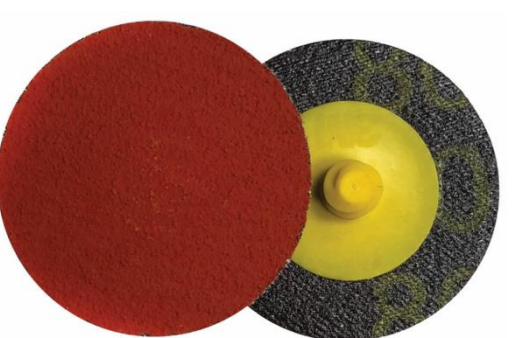
2" SANDING DISCS

<p>41979</p>  <p>2" 24 GRIT</p> <p>10</p>	<p>41950</p>  <p>2" 36 GRIT</p> <p>10</p>	<p>41980</p>  <p>2" 50 GRIT</p> <p>10</p>	<p>41981</p>  <p>2" 80 GRIT</p> <p>10</p>
<p>41952</p>  <p>2" 120 GRIT</p> <p>10</p>			<p>40448</p>  <p>2" ARBOR</p> <p>1</p>



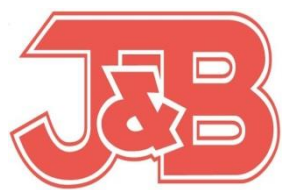
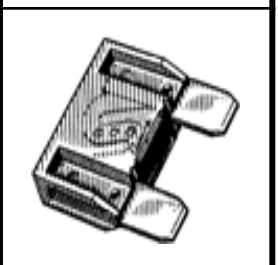
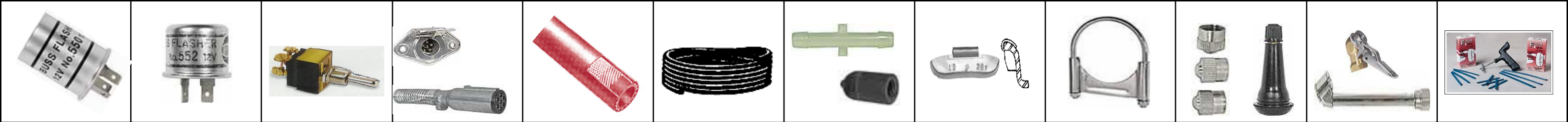

PART# 2852

J&B Fleet - Industrial Supply

22428 Harrisburg-Westville Rd. Alliance, Ohio 44601 Phone: (330) 821-6342 Fax: (330) 821-0411

www.jbfleet.com

2" SANDING DISCS

<p>38895</p> <p>2" 24 GRIT</p> <p>10</p>	<p>38894</p> <p>2" 36 GRIT</p> <p>10</p>	<p>38893</p> <p>2" 50 GRIT</p> <p>10</p>	<p>38903</p> <p>2" 80 GRIT</p> <p>10</p>
<p>41952</p> <p>2" 120 GRIT</p> <p>10</p>			<p>40448</p> <p>2" ARBOR</p> <p>1</p>



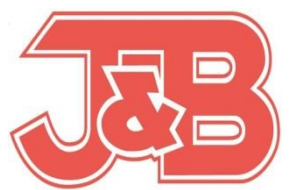
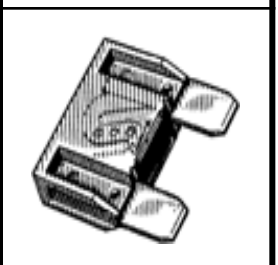
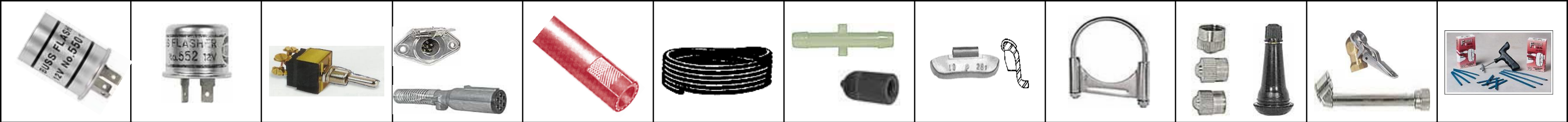

PART# 2853

J&B Fleet - Industrial Supply

22428 Harrisburg-Westville Rd. Alliance, Ohio 44601 Phone: (330) 821-6342 Fax: (330) 821-0411

www.jbfleet.com

3" SANDING DISCS

<p style="text-align: center;">38898</p>  <p style="text-align: center;">3" 24 GRIT</p> <p style="text-align: center;">10</p>	<p style="text-align: center;">38897</p>  <p style="text-align: center;">3" 36 GRIT</p> <p style="text-align: center;">10</p>	<p style="text-align: center;">38896</p>  <p style="text-align: center;">3" 50 GRIT</p> <p style="text-align: center;">10</p>	<p style="text-align: center;">38966</p>  <p style="text-align: center;">3" 80 GRIT</p> <p style="text-align: center;">10</p> <hr/> <p style="text-align: center;">40449</p>  <p style="text-align: center;">3" ARBOR</p> <p style="text-align: center;">1</p>
---	--	---	---



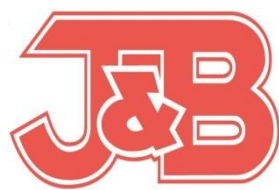
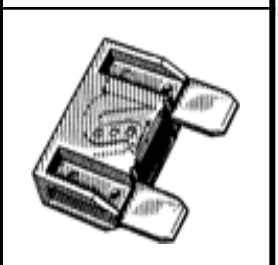
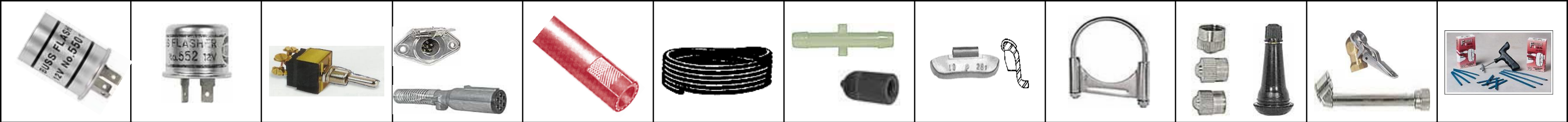



PART# 2854

J&B Fleet - Industrial Supply

22428 Harrisburg-Westville Rd. Alliance, Ohio 44601 Phone: (330) 821-6342 Fax: (330) 821-0411

www.jbfleet.com

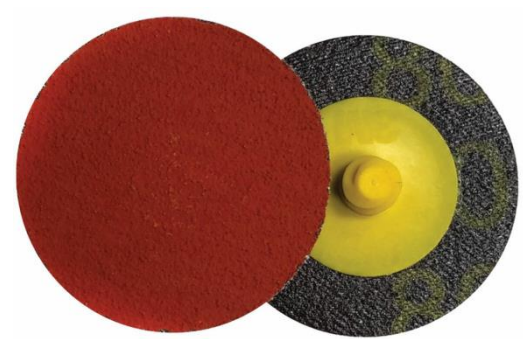
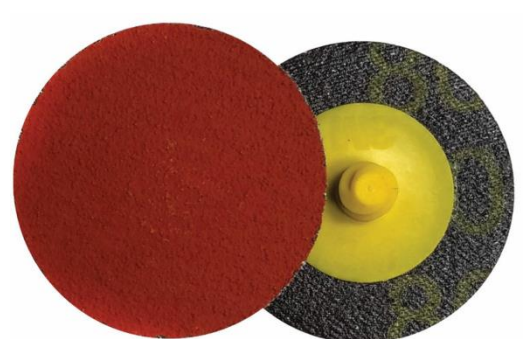
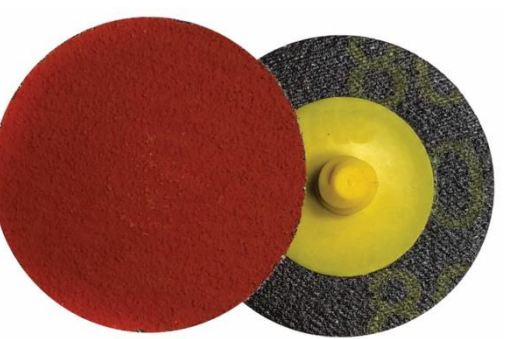
3" SANDING DISCS

<p style="text-align: center;">41987</p>  <p style="text-align: center;">3" 24 GRIT</p> <p style="text-align: center;">10</p>	<p style="text-align: center;">41986</p>  <p style="text-align: center;">3" 36 GRIT</p> <p style="text-align: center;">10</p>	<p style="text-align: center;">41985</p>  <p style="text-align: center;">3" 50 GRIT</p> <p style="text-align: center;">10</p>	<p style="text-align: center;">38966</p>  <p style="text-align: center;">3" 80 GRIT</p> <p style="text-align: center;">10</p> <hr/> <p style="text-align: center;">40449</p>  <p style="text-align: center;">3" ARBOR</p> <p style="text-align: center;">1</p>
---	---	---	---



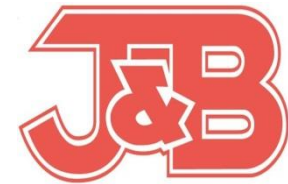
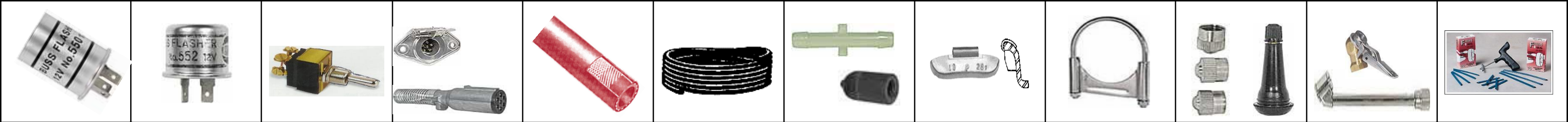

PART# 2855

J&B Fleet - Industrial Supply

22428 Harrisburg-Westville Rd. Alliance, Ohio 44601 Phone: (330) 821-6342 Fax: (330) 821-0411

www.jbfleet.com

BRISTLE DISCS

42163



3" COARSE GREEN

2

42162



2" COARSE GREEN

3

42160



2" MEDIUM YELLOW

3

42164



2" FINE WHITE

3

40449



3" ARBOR

1

40448



2" ARBOR

1



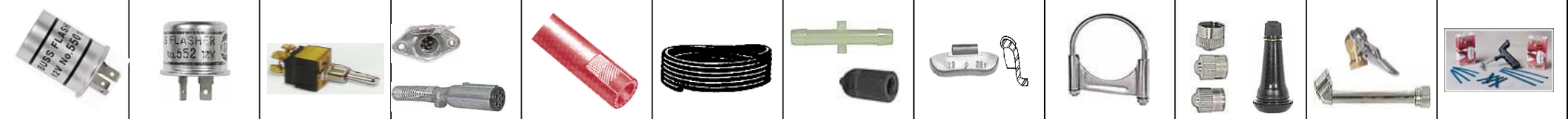







J&B Fleet - Industrial Supply

www.jbfleet.com

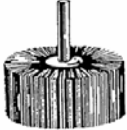
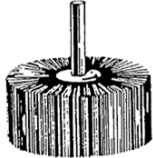
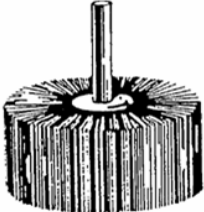
22428 Harrisburg-Westville Rd. Alliance, Ohio 44601 Phone: (330) 821-6342 Fax: (330) 821-0411

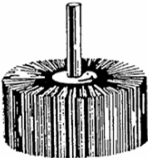
PART # 2202

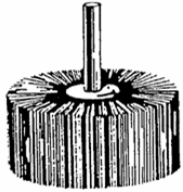
FLAP WHEELS

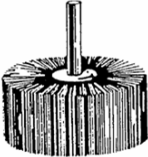
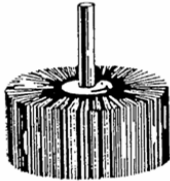
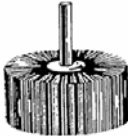
<p>40654</p>  <p>1 1" DIA 60 GRIT</p>	<p>42388</p>  <p>1 1-1/2" DIA 80 GRIT</p>	<p>40662</p>  <p>1 2" DIA 120 GRIT</p>	<p>42395</p>  <p>1 3" DIA 60 GRIT</p>
<p>40655</p>  <p>1 1" DIA 80 GRIT</p>	<p>42391</p>  <p>1 2" DIA 60 GRIT</p>	<p>40664</p>  <p>1 2" DIA 180 GRIT</p>	<p>42397</p>  <p>1 3" DIA 120 GRIT</p>
<p>42385</p>  <p>1 1" DIA 120 GRIT</p>	<p>40660</p>  <p>1 2" DIA 80 GRIT</p>	<p>42393</p>  <p>1 2-1/2" DIA 80 GRIT</p>	<p>1</p>
<p>42387</p>  <p>1 1-1/2" DIA 60 GRIT</p>	<p>1</p>	<p>1</p>	<p>1</p>



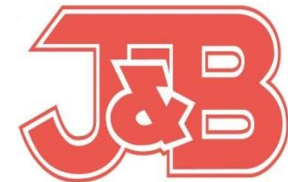
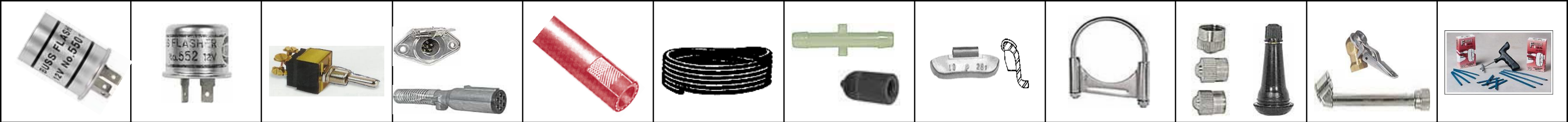

J&B Fleet - Industrial Supply

www.jbfleet.com

22428 Harrisburg-Westville Rd. Alliance, Ohio 44601 Phone: (330) 821-6342 Fax: (330) 821-0411

PART# 2856

MINI FLAP DISCS

59114



2" 40 GRIT

3

40449



3" ARBOR

1

59117



3" 40 GRIT

3

59118



3" 80 GRIT

3

59115



2" 80 GRIT

3

40448



2" ARBOR

1



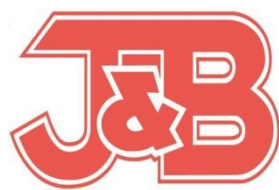
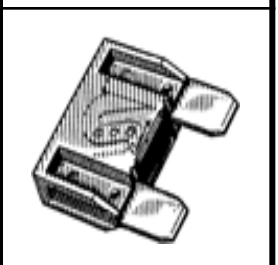
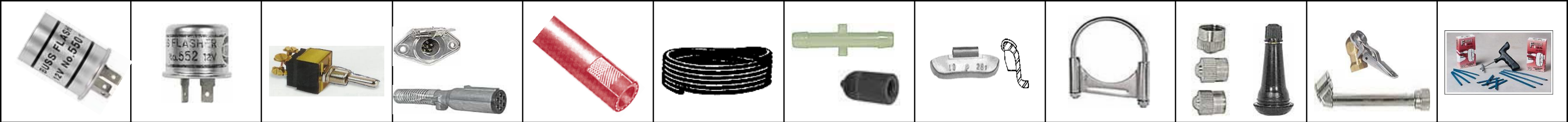





PART# 2857

J&B Fleet - Industrial Supply

22428 Harrisburg-Westville Rd. Alliance, Ohio 44601 Phone: (330) 821-6342 Fax: (330) 821-0411

www.jbfleet.com

TRIM-KUT DISCS

<p style="text-align: center;">20441</p>  <p style="text-align: center;">3" 24 GRIT WHITE</p> <p style="text-align: center;">10</p>	<p style="text-align: center;">20442</p>  <p style="text-align: center;">3" 36 GRIT RED</p> <p style="text-align: center;">10</p>	<p style="text-align: center;">20443</p>  <p style="text-align: center;">3" 60 GRIT ORANGE</p> <p style="text-align: center;">10</p>	<p style="text-align: center;">20444</p>  <p style="text-align: center;">3" 120 GRIT GREEN</p> <p style="text-align: center;">10</p> <hr/> <p style="text-align: center;">20450</p>  <p style="text-align: center;">ARBOR</p> <p style="text-align: center;">1</p>
--	---	---	--



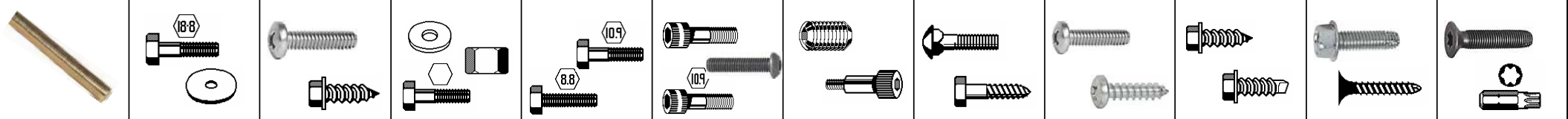







J&B Fleet - Industrial Supply

22428 Harrisburg-Westville Rd. Alliance, Ohio 44601 Phone: (330) 821-6342 Fax: (330) 821-0411

www.jbfleet.com

PART # 2131

ROLON SURFACE DISCS

<p>40444 1</p>  <p>3" MEDIUM</p> <p>10</p>	<p>40446 2</p>  <p>3" COARSE</p> <p>10</p>	<p>40440 3</p>  <p>2" MEDIUM</p> <p>10</p>	<p>40442 4</p>  <p>2" COARSE</p> <p>10</p>
<p>Non-woven surface conditioning discs are ideal for deburring, cleaning, blending, and polishing. Use on mild steel, stainless, aluminum, plastic or wood.</p>		<p>40448 5</p>  <p>2" ARBOR</p> <p>1</p>	<p>40449 6</p>  <p>3" ARBOR</p> <p>1</p>

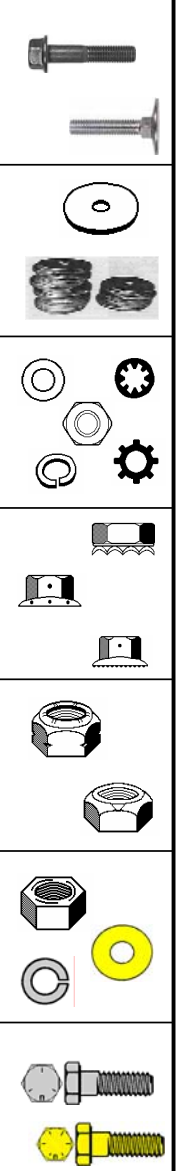











J&B Fleet - Industrial Supply

www.jbfleet.com

22428 Harrisburg-Westville Rd. Alliance, Ohio 44601 Phone: (330) 821-6342 Fax: (330) 821-0411

PART # 2204

ROL-ON SANDING DISCS

<p>1</p> <p>41952</p>  <p>5</p> <p>2" 120 GRIT 3M</p>	<p>2</p> <p>41950</p>  <p>5</p> <p>2" 36 GRIT 3M</p>	<p>3</p> <p>38966</p>  <p>3</p> <p>3" 80 GRIT</p>
<p>4</p> <p>41981</p>  <p>5</p> <p>2" 80 GRIT 3M</p>	<p>5</p>	<p>6</p> <p>38896</p>  <p>3</p> <p>3" 50 GRIT</p>
<p>7</p> <p>41980</p>  <p>5</p> <p>2" 50 GRIT 3M</p>	<p>8</p> <p>41979</p>  <p>3</p> <p>2" 24 GRIT 3M</p>	<p>9</p> <p>38897</p>  <p>3</p> <p>3" 36 GRIT</p>
<p>10</p>	<p>11</p>	<p>12</p> <p>38898</p>  <p>3</p> <p>3" 24 GRIT</p>



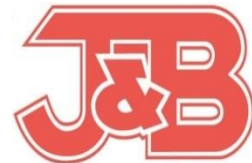
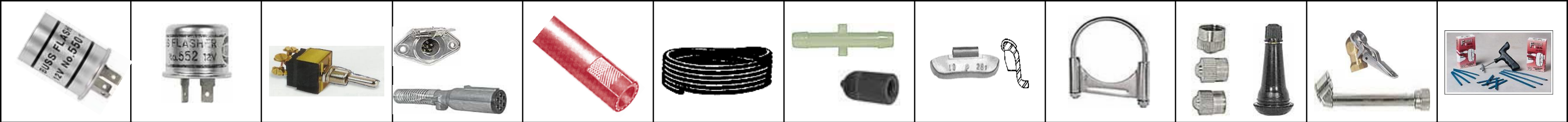







PART#2849

J&B Fleet - Industrial Supply

22428 Harrisburg-Westville Rd. Alliance, Ohio 44601 Phone: (330) 821-6342 Fax: (330) 821-0411

www.jbfleet.com

ROLON SURFACE DISCS - SHARK

<p>41897</p>  <p>3" SHARK</p> <p>10</p>	<p>41898</p>  <p>3" SHARK</p> <p>10</p>	<p>41893</p>  <p>2" SHARK</p> <p>2" MEDIUM MAROON</p> <p>10</p>	<p>41895</p>  <p>2" SHARK</p> <p>2" COARSE BROWN</p> <p>10</p>
<p>3" MEDIUM MAROON</p> <p>10</p> <p>Non-woven surface conditioning discs are ideal for deburring, cleaning, blending, and polishing. Use on mild steel, stainless, aluminum, plastic or wood.</p>		<p>40448</p>  <p>2" ARBOR</p> <p>1</p>	<p>40449</p>  <p>3" ARBOR</p> <p>1</p>



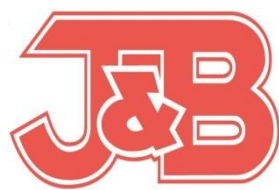
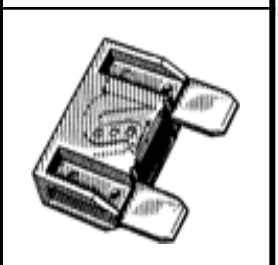
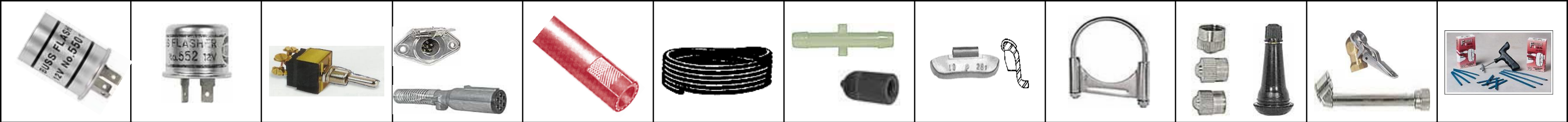

PART# 2858

J&B Fleet - Industrial Supply

22428 Harrisburg-Westville Rd. Alliance, Ohio 44601 Phone: (330) 821-6342 Fax: (330) 821-0411

www.jbfleet.com

2" ROLON DISCS

38899

2" FINE BLUE

10

40440

2" MEDIUM MAROON

10

40442

2" COARSE BROWN

10

40448

2" ARBOR

1



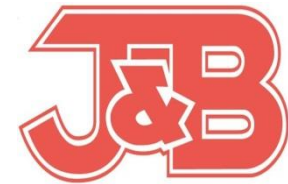
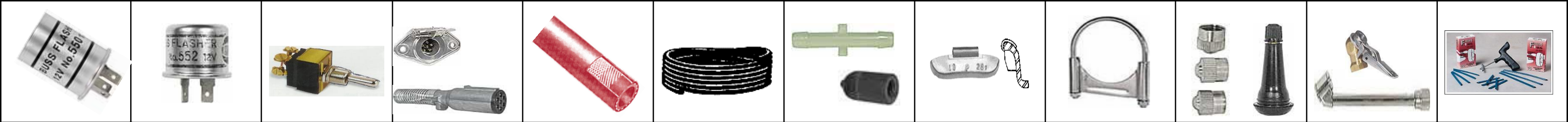

PART# 2859

J&B Fleet - Industrial Supply

22428 Harrisburg-Westville Rd. Alliance, Ohio 44601 Phone: (330) 821-6342 Fax: (330) 821-0411

www.jbfleet.com

3" ROLON DISCS

38900



3" FINE BLUE

10

40444



3" MEDIUM MAROON

10

40446



3" COARSE BROWN

10

40449



3" ARBOR

1



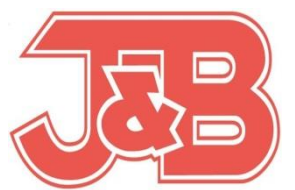
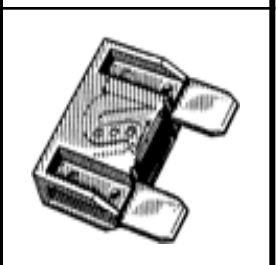
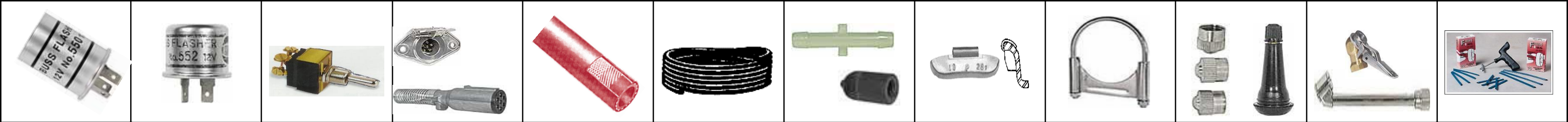

PART# 2861

J&B Fleet - Industrial Supply

22428 Harrisburg-Westville Rd. Alliance, Ohio 44601 Phone: (330) 821-6342 Fax: (330) 821-0411

www.jbfleet.com

2" ROLON DISCS

41988

2" FINE BLUE

10

41893

2" MEDIUM MAROON

10

41895

2" COARSE BROWN

10

40448

2" ARBOR

1



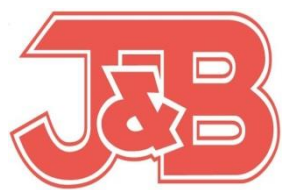
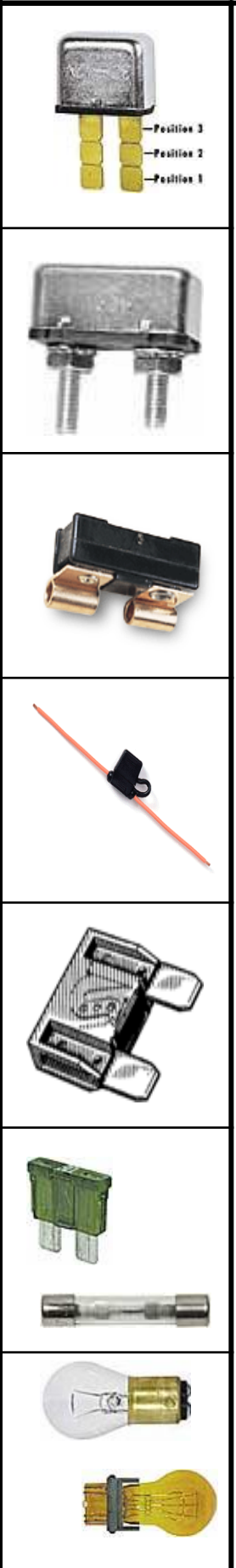
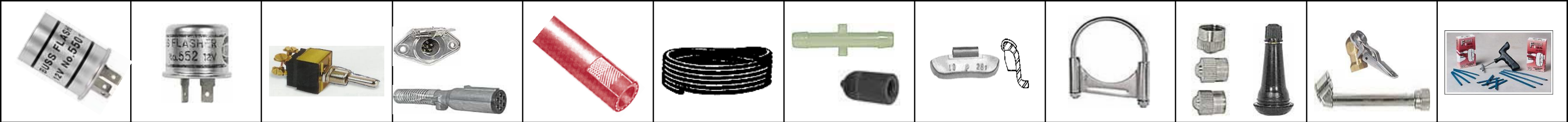

PART# 2863

J&B Fleet - Industrial Supply

22428 Harrisburg-Westville Rd. Alliance, Ohio 44601 Phone: (330) 821-6342 Fax: (330) 821-0411

www.jbfleet.com

3" ROLON DISCS

<p style="text-align: center;">41932</p>  <p style="text-align: center;">3" FINE BLUE</p> <p style="text-align: center;">10</p>	<p style="text-align: center;">41897</p>  <p style="text-align: center;">3" MEDIUM MAROON</p> <p style="text-align: center;">10</p>	<p style="text-align: center;">41898</p>  <p style="text-align: center;">3" COARSE BROWN</p> <p style="text-align: center;">10</p>	<p style="text-align: center;">40449</p>  <p style="text-align: center;">3" ARBOR</p> <p style="text-align: center;">1</p>
---	--	--	---

















J&B Fleet - Industrial Supply

22428 Harrisburg-Westville Rd. Alliance, Ohio 44601 Phone: (330) 821-6342 Fax: (330) 821-0411

www.jbfleet.com

PART # 2139

MOUNTED STONES

 40690 IND # W235	2 1	 40682 IND #A21	4 1	 40680 IND # A3	6 1
 40683 IND # A31	7 1	 40684 IND # A36	8 1	 40685 IND # B52	10 11 12
 40686 IND # W163	13 14 1	 40687 IND # W185	15 16 1	 40681 IND # A11	17 18 1
 40688 IND # W215	19 20 1	 40689 IND # W220	21 22 1	 40691 IND # W236	23 24 1



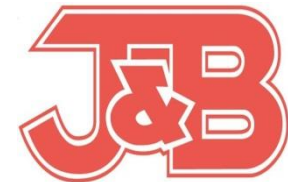
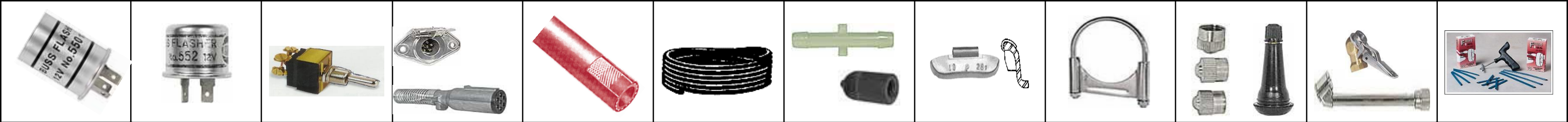

PART# 2850

J&B Fleet - Industrial Supply

22428 Harrisburg-Westville Rd. Alliance, Ohio 44601 Phone: (330) 821-6342 Fax: (330) 821-0411

www.jbfleet.com

WIRE WHEEL ASSORTMENT

45731



**3/8 x 1/4
KNOTTED
WIRE WHEEL**

2

38669



**3" X 1/4
CRIMP WIRE
WHEEL
WIRE SIZE .008**

2

38668



**3" X 1/4
CRIMP WIRE
WHEEL
WIRE SIZE .012**

2

38667



**2" X 1/4
CRIMP WIRE
WHEEL
WIRE SIZE .012**

2

20960



**1/2 X 1/4
END BRUSH**

2

20961



**1 X 1/4
END BRUSH**

2

41192



**1-1/8 X 1/4
END BRUSH**

2

42120



**1-3/4 X 1/4
END BRUSH**

2

