

Register your product and get support at  
[www.philips.com/welcome](http://www.philips.com/welcome)



32PFL3605/67

42PFL3605/67

47PFL3605/67

32PFL3605/98

42PFL3605/98

47PFL3605/98

32PFL3605S/98

42PFL3605S/98

47PFL3605S/98

---

EN User manual

---

FR Mode d'emploi

---

VI Hướng dẫn sử dụng

---

ZH-CN 用户手册

---

ZH-HK 使用手冊

---

TH คู่มือผู้ใช้

---

AR دليل المستخدم

---

**PHILIPS**

# Contents

<b>1</b>	<b>Notice</b>	2	<b>8</b>	<b>Product information</b>	24
				Supported display resolutions	24
				Multimedia	24
				Tuner/Reception/Transmission	24
				Remote control	24
				Power	24
				Supported TV mounts	25
				Product specification	25
<b>2</b>	<b>Important</b>	3	<b>9</b>	<b>Troubleshooting</b>	26
				General TV issues	26
				TV channel issues	26
				Picture issues	26
				Sound issues	27
				HDMI connection issues	27
				Computer connection issues	27
				Contact us	27
<b>3</b>	<b>Your TV</b>	5	<b>10</b>	<b>Index</b>	28
	Side controls and indicators	5			
	Remote control	5			
<b>4</b>	<b>Use your TV</b>	7			
	Switch your TV on/off or to standby	7			
	Switch channels	7			
	Watch connected devices	8			
	Adjust TV volume	8			
<b>5</b>	<b>Use more of your TV</b>	9			
	Access TV menus	9			
	Remove devices from the home menu	9			
	Change picture and sound settings	9			
	Create and use list of favourite channels	11			
	Use the TV clock	12			
	Use timers	12			
	Use TV locks	13			
	View photos and play music from a USB storage device	14			
	Update the TV software	15			
	Change TV preferences	16			
	Start a TV demo	16			
	Reset the TV to factory settings	16			
<b>6</b>	<b>Install channels</b>	17			
	Automatically install channels	17			
	Manually install channels	17			
	Rename channels	18			
	Rearrange channels	18			
<b>7</b>	<b>Connect devices</b>	19			
	Back connector	19			
	Side connector	20			
	Connect a computer	21			
	Use Philips EasyLink	22			
	Use a Kensington lock	23			

# 1 Notice

2010 © Koninklijke Philips Electronics N.V. All rights reserved.

Specifications are subject to change without notice. Trademarks are the property of Koninklijke Philips Electronics N.V. or their respective owners. Philips reserves the right to change products at any time without being obliged to adjust earlier supplies accordingly. The material in this manual is believed adequate for the intended use of the system. If the product, or its individual modules or procedures, are used for purposes other than those specified herein, confirmation of their validity and suitability must be obtained. Philips warrants that the material itself does not infringe any United States patents. No further warranty is expressed or implied. Philips cannot be held responsible either for any errors in the content of this document or for any problems as a result of the content in this document. Errors reported to Philips will be corrected and published on the Philips support website as soon as possible.

## **Pixel characteristics**

This LCD product has a high number of colour pixels. Although it has effective pixels of 99.999% or more, black dots or bright points of light (red, green or blue) may appear constantly on the screen. This is a structural property of the display (within common industry standards) and is not a malfunction.

## **Warranty**

No components are user serviceable. Do not open or remove covers to the inside of the product. Repairs may only be done by Philips Service Centres and official repair shops. Failure to do so shall void any warranty, stated or implied.

Any operation expressly prohibited in this manual, any adjustments, or assembly procedures not recommended or authorised in this manual, shall void the warranty.

## **Copyright**

All other registered and unregistered trademarks are the property of their respective owners.

® Kensington and Micro Saver are registered US trademarks of ACCO World Corporation with issued registrations and pending applications in other countries throughout the world.

Portions of this software are copyright © The FreeType Project ([www.freetype.org](http://www.freetype.org)).



HDMI, the HDMI logo and High-Definition Multimedia Interface are trademarks or registered trademarks of HDMI Licensing LLC.

## 2 Important

Read and understand all instructions before you use your TV. If damage is caused by failure to follow instructions, the warranty does not apply.

### Safety

#### Risk of electric shock or fire!

- Never expose the TV to rain or water. Never place liquid containers, such as vases, near the TV. If liquids are spilt on or into the TV, disconnect the TV from the power outlet immediately. Contact Philips Consumer Care to have the TV checked before use.
- Never place the TV, remote control or batteries near naked flames or other heat sources, including direct sunlight. To prevent the spread of fire, keep candles or other flames away from the TV, remote control and batteries at all times.



- Never insert objects into the ventilation slots or other openings on the TV.
- When the TV is swiveled ensure that no strain is exerted on the power cord. Strain on the power cord can loosen connections and cause arcing.

#### Risk of short circuit or fire!

- Never expose the remote control or batteries to rain, water or excessive heat.
- Avoid force coming onto power plugs. Loose power plugs can cause arcing or fire.

#### Risk of injury or damage to the TV!

- Two people are required to lift and carry a TV that weighs more than 25 kg.

- When stand mounting the TV, use only the supplied stand. Secure the stand to the TV tightly. Place the TV on a flat, level surface that can support the combined weight of the TV and the stand.
- When wall mounting the TV, use only a wall mount that can support the weight of the TV. Secure the wall mount to a wall that can support the combined weight of the TV and wall mount. Koninklijke Philips Electronics N.V. bears no responsibility for improper wall mounting that result in accident, injury or damage.

#### Risk of injury to children!

Follow these precautions to prevent the TV from toppling over and causing injury to children:

- Never place the TV on a surface covered by a cloth or other material that can be pulled away.
- Ensure that no part of the TV hangs over the edge of the surface.
- Never place the TV on tall furniture (such as a bookcase) without anchoring both the furniture and TV to the wall or a suitable support.
- Educate children about the dangers of climbing on furniture to reach the TV.

#### Risk of overheating!

- Never install the TV in a confined space. Always leave a space of at least 4 inches or 10 cm around the TV for ventilation. Ensure curtains or other objects never cover the ventilation slots on the TV.

#### Risk of damage to the TV!

- Before you connect the TV to the power outlet, ensure that the power voltage matches the value printed on the back of the TV. Never connect the TV to the power outlet if the voltage is different.

#### Risk of injury, fire or power cord damage!

- Never place the TV or any objects on the power cord.
- To disconnect the TV power cord easily from the power outlet, ensure that you have full access to the power cord at all times.

- When you disconnect the power cord, always pull the plug, never the cable.
- Disconnect the TV from the power outlet and antenna before lightning storms. During lightning storms, never touch any part of the TV, power cord or antenna cable.

### **Risk of hearing damage!**

- Avoid using earphones or headphones at high volumes or for prolonged periods of time.

### **Low temperatures**

- If the TV is transported in temperatures below 5°C, unpack the TV and wait until the TV temperature matches room temperature before connecting the TV to the power outlet.

---

## **Screen care**

- Avoid stationary images as much as possible. Stationary images are images that remain on-screen for extended periods of time. Examples include: on-screen menus, black bars and time displays. If you must use stationary images, reduce screen contrast and brightness to avoid screen damage.
- Unplug the TV before cleaning.
- Clean the TV and frame with a soft, damp cloth. Never use substances such as alcohol, chemicals or household cleaners on the TV.
- Risk of damage to the TV screen! Never touch, push, rub or strike the screen with any object.
- To avoid deformations and colour fading, wipe off water drops as soon as possible.

---

## **Disposal of your old product and batteries**



Your product is designed and manufactured with high quality materials and components, which can be recycled and reused.



When this crossed-out wheeled bin symbol is attached to a product it means that the product is covered by the European Directive 2002/96/EC. Please inform yourself about the local separate collection system for electrical and electronic products.

Please act according to your local rules and do not dispose of your old products with your normal household waste.

Correct disposal of your old product helps to prevent potential negative consequences for the environment and human health.



Your product contains batteries covered by the European Directive 2006/66/EC, which cannot be disposed with normal household waste.

Please inform yourself about the local rules on separate collection of batteries because correct disposal helps to prevent negative consequences for the environmental and human health.

# 3 Your TV

Congratulations on your purchase, and welcome to Philips! To fully benefit from the support that Philips offers, register your TV at [www.philips.com/welcome](http://www.philips.com/welcome).

This section gives you an overview of commonly used TV controls and functions.

## Side controls and indicators

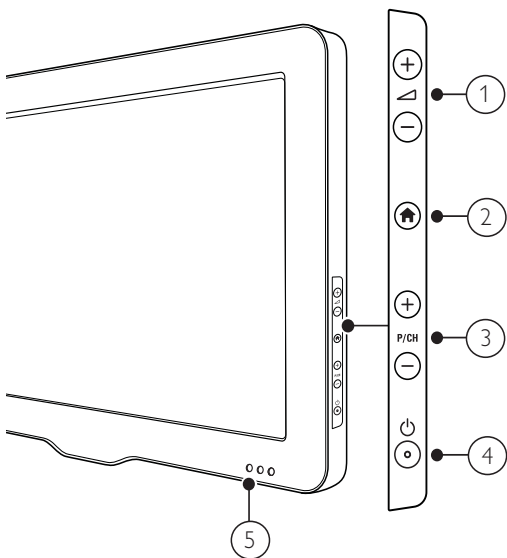

- ①  $\triangleleft$  +/-: Increases or decreases volume.
- ② **⬆** (Home): Toggles the home menu on or off.
- ③ P/CH +/-: Switches to the next or previous channel.
- ④ **⏻** (Power): Switches the product on or off. The product is not powered off completely unless it is physically unplugged.
- ⑤ Standby indicator/ remote control sensor

## Remote control

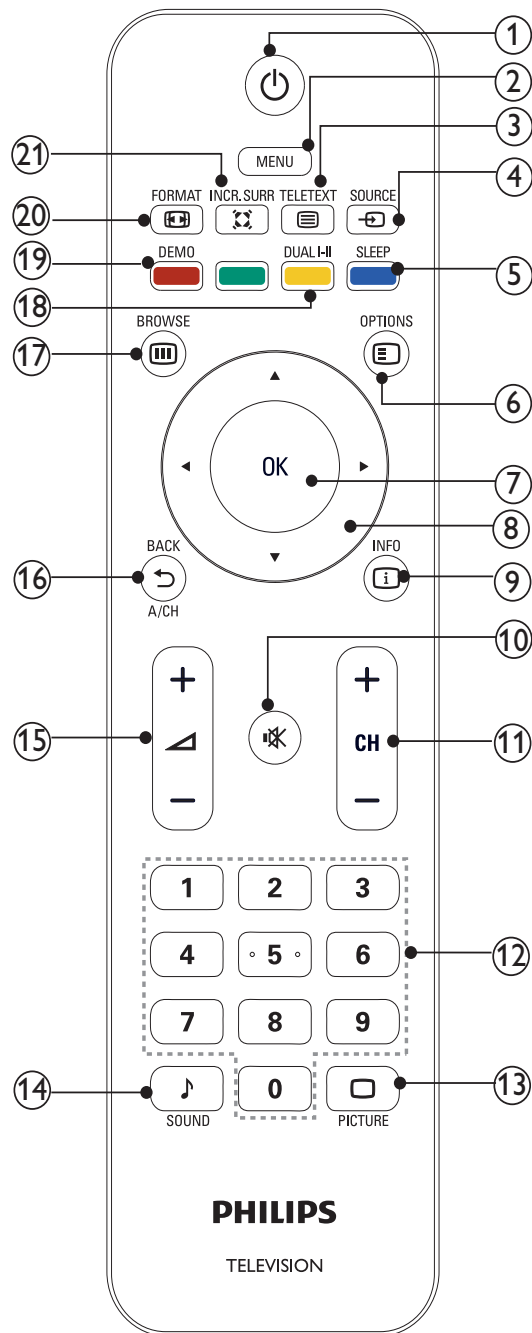

- ① **⏻** (Standby-On)
  - Switches the TV to standby if it is on.
  - Switches on the TV if it is in standby.
- ② **MENU**  
Toggles the main menu on or off.
- ③ **☰** **TELETEXT (Not Used)**  
Toggles teletext on or off.
- ④ **⏻** **SOURCE**  
Selects connected devices.

- ⑤ **SLEEP**  
Sets a delay after which the TV switches to standby.
- ⑥ **☰ OPTIONS**  
Accesses options relating to the current activity or selection.
- ⑦ **OK**  
Confirms an entry or selection and displays the channel grid, when watching TV.
- ⑧ **▲▼◀▶ (Navigation buttons)**  
Navigates menus.
- ⑨ **i INFO**  
Displays programme information, if available.
- ⑩ **🔇 (Mute)**  
Mutes or restores volume.
- ⑪ **CH +/- (CHANNEL +/-)**  
Switches to the next or previous channel. When the TV menu is on, this functions as Page Up/Down.
- ⑫ **0-9 (Numeric buttons)**  
Selects a channel or setting.
- ⑬ **🖼️ PICTURE (Smart picture)**  
Launches the picture menu.
- ⑭ **🎵 SOUND (Smart Sound)**  
Launches the sound menu.
- ⑮ **📶 +/-**  
Increases or decreases volume.
- ⑯ **↶ BACK A/CH**
  - Returns to a previous screen.
  - Toggles between the current channel and the last viewed channel.
- ⑰ **📺 BROWSE**  
Switches between channel grid and programme list.

- ⑱ **DUAL I-II**  
Switches Stereo and Nicam Stereo to Mono. Selects first language (Dual I) or second language (Dual II) in bilingual programmes.
- ⑲ **DEMO**  
Toggles the demonstration menu on or off.
- ⑳ **🖼️ FORMAT**  
Selects a picture format.
- ㉑ **🔊 INCR. SURR**  
Enables Incredible Surround for stereo sources. Enables spatial mode for mono sources.

---

## Remote control usage

When using the remote control, hold it close to the TV and point it at the remote control sensor. Make sure that the line-of-sight between the remote control and TV is not blocked by furniture, walls or other objects.

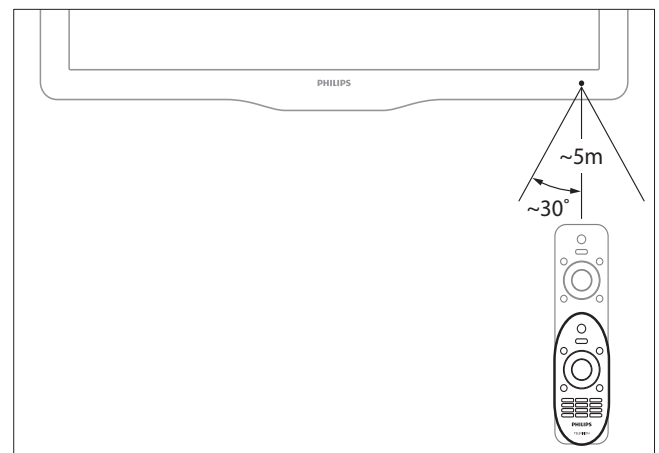



# 4 Use your TV

This section helps you perform basic TV operations.

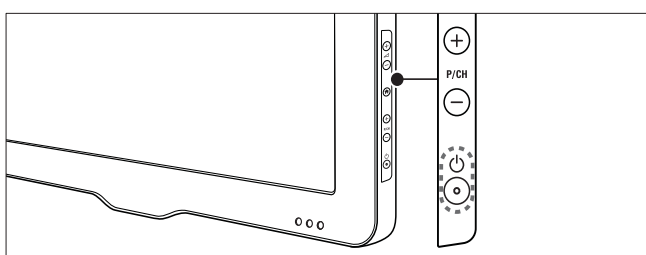
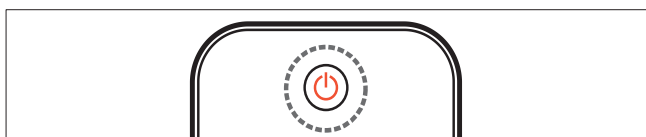
## Switch your TV on/off or to standby



### To switch on

- If the standby indicator is off, press  (**Power**) at the side of the TV.
- If the standby indicator is red, press  (**Standby-On**) on the remote control.

### To switch to standby

- Press  (**Standby-On**) on the remote control.  
↳ The standby indicator switches to red.

### To switch off

- Press  (**Power**) at the side of the TV.  
↳ The standby indicator switches off.

### Tip

- Though your TV consumes very little power when in standby, energy continues to be consumed. When not in use for an extended period of time, disconnect the TV power cable from the power outlet.

## Switch channels

- Press **CH +/-** on the remote control or **P/CH +/-** on the side of the TV.
- Enter a channel number using the **Numeric buttons**.
- Press **OK** to use the channel grid.
- Press  **BACK A/CH** on the remote control to return to the previous channel.





### Note

- When you use a favourite list, you can only select those channels in the list (see 'Select a favourite list' on page 11).

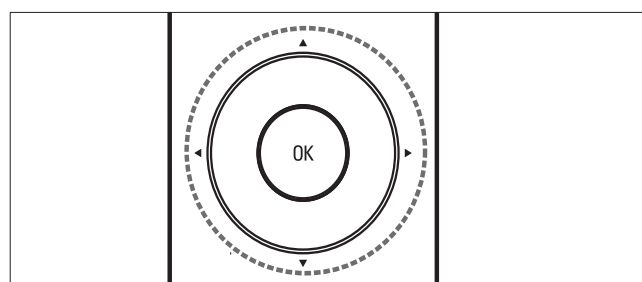
## Switch channels with the channel grid

The channel grid allows you to view all available channels in a grid format.



- 1 Press **OK**.  
↳ The channel grid appears.
- 2 Press     to browse the channel grid.
- 3 Press **OK** to select a channel.



---

## Watch connected devices

### Note

- Switch on the device before selecting it as a source on the TV.

---

## Use the source button

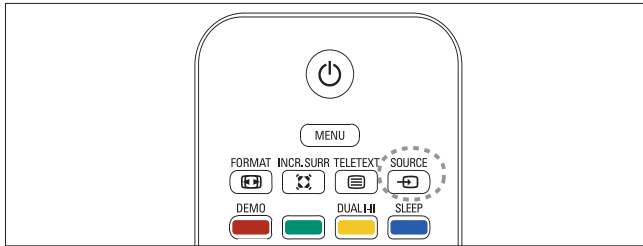

- 1 Press **SOURCE**.  
↳ The source list appears.
- 2 Press **▲▼** to select a device.
- 3 Press **OK** to confirm your choice.  
↳ The TV switches to the selected device.

---

## Adjust TV volume

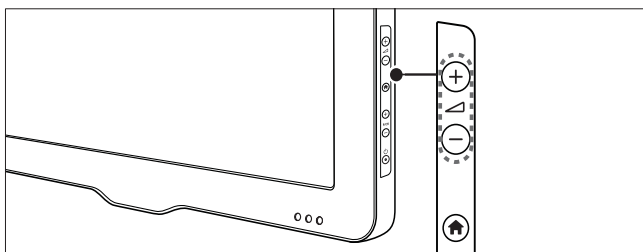
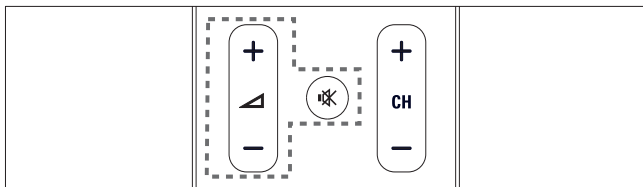

### To increase or decrease volume

- Press **+/-**.

### To mute or unmute sound

- Press **mute** to mute the sound.
- Press **mute** again to restore the sound.

# 5 Use more of your TV

## Access TV menus

Menus help you to install channels, change picture and sound settings and access other features.

- 1 Press **MENU**.  
↳ The menu screen appears.



- 2 Press **▲▼◀▶** to select and navigate through one of the following menus.
  - **[Watch TV]**: Switches back to the aerial source if another source is selected.
  - **[Add new device]**: Adds new devices to the home menu.
  - **[Setup]**: Accesses menus to change picture, sound and other settings.
- 3 Press **OK** to confirm your choice.
- 4 Press **MENU** to exit.

### Tip

- After selecting **[Add new device]**, follow the on-screen instructions to select the correct device and connector.

## Remove devices from the home menu

If a device is no longer connected to the TV, remove it from the home menu.

- 1 Press **MENU**.
- 2 Press **▲▼◀▶** to select a device to remove.
- 3 Press **☰ OPTIONS**.  
↳ The **[Remove device]** list appears.
- 4 Press **OK**, then select **[Remove]** to remove the device.  
↳ The selected device is removed from the home menu.

## Change picture and sound settings

Change picture and sound settings to suit your preferences. You can apply pre-defined settings or change settings manually.

### Use smart picture

Use smart picture to apply pre-defined picture settings.

- 1 Press **□ PICTURE**.  
↳ The **[Smart picture]** menu appears.
- 2 Press **▲▼** to select from the following smart picture settings:
  - **[Personal]**: Lists customised picture settings.
  - **[Vivid]**: Applies rich and dynamic settings.
  - **[Standard]**: Adjusts picture settings to suit most environments and types of video.
  - **[Movie]**: Applies settings for movie viewing.
  - **[Game]**: Applies settings for games.
  - **[Energy saving]**: Applies low-energy settings.
- 3 Press **OK** to confirm your choice.  
↳ The selected smart picture setting is applied.

---

## Manually adjust picture settings

- 1 Press **MENU**.
- 2 Press **▲▼◀▶** to select **[Setup] > [Picture]**.  
↳ The **[Picture]** menu appears.
- 3 Press **▲▼◀▶** to select from the following settings and adjust:
  - **[Smart picture]**: Accesses pre-defined smart picture settings.
  - **[Backlight]**: Adjusts the backlight.
  - **[Contrast]**: Adjusts the intensity of bright areas, keeping dark areas unchanged.
  - **[Brightness]**: Adjusts the intensity and details of dark areas.
  - **[Colour]**: Adjusts colour saturation.
  - **[Sharpness]**: Adjusts sharpness in the image.
  - **[Noise reduction]**: Filters and reduces noise in an image.
  - **[Colour temp.]**: Introduces more orange tones (**[Warm]**) or blue tones (**[Cool]**).
  - **[Dig.CrystalClear]**: Adjusts picture quality to optimal contrast, colour and sharpness.
    - **[Dynamic contrast]**: Enhances contrast.
    - **[Dynamic backlight]**: Adjusts brightness of the TV backlight to match lighting conditions.
    - **[Colour enhancement]**: Makes colours more vivid and improves the details in bright colours. You can switch this feature on or off.
  - **[PC mode]**: Adjusts picture settings when a PC is connected to the TV.
  - **[Picture format]**: Changes the picture format.
  - **[Horizontal shift]**: Adjusts the picture horizontally for PC-VGA or HD input.
  - **[Vertical shift]**: Adjusts the picture vertically for PC-VGA or HD input.

---

## Change picture format

- 1 Press **FORMAT**.  
↳ A picture format bar appears.
- 2 Press **▲▼** to select a picture format.  
↳ The selected picture format is activated.
- 3 Press **OK** to confirm your choice.

---

## Summary of picture formats

The following picture settings can be configured.

 **Note**

- Depending on the format of the picture source, some picture settings are not available.

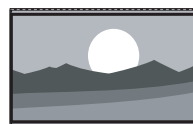

**[Super zoom]**: (Not for HD and PC mode.) Removes the black bars on the side of 4:3 broadcasts. There is minimal distortion.



**[4:3]**: Shows the classic 4:3 format.

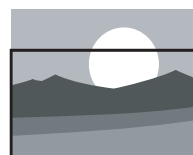

**[Subtitle zoom]**: Displays 4:3 pictures over the full area of the screen, with sub-titles visible. Part of the top of the picture is clipped off.



**[Movie expand 14:9]**: (Not for HD and PC mode.) Scales 4:3 format to 14:9.



**[Movie expand 16:9]**: (Not for HD and PC mode.) Scales 4:3 format to 16:9.



**[Wide screen]**: Scales 4:3 format to 16:9.

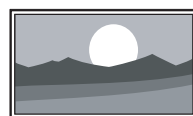

**[Unscaled]**: For HD and PC mode only, and in selected models only. Allows maximum sharpness. Some distortion may be present due to the broadcaster's systems. Set your PC resolution to wide screen mode for best results.

---

## Use smart sound

Use smart sound to apply pre-defined sound settings.

- 1 Press **♪ SOUND**.  
↳ The **[Smart sound]** menu appears.
- 2 Press **▲▼◀▶** to select a smart sound setting:
  - **[Standard]**: Adjusts sound settings to suit most environments and types of audio.
  - **[News]**: Applies settings for spoken audio, such as news.
  - **[Movie]**: Applies settings for movies.
  - **[Personal]**: Applies the settings that were customised in the sound menu.
- 3 Press **OK** to confirm your choice.  
↳ The selected smart sound setting is applied.

## Manually adjust sound settings

- 1 Press **MENU**.
- 2 Press **▲▼◀▶** to select **[Setup] > [Sound]**.  
↳ The **[Sound]** menu appears.
- 3 Press **▲▼◀▶** to select and adjust:
  - **[Smart sound]**: Accesses pre-defined smart sound settings.
  - **[Bass]**: Adjusts the bass level.
  - **[Treble]**: Adjusts the treble level.
  - **[Volume]**: Adjusts the volume.
  - **[Balance]**: Adjusts the balance of the right and left speakers.
  - **[Dual I-II]**: Selects audio languages if dual sound broadcast is available.
  - **[Mono/Stereo]**: Selects mono or stereo if stereo broadcast is available.
  - **[TV speakers]**: Sets the TV speakers on or off, or outputs sound to an EasyLink-compliant device.  
**[EasyLink]** must be activated in the **[Preferences]** menu.
  - **[Surround]**: Enables spatial sound.

- **[Auto volume]**: Automatically reduces sudden volume changes, for example, when switching channels.
- **[Delta volume]**: Levels out volume differences between channels or connected devices. Switch to the connected device before you change the delta volume.

## Create and use list of favourite channels

You can create a list of your preferred TV channels so that you can find those channels easily.

### Select a favourite list

- 1 When watching TV, press **OK** to display the channel grid.
- 2 Press **☰ OPTIONS**.  
↳ The channel options menu appears.
- 3 Press **▲▼** to select **[Select list]**, then press **OK** to enter.  
↳ The channel list options appear.
- 4 Select **[Favourite]**, then press **OK**.  
↳ Only channels in the favourite list appear in the channel grid.

#### Note

- The favourite channel grid is empty until you add channels into the favourite lists.

### Add a channel to a favourite list

- 1 When watching TV, press **OK**.  
↳ The channel grid appears.
- 2 Press **▲▼◀▶** to select a channel to add to a favourite list.
- 3 Press **☰ OPTIONS**.  
↳ The channel options menu appears.
- 4 Select **[Mark as favourite]**, then press **OK**.  
↳ The channel is added to the favourite list.

## Note

- All favourite channels are marked by an asterisk in the channel grid.

## Remove a channel from a favourite list

- 1 When watching TV, press **OK**.  
↳ The channel grid appears.
- 2 Press **▲▼◀▶** to select a channel to remove.
- 3 Press **☰** **OPTIONS**.
- 4 Select **[Unmark as fav.]**, then press **OK**.  
↳ The channel is removed.

## Use the TV clock

You can display a clock on the TV screen.  
(RF only)

### Set the TV clock

- 1 Press **MENU**.
- 2 Select **[Setup] > [Features] > [Clock]**  
↳ The **[Clock]** menu appears.
- 3 Press **▲▼◀▶** or the **Numeric buttons** to enter the time.
- 4 Select **[Done]** and press **OK** to confirm.
- 5 Press **MENU** to exit.

### Display the TV clock

- 1 When watching TV, press **☰** **OPTIONS**.  
↳ The TV option menu appears.
- 2 Select **[Clock]**.
- 3 Press **OK**.

## Note

- To disable the clock, repeat the above procedure.

## Use timers

You can set timers to switch the TV to standby at a specified time.

### Tip

- Set the TV clock before you use timers.

## Automatically switch the TV to standby (sleep timer)

Sleep timer switches the TV to standby after a pre-defined period of time.

### Tip

- You can switch off your TV earlier or reset the sleep timer during the countdown.

- 1 Press **MENU**.
- 2 Press **▲▼◀▶** to select **[Setup] > [Features] > [Sleep timer]**.  
↳ The **[Sleep timer]** menu appears.
- 3 Press **◀▶** to set the sleep time.  
↳ The sleeptimer can be up to 180 minutes in steps of five minutes. If set to zero, the sleep timer is switched off.
- 4 Press **OK** to switch on the sleep timer.  
↳ The TV switches to standby after the specified time.

## Automatically switch the TV on (on timer)

You can switch on the TV from standby to a specific channel at a specified time.

- 1 Press **MENU**.
- 2 Press **▲▼◀▶** to select **[Setup] > [Features] > [On timer]**.
- 3 Press **▶** to enter the **[On timer]** menu.
  - **[Activate]**: Selects how often the TV is switched on.

- **[Time]:** Sets the time to switch on the TV.
- **[Programme no.]:** Selects the channel.

4 Press **MENU** to exit.



Tip

- Select **[On timer] > [Activate] > [Off]** to disable this feature.

## Use TV locks

You can prevent your children from watching certain programmes or channels by locking the TV controls.

### Set or change your PIN code

- 1 Press **MENU**.
- 2 Press **▲▼◀▶** to select **[Setup] > [Features] > [Set code] / [Change code]**.  
↳ The **[Set code] / [Change code]** menu appears.
- 3 Enter your code using the **Numeric buttons**.  
↳ Follow the on-screen instructions to create or change your PIN code.



Tip

- If you forget your code, enter '8888' to override any existing codes.

### Lock or unlock the TV

Lock the TV to prevent access to all channels and connected devices.

- 1 Press **MENU**.
- 2 Press **▲▼◀▶** to select **[Setup] > [Features] > [TV lock]**.  
↳ You are prompted to enter your PIN code.

3 Enter your code with the **Numeric buttons**.

↳ The **[TV lock]** menu appears.

4 Press **▲▼** to select **[Lock]** or **[Unlock]**.

5 Press **OK** to confirm.

↳ All channels and connected devices are locked or unlocked.

6 Press **MENU** to exit.



Note

- If you select **[Lock]**, you have to enter your code every time you turn on your TV.

### Lock or unlock one or more channels

- 1 When watching TV, press **OK** to display the channel grid.
- 2 Press **▲▼◀▶** to select a channel to lock or unlock.
- 3 Press **☰** **OPTIONS**.
- 4 Press **▲▼** to select **[Lock channel]** or **[Unlock channel]**, then press **OK**.  
↳ You are prompted to enter your PIN code.
- 5 Enter your code and press **OK**.  
↳ If the channel is locked, a lock icon is displayed.
- 6 Repeat the process to lock or unlock more channels.



Note

- Switch the TV off and on again for the change to take effect.
- If you access the locked channels, you are prompted to enter your PIN code.

---

## View photos and play music from a USB storage device

Use the USB connector to view photos or listen to music stored on a USB storage device.

### Note

- Your TV only supports USB flash drives in FAT/FAT32 format. It does not support other devices that can be connected to the USB port including but not limited to the following: portable storage devices such as external hard drives and mini hard drives, MP3 player, digital camera, phone, portable video player, portable multimedia player.

---

## Connect a USB storage device and enter the content browser

- 1 Turn on the TV.
- 2 Connect the USB storage device to the TV.
- 3 Press **MENU**.  
↳ The home menu appears.
- 4 Press **▲▼◀▶** to select **[Browse USB]**.
- 5 Press **OK** to confirm.  
↳ The USB content browser appears.

### Tip

- Press **⏏ BROWSE** to switch between thumbnail and file browsing views.

---

## View photos

- 1 In the USB browser, press **▶** to enter the **[Picture]** folder.
- 2 Press **▲▼◀▶** to select a photo or a photo album.
- 3 Press **OK** to view a full screen image of the photo.

### Tip

- When in full screen mode, press **◀▶** to move between photos.

---

## View a slide show of your photos

- 1 When a full screen image of a photo is displayed, press **OK**.  
↳ A slide show begins from the selected photo.
- 2 Press the following buttons to control the slide show:
  - **OK** to pause the slide show.
  - **◀▶** to go back or move forward to the next image.
  - **↶ BACK** to stop the slide show.

---

## Change slide show settings

- 1 When viewing a slide show, press **⏏ OPTIONS**.  
↳ The slide show options menu appears.
- 2 Press **▲▼◀▶** to select from the following settings and adjust:
  - **[Start Slideshow] / [Stop Slideshow]**: Starts or stops a slide show.
  - **[Slideshow transitions]**: Displays a list of transition styles.
  - **[Slideshow frequency]**: Sets the amount of time that a picture is shown.
  - **[Rotate image]**: Rotates a picture.
  - **[Show info]**: Displays the picture name, date, size and next picture in the slide show.
- 3 Press **OK** to confirm the setting change.

---

## Listen to music

- 1 In USB browser view, select **[MUSIC]** and press **▶** to enter.
- 2 Press **▲▼◀▶** to select a music track or album.
- 3 Press **OK** to play the selected music.

Button	Function
<b>OK</b>	Pause, resume play or stop playback.
<b>◀/▶</b>	Go to the previous or next music.

---

## Music settings

When listening to music, press **☰ OPTIONS** to access one of the following music settings.

- **[Start playback] / [Stop playback]**: Starts or stops the music.
- **[Play mode]**:
  - **[Play once]**: Disables repeat play and plays a song once.
  - **[Repeat]**: Repeats a song.
  - **[Shuffle]**: Plays songs randomly.
- **[Show info]**: Displays the file name.
- **[TV speakers]**: Sets the TV speakers on or off.

---

## View a slideshow with music

You can view a picture slide show with background music.

- 1 Select an album of songs.
- 2 Press **OK**.
- 3 Press **↩ BACK** to return to the USB content browser.
- 4 Select an album of pictures.
- 5 Press **OK** to view photo.
- 6 Press **OK** again to start slide show.

---

## Disconnect a USB storage device



### Caution

- Follow this procedure to avoid damage to your USB storage device.

- 1 Press **↩ BACK** to exit the USB browser.
- 2 Wait for five seconds then disconnect the USB storage device.

---

## Update the TV software

Philips continuously tries to improve its products and we recommend that you update the TV software when updates are available. Check [www.philips.com/support](http://www.philips.com/support) for availability.

---

## Check the current software version

- 1 Press **MENU**.
- 2 Select **[Setup] > [Software update] > [Current software]**.
  - ↳ The TV displays the current software information.

---

## Download the software

- 1 On your PC, open a web browser and go to [www.philips.com/support](http://www.philips.com/support).
- 2 Download the latest software upgrade file to your PC.
- 3 Decompress the ZIP-file.
- 4 Copy the autorun.upg file to the root directory of the USB device.



---

## Update using a USB device

Connect your USB device to the USB port at the side of your TV.

- 1 If the software update screen does not appear automatically, select **[Setup]** > **[Software update]** > **[Local updates]**.
- 2 Press **OK** to update the TV software manually.
- 3 Follow the on-screen instructions to complete the update.

### Note

- The TV restarts after the software update is complete.

---

## Change TV preferences

Use the preferences menu to customise your TV settings.

- 1 Press **MENU**.
- 2 Select **[Setup]** > **[Installation]** > **[Preferences]**.
  - **[Location]**: Optimises TV settings for your location - home or shop.
  - **[Volume bar]**: Displays the volume bar when you adjust the volume.
  - **[EasyLink]**: Enables one-touch play and one-touch standby between EasyLink-compliant devices.
  - **[Pixel Plus Link]**: Overrides the settings of connected devices and uses the settings of the TV.
  - **[E-sticker]**: For shop mode only. Sets the location of the e-sticker.
- 3 Press **MENU** to exit.

---

## Start a TV demo

You can use demonstrations to better understand the features of your TV. Some demos are not available on certain models. Available demos are displayed in the menu list.

- 1 Press **DEMO** on the remote control.
- 2 Press **▲▼** to select a demo and press **OK** to view it.
- 3 Press **↶ BACK** to exit.

---

## Reset the TV to factory settings

You can restore the default picture and sound settings of your TV. The channel installation settings remain the same.

- 1 Press **MENU**.
- 2 Select **[Setup]** > **[Installation]** > **[Factory settings]**.
- 3 Press **▶** to enter **[Factory settings]**.
- 4 Select **[Reset]** to start resetting.
- 5 Press **OK**.
- 6 Press **MENU** to exit.

## 6 Install channels

The first time you set up your TV, you are prompted to select a menu language and to install TV and digital radio channels (if available). This chapter provides instructions on how to re-install and fine tune channels.

### Automatically install channels

This section describes how to search and store channels automatically.

- 1 Press **MENU**.
- 2 Select **[Setup] > [Installation] > [Channel install.] > [Channel assistant]**.
- 3 Press **OK**.
- 4 Follow the on-screen instructions to install channels.

### Manually install channels

This section describes how to search and store analogue TV channels manually.

#### Step 1 Select your system

##### Note

- Skip this step if your system settings are correct.

- 1 Press **MENU**.
- 2 Press **▲▼◀▶** to select **[Setup] > [Installation] > [Channel install.] > [Manual install]**.  
↳ The **[Manual install]** menu appears.
- 3 Press **▲▼** to select **[Colour system]**, then press **▶** to enter.
- 4 Select your system, then press **OK** to confirm.
- 5 Repeat the previous steps for **[Sound system]**.
- 6 Press **MENU** to exit.

#### Step 2 Search and store new TV channels

- 1 Press **MENU**.
- 2 Press **▲▼◀▶** to select **[Setup] > [Installation] > [Channel install.] > [Manual install]**.  
↳ The **[Manual install]** menu appears.
- 3 Press **▲▼** to select **[Search]**, then press **▶** to enter.
- 4 Press **Numeric buttons** to manually enter the three-digit frequency.
- 5 Press **OK** to begin search.  
↳ If a channel is unavailable at the selected frequency, the system searches for the next available channel.
- 6 Press **↶ BACK** when the new channel is found.
- 7 Press **▲▼** to select **[Store new channel]** to store the new channel under a new channel number.
- 8 Press **▶** to enter **[Store new channel]**.
- 9 Select **[OK]**, then press **OK** to store the new channel.
- 10 Press **MENU** to exit.

#### Step 3 Fine-tune analogue channels

- 1 Press **MENU**.
- 2 Press **▲▼◀▶** to select **[Setup] > [Installation] > [Channel install.] > [Manual install]**.  
↳ The **[Manual install]** menu appears.
- 3 Press **▲▼** to select **[Fine-tune]**, then press **▶** to enter.
- 4 Press **▲▼** to adjust frequency.
- 5 Press **OK** to confirm.
- 6 Press **▲▼** to select **[Store curr. chan.]** to store the channel number.
- 7 Press **▶** to enter **[Store curr. chan.]**.
- 8 Select **[OK]**, then press **OK** to store current channel.
- 9 Press **MENU** to exit.

---

## Skip channels

- 1 When watching TV, switch to the channel you want to skip.
- 2 Press **MENU**.
- 3 Press **▲▼◀▶** to select **[Setup]** > **[Installation]** > **[Channel install.]** > **[Manual install.]**.  
↳ The **[Manual install]** menu appears.
- 4 Press **▲▼** to select **[Skip channel]**, then press **▶** to enter.
- 5 Press **▲▼** to select **[Skip]** > **[Yes]**, then press **OK** to skip current channel.  
↳ The selected channel is skipped when you press **CH +/-** on your remote control or view the channel grid.
- 6 Repeat the previous steps to skip more channels.



### Tip

- Use the **Numeric buttons** on the remote control to access the skipped channel.
- To access the skipped channel, repeat steps 1-5 and select **[No]** to restore.

---

## Rename channels

You can rename channels. The name appears when you select the channel.

- 1 When watching TV, press **OK** to display the channel grid.
- 2 Select the channel to rename.
- 3 Press **☰ OPTIONS**.  
↳ The channel options menu appears.
- 4 Press **▲▼** to select **[Rename channel]**, then press **OK**.  
↳ A text input box appears.
- 5 Press **▲▼◀▶** to select characters.
- 6 Press **OK** to confirm each character.
- 7 Select **[Done]**, then press **OK** to finish renaming channels.



### Tip

- The device name can be up to six characters long.
- Press **[Aa]** to change an uppercase letter to a lowercase letter and vice versa.

---

## Rearrange channels

After you install channels, you can rearrange the order in which they appear:

- 1 When watching TV, press **OK** to display the channel grid.
- 2 Press **☰ OPTIONS**.  
↳ The channel options menu appears.
- 3 Press **▲▼** to select **[Reorder]**, then press **OK**.
- 4 Select the channel to rearrange, then press **OK**.  
↳ The selected channel is highlighted.
- 5 Press **▲▼◀▶** to move the highlighted channel to the desired location, then press **OK**.
- 6 Press **☰ OPTIONS**.  
↳ **[Done reordering]** appears on the screen.
- 7 Press **OK** to confirm.
- 8 Press **↶ BACK** to exit the channel grid.

# 7 Connect devices

This section describes how to connect various devices with different connectors and supplements examples provided in the Quick Start.

**Caution**

- Disconnect the mains cord cable before connecting devices.

**Note**

- Different types of connectors may be used to connect a device to your TV, depending on availability and your needs.

## Back connector

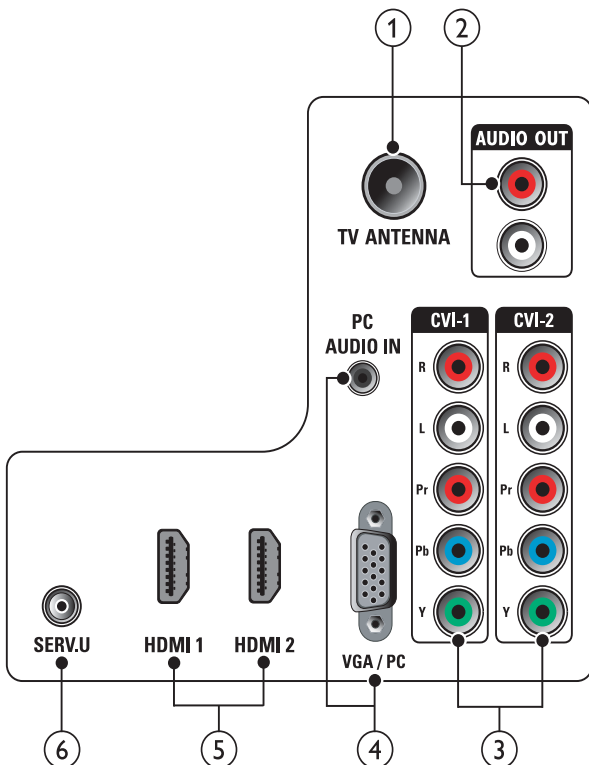

- ① **TV ANTENNA**  
Signal input from an antenna, cable or satellite.

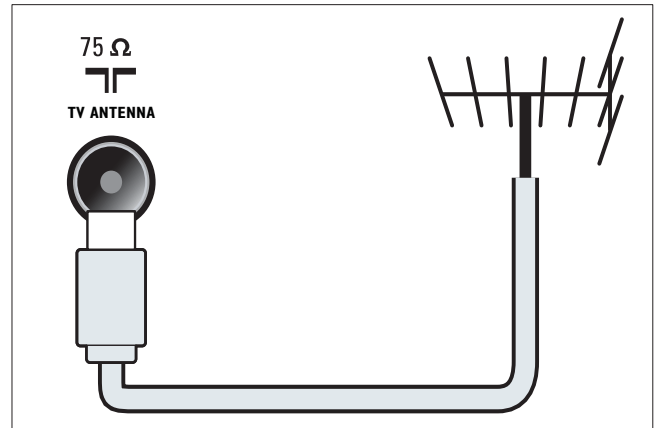

- ② **AUDIO OUT**  
Analogue audio output to home theatres and other audio systems.

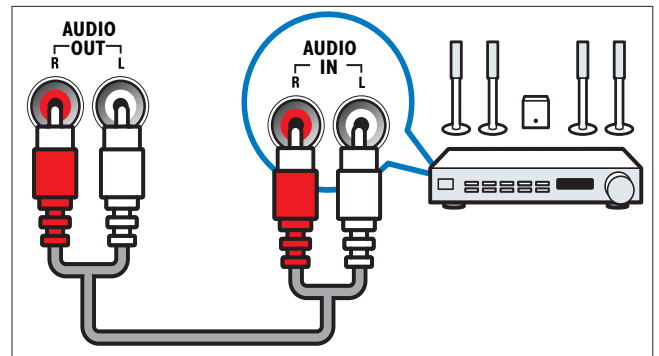

- ③ **CVI 1/CVI 2 (Y Pb Pr and AUDIO L/R)**  
Analogue audio and video input from analogue or digital devices such as DVD players or game consoles.

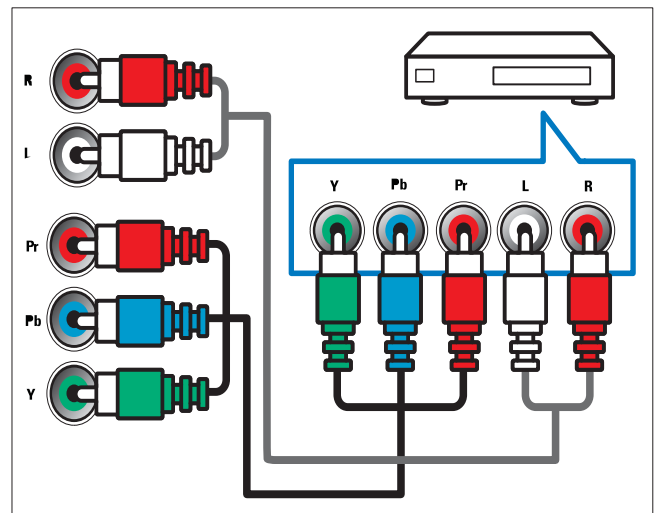

- ④ **PC IN (VGA/PC and AUDIO IN)**  
Audio and video input from a computer.

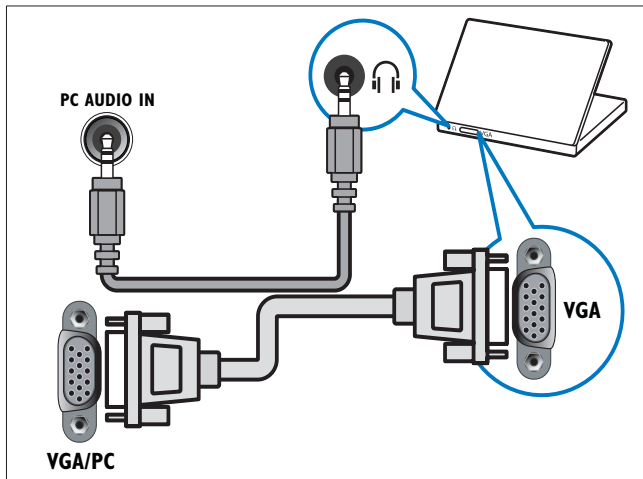

- ⑤ **HDMI 1 / HDMI 2**  
Digital audio and video input from high-definition digital devices such as Blu-ray players.

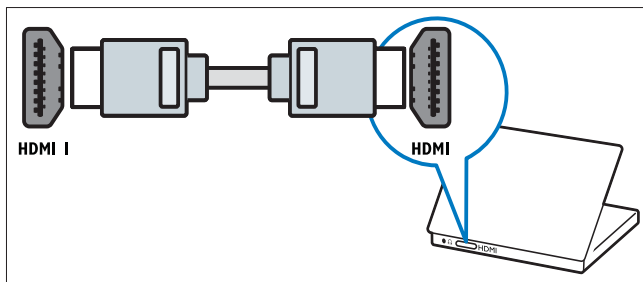

Connections via DVI or VGA require an additional audio cable.

- ⑥ **SERV. U**  
For use by service personnel only.

## Side connector

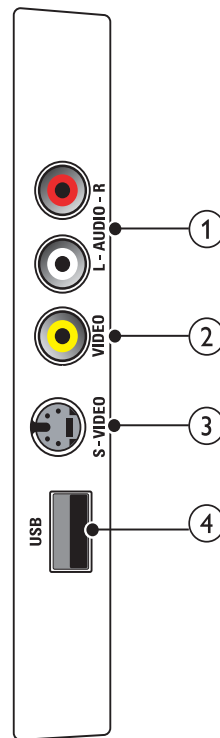

- ① **AUDIO L/R**  
Audio input from analogue devices connected to **VIDEO**.

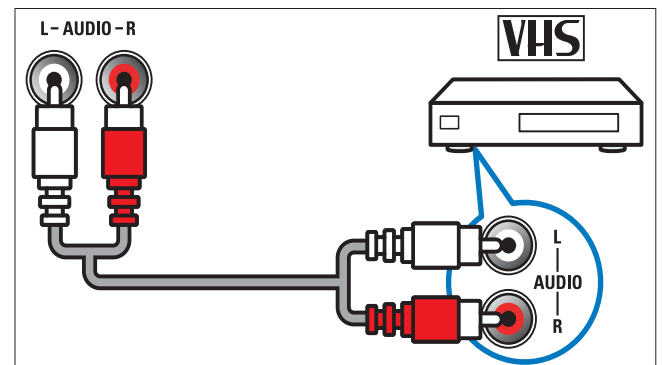

## ② VIDEO

Composite video input from analogue devices such as VCRs.

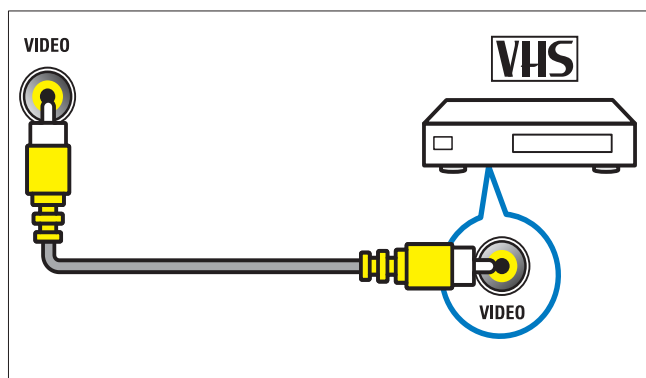

## ③ S-VIDEO

S-Video (side) to be used with Audio L/R connectors for camcorder, game console, etc. When you use the S-Video (side) for video signals, do not use the Composite video (side) input for video signals.

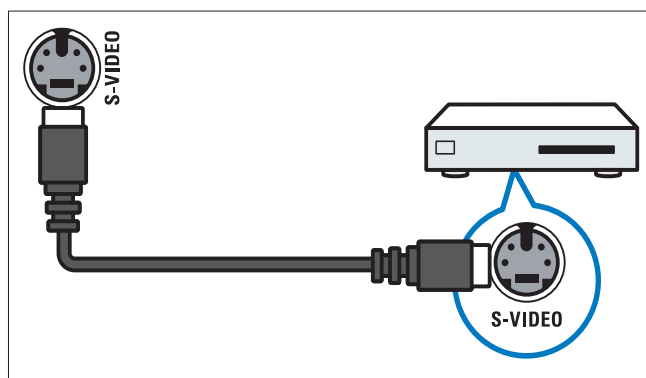

## ④ USB

Data input from USB storage devices.

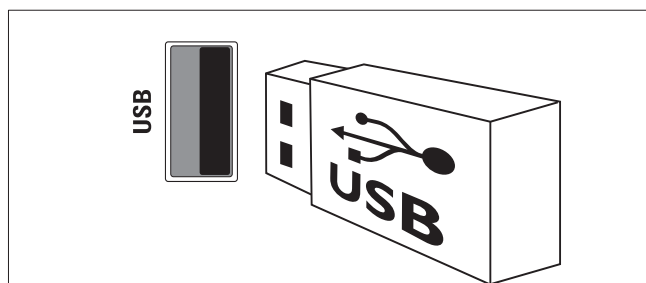

## Connect a computer

Before you connect a computer to the TV

- Set the monitor refresh rate on your computer to 60Hz.
- Press **FORMAT** and change the TV picture format to **[Unscaled]**.

Connect a computer with one of the following connectors:

### Note

- Connections via DVI or VGA require an additional audio cable.

- **HDMI cable**

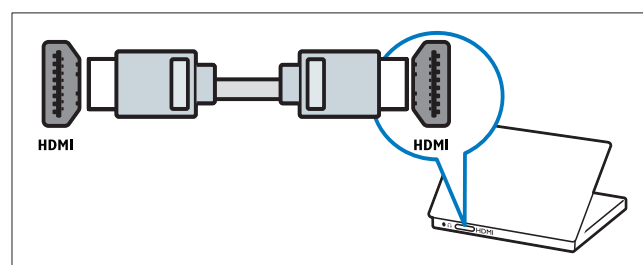

- **DVI-HDMI cable**

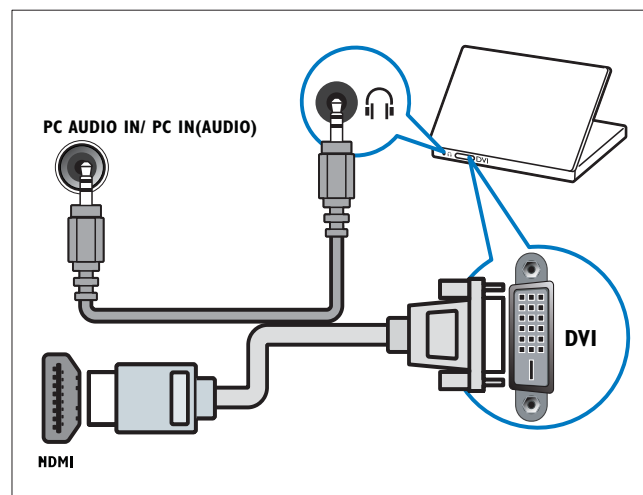

- HDMI cable and HDMI-DVI adaptor

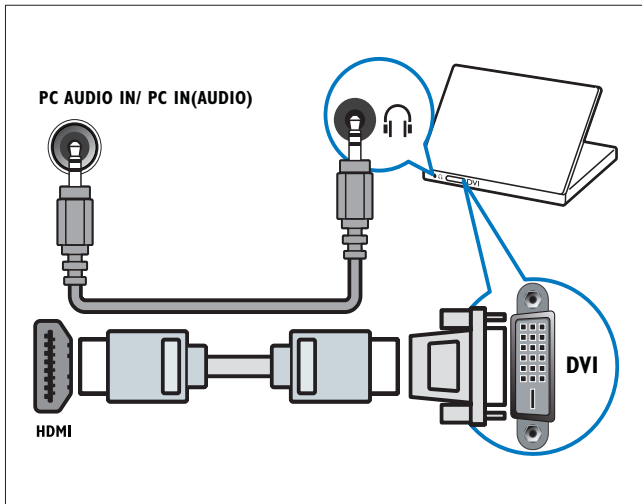

- VGA cable

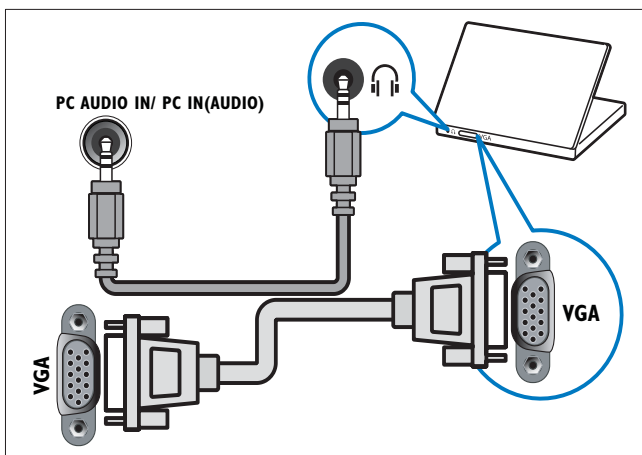

## Use Philips EasyLink

Your TV supports Philips EasyLink, which uses the HDMI CEC (Consumer Electronics Control) protocol. EasyLink-compliant devices that are connected through HDMI connectors can be controlled by a single remote control.

### Note

- The EasyLink-compliant device must be switched on and selected as the source.
- Philips does not guarantee 100% interoperability with all HDMI CEC devices.

## EasyLink features

### One-touch play

When you connect your TV to devices that support one-touch play, you can control your TV and the devices with one remote control.

### One-touch standby

When you connect your TV to devices that support standby, you can use your TV remote control to put your TV and all connected HDMI devices in standby mode.

### System audio control

When you connect your TV to HDMI CEC compliant devices, your TV can switch automatically to play audio from the connected device.

To use one-touch audio, you must map the audio input from the connected device to your TV.

You can use the remote control from the connected device to adjust the volume.

## Enable or disable EasyLink

### Note

- Do not enable Philips EasyLink if you do not intend to use it.

- 1 Press **MENU**.
- 2 Press **▲▼◀▶** to select **[Setup] > [Installation] > [Preferences] > [EasyLink]**.
- 3 Select **[On]** or **[Off]**.

## Use one-touch play

- 1 After enabling EasyLink, press play on your device.
  - ↳ The TV automatically switches to the correct source.

## Use one-touch standby

- 1 Press **⏻ (Standby-On)** on the TV's or device's remote control.
  - ↳ The TV and all connected HDMI devices switch to standby.

## Set TV speakers to EasyLink mode

When you play content from an EasyLink compliant home theater, the TV speakers are automatically muted.

- 1 Press **MENU**.
- 2 Press **▲▼◀▶** to select **[Setup] > [Sound] > [TV speakers] > [Auto EasyLink]**.
  - ↳ The TV speakers are turned off automatically when content from an Easylink compliant system is detected.
- 3 Select **[Setup] > [Sound] > [TV speakers] > [On]** to disable system audio control and enable the TV speakers.

## Use a Kensington lock

There is a Kensington security slot at the back of the TV. Prevent theft by looping a Kensington lock between the slot and a permanent object, such as a heavy table.

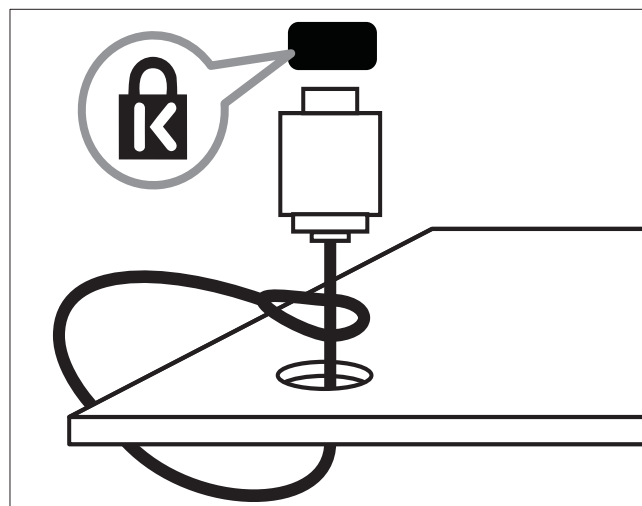



# 8 Product information

Product information is subject to change without notice. For detailed product information, go to [www.philips.com/support](http://www.philips.com/support).

---

## Supported display resolutions

### Computer formats (HDMI)

- Resolution - refresh rate:
  - 640 × 480 - 60Hz
  - 800 × 600 - 60Hz
  - 1024 × 768 - 60Hz
  - 1280 × 768 - 60Hz
  - 1280 × 1024 - 60Hz
  - 1360 × 768 - 60Hz
  - 1920 × 1080 - 60Hz

### Computer formats (VGA)

- Resolution - refresh rate:
  - 640 × 480 - 60Hz
  - 800 × 600 - 60Hz
  - 1024 × 768 - 60Hz
  - 1280 × 768 - 60Hz
  - 1280 × 1024 - 60Hz
  - 1360 × 768 - 60Hz

### Video formats

- Resolution - refresh rate:
  - 480i - 60Hz
  - 480p - 60Hz
  - 576i - 50Hz
  - 576p - 50Hz
  - 720p - 50Hz, 60Hz
  - 1080i - 50Hz, 60Hz
  - 1080p - 24Hz, 25Hz, 30Hz, 50Hz, 60Hz

---

## Multimedia

- Supported storage device: USB (Only FAT 16 or FAT 32 USB storage devices are supported)
- Supported multimedia file formats:
  - Images: JPEG
  - Audio: MP3



### Note

- Multimedia file names must not exceed 128 characters.

---

## Tuner/Reception/Transmission

- Antenna input: 75ohm coaxial (IEC75)
- TV system: PAL
- Video playback: NTSC, PAL

---

## Remote control

- Batteries: 2 × AAA (R03 type)

---

## Power

- Mains power: 220-240 V ~, 50-60 Hz
- Standby power: < 1 W
- Ambient temperature: 5 to 40 degrees Celsius

## Supported TV mounts

To mount the TV, purchase a Philips TV mount or a VESA-compatible TV mount. To prevent damage to cables and connectors, be sure to leave a clearance of at least 2.2 inches or 5.5cm from the back of the TV.



### Warning

- Follow all instructions provided with the TV mount. Koninklijke Philips Electronics N.V. bears no responsibility for improper TV mounting that results in accident, injury or damage.

TV screen size (inches)	Required pitch (mm)	Required mounting bolts
32	200 × 200	4 × M6
42	300 × 200	4 × M6
47	400 × 300	4 × M8

## Product specification

Design and specifications are subject to change without notice.

### 32PFL3605

- Without TV stand
  - Dimension (WxHxD): 795.6 × 508.3 × 93 (mm)
  - Weight: 8.3 kg
- With TV stand
  - Dimension (WxHxD): 795.6 × 556.2 × 221.5 (mm)
  - Weight: 9.9 kg

### 42PFL3605

- Without TV stand
  - Dimension (WxHxD): 1018.5 × 635.7 × 83 (mm)
  - Weight: 11.5 kg
- With TV stand
  - Dimension (WxHxD): 1018.5 × 683.5 × 236.4 (mm)
  - Weight: 13.5 kg

### 47PFL3605

- Without TV stand
  - Dimension (WxHxD): 1129.8 × 700.7 × 83 (mm)
  - Weight: 18 kg
- With TV stand
  - Dimension (WxHxD): 1129.8 × 749.6 × 270 (mm)
  - Weight: 20.5 kg

# 9 Troubleshooting

This section describes commonly encountered issues and accompanying solutions.

---

## General TV issues

### The TV does not switch on:

- Disconnect the power cable from the power outlet. Wait for one minute then reconnect it.
- Check that the power cable is securely connected.

### The remote control is not working properly:

- Check that the remote control batteries are correctly inserted according to the +/- orientation.
- Replace the remote control batteries if they are flat or weak.
- Clean the remote control and TV sensor lens.

### The standby light on the TV blinks red:

- Disconnect the power cable from the power outlet. Wait until the TV cools down before reconnecting the power cable. If the blinking reoccurs, contact Philips Consumer Care.

### You forgot the code to unlock the TV lock feature

- Enter '8888'.

### The TV menu is in the wrong language.

- Change the TV menu to your preferred language.

### When turning the TV on/off/to standby, you hear a creaking sound from the TV chassis:

- No action is required. The creaking sound is normal expansion and contraction of the TV as it cools down and warms up. This does not impact performance.

### Cannot remove 'e-sticker' banner displayed on the TV.

- To remove the logos and images, set the location of your TV to home.
  1. Press **MENU**.
  2. Select **[Setup] > [Installation] > [Preferences] > [Location]**.
  3. Select **[Home]** and press **OK**.

---

## TV channel issues

### Previously installed channels do not appear in the channel list:

- Check that the correct channel list is selected.

---

## Picture issues

### The TV is on, but there is no picture:

- Check that the antenna is properly connected to the TV.
- Check that the correct device is selected as the TV source.

### There is sound but no picture:

- Check that the picture settings are correctly set.

### There is poor TV reception from an antenna connection:

- Check that the antenna is properly connected to the TV.
- Loudspeakers, unearthed audio devices, neon lights, high buildings and other large objects can influence reception quality. If possible, try to improve the reception quality by changing the antenna direction or moving devices away from the TV.
- If reception on only one channel is poor, fine tune this channel.

### There is poor picture quality from connected devices:

- Check that the devices are connected properly.
- Check that the picture settings are correctly set.

**The TV did not save your picture settings:**

- Check that the TV location is set to the home setting. This mode offers you the flexibility to change and save settings.

**The picture does not fit the screen; it is too big or too small:**

- Try using a different picture format.

**The picture position is incorrect:**

- Picture signals from some devices may not fit the screen correctly. Check the signal output of the device.

---

## Sound issues

**There is a picture but sound quality is poor:** **Note**

- If no audio signal is detected, the TV automatically switches the audio output off — this does not indicate malfunction.

- Check that all cables are properly connected.
- Check that the volume is not set to 0.
- Check that the sound is not muted.

**There is a picture but the sound quality is poor:**

- Check that the sound settings are correctly set.

**There is a picture but sound comes from one speaker only:**

- Verify that sound balance is set to the centre.

---

## HDMI connection issues

**There are problems with HDMI devices:**

- Note that HDCP (High-bandwidth Digital Content Protection) support can delay the time taken for a TV to display content from a HDMI device.
- If the TV does not recognize the HDMI device and no picture is displayed, try switching the source from one device to another and back again.

- If there are intermittent sound disruptions, check that output settings from the HDMI device are correct.
- If you use an HDMI-to-DVI adapter or HDMI to DVI cable, check that an additional audio cable is connected to **AUDIO IN** (mini-jack only).

---

## Computer connection issues

**The computer display on the TV is not stable:**

- Check that your PC uses the supported resolution and refresh rate.
- Set the TV picture format to unscaled.

---

## Contact us

If you cannot resolve your problem, refer to the FAQs for this TV at [www.philips.com/support](http://www.philips.com/support).

If the problem remains unresolved, contact Philips Consumer Care in your country as listed in this user manual.

**Warning**

- Do not attempt to repair the TV yourself. This may cause severe injury, irreparable damage to your TV or void your warranty.

**Note**

- Make a note of your TV model and serial number before you contact Philips. These numbers are printed on the back of the TV and on the packaging.

# 10 Index

---

<b>A</b>	
analogue	
fine-tune	17
<hr/>	
<b>B</b>	
batteries	24, 4
bracket for wall mount	25
<hr/>	
<b>C</b>	
care	4
channel grid	7
channels	
favourites list	11
fine-tune	17
grid	7
install	
automatic	17
manual	17
list	11
lock	13
rename	18
reorder/rearrange	18
skip channels	18
switch	7
troubleshooting	26
tune	17
child lock	
lock channels	13
lock connected devices	13
PIN code	13
clock	
display	12
computer	
connect	27, 21
display resolution	24
connect	
PC	27, 21
connectors	
HDMI	27, 19
overview	19
USB	14
controls	5
<hr/>	
<b>D</b>	
default settings	16
demo	16
devices	8
devices	
add to home menu	9
remove	9
watch	8
digital services	
disconnect USB	15
display	
resolution	24
dispose	4
<hr/>	
<b>E</b>	
EasyLink	
disable	23
enable	23
one-touch play	23
one-touch standby	23
system audio control	23
end of life	4
environmental care	4
e-sticker	16
<hr/>	
<b>F</b>	
factory settings	16
favourites list	
create list	11
view list	11
fine-tune channels	17
<hr/>	
<b>H</b>	
HDMI	27, 19
home mode	16
<hr/>	
<b>I</b>	
install channels	
automatic	17
manual	17

<b>K</b>	
Kensington lock	23
<b>L</b>	
language	
troubleshoot	26
list	
favourites list	11
location	
home or shop	16
lock	
Kensington lock	23
lock channels	13
lock connected devices	13
PIN code	13
<b>M</b>	
menu	
main menu	9
MPEG artifact reduction	10
multimedia	24
music	
USB	15
with slideshow	15
mute TV speakers	23
<b>O</b>	
on timer	12
one-touch play	23
one-touch standby	23
<b>P</b>	
PC	
connect	27
resolution	24
picture format	
change	10
troubleshooting	26
picture settings	9
PIN code	13
pixel plus link	16
power	24
power consumption	24
preferences	16
product specifications	24

<b>R</b>	
rearrange channels	18
reception	26
recycle	4
register product	5
remote control	
batteries	24, 4
overview	5
technical specifications	24
rename channels	18
reorder channels	18
resolution	24
restore default	16
<b>S</b>	
safety	3
screen care	4
settings	
picture	10
sound	11
shop mode	16
side controls	5
skip channels	18
slideshow	
view	14
with music	15
smart picture	9
smart settings	9, 11
smart sound	11
software	
version	15
sound settings	11
specifications	24
standby	7
switch	
channels	7
on and off	7
source	8

---

<b>T</b>	
<b>technical specifications</b>	24
<b>timer</b>	
on timer	12
sleep timer	12
standby	12
<b>transmission</b>	24, 26
<b>transporting</b>	3
<b>troubleshooting</b>	26
<b>TV lock</b>	
lock channels	13
lock connected devices	13
PIN code	13
<b>TV overview</b>	5

---

<b>U</b>	
<b>USB</b>	
disconnect USB	15
listen to music	15
update software	16
view photos	14

---

<b>V</b>	
<b>video format</b>	
technical specifications	24
<b>volume</b>	
adjust	8
automatic levelling	11
delta	11
mute	8, 23

---

<b>W</b>	
<b>wall mount</b>	3, 25